

**HAYWARD UNIFIED SCHOOL DISTRICT
24411 Amador Street
Hayward, CA 94544
510.784.2600**



BID PACKAGE

**Bid No. 26.004
REBID - Supply and Installation of Acoustical Towers
at HUSD Performing Arts Center**

BID DUE DATE AND TIME

**HUSD Administration Building
24411 Amador Street
Hayward, CA 94544
Bid Due – January 8, 2026 – 10:00am**

DOCUMENT 00 01 10

TABLE OF CONTENTS - CONTRACT DOCUMENTS

PROCUREMENT AND CONTRACTING REQUIREMENTS

Division 00	Section	Title
	00 01 01	Title Page
	00 01 10	Table of Contents (This Document)
	00 01 15	List of Drawings, Tables and Schedules
	00 11 16	Notice to Bidders / Invitation to Bid
	00 21 13	Instructions to Bidders
	00 31 19	Existing Information and Documentation Regarding Project Site (<u>NOT</u> part of the Contract Documents)

DOCUMENTS THAT BIDDER MUST SUBMIT AS PART OF ITS BID

00 41 13	Bid Form
00 43 13	Bid Bond (Security)
00 43 36	Designated Subcontractors List
00 43 40	Noncollusion Declaration
00 43 50	Iran Contracting Act Certification

00 45 00	Notice of Award
00 45 10	Agreement
00 45 40	Certifications to be Completed by Contractor
00 45 85	Criminal Background Investigation/Fingerprinting Certification
00 54 50	Escrow of Bid Documentation
00 54 55	Escrow Agreement for Security Deposits in Lieu of Retention
00 61 14	Performance Bond
00 61 15	Payment Bond (Contractor's Labor and Material Bond)
00 65 10	Notice to Proceed
00 65 36	Warranty and Guarantee Form
00 70 00	General Conditions
00 71 00	Special Conditions
00 91 13	Addenda - All addenda issued by District become part of the Contract.

SPECIFICATIONS – GENERAL REQUIREMENTS

Division 01	Section	Title
	01 11 00	Summary of Work
	01 25 10	Product Options and Substitutions
	01 26 00	Contract Modification Procedures
	01 26 10	Requests for Information
	01 33 00	Submittals
	01 40 00	Quality Requirements
	01 52 10	Site Standards
	01 60 00	Materials and Equipment
	01 66 10	Delivery, Storage and Handling
	01 73 00	Execution
	01 73 10	Cutting and Patching
	01 77 00	Contract Closeout and Final Cleaning
	01 78 23	Operation and Maintenance Data
	01 78 36	Warranties

TECHNICAL SPECIFICATIONS

DIVISION 11 – EQUIPMENT

11 61 14	Orchestra Shell Towers & Wall Panels
----------	--------------------------------------

END OF DOCUMENT

DOCUMENT 00 01 15

LIST OF DRAWINGS, TABLES AND SCHEDULES

DRAWINGS

ORCHESTRA SHELL TOWERS

A1	ORCHESTRA SHELL TOWERS
A2	ORCHESTRA SHELL TOWER - CONFIG #1 - #4
A3	ORCHESTRA SHELL TOWER REAR ELEVATION, SECTIONS AND DETAILS
A4	ORCHESTRA SHELL TOWER STORAGE TRACK DETAIL & LAYOUT
A5	STAGE LED RECESSED WALL LUMINAIRES COORDINATION 1
A6	STAGE LED RECESSED WALL LUMINAIRES COORDINATION 1

TABLES

None

SCHEDULES

None

END OF DOCUMENT

DOCUMENT 00 11 16

NOTICE TO BIDDERS / INVITATION TO BID

1. Notice is hereby given that the governing board ("Board") of the **Hayward Unified School District** ("District") will receive sealed bids to construct the following project:

Bid No. 26.004 REBID Supply and Installation of Acoustical Towers at HUSD PAC ("Project" or "Contract")

2. Contractors must submit sealed bids on or before 10:00am, January 8, 2026, at the District Office, located at 24411 Amador St, Hayward, California, at or after which time the District will open the bids and publicly read them aloud. The bid must be in a sealed envelope inside the shipping package and marked on the exterior "**Bid Enclosed #26.004**". The District is not responsible for the timeliness of bids that are not delivered directly to the District as outlined above. Any claim by a Bidder of error in its bid must be made in compliance with Public Contract Code § 5100, et seq. Any bid that is submitted after this time shall be non-responsive and returned to the Bidder. The District is not responsible for Bids that are received after the deadline noted above.
3. The Project consists of Supply and Installation of Acoustical Towers at HUSD Performing Arts Center.
4. All bids shall be on the form provided by the District. Each bid must conform and be responsive to all pertinent Contract Documents, including, but not limited to, the Instructions to Bidders.
5. To bid on this Project, the Bidder is required to possess one or more of the following State of California Contractor Licenses: C-61/D-34.

The Bidder's license(s) must be active and in good standing at the time of the bid opening and must remain so throughout the term of the Contract.

6. As security for its Bid, each Bidder shall provide with its Bid form
 - a bid bond issued by an admitted surety insurer on the form provided by the District,
 - cash, or
 - a cashier's check or a certified check, drawn to the order of the **Hayward Unified School District**, in the amount of ten percent (10%) of the total bid price. This bid security shall be a guarantee that the Bidder shall, within seven (7) calendar days after the date of the Notice of Award, enter into a contract with the District for the performance of the services as stipulated in the bid.
7. All bidders' questions must be submitted in writing via email to facilitiesbond@husd.k12.ca.us, by 10:00am, December 30, 2025
8. If a bidder wishes to visit the project site, submit a request in writing via email to facilitiesbond@husd.k12.ca.us
9. Contract Documents are available on the District's website at <https://www.husd.us/departments/business-services/bonds>
10. The successful Bidder shall be required to furnish a 100% Performance Bond and a 100% Payment Bond if it is awarded the contract for the Project.
11. The successful Bidder may substitute securities for any monies withheld by the District to ensure performance under the Contract, in accordance with the provisions of Public Contract Code § 22300.

12. The successful Bidder and its subcontractors shall pay all workers on the Project not less than the general prevailing rate of per diem wages and the general prevailing rate for holiday and overtime work as determined by the Director of the Department of Industrial Relations, State of California, for the type of work performed and the locality in which the work is to be performed within the boundaries of the District, pursuant to Labor Code § 1770 et seq. Prevailing wage rates are on file with the District and are available to any interested party on request or at www.dir.ca.gov/oprl/statistics_and_databases.html. Bidders and Bidders' subcontractors shall comply with the registration and qualification requirements pursuant to Labor Code §§ 1725.5 & 1771.1
13. The District's Board reserves the right to reject any and all bids and/or waive any irregularity in any bid received. If the District awards the Contract, the security of unsuccessful Bidder(s) shall be returned within sixty (60) days from the time the award is made. Unless otherwise required by law, no Bidder may withdraw its bid for ninety (90) days after the date of the bid opening.
14. The District shall award the Contract, if it awards it at all, to the lowest responsive responsible Bidder based on the base bid amount only.

END OF DOCUMENT

DOCUMENT 00 21 13

INSTRUCTIONS TO BIDDERS

Bidders shall follow the instructions in this document, and shall submit all documents, forms, and information required for consideration of a Bid.

Hayward Unified School District ("District") will evaluate information submitted by the apparent low Bidder and, if incomplete or unsatisfactory to District, Bidder's bid may be rejected at the sole discretion of District.

1. **Project.** Bids are requested for a general construction contract, or work described in general, for the following project:

Bid No. 26.004 REBID Supply and Installation of Acoustical Towers at HUSD PAC ("Project" or "Contract")

2. **Submittal of Bids.** District will receive sealed Bids from Bidders as indicated in the Invitation to Bid and each Bidder shall ensure that its Bid contains all documents as required herein and is submitted by date and time shown in the Invitation to Bid.
 - a. Contractors must ensure the District receives its bid, sealed and marked with name and address of the Bidder, the Project name and number, the bid number and bid package (if applicable), and the date for opening bids.
3. **Bid Opening.** Bids will be opened at or after the time indicated for receipt of bids.
4. **Complete Bids.** Bidders must supply all information required by each Bid Document. Bids must be full and complete. District reserves the right in its sole discretion to reject any Bid as non-responsive as a result of any error or omission in the Bid. Each Bidder must complete and submit all of the following documents as its Bid:
 - Bid Form
 - Bid Bond or other security
 - Designated Subcontractors List
 - Noncollusion Declaration
 - Iran Contracting Act Certification
 - a. **Bid Form.** Bidders must submit Bids on the Bid Form and all other required District forms. Bids not submitted on the District's required forms shall be deemed non-responsive and shall not be considered. Additional sheets required to fully respond to requested information are permissible. Bidders shall not modify the Bid Form or qualify their Bids. Bidders shall not submit scanned, re-typed, word-processed, or otherwise recreated versions of the Bid Form or other District-provided documents.
 - b. **Bid Bond or Other Security.** Bidders must submit their Bid Form with cash, a cashier's check or a certified check payable to District, or a bid bond by an admitted surety insurer of not less than ten percent (10%) of their base Bid amount, including all additive alternates. Required form of corporate surety, Bid Bond, is provided by District and must be used and fully completed by Bidders choosing to provide a Bid Bond as security. The Surety on Bidders' Bid Bond must be an insurer admitted in the State of California and authorized to issue surety bonds in the State of California. Bids submitted without necessary bid security will be deemed non-responsive and will not be considered.
 - c. **Designated Subcontractors List.** Bidders must submit with the Bid the Designated Subcontractors List for those subcontractors who will perform any portion of Work, including labor, rendering of service, or specially fabricating and installing a portion of the Work or improvement according to detailed drawings contained in the plans and specifications, in excess of one half of one percent (0.5%) of the Bidder's total Bid. Failure to fully complete and submit this list when required by law shall result in Bid being deemed non-responsive and the Bid will not be considered.

- d. **Noncollusion Declaration.** Bidders shall submit the Noncollusion Declaration with their Bids. Bids submitted without the Noncollusion Declaration shall be deemed non-responsive and will not be considered.
 - e. **Iran Contracting Act Certification.** Bidders shall submit the Iran Contracting Act Certification with their Bids. Bids submitted without the Iran Contracting Act Certification shall be deemed non-responsive and will not be considered.
5. **Erasures.** Bids shall be clearly written without erasure or deletions. District reserves the right to reject any Bid containing erasures or deletions.
 6. **Prevailing Wages.** Pursuant to sections 1770 et seq. of the California Labor Code, Bidder and all Subcontractors under the Bidder shall pay all workers on all work performed pursuant to the Contract not less than the general prevailing rate of per diem wages and the general prevailing rate for holiday and overtime work as determined by the Director of the State of California Department of Industrial Relations (DIR) for the type of work performed and the locality in which the work is to be performed within the boundaries of the District. Copies of the general prevailing rates of per diem wages for each craft, classification, or type of worker needed to execute the Contract, as determined by the DIR are on file with the District and are available to any interested party on request or at www.dir.ca.gov/oprl/statistics_and_databases.html.
 7. **Contractor Registration.** Bidder shall ensure that it and its Subcontractors comply with the registration and compliance monitoring provisions of Labor Code section 1771.4, including furnishing its CPRs to the Labor Commissioner, and are registered pursuant to Labor Code section 1725.5. Bidder and its subcontractors shall comply with Labor Code section 1725.5 to be qualified to bid on, be listed in a bid proposal, subject to the requirements of Section 4104 of the Public Contract Code, or engage in the performance of the Contract.
 8. **Bidder Diligence.** Submission of Bid signifies careful examination of the Contract Documents and a complete understanding of the nature, extent, and location of Work to be performed. Bidders must complete the tasks listed below as a condition to bidding, and submission of Bid shall constitute the Bidder's express representation to District that Bidder has fully completed the following:
 - a. Bidder has visited the Project Site, if required, and has examined thoroughly and understood the nature and extent of the Contract Documents, Work, Site, locality, actual conditions, as-built conditions, and all local conditions and federal, state and local laws, and regulations that in any manner may affect cost, progress, performance, or furnishing of Work or that relate to any aspect of the means, methods, techniques, sequences, or procedures of construction to be employed by Bidder and safety precautions and programs incident thereto;
 - b. Bidder has conducted or obtained and has understood all examinations, investigations, explorations, tests, reports, and studies that pertain to the subsurface conditions, as-built conditions, underground facilities, and all other physical conditions at or contiguous to the Site or otherwise that may affect the cost, progress, performance, or furnishing of Work, as Bidder considers necessary for the performance or furnishing of Work at the Contract Price, within the Contract Time, and in accordance with the other terms and conditions of Contract Documents, including specifically the provisions of the General Conditions. Bidder has notified the District if it contends that it requires additional examinations, investigations, explorations, tests, reports, studies, or similar information or data prior to submitting its bid;
 - c. Bidder has correlated its knowledge and the results of all observations, examinations, investigations, explorations, tests, reports, and studies with the terms and conditions of the Contract Documents;
 - d. Bidder has given the District prompt written notice of all conflicts, errors, ambiguities, or discrepancies that it has discovered in or among the Contract Documents and the actual conditions, and the written resolution thereof by the District is acceptable to Bidder;
 - e. Bidder has made a complete disclosure in writing to the District of all facts bearing upon any possible

interest, direct or indirect, that Bidder believes any representative of the District or other officer or employee of the District presently has or will have in this Contract or in the performance thereof or in any portion of the profits thereof;

- f. Bidder must, prior to bidding, perform the work, investigations, research, and analysis required by the Instructions to Bidders and that Bidder represented in its Bid Form and the Agreement that it performed prior to bidding. Bidder is charged with all information and knowledge that a reasonable bidder would ascertain from having performed this required work, investigation, research, and analysis. Bid prices must include entire cost of all work “incidental” to completion of the Work.
 - g. **Conditions Shown on the Contract Documents:** Information as to underground conditions, as-built conditions, or other conditions or obstructions, indicated in the Contract Documents, e.g., on Drawings or in Specifications, has been obtained with reasonable care, and has been recorded in good faith. However, District only warrants, and Bidder may only rely, on the accuracy of limited types of information.
 - (1) As to above-ground conditions or as-built conditions shown or indicated in the Contract Documents, there is no warranty, express or implied, or any representation express or implied, that this information is correctly shown or indicated. This information is verifiable by independent investigation and Bidder is required to make that verification as a condition to bidding. In submitting its Bid, Bidder shall rely on the results of its own independent investigation. In submitting its Bid, Bidder shall not rely on District-supplied information regarding above-ground conditions or as-built conditions.
 - (2) As to any subsurface condition shown or indicated in the Contract Documents, Bidder may rely only upon the general accuracy of actual reported depths, actual reported character of materials, actual reported soil types, actual reported water conditions, or actual obstructions shown or indicated. District is not responsible for the completeness of this information for bidding or construction; nor is District responsible in any way for any conclusions or opinions of Bidder drawn from that information; nor is District responsible for subsurface conditions that are not specifically shown if those subsurface conditions are reasonably determinable by above-ground conditions and observation or as-built conditions (e.g., subsurface soil conditions in areas contiguous to areas where an above-ground condition is shown; utility pipes between a manhole and a water source, etc.).
 - h. **Conditions Shown in Reports and Drawings Supplied for Informational Purposes:** Reference is made to the document entitled Existing Information and Documentation Regarding Project Site, for identification of:
 - (1) Subsurface Conditions: Those reports of explorations and tests of subsurface conditions at or contiguous to the Project Site that have been utilized by Architect in preparing the Contract Documents; and
 - (2) Physical Conditions: Those drawings of physical conditions in or relating to existing surface or subsurface structures at or contiguous to the Project Site that has been utilized by Architect in preparing the Contract Documents.
 - (3) These reports and drawings are **not** Contract Documents and, except for any “technical” data regarding subsurface conditions specifically identified in Existing Information and Documentation Regarding Project Site, and underground facilities data, Bidder may not in any manner rely on the information in these reports and drawings.
9. **As-Builts.** Bidders may examine any available “as-built” drawings of previous work by giving District reasonable advance notice. District will not be responsible for accuracy of “as-built” drawings. The document entitled Existing Information and Documentation Regarding Project Site applies to all supplied “as-built” drawings.

10. **Questions.** All questions about the meaning or intent of the Contract Documents are to be directed in writing to the District. Interpretations or clarifications considered necessary by the District in response to those questions will be issued in writing by Addenda faxed, mailed, or delivered to all parties recorded by the District as having received the Contract Documents. Questions received less than **SEVEN (7)** calendar days prior to the date for opening Bids may not be answered. Only questions answered by formal written Addenda will be binding. Oral and other interpretations or clarifications will be without legal effect.
11. **Addenda.** Addenda may also be issued to modify parts of the Contract Documents as deemed advisable by the District. Bidder must acknowledge each Addendum in its Bid Form by number or its Bid may be considered non-responsive. Each Addenda shall be part of the Contract Documents. A complete listing of Addenda may be obtained from the District.
12. **Substitution for Specified Items.** Bids shall be based on products and systems specified in the Contract Documents or listed by name in Addenda. All requests must comply with the requirements specified in the General Conditions, the Specifications and the following:
 - a. **Request for Substitution Prior to Bid.**
 - (1) District must receive any request for substitution a minimum of **FOURTEEN (14)** calendar days prior to the date of bid opening.
 - (2) **Information with Request.** Requests for substitutions shall contain sufficient information to assess acceptability of the product or system and impact to Project, including, without limitation, the requirements specified in the General Conditions and the Specifications. Insufficient information shall be grounds for rejection of substitution.
 - (3) The District's denial of a substitution request prior to the date of bid opening shall be conclusive, requiring Bidders to list only approved items. The District is not responsible and/or liable in any way for a Bidder's damages and/or claims related, in any way, to that Bidder's basing its bid on any requested substitution that the District has not approved. Bidder's Bid shall be deemed non-responsive if it identifies a product or manufacturer of a non-approved substitution.
 - (4) Approved substitutions shall be listed in Addenda.
 - (5) District reserves the right not to act upon submittals of substitutions until after the date of bid opening. If the District does not act on a substitution request prior to the date of bid opening, Bidders must bid based on products and systems specified in Contract Documents or listed by name in Addenda.
 - b. **Request for Substitution after Bid Award.** Substitutions may be requested after the Contract has been awarded only if indicated in and in accordance with requirements specified in the General Conditions, as may be modified in the Special Conditions.
13. **Alternates.** The Contract may include alternates. Alternates are defined as alternate products, materials, equipment, systems, methods, or major elements of the construction, that may, at the District's option and under terms established in the Contract and pursuant to section 20103.8 of the Public Contract Code, be selected for the Work. The District shall award the Contract, if it awards it at all, to the lowest responsive responsible bidder based on the criteria as indicated in the Invitation to Bid.
14. **Notice of Award.** The Bidder awarded the Contract shall execute and submit the following documents by 5:00 p.m. of the **SEVENTH (7TH)** calendar day following the date of the Notice of Award. Failure to properly and timely submit these documents entitles District to, among other remedies, make a claim against Bidder's Bid Bond or deposit Bidder's cash, cashier's check, or certified check. The proceeds thereof may be retained by District as liquidated damages, in District's sole discretion.
 - a. Agreement: To be executed by successful Bidder. Submit four (4) copies, each bearing an original

signature.

- b. Escrow of Bid Documentation: This must include all required documentation. See the document Escrow of Bid Documentation for more information.
 - c. Performance Bond (100%): On the form provided in the Contract Documents and fully executed as indicated on the form.
 - d. Payment Bond (100%) (Contractor's Labor and Material Bond): On the form provided in the Contract Documents and fully executed as indicated on the form.
 - e. Insurance Certificates and Endorsements as required.
 - f. Certifications to be Completed by Contractor
 - g. Criminal Background Investigation/Fingerprinting Certification.
15. **Notice to Proceed.** District may issue a Notice to Proceed within **THREE (3)** months from the date of the Notice of Award. Upon receipt of the Notice to Proceed, Contractor shall complete the Work within the period of time indicated in the Contract Documents. It is further expressly understood by Contractor that Contractor shall not be entitled to any claim of additional compensation or additional time when the Notice to Proceed is issued within the 3-month period.
- a. The District may postpone issuing the Notice to Proceed beyond the 3-month period, upon reasonable notice to Contractor.
 - b. If the Contractor believes that a postponement of issuance of the Notice to Proceed will cause a hardship to Contractor, the Contractor may, by written notice to District within **SEVEN (7)** calendar days after receipt by Contractor of District's notice of postponement, take one of the following actions:
 - (1) **Agree with the postponement.** This would be at no additional cost to the District.
 - (2) **Terminate the Contract.** District shall only be obligated to pay Contractor for any Work that Contractor had performed at the time of notification of postponement and that the District had in writing authorized Contractor to perform, if any, prior to issuing a Notice to Proceed.
 - (3) **Request additional compensation.** Contractor must submit detailed documentation demonstrating the need for that additional compensation, compared to the calculations and amounts that Contractor used to prepare its bid. If the Parties do not agree on an amount for the requested additional compensation, the Contractor can agree to the postponement without any additional compensation, or either Party may terminate the Contract.
 - c. If the Contract is terminated as a result of a notice of postponement, District shall have the authority to award the Contract to the next lowest responsive responsible Bidder.
16. **Bid Protests.** Any bid protest by any Bidder regarding any other bid on this Project must be submitted in writing to the District, before 5:00 p.m. of the **THIRD (3rd)** Business Day following the date of bid opening.
- a. The protest must contain a complete statement of any and all bases for the protest.
 - b. The protest must refer to the specific portions of all documents that form the bases for the protest, including the specific portion(s) of the bid(s) that the Bidder is protesting.
 - c. The protest must include the name, address and telephone number of the person representing the protesting party.

- d. The party filing the protest must concurrently transmit a copy of the protest and any attached documentation to all other parties with a direct financial interest that may be adversely affected by the outcome of the protest, which must include all other Bidders or proposers who appear to have a reasonable prospect of receiving an award depending upon the outcome of the protest.
 - e. The procedure and time limits set forth in this paragraph are mandatory and are each Bidder's sole and exclusive remedy in the event of bid protest. Failure to comply with these procedures shall constitute a waiver of any right to further pursue the bid protest, including filing a Government Code Claim or legal proceedings.
17. **Rejection of Bids.** District reserves the right to reject any or all bids, including without limitation the right to reject any or all nonconforming, non-responsive, unbalanced, or conditional bids, to re-bid, and to reject the bid of any Bidder if District believes that it would not be in the best interest of the District to make an award to that Bidder, whether because the bid is not responsive or the Bidder is unqualified or of doubtful financial ability or fails to meet any other pertinent standard or criteria established by District. District also reserves the right to waive inconsequential deviations not involving price, time, or changes in the Work. For purposes of this paragraph, an "unbalanced bid" is one having nominal prices for work item(s) that represent substantive work and/or overly-enhanced prices for nominal work item(s).
18. **Bidder's Representative's Authority.** Each bid must be executed by an authorized representative of the Bidder. Bidders may be asked to provide documentation of that authority (e.g., an authenticated resolution of its Board of Directors, a power of attorney evidencing the capacity of the person signing the Bid Form to bind the Bidder to its bid, etc.).
19. **Bidder Responsibility.** Prior to the award of Contract, District reserves the right to consider the responsibility of the Bidder. District may conduct investigations as District deems necessary to assist in the evaluation of any bid and to establish the responsibility, including, without limitation, qualifications and financial ability of Bidders, proposed subcontractors, suppliers, and other persons and organizations to perform and furnish the Work in accordance with the Contract Documents to District's satisfaction within the Contract Time.

END OF DOCUMENT

DOCUMENT 00 31 19

EXISTING INFORMATION AND DOCUMENTATION REGARDING PROJECT SITE

1. Summary

This document describes existing conditions at or near the Project and use of information available regarding existing conditions. This document is **not** part of the Contract Documents. See General Conditions for definition(s) of terms used herein. Contractor is required to request from the District a copy of any reports that it believes are necessary to perform Contractor's Work in a safe, efficient and workman-like manner.

2. Reports and Information on Existing Conditions

- a. Documents providing a general description of the Site and conditions of the Work may have been collected by District, its consultants, contractors, and tenants. These documents may include previous contracts, contract specifications, tenant improvement contracts, as-built drawings, utility drawings, and information regarding underground facilities.
- b. Information regarding existing conditions may be inspected at the District offices or the Construction Manager's offices, if any, and copies may be obtained at cost of reproduction and handling upon Bidder's agreement to pay for such copies. These reports, documents, and other information are **not** part of the Contract Documents.
- c. Information regarding existing conditions may also be included in the Project Manual, but shall **not** be considered part of the Contract Documents.
- d. The reports and other data or information regarding existing conditions and underground facilities at or contiguous to the Project are listed below. The reports are available on the Districts website at <https://www.husd.us/bonds> select the appropriate project and look under "Information".

None

3. Use of Information

- a. Information regarding existing conditions was obtained only for use of District and its consultants, contractors, and tenants for planning and design and is **not** part of the Contract Documents.
- b. District does not warrant, and makes no representation regarding, the accuracy or thoroughness of any information regarding existing conditions. Bidder represents and agrees that in submitting a bid it is not relying on any information regarding existing conditions supplied by District.
- c. Under no circumstances shall District be deemed to warrant or represent existing above-ground conditions, as-built conditions, or other actual conditions, verifiable by independent investigation. These conditions are verifiable by Contractor by the performance of its own independent investigation that Contractor must perform as a condition to bidding, and Contractor should not and shall not rely on this information or any other information supplied by District regarding existing conditions.
- d. Any information shown or indicated in the reports and other data supplied herein with respect to existing underground facilities at or contiguous to the Project may be based upon information and data furnished to District by the District's employees and/or consultants or builders of such underground facilities or others. District does not assume responsibility for the completeness of this information, and Bidder is solely responsible for any interpretation or conclusion drawn from this information.
- e. District shall be responsible only for the general accuracy of information regarding underground facilities, and only for those underground facilities that are owned by District, and only where Bidder has conducted the independent investigation required of it pursuant to the Instructions to Bidders, and discrepancies are not apparent.

4. Limited Reliance on Certain Information

- a. Reference is made herein for identification of:
 - (1) Reports of explorations and tests of subsurface conditions at or contiguous to the Site that have been utilized by District in preparation of the Contract Documents.
 - (2) Drawings of physical conditions in or relating to existing subsurface structures (except underground facilities) that are at or contiguous to the Site and have been utilized by District in preparation of the Contract Documents.
- b. Bidder may rely upon the general accuracy of the “technical data” contained in the reports and drawings identified above, but only insofar as it relates to subsurface conditions, provided Bidder has conducted the independent investigation required pursuant to Instructions to Bidders, and discrepancies are not apparent. The term “technical data” in the referenced reports and drawings shall be limited as follows:
 - (1) The term “technical data” shall include actual reported depths, reported quantities, reported soil types, reported soil conditions, and reported material, equipment or structures that were encountered during subsurface exploration. The term “technical data” does not include, and Bidder may not rely upon, any other data, interpretations, opinions or information shown or indicated in such drawings or reports that otherwise relate to subsurface conditions or described structures.
 - (2) The term “technical data” shall not include the location of underground facilities.
 - (3) Bidder may not rely on the completeness of reports and drawings for the purposes of bidding or construction. Bidder may rely upon the general accuracy of the “technical data” contained in such reports or drawings.
 - (4) Bidder is solely responsible for any interpretation or conclusion drawn from any “technical data” or any other data, interpretations, opinions, or information provided in the identified reports and drawings.

5. Investigations/Site Examinations

- a. Before submitting a Bid, each Bidder is responsible for conducting or obtaining any additional or supplementary examinations, investigations, explorations, tests, studies, and data concerning conditions (surface, subsurface, and underground facilities) at or contiguous to the Site or otherwise, that may affect cost, progress, performance, or furnishing of Work or that relate to any aspect of the means, methods, techniques, sequences, or procedures of construction to be employed by Bidder and safety precautions and programs incident thereto or that Bidder deems necessary to determine its Bid for performing and furnishing the Work in accordance with the time, price, and other terms and conditions of Contract Documents.
- b. On request, District will provide each Bidder access to the Site to conduct such examinations, investigations, explorations, tests, and studies, as each Bidder deems necessary for submission of a Bid. Bidders must fill all holes and clean up and restore the Site to its former condition upon completion of its explorations, investigations, tests, and studies. Such investigations and Site examinations may be performed during any and all Site visits indicated in the Invitation to Bid and only under the provisions of the Contract Documents, including, but not limited to, proof of insurance and obligation to indemnify against claims arising from such work, and District’s prior approval.

END OF DOCUMENT

DOCUMENT 00 41 13

BID FORM

To: Governing Board of **Hayward Unified School District** ("District")

From: _____
(Proper Name of Bidder)

1. **Total Bid.** The undersigned declares that the Contract Documents including, without limitation, the Invitation to Bid, the Instructions to Bidders, and the Special Conditions have been read, and agrees and proposes to furnish all necessary labor, materials, and equipment to perform and furnish all work in accordance with the terms and conditions of the Contract Documents, including, without limitation, the Drawings and Specifications for the following project:

Bid No. 26.004 REBID Supply and Installation of Acoustical Towers at HUSD PAC ("Project" or "Contract")

and will accept in full payment for that Work the following total lump sum amount, all taxes included:

TOTAL BASE BID AMOUNT	
NOTE: IF THERE ARE ALLOWANCES IDENTIFIED IN THIS BID FORM, DO NOT INCLUDE ANY ALLOWANCE(S) AMOUNTS IN THESE BID AMOUNTS.	\$ _____ Dollars

2. **Allowance(s).** The Bidder's Base Bid shall include the following Allowance for any unknown issues that occur during the construction of this project. Contractor shall be permitted to invoice for Work under an Allowance in the identical structure as a Change Order. Any unused allowance will be credited back to the District at the conclusion of the project:

Construction Allowance: This number will be added to the base bid amount:	\$20,000.00 Dollars
--	----------------------------

3. **Total Bid Amount.** Bidder's total bid (Base Bid Amount + Allowance) is as follows:

_____ Dollars	\$ _____ Dollars
TOTAL BID AMOUNT	

4. Please provide the following information:
- Time to provide submittal(s) after award of contract _____ weeks
- Time to fabricate after receipt of approved submittal _____ weeks
- Time to install _____ weeks
5. **Contract Review.** The undersigned has reviewed the Work outlined in the Contract Documents and fully understands the scope of Work required in this bid, understands the construction and project management function(s) is described in the Contract Documents, and that each Bidder who is awarded a contract shall be in fact a prime contractor, not a subcontractor, to the District, and agrees that its bid, if accepted by the District, will be the basis for the Bidder to enter into a contract with the District in accordance with the intent of the Contract Documents.
6. **Requests for Clarification.** The undersigned has notified the District in writing of any discrepancies or omissions or of any doubt, questions, or ambiguities about the meaning of any of the Contract Documents, and has contacted the Construction Manager before bid date to verify the issuance of any clarifying Addenda.

7. **Contract Time.** The undersigned agrees to commence work under this Contract on the date established in the Contract Documents and to complete all work within the time specified in the Contract Documents.

8. **Contractual Provisions.** The undersigned hereby acknowledges and agrees to be bound by following provisions and all provisions in the Contract Documents:

- The liquidated damages clause of the General Conditions and Agreement.
- The "Changes in the Work" provisions in the General Conditions that limit the permitted charges and mark-ups on change orders and on the amount of home office overhead that the successful bidder can receive from the District.
- The "Claims" provisions in the General Conditions that delineate the required process to submit and process disputes and claims.
- The "COVID-19" provisions in the Contract Documents related to the Contractor's staffing requirements and its compliance with all applicable and existing federal, state, and/or local statutes, orders, rules, regulations, ordinances, and/or directives relating to construction site safety in connection with COVID-19, and/or any similar virus or derivative strain.

9. **Bid Open for 90 Days.** It is understood that the District reserves the right to reject this bid and that the bid shall remain open to acceptance and is irrevocable for a period of ninety (90) days.

10. **Attachments.** The following documents are attached hereto:

- The Bid Bond on the District's form or other security
- The Designated Subcontractors List
- The Noncollusion Declaration
- Iran Contracting Act Certification

11. **Addenda Acknowledgement.** Receipt and acceptance of the following addenda is hereby acknowledged:

No.____, Dated _____	No.____, Dated _____
No.____, Dated _____	No.____, Dated _____
<input type="checkbox"/> Or check here if no addenda were issued.	

12. **Bidder's License.** Bidder acknowledges that the license required for performance of the Work is as stated in the Invitation to Bid. Bidder certifies that it is, at the time of bidding, and shall be throughout the period of the contract, licensed by the State of California to do the type of work required under the terms of the Contract Documents. Bidder further certifies that it is regularly engaged in the general class and type of work called for in the Contract Documents.

13. **Labor Harmony.** The undersigned hereby certifies that Bidder is able to furnish labor that can work in harmony with all other elements of labor employed or to be employed on the Work.

14. **DIR Registration.** Bidder shall ensure that it and its Subcontractors comply with the registration and compliance monitoring provisions of Labor Code section 1771.4, including furnishing its CPRs to the Labor Commissioner, and are registered pursuant to Labor Code section 1725.5.

14. **General Acknowledgement.** The Bidder represents that it is competent, knowledgeable, and has special skills with respect to the nature, extent, and inherent conditions of the Work to be performed. Bidder further acknowledges that there are certain peculiar and inherent conditions existent in the construction of the Work that may create, during the Work, unusual or peculiar unsafe conditions hazardous to persons and property.

Bidder expressly acknowledges that it is aware of such peculiar risks and that it has the skill and experience to foresee and to adopt protective measures to adequately and safely perform the Work with respect to such hazards.

15. False Claims Act. Bidder expressly acknowledges that it is aware that if a false claim is knowingly submitted (as the terms "claim" and "knowingly" are defined in the California False Claims Act, Cal. Gov. Code, §12650 et seq.), the District will be entitled to civil remedies set forth in the California False Claim Act. It may also be considered fraud and the Contractor may be subject to criminal prosecution.

Furthermore, Bidder hereby certifies to the District that all representations, certifications, and statements made by Bidder, as set forth in this bid form, are true and correct and are made under penalty of perjury.

Dated this _____ day of _____ 2025

Signature _____

Signed by (Print Name) _____

Title of Person Signing _____

Name of Bidder _____

Type of Organization _____

Address of Bidder _____

Taxpayer's Identification No. of Bidder _____

Telephone Number _____

Fax Number _____

E-mail _____ Web page _____

Bidder's DIR Registration No.: No.: _____

Contractor's License No(s): No.: _____ Class: _____ Expiration Date: _____

No.: _____ Class: _____ Expiration Date: _____

No.: _____ Class: _____ Expiration Date: _____

If Bidder is a corporation, provide the following:

Name of Corporation: _____

President: _____

Secretary: _____

Treasurer: _____

END OF DOCUMENT

DOCUMENT 00 43 13

BID BOND (SECURITY)

**(Note: If Bidder is providing a bid bond as its bid security,
Bidder must use this form, NOT a surety company form.)**

The undersigned, _____ as Principal ("Principal");

and _____ as Surety ("Surety"; a corporation organized and existing under and by virtue of the laws of the State of _____ and authorized to do business as a surety in the State of California) are held and firmly bound unto the **Hayward Unified School District** ("District") as Oblige, in the sum of \$ _____ Dollars, lawful money of the United States, for the payment to the District will and truly to be made pursuant to the provisions herein. Principal and Surety each of us, bind ourselves, our heirs, executors, administrators, successors, and assigns, jointly and severally.

THE CONDITION OF THIS OBLIGATION IS SUCH that whereas the Principal has submitted a bid to the District for all Work specifically described in the accompanying bid and if the District awards the contract to the Principal and, within the time and manner required under the Contract Documents, after the prescribed forms are presented to Principal for signature, the Principal enters into a written contract, in the prescribed form in accordance with the bid, and files two bonds (one guaranteeing faithful performance and the other guaranteeing payment for labor and materials as required by law), and meets all other conditions to the contract between the Principal and the Oblige becoming effective, or if the Principal shall fully reimburse and save harmless the Oblige from any damage sustained by the Oblige through failure of the Principal to enter into the written contract and to file the required performance and labor and material bonds, and to meet all other conditions to the Contract between the Principal and the Oblige becoming effective, then this obligation shall be null and void; otherwise, it shall be and remain in full force and effect and the Surety shall immediately issue full payment of the sum stated above to the Oblige upon notification from the Oblige that the Principal has not taken all steps to nullify or void this obligation.

Surety agrees that no change, extension of time, alteration or addition to the terms of the call for bids, or to the work to be performed thereunder, or the specifications accompanying the same, shall in any way affect its obligation under this bond, and it does hereby waive notice of any such change, extension of time, alteration or addition to the call for bids, or to the work, or to the specifications.

In the event suit is brought upon this bond by the Oblige and judgment is recovered, the Surety shall pay all costs incurred by the Oblige in that suit, including a reasonable attorneys' fee to be fixed by the Court.

If the District awards the bid, the security of unsuccessful bidder(s) shall be returned within sixty (60) days from the time the award is made. Unless otherwise required by law, no bidder may withdraw its bid for ninety (90) days after the date of the bid opening.

IN WITNESS WHEREOF, this instrument has been duly executed by the Principal and Surety above named, on

_____, 2025.

Principal

By

Surety

By

Name of California Agent of Surety

Address of California Agent of Surety

Telephone Number of California Agent of Surety

Bidder must attach Power of Attorney and Certificate of Authority for Surety and a Notarial Acknowledgment for all Surety's signatures. The California Department of Insurance must authorize the Surety to be an admitted Surety Insurer.

END OF DOCUMENT

DOCUMENT 00 43 36

DESIGNATED SUBCONTRACTORS LIST

TO BE EXECUTED BY BIDDER AND SUBMITTED WITH BID

Bid No. 26.004 REBID Supply and Installation of Acoustical Towers at HUSD PAC ("Project" or "Contract")

1. **Listed.** Bidder must list hereinafter the name and location of each subcontractor who will be employed, and the scope of Work that each will perform if the Contract is awarded to the Bidder. Bidder acknowledges and agrees that under Public Contract Code section 4100, et seq., it must clearly identify the name and location of each subcontractor who will perform work or labor or render service to the Bidder in or about the construction of the Work in an amount in excess of one-half of one percent (1/2 of 1%) of Bidder's total Bid.
2. **CSLB Number.** Bidder must provide the Contactor State License Board number ("**CSLB No.**") for all listed subcontractors.
3. **DIR Number.** Bidder must provide the Department of Industrial Relations registration number ("**DIR No.**") for all listed subcontractors.
4. **Same Scope.** If more than one subcontractor is named for the same scope of Work, state with specificity the particular scope or portion that each subcontractor will perform.
5. **No Vendors or Suppliers.** Bidder need not list entities that are only vendors or suppliers of materials.
6. **Not Listed.** As to any Work that Bidder fails to list that is in excess of one-half of one percent (1/2 of 1%) of Bidder's total Bid, Bidder agrees that it is qualified to perform that scope of Work and will perform that scope of Work, or be subjected to penalty under applicable law.
7. **Alternate Work.** If alternate bids are called for and Bidder intends to use Subcontractors different from or in addition to those Subcontractors listed for work under the base Bid, Bidder must list Subcontractors that will perform Work in an amount in excess of one half of one percent (1/2 of 1%) of Bidder's total Bid, including alternates.
8. **Bidders may correct inadvertent error(s) in listing subcontractors' CSLB Nos. or DIR Nos. within twenty-four (24) hours after bid opening.**
9. **Additional Sheets.** If further space is required for the list of proposed subcontractors, additional sheets showing the required information, as indicated below, shall be attached hereto and made a part of this document and submitted with this form.

I certify and declare under penalty of perjury under the laws of the State of California that all the information listed on the following page(s) is complete, true, and correct.

Date: _____

Proper Name of Bidder: _____

Signature: _____

Print Name: _____

Title: _____

Subcontractor Name	Portion of Work (Scope)	Location of Business	CSLB No.:
			DIR No.:
Subcontractor Name	Portion of Work (Scope)	Location of Business	CSLB No.:
			DIR No.:
Subcontractor Name	Portion of Work (Scope)	Location of Business	CSLB No.:
			DIR No.:
Subcontractor Name	Portion of Work (Scope)	Location of Business	CSLB No.:
			DIR No.:
Subcontractor Name	Portion of Work (Scope)	Location of Business	CSLB No.:
			DIR No.:

END OF DOCUMENT

DOCUMENT 00 43 40

NONCOLLUSION DECLARATION
Public Contract Code § 7106

TO BE EXECUTED BY BIDDER AND SUBMITTED WITH BID

The undersigned declares:

I am the _____ **[PRINT YOUR TITLE]**

of _____ **[PRINT FIRM NAME]**,

the party making the foregoing bid.

The bid is not made in the interest of, or on behalf of, any undisclosed person, partnership, company, association, organization, or corporation. The bid is genuine and not collusive or sham. The bidder has not directly or indirectly induced or solicited any other bidder to put in a false or sham bid. The bidder has not directly or indirectly colluded, conspired, connived, or agreed with any bidder or anyone else to put in a sham bid, or to refrain from bidding. The bidder has not in any manner, directly or indirectly, sought by agreement, communication, or conference with anyone to fix the bid price of the bidder or any other bidder, or to fix any overhead, profit, or cost element of the bid price, or of that of any other bidder. All statements contained in the bid are true. The bidder has not, directly or indirectly, submitted his or her bid price or any breakdown thereof, or the contents thereof, or divulged information or data relative thereto, to any corporation, partnership, company, association, organization, bid depository, or to any member or agent thereof, to effectuate a collusive or sham bid, and has not paid, and will not pay, any person or entity for such purpose.

Any person executing this declaration on behalf of a bidder that is a corporation, partnership, joint venture, limited liability company, limited liability partnership, or any other entity, hereby represents that he or she has full power to execute, and does execute, this declaration on behalf of the bidder.

I declare under penalty of perjury under the laws of the State of California that the foregoing is true and correct and that this declaration is executed on the following date:

Date: _____

Proper Name of Bidder: _____

City, State: _____

Signature: _____

Print Name: _____

Title: _____

END OF DOCUMENT

DOCUMENT 00 43 50

IRAN CONTRACTING ACT CERTIFICATION (Public Contract Code § 2204)

Bid No. 26.004 REBID Supply and Installation of Acoustical Towers at HUSD PAC ("Project" or "Contract")

Pursuant to Public Contract Code (PCC) section 2204, an Iran Contracting Act certification is required for solicitations of goods or services of one million dollars (\$1,000,000) or more.

Bidder shall complete **ONLY ONE** of the following three paragraphs.

1. Bidder's Total Base Bid is less than one million dollars (\$1,000,000).

OR

2. Bidder's Total Base Bid is one million dollars (\$1,000,000) or more, but Bidder is **not** on the current list of persons engaged in investment activities in Iran created by the California Department of General Services ("DGS") pursuant to Public Contract Code § 2203(b), and Bidder is not a financial institution extending twenty million dollars (\$20,000,000) or more in credit to another person, for 45 days or more, if that other person will use the credit to provide goods or services in the energy sector in Iran and is identified on the current list of persons engaged in investment activities in Iran created by DGS.

OR

3. Bidder's Total Base Bid is one million dollars (\$1,000,000) or more, but the District has given prior written permission to Bidder to submit a proposal pursuant to PCC 2203(c) or (d). **A copy of the written permission from the District is included with Bid.**

I certify that I am duly authorized to legally bind the Bidder to this certification, that the contents of this certification are true, and that this certification is made under the laws of the State of California.

Date: _____

Proper Name of Bidder: _____

Signature: _____

Print Name: _____

Title: _____

END OF DOCUMENT

DOCUMENT 00 45 00

NOTICE OF AWARD

Dated: June 26, 2025

To: _____
("Contractor")

(Address)

From: Governing Board ("Board") of **Hayward Unified School District** ("District")

Re: **Bid No. 26.004 REBID Supply and Installation of Acoustical Towers at HUSD PAC** ("Project" or "Contract")

Contractor was awarded the Contract on June 25, 2025, by action of the District's Board.
The Contract Price is \$ _____ Dollars

Contractor shall execute and submit the following Contract Documents by 5:00 p.m. of the **FOURTEENTH (14TH)** calendar day following the date of the Notice of Award. Failure to properly and timely submit the following Contract Documents entitles District to foreclose on Contractor's bid bond and award the contract to the next responsive, responsible bidder.

- a. Agreement: Submit two (2) copies, each bearing an original signature. **If Contractor is a corporation, Contractor must attach a certified copy of the corporation's by-laws, or the resolution of the Board of Directors of the corporation, authorizing the signatory to execute the Agreement and the bonds required by the Contract Documents.**
- b. Escrow of Bid Documentation: Include all required documentation. Refer to the Escrow of Bid Documentation document for details.
- c. Performance Bond (100%): Fully executed form provided in the Contract Documents.
- d. Payment Bond (100%) (Contractor's Labor and Material Bond): Fully executed form provided in the Contract Documents.
- e. Insurance Certificates and Endorsements as required.
- f. Certifications to be Completed by Contractor
- g. Criminal Background Investigation/Fingerprinting Certification.

Failure to comply with these conditions within the time specified will entitle District to consider Contractor's bid abandoned, to annul the Notice of Award, and to declare Contractor's Bid Security forfeited, as well as any other rights the District may have against Contractor.

District will return to Contractor one fully signed counterpart of the Agreement.

Hayward Unified School District

SIGNATURE: _____

NAME: _____

TITLE: _____

END OF DOCUMENT

DOCUMENT 00 45 10

AGREEMENT

This agreement is made and entered into on June 26, 2025, by and between the **Hayward Unified School District** ("District") and _____ ("Contractor") ("Agreement"). The District and the Contractor agree as follows:

1. **The Work:** Contractor shall furnish all tools, equipment, apparatus, facilities, labor, and material necessary to perform and complete in a good and workmanlike manner, the work of the following project:

Bid No. 26.004 REBID Supply and Installation of Acoustical Towers at HUSD PAC ("Project" or "Contract" or "Work")

The Work shall be performed and completed as required in the Contract Documents as defined in the General Conditions including, without limitation, the Drawings and Specifications, under the direction and supervision of, and subject to, the approval of the District or its authorized representative.

2. **The Contract Documents:**

- a. The complete Contract consists of all Contract Documents as defined in the General Conditions and incorporated herein by this reference. All obligations of the District and Contractor are fully set forth and described in the Contract Documents. The Contract Documents are intended to cooperate so that Work called for in one and not mentioned in the other or vice versa is to be performed the same as if mentioned in all Contract Documents.
- b. **Interpretation of Contract Documents/Order of Precedence:** Questions concerning the intent, precedence, or meaning of the Contract Documents, including the Drawings or Specifications, shall be submitted to the District for interpretation. Inconsistencies in the Contract Documents shall be resolved by giving precedence in the following order:
 - (i) District-approved modifications (e.g., Change Orders, Force Account Directives, etc.), beginning with the most recent (if any);
 - (ii) Agreement;
 - (iii) Special Conditions (if any);
 - (iv) Supplemental Conditions (if any);
 - (v) General Conditions;
 - (vi) Remaining Division 0 documents (Documents beginning with "00");
 - (vii) Division 1 Documents (Documents beginning with "01");
 - (viii) Division 2 through Division 49 documents (Technical Specifications);
 - (ix) Figured dimensions;
 - (x) Large-scale drawings;
 - (xi) Small-scale drawings.

In case of conflict, the greater quantity and/or higher standard of workmanship shall apply unless the District expressly in writing (e.g., via a Change Order) accepts a lesser quantity or lower quality of workmanship and the Contract Price is adjusted accordingly. The decision of the District in the matter shall be final.

3. **Integration / Modification.** The Contract Documents and any documents specifically incorporated by reference are completely integrated as the complete and exclusive statement of the terms of the Agreement. This Agreement supersedes all previous contracts, agreements, and / or communications, both oral and written, and constitutes the entire understanding of the District and Contractor. No extrinsic evidence whatsoever shall be admissible or used to explain or supplement the terms of the Contract, Contract

Documents, or any items incorporated by reference. No changes, amendments or alterations shall be effective unless in writing, signed by both Parties, and unless provided otherwise by the Contract Documents.

4. **Classification of Contractor's License:** Contractor hereby acknowledges that it currently holds a valid Type C-61/D-34 Contractor's license(s) issued by the State of California, Contractor's State Licensing Board, in accordance with division 3, chapter 9, of the Business and Professions Code and in the classification called for in the Contract Documents.
5. **Time for Completion:** It is hereby understood and agreed that the Contractor shall complete the Work within TBD consecutive calendar days ("**Contract Time**") from the date specified in the District's Notice to Proceed. The District shall not approve an early completion schedule by Contractor. A schedule showing the Work completed in less than the Contract Time indicated in the Contract, shall be considered to have Project Float.
6. **Completion-Extension of Time:** If Contractor fails to complete the Work within the Contract Time, due allowance being made for the contingencies provided for herein, Contractor shall become liable to District for all loss and damage that District may suffer on account thereof. Contractor shall coordinate its Work with the work of all other contractors. The District shall not be liable for delays resulting from Contractor's failure to coordinate its Work with other contractors in a manner that allows for timely completion of Contractor's Work. Contractor shall be liable for delays to other contractors caused by Contractor's failure to coordinate its Work with the work of other contractors.
7. **Liquidated Damages:** Time is of the essence for all Work to be performed. It is hereby understood and agreed that it is and will be difficult and/or impossible to ascertain and determine the actual damage that District will sustain in the event of and by reason of Contractor's delay; therefore, pursuant to Government Code section 53069.85 and Public Contract Code section 7203, Contractor shall forfeit and pay to District the following sum(s) as liquidated damages ("**Liquidated Damages**"):

Project Completion: \$1,000.00 dollars per day as Liquidated Damages for each and every day's delay beyond the Contract Time to complete all the Work.

- a. Each portion of the Liquidated Damages shall be calculated cumulatively. For example, if Contractor is late in completing two milestones and the entire Project, Contractor will forfeit and pay three separate Liquidated Damages amounts. It is hereby understood and agreed that neither the total cumulative Liquidate Damages amount nor any portion of the Liquidated Damage amount are penalties.
- b. District may deduct Liquidated Damages from money due or that may become due Contractor under this Agreement. Contractor's forfeiture of Liquidated Damages to District, and District's right to retain Liquidated Damages, are as indicated in Government Code section 53069.85 and as indicated herein and in the General Conditions. Liquidated Damages are automatically and without notice of any kind forfeited and payable by Contractor upon the accrual of each day of delay. Neither District's failure or delay in deducting Liquidated Damages from payments otherwise due the Contractor, nor District's failure or delay in notifying Contractor of the forfeiture and payment of Liquidated Damages, shall be deemed a waiver of District's right to Liquidated Damages and/or the District's right to withhold Liquidated Damages from any amounts that would otherwise be payable to the Contractor.
- c. Contractor and Surety shall be liable for and pay to District the entire amount of Liquidated Damages including any portion that exceeds the amount of the Contract Price then held, retained or controlled by District.
- d. Liquidated Damages shall be in addition, and not in lieu of, District's right to charge Contractor for the District's cost of completing or correcting items of the Work.

8. **Contract Price:** In consideration of the foregoing covenants, promises, and agreements, Contractor offers, in the amounts stated below, to perform the Work according to the Contract Documents. District covenants, promises, and agrees that it will pay and cause to be paid to Contractor in full, and as the Contract Price the following amount(s):

$$\begin{array}{r}
 \$ \underline{\hspace{10em}} \text{Dollars} \\
 \text{Base Contract Amount} \\
 + \quad \$ 20,000 - \text{Twenty Thousand Dollars} \quad \text{Allowance Amount - Unknown Conditions} \\
 \hline
 = \quad \$ \underline{\hspace{10em}} \text{Dollars} \\
 \text{"Contract Price"}
 \end{array}$$

a. **THE ABOVE ALLOWANCES ARE WITHIN THE CONTRACT PRICE ONLY TO THE EXTENT CONTRACTOR HAS PERFORMED WORK ENCOMPASSED BY THE ALLOWANCE DESCRIPTION, CONTRACTOR HAS APPROPRIATELY INVOICED FOR THAT WORK, AND DISTRICT HAS APPROVED CONTRACTOR'S INVOICE. CONTRACTOR SHALL INVOICE ONLY FOR COMPONENTS OF THE WORK ENCOMPASSED BY THE ALLOWANCE DESCRIPTION, IN THE IDENTICAL STRUCTURE AS A CHANGE ORDER. THE UNUSED PORTION OF EACH ALLOWANCE SHALL BE RETAINED BY THE DISTRICT.**

b. The Contract Price shall be paid in lawful money of the United States pursuant to the payment provisions in the General Conditions.

c. The District may, at its sole discretion, increase or decrease the Contract Price by unit prices or alternates contained in Contractor's original bid. If the Bid for the Work included proposal(s) for Alternate Bid Item(s), during Contractor's performance of the Work, the District may elect to add any such Alternate Bid Item(s) if the item did not form a basis for award of the Agreement or delete any such Alternate Bid Item(s) if that item formed a basis for award of the Agreement. If the District elects to add or delete an Alternate Bid Item(s) pursuant to the foregoing, the cost or credit for that Alternate Bid Item(s) shall be as set forth in the Contractor's Bid, at the District's discretion. If any Alternate Bid Item is added or deleted from the Work pursuant to the foregoing, the Contract Time shall be adjusted by the number of days allocated for the added or deleted Alternate Bid Item in the Contract Documents; if days are not allocated for any Alternate Bid Item added or deleted pursuant to the foregoing, the Contract Time shall be equitably adjusted.

9. **Insurance and Bonds:** Contractor shall provide all required certificates of insurance, and payment and performance bonds.

10. **Performance of Work:** If Contractor fails to perform the Work properly or fails to perform any provisions of this Contract, the District, may, pursuant to the General Conditions and without prejudice to any other remedy it may have, cure the deficiencies and deduct the cost thereof from the payment then or thereafter due Contractor.

11. **COVID-19.** Contractor is responsible for complying with all applicable and existing federal, state, and/or local statutes, orders, rules, regulations, ordinances, and/or directives relating to construction site safety in connection with COVID-19, and/or any similar virus or derivative strain. Contractor shall ensure it has supervisor employees onsite that are trained and knowledgeable of all of these requirements to ensure full compliance on Project Site(s).

12. **Authority of Architect, Project Inspector, and DSA:** Contractor hereby acknowledges that the Architect(s), the Project Inspector(s), and the Division of the State Architect have authority to approve and/or stop Work if Contractor's Work does not comply with the requirements of the Contract Documents, Title 24 of the

California Code of Regulations, and all applicable laws. Contractor shall be liable for any delay caused by its non-compliant Work.

- 13. Assignment of Contract:** Neither the Contract, nor any part thereof, nor any moneys due or to become due thereunder, may be assigned by Contractor without the written approval of District, nor without the written consent of the Surety on Contractor's Performance Bond (the "Surety"), unless the Surety has waived in writing its right to notice of assignment.
- 14. Payment of Prevailing Wages:** Contractor and all Subcontractors under Contractor shall pay all workers on Work performed pursuant to this Contract not less than the general prevailing rate of per diem wages and the general prevailing rate for holiday and overtime work as determined by the Director of the Department of Industrial Relations, State of California, for the type of work performed and the locality in which the work is to be performed within the boundaries of the District, pursuant to sections 1770 et seq. of the California Labor Code.
- 15. Contractor & Subcontractor Registration:** Contractor shall comply with the registration and compliance monitoring provisions of Labor Code section 1771.4, including complying with any applicable enforcement by the Department of Industrial Relations.
- 16. Authority of Contractor's Representatives:** Contractor hereby certifies that the person who executes this Agreement has the authority and power to legally bind the Contractor. Contractor also certifies that each person(s) it employees on the Project at or above the level of project superintendent, has the authority to legally bind the Contractor.
- 17. Severability:** If any term, covenant, condition, or provision of the Contract Documents is held by a court of competent jurisdiction to be invalid, void or unenforceable, the remainder of the provisions in the Contract Documents shall remain in full force and effect and shall in no way be affected, impaired, or invalidated thereby.
- 18. Notice:** Any notice required by the Agreement shall be in writing, dated and signed by the party giving notice or by a duly authorized representative of that party. Notice shall be served and considered effective if given in one of the following manners and to the following persons and addresses:
 - a. By personal delivery; considered delivered on the day of delivery.
 - b. By overnight delivery service; considered delivered one (1) day after date deposited, as indicated by the delivery service.
 - c. By depositing same in United States mail, enclosed in a sealed envelope; considered delivered three (3) days after date deposited, as indicated by the postmarked date.
 - d. By registered or certified mail with postage prepaid, return receipt requested; considered delivered on the day the notice is signed for.

If to District
Hayward Unified School District
24411 Amador Street
Hayward, CA 94544
ATTN: Amy Nicolos

If to Contractor:
@Contractor

_____, CA _____
ATTN: _____

IN WITNESS WHEREOF, accepted and agreed on the date indicated above:

Dated: _____, 2025

Dated: _____, 2025

Hayward Unified School District

_____ **Contractor**

Signature: _____

Signature: _____

Print Name: _____

Print Name: _____

Print Title: _____

Print Title: _____

NOTE: If the Contractor is a corporation, Contractor must attach a certified copy of the corporation's by-laws, or of the resolution of the Board of Directors of the corporation, authorizing the above person to execute this Agreement and the bonds required by the Contract Documents.

END OF DOCUMENT

DOCUMENT 00 45 40

CERTIFICATIONS TO BE COMPLETED BY CONTRACTOR

THE UNDERSIGNED MUST CHECK EACH BOX AND EXECUTE THIS FORM AND HEREBY CERTIFIES TO THE GOVERNING BOARD OF THE DISTRICT THAT:

- The undersigned is a representative of the Contractor,
- The undersigned is familiar with the facts herein certified and acknowledged,
- The undersigned is authorized and qualified to execute this Agreement and these certifications on behalf of Contractor and that by executing this Agreement undersigned is certifying the following items.

Labor Code Sections 1860-1861 (Workers' Compensation). In accordance with Labor Code section 3700, every contractor will be required to secure the payment of compensation to his or her employees. I acknowledge and certify under penalty of perjury that I am aware of the provisions of Section 3700 of the Labor Code which require every employer to be insured against liability for workers' compensation or to undertake self-insurance in accordance with the provisions of that code, and I will comply with such provisions before commencing the performance of the work of this contract.

Government Code Sections 8355-8357 (Drug-Free Workplace). I acknowledge and certify under penalty of perjury that I will provide a drug-free workplace by doing all of the following:

- (1) Publishing a statement notifying employees that the unlawful manufacture, distribution, dispensation, possession, or use of a controlled substance is prohibited in the person's or organization's workplace and specifying the actions that will be taken against employees for violations of the prohibition.
- (2) Establishing a drug-free awareness program to inform employees about all of the following:
 - (A) The dangers of drug abuse in the workplace.
 - (B) The person's or organization's policy of maintaining a drug-free workplace.
 - (C) Any available drug counseling, rehabilitation, and employee assistance programs.
 - (D) The penalties that may be imposed upon employees for drug abuse violations.
- (3) Requiring that each employee engaged in the performance of the contract or grant be given a copy of the statement required by subdivision (a) and that, as a condition of employment on the contract or grant, the employee agrees to abide by the terms of the statement.

I also acknowledge that this Contract may be subject to suspension of payments under the contract or grant or termination of the contract or grant, or both, and the contractor or grantee thereunder may be subject to debarment, in accordance with the requirements of the above-referenced statute, if the contracting or granting agency determines that any of the following has occurred:

- (1) The contractor or grantee has made a false certification under Section 8355.
- (2) The contractor or grantee violates the certification by failing to carry out the requirements of subdivisions (a) to (c), inclusive, of Section 8355.

I also acknowledge that the Department of General Services shall establish and maintain a list of individuals and organizations whose contracts or grants have been canceled due to failure to comply with the above-referenced statute. This list shall be updated monthly and published each month. No state agency shall award a contract or grant to a person or organization on the published list until that person or organization has complied with the above-referenced statute.

Tobacco-Free Environment. Pursuant to, without limitation, 20 U.S.C. section 6083, Labor Code section 6400 et seq., Health & Safety Code section 104350 et seq. and District Board Policies, all District sites, including the Project site, are tobacco-free environments. Smoking and the use of tobacco products by all persons is prohibited on or in District property. District property includes school buildings, school grounds, school owned vehicles and vehicles owned by others while on District property.

I acknowledge and certify under penalty of perjury that I am aware of the District's policy regarding tobacco-free environments at District sites, including the Project site and acknowledge and certify that I will adhere to the requirements of that policy and not permit any of my firm's employees, agents, subcontractors, or my firm's subcontractors' employees or agents to use tobacco and/or smoke on the Project site. The District also prohibits electronic cigarettes, "vaping" or similar product uses on District sites.

No Hazardous Materials. I acknowledge and certify under penalty of perjury that no Asbestos, or Asbestos-Containing Materials, polychlorinated biphenyl (PCB), or any material listed by the federal or state Environmental Protection Agency or federal or state health agencies as a hazardous material, or any other material defined as being hazardous under federal or state laws, rules, or regulations ("New Hazardous Material"), shall be furnished, installed, or incorporated in any way into the Project or in any tools, devices, clothing, or equipment used to affect any portion of Contractor's work on the Project for District. I have instructed our employees with respect to the above-mentioned standards, hazards, risks, and liabilities.

- (i) Asbestos and/or asbestos-containing material shall be defined as all items containing but not limited to chrysotile, crocidolite, amosite, anthophyllite, tremolite, and actinolite. Any or all material containing greater than one-tenth of one percent (.1%) asbestos shall be defined as asbestos-containing material. Any disputes involving the question of whether or not material is New Hazardous Material shall be settled by electron microscopy or other appropriate and recognized testing procedure, at the District's determination. The costs of any such tests shall be paid by Contractor if the material is found to be New Hazardous Material.
- (ii) All Work or materials found to be New Hazardous Material or Work or material installed with equipment containing "New Hazardous Material," will be immediately rejected and this Work will be removed at Contractor's expense at no additional cost to the District.

The Contractor must immediately notify the District within two (2) Business Days, if the Contractor finds and before it disturbs, any material that the Contractor believes may be hazardous waste, as defined in section 25117 of the Health and Safety Code, and requires removal to a Class I, Class II, or Class III disposal site in accordance with provisions of existing law.

Lead as a Health Hazard. Lead poisoning is recognized as a serious environmental health hazard facing children today. Even at low levels of exposure, much lower than previously believed, lead can impair the development of a child's central nervous system, causing learning disabilities, and leading to serious behavioral problems. Lead enters the environment as tiny lead particles and lead dust disbursts when paint chips, chinks, peels, wears away over time, or is otherwise disturbed. Ingestion of lead dust is the most common pathway of childhood poisoning; lead dust gets on a child's hands and toys and then into a child's mouth through common hand-to-mouth activity. Exposures may result from construction or remodeling activities that disturb lead paint, from ordinary wear and tear of windows and doors, or from friction on other surfaces.

Ordinary construction and renovation or repainting activities carried out without lead-safe work practices can disturb lead-based paint and create significant hazards. Improper removal practices, such as dry scraping, sanding, or water blasting painted surfaces, are likely to generate high volumes of lead dust.

Because the Contractor and its employees will be providing services for the District, and because the Contractor's work may disturb lead-containing building materials, **Contractor is hereby notified** of the potential presence of lead-containing materials located within certain buildings utilized by the District. All school buildings built prior to

1993 are presumed to contain some lead-based paint until sampling proves otherwise.

(i) **Overview of California Law**

Education Code section 32240 et seq. is known as the Lead Safe Schools Protection Act. Under this act, the Department of Health Services ("DHS") is to conduct a sample survey of schools in the State of California for the purpose of developing risk factors to predict lead contamination in public schools. (Ed. Code, § 32241.)

Any school that undertakes any action to abate existing risk factors for lead is required to utilize trained and state-certified contractors, inspectors, and workers. (Ed. Code, § 32243, subd. (b).) Moreover, lead-based paint, lead plumbing, and solders, or other potential sources of lead contamination, shall not be utilized in the construction of any new school facility or the modernization or renovation of any existing school facility. (Ed. Code, § 32244.)

Both the Federal Occupational Safety and Health Administration ("Fed/OSHA") and the California Division of Occupational Safety and Health ("Cal/OSHA") have implemented safety orders applicable to all construction work where a contractor's employee may be occupationally exposed to lead.

The OSHA Regulations apply to all construction work where a contractor's employee may be occupationally exposed to lead. The OSHA Regulations contain specific and detailed requirements imposed on contractors subject to that regulation. The OSHA Regulations define construction work as work for construction, alteration, and/or repair, including painting and decorating. It includes, but is not limited to, the following:

- a. Demolition or salvage of structures where lead or materials containing lead are present;
- b. Removal or encapsulation of materials containing lead;
- c. New construction, alteration, repair, or renovation of structures, substrates, or portions thereof, that contain lead, or materials containing lead;
- d. Installation of products containing lead;
- e. Lead contamination/emergency cleanup;
- f. Transportation, disposal, storage, or containment of lead or materials containing lead on the site or location at which construction activities are performed; and
- g. Maintenance operations associated with the construction activities described in the subsection.

Because it is assumed by the District that all painted surfaces (interior as well as exterior) within the District contain some level of lead, it is imperative that the Contractor, its workers and subcontractors fully and adequately comply with all applicable laws, rules and regulations governing lead-based materials (including title 8, California Code of Regulations, section 1532. 1).

The Contractor must notify the District if any Work may result in the disturbance of lead-containing building materials. Any and all Work that may result in the disturbance of lead-containing building materials must be coordinated through the District. A signed copy of this Certification must be on file prior to beginning Work on the Project, along with all current insurance certificates.

(ii) **Renovation, Repair and Painting Rule, Section 402(c)(3) of the Toxic Substances Control Act**

In 2008, the U.S. Environmental Protection Agency, issued a rule pursuant to the authority of Section 402(c)(3)

of the Toxic Substances Control Act, requiring lead safe work practices to reduce exposure to lead hazards created by renovation, repair and painting activities that disturb lead-based paint (Renovation, Repair and Painting Rule). Renovations in homes, childcare facilities, and schools built prior to 1978 must be conducted by certified renovations firms, using renovators with accredited training, and following the work practice requirements to reduce human exposures to lead.

Contractor, its workers and subcontractors must fully and adequately comply with all applicable laws, rules and regulations governing lead-based materials, including those rules and regulations appearing within title 40 of the Code of Federal Regulations as part 745 (40 CFR 745).

The requirements apply to all contractors who disturb lead-based paint in a six-square-foot area or greater indoors or a 20-square-foot area outdoors. If a DPH-certified inspector or risk assessor determines that a home constructed before 1978 is lead-free, the federal certification is not required for anyone working on that particular building.

(iii) **Contractor's Liability**

If the Contractor fails to comply with any applicable laws, rules, or regulations, and that failure results in a site or worker contamination, the Contractor will be held solely responsible for all costs involved in any required corrective actions, and shall defend, indemnify, and hold harmless the District, pursuant to the indemnification provisions of the Contract, for all damages and other claims arising therefrom.

If lead disturbance is anticipated in the Work, only persons with appropriate accreditation, registrations, licenses, and training shall conduct this Work.

It shall be the responsibility of the Contractor to properly dispose of any and all waste products, including, but not limited to, paint chips, any collected residue, or any other visual material that may occur from the prepping of any painted surface. It will be the responsibility of the Contractor to provide the proper disposal of any hazardous waste by a certified hazardous waste hauler. This company shall be registered with the Department of Transportation (DOT) and shall be able to issue a current manifest number upon transporting any hazardous material from any school site within the District.

The Contractor shall provide the District with any sample results prior to beginning Work, during the Work, and after the completion of the Work. The District may request to examine, prior to the commencement of the Work, the lead training records of each employee of the Contractor.

I acknowledge and certify under penalty of perjury, that:

1. I have received notification of potential lead-based materials on the District's property;
 2. I am knowledgeable regarding and will comply with all applicable laws, rules, and regulations governing work with, and disposal of, lead.
-

Imported Materials. All soils, aggregate, or related materials ("Fill") that Contractor, a Subcontractor, agent or supplier, in any way, provides or delivers and/or supplies to the Project Site shall be free of any and all hazardous material as defined in section 25260 of the Health and Safety Code, shall satisfy the requirements of any environmental review of the Project performed pursuant to the statutes and guidelines of the California Environmental Quality Act, sections 21000 et seq. of the Public Resources Code ("CEQA"), and shall comply with the requirements of sections 17210 et seq. of the Education Code, including requirements for a Phase I environmental assessment acceptable to the State of California Department of Education and Department of Toxic Substances Control. I acknowledge that, to the furthest extent permitted by California law, the indemnification provisions in the Contract Documents apply to, without limitation, any claim(s) connected with providing, delivering, and/or supplying Fill.

Roofing Contract Financial Interest Certification (Public Contract Code § 3006)

I, _____ **[Your Name]**, _____ **[Firm Name]**
certify that I have not offered, given, or agreed to give, received, accepted, or agreed to accept, any gift, contribution, or any financial incentive whatsoever to or from any person in connection with a roof project contract or subcontract on the Project. As used in this certification, "person" means any natural person, business, partnership, corporation, union, committee, club, or other organization, entity, or group of individuals.

I, _____ **[Your Name]**, _____ **[Firm Name]**
certify that I do not have, and throughout the duration of the Contract, I will not have, any financial relationship in connection with the performance of the Contract with any architect, engineer, roofing consultant, materials manufacturer, distributor, or vendor that is not disclosed below.

I, _____ **[Your Name]**, _____ **[Firm Name]**
have the following financial relationships with an architect, engineer, roofing consultant, materials manufacturer, distributor, or vendor, or other person in connection with the following roof project contract:

Name of firm ("Firm"): _____
Mailing address: _____
Address of branch office used for this Project: _____
If subsidiary, name and address of parent company: _____

For Projects without substantive roofing components, check the following box and execute this certification:

The Work on the Contract (1) does not include the replacement or repair of a roof or (2) is a repair of twenty five percent (25%) or less of the roof, (3) or is a repair project that has a total cost of twenty one thousand dollars (\$21,000) or less.

Russian Sanctions Certification

On February 21, 2022, President Biden issued Executive Order 14065 (<https://www.whitehouse.gov/briefing-room/presidential-actions/2022/02/21/executive-order-on-blocking-property-of-certain-persons-and-prohibiting-certain-transactions-with-respect-to-continued-russian-efforts-to-undermine-the-sovereignty-and-territorial-integrity-of-ukraine/>; "Federal Order") imposing economic sanctions and prohibiting many activities including, but not limited to, investing in, importing to, exporting from, and contracting with, areas of Ukraine and in Russia. On March 4, 2022, California Governor Newsom issued Executive Order N-6-22 requiring state agencies to take steps to ensure any agency and entity under contract with state agencies comply with the Federal Order (<https://www.gov.ca.gov/wp-content/uploads/2022/03/3.4.22-Russia-Ukraine-Executive-Order.pdf>; "State Order").

The District requires the Contractor, as a vendor with the District, to comply with the economic sanctions imposed in response to Russia's actions in Ukraine, including the orders and sanctions identified on the U.S. Department of the Treasury website (<https://home.treasury.gov/policy-issues/financial-sanctions/sanctions-programs-and-country-information/ukraine-russia-related-sanctions>).

If your Firm's contract with the District has a cumulative value of \$5 million or more, your certification here constitutes your written response to the District, indicating:

- (1) that your Firm is in compliance with the required economic sanctions of the Federal and State Orders;
- (2) the steps your Firm has taken in response to Russia's actions in Ukraine, including, but not limited to, desisting from making new investments in, or engaging in financial transactions with, Russian entities, not

transferring technology to Russia or Russian entities, and directly providing support to the government and people of Ukraine.

I ACKNOWLEDGE AND CERTIFY UNDER PENALTY OF PERJURY THAT I AM DULY AUTHORIZED TO LEGALLY BIND THE CONTRACTOR TO ALL PROVISIONS AND ITEMS INCLUDED IN THESE CERTIFICATIONS, THAT THE CONTENTS OF THESE CERTIFICATIONS ARE TRUE, AND THAT THESE CERTIFICATIONS ARE MADE UNDER THE LAWS OF THE STATE OF CALIFORNIA.

Date: _____

Proper Name of Contractor: _____

Signature: _____

Print Name: _____

Title: _____

END OF DOCUMENT

CRIMINAL BACKGROUND INVESTIGATION / FINGERPRINTING CERTIFICATION

The undersigned does hereby certify to the governing board of the District that undersigned is a representative of the Contractor, is familiar with the facts herein certified, is authorized and qualified to execute this certificate on behalf of Contractor; and that the information in this Criminal Background Investigation / Fingerprinting Certification is true and correct.

1. **Education Code.** Contractor has taken at least one of the following actions (check all that apply):

All Workers Fingerprinted. The Contractor has complied with the fingerprinting requirements of Education Code section 45125.1 with respect to all Contractor’s employees and all of its subcontractors’ employees who interact with pupils, outside of the immediate supervision and control of the pupil’s parent or guardian or a school employee, has a valid criminal records summary as described in Education Code Section 44237 (Contractor shall “require each applicant for employment in a position requiring contact with minor pupils to submit two sets of fingerprints prepared for submittal by the employer to the Department of Justice for the purpose of obtaining criminal record summary information from the Department of Justice and the Federal Bureau of Investigation.”). A complete and accurate list of Contractor’s employees and of all of its subcontractors’ employees who may interact with District pupils during the course and scope of the Contract is attached hereto; and/or

Physical Barrier. Pursuant to Education Code section 45125.2, Contractor has installed or will install, prior to commencement of work, a physical barrier at the Project site, that will limit contact between Contractor’s employees and District pupils at all times; and/or

Continual Supervision by Fingerprinted Employee. Pursuant to Education Code section 45125.2, Contractor certifies that all employees will be under the continual supervision of, and monitored by, an employee of the Contractor who the California Department of Justice has ascertained has not been convicted of a violent or serious felony. The name and title of the employee who will be supervising Contractor’s employees and its subcontractors’ employees is:

Name: _____ **Title:** _____

Unoccupied Site. The Work on the Contract is at an unoccupied school site and no employee and/or subcontractor or supplier of any tier of Contract shall come in contact with the District pupils.

2. **Megan’s Law (Sex Offenders).** I have verified and will continue to verify that the employees of Contractor that will be on the Project site and the employees of the Subcontractor(s) that will be on the Project site are **not** listed on California’s “Megan’s Law” Website (<http://www.meganslaw.ca.gov/>).

Contractor’s responsibility for background clearance extends to all of its employees, subcontractors, and employees of subcontractors coming into contact with District pupils regardless of whether they are designated as employees or acting as independent contractors of the Contractor.

Date: _____

Proper Name of Contractor: _____

Signature: _____

Print Name: _____

Title: _____

END OF DOCUMENT

DOCUMENT 00 54 50

ESCROW OF BID DOCUMENTATION

1. Requirement to Escrow Bid Documentation

- a. Contractor shall submit, within **Five (5) Business Days** after the date of the Notice of Award, one copy of all documentary information received or generated by Contractor in preparation of bid prices for this Contract. This material is referred to as "Escrow Bid Documentation." The Escrow Bid Documentation will be held in escrow by the District for the duration of the Contract.
- b. Contractor agrees, as a condition of award of the Contract, that the Escrow Bid Documentation constitutes **ALL** written information used in the preparation of its bid, and that no other written bid preparation information shall be considered in resolving disputes or claims. Contractor also agrees that nothing in the Escrow Bid Documentation shall change or modify the terms or conditions of the Contract Documents.
- c. The Escrow Bid Documentation will not be opened by District except as indicated herein. The Escrow Bid Documentation will be used only to assist in the negotiation of price adjustments and change orders or the settlement of disputes or claims.
- d. Contractor's submission of the Escrow Bid Documentation, as with the bonds and insurance documents required, is considered an essential part of the Contract award. Should the Contractor fail to make the submission within the allowed time specified above, District may deem the Contractor to have failed to enter into the Contract, and the Contractor shall forfeit the amount of its bid security, accompanying the Contractor's bid, and District may award the Contract to the next lowest responsive responsible bidder.
- e. **NO PAYMENTS WILL BE MADE, NOR WILL DISTRICT ACCEPT PROPOSED CHANGE ORDERS UNTIL THE ESCROW BID DOCUMENTATION IS SUBMITTED AND APPROVED.**
- f. The Escrow Bid Documentation shall be submitted in person by an authorized representative of the Contractor to the District.

2. Ownership of Escrow Bid Documentation

- a. The Escrow Bid Documentation is, and shall always remain, the property of Contractor, subject to review by District, as provided herein.
- b. As trade secrets, the Escrow Bid Documentation is proprietary and confidential to the extent allowed by law. Escrow Bid Documentation constitute trade secrets, not known outside Contractor's business, known only to a limited extent and only by a limited number of employees of Contractor, safeguarded while in Contractor's possession, extremely valuable to Contractor, and could be extremely valuable to Contractor's competitors by virtue of it reflecting Contractor's contemplated techniques of construction. Subject to the provisions herein, District agrees to safeguard the Escrow Bid Documentation, and all information contained therein, against disclosure to the fullest extent permitted by law.

3. Format and Contents of Escrow Bid Documentation

- a. Contractor may submit Escrow Bid Documentation in its usual cost-estimating format; a standard format is not required.
- b. Escrow Bid Documentation must clearly itemize the estimated costs of performing the work of each bid item contained in the bid schedule, separating bid items into sub-items as required to present a detailed cost estimate and allow a detailed cost review.

- c. **Subcontractors.** The Escrow Bid Documentation shall include all subcontractor bids or quotes, supplier bids or quotes, quantity takeoffs, crews, equipment, calculations of rates of production and progress, copies of quotes from subcontractors and suppliers, and memoranda, narratives, add/deduct sheets, and all other information used by the Contractor to arrive at the prices contained in the bid proposal.
- d. Estimated costs should be broken down into Contractor's usual estimate categories such as direct labor, repair labor, equipment ownership and operation, expendable materials, permanent materials, and subcontract costs as appropriate. Plant and equipment and indirect costs should be detailed in the Contractor's usual format. The Contractor's allocation of indirect costs, contingencies, markup, and other items to each bid item shall be identified.
- e. **All costs shall be identified.** For bid items amounting to less than \$10,000, estimated unit costs are acceptable without a detailed cost estimate, provided that labor, equipment, materials, and subcontracts, as applicable, are included and provided that indirect costs, contingencies, and markup, as applicable, are allocated.
- f. Bid Documentation provided by District should not be included in the Escrow Bid Documentation unless needed to comply with the following requirements.

4. Submittal of Escrow Bid Documentation

- a. The Escrow Bid Documentation shall be submitted by the Contractor in a sealed container/envelope within **Five (5) Business Days** after the date of the Notice of Award. The container/envelope shall be clearly marked on the outside with the Contractor's name, date of submittal, project name and the words ***"Escrow Bid Documentation – To be opened only after written notice to Contractor and District."***
- b. By submitting Escrow Bid Documentation, Contractor represents that the material in the Escrow Bid Documentation constitutes of all the documentary information used in preparation of the bid and that the Contractor has personally examined the contents of the Escrow Bid Documentation container and has found that the documents in the container are complete.
- c. **Subcontractors.** If Contractor's proposal is based upon subcontracting any part of the work, each subcontractor whose total subcontract price exceeds five percent (5%) of the total contract price proposed by Contractor, shall provide separate escrow documents to be included with those of Contractor. Those documents shall be opened and examined in the same manner and at the same time as the examination described above for Contractor. Each subcontractor's documents can be sealed within Contractor's Escrow Bid Documentation and will only be opened if the change order or dispute at issue relates to that subcontractor(s)' scope of work.
- d. If Contractor wishes to subcontract any portion of the Work after award of the Contract, District retains the right to require Contractor to submit escrow documents for the Subcontractor before the subcontract is approved.

5. Storage, Examination and Final Disposition of Escrow Bid Documentation

- a. The Escrow Bid Documentation will be placed in escrow, for the term of the Contract, at the District offices.
- b. The Escrow Bid Documentation may be examined by the District, by the Contractor, and/or by both parties, upon **Five (5) Business Days** written notice from the party noticing the examination to the other party.
- c. An examination is permissible at any time that one party reasonably believes that an examination of the

Escrow Bid Documentation is necessary to assist in the negotiation of price adjustments and change orders or the settlement of disputes or claims. In the case of legal proceedings, Escrow Bid Documentation may be subject to the terms of an appropriate protective order, if requested via motion by Contractor and ordered by a court of competent jurisdiction.

- d. If Contractor or District fails to designate a representative or fails to appear for the noticed examination, then the Contractor or District representative may examine the Escrow Bid Documents alone if a representative of the Contractor or District does not appear at the time set.
- e. **Subcontractor.** If a subcontractor has submitted sealed information that is included in the Escrow Bid Documentation and that subcontractor is reasonably involved in the negotiation of price adjustments and change orders or the settlement of disputes or claims, then the party requesting examination (the Contractor or the District) is required to also notify that Subcontractor with the same **Five (5) Business Days** written notice that the requesting party sends to the other party.
- f. The Escrow Bid Documentation will be returned to Contractor when the District accepts Project Completion, when all of Contractor's claims (if any) have been resolved to District's and Contractor's satisfaction, and when the Contractor certifies that it has no further claims against the District.

END OF DOCUMENT

DOCUMENT 00 54 55

ESCROW AGREEMENT FOR SECURITY DEPOSITS IN LIEU OF RETENTION
(Public Contract Code § 22300)

This Escrow Agreement ("Escrow Agreement") is made and entered into on _____
_____, 202_____, by and between the following:

Hayward Unified School District ("District"), whose address is _____
_____, California, and

_____ ("Contractor"), whose address is _____
_____, and

_____ ("Escrow Agent"), a state or federally chartered bank in
California, whose address is _____.

For the consideration hereinafter set forth, District, Contractor, and Escrow Agent agree as follows:

1. Pursuant to section 22300 of Public Contract Code of the State of California, which is hereby incorporated by reference, Contractor has the following two (2) options:

Deposit securities with Escrow Agent as a substitute for retention earnings required to be withheld by District pursuant to the Construction Contract No. _____ entered into between District and Contractor for the _____ Project, in the amount of _____ (\$ _____) dated, _____, 20_____, (the "Contract");

OR

On written request of Contractor, District shall make payments of the retention earnings for the Contract directly to Escrow Agent.

When Contractor deposits the securities as a substitute for Contract earnings, Escrow Agent shall notify District within ten (10) calendar days of the deposit. The market value of the securities at all times from substitution until the termination of the Escrow Agreement shall be at least equal to the cash amount then required to be withheld as retention pursuant to the Contract.

Securities shall be held in name of **Hayward Unified School District**, and shall designate Contractor as beneficial owner.

2. District shall make payments to Contractor for those funds which otherwise would be withheld from payments pursuant to Contract provisions, provided that Escrow Agent holds securities in the form and amount specified above.
3. When District makes payment of retention earned directly to Escrow Agent, Escrow Agent shall hold them for the benefit of Contractor until the time that the escrow created under this Escrow Agreement is terminated. Contractor may direct the investment of the payments into securities. All terms and conditions of this Escrow Agreement and the rights and responsibilities of the Parties shall be equally applicable and binding when District pays Escrow Agent directly.
4. Contractor shall be responsible for paying all fees for the expenses incurred by Escrow Agent in administering the Escrow Account, and all expenses of District. These expenses and payment terms shall be determined by District, Contractor, and Escrow Agent.
5. Interest earned on securities or money market accounts held in escrow and all interest earned on that interest

shall be for sole account of Contractor and shall be subject to withdrawal by Contractor at any time and from time to time without notice to District.

6. Contractor shall have the right to withdraw all or any part of the principal in the Escrow Account only by written notice to Escrow Agent accompanied by written authorization from District to Escrow Agent that District consents to withdrawal of amount sought to be withdrawn by Contractor.
7. District shall have the right to draw upon the securities and/or withdraw amounts from the Escrow Account in event of default by Contractor. Upon seven (7) days written notice to Escrow Agent from District of the default, if applicable, Escrow Agent shall immediately convert the securities to cash and shall distribute the cash as instructed by District.
8. Upon receipt of written notification from District certifying that the Contract is final and complete, and that Contractor has complied with all requirements and procedures applicable to the Contract, Escrow Agent shall release to Contractor all securities and interest on deposit less escrow fees and charges of the Escrow Account. The escrow shall be closed immediately upon disbursement of all monies and securities on deposit and payments of fees and charges.
9. Escrow Agent shall rely on written notifications from District and Contractor pursuant to Paragraphs 5 through 8, inclusive, of this Escrow Agreement and District and Contractor shall hold Escrow Agent harmless from Escrow Agent's release and disbursement of securities and interest as set forth above.
10. Names of persons who are authorized to give written notice or to receive written notice on behalf of District and on behalf of Contractor in connection with the foregoing, and exemplars of their respective signatures are as follows:

On behalf of District:

Title

Name

Signature

Address

On behalf of Contractor:

Title

Name

Signature

Address

On behalf of Escrow Agent:

Title

Name

Signature

Address

At the time the Escrow Account is opened, District and Contractor shall deliver to Escrow Agent a fully executed copy of this Escrow Agreement.

IN WITNESS WHEREOF, the parties have executed this Escrow Agreement by their proper officers on the date first set forth above.

Hayward Unified School District

_____ **Contractor**

Signature: _____

Signature: _____

Print Name: _____

Print Name: _____

Print Title: _____

Print Title: _____

_____ **Escrow Agent**

Signature: _____

Print Name: _____

Print Title: _____

END OF DOCUMENT

DOCUMENT 00 61 14

PERFORMANCE BOND (100% of Contract Price)
(Note: Contractors must use this form, NOT a surety company form.)

WHEREAS, the governing board ("Board") of the **Hayward Unified School District**, ("District") and

_____, ("Principal")

have entered into a contract for the furnishing of all materials and labor, services and transportation, necessary, convenient, and proper to perform the following project:

Bid No. 26.004 REBID Supply and Installation of Acoustical Towers at HUSD PAC ("Project" or "Contract")

which Contract dated June 26, 2025, and all of the Contract Documents attached to or forming a part of the Contract, are hereby referred to and made a part hereof, and

WHEREAS, the Principal is required under the terms of the Contract to furnish a bond for the faithful performance of the Contract;

NOW, THEREFORE, the Principal and _____ ("Surety") are held and firmly bound unto the District in the penal sum of:

\$ _____ **DOLLARS,**

lawful money of the United States, for payment to the District and will and truly be made pursuant to the provisions herein. Principal and Surety, each of us, bind ourselves, our heirs, executors, administrators, successors, and assigns jointly and severally to:

- Perform all the work required to complete the Project; and
- Pay to the District all damages the District incurs as a result of the Principal's failure to perform all the Work required to complete the Project.

In the event the Principal is declared by the District to be in breach or default in the performance of the Contract, then, after written notice from the District to the Surety, as provided for herein, the Surety shall either remedy the default or breach of the Principal or shall take charge of the Work of the Contract and complete the Contract with a Contractor other than the Principal at its own expense; provided, however, that the procedure by which the Surety undertakes to discharge its obligations under this Bond shall be subject to the advance written approval of the District.

The condition of the obligation is such that, if the above bounden Principal, his or its heirs, executors, administrators, successors, or assigns, shall in all things stand to and abide by, and well and truly keep and perform the covenants, conditions, and agreements in the Contract and any alteration thereof made as therein provided, on his or its part to be kept and performed at the time and in the intent and meaning, including all contractual guarantees and warranties of materials and workmanship, and shall indemnify and save harmless the District, its trustees, officers and agents, as therein stipulated, then this obligation shall become null and void, otherwise it shall be and remain in full force and effect.

As a condition precedent to the satisfactory completion of the Contract, the above obligation shall hold good for a period equal to the warranty and/or guarantee period of the Contract, during which time Surety's obligation shall continue if Contractor shall fail to make full, complete, and satisfactory repair, replace, and totally protect the District from loss or damage resulting from or caused by defective materials or faulty workmanship. The obligations of Surety hereunder shall continue so long as any obligation of Contractor remains. Nothing herein shall limit the District's rights or the Contractor's or Surety's obligations under the Contract, law or equity,

including, but not limited to, California Code of Civil Procedure section 337.15.

The Surety, for value received, hereby stipulates and agrees that no change, extension of time, alteration, or addition to the terms of the Contract or to the Work to be performed thereunder shall in any way affect its obligation on this bond, and it does hereby waive notice of any such change, extension of time, alteration, or addition to the Contract Documents or to the Work.

Any claims under this bond may be addressed to the Surety at the following address. This cannot be the Contractor's broker for this bond, but must be an employee of the Surety or the Surety's legal counsel:

Attention: _____

Telephone No.: (_____) _____ - _____

Fax No.: (_____) _____ - _____

E-mail Address: _____

IN WITNESS WHEREOF, two (2) identical counterparts of this instrument, each of which shall for all purposes be deemed an original thereof, have been duly executed by the Principal and Surety above named, on the _____ day of _____, 2025.

Principal

Surety

(Name of Principal)

(Name of Surety)

(Signature of Person with Authority)

(Signature of Person with Authority)

(Print Name)

(Print Name)

(Name of California Agent of Surety)

(Address of California Agent of Surety)

(Telephone Number of California Agent of Surety)

Contractor must attach a Notarial Acknowledgment for all Surety's signatures and a Power of Attorney and Certificate of Authority for Surety. The California Department of Insurance must authorize the Surety to be an admitted surety insurer.

END OF DOCUMENT

DOCUMENT 00 61 15

PAYMENT BOND -- Contractor's Labor & Material Bond (100% of Contract Price)
(Note: Contractors must use this form, NOT a surety company form.)

WHEREAS, the governing board ("Board") of the **Hayward Unified School District**, ("District") and

_____, ("Principal")

have entered into a contract for the furnishing of all materials and labor, services and transportation, necessary, convenient, and proper to perform the following project:

Bid No. 26.004 REBID Supply and Installation of Acoustical Towers at HUSD PAC ("Project" or "Contract")

which Contract dated June 26, 2025, and all of the Contract Documents attached to or forming a part of the Contract, are hereby referred to and made a part hereof, and

WHEREAS, pursuant to law and the Contract, the Principal is required, before entering upon the performance of the work, to file a good and sufficient bond with the body by which the Contract is awarded in an amount equal to 100 percent (100%) of the Contract price, to secure the claims to which reference is made in the Civil Code of California, including section 9100, and the Labor Code of California, including section 1741.

NOW, THEREFORE, the Principal and _____ ("Surety") are held and firmly bound unto all laborers, material men, and other persons referred to in said statutes in the penal sum of:

\$ _____ **DOLLARS,**

lawful money of the United States, being a sum not less than the total amount payable by the terms of Contract, for the payment of which sum well and truly to be made pursuant to all applicable statutes and laws applicable to the provisions herein. Principal and Surety, each of us, bind ourselves, our heirs, executors, administrators, successors, or assigns, jointly and severally, to those applicable statutes and laws, and to the provisions herein.

The condition of this obligation is that if the Principal or any of his or its subcontractors, of the heirs, executors, administrators, successors, or assigns of any, all, or either of them shall fail to pay for any labor, materials, provisions, equipment, or other supplies, used in, upon, for or about the performance of the work contracted to be done, or for any work or labor thereon of any kind, or for amounts due under the Unemployment Insurance Act with respect to that work or labor, that the Surety will pay the same in an amount not exceeding the amount herein above set forth, and also in case suit is brought upon this bond, will pay a reasonable attorney's fee to be awarded and fixed by the Court, and to be taxed as costs and to be included in the judgment therein rendered.

It is hereby expressly stipulated and agreed that this bond shall inure to the benefit of any and all persons, companies, and corporations entitled to file claims under sections 9000 through 9566 of the Civil Code, so as to give a right of action to them or their assigns in any suit brought upon this bond.

Should the condition of this bond be fully performed, then this obligation shall become null and void; otherwise it shall be and remain in full force and affect.

The Surety, for value received, hereby stipulates and agrees that no change, extension of time, alteration, or addition to the terms of the Contract or to the Work to be performed thereunder shall in any way affect its obligation on this bond, and it does hereby waive notice of any such change, extension of time, alteration, or addition to the Contract Documents or to the Work.

IN WITNESS WHEREOF, two (2) identical counterparts of this instrument, each of which shall for all purposes be

deemed an original thereof, have been duly executed by the Principal and Surety above named, on the _____ day of _____, 2025.

Principal

Surety

(Name of Principal)

(Name of Surety)

(Signature of Person with Authority)

(Signature of Person with Authority)

(Print Name)

(Print Name)

(Name of California Agent of Surety)

(Address of California Agent of Surety)

(Telephone Number of California Agent of Surety)

Contractor must attach a Notarial Acknowledgment for all Surety's signatures and a Power of Attorney and Certificate of Authority for Surety. The California Department of Insurance must authorize the Surety to be an admitted surety insurer.

END OF DOCUMENT

DOCUMENT 00 65 10

NOTICE TO PROCEED

Dated: _____, 2025

To: _____
("Contractor")

(Address)

From: Governing Board ("Board") of **Hayward Unified School District** ("District")

Re: **Bid No. 26.004 REBID Supply and Installation of Acoustical Towers at HUSD PAC** ("Project" or "Contract")

Contractor is hereby notified that the Contract Time under the Contract will commence to run on _____, 2025. By that date, Contractor shall start performing its obligations under the Contract Documents. In accordance with the Agreement executed by Contractor, the Contract Time and Project Completion is _____, 2025.

Contractor must submit the following documents by 5:00 p.m. of the **TENTH (10TH)** calendar day following the date of this Notice to Proceed:

1. Contractor's preliminary schedule of construction.
2. Contractor's preliminary schedule of submittals, including Shop Drawings, Product Data, and Samples submittals.
3. Contractor's preliminary schedule of values for all of the Work.
4. Contractor's preliminary Contractor's Safety Plan specifically adapted for the Project.
5. A complete subcontractors list, including the name, address, telephone number, facsimile number, California State Contractor's License number, classification, and monetary value of all Subcontracts.

Thank you. We look forward to a successful Project.

Hayward Unified School District

SIGNATURE: _____

NAME: _____

TITLE: _____

END OF DOCUMENT

DOCUMENT 00 65 36

WARRANTY AND GUARANTEE FORM

1. _____ ("Contractor")

hereby agrees that the _____ ("Work" of Contractor)

which Contractor has installed for the **Hayward Unified School District** ("District") for the following project:

Bid No. 26.004 REBID Supply and Installation of Acoustical Towers at HUSD PAC ("Project" or "Contract")

was performed in accordance with the requirements of the Contract Documents and that the Work as installed fulfills the requirements of the Contract Documents.

2. Contractor agrees to repair or replace all of the Work that may prove to be defective in workmanship or material and any other adjacent Work that may be displaced in connection with such replacement within a period of _____ **YEAR(S)** from the date of Completion as defined in the Contract, ordinary wear and tear and unusual abuse or neglect excepted. The date of completion is _____, 20__.

3. In the event Contractor fails to comply with the above-mentioned conditions within a reasonable period of time, as determined by District, but not later than **SEVEN (7)** calendar days after being notified in writing by District, Contractor authorizes District to proceed to repair or replace the defective Work at the expense of Contractor. Contractor shall pay the costs and charges therefor upon demand.

4. **Representatives to be contacted for service subject to the terms of Contract:**

NAME: _____

ADDRESS: _____

PHONE NO.: _____

EMAIL: _____

Date: _____

Proper Name of Contractor: _____

Signature: _____

Print Name: _____

Title: _____

END OF DOCUMENT

DOCUMENT 00 70 00

TABLE OF CONTENTS

GENERAL CONDITIONS

1.	CONTRACT TERMS AND DEFINITIONS.....	1
1.1.	Definitions	1
1.2.	Laws Concerning the Contract.....	5
1.3.	No Oral Agreements	5
1.4.	No Assignment.....	5
1.5.	Confidentiality	5
1.6.	Notice and Service Thereof	5
1.7.	No Waiver.....	5
1.8.	Substitutions for Specified Items.....	6
1.9.	Materials and Work	7
2.	DISTRICT	8
3.	ARCHITECT	9
4.	CONSTRUCTION MANAGER.....	9
5.	INSPECTOR, INSPECTIONS AND TESTS	9
5.1.	Project Inspector.....	9
5.2.	Tests and Inspections.....	10
5.3.	Costs for After Hours and/or Off Site Inspections.....	11
6.	CONTRACTOR.....	11
6.1.	Status of Contractor	11
6.2.	Contractor’s Supervision	11
6.3.	Duty to Provide Fit Workers.....	12
6.4.	Personnel.....	13
6.5.	Prohibition on Harassment	14
6.6.	Conferences and Meetings.....	14
6.7.	Purchase of Materials and Equipment.....	15
6.8.	Documents on Work	16
6.9.	Preservation of Records.....	17
6.10.	Integration of Work	17
6.11.	Obtaining of Permits and Licenses	17
6.12.	Work to Comply with Applicable Laws and Regulations	18
6.13.	Safety/Protection of Persons and Property.....	19
6.14.	Working Evenings and Weekends	22
6.15.	Noise and Dust Control	22
6.16.	Cleaning Up	23
7.	SUBCONTRACTORS.....	23
8.	OTHER CONTRACTS/CONTRACTORS	24
9.	DRAWINGS AND SPECIFICATIONS.....	25
9.8.	Ownership of Drawings.....	25
10.	CONTRACTOR’S SUBMITTALS AND SCHEDULES	26
10.1.	Schedules, Safety Plan and Complete Subcontractor List	26
10.2.	Monthly Progress Schedule(s)	29
10.3.	Material Safety Data Sheets (MSDS)	29
10.4.	Logistic Plan	29
10.5.	Information Included in Submittals.....	29
10.6.	Verification of Submittal Information.	30
10.7.	Contractor Responsibility for Deviations.	30

10.8.	No Performance of Work Without Architect Review	30
10.9.	District and Architect Review of Submittals.	30
10.10.	Deferred Approval Items.....	30
10.11.	Contractor Responsibility for Deviations	31
11.	SITE ACCESS, CONDITIONS AND REQUIREMENTS	31
11.1.	Site Investigation	31
11.2.	Soils Investigation Report	31
11.3.	Access to Work	32
11.4.	Layout and Field Engineering	32
11.5.	Utilities for Construction	32
11.6.	Sanitary Facilities	32
11.7.	Surveys	32
11.8.	Regional Notification Center	32
11.9.	Existing Utility Lines	33
11.10.	Notification	33
11.11.	Hazardous Materials	33
11.12.	No Signs	33
12.	TRENCHES	34
12.1.	Trenches Greater Than Five Feet.....	34
12.2.	Excavation Safety.....	34
12.3.	No Tort Liability of District	34
12.4.	No Excavation without Permits.....	34
12.5.	Discovery of Hazardous Waste, Unusual Conditions and/or Unforeseen Conditions	34
13.	INSURANCE AND BONDS.....	35
13.1.	Insurance	35
13.2.	Contract Security – Bonds	38
14.	WARRANTY/GUARANTEE/INDEMNITY	38
14.1.	Warranty/Guarantee	38
14.2.	Indemnity	39
15.	TIME	40
15.1.	Notice to Proceed	40
15.2.	Hours of Work.....	40
15.3.	Progress and Completion	40
15.4.	Schedule	41
15.5.	Expeditious Completion	41
16.	EXTENSIONS OF TIME – LIQUIDATED DAMAGES.....	41
16.1.	Contractor’s Notice of Delay	41
16.2.	Excusable and Compensable Delay(s).....	42
16.3.	Excusable and Non-Compensable Delay(s).....	43
16.4.	Unexcused Delay(s) – Liquidated Damages	45
17.	CHANGES IN THE WORK	45
17.1.	No Changes Without Authorization.....	45
17.2.	Architect Authority	46
17.3.	Change Orders	46
17.4.	Unilateral Change Orders	47
17.5.	Force Account Directives.....	47
17.6.	Price Request	48
17.7.	Proposed Change Order	49
17.8.	Format for Proposed Change Order	50
17.9.	Change Order Certification.....	55
17.10.	Determination of Change Order Cost	55
17.11.	Deductive Change Orders.....	56

17.12.	Discounts, Rebates and Refunds	56
17.13.	Accounting Records	56
17.14.	Notice Required	56
17.15.	Applicability to Subcontractors	56
17.16.	Alteration to Change Order Language	56
17.17.	Failure of Contractor to Execute Change Order	57
18.	REQUEST FOR INFORMATION.....	57
19.	PAYMENTS.....	57
19.1.	Contract Price	57
19.2.	Applications for Progress Payments.....	58
19.3.	Progress Payments.....	60
19.4.	Decisions to Withhold Payment.....	62
19.5.	Subcontractor Payments.....	64
20.	COMPLETION OF THE WORK.....	64
20.1.	Completion	64
20.2.	Closeout Procedures	64
20.3.	Final Inspection.....	65
20.4.	Costs of Multiple Inspections	66
20.5.	Partial Occupancy or Use Prior to Completion.....	66
21.	FINAL PAYMENT AND RETENTION.....	67
21.1.	Final Payment	67
21.2.	Prerequisites for Final Payment	67
21.3.	Retention.....	68
21.4.	Substitution of Securities	68
21.5.	Claims Asserted After Final Payment	68
22.	UNCOVERING WORK, CORRECTION OF WORK AND RIGHT TO TAKEOVER WORK.....	68
22.1.	Uncovering of Work	68
22.2.	Rejection of Work	69
22.3.	Nonconforming Work	69
22.4.	Correction of Work	69
22.5.	District's Right to Takeover Work.....	69
23.	TERMINATION AND SUSPENSION.....	70
23.1.	District's Right to Terminate Contractor for Cause	70
23.2.	Emergency Termination of Public Contracts Act of 1949	72
23.3.	Termination of Contractor for Convenience	73
23.4.	Suspension of Work	73
23.5.	Scope Reduction	73
24.	CLAIMS RESOLUTION	74
24.1.	Exclusive Remedy.	74
24.2.	Performance during Claim Resolution Process.	74
24.3.	Waiver.	74
24.4.	Intention.....	74
24.5.	Other Provisions.	74
24.6.	Claim Presentation.....	75
24.7.	Documentation of Resolution.	79
24.8.	Claim Resolution Process – Non-Applicability.....	79
25.	LABOR, WAGE & HOUR, APPRENTICE AND RELATED PROVISIONS.....	80
25.1.	Contractor & Subcontractor Registration	80
25.2.	Wage Rates, Travel and Subsistence	80
25.3.	Hours of Work.....	82
25.4.	Payroll Records	82
25.5.	Apprentices.....	84

25.6.	Non-Discrimination	85
25.7.	Labor First Aid.....	85
26.	MISCELLANEOUS	85
26.1.	Assignment of Antitrust Actions.....	85
26.2.	Excise Taxes	86
26.3.	Taxes	86
26.4.	Shipments.....	86
26.5.	Compliance with Government Reporting Requirements.....	86

1. CONTRACT TERMS AND DEFINITIONS

1.1. Definitions

Wherever used in the Contract Documents, the following terms shall have the meanings indicated, which shall be applicable to both the singular and plural thereof:

1.1.1. Adverse Weather: Weather that satisfies all of the following conditions: (1) unusually severe precipitation, sleet, snow, hail, heat, or cold conditions in excess of the norm for the location and time of year it occurred, (2) unanticipated, and (3) occurring at the Project Site.

1.1.2. Allowance(s): Amount(s) stated in the Agreement for specific scopes of work for which Contractor may, upon District's written approval, bill its time, materials, and other items in the identical structure as a Change Order.

1.1.3. Approval, Approved, and/or Accepted: Refer to written authorization, unless stated otherwise.

1.1.4. Architect: The individual, partnership, corporation, joint venture, or any combination thereof, named as Architect that has the rights and authority assigned to the Architect in the Contract Documents. The term Architect means the District's Architect on this Project or the Architect's authorized representative. If no Architect is used on the Project, then all references in the Contract Documents to Architect shall be read to refer to District.

1.1.5. As-Built Drawings: A reproducible full-size sets of drawings to be prepared on a monthly basis, and upon Project Completion, pursuant to the Contract Documents, that reflect changes made during the performance of the Work, recording differences between the original design of the Work and the Work as constructed.

1.1.6. Bidder: A contractor who provides a bid to the District to perform the Work of the Contract.

1.1.7. Change Order: A written order to the Contractor authorizing an addition to, deletion from, or revision in the Work, and/or authorizing an adjustment in the Contract Price or Contract Time. If a Change Order is required to be approved by DSA, the District may call it a Construction Change Document.

1.1.8. Completion: When the entire Work shall have been completed, including all punch list items, as further detailed in the "Completion of the Project" Section herein. Final DSA approval of the Project is not required for Completion. There is no "Substantial Completion" or "Beneficial Occupancy" for this Project, although the District may occupy the Project prior to completion as permitted herein.

1.1.9. Construction Manager: The individual, partnership, corporation, joint venture, or any combination thereof, or its authorized representative, named as such by the District. If no Construction Manager is used on the Project, then all references in the Contract Documents to Construction Manager shall be read to refer to District.

1.1.10. Construction Schedule: The progress schedule of construction of the Project as provided by Contractor and approved by District.

1.1.11. Contract, Contract Documents: The Contract consists exclusively of the documents evidencing the agreement of the District and Contractor, identified as the Contract Documents. The Contract Documents consist of the following documents:

1.1.11.1. Notice to Bidders / Invitation to Bid

- 1.1.11.2.** Instructions to Bidders
- 1.1.11.3.** Bid Form
- 1.1.11.4.** Bid Bond
- 1.1.11.5.** Designated Subcontractors List
- 1.1.11.6.** Noncollusion Declaration
- 1.1.11.7.** Iran Contracting Act Certification
- 1.1.11.8.** Certifications to be Completed by Contractor
- 1.1.11.9.** Criminal Background Investigation/Fingerprinting Certification
- 1.1.11.10.** Notice of Award
- 1.1.11.11.** Agreement
- 1.1.11.12.** Escrow of Bid Documentation (if applicable)
- 1.1.11.13.** Escrow Agreement for Security Deposits in Lieu of Retention
- 1.1.11.14.** Storm Water Pollution Prevention Plan (if applicable)
- 1.1.11.15.** Notice to Proceed
- 1.1.11.16.** Performance Bond
- 1.1.11.17.** Payment Bond (Contractor's Labor and Material Bond)
- 1.1.11.18.** District Contract Forms (if applicable)
- 1.1.11.19.** District Closeout Forms (if applicable)
- 1.1.11.20.** Warranty and Guarantee Form
- 1.1.11.21.** General Conditions
- 1.1.11.22.** Special Conditions
- 1.1.11.23.** Project Plans, Specifications, Technical Specifications, and Drawings
- 1.1.11.24.** Addenda to any of the above documents
- 1.1.11.25.** Schedules if approved in writing by the District
- 1.1.11.26.** Change Orders or written modifications to the above documents if approved in writing by the District

1.1.12. Contract Price: The total monies payable to the Contractor under the terms and conditions of the Contract Documents.

1.1.13. Contract Time: The time period stated in the Agreement for the Completion of the Work.

1.1.14. Contractor: The licensed person, entity, or entities identified in the Agreement as contracting to perform the Work.

1.1.15. Daily Job Report(s): Daily Project reports prepared by the Contractor's employee(s) who are present on Site, which shall include the information required herein.

1.1.16. Day(s): Unless otherwise designated, day(s) means calendar day(s). **"Business Day(s)"** shall mean days except Saturday, Sunday, a day that is federally-recognized holiday, or a day that is a California-recognized holiday.

1.1.17. Defective or Nonconforming Work. Defective or nonconforming Work is any Work which is unsatisfactory, faulty or deficient by: (a) not conforming to the requirements of the Contract Documents; (b) not conforming to the standards of workmanship of the applicable trade; (c) not being in compliance with the requirements of any inspection, reference, standard, test, or approval required by the Contract Documents; or (d) damage to Work occurring prior to Completion.

1.1.18. District: The public agency or the school district for which the Work is performed.

1.1.19. Drawings: (or "Plans") The graphic and pictorial portions of the Contract Documents showing the design, location, scope and dimensions of the Work, generally including plans, elevations, sections, details, schedules, sequence of operation, and diagrams.

1.1.20. DSA: Division of the State Architect.

1.1.21. Force Account Directive: A process that may be used when the District and the Contractor cannot agree on a price for a specific scope of work or before Contractor prepares a price for the scope of work and Contractor is directed in writing by the District to perform on a time and materials basis.

1.1.22. Premises: The real property owned by the District on which the Project Site is located. For example, if the Project is only being performed on a portion of a school, the Site is only the area where the Project is located (the Project Site), and the Premises is the entire school site.

1.1.23. Product(s): New material, machinery, components, equipment, fixtures and systems forming the Work, including existing materials or components required and approved by the District for reuse.

1.1.24. Product Data: Illustrations, standard schedules, performance charts, instructions, brochures, diagrams, and other information furnished by Contractor to illustrate a material, product, or system for a scope of the Work.

1.1.25. Project: The planned undertaking as provided for in the Contract Documents.

1.1.26. Project Inspector: (or "Inspector") Individual(s) retained by the District in accordance with title 24 of the California Code of Regulations to monitor and inspect the Project. If no Project Inspector is used on the Project, then all references in the Contract Documents to Project Inspector shall be read to refer to District.

1.1.27. Program Manager: The individual, partnership, corporation, joint venture, or any combination thereof, or its authorized representative, named as such by the District. If no Program Manager is designated for the Project then all references to Program Manager shall refer to District.

1.1.28. Proposed Change Order: A written request prepared by the Contractor requesting that the District and the Architect issue a Change Order based upon a proposed change to the Work.

1.1.29. Provide: Shall include "provide complete in place," that is, "furnish and install," and "provide

complete and functioning as intended in place” unless specifically stated otherwise.

1.1.30. Request for Information: (or “RFI”) A written request prepared by the Contractor requesting that the Architect provide additional information necessary to clarify or amplify an item in the Contract Documents that the Contractor believes is not clearly shown or called for in the Drawings or Specifications or other portions of the Contract Documents, or to address issues that have arisen under field conditions.

1.1.31. Request for Substitution: A request by Contractor to substitute an equal or superior material, product, thing, or service for a specific material, product, thing, or service that has been designated in the Contract Documents by a specific brand or trade name.

1.1.32. Safety Orders: Written and/or verbal orders for construction issued by the California Division of Industrial Safety (“CalOSHA”) or by the United States Occupational Safety and Health Administration (“OSHA”).

1.1.33. Safety Plan: Contractor’s safety plan specifically adapted for the Project. Contractor's Safety Plan shall comply with all provisions regarding Project safety, including all applicable provisions in these General Conditions.

1.1.34. Samples: Physical examples that illustrate materials, products, equipment, finishes, colors, or workmanship and that, when approved in accordance with the Contract Documents, establish standards by which portions of the Work will be judged.

1.1.35. Shop Drawings: All drawings, prints, diagrams, illustrations, brochures, schedules, and other data that are prepared by the Contractor, a subcontractor, manufacturer, supplier, or distributor, that illustrate how specific portions of the Work shall be fabricated or installed.

1.1.36. Site: The Project site as shown on the Drawings.

1.1.37. Specifications: That portion of the Contract Documents, Division 1 through Division 17, and all technical sections, and addenda to all of these, if any, consisting of written descriptions and requirements of a technical nature of materials, equipment, construction methods and systems, standards, and workmanship.

1.1.38. Subcontractor: A contractor and/or supplier who is under contract with the Contractor or with any other subcontractor, regardless of tier, to perform a portion of the Work.

1.1.39. Submittal Schedule: The schedule of submittals as provided by Contractor and approved by District.

1.1.40. Surety: The person, firm, or corporation that executes as surety the Contractor’s Performance Bond and Payment Bond, and must be a California admitted surety insurer as defined in the Code of Civil Procedure section 995.120.

1.1.41. SWPPP: The District’s Storm Water Pollution Prevention Plan.

1.1.42. Terms. The term “provide” means “provide complete in place” or to “furnish and install” such item. Unless otherwise provided in the Contract Documents, the terms “approved;” “directed;” “satisfactory;” “accepted;” “acceptable;” “proper;” “required;” “necessary” and “equal” shall mean as approved, directed, satisfactory, accepted, acceptable, proper, required, necessary and equal, in the opinion of the District. The term “typical” as used in the Drawings shall require the installation or furnishing of such item(s) of the Work designated as “typical” in all other areas similarly marked as “typical”; Work in such other areas shall conform to that shown as “typical” or as reasonably inferable therefrom.

1.1.43. Unilateral Change Order: A written order prepared and issued by the District, the Construction Manager, and/or the Architect and signed by the District and the Architect, directing a change in the Work. **A Unilateral Change Order is NOT a Construction Change Document (which is defined above as a Change Order that DSA must approve).**

1.1.44. Work: All labor, materials, equipment, components, appliances, supervision, coordination, and services required by, or reasonably inferred from, the Contract Documents, that are necessary for the construction and Completion of the Project.

1.2. Laws Concerning the Contract

Contract is subject to all provisions of the Constitution and laws of California and the United States, governing, controlling, or affecting District, or the property, funds, operations, or powers of District, and such provisions are by this reference made a part hereof. Any provision required by law to be included in this Contract shall be deemed to be inserted.

1.3. No Oral Agreements

No oral agreement or conversation with any officer, agent, or employee of District, either before or after execution of Contract, shall affect or modify any of the terms or obligations contained in the Contract Documents.

1.4. No Assignment

Contractor shall not assign the Contract or any part thereof including, without limitation, any services or money to become due without the prior written consent of the District. Assignment without District's prior written consent shall be null and void. Any assignment of money due or to be come due under the Contract shall be subject to a prior lien for services rendered or material supplied for Work performed in favor of all persons, firms, or corporations rendering services or supplying material to the extent that claims are filed pursuant to the Civil Code, Code of Civil Procedure, Government Code, Labor Code, and/or Public Contract Code, and shall also be subject to deductions for Liquidated Damages or withholding of payments as determined by District in accordance with the Contract. Contractor shall not assign or transfer in any manner to a Subcontractor or supplier the right to prosecute or maintain an action against the District.

1.5. Confidentiality

Contractor shall maintain the confidentiality of all information, documents, programs, procedures and all other items that Contractor encounters while performing the Work. This requirement shall be ongoing and shall survive the expiration or termination of the Contract and specifically includes, without limitation, all student, parent, and employee disciplinary information and health information.

1.6. Notice and Service Thereof

Any notice required by the Contract shall be in writing, dated and signed by the party giving notice or by a duly authorized representative of that party and pursuant to the provisions in the Agreement.

1.7. No Waiver

The failure of District in any one or more instances to insist upon strict performance of any term of the Contract or to exercise any District option shall not be construed as a waiver or relinquishment of the right to assert or rely upon any such term or option on a future occasion. No action or failure to act by the District, Architect, or Construction Manager shall constitute a waiver of any right or duty afforded the District under the Contract, nor shall any action or failure to act constitute an approval of or acquiescence

in any breach hereunder, except as may be specifically agreed in writing.

1.8. Substitutions for Specified Items

1.8.1. Requests for substitutions prior to award of the Contract shall be submitted within the time period indicated in the Instructions to Bidders.

1.8.2. Requests for substitutions after award of the Contract shall be submitted within **THIRTY-FIVE (35)** days of the date of the Notice of Award. This time period may be extended by the District only, in its sole discretion.

1.8.3. Whenever in the Specifications any materials, process, or article is indicated or specified by grade, patent, or proprietary name, or by name of manufacturer, that Specification shall be deemed to be followed by the words "or equal." Contractor may, unless otherwise stated, offer any material, process, or article that shall be substantially equal or better in every respect to that so indicated or specified.

1.8.3.1. If the material, process, or article offered by Contractor is not, in the opinion of the District, substantially equal or better in every respect to that specified, then Contractor shall furnish the material, process, or article specified in the Specifications without any additional compensation or change order.

1.8.3.2. This provision shall not be applicable with respect to any material, product, thing or service for which District made findings and gave notice in accordance with Public Contract Code section 3400(b); therefore, Contractor shall not be entitled to request a substitution with respect to those materials, products or services.

1.8.4. A request for a substitution shall be in writing and shall include:

1.8.4.1. All variations of the proposed substitute from the material specified including, but not limited to, principles of operation, materials, or construction finish, thickness or gauge of materials, dimensions, weight, and tolerances;

1.8.4.2. Available maintenance, repair or replacement services;

1.8.4.3. Increases or decreases in operating, maintenance, repair, replacement, and spare parts costs;

1.8.4.4. Whether or not acceptance of the substitute will require other changes in the Work (or in work performed by the District or others under Contract with the District); and

1.8.4.5. The time impact on any part of the Work resulting directly or indirectly from acceptance of the proposed substitute.

1.8.5. No substitutions shall be made until approved, in writing, by the District. The burden of proof as to equality of any material, process, or article shall rest with Contractor. The Contractor warrants that if substitutes are approved:

1.8.5.1. The proposed substitute is equal or superior in all respects to that specified, and that such proposed substitute is suitable and fit for the intended purpose and will perform adequately the function and achieve the results called for by the general design and the Contract Documents;

1.8.5.2. The Contractor provides the same warranties and guarantees for the substitute that would be provided for that specified;

1.8.5.3. The Contractor shall be fully responsible for the installation of the substitute and any changes in the Work required, either directly or indirectly, because of the acceptance of such substitute, with no increase in Contract Price or Contract Time. Incidental changes or extra component parts required to accommodate the substitute will be made by the Contractor without a change in the Contract Price or Contract Time;

1.8.5.4. The Contractor shall be responsible for any re-design costs occasioned by District's acceptance and/or approval of any substitute; and

1.8.5.5. The Contractor shall, in the event that a substitute is less costly than that specified, credit the District with one hundred percent (100%) of the net difference between the substitute and the originally specified material. In this event, the Contractor agrees to execute a deductive Change Order to reflect that credit.

1.8.6. In the event Contractor furnishes a material, process, or article more expensive than that specified, the difference in the cost of that material, process, or article so furnished shall be borne by Contractor.

1.8.7. In no event shall the District be liable for any increase in Contract Price or Contract Time due to any claimed delay in the evaluation of any proposed substitute or in the acceptance or rejection of any proposed substitute.

1.8.8. If the District approves a substitution after the award of the Contract, the District shall memorialize that approval in a Change Order or other applicable Contract modification process.

1.9. Materials and Work

1.9.1. Except as otherwise stated in the Contract, Contractor shall provide and pay for all materials, labor, tools, equipment, transportation, supervision, temporary constructions of every nature, and all other services, management, and facilities of every nature whatsoever necessary to execute and complete the Contract within the Contract Time.

1.9.2. Unless otherwise specified, all materials shall be new and the best of their respective kinds and grades as noted or specified, and workmanship shall be of good quality.

1.9.3. Materials shall be furnished in sufficient quantities and at such times as to ensure uninterrupted progress of Work and shall be stored properly and protected as required.

1.9.4. For all materials and equipment specified or indicated in the Drawings, the Contractor shall provide all labor, materials, equipment, and services necessary for complete assemblies and complete working systems, functioning as intended. Incidental items not indicated on Drawings, nor mentioned in the Specifications, that can legitimately and reasonably be inferred to belong to the Work described, or be necessary in good practice to provide a complete assembly or system, shall be furnished as though itemized here in every detail. In all instances, material and equipment shall be installed in strict accordance with each manufacturer's most recent published recommendations and specifications.

1.9.5. Contractor shall, after award of Contract by District and after relevant submittals have been approved, place orders for materials and/or equipment as specified so that delivery of same may be made without delays to the Work. Contractor shall, upon demand from District, present documentary evidence showing that orders have been placed.

1.9.6. District reserves the right but has no obligation, for any neglect in complying with the above instructions, to place orders for such materials and/or equipment as it may deem advisable in order that

the Work may be completed at the date specified in the Agreement, and all expenses incidental to the procuring of said materials and/or equipment shall be paid for by Contractor or withheld from payment(s) to Contractor.

1.9.7. Contractor warrants good title to all material, supplies, and equipment installed or incorporated in Work and agrees upon Completion of all Work to deliver the Site to District, together with all improvements and appurtenances constructed or placed thereon by it, and free from any claims, liens, or charges. Contractor further agrees that neither it nor any person, firm, or corporation furnishing any materials or labor for any Work shall have any right to lien any portion of the Premises or any improvement or appurtenance thereon, except that Contractor may install metering devices or other equipment of utility companies or of political subdivision, title to which is commonly retained by utility company or political subdivision. In the event of installation of any such metering device or equipment, Contractor shall advise District as to owner thereof.

1.9.8. Nothing contained in this Article, however, shall defeat or impair the rights of persons furnishing materials or labor under any bond given by Contractor for their protection or any rights under law permitting such protection or any rights under law permitting such persons to look to funds due Contractor in hands of District (e.g., stop payment notices). This provision shall be inserted in all subcontracts and material contracts and notice of its provisions shall be given to all persons furnishing material for work when no formal contract is entered into for such material.

1.9.9. Title to new materials and/or equipment for the Work and attendant liability for its protection and safety shall remain with Contractor until incorporated in the Work of this Contract and accepted by District. No part of any materials and/or equipment shall be removed from its place of storage except for immediate installation in the Work. Contractor shall keep an accurate inventory of all materials and/or equipment in a manner satisfactory to District or its authorized representative and shall, at the District's request, forward it to the District.

1.9.10. Contractor certifies that it shall comply with the recycled product requirements of Public Contract Code section 22150, et seq., including, without limitation, section 22154 which states, "All businesses shall certify in writing to the contracting officer, or his or her representative, the minimum, if not exact, percentage of postconsumer material in the products, materials, goods, or supplies being offered or sold to any local public entity."

2. DISTRICT

2.1. The governing board of the District or its designees will act for the District in all matters pertaining to the Contract.

2.2. The District may, at any time,

2.2.1. Direct the Contractor to communicate with or provide notice to the Construction Manager or the Architect on matters for which the Contract Documents indicate the Contractor will communicate with or provide notice to the District; and/or

2.2.2. Direct the Construction Manager or the Architect to communicate with or direct the Contractor on matters for which the Contract Documents indicate the District will communicate with or direct the Contractor.

2.3. District's Rights if Contractor Fails to Perform. If the District at any time believes that the Contractor is behind schedule, is failing to construct the Project pursuant to the Contract Documents or is otherwise failing to perform any provisions of this Contract, the District, after **FORTY-EIGHT (48)** hours written notice to the Contractor, may take any action necessary or beneficial to the District to complete the Project, takeover the Work of the Contract, terminate or suspend the Contract as indicated herein, or any

combination or portion of those actions. The Contractor and the Surety shall be liable to the District for any cost incurred by the District in those actions and the District has the right to deduct the cost thereof from any payment then or thereafter due the Contractor.

3. ARCHITECT

- 3.1.** Architect shall have the authority to act on behalf of District to the extent expressly provided in the Contract Documents and to the extent determined by District to, among other things, observe the progress and quality of the Work on behalf of the District.
- 3.2.** Architect shall have authority to reject materials, workmanship, and/or the Work whenever rejection may be necessary, in Architect's reasonable opinion, to insure the proper execution of the Contract and if Work is defective or does not conform to the requirements of the Contract Documents. Whenever the Architect considers it necessary or advisable, for implementation of the intent of the Contract Documents, the Architect will have authority to require additional inspections or testing of the Work, whether or not such Work is fabricated, installed or completed. Neither this authority of the Architect nor a decision made in good faith by the Architect to exercise or not to exercise that authority shall give rise to a duty or responsibility to the Contractor, Subcontractors, material suppliers, their agents or employees, or other persons performing portions of the Work.
- 3.3.** Architect shall, with the District and on behalf of the District, determine the amount, quality, acceptability, and fitness of all parts of the Work, and interpret the Specifications, Drawings, and shall, with the District, interpret all other Contract Documents.
- 3.4.** Architect shall have all authority and responsibility established by law, including title 24 of the California Code of Regulations.
- 3.5.** Contractor shall provide District and the Construction Manager with a copy of all written communication between Contractor and Architect at the same time as that communication is made to Architect, including, without limitation, all RFIs, correspondence, submittals, claims, and proposed change orders.

4. CONSTRUCTION MANAGER

- 4.1.** If a Construction Manager is used on this Project, the Construction Manager will provide administration of the Contract on the District's behalf. After execution of the Contract and Notice to Proceed, all correspondence and/or instructions from Contractor and/or District shall be forwarded through the Construction Manager. The Construction Manager will not be responsible for and will not have control or charge of construction means, methods, techniques, sequences, or procedures or for safety precautions in connection with the Work, which shall all remain the Contractor's responsibility.
- 4.2.** Construction Manager, however, will have authority to reject materials and/or workmanship not conforming to the Contract Documents, as determined by the District, the Architect, and/or the Project Inspector. Construction Manager shall also have the authority to require special inspection or testing of any portion of the Work, whether it has been fabricated, installed, or fully completed. Any decision made by Construction Manager, in good faith, shall not give rise to any duty or responsibility of the Construction Manager to the Contractor, any Subcontractor, their agents, employees, or other persons performing any of the Work. Construction Manager shall have free access to all parts of Work at any time.
- 4.3.** If the District does not use a Construction Manager on this Project, all references to Construction Manager or CM shall be read as District.

5. INSPECTOR, INSPECTIONS AND TESTS

5.1. Project Inspector

5.1.1. One or more Project Inspector(s), including special Project Inspector(s), as required, will be assigned to the Work by District, in accordance with requirements of title 24, part 1, of the California Code of Regulations, to enforce the building code and monitor compliance with Plans and Specifications for the Project previously approved by the DSA. Duties of Project Inspector(s) are specifically defined in section 4-342 of said part 1 of title 24.

5.1.2. No Work shall be carried on except with the knowledge and under the inspection of the Project Inspector(s). The Project Inspector(s) shall have free access to all parts of Work at any time. Contractor shall furnish Project Inspector(s) reasonable opportunities for obtaining such information as may be necessary to keep Project Inspector(s) fully informed respecting progress and manner of work and character of materials. Inspection of Work shall not relieve Contractor from the obligation to fulfill the Contract. Project Inspector(s) and the DSA are authorized to stop work whenever the Contractor and/or its Subcontractor(s) are not complying with the Contract Documents. Any work stoppage by the Project Inspector(s) and/or DSA shall be without liability to the District. Contractor shall instruct its Subcontractors and employees accordingly.

5.1.3. If Contractor and/or any Subcontractor requests that the Project Inspector(s) perform any inspection off-site, this shall only be done if it is allowable pursuant to applicable regulations and DSA, if the Project Inspector(s) agree to do so, and at the expense of the Contractor.

5.1.4. Limitations on Project Inspector Authority. The Project Inspector does not have authority to interpret the Contract Documents or to modify the Work depicted in the Contract Documents. No Work inconsistent with the Contract Documents shall be performed solely on the basis of the direction of the Project Inspector, and the Contractor shall be liable to the District for the consequences of all Work performed on such basis.

5.2. Tests and Inspections

5.2.1. Tests and Inspections shall comply with title 24, part 1, California Code of Regulations, group 1, article 5, section 4-335, and with the provisions of the Specifications.

5.2.2. If the Contract Documents, laws, ordinances or any public authority with jurisdiction over the Work requires the Work, or any portion thereof, to be specially tested, inspected or approved, the Contractor shall give the Architect, the Construction Manager and the Project Inspector written notice of the readiness of such Work for observation, testing or inspection at least seventy-two (72) hours prior to the time for the conducting of such test, inspection or observation. If inspection, testing or observation is by authority other than the District, the Contractor shall inform the Project Inspector and the Construction Manager not less than seventy-two (72) hours prior to the date fixed for such inspection, test or observation. The Contractor shall not cover up any portion of the Work subject to tests, inspections or observations prior to the completion and satisfaction of the requirements of such test, inspection or observation. In the event that any portion of the Work subject to tests, inspection or approval shall be covered up by Contractor prior to completion and satisfaction of the requirements of such tests, inspection or approval, Contractor shall be responsible for the uncovering of such portion of the Work as is necessary for performing such tests, inspection or approval without adjustment of the Contract Price or the Contract Time on account thereof.

5.2.3. The District will select an independent testing laboratory to conduct the tests. Selection of the materials required to be tested shall be by the laboratory or the District's representative and not by the Contractor. The Contractor shall notify the District's representative a sufficient time in advance of its readiness for required observation or inspection.

5.2.4. The Contractor shall notify the District's representative a sufficient time in advance of the manufacture of material to be supplied under the Contract Documents, that must by terms of the Contract Documents be tested, in order that the District may arrange for the testing of same at the source

of supply. This notice shall be, at a minimum, seventy-two (72) hours prior to the manufacture of the material that must be tested.

5.2.5. Any material shipped by the Contractor from the source of supply prior to having satisfactorily passed required testing and inspection or prior to the receipt of notice from the representative that testing and inspection will not be required, shall not be incorporated into and/or onto the Project.

5.2.6. The District will select and pay testing laboratory costs for all tests and inspections. Costs of tests of any materials found to be not in compliance with the Contract Documents shall be paid for by the District and reimbursed by the Contractor or deducted from the Contract Price.

5.3. Costs for After Hours and/or Off Site Inspections

5.3.1. If the Contractor performs Work outside the Inspector's regular working hours, over a period of more than eight (8) hours per day by any single person, on weekends/holidays or requests the Inspector to perform inspections off Site, then the costs of any inspections required outside regular working hours, over a period of more than eight (8) hours per day by any single person, on weekends/holidays or off Site, shall be borne by the Contractor and may be invoiced to the Contractor by the District or the District may deduct those expenses from the next Progress Payment.

6. CONTRACTOR

Contractor shall construct the Work for the Contract price including any adjustment(s) to the Contract Price pursuant to provisions herein regarding changes to the Contract Price. Except as otherwise noted, Contractor shall provide and pay for all labor, materials, equipment, permits, fees, licenses, facilities, transportation, taxes, and services necessary for the proper execution and Completion of the Work, except as indicated herein.

6.1. Status of Contractor

6.1.1. Contractor is and shall at all times be deemed to be an independent contractor and shall be wholly responsible for the manner in which it and its Subcontractors perform the services required of it by the Contract Documents. Nothing herein contained shall be construed as creating the relationship of employer and employee, or principal and agent, between the District, or any of the District's employees or agents, and Contractor or any of Contractor's Subcontractors, agents or employees. Contractor assumes exclusively the responsibility for the acts of its employees as they relate to the services to be provided during the course and scope of their employment. Contractor, its Subcontractors, agents, and its employees shall not be entitled to any rights or privileges of District employees. District shall be permitted to monitor the Contractor's activities to determine compliance with the terms of the Contract.

6.1.2. As required by law, Contractor and all Subcontractors shall be properly licensed and regulated by the Contractor's State License Board, located at 9821 Business Park Drive, , Sacramento, California 95827, with a mailing address of Post Office Box 26000, Sacramento, California, and with a website at <http://www.cslb.ca.gov>.

6.2. Contractor's Supervision

6.2.1. During progress of the Work, Contractor shall keep on the Premises, and at all other locations where any Work related to the Contract is being performed, a competent project manager and construction superintendent who are employees of the Contractor, to whom the District does not object and at least one of whom shall be fluent in English, written and verbal.

6.2.2. The project manager and construction superintendent shall both speak fluently the predominant language of the Contractor's employees.

6.2.3. Before commencing the Work, Contractor shall give written notice to District of the name of its project manager and construction superintendent. Neither the Contractor's project manager nor construction superintendent shall be changed except with prior written notice to District, unless the Contractor's project manager and/or construction superintendent proves to be unsatisfactory to Contractor, District, any of the District's employees, agents, the Construction Manager, or the Architect, in which case, Contractor shall notify District in writing. District retains the right to reasonably refuse Contractor's replacement personnel. The Contractor's project manager and construction superintendent shall each represent Contractor, and all directions given to Contractor's project manager and/or construction superintendent shall be as binding as if given to Contractor.

6.2.4. Contractor shall give efficient supervision to Work, using its best skill and attention. Contractor shall carefully study and compare all Contract Documents, Drawings, Specifications, and other instructions and shall at once report to District, Construction Manager, and Architect any error, inconsistency, or omission that Contractor or its employees and Subcontractors may discover, in writing, with a copy to District's Project Inspector(s). The Contractor shall have responsibility for discovery of errors, inconsistencies, or omissions.

6.2.5. The Contractor's project manager shall devote sufficient time to the Project on site, and in the Contractor's home office to pre-plan activities to meet the Construction Schedule and fulfill all Contract obligations. This includes making timely submittals, issuing and disseminating necessary RFI's, promptly processing and distributing bulletins, change orders and payments, keeping required logs current etc. If any of these activities fall behind contract requirements or dates necessary to complete the Project on time, the Contractor must provide a full time project manager on the Project Site dedicated solely to the Project, until the deficiencies are corrected.

6.2.6. The Contractor shall verify all indicated dimensions before ordering materials or equipment, or before performing Work. The Contractor shall take field measurements, verify field conditions, and shall carefully compare such field measurements and conditions and other information known to the Contractor with the Project Documents before commencing work. Errors, inconsistencies or omissions discovered shall be immediately reported to the District. Upon commencement of any item of Work, the Contractor shall be responsible for dimensions related to the Work and shall make any corrections necessary to make Work properly fit at no additional cost to District. This responsibility for verification of dimensions is a non-delegable duty and may not be delegated to subcontractors or agents.

6.2.7. Omissions from the Drawings or Specifications, or the misdescription of details of Work which are manifestly necessary to carry out the intent of the Drawings and Specifications, or which are customarily performed, shall not relieve the Contractor from performing such omitted or misdescribed Work, but they shall be performed as if fully and correctly set forth and described in the Drawings and Specifications.

6.2.8. The Contractor shall be solely responsible for the means, methods, techniques, sequences, and procedures of construction. The Contractor shall be responsible to see that the finished Work complies accurately with the Contract Documents.

6.3. Duty to Provide Fit Workers

6.3.1. Contractor and Subcontractor(s) shall at all times enforce strict discipline and good order among their employees and shall not employ or work any unfit person or anyone not skilled in work assigned to that person. It shall be the responsibility of Contractor to ensure compliance with this requirement. District may require Contractor to permanently remove unfit persons from Project Site.

6.3.2. COVID-19. Contractor shall ensure that all its employees and employees of its subcontractors shall comply with all applicable and existing federal, state, and/or local statutes, orders, rules, regulations, ordinances, and/or directives relating to construction site safety in connection with COVID-19, and/or any

similar virus or derivative strain.

6.3.3. Any person in the employ of Contractor or Subcontractor(s) whom District may deem incompetent or unfit shall be excluded from working on the Project and shall not again be employed on the Project except with the prior written consent of District.

6.3.4. The Contractor shall furnish labor that can work in harmony with all other elements of labor employed or to be employed in the Work.

6.3.5. If Contractor intends to make any change in the name or legal nature of the Contractor's entity, Contractor must first notify the District. The District shall determine if Contractor's intended change is permissible while performing the Contract.

6.3.6. Compliance with Immigration Reform and Control Act of 1986. As required by law, Contractor and all Subcontractors shall employ individuals for the Work in conformity with the Immigration Reform and Control Act of 1986, 8 USC §§1101 et seq.

6.4. Personnel

6.4.1. Contractor, Contractor's employees, Subcontractors, Subcontractors' employees, or any person associated with the Work shall conduct themselves in a manner appropriate for a school site. The District will not permit any (1) verbal or physical contact with neighbors, students, and faculty; (2) profanity, or inappropriate attire or behavior; (3) photographing, videoing, or audio recording of any neighbors, students, and faculty or any posting of any photographs, videos, or audio recordings of any neighbors, students, and faculty on any internet site, social media platform of any kind, regardless of source of any photograph, video, or audio recording. District may require Contractor to permanently remove noncomplying persons from Project Site.

6.4.2. The Contractor shall employ a full-time superintendent and necessary assistants who shall have complete authority to represent and act on behalf on the Contractor on all matters pertaining to the Work. The superintendent shall be competent and have a minimum of five (5) years' experience in construction supervision on projects of similar scale and complexity. The superintendent shall be satisfactory to the District and, if not satisfactory, shall be replaced by the Contractor with one that is acceptable to the District. The superintendent shall not be changed without the written consent of the District unless the superintendent ceases to be employed by the Contractor.

6.4.3. The Contractor shall employ a competent estimator and necessary assistants, or contract for sufficient services of an estimating consultant and to process proposed change orders. The estimator shall have a minimum of five (5) years' experience in estimating. The estimator shall be satisfactory to the District and, if not satisfactory, shall be replaced by the Contractor with one that is acceptable. The Contractor shall submit PCO's requested by the District within fourteen (14) calendar days.

6.4.4. The Contractor shall employ a competent scheduler and necessary assistants, or contract for sufficient services of a scheduling consultant. The scheduler shall have a minimum of five (5) years' experience in scheduling. The scheduler shall be satisfactory to the District and, if not satisfactory, shall be replaced by the Contractor with one that is acceptable.

6.4.5. Contractor shall at all times enforce strict discipline and good order among Contractor's employees, and shall not employ on the Project any unfit person or anyone not skilled in the task assigned.

6.4.6. If Contractor or any Subcontractor on the Project site fails to comply with any provision herein, the District may have the offending person(s) immediately removed from the Site, and the person(s) shall be replaced within three (3) days, at no additional expense to the District. Contractor, on behalf of it and

its Subcontractors, hereby waives any claim that the provisions of this paragraph or the enforcement thereof interferes, or has the potential to interfere, with its right to control the means and methods of its performance and duties under this Contract.

6.5. Prohibition on Harassment

6.5.1. In addition to the non-discrimination requirements in the Contract Documents, the Contractor and all Subcontractors must comply with these provisions prohibiting harassment at the Site. The District is committed to providing a campus and workplace free of sexual harassment and harassment based on factors such as race, color religion, national origin, ancestry, age, medical condition, marital status, disability or veteran status. Harassment includes without limitation, verbal, physical or visual conduct which creates an intimidating, offensive or hostile environment such as racial slurs; ethnic jokes; posting of offensive statements, posters or cartoons or similar conduct. Sexual harassment includes without limitation the solicitation of sexual favors, unwelcome sexual advances, or other verbal, visual or physical conduct of a sexual nature.

6.5.2. Contractor shall take all reasonable steps to prevent harassment from occurring, including without limitation affirmatively raising the subject of harassment among its employees, expressing strong disapproval of any form of harassment, developing appropriate sanctions, informing employees of their right to raise and how to raise the issue of harassment and informing complainants of the outcome of an investigation into a harassment claim.

6.5.3. Contractor shall not permit any person, whether employed by Contractor or a Subcontractor or any other person or entity, performing any Work at or about the Site to engage in any prohibited form of harassment. Any person performing or providing Work on or about the Site engaging in a prohibited form of harassment directed to any student, faculty member or staff of the District or directed to any other person on or about the Site shall be subject to immediate removal and shall be prohibited thereafter from providing or performing any portion of the Work. Upon the District's receipt of any notice or complaint that any person employed directly or indirectly by Contractor on any Subcontractor in performing or providing the Work has engaged in a prohibited form of harassment, the District will promptly undertake an investigation of such notice or complaint. In the event that the District, after such investigation, reasonably determines that a prohibited form of harassment has occurred, the District shall promptly notify the Contractor of the same and direct that the person engaging in such conduct be immediately removed from the Site. Unless the District's determination that a prohibited form of harassment has occurred is grossly negligent or without reasonable cause, District shall have no liability for directing the removal of any person determined to have engaged in a prohibited form of harassment nor shall the Contract Price or the Contract Time be adjusted on account thereof. The indemnity provisions of the Contract Documents apply to any assertion by any person dismissed from performing or providing work at the direction of the District pursuant to this provision; or (ii) the assertion by any person that any person directly or indirectly under the employment or direction of the Contractor has engaged in a prohibited form of harassment directed to or affecting such person. The obligations of the Contractor and the Surety under the preceding sentence are in addition to, and not in lieu of, any other obligation of defense, indemnity and hold harmless whether arising under the Contract Documents, at law or otherwise; these obligations survive completion of the Work or the termination of the Contract.

6.6. Conferences and Meetings.

6.6.1. In addition to the conference and meeting requirements in the Specifications, Contractor's supervisory personnel for the Work and the Contractor's management personnel shall attend all required meetings as required by the Contract Documents or as requested by the District. The Contractor's personnel participating in conferences and meetings relating to the Work shall be authorized to act on behalf of the Contractor and to bind the Contractor. The Contractor is solely responsible for arranging for the attendance by Subcontractors and Material Suppliers at meetings and conferences relating to the Work as necessary, appropriate or as requested by the District.

6.6.2. Preconstruction Conference. The Contractor's representatives (and representatives of Subcontractors as requested by the District) shall attend a preconstruction conference at such time and place as designated by the District. The preconstruction conference will generally address the requirements of the Work and Contract Documents, and to establish construction procedures. Subject matters of the preconstruction conference will include as appropriate: (a) administrative matters, including an overview of the respective responsibilities of the District, Architect, Construction Manager, Contractor, Subcontractors, Project Inspector, and others performing any part of the Work or services relating to the Work; (b) Submittals; (c) Changes; (d) employment practices, including Certified Payroll preparation and submission and prevailing wage rate responsibilities of the Contractor and Subcontractors; (e) Progress Schedule development and maintenance; (f) development of Schedule of Values and payment procedures; (g) implementation of BIM, if applicable; (h) communication procedures, including the handling of Requests for Information; (i) emergency and safety procedures; (j) Site visitor policies; (k) conduct of Contractor/Subcontractor personnel at the Site; and (l) Completion, Punchlist and closeout procedures.

6.6.3. Progress Meetings. Progress meetings will be conducted on regular intervals (weekly unless otherwise expressly indicated elsewhere in the Contract Documents). The Contractor's representatives and representatives of Subcontractors (as requested by the District) shall attend progress meetings. Progress Meetings will be chaired by the District or the Construction Manager and will generally include as agenda items: Site safety, field issues, coordination of Work, construction progress and impacts to timely Completion, if any. The purposes of the progress meetings include: a formal and regular forum for discussion of the status and progress of the Work by all Project participants, a review of progress or resolution of previously raised issues and action items assigned to the Project participants, and reviews of the Progress schedule and submittals. Contractor shall prepare and submit at each progress meeting a three (3) week look-ahead schedule identifying all planned activities for the next three (3) weeks and any deviations from activities in the current Construction Schedule.

6.6.4. Special Meetings. As deemed necessary or appropriate by the District, special meetings will be conducted with the participation of the Contractor, Subcontractors and other Project participants as requested by the District.

6.6.5. Minutes of Meetings. following conclusion of the preconstruction conference, progress meetings and special meetings, the Architect or the Construction Manager will prepare and distribute minutes reflecting the items addressed and actions taken at a meeting or conference. Unless the Contractor notifies the Architect and the Construction Manager in writing of objections or corrections to minutes prepared hereunder within five (5) days of the date of distribution of the minutes, the minutes as distributed shall constitute the official record of the meeting or conference. No objections or corrections of any Subcontractor or Material Supplier shall be submitted directly to the Architect or the Construction Manager; such objections or corrections shall be submitted to the Architect and the Construction Manager through the Contractor. If the Contractor timely interposes objections or notes corrections, the resolution of such matters shall be addressed at the next scheduled progress meeting.

6.7. Purchase of Materials and Equipment

6.7.1. The Contractor is required to order and obtain materials and equipment sufficiently in advance of its Work at no additional cost or advance payment from District to ensure against price escalations or delays. All materials and equipment shall be stored on-Site and secured by Contractor unless otherwise approved in writing by the District.

6.7.2. Off-Site Storage of Materials and Equipment Only Upon District's Written Consent. If Contractor intends to store materials and/or equipment off site after District has paid for those materials and/or equipment, Contractor must first obtain the District's express, written consent. If Contractor receives District's consent to store materials and/or equipment off site ("Stored Materials"), Contractor shall comply with all of the following:

6.7.2.1. Property of Others Insurance. Contractor shall procure and maintain, during the entire time Stored Materials are in off-site storage, insurance coverage acceptable to the District that shall protect Contractor and District from all claims for Stored Materials that are lost, stolen, or damaged. The District shall be named as a loss payee for this insurance coverage. The insurance coverage shall include a “loss payable endorsement” stating that all amounts payable will be paid as a joint-check to the Contractor and District. If approved in advance by District, this required insurance may be obtained by an “Employee Theft Protection Insurance Policy” or an “Employee Theft Protection Bond.”

6.7.2.2. Payment for Stored Materials. District shall only make payment to Contractor for Stored Materials if agreed upon in advance, in writing, by the District and provided that Contractor submits an itemized list of all Stored Materials with Contractor’s Application for Payment. Contractor’s itemized list of all Stored Materials shall be supported by all of the following:

6.7.2.2.1. Itemized breakdown of the Stored Materials for the purpose of requesting partial payment, identifying the serial numbers and exact storage location of each piece of equipment and material; and

6.7.2.2.2. Verified invoices for the Stored Materials; and

6.7.2.2.3. Original copy of Property of Others Insurance, Employee Theft Protection Insurance Policy, or an Employee Theft Protection Bond based on the type of insurance required by the District. These documents shall include certificates and endorsements stating the coverage and that the District is a loss payee or obligee, as appropriate.

6.7.2.2.4. An express, signed document from Contractor indicating that the District may, at any time and at its sole discretion, have unhindered and unqualified access to all Stored Materials and to remove the Stored Materials.

6.8. Documents on Work

6.8.1. Contractor shall at all times keep on the Work Site, or at another location as the District may authorize in writing, one legible copy of all Contract Documents, including Addenda and Change Orders, and current titles 19 and 24 of the California Code of Regulations, the specified edition(s) of the California Building Standards Code (electronic versions are acceptable), all approved Drawings, Plans, Schedules, and Specifications, and all codes and documents referred to in the Specifications, and made part thereof. These documents shall be kept in good order and available to District, Construction Manager, Architect, Architect’s representatives, the Project Inspector(s), and all authorities having jurisdiction. Contractor shall be acquainted with and comply with the provisions of these titles as they relate to this Project. (See particularly the duties of Contractor, title 24, part 1, California Code of Regulations, section 4-343.) Contractor shall also be acquainted with and comply with all California Code of Regulations provisions relating to conditions on this Project, particularly titles 8 and 17. Contractor shall coordinate with Architect and Construction Manager and shall submit its verified report(s) according to the requirements of title 24.

6.8.2. Daily Job Reports.

6.8.2.1. Contractor shall maintain, at a minimum, at least one (1) set of Daily Job Reports on the Project. These must be prepared by the Contractor’s employee(s) who are present on Site, and must include, at a minimum, the following information:

6.8.2.1.1. A brief description of all Work performed on that day.

- 6.8.2.1.2. A summary of all other pertinent events and/or occurrences on that day.
- 6.8.2.1.3. The weather conditions on that day.
- 6.8.2.1.4. A list of all Subcontractor(s) working on that day,
- 6.8.2.1.5. A list of each Contractor employee working on that day and the total hours worked for each employee.
- 6.8.2.1.6. A complete list of all equipment on Site that day, whether in use or not.
- 6.8.2.1.7. A complete list of all materials, supplies, and equipment delivered on that day.
- 6.8.2.1.8. A complete list of all inspections and tests performed on that day.

6.8.2.2. Each day Contractor shall provide a copy of the previous day's Daily Job Report to the District or the District's Construction Manager.

6.9. Preservation of Records

District shall have the right to examine and audit all Daily Job Reports or other Project records of Contractor's project manager(s), project superintendent(s), and/or project foreperson(s), all certified payroll records and/or related documents including, without limitation, payroll, payment, timekeeping and tracking documents; all books, estimates, records, contracts, documents, bid documents, bid cost data, subcontract job cost reports, and other data of the Contractor, any Subcontractor, and/or supplier, including computations and projections related to bidding, negotiating, pricing, or performing the Work or Contract modification, in order to evaluate the accuracy, completeness, and currency of the cost, manpower, coordination, supervision, or pricing data at no additional cost to the District. These documents may be duplicative and/or be in addition to any Bid Documents held in escrow by the District. Contractor shall make available at its office at all reasonable times the materials described in this paragraph for the examination, audit, or reproduction until three (3) years after final payment under this Contract. Notwithstanding the provisions above, Contractor shall provide any records requested by any governmental agency, if available, after the time set forth above.

6.10. Integration of Work

6.10.1. Contractor shall do all cutting, fitting, patching, and preparation of Work as required to make its several parts come together properly, to fit it to receive or be received by work of other contractors, and to coordinate tolerances to various pieces of work, showing upon, or reasonably implied by, the Drawings and Specifications for the completed structure, and shall conform them as District and/or Architect may direct.

6.10.2. All cost caused by defective or ill-timed Work shall be borne by Contractor, inclusive of repair work.

6.10.3. Contractor shall not endanger any work performed by it or anyone else by cutting, excavating, or otherwise altering work and shall not cut or alter work of any other contractor except with written consent of District.

6.11. Obtaining of Permits and Licenses

6.11.1. Contractor shall secure and pay for all permits, licenses, and certificates. Contractor must review the Special Conditions for any changes or exceptions to this provision.

6.12. Work to Comply with Applicable Laws and Regulations

6.12.1. Contractor shall give all notices and comply with all applicable laws, ordinances, rules, and regulations relating to the Work, including the specific laws, ordinances, rules, and regulations as indicated and specified in the Contract Documents and identified below, including but not limited to the appropriate statutes and administrative code sections. If Contractor observes that Drawings and Specifications are at variance therewith, or should Contractor become aware of the development of conditions not covered by Contract Documents that will result in finished Work being at variance therewith, Contractor shall promptly notify District in writing and any changes deemed necessary by District shall be made as provided in Contract for changes in Work.

- 6.12.1.1.** National Electrical Safety Code, U. S. Department of Commerce
- 6.12.1.2.** National Board of Fire Underwriters’ Regulations
- 6.12.1.3.** California Building Standards Code , latest addition, and the California Code of Regulations, Title 24, including amendments
- 6.12.1.4.** Manual of Accident Prevention in Construction, latest edition, published by A.G.C. of America
- 6.12.1.5.** Industrial Accident Commission’s Safety Orders, State of California
- 6.12.1.6.** Regulations of the State Fire Marshall (title 19, California Code of Regulations) and Pertinent Local Fire Safety Codes
- 6.12.1.7.** Americans with Disabilities Act
- 6.12.1.8.** Education Code of the State of California
- 6.12.1.9.** Government Code of the State of California
- 6.12.1.10.** Labor Code of the State of California, division 2, part 7, Public Works and Public Agencies
- 6.12.1.11.** Public Contract Code of the State of California
- 6.12.1.12.** California Art Preservation Act
- 6.12.1.13.** U. S. Copyright Act
- 6.12.1.14.** U. S. Visual Artists Rights Act

6.12.2. Contractor shall comply will all applicable mitigation measures, if any, adopted by any public agency with respect to this Project pursuant to the California Environmental Quality Act (“CEQA”) (Public Resources Code sections 21000 et. seq.) (Also see the Special Conditions.)

6.12.3. If Contractor performs any Work that it knew, or through exercise of reasonable care should have known, to be contrary to any applicable laws, ordinance, rules, or regulations, Contractor shall bear all costs arising therefrom.

6.12.4. Where Specifications or Drawings state that materials, processes, or procedures must be approved by the DSA, State Fire Marshall, or other body or agency, Contractor shall be responsible for satisfying requirements of such bodies or agencies.

6.13. Safety/Protection of Persons and Property

6.13.1. Contractor will be solely and completely responsible for conditions of the Work Site, including safety of all persons and property during performance of the Work. This requirement will apply continuously and not be limited to normal working hours.

6.13.2. COVID-19. Contractor is responsible for complying with all applicable and existing federal, state, and/or local statutes, orders, rules, regulations, ordinances, and/or directives relating to construction site safety in connection with COVID-19, and/or any similar virus or derivative strain. Contractor shall ensure it has supervisor employees onsite that are trained and knowledgeable of all of these requirements to ensure full compliance on Project Site(s).

6.13.3. The wearing of hard hats will be mandatory at all times for all personnel on Site. Contractor shall supply sufficient hard hats to properly equip all employees and visitors.

6.13.4. Any construction review of the Contractor's performance is not intended to include review of the adequacy of the Contractor's safety measures in, on, or near the Work Site.

6.13.5. Implementation and maintenance of safety programs shall be the sole responsibility of the Contractor.

6.13.6. Contractor shall furnish to the District a copy of the Contractor's safety plan within the time frame indicated in the Contract Documents and specifically adapted for the Project.

6.13.7. Contractor shall be responsible for all damages to persons or property that occur as a result of its fault or negligence in connection with the performance of the Contract and shall take all necessary measures and be responsible for the proper care and completion and final acceptance by District. All Work shall be solely at Contractor's risk with the exception of damage to the Work caused by "acts of God" as defined in Public Contract Code section 7105.

6.13.8. Contractor shall take, and require Subcontractors to take, all necessary precautions for safety of workers on the Project and shall comply with all applicable federal, state, local, and other safety laws, standards, orders, rules, regulations, and building codes to prevent accidents or injury to persons on, about, or adjacent to premises where Work is being performed and to provide a safe and healthful place of employment. Contractor shall furnish, erect, and properly maintain at all times, all necessary safety devices, safeguards, construction canopies, signs, nets, barriers, lights, and watchmen for protection of workers and the public and shall post danger signs warning against hazards created by such features in the course of construction.

6.13.9. Hazards Control. Contractor shall store volatile wastes in covered metal containers and remove them from the Site daily. Contractor shall prevent accumulation of wastes that create hazardous conditions. Contractor shall provide adequate ventilation during use of volatile or noxious substances.

6.13.10. Contractor shall designate a responsible member of its organization on the Project, whose duty shall be to post information regarding protection and obligations of workers and other notices required under occupational safety and health laws, to comply with reporting and other occupational safety requirements, and to protect the life, safety, and health of workers. Name and position of person so designated shall be reported to District by Contractor.

6.13.11. Contractor shall correct any violations of safety laws, rules, orders, standards, or regulations. Upon the issuance of a citation or notice of violation by the Division of Occupational Safety and Health, Contractor shall correct such violation promptly.

6.13.12. Storm Water. Contractor shall comply with the District's Storm Water Pollution Prevention Plan

(SWPPP) and, if indicated in the Special Conditions, shall be the District's Qualified SWPPP Practitioner, at no additional cost to the District.

6.13.13. In an emergency affecting safety of life or of work or of adjoining property, Contractor, without special instruction or authorization, shall act, at its discretion, to prevent such threatened loss or injury. Any compensation claimed by Contractor on account of emergency work shall be determined by agreement.

6.13.14. All salvage materials will become the property of the Contractor and shall be removed from the Site unless otherwise called for in the Contract Documents. The District reserves the right to designate certain items of value that shall be turned over to the District.

6.13.15. All connections to public utilities and/or existing on-site services shall be made and maintained in such a manner as to not interfere with the continuing use of same by the District during the entire progress of the Work.

6.13.16. Contractor shall provide such heat, covering, and enclosures as are necessary to protect all Work, materials, equipment, appliances, and tools against damage by weather conditions, such as extreme heat, cold, rain, snow, dry winds, flooding, or dampness.

6.13.17. Contractor shall protect and preserve the Work from all damage or accident, providing temporary roofs, window and door coverings, boxing, or other construction as needed. Contractor shall be responsible for existing structures, walks, roads, trees, landscaping, materials, equipment, furnishings, and/or improvements in working areas; and shall provide adequate protection therefor. If temporary removal is necessary of any of the above items, or damage occurs due to the Work, the Contractor shall replace same at its expense with same kind, quality, and size of Work or item damaged. This shall include any adjoining property of the District and others.

6.13.18. Contractor shall take adequate precautions to protect existing roads, sidewalks, curbs, pavements, utilities, adjoining property, and structures (including, without limitation, protection from settlement or loss of lateral support), and to avoid damage thereto, and repair any damage thereto caused by construction operations.

6.13.19. Contractor shall confine apparatus, the storage of materials, and the operations of workers to limits indicated by law, ordinances, permits, or directions of the District, and shall not interfere with the Work or unreasonably encumber Premises or overload any structure with materials. Contractor shall enforce all instructions of District and Architect regarding signs, advertising, fires, and require that all workers comply with all regulations while on Project Site.

6.13.20. Contractor shall take care to prevent disturbing or covering any survey markers, monuments, or other devices marking property boundaries or corners. If such markers are disturbed, Contractor shall have a civil engineer, registered as a professional engineer in California, replace them at no cost to District.

6.13.21. In the event that the Contractor enters into any agreement with owners of any adjacent property to enter upon the adjacent property for the purpose of performing the Work, Contractor shall fully indemnify, defend, and hold harmless each person, entity, firm, or agency that owns or has any interest in adjacent property. The form and content of the agreement of indemnification shall be approved by the District prior to entering the adjacent property. The Contractor shall also indemnify the District as provided in the indemnification provision herein. These provisions shall be in addition to any other requirements of the owners of the adjacent property.

6.13.22. Infectious Disease Compliance Provisions

6.13.22.1. Compliance with Orders. Contractor and its Subcontractors, agents and employees thereof, are responsible for complying with all applicable and existing federal, State, and/or local statutes, orders, rules, regulations, ordinances, and/or directives in any way relating to construction site safety, the Work, the Project, and Site, in connection with any infectious and communicable disease in any form, whether bacterial or viral, including, without limitation, MSRA, influenza, COVID-19, and/or any similar virus or derivative strain (“**Infectious Disease(s)**”). Contractor shall ensure it has supervisor employees onsite that are trained and knowledgeable of all these requirements to ensure full compliance on Site and the Work. Contractor’s obligations hereunder shall include, without limitation providing personal protective equipment (“PPE”) to its employees and to ensure that its subcontractors provide PPE equipment to its employees to prevent the spread of an Infectious Disease at the Project Site(s).

6.13.22.2. Infectious Disease and Contract Time. Contractor agrees that the Contract Time is based on Contractor’s full compliance with all applicable and existing federal, State, and/or local statutes, orders, rules, regulations, ordinances, and/or directives relating to construction site safety, the Work, the Project, and the Site in connection with an Infectious Disease. Any dispute concerning the Contract Time in connection with any delay associated with an Infectious Disease shall be resolved pursuant to the Claims procedures in these General Conditions.

6.13.22.3. Infectious Disease Release. Contractor acknowledges that it is voluntarily and freely entering into the Contract for this Project and deciding to perform the Work which will require Contractor to enter upon and into the Site and that Contractor use of the Site includes the possible exposure to and illness from an Infectious Disease. Contractor further acknowledges the dangers involved and with full knowledge of these dangers, voluntarily agrees to assume all risks of bodily injury, death, or property damage, whether those risks are known or unknown. Contractor hereby releases District, its agents, representatives, officers, consultants, employees, trustees, and volunteers from any and all liabilities, causes of action, lawsuits, claims, demands, or damages of any kind whatsoever that Contractor, its staff, participants, relatives, children, spouse, partner, household members, family members, employees, guests, invitees, volunteers, agents, consultants, Subcontractors, and any other person tracing exposure or illness to Contractor, now have, or may have in the future, for injury, trauma, illness, loss, unwanted contact, harassment, disability, death or property damages related to being exposed to or contracting an Infectious Disease while using the Site for the performance of the Work. Contractor shall include this paragraph in all subcontracts with Subcontractors.

6.13.22.4. Contractor shall ensure it has supervisor employees onsite that are trained and knowledgeable of all of these requirements to ensure full compliance on Project Site(s).

6.13.22.5. Any cost to comply with these “Infectious Disease Compliance Provisions” shall be at Contractor’s sole expense and expense, but may be included in the Contract Price.

6.13.23. Photos, Videos and Use of Drones.

6.13.23.1. Contractor may photograph or video the progress of the Work and shall provide all of those photos and videos to the District at the District’s request. Contractor may utilize drones or similar aerial equipment to photograph, video or monitor the progress of the Work and for security purposes, but Contractor must comply with all legal requirements of the federal government, the State of California, and the County and City in which the Project is located, applicable to the use of drones or similar aerial equipment. In addition, Contractor shall ensure that no photographs, videos or digital recordings of any kind are taken of District students or staff.

6.13.23.2. If Contractor utilizes drones or any other unmanned aircraft during construction operations, Contractor must either ensure its insurance coverage includes

unmanned aircraft operations or procure and maintain a separate aircraft liability policy to cover unmanned aircraft operations.

6.14. Working Evenings and Weekends

Contractor may be required to work evenings and/or weekends at no additional cost to the District. Contractor shall give the District seventy-two (72) hours' notice prior to performing any evening and/or weekend work. Contractor shall perform all evening and/or weekend work only upon District's written approval and in compliance with all applicable rules, regulations, laws, and local ordinances including, without limitation, all noise and light limitations. Contractor shall reimburse the District for any Inspector and custodial charges necessitated by the Contractor's evening and/or weekend work.

6.15. Noise and Dust Control

6.15.1. In addition to the noise control, dust control and related requirements in the Specifications, Contractor shall control the noise and dust at the Site as indicated here.

6.15.2. Noise Control. The Contractor shall install noise reducing devices on construction equipment. Contractor shall comply with the requirements of the city and county having jurisdiction with regard to noise ordinances governing construction sites and activities. Construction equipment noise at the Site shall be limited as required by applicable law, rule or regulation. If classes are in session at any point during the progress of the Work, and, in the District's reasonable discretion, the noise from any Work disrupts or disturbs the students or faculty or the normal operation of the school at the Site, at the District's request, the Contractor shall schedule the performance of that Work around normal school hours or make other arrangements so that the Work does not cause disruption or disturbance. In no event shall those arrangements result in adjustment of the Contract Price or the Contract Time.

6.15.3. Dust Control. The Contractor shall be fully and solely responsible for maintaining and upkeeping all areas of the Site and adjoining areas, outdoors and indoors, free from flying debris, grinding powder, sawdust, dirt and dust as well as any other product, product waste or work waste, that by becoming airborne may cause respiratory inconveniences to persons, particularly to students and District personnel. Additionally, the Contractor shall take specific care to avoid deposits of airborne dust or airborne elements. Those protection devices, systems or methods shall be in accordance with the regulations set forth by the EPA and OSHA, and other applicable law, rule or regulation. Additionally, the Contractor shall be responsible to regularly and routinely clean up and remove any and all deposits of dust and other elements. Damage and/or any liability derived from the Contractor's failure to comply with these requirements shall be exclusively at the cost of the Contractor, including, without limitation, any and all penalties that may be incurred for violations of applicable law, rule or regulation, and any amounts expended by the District to pay such damages shall be due and payable to the District on demand. Contractor shall replace any damages property or part thereof and professionally clean any and all items that become covered or partially covered to any degree by dust or other airborne elements. If classes are in session at any point during the progress of Work, and, in the District's reasonable discretion, flying debris, grinding powder, sawdust, dirt or dust from any Work disrupts or disturbs the students or faculty or the normal operation of the school, at the District's request, the Contractor shall schedule the performance of all that Work around normal school hours and make other arrangements so that the Work does not cause disruption or disturbance. In no event shall those arrangements result in adjustment of the Contract Price or the Contract Time.

6.15.4. Contractor Failure to Comply. If the Contractor fails to comply with the requirements for dust control, noise control, or any other maintenance or clean up requirement of the Contract Documents, the District, Architect, Project Inspector, or Construction Manager shall notify the Contractor in writing and the Contractor shall take immediate action. Should the Contractor fail to respond with immediate and responsive action and not later than twenty-four (24) hours from that notification, the District shall have the absolute right to proceed as it may deem necessary to remedy such matter. Any and all costs incurred

by the District in connection with those actions shall be the sole responsibility of, and be borne by, the Contractor; the District may deduct those amounts from the Contract Price then or thereafter due the Contractor.

6.16. Cleaning Up

6.16.1. The Contractor shall provide all services, labor, materials, and equipment necessary for protecting the Work, all school occupants, furnishings, equipment, and building structure from damage until its Completion and final acceptance by District. Dust barriers shall be provided to isolate dust and dirt from construction operations. At Completion of the Work and portions thereof, Contractor shall clean to the original state any areas beyond the Work area that become dust laden as a result of the Work. The Contractor must erect the necessary warning signs and barricades to ensure the safety of all school occupants. The Contractor at all times must maintain good housekeeping practices to reduce the risk of fire damage and must make a fire extinguisher, fire blanket, and/or fire watch, as applicable, available at each location where cutting, braising, soldering, and/or welding is being performed or where there is an increased risk of fire.

6.16.2. Contractor at all times shall keep Premises free from debris such as waste, rubbish, and excess materials and equipment caused by the Work. Contractor shall not leave debris under, in, or about the Premises, but shall promptly remove same from the Premises on a daily basis. If Contractor fails to clean up, District may do so and the cost thereof shall be charged to Contractor. If Contract is for work on an existing facility, Contractor shall also perform specific clean-up on or about the Premises upon request by the District as it deems necessary for the continuing education process. Contractor shall comply with all related provisions of the Specifications.

6.16.3. If the Construction Manager, Architect, or District observes the accumulation of trash and debris, the District will give the Contractor a 24-hour written notice to mitigate the condition.

6.16.4. Should the Contractor fail to perform the required clean-up, or should the clean-up be deemed unsatisfactory by the District, the District will then perform the clean-up. All cost associated with the clean-up work (including all travel, payroll burden, and costs for supervision) will be deducted from the Contract Price, or District may withhold those amounts from payment(s) to Contractor.

7. SUBCONTRACTORS

7.1. Contractor shall provide the District with information for all Subcontracts as required in the Contractor's Submittals and Schedules Section.

7.2. No contractual relationship exists between the District and any Subcontractor, supplier, or sub-subcontractor by reason of the Contract.

7.3. Contractor agrees to bind every Subcontractor by terms of the Contract as far as those terms are applicable to Subcontractor's work. If Contractor shall subcontract any part of the Contract, Contractor shall be as fully responsible to District for acts and omissions of any Subcontractor and of persons either directly or indirectly employed by any Subcontractor, as it is for acts and omissions of persons directly employed by Contractor. The divisions or sections of the Specifications are not intended to control the Contractor in dividing the Work among Subcontractors or limit the work performed by any trade.

7.4. District's consent to, or approval of, or failure to object to, any Subcontractor under the Contract shall not in any way relieve Contractor of any obligations under the Contract and no such consent shall be deemed to waive any provisions of the Contract.

7.5. Contractor acknowledges sections 4100 through 4114 of the Public Contract Code of the State of California, as regards subletting and subcontracting, and shall comply with all applicable requirements

therein. In addition, Contractor acknowledges sections 1720 through 1861 of the Labor Code of the State of California, as regards the payment of prevailing wages and related issues, and shall comply with all applicable requirements therein all including, without limitation, section 1775 and the Contractor's and Subcontractors' obligations and liability for violations of prevailing wage law and other applicable laws.

7.6. No Contractor whose Bid is accepted shall, without consent of the awarding authority and in full compliance with section 4100, et seq, of the Public Contract Code, including, without limitation, sections 4107, 4107.5, and 4109 of the Public Contract Code, either:

7.6.1. Substitute any person as a Subcontractor in place of the Subcontractor designated in the original Bid; or

7.6.2. Permit any Subcontract to be assigned or transferred, or allow any portion of the Work to be performed by anyone other than the original Subcontractor listed in the Bid; or

7.6.3. Sublet or subcontract any portion of the Work in excess of one-half of one percent (1/2 of 1%) of the Contractor's total bid as to which his original bid did not designate a Subcontractor.

7.7. The Contractor shall be responsible for the coordination of the trades, Subcontractors, sub-subcontractors, and material or equipment suppliers working on the Project.

7.8. Contractor is solely responsible for settling any differences between the Contractor and its Subcontractor(s) or between Subcontractors.

7.9. Contractor must include in all of its subcontracts the assignment provisions as indicated in the Termination section of these General Conditions.

8. OTHER CONTRACTS/CONTRACTORS

8.1. District reserves the right to let other contracts, and/or to perform work with its own forces, in connection with other portions of the Project or other construction or operations at or about the Site. Contractor shall afford other contractors reasonable opportunity for introduction and storage of their materials and execution of their work and shall properly coordinate and connect Contractor's Work with the work of other contractors.

8.2. In addition to Contractor's obligation to protect its own Work, Contractor shall protect the work of any other contractor that Contractor encounters while working on the Site.

8.3. If any part of Contractor's Work depends for proper execution or results upon work of District or any other contractor, Contractor shall inspect and promptly report to the District in writing before proceeding with its Work any defects in District's or any other contractor's work that render Contractor's Work unsuitable for proper execution and results. Contractor shall be held accountable for damages to District for District's or any other contractor's work that Contractor failed to inspect or should have inspected. Contractor's failure to inspect and report shall constitute Contractor's acceptance of all District's or any other contractor's work as fit and proper for reception of Contractor's Work, except as to defects that may develop in District's or any other contractor's work after execution of Contractor's Work.

8.4. To ensure proper execution of its subsequent work, Contractor shall measure and inspect work already in place and shall at once report to the District in writing any discrepancy between that executed work and the Contract Documents.

8.5. Contractor shall ascertain to its own satisfaction the scope of the Project and nature of District's or any other contracts that have been or may be awarded by District in completion of the Project to the end that

Contractor may perform this Contract in light of the other contracts, if any.

8.6. Nothing herein contained shall be interpreted as granting to Contractor exclusive occupancy of the Site, the Premises, or of the Project. The District shall have complete access to the Project Site for any reasonable purpose at all times. Contractor shall not cause any unnecessary hindrance or delay to the use and/or school operation(s) of the Premises and/or to District or any other contractor working on the Project. If simultaneous execution of any contract or school operation is likely to cause interference with performance of Contractor's Contract, Contractor shall coordinate with those contractor(s), person(s), and/or entity(s) and shall notify the District of the resolution.

9. DRAWINGS AND SPECIFICATIONS

9.1. A complete list of all Drawings that form a part of the Contract is to be found as an index on the Drawings themselves, and/or may be provided to the Contractor and/or in the Table of Contents.

9.2. Materials or Work described in words that so applied have a well-known technical or trade meaning shall be deemed to refer to recognized standards, unless noted otherwise.

9.3. Trade Name or Trade Term. It is not the intention of the Contract to go into detailed descriptions of any materials and/or methods commonly known to the trade under "trade name" or "trade term." The mere mention or notation of "trade name" or "trade term" shall be considered sufficient notice to Contractor that it will be required to complete the work so named, complete, finished, and operable, with all its appurtenances, according to the best practices of the trade.

9.4. The naming of any material and/or equipment shall mean furnishing and installing of same, including all incidental and accessory items thereto and/or labor therefor, as per best practices of the trade(s) involved, unless specifically noted otherwise.

9.5. Contract Documents are complementary, and what is called for by one shall be binding as if called for by all. As such, Drawings and Specifications are intended to be fully cooperative and to agree. However, if Contractor observes that Drawings and Specifications are in conflict, Contractor shall promptly notify District and Architect in writing, and any necessary changes shall be made as provided in the Contract Documents.

9.6. In the case of discrepancy or ambiguity in the Contract Documents, the order of precedence in the Agreement shall prevail. However, in the case of discrepancy or ambiguity solely between and among the Drawings and Specifications, the discrepancy or ambiguity shall be resolved in favor of the interpretation that will provide District with the functionally complete and operable Project described in the Drawings and Specifications. In case of ambiguity, conflict, or lack of information, District will furnish clarifications with reasonable promptness.

9.7. Drawings and Specifications are intended to comply with all laws, ordinances, rules, and regulations of constituted authorities having jurisdiction, and where referred to in the Contract Documents, the laws, ordinances, rules, and regulations shall be considered as a part of the Contract within the limits specified. Contractor shall bear all expense of correcting work done contrary to said laws, ordinances, rules, and regulations.

9.8. Ownership of Drawings

9.8.1. All copies of the Drawings, Designs, Specifications, and copies of other incidental architectural and engineering work, or copies of other Contract Documents furnished by District, are the property of District. They are not to be used by Contractor in other work and, with the exception of signed sets of Contract Documents, are to be returned to District on request at Completion of Work, or may be used by District as it may require without any additional costs to District. Neither the Contractor nor any

Subcontractor, or material or equipment supplier shall own or claim a copyright in the Drawings, Specifications, and other documents prepared by the Architect. District hereby grants the Contractor, Subcontractors, sub-subcontractors, and material or equipment suppliers a limited license to use applicable portions of the Drawings prepared for the Project in the execution of their Work under the Contract Documents.

10. CONTRACTOR'S SUBMITTALS AND SCHEDULES

Contractor's submittals shall comply with the provisions and requirements of the Specifications including, without limitation Submittals. No submittal, unless approved in writing by the District as acceptable and complete, shall be a Contract Document.

10.1. Schedules, Safety Plan and Complete Subcontractor List

10.1.1. Within **TEN (10)** calendar days after the date of the Notice to Proceed (unless otherwise specified in the Notice to Proceed or in the Special Conditions), Contractor shall prepare and submit to the District for review, in a form supported by sufficient data to substantiate its accuracy as the District may require:

10.1.1.1. Schedule of Work. Contractor shall provide a preliminary schedule of construction indicating the starting and completion dates of the various stages of the Work, including any information and following any form as may be specified in the Specifications. Once approved by District, this shall become the Construction Schedule. This schedule shall include and identify all tasks that are on the Project's critical path with a specific determination of the start and completion of each critical path task, all contract milestones and each milestone's completion date(s) as may be required by the District, and the date of Project Completion.

10.1.1.1.1. Proposed Advanced Schedule. The District is not required to accept an early completion ("advanced") schedule; i.e., one that shows early completion dates for the Contract completion or milestones. Contractor shall not be entitled to extra compensation if the District allows the Contractor to proceed performing the Contract on an earlier ("advanced") schedule and Contractor completes the Project, for whatever reason, beyond the date shown in that earlier ("advanced") schedule, but within the Time for Completion indicated in the Contract. A schedule showing the work completed in less than the Time for Completion indicated in the Contract, shall be considered to have Project Float.

10.1.1.1.2. Float or Slack in the Schedule. Float or slack is the amount of time between the early start date and the late start date, or the early finish date and the late finish date, of any of the activities in the schedule. Float or slack is not for the exclusive use of or benefit of either the District or the Contractor, but its use shall be determined solely by the District.

10.1.1.2. Schedule of Submittals. The Contractor shall provide a preliminary schedule of submittals, including Shop Drawings, Product Data, and Samples submittals. Once approved by District, this shall become the Submittal Schedule. All submittals shall be forwarded to the District by the date indicated on the approved Submittal Schedule, unless an earlier date is necessary to maintain the Construction Schedule, in which case those submittals shall be forwarded to the District so as not to delay the Construction Schedule.

10.1.1.3. Schedule of Values. The Contractor shall provide a preliminary schedule of values for all component parts of the Work for which progress payments may be requested. The schedule of values must include quantities and prices of items totaling the Contract Price and must subdivide the Work into component parts in sufficient detail to serve as the basis for progress payments during construction. The preliminary schedule of values should include, at a minimum, the following information and the following structure:

10.1.1.3.1. Divided into at least the following categories:

- 10.1.1.3.1.1.** Overhead and profit;
- 10.1.1.3.1.2.** Supervision;
- 10.1.1.3.1.3.** General conditions;
- 10.1.1.3.1.4.** Layout;
- 10.1.1.3.1.5.** Mobilization;
- 10.1.1.3.1.6.** Submittals;
- 10.1.1.3.1.7.** Bonds and insurance;
- 10.1.1.3.1.8.** Closeout documentation;
- 10.1.1.3.1.9.** Demolition;
- 10.1.1.3.1.10.** Installation;
- 10.1.1.3.1.11.** Rough-in;
- 10.1.1.3.1.12.** Finishes;
- 10.1.1.3.1.13.** Testing;
- 10.1.1.3.1.14.** Punch List and acceptance.

10.1.1.3.2. Divided by each of the following areas:

- 10.1.1.3.2.1.** Site work;
- 10.1.1.3.2.2.** By each building;
- 10.1.1.3.2.3.** By each floor.

10.1.1.3.3. The preliminary schedule of values shall not provide for values any greater than the following percentages of the Contract value:

- 10.1.1.3.3.1.** Mobilization and layout combined to equal not more than 1%;
- 10.1.1.3.3.2.** Submittals, samples and shop drawings combined to equal not more than 3%;
- 10.1.1.3.3.3.** Bonds and insurance combined to equal not more than 2%.

10.1.1.3.4. Closeout Documentation. Closeout Documentation shall have a value in the preliminary schedule of not less than 5%. The value for Closeout Documentation shall be in addition to and shall not be a part of the Contract retention.

10.1.1.3.5. All items on the Schedule of Values must have a specific completion date on the Construction Schedule, or District has approved the Construction Schedule and the Construction Schedule is fully cost-loaded and resource-loaded, unless waived by the District in writing, and detailed as required by the Contract Documents

10.1.1.3.6. Contractor shall certify that the preliminary schedule of values as submitted to the District is accurate and reflects the costs as developed in preparing Contractor's bid. The preliminary schedule of values shall be subject to the District's review and approval of the form and content thereof. In the event that the District objects to any portion of the preliminary schedule of values, the District shall notify the Contractor, in writing, of the District's objection(s) to the preliminary schedule of values. Within five (5) calendar days of the date of the District's written objection(s), Contractor shall submit a revised preliminary schedule of values to the District for review and approval. The foregoing procedure for the preparation, review and approval of the preliminary schedule of values shall continue until the District has approved the entirety of the preliminary schedule of values.

10.1.1.3.7. Once the preliminary schedule of values is approved by the District, this shall become the Schedule of Values. The Schedule of Values shall not be thereafter modified or amended by the Contractor without the prior written consent and approval of the District,

which may be granted or withheld in the sole discretion of the District.

10.1.1.3.8. Notwithstanding any provision of the Contract Documents to the contrary, payment of the Contractor's overhead, supervision, general conditions costs, and profit, as reflected in the Schedule of Values, shall be paid by the District in installments, based on percentage complete, with the disbursement of Progress Payments and the Final Payment.

10.1.1.3.9. The Contractor shall not "front-load" the Schedule of Values with false dollar amounts for activities to be performed in the early stages of the Project. The District may, in its sole discretion, utilize the costs listed in the Schedule of Values as the true cost of items to be deducted from the Contract Price through credit or deductive Change Order. The values for each line item shall include the amount of overhead and profit applicable to each item of work and shall include, at a minimum, a breakdown between rough and finish Work for the basic trades as well as individual dollar figures for large dollar equipment and materials to be installed or furnished for the Project. No individual line item or scope of work in the Schedule of Values shall exceed \$50,000, except with the express, written consent of the District. Exceptions will be given by the District for a single item of Equipment for which the true cost exceeds \$50,000. The Schedule of Values shall be subject to the District's review and approval of the form and content thereof. Upon request, Contractor shall provide District with data and documentation substantiating the accuracy of the proposed line items. In the event that the District shall reasonably object to any portion of the Schedule of Values, within ten (10) days of the District's receipt of the Schedule of Values, the District shall notify the Contractor, in writing of the District's objection(s) to the Schedule of Values together with any request for substantiating data or documentation. Within five (5) days of the date of the District's written objection(s) and request for substantiating data and documentation, Contractor shall submit a revised Schedule of Values to the District for review and approval together with the requested data and documentation. The foregoing procedure for the preparation, review and approval of the Schedule of Values shall continue until the District has approved of the entirety of the Schedule of Values. Once the Schedule of Values is approved by the District, the Schedule of Values shall not be thereafter modified or amended by the Contractor without the prior consent and approval of the District, which may be granted or withheld in the sole reasonable discretion of the District. Notwithstanding any provision of the Contract Documents to the contrary, payment of the Contractor's overhead, supervision and general conditions costs and profit, as such items are reflected in the Schedule of Values, shall be made incrementally as included in the activities included in the Approved Construction Schedule.

10.1.1.4. **Safety Plan.** The Contractor shall provide a preliminary Contractor's Safety Plan specifically adapted for the Project. Contractor's Safety Plan shall comply with the following requirements:

10.1.1.4.1. All applicable requirements of California Division of Industrial Safety ("CalOSHA") and/or of the United States Occupational Safety and Health Administration ("OSHA").

10.1.1.4.2. All provisions regarding Project safety, including all applicable provisions in these General Conditions.

10.1.1.4.3. Contractor's Safety Plan shall be prepared in both English and in the predominant language(s) of the Contractor's and its Subcontractors' employees.

10.1.1.5. **Complete Subcontractor List.** Contractor shall provide a preliminary Subcontractor List stating the name, address, telephone number, facsimile number, email address, California State Contractors License number, Department of Industrial Relations

registration number, classification, and monetary value of all Subcontracts for parties furnishing labor, material, or equipment for the Project.

10.1.2. Contractor must provide all schedules both in hard copy and electronically, in a format (e.g., Microsoft Project, Primavera, or substantially similar product) approved in advance by the District.

10.1.3. The District will review the schedules submitted and the Contractor shall make changes and corrections in the schedules as requested by the District and resubmit the schedules until approved by the District.

10.1.4. The District shall have the right at any time to revise the Schedule of Values if, in the District's sole opinion, the Schedule of Values does not accurately reflect the value of the Work performed.

10.1.5. All submittals and schedules must be approved by the District before Contractor can rely on them as a basis for payment.

10.2. Monthly Progress Schedule(s)

10.2.1. Contractor shall provide Monthly Progress Schedule(s) to the District. A Monthly Progress Schedule shall update the approved Construction Schedule or the last Monthly Progress Schedule, showing all work completed and to be completed. The Monthly Progress Schedule shall be sent to the District and shall be in a format acceptable to the District and contain a written narrative of the progress of work that month and any changes, delays, or events that may affect the work. The process for District approval of the Monthly Progress Schedule shall be the same as the process for approval of the Construction Schedule.

10.2.2. Contractor shall also submit Monthly Progress Schedule(s) with all payment applications.

10.3. Material Safety Data Sheets (MSDS)

Contractor is required to ensure Material Safety Data Sheets are available in a readily accessible place at the Work Site for any material requiring a Material Safety Data Sheet per the Federal "Hazard Communication" standard, or employees right to know law. The Contractor is also required to ensure proper labeling on substances brought onto the Project Site and that any person working with the material or within the general area of the material is informed of the hazards of the substance and follows proper handling and protection procedures. Two additional copies of the Material Safety Data Sheets shall also be submitted directly to the District.

10.4. Logistic Plan

Contractor shall provide a staging and logistics plan identifying laydown areas, loading and unloading areas, crane locations, fence locations, temporary utility connections, trailer locations, and emergency evacuation meeting area. This Logistics Plan must be approved by the District prior to the Contractor mobilizing on the Site.

10.5. Information Included in Submittals.

All Submittals shall be accompanied by a written transmittal and each set of plans shall carry a "wet stamp" or other writing by the Contractor providing an identification of the portion of the Drawings or the Specifications pertaining to the Submittal, with each Submittal numbered consecutively for ease of reference along with the following information: (i) date of submission; (ii) Project name; (iii) name of submitting Subcontractor; and (iv) if applicable, the revision number. The foregoing information is in addition to, and not in lieu of, any other information required for the District's review, evaluation and approval of the Contractor's Submittals. Each Submittal shall be complete with its required number of

copies, no piecemeal documentation is allowed. Any Submittal not bearing the required wet stamp as stated herein, shall be rejected until the appropriate wet stamp information is provided on each submittal.

10.6. Verification of Submittal Information.

By approving and submission of Submittals, the Contractor represents to the District and Architect that the Contractor has determined and verified materials, field measurements, field construction criteria, catalog numbers and similar data related thereto and has checked and coordinated the information contained within such Submittals with the requirements of the Work and of the Contract Documents. Each Submittal shall include the following certification duly executed by the Contractor's superintendent or project manager for the Work: "The Contractor has reviewed and approved the field dimensions and construction criteria of the attached Submittal. The Contractor has verified that the Submittal is complete and includes notations of any portion of the Work depicted in the Submittal which is not in strict conformity with the Contract Documents. The information in the attached Submittal has been reviewed and coordinated by the Contractor with information included in other Submittals."

10.7. Contractor Responsibility for Deviations.

The Contractor shall not be relieved of responsibility for correcting deviations from the requirements of the Contract Documents by the District's and Architect's review of Submittals unless the Contractor has specifically informed the District in writing of such deviation at the time of submission of the Submittal and the District has given written approval to the specific deviation. The Contractor shall not be relieved of responsibility for errors or omissions in Submittals by the District's and Architect's review or comments thereon.

10.8. No Performance of Work Without Architect Review.

The Contractor shall perform no portion of the Work requiring the District's and Architect's review of Submittals until the District and Architect have completed their review and returned the Submittal to the Contractor indicating "No Exception Taken" to that Submittal. The Contractor shall not perform any portion of the Work forming a part of a Submittal or which is affected by a related Submittal until the entirety of the Submittal or other related Submittal has been fully processed. All Work shall be in accordance with the final action taken by the District and the Architect review in review of Submittals and other applicable portions of the Contract Documents.

10.9. District and Architect Review of Submittals.

The purpose of the District's and Architect's review of Submittals and the time for the District's and Architect's return of Submittals to the Contractor shall be as set forth elsewhere in the Contract Documents. If the District and/or Architect return a Submittal as rejected or requiring correction(s) with re-submission, the Contractor, so as not to delay the progress of the Work, shall promptly thereafter resubmit a Submittal conforming to the requirements of the Contract Documents; the resubmitted Submittal shall indicate the portions thereof modified in accordance with the District's and Architect's direction. When professional certification of performance criteria of materials, systems or equipment is required by the Contract Documents, the District shall be entitled to rely upon the accuracy and completeness of the Contractor's calculations and certifications accompanying Submittals. The District's and Architect's review of the Submittals is for the limited purposes described in the Contract Documents. The District and Architect will review each Submittal twice. Should additional Submittals be required as a result of failure of the Contractor to address comments, the Contractor will pay for the Architect's services on a time and material basis for each subsequent review.

10.10. Deferred Approval Items.

In the event that any portion of the Work is designated in the Contract Documents as a "Deferred Approval" item from DSA, Contractor shall be solely and exclusively responsible for the preparation of Submittals for such item(s) in a timely manner so as not to delay or hinder the completion of the Work within the Contract Time. All work, labor, materials, equipment or services necessary to complete the design, engineering and permitting/approval of the Deferred Approval items shall be provided by the Contractor without adjustment of the Contract Price or the Contract Time.

10.11. Contractor Responsibility for Deviations

The Contractor shall not be relieved of responsibility for correcting deviations from the requirements of the Contract Documents by the District's or Architect's review of Submittals unless the Contractor has specifically informed the District and the Architect in writing of such deviation at the time of submission of the Submittal and the District and the Architect have given written approval to the specific deviation. The Contractor shall not be relieved of responsibility for errors or omissions in Submittals by the District's or the Architect's review or comments thereon.

11. SITE ACCESS, CONDITIONS AND REQUIREMENTS

11.1. Site Investigation

Before bidding on the Work, Contractor shall make a careful investigation of the Site and thoroughly familiarize itself with the requirements of the Contract. By the act of submitting a bid for the Work included in the Contract, Contractor shall be deemed to have made a complete study and investigation, and to be familiar with and accepted the existing conditions of the Site.

11.2. Soils Investigation Report

11.2.1. When a soils investigation report obtained from test holes at Site is available, that report shall be available to the Contractor but shall not be a part of the Contract. Any information obtained from that report or any information given on Drawings as to subsurface soil condition or to elevations of existing grades or elevations of underlying rock is approximate only, is not guaranteed, does not form a part of the Contract, and Contractor may not rely thereon. By submitting its bid, Contractor acknowledges that it made visual examination of Site and made whatever tests Contractor deems appropriate to determine underground condition of soil.

11.2.2. If a soils report is identified in the Contract Documents, it is not a Contract Document. Further, no representation is made by District that information provided is adequate for purposes of construction of the Project. District disclaims responsibility for any and all interpretations made by the Contractor of any soil or subsurface condition for information, such as soil-bearing values, rock profiles, presence and scope of boulders and cobbles, soil stability and the presence or level and extent of underground water.

11.2.3. The Contractor shall determine the means, methods, techniques and sequences necessary to achieve required soil contours and characteristics of all completed Work.

11.2.4. If after execution of the Contract, the Contractor encounters conditions at the Site than are materially different from those customarily encountered at or near the Premises, any request by the Contractor for additional funds or additional time, shall be governed by provisions of the Contract Documents for Changes in the Work related to unforeseen conditions.

11.2.5. Contractor agrees that no claim against District will be made by Contractor for damages and hereby waives any rights to damages if, during progress of Work, Contractor encounters subsurface or latent conditions at Site materially differing from those shown on Drawings or indicated in Specifications, or for unknown conditions of an unusual nature that differ materially from those ordinarily encountered in the work of the character provided for in Plans and Specifications, except as indicated in the provisions

of these General Conditions regarding trenches, trenching, and/or existing utility lines.

11.3. Access to Work

District and its representatives shall at all times have access to Work wherever it is in preparation or progress, including storage and fabrication. Contractor shall provide safe and proper facilities for access so that District's representatives may perform their functions.

11.4. Layout and Field Engineering

11.4.1. All field engineering required for layout of this Work and establishing grades for earthwork operations shall be furnished by Contractor at its expense. This Work shall be done by a qualified, California-registered civil engineer approved in writing by District and Architect. Any required Record and/or As-Built Drawings of Site development shall be prepared by the approved civil engineer.

11.4.2. Contractor shall be responsible for having ascertained pertinent local conditions such as location, accessibility, and general character of the Site and for having satisfied itself as to the conditions under which the Work is to be performed. District shall not be liable for any claim for allowances because of Contractor's error or negligence in acquainting itself with the conditions at the Site.

11.4.3. Contractor shall protect and preserve established benchmarks and monuments and shall make no changes in locations without the prior written approval of District. Contractor shall replace any benchmarks or monuments that are lost or destroyed subsequent to proper notification of District and with District's approval.

11.5. Utilities for Construction

Utilities necessary to complete the Work and to completely perform all of the Contractors' obligations shall be obtained by the Contractor without adjustment of the Contract Price. The Contractor shall furnish and install necessary or appropriate temporary distributions of utilities, including utilities furnished by the District. Any such temporary distributions shall be removed by the Contractor upon completion of the Work. The costs of all such utility services, including the installation and removal of temporary distributions thereof, shall be borne by the Contractor and included in the Contract Price. Also refer to other utility requirements as indicated in the Specifications.

11.6. Sanitary Facilities

At all times during Work at the Site, the Contractor shall obtain and maintain temporary sanitary facilities in conformity with applicable law, rule or regulation. The Contractor shall maintain temporary sanitary facilities in a neat and clean manner with sufficient toilet room supplies. Personnel engaged in the Work are not permitted to use toilet facilities at the Site. Also refer to other Sanitary facility requirements as indicated in the Specifications.

11.7. Surveys

Contractor shall provide surveys done by a California-licensed civil engineer surveyor to determine locations of construction, grading, and site work as required to perform the Work.

11.8. Regional Notification Center

Contractor, except in an emergency, shall contact the appropriate regional notification center at least two (2) days prior to commencing any excavation if the excavation will be conducted in an area or in a private easement that is known, or reasonably should be known, to contain subsurface installations other than the underground facilities owned or operated by the District, and obtain an inquiry identification number from that notification center. No excavation shall be commenced and/or carried out by the Contractor

unless an inquiry identification number has been assigned to the Contractor or any Subcontractor and the Contractor has given the District the identification number. Any damages arising from Contractor's failure to make appropriate notification shall be at the sole risk and expense of the Contractor. Any delays caused by failure to make appropriate notification shall be at the sole risk of the Contractor and shall not be considered for an extension of the Contract time.

11.9. Existing Utility Lines

11.9.1. Pursuant to Government Code section 4215, District assumes the responsibility for removal, relocation, and protection of main or trunk utility lines and facilities located on the construction Site at the time of commencement of construction under the Contract with respect to any such utility facilities that are not identified in the Plans and Specifications. Contractor shall not be assessed for liquidated damages for delay in completion of the Project caused by failure of District or the owner of a utility to provide for removal or relocation of such utility facilities.

11.9.2. Locations of existing utilities provided by District shall not be considered exact, but approximate within reasonable margin and shall not relieve Contractor of responsibilities to exercise reasonable care nor costs of repair due to Contractor's failure to do so. District shall compensate Contractor for the costs of locating, repairing damage not due to the failure of Contractor to exercise reasonable care, and removing or relocating such utility facilities not indicated in the Plans and Specifications with reasonable accuracy, and for equipment necessarily idle during such work.

11.9.3. No provision herein shall be construed to preclude assessment against Contractor for any other delays in completion of the Work. Nothing in this Article shall be deemed to require District to indicate the presence of existing service laterals, appurtenances, or other utility lines, within the exception of main or trunk utility lines, whenever the presence of these utilities on the Site can be inferred from the presence of other visible facilities, such as buildings, meter junction boxes, on or adjacent to the Site.

11.9.4. If Contractor, while performing Work, discovers utility facilities not identified by District in Contract Plans and Specifications, Contractor shall immediately, but in no case longer than two (2) Business Days, notify the District and the utility in writing. The cost of repair for damage to above-mentioned visible facilities without prior written notification to the District shall be borne by the Contractor.

11.10. Notification

Contractor understands, acknowledges and agrees that the purpose for prompt notification to the District pursuant to these provisions is to allow the District to investigate the condition(s) so that the District shall have the opportunity to decide how the District desires to proceed as a result of the condition(s). Accordingly, failure of Contractor to promptly notify the District in writing, pursuant to the applicable provisions of these General Conditions, shall constitute Contractor's waiver of any claim for damages or delay incurred as a result of the condition(s).

11.11. Hazardous Materials

Contractor shall comply with all provisions and requirements of the Contract Documents related to hazardous materials including, without limitation, certifications related to hazardous materials in the document entitled Certifications to be Completed by Contractor.

11.12. No Signs

Neither the Contractor nor any other person or entity shall display any signs not required by law or the Contract Documents at the Site, fences trailers, offices, or elsewhere on the Site without specific prior written approval of the District.

12. TRENCHES

12.1. Trenches Greater Than Five Feet

Pursuant to Labor Code section 6705, if the Contract Price exceeds \$25,000 and involves the excavation of any trench or trenches five (5) feet or more in depth, the Contractor shall, in advance of excavation, promptly submit to the District and/or a registered civil or structural engineer employed by the District or Architect, a detailed plan showing the design of shoring for protection from the hazard of caving ground during the excavation of such trench or trenches.

12.2. Excavation Safety

If such plan varies from the Shoring System Standards established by the Construction Safety Orders, the plan shall be prepared by a registered civil or structural engineer, but in no case shall such plan be less effective than that required by the Construction Safety Orders. No excavation of such trench or trenches shall be commenced until said plan has been accepted by the District or by the person to whom authority to accept has been delegated by the District.

12.3. No Tort Liability of District

Pursuant to Labor Code section 6705, nothing in this Article shall impose tort liability upon the District or any of its employees.

12.4. No Excavation without Permits

The Contractor shall not commence any excavation Work until it has secured all necessary permits including the required CAL OSHA excavation/shoring permit. Any permits shall be prominently displayed on the Site prior to the commencement of any excavation.

12.5. Discovery of Hazardous Waste, Unusual Conditions and/or Unforeseen Conditions

12.5.1. Pursuant to Public Contract Code section 7104, if the Work involves digging trenches or other excavations that extend deeper than four (4) feet below the surface, the Contractor shall immediately, but in no case longer than two (2) Business Days, and before the following conditions are disturbed, notify the District, in writing, of any:

12.5.1.1. Material that the Contractor believes may be material that is hazardous waste, as defined in section 25117 of the Health and Safety Code, and requires removal to a Class I, Class II, or Class III disposal site in accordance with provisions of existing law.

12.5.1.2. Subsurface or latent physical conditions at the Site differing from those indicated.

12.5.1.3. Unknown physical conditions at the Site of any unusual nature, different materially from those ordinarily encountered and generally recognized as inherent in work of the character provided for in the Contract.

12.5.2. The District shall promptly investigate the conditions, and if it finds that the conditions do materially so differ, or do involve hazardous waste, and cause a decrease or increase in the Contractor's cost of, or the time required for, performance of any part of the Work, shall issue a Change Order under the procedures described herein.

12.5.3. In the event that a dispute arises between District and the Contractor whether the conditions materially differ, or involve hazardous waste, or cause a decrease or increase in the Contractor's cost of,

or time required for, performance of any part of the Work, the Contractor shall not be excused from any scheduled Completion date provided for by the Contract, but shall proceed with all work to be performed under the Contract. The Contractor shall retain any and all rights provided by the Contract or by law that pertain to the resolution of disputes and protests, which include the requirement that Contractor complies with the notice and PCO provisions of the Contract Documents. Contractor's failure to submit a proposed change order pursuant to the terms of the Contract Documents shall be deemed a waiver of Contractor's right to an adjustment of the Contract Price of Contract Time.

13. INSURANCE AND BONDS

13.1. Insurance

Unless different provisions and/or limits are indicated in the Special Conditions, all insurance required of Contractor and/or its Subcontractor(s) shall be in the amounts indicated herein and include the provisions set forth herein.

13.1.1. Commercial General Liability and Automobile Liability Insurance

13.1.1.1. Contractor shall procure and maintain, during the life of the Contract, Commercial General Liability Insurance and Automobile Liability Insurance that shall protect Contractor, District, State, Construction Manager(s), Project Inspector(s), and Architect(s) from all claims for bodily injury, property damage, personal injury, death, advertising injury, and medical payments arising from operations under the Contract. This coverage shall be provided in a form at least as broad as the Insurance Services Office (ISO) standard form. Contractor shall ensure that Products Liability and Completed Operations coverage, Fire Damage Liability, and any Auto including owned, non-owned, and hired, are included within the above policies and at the required limits, or Contractor shall procure and maintain these coverages separately.

13.1.1.2. Contractor's deductible or self-insured retention for its Commercial General Liability Insurance policy shall not exceed \$25,000 unless approved in writing by District.

13.1.2. Umbrella Liability Insurance

13.1.2.1. Contractor shall procure and maintain, during the life of the Contract, an Excess Liability and/or Umbrella Liability Insurance Policy. Any Umbrella Liability Insurance Policy shall protect Contractor, District, State, Construction Manager(s), Program Manager(s), and Architect(s) in the amounts indicated herein, and shall comply with all requirements for Commercial General Liability and Automobile Liability, Employers' Liability Insurance, and Sexual Molestation and Abuse Liability. This coverage shall be provided in a form at least as broad as the Insurance Services Office (ISO) standard form.

13.1.2.2. There shall be no gap between the per occurrence amount of any underlying policy and the start of the coverage under the Umbrella Liability Insurance Policy.

13.1.2.3. Whether this Excess Liability and/or Umbrella Liability Insurance Policy is written on a "follow form" or "stand alone" form, the coverages shall equal or greater than the Contractor's Commercial General Liability and Automobile Liability, Employers' Liability Insurance, and Sexual Molestation and Abuse Liability with no exclusions that reduce or eliminate coverage items.

13.1.3. Subcontractor(s): Contractor shall require its Subcontractor(s), if any, to procure and maintain Commercial General Liability Insurance, Automobile Liability Insurance, and Umbrella Liability Insurance with minimum limits equal to at least fifty percent (50%) of the amounts required of the Contractor.

13.1.4. Workers' Compensation and Employers' Liability Insurance

13.1.4.1. In accordance with provisions of section 3700 of the California Labor Code, the Contractor and every Subcontractor shall be required to secure the payment of compensation to its employees.

13.1.4.2. Contractor shall procure and maintain, during the life of this Contract, Workers' Compensation Insurance and Employers' Liability Insurance for all of its employees engaged in Work under the Contract, on/or at the Site of the Project. This coverage shall cover, at a minimum, medical and surgical treatment, disability benefits, rehabilitation therapy, and survivors' death benefits. Contractor shall require its Subcontractor(s), if any, to procure and maintain Workers' Compensation Insurance and Employers' Liability Insurance for all employees of Subcontractor(s). Any class of employee or employees not covered by a Subcontractor's insurance shall be covered by Contractor's insurance. If any class of employee or employees engaged in Work under the Contract, on or at the Site of the Project, are not protected under the Workers' Compensation Insurance, Contractor shall provide, or shall cause a Subcontractor to provide, adequate insurance coverage for the protection of any employee(s) not otherwise protected before any of those employee(s) commence work.

13.1.5. Sexual Molestation and Abuse Liability Insurance. Contractor shall procure and maintain, during the life of this Contract, sexual molestation and abuse insurance. Contractor shall require its Subcontractor(s), if any, to procure and maintain sexual molestation and abuse insurance for all employees of Subcontractor(s). Any class of employee or employees not covered by a Subcontractor's insurance shall be covered by Contractor's insurance. If any class of employee or employees engaged in Work under the Contract, on or at the Site of the Project, are not covered under the sexual molestation and abuse insurance, Contractor shall provide, or shall cause a Subcontractor to provide, adequate insurance coverage to cover any employee(s) not otherwise covered before any of those employee(s) commence work.

13.1.6. Builder's Risk Insurance: Builder's Risk "All Risk" Insurance (NO Earthquake or Flood).

13.1.6.1. Contractor (Builder) shall procure and maintain, during the life of this Contract, Builder's Risk (Course of Construction), or similar first party property coverage acceptable to the District, issued on a replacement cost value basis. The cost shall be consistent with the total replacement cost of all insurable Work included within the Contract Documents.

13.1.6.2. Coverage is to insure against all risks of accidental physical loss and shall include without limitation the perils of vandalism and/or malicious mischief (both without any limitation regarding vacancy or occupancy), sprinkler leakage, water damage, mold, civil authority, theft, sonic disturbance, collapse, wind, fire, war, terrorism, lightning, smoke, and rioting. Coverage shall include debris removal, demolition, increased costs due to enforcement of all applicable ordinances and/or laws in the repair and replacement of damaged and undamaged portions of the property, and reasonable costs for the Architect's and engineering services and expenses required as a result of any insured loss upon the Work and Project, including completed Work and Work in progress, to the full insurable value thereof.

13.1.6.3. Coverage shall be maintained until final payment has been made as provided under the Contract or until no person or entity other than the District has an insurable interest in the property to be covered, whichever is later. This insurance shall cover as insureds the District, Contractor, all Subcontractors of every tier on the Project, and all vendors and suppliers. Coverage must also be maintained for any materials stored offsite that will be incorporated into the Project.

13.1.6.4. The deductible for this insurance shall be paid by Contractor.

13.1.6.5. Contractor must review the Special Conditions to confirm the scope of this requirement and if the District has modified this provision.

13.1.7. Proof of Carriage of Insurance and Other Requirements: Endorsements and Certificates

13.1.7.1. Contractor shall not commence Work nor shall it allow any Subcontractor to commence Work under the Contract, until Contractor and its Subcontractor(s) have procured all required insurance and Contractor has delivered in duplicate to the District complete endorsements (or entire insurance policies) and certificates indicating the required coverages have been obtained, and the District has approved these documents.

13.1.7.2. Endorsements, certificates, and insurance policies shall include the following:

13.1.7.2.1. A clause stating:

13.1.7.2.1.1. “This policy shall not be amended, canceled or modified and the coverage amounts shall not be reduced until notice has been mailed to District, Architect, and Construction Manager stating date of amendment, modification, cancellation or reduction. Date of amendment, modification, cancellation or reduction may not be less than thirty (30) days after date of mailing notice.”

13.1.7.2.1.2. In lieu of receiving an endorsement with this clause, the District may, at its sole discretion, accept written notification from Contractor and its insurer to the District of any amendments, modifications, cancellations or reduction in coverage, not less than thirty (30) days prior to such coverage changes occur.

13.1.7.2.2. Language stating in particular those insured, extent of insurance, location and operation to which insurance applies, expiration date, to whom cancellation and reduction notice will be sent, and length of notice period.

13.1.7.3. All endorsements, certificates and insurance policies shall state that District, its trustees, employees and agents, the State of California, Construction Manager(s), Program Manager(s), Inspector(s) and Architect(s) are named additional insureds under all policies except Workers’ Compensation Insurance and Employers’ Liability Insurance.

13.1.7.4. Contractor’s and Subcontractors’ insurance policy(s) shall be primary and non-contributory to any insurance or self-insurance maintained by District, its trustees, employees and/or agents, the State of California, Construction Manager(s), Program Manager(s), Inspector(s), and/or Architect(s).

13.1.7.5. All endorsements shall waive any right to subrogation against any of the named additional insureds.

13.1.7.6. All policies shall be written on an occurrence form.

13.1.7.7. Unless otherwise stated in the Special Conditions, all of Contractor’s insurance shall be placed with insurers **ADMITTED** in California with a current A.M. Best’s rating of no less than **A—** or **A:VII**.

13.1.7.8. The insurance requirements set forth herein shall in no way limit the Contractor’s liability arising out or relating to the performance of the Work or related activities.

13.1.7.9. Failure of Contractor and/or its Subcontractor(s) to comply with the insurance requirements herein shall be deemed a material breach of the Agreement.

13.1.8. Insurance Policy Limits

Unless different limits are indicated in the Special Conditions, the limits of insurance shall not be less than the following amounts:

Commercial General Liability	Includes: Bodily Injury, Property Damage, Personal & Advertising Injury, Product Liability and Completed Operations	\$2,000,000 each occurrence; \$4,000,000 general aggregate
Automobile Liability – Any Auto	Combined Single Limit	\$2,000,000 per occurrence
Excess Liability (Umbrella)		\$6,000,000 per occurrence; \$6,000,000 aggregate
Workers Compensation		Statutory limits pursuant to State law
Employers' Liability		\$2,000,000 each incident, each disease; \$2,000,000 policy limit
Sexual Abuse / Molestation		\$1,000,000 each incident; \$2,000,000 policy limit
Builder's Risk (Course of Construction)		Issued for the value and scope of Work indicated herein.
Property of Others	Combined Single Limit General Aggregate	Issued for the value and scope of Work stored off-site.

13.2. Contract Security – Bonds

13.2.1. Contractor shall furnish two surety bonds issued by a California admitted surety insurer as follows:

13.2.1.1. Performance Bond: A bond in an amount at least equal to one hundred percent (100%) of Contract Price as security for faithful performance of this Contract.

13.2.1.2. Payment Bond: A bond in an amount at least equal to one hundred percent (100%) of the Contract Price as security for payment of persons performing labor and/or furnishing materials in connection with the Contract.

13.2.2. Cost of bonds shall be included in the Bid and Contract Price.

13.2.3. All bonds related to the Project shall be in the forms set forth in the Contract Documents and shall comply with all requirements of the Contract Documents, including, without limitation, the bond forms.

14. WARRANTY/GUARANTEE/INDEMNITY

14.1. Warranty/Guarantee

14.1.1. Contractor shall obtain and preserve for the benefit of the District, manufacturer's warranties on materials, fixtures, and equipment incorporated into the Work. All manufacturer, material, and fixture warranties shall commence at Project Completion. Contractor shall ensure that all warranties are maintained for the benefit of the District, regardless of the who the manufacturer is, who the installing Subcontractor was, if any, etc. While the District will fully expect the Contractor to manage all warranty

work through all applicable warranty periods, the District must have that same ability if the Contractor fails to perform its warranty obligations as required.

14.1.2. In addition to guarantees required elsewhere, Contractor shall, and hereby does guarantee and warrant all Work against all defects for a period of **ONE (1)** year after the later of the following dates:

14.1.2.1. The date of completion as defined in Public Contract Code section 7107, subdivision (c),

14.1.2.2. The commissioning date for the Project, if any.

14.1.3. At the District's sole option, Contractor shall repair or replace any and all of that Work, together with any other Work that may be displaced in so doing, that may prove defective in workmanship and/or materials within a **ONE (1)** year period from date of Completion as defined above without expense whatsoever to District. In the event of failure of Contractor and/or Surety to commence and pursue with diligence said replacements or repairs within **TEN (10)** days after being notified in writing, Contractor and Surety hereby acknowledge and agree that District is authorized to proceed to have defects repaired and made good at expense of Contractor and/or Surety who hereby agree to pay costs and charges therefore immediately on demand.

14.1.4. If, in the opinion of District, defective work creates a dangerous condition or requires immediate correction or attention to prevent further loss to District or to prevent interruption of operations of District, District will attempt to give the notice required above. If Contractor or Surety cannot be contacted or neither complies with District's request for correction within a reasonable time as determined by District, District may, notwithstanding the above provision, proceed to make all corrections and/or provide attentions the District believes are necessary. The costs of correction or attention shall be charged against Contractor and Surety of the guarantees provided in this Article or elsewhere in the Contract Documents.

14.1.5. The above provisions do not in any way limit the guarantees on any items for which a longer guarantee is specified or on any items for which a manufacturer gives a guarantee for a longer period. Contractor shall furnish to District all appropriate guarantee or warranty certificates as indicated in the Specifications or upon request by District.

14.1.6. Nothing herein shall limit any other rights or remedies available to District.

14.2. Indemnity

14.2.1. To the furthest extent permitted by California law, Contractor shall indemnify, defend with legal counsel reasonably acceptable to the District, keep and hold harmless the District and its consultants, the Architect and its consultants, the Construction Manager and its consultants, separate contractors, and their respective board members, officers, representatives, contractors, agents, and employees, in both individual and official capacities ("Indemnitees"), against all suits, claims, damages, losses, and expenses, including but not limited to attorney's fees, caused by, arising out of, resulting from, or incidental to, the performance of the Work by Contractor, its Subcontractors, vendors, or suppliers, including, without limitation, any such suit, claim, damage, loss, or expense attributable to, without limitation, bodily injury, sickness, disease, death, alleged patent violation or copyright infringement, or to injury to or destruction of tangible property (including damage to the Work itself) including the loss of use resulting therefrom, except to the extent caused by the sole negligence, active negligence, or willful misconduct of the Indemnitees, and/or to any extent that would render these provisions void or unenforceable. This agreement and obligation of Contractor shall not be construed to negate, abridge, or otherwise reduce any right or obligation of indemnity that would otherwise exist as to any party or person described herein. This indemnification, defense, and hold harmless obligation includes, without limitation:

14.2.1.1. Any failure or alleged failure by Contractor to comply with any provision of law, any failure or alleged failure to timely and properly fulfill all of its obligations under the Contract Documents in strict accordance with their terms, and without limitation, any stop payment notice actions or liens, including liens by the California Department of Labor Standards Enforcement.

14.2.1.2. Any claim arising (including bid protests) from any errors or mistakes in Contractor's bid documents provided to Subcontractors.

14.2.2. Contractor shall give prompt notice to the District in the event of any injury (including death), loss, or damage included herein. Without limitation of the provisions herein, if Contractor's agreement to indemnify, defend, and hold harmless the Indemnitees as provided herein against liability for damage arising out of bodily injury to persons or damage to property caused by or resulting from the negligence of any of the Indemnitees shall to any extent be or be determined to be void or unenforceable, it is the intention of the parties that these circumstances shall not otherwise affect the validity or enforceability of Contractor's agreement to indemnify, defend, and hold harmless the rest of the Indemnitees, as provided herein, and in the case of any such suits, claims, damages, losses, or expenses caused in part by the default, negligence, or act or omission of Contractor, any Subcontractor, anyone directly or indirectly employed by any of them or anyone for whose acts any of them may be liable, and in part by any of the Indemnitees, Contractor shall be and remain fully liable on its agreements and obligations herein to the full extent permitted by law.

14.2.3. In any and all claims against any of the Indemnitees by any employee of Contractor, any Subcontractor, anyone directly or indirectly employed by any of them or anyone for whose acts any of them may be liable, Contractor's indemnification obligation herein shall not be limited in any way by any limitation on the amount or type of damages, compensation, or benefits payable by or for Contractor or any Subcontractor under workers' compensation acts, disability benefit acts, or other employee benefit acts.

14.2.4. The defense and indemnification obligations hereunder shall survive the Completion of Work, including the warranty/guarantee period, and/or the termination of the Agreement.

15. TIME

15.1. Notice to Proceed

District may issue a Notice to Proceed as indicated in the Instructions to Bidders or will otherwise instruct the Contractor to begin performing the Work of the Project.

15.2. Hours of Work

Work shall be performed during regular working hours as permitted by the appropriate governmental agency except that in the event of an emergency, or when required to complete the Work in accordance with job progress, Work may be performed outside of regular working hours with the advance written consent of the District and approval of any required governmental agencies. Contractor and Subcontractors shall continuously furnish sufficient forces to ensure the performance of the Work in accordance with the Construction Schedule. In no event will the District be responsible for the costs of Work performed outside of regular working hours, including, without limitation, overtime or weekend Work, unless expressly agreed to by the District in writing and approved in a Change Order.

15.3. Progress and Completion

15.3.1. Time of the Essence

Time limits stated in the Contract Documents are of the essence to the Contract. By executing the Agreement, Contractor confirms that the Contract Time is a reasonable period for performing the Work.

15.3.2. No Commencement Without Insurance

15.3.2.1. Contractor shall not commence operations on the Project or elsewhere prior to the effective date of insurance and bonds. The date of commencement of the Work shall not be changed by the effective date of such insurance. If Contractor commences Work without insurance and bonds, all Work is performed at Contractor's peril and shall not be compensable until and unless Contractor secures bonds and insurance pursuant to the terms of the Contract Documents and subject to District's claim for damages.

15.4. Schedule

Contractor shall provide to District, Construction Manager, and Architect a schedule in conformance with the Contract Documents and as required in the Notice to Proceed and the Contractor's Submittals and Schedules section of these General Conditions.

15.5. Expeditious Completion

The Contractor shall proceed expeditiously with adequate forces and shall achieve Completion within the Contract Time.

16. EXTENSIONS OF TIME – LIQUIDATED DAMAGES

16.1. Contractor's Notice of Delay

16.1.1. In addition to the requirements indicated in this subsection, Contractor shall submit any request for an adjustment of the Contract Price or the Contract Time through the Change Order provisions in these General Conditions.

16.1.2. Contractor shall, within **FIVE (5)** calendar days of any delay impacting the critical path in completing the Work, notify District in writing of the causes of the delay including documentation and facts explaining the delay.

16.1.3. Any request by Contractor for an adjustment of the Contract Price or the Contract Time for a delay shall be submitted in accordance with the provisions in the Contract Documents governing changes in Work. When requesting time, requests must be submitted with full justification and documentation. Such justification must be based on the official Construction Schedule as updated at the time of occurrence of the delay or execution of Work related to any changes to the Scope of Work.

16.1.4. Any claim for delay must include the following information as support, without limitation:

16.1.4.1. Duration. The duration of the activity relating to the changes in the Work and the resources (manpower, equipment, material, etc.) required to perform the activities within the stated duration.

16.1.4.2. Schedule Analysis. A detailed schedule analysis articulating the cause of any delay and explaining the delay's impact to critical path and each activity of the Project. This analysis may be in the form of a time impact analysis. The time impact analysis shall provide all documentation and justification necessary to substantiate the requested extension. All supporting documentation shall be based on the then current Monthly Progress Schedule.

16.1.4.3. Logical Ties / Fragnets. Specific logical ties to the Contract Schedule for the proposed changes and/or delay showing the activity/activities in the Construction Schedule that are affected by the change and/or delay. (A portion of any delay of seven (7) days or more must be provided.) Include a “fragnet” analysis for the portion of the schedule and the activities the Contractor contends are impacted by the delay.

16.1.4.4. Updated Construction Schedule. A recovery or updated Construction Schedule must be submitted.

16.1.5. District shall review the facts and extent of any noticed delay and may grant Contract Time extension(s) of time for completing Work when, in the District’s judgment, the findings of fact justify an extension.

16.1.6. Extension(s) of time shall apply only to that portion of Work affected by delay, and shall not apply to other portions of Work not so affected.

16.1.7. An extension of time may only be granted if Contractor has timely submitted the updated Construction Schedule as required herein.

16.1.8. Following submission of a notice of delay, the District may determine whether the delay is to be considered:

16.1.8.1. Excusable and Compensable, Excusable and Non-Compensable, or Unexcused;

16.1.8.2. How long the delay continues; and

16.1.8.3. To what extent the prosecution and Completion of the Work might be delayed thereby.

16.1.9. Contractor’s failure to request adjustment(s) of the Contract Time in strict conformity with applicable provisions of the Contract Documents shall be deemed Contractor’s waiver of its right to assert a claim for a delay.

16.1.10. Limitations Upon Adjustment of Contract Time on Account of Delays. Any adjustment of the Contract Time on account of an Excusable Delay or a Compensable Delay shall be limited as set forth herein. No adjustment of the Contract Time shall be made on account of any Excusable Delays or Compensable Delays unless those delay(s) actually and directly impact Work or Work activities on the critical path of the then current and updated approved Construction Schedule as of the date on which a delay first occurs. The District shall not be deemed in breach of, or otherwise in default of any obligation hereunder, if the District shall deny a request by the Contractor for an adjustment of the Contract Time for any delay that does not actually and directly impact Work on the then current and updated approved Construction Schedule. In submitting a request for an adjustment of Contract Time, and as a condition precedent to the District’s review of that request, Contractor shall insert into the then current and updated approved Construction Schedule a “fragnet” analysis representing the event that Contractor claims to result in delay to the critical path as depicted in the updated approved Construction Schedule. If an Excusable Delay and a Compensable Delay occur concurrently, the maximum extension of the Contract Time shall be the number of days from the commencement of the first delay to the cessation of the delay that ends last. If an Unexcused Delay occurs concurrently with either an Excusable Delay or a Compensable Delay, the maximum extension of the Contract Time shall be the number of days, if any, which the Excusable Delay or the Compensable Delay exceeds the period of time of the Unexcused Delay.

16.2. Excusable and Compensable Delay(s)

16.2.1. Contractor is not entitled to additional compensation for any delay, even a delay caused by

Adverse Weather or an Excusable Delay, unless all of the following conditions are met (“**Excusable and Compensable Delay**”):

- 16.2.1.1. The District is responsible for the delay;
- 16.2.1.2. The delay is unreasonable under the circumstances involved and impacts the critical path of the Work and extends the most current Contract Completion date;
- 16.2.1.3. The delay was not within the contemplation of District and Contractor;
- 16.2.1.4. Contractor complies with the Change Order procedures, and if necessary, the Claims procedures of the Contract Documents;
- 16.2.1.5. The delay could not have been avoided or mitigated by the Contractor's care, prudence, foresight, and diligence;
- 16.2.1.6. The delay extends the most current Contract Completion date; and
- 16.2.1.7. The delay is not concurrent with a Contractor-caused delay or other type of Excusable Delay.

16.2.2. In accordance with California Public Contract Code section 7102, if the Contractor’s progress is delayed by the events described in the preceding subsection, Contractor shall not be precluded from the recovery of damages directly and proximately resulting therefrom. In that event, Contractor’s damages, if any, shall be limited to direct, actual and unavoidable additional costs of labor, materials or construction equipment directly resulting from that delay, and shall exclude special, indirect or consequential damages. In no event shall Contractor seek costs or damages for delays, interruptions, hindrances or disruptions to the Work for on-Site or off-Site costs or damages based upon formulas, e.g. Eichleay or other formula. Except as expressly provided for herein, Contractor shall not have any other claim, demand or right to adjustment of the Contract Price arising out of delay, interruption, hindrance or disruption to the progress of the Work. Adjustments to the Contract Price and the Contract Time, if any, on account of Changes to the Work or Suspension of the Work shall be governed by the applicable provisions of the Contract Documents, including without limitation, the “Changes in the Work” section and the percentages in the “Format for Proposed Change” section of these General Conditions.

16.3. Excusable and Non-Compensable Delay(s)

16.3.1. An "Excusable Delay" shall mean an interruption of the Work beyond the reasonable control of the Contractor and that:

- 16.3.1.1. Could have not been avoided by the Contractor exercising care, prudence, foresight, and diligence, and
- 16.3.1.2. Actually extended the most current Project Completion date.

16.3.2. The Contractor may be entitled to an extension of the Project Completion date if there is an Excusable Delay, but the Contractor shall not be entitled to additional compensation for an Excusable Delay.

16.3.3. Force Majeure.

- 16.3.3.1. Excusable Delays are limited to interruptions that satisfy the above requirements and that are acts of God; acts of a public enemy; fires; floods; windstorms; tornadoes; earthquakes; wars; riots; insurrections; epidemics; pandemics; quarantine

restrictions; strikes; lockouts; fuel shortages; freight embargoes; and Adverse Weather that satisfies the requirements herein (“**Force Majeure Events**”).

16.3.3.2. If an Infectious Disease impacts the progress of the Work and Contractor demonstrates that the event satisfies the conditions of the Contract Documents for an adjustment to the Contract Time, it will be considered a Force Majeure Event.

16.3.3.3. In addition to any other requirement of the Contract Documents, Contractor shall not be entitled to any adjustment to the Contract Time unless Contractor submits a PCO and the District has issued a Change Order pursuant to the “Changes in the Work” provisions herein. If the Parties cannot in good faith and reasonably agree to an increase in the Contract Time, the Parties agree that dispute will be resolved pursuant to the Claims Resolution Process herein.

16.3.4. Contractor is aware that governmental agencies and utilities, including, without limitation, the Division of the State Architect, the Department of General Services, gas companies, electrical utility companies, water districts, and other agencies may have to approve Contractor-prepared drawings or approve a proposed installation. Contractor shall include in its bid, time for possible review of its drawings and for reasonable delays and damages that may be caused by such agencies. Contractor is not entitled to make a claim for damages or delays or an Excusable Delay arising from the review of Contractor’s drawings or other approvals from the Division of the State Architect, the Department of General Services, gas companies, electrical utility companies, water districts, and other agencies.

16.3.5. Neither the financial resources of the Contractor or any person or entity directly or indirectly engaged by the Contractor in performance of any portion of the Work shall be deemed conditions beyond the control of the Contractor. If an event of Excusable Delay occurs, the Contract Time shall be subject to adjustment hereunder only if the Contractor establishes: (i) full compliance with all applicable provisions of the Contract Documents relative to the method, manner and time for Contractor’s notice and request for adjustment of the Contract Time; (ii) that the event(s) forming the basis for Contractor’s request to adjust the Contract Time are outside the reasonable control and without any fault or neglect of the Contractor or any person or entity directly or indirectly engaged by Contractor in performance of any portion of the Work; and (iii) that the event(s) forming the basis for Contractor’s request to adjust the Contract Time directly and adversely impacted the critical path of the Work as indicated in the approved Construction Schedule or the most recent updated approved Construction Schedule relative to the date(s) of the claimed event(s) of Excusable Delay.

16.3.6. Computation of Time / Adverse Weather

16.3.6.1. The Contractor will only be allowed a time extension for Adverse Weather conditions if requested by Contractor within five (5) calendar days of the Adverse Weather event, and only if all of the following conditions are met – thereby making the resulting delay an Excusable Delay.

16.3.6.1.1. The weather conditions constitute Adverse Weather, as defined herein and further specified in the Special Conditions;

16.3.6.1.2. Contractor can verify that the Adverse Weather caused delays in excess of five (5) hours of the indicated labor required to complete the scheduled tasks of Work on the day affected by the Adverse Weather;

16.3.6.1.3. The Contractor’s crew is dismissed as a result of the Adverse Weather; and

16.3.6.1.4. The number of days of delay exceed those indicated in the Special Conditions.

16.3.6.2. A day-for-day extension will only be allowed for those days in excess of those indicated in the Special Conditions and only if the tasks of Work on the day affected by the Adverse Weather were tasks required to be performed on that day to maintain the critical path of the Construction Schedule.

16.3.6.3. The Contractor shall work seven (7) days per week, if necessary, irrespective of inclement weather, to maintain access and the Construction Schedule, and to protect the Work under construction from the effects of Adverse Weather, all at no further cost to the District.

16.3.6.4. The Contract Time has been determined with consideration given to the average climate weather conditions prevailing in the County in which the Project is located.

16.4. Unexcused Delay(s) – Liquidated Damages

16.4.1. Unexcused delays refer to any delay to the progress of the Work caused by events or factors other than those specifically identified in the “Excusable and Compensable Delay(s)” or the “Excusable and Non-Compensable Delay(s)” sections above (“**Unexcused Delays**”). Neither the Contract Price nor the Contract Time shall be adjusted on account of Unexcused Delays.

16.4.2. Contractor and District hereby agree that the exact amount of damages for failure to complete the Work within the time specified is extremely difficult or impossible to determine. If the Work is not completed within the time specified in the Contract Documents, it is understood that the District will suffer damage. It being impractical and unfeasible to determine the amount of actual damage, it is agreed the Contractor shall forfeit and pay to District as fixed and liquidated damages, and not as a penalty, the amount set forth in the Agreement for each calendar day of delay in Completion. Contractor and its Surety shall be liable for the amount thereof pursuant to Government Code section 53069.85.

16.4.3. Contractor shall not forfeit or pay liquidated damages for an Excusable Delay or an Excusable and Compensable Delay.

17. CHANGES IN THE WORK

17.1. No Changes Without Authorization

17.1.1. There shall be no change whatsoever in the Drawings, Specifications, or in the Work without an executed Change Order, a written Unilateral Change Order, or a written Force Account Directive authorized by the District as herein provided. District shall not be liable for the cost of any extra work, any changes to the Contract Time, or any substitutions, changes, additions, omissions, or deviations from the Drawings and Specifications unless the District's governing board has authorized the same and the cost thereof has been approved in writing by an executed Change Order, a written Unilateral Change Order, or a written Force Account Directive.

17.1.2. Verbal Order of Change in the Work. Any verbal order, direction, instruction, interpretation, or determination from the District, the Project Inspector or the Architect which in the opinion of the Contractor causes any change to the scope of the Work, or otherwise requires an adjustment to the Contract Price or the Contract Time, shall be treated as a Change only if the Contractor gives the Architect written notice within three (3) Business Days of the order, directions, instructions, interpretation or determination and prior to acting in accordance therewith. Time is of the essence in Contractor's written notice pursuant to the preceding sentence so that the District can promptly investigate and consider alternative measures to address the order, direction, instruction, interpretation or determination giving rise to Contractor's notice. Accordingly, Contractor acknowledges that its failure, for any reason, to give written notice within three (3) Business Days of any verbal order, direction, instruction, interpretation or determination shall be deemed Contractor's waiver of any right to assert or claim any entitlement to an adjustment of the Contract Time or the Contract Price on account of that verbal order, direction,

instruction, interpretation or determination. The written notice shall state the date, circumstances, extent of adjustment to the Contract Price or the Contract Time, if any, requested, and the source of the verbal order, directions, instructions, interpretation or determination that the Contractor regards as a Change. Unless the Contractor acts in strict accordance with this procedure, any verbal order, direction, instruction, interpretation or determination shall not be treated as a Change and the Contractor hereby waives any claim for any adjustment to the Contract Price or the Contract Time on account thereof.

17.1.3. The Surety, in executing and providing the Performance Bond and the Payment Bond, shall be deemed to have expressly agreed to any change to the Contract and to any extension of time made by reason thereof.

17.1.4. No extension of time for performance of the Work shall be allowed hereunder unless claim for such extension is made at the time changes in the Work are ordered, and such time duly adjusted in writing in the Change Order, Unilateral Change Order, or Force Account Directive. The provisions of the Contract Documents shall apply to all such changes, additions, and omissions with the same effect as if originally embodied in the Drawings and Specifications.

17.1.5. Contractor shall perform immediately all work that has been authorized by a fully executed Change Order, Unilateral Change Order, or Force Account Directive. Contractor shall be fully responsible for any and all delays and/or expenses caused by Contractor's failure to expeditiously perform this Work and Contractor's failure or refusal to so proceed with that Work may be deemed to be Contractor's default of a material obligation of the Contractor under the Contract Documents.

17.1.6. Should any Change Order result in an increase in the Contract Price, the cost of that Change Order shall be agreed to, in writing, in advance by Contractor and District and be subject to the monetary limitations set forth in Public Contract Code section 20118.4. In the event that Contractor proceeds with any change in Work without a Change Order executed by the District, Unilateral Change Order, or Force Account Directive, Contractor waives any claim of additional compensation or time for that additional work.

17.1.7. Contractor understands, acknowledges, and agrees that the reason for District authorization is so that District may have an opportunity to analyze the Work and decide whether the District shall proceed with the Change Order or alter the Project so that a change in Work becomes unnecessary.

17.1.8. In an emergency affecting safety of life or of work or of adjoining property, Contractor, without special instruction or authorization, shall act, at its discretion, to prevent all threatened loss or injury. Any compensation or time claimed by Contractor on account of emergency work shall be determined as indicated herein as a PCO.

17.1.9. No payments will be made, nor will District accept proposed change orders until the Contractor has complied with all the requirements of the Escrow of Bid Documentation document (if applicable).

17.2. Architect Authority

The Architect will have authority to order minor changes in the Work not involving any adjustment in the Contract Price, or an extension of the Contract Time, or a change that is inconsistent with the intent of the Contract Documents. These changes shall be effected by written Change Order, Unilateral Change Order, or by Architect's response(s) to RFI(s).

17.3. Change Orders

17.3.1. A Change Order is a written instrument prepared and issued by the District and/or the Architect and signed by the District (as authorized by the District's governing board), the Contractor, the Architect, and approved by the Project Inspector (if necessary) and DSA (if necessary), stating their agreement

regarding all of the following:

- 17.3.1.1. A description of a change in the Work;
- 17.3.1.2. The amount of the adjustment in the Contract Price, if any; and
- 17.3.1.3. The extent of the adjustment in the Contract Time, if any.

17.3.2. If a Change Order is required to be approved by DSA, the District may call it a Construction Change Document.

17.3.3. If the District approves a Change, the District or the Architect shall provide a written Change Order to the Contractor describing the Change and setting forth the adjustment to the Contract Time and the Contract Price, if any, on account of that Change. All Change Orders shall be full payment and final settlement of all rights for direct, indirect and consequential costs, including without limitation, costs of delays or impacts related to, or arising out of, items covered and affected by the Change Order, as well as any adjustments to the Contract Time. Any demand or request for an adjustment to the Contract Time or the Contract Price relating to any Change incorporated into a Change Order not presented by the Contractor for inclusion in the Change Order shall be deemed waived. The Contractor shall execute the Change Order prepared pursuant to the foregoing. After the Change Order has been prepared and forwarded to the Contractor for execution, the Contractor shall not modify or amend the form or content of such Change Order, or any portion thereof.

17.4. Unilateral Change Orders

17.4.1. A Unilateral Change Order is a written order prepared and issued by the District, the Construction Manager, and/or the Architect and signed by the District, directing a change in the Work. The District may as provided by law, by Unilateral Change Order and without invalidating the Contract, order changes in the Work consisting of additions, deletions, or other revisions. Any dispute as to the sum of the Unilateral Change Order or timing of payment shall be resolved pursuant to the Payment provisions and the Claims provisions herein. **A Unilateral Change Order is NOT a Construction Change Document (which is defined above as a Change Order that DSA must approve).**

17.4.2. The District may issue a Unilateral Change Order in the absence of agreement on the terms of a Change Order.

17.5. Force Account Directives

17.5.1. When work, for which a definite price has not been agreed upon in advance, is to be paid for on a force account basis, all direct costs necessarily incurred and paid by the Contractor for labor, material, and equipment used in the performance of that Work, shall be subject to the approval of the District and compensation will be determined as set forth herein.

17.5.2. District will issue a Force Account Directive to proceed with the Work on a force account basis, and a not-to-exceed budget will be established by District.

17.5.3. All requirements regarding direct cost for labor, labor burden, material, equipment, and markups on direct costs for overhead and profit described in this section shall apply to Force Account Directives. However, District will only pay for actual costs verified in the field by the District or its authorized representative(s) on a daily basis.

17.5.4. Contractor shall be responsible for all cost related to the administration of Force Account Directive. The markup for overhead and profit for Contractor modifications shall be full compensation to the Contractor to administer Force Account Directive.

17.5.5. Contractor shall notify District or its authorized representative(s) at least twenty-four (24) hours prior to proceeding with any of the force account work. Furthermore, the Contractor shall notify the District when it has consumed eighty percent (80%) of the budget, and shall not exceed the budget unless specifically authorized in writing by the District. Contractor will not be compensated for force account work in the event that Contractor fails to timely notify the District regarding the commencement of force account work, or exceeding the force account budget.

17.5.6. Contractor shall diligently proceed with the work, and on a daily basis, submit a daily force account report on a form supplied by the District no later than 5:00 p.m. each day. The report shall contain a detailed itemization of the daily labor, material, and equipment used on the force account work only. The names of the individuals performing the force account work shall be included on the daily force account reports. The type and model of equipment shall be identified and listed. District will review the information contained in the reports, and sign the reports no later than the next work day, and return a copy of the report to Contractor for its records. District will not sign, nor will Contractor receive compensation for work District cannot verify. Contractor will provide a weekly force account summary indicating the status of each Force Account Directive in terms of percent complete of the not-to-exceed budget and the estimated percent complete of the work.

17.5.7. In the event Contractor and District reach a written agreement on a set cost for the work while the work is proceeding based on a Force Account Directive, the Contractor's signed daily force account reports shall be discontinued and all previously signed reports shall be invalid.

17.6. Price Request

17.6.1. Definition of Price Request. A Price Request ("PR") is a written request prepared by the Architect or the District, requesting the Contractor to submit to the District and the Architect an estimate of the effect of a proposed change in the Work on the Contract Price and the Contract Time.

17.6.2. Scope of Price Request. A Price Request shall contain adequate information, including any necessary Drawings and Specifications, to enable Contractor to provide the cost breakdowns required herein. Contractor shall not be entitled to any additional compensation for preparing a response to a Price Request, whether ultimately accepted or not.

17.6.3. Contractor shall not consider Price Requests to be instructions either to stop work in progress or to execute the proposed change.

17.6.4. Within the time specified in Price Request after receipt of Price Request, Contractor shall submit a quotation estimating cost adjustments to the Contract Price and the Contract Time necessary to execute the change, with the following documentation and information:

17.6.4.1. Include a list of quantities of products required or eliminated and unit costs, with total amount of purchases and credits to be made. If requested, furnish survey data to substantiate quantities.

17.6.4.2. Indicate applicable taxes, delivery charges, equipment rental, and amounts of trade discounts.

17.6.4.3. Include costs of labor and supervision directly attributable to the change.

17.6.4.4. Include an updated Contractor's Construction Schedule that indicates the effect of the change, including, but not limited to, changes in activity duration, start and finish times, and activity relationship. Use available total float before requesting an extension of the Contract Time.

17.7. Proposed Change Order

17.7.1. Proposed Change Order. The Contractor may issue a Proposed Change Order (“PCO”), only as a written request prepared by it to the District and the Architect, requesting that the District issue a Change Order based upon a proposed change to the Work.

17.7.2. Changes in Contract Price. A PCO shall include breakdowns pursuant to the provisions herein to validate any change in Contract Price and include all reasonable documentation as required herein.

17.7.3. Changes in Time. A PCO shall also include any changes in time required to complete the Project. Include an updated Contractor's Construction Schedule that indicates the effect of the change, including, but not limited to, changes in activity duration, start and finish times, and activity relationships. Use available total float before requesting an extension of the Contract Time. Any additional time requested shall not be the number of days to make the proposed change, but must be based upon the impact to the Construction Schedule as defined in the Contract Documents. If Contractor fails to request a time extension in a PCO, then the Contractor is thereafter precluded from requesting time and/or claiming a delay. If the Contractor is requesting additional time and believes that time is both Excusable and Compensable, then the Contractor must provide detailed documentation that supports its position and that addresses all the components of the “Excusable and Compensable Delay(s)” section above.

17.7.4. Unknown and/or Unforeseen Conditions. If Contractor submits a PCO requesting an increase in Contract Price and/or Contract Time that is based at least partially on Contractor’s assertion that Contractor has encountered unknown and/or unforeseen condition(s) on the Project, then Contractor shall base the PCO on provable information that, beyond a reasonable doubt and to the District’s satisfaction, demonstrates that the unknown and/or unforeseen condition(s) were actually unknown and/or unforeseen and that the condition(s) were reasonably unknown and/or unforeseen. If not, the District shall deny the PCO and the Contractor shall complete the Project without any increase in Contract Price and/or Contract Time based on that PCO.

17.7.5. Time to Submit PCO. Contractor shall submit its PCO within five (5) days of the date Contractor discovers, or reasonably should discover, the circumstances giving rise to the proposed change order, unless additional time to submit a proposed change order is granted in writing by the District. Time is of the essence in Contractor's written notice pursuant to the preceding sentence so that the District can promptly investigate and consider alternative measures to the address the basis for the PCI. Accordingly, Contractor acknowledges that its failure, for any reason, to give written notice (with Supporting Documentation to permit the District's review and evaluation) within this time frame shall be deemed Contractor's waiver, release, discharge and relinquishment of any right to assert or claim any entitlement to an adjustment of the Contract Time or the Contract Price on account of the circumstances giving rise to the PCO.

17.7.6. COVID-19 and other Infectious Disease(s).

17.7.6.1. Contractor agrees that its bid, the Contract Price and the Contract Time are based on the Contractor’s full compliance with all applicable and existing federal, state, and/or local statutes, orders, rules, regulations, ordinances, and/or directives relating to construction site safety in connection with Infectious Disease(s) (as defined herein) including COVID-19, and/or any similar virus or derivative strain at the time of Contract award. Therefore, any cost or delay associated with Infectious Disease(s), or any derivative or similar strain thereof, or any federal, state, or local order relating thereto, shall not be considered compensable unless:

17.7.6.1.1. It occurred after the date of the award of the Contract to Contractor;

17.7.6.1.2. It materially increases the Contract Price or the Contract Time; and

17.7.6.1.3. Contractor notifies the District within 10 days of notice of any a new derivative, strain, or new public health order(s), including the anticipated increase to the Contract Price or Contract Time due to the new derivative, strain, or new public health order(s), and Contractor substantiates those costs with detailed supporting documentation as required for a PCO.

17.7.6.2. If, during the construction of the Project, the applicable and existing federal, state, and/or local statutes, orders, rules, regulations, ordinances, and/or directives relating to construction site safety in connection with Infectious Disease(s), and/or any similar virus or derivative strain, are changed or rescinded (e.g., by the reduction of potential exposure or risk due to vaccinations), the Parties agree to reduce the Contract Price and the Contract Time due to the removal of the required efforts. If the Parties cannot mutually agree on the appropriate reduction, the District may issue a Unilateral Change Order for an amount of time and money it determines to be both reasonable and appropriate. The Parties agree that any dispute related to this provision will be resolved pursuant to the Claims Resolution Process herein.

17.8. Format for Proposed Change Order

17.8.1. The following “Format For Proposed Change For Subcontractor Performed Work” and “Format For Proposed Change For Contractor Performed Work” shall be used as applicable by the District and the Contractor (e.g. Change Orders, PCO’s) to communicate proposed additions and deductions to the Contract, supported by attached documentation.

FORMAT FOR PROPOSED CHANGE FOR SUBCONTRACTOR PERFORMED WORK

	<u>SUBCONTRACTOR PERFORMED WORK</u>	<u>ADD</u>	<u>DEDUCT</u>
(A)	<p><u>Labor Charge</u></p> <p>1. Hours. Attach total itemized hours, by each Subcontractor at each tier.</p> <p>2. Rate. This shall be no more than the Straight-Time Total Hourly Rate as determined by the Department of Industrial Relations (“DIR”) for the applicable labor category.</p>		
(B)	<p><u>Labor Burden & Worker’s Compensation Charge</u></p> <p>1. This shall be no more than <u>twenty percent (20%)</u> of item (A), the Labor Charge.</p> <p>2. This shall be the total cumulative charge permitted for all Subcontractors or all labor performed by the Subcontractor or Subcontractor’s Subcontractor(s) (i.e., all “lower-tier” Subcontractor(s)).</p>		
(C)	<u>Subtotal (A+B)</u>		
(D)	<p><u>Material Charge</u></p> <p>Attach itemized quantity and unit cost plus sales tax and invoice(s) from vendor(s).</p>		
(E)	<p><u>Equipment Charge</u></p> <p>Attach invoice(s) from supplier(s).</p>		
(F)	<u>Subtotal (C+D+E)</u>		
(G)	<p><u>Subcontractor’s Overhead and Profit Charge</u></p> <p>1. This shall be no more than <u>eight percent (8%)</u> of item (F).</p> <p>2. This shall be the total cumulative mark-up permitted for the Subcontractor and Subcontractor’s Subcontractor(s) (i.e., all “lower-tier” Subcontractor(s)).</p>		
(H)	<u>Subtotal (F+G)</u>		
(I)	<p><u>Contractor’s Overhead, Profit, Bond and Insurance</u></p> <p>1. This shall be no more than <u>six percent (6%)</u> of Item (F).</p> <p>2. This shall be the total mark-up permitted for Contractor.</p>		
(J)	<u>TOTAL (H+I)</u>		
(K)	<u>Time</u>	_____ Days	

FORMAT FOR PROPOSED CHANGE FOR CONTRACTOR PERFORMED WORK

	<u>CONTRACTOR PERFORMED WORK</u>	<u>ADD</u>	<u>DEDUCT</u>
(A)	<u>Labor Charge</u> 1. Hours. Attach total itemized hours. 2. Rate. This shall be no more than the Straight-Time Total Hourly Rate as determined by the Department of Industrial Relations (“DIR”) for the applicable labor category.		
(B)	<u>Labor Burden & Worker’s Compensation Charge</u> 1. This shall be no more than <u>twenty percent (20%)</u> of item (A), the Labor Charge. 2. This shall be the total cumulative charge permitted for all labor performed by Contractor.		
(C)	<u>Subtotal (A+B)</u>		
(D)	<u>Material Charge</u> Attach itemized quantity and unit cost plus sales tax and invoice(s) from vendor(s).		
(E)	<u>Equipment Charge</u> Attach invoice(s) from supplier(s).		
(F)	<u>Subtotal (C+D+E)</u>		
(G)	<u>Contractor’s Overhead, Profit, Bond and Insurance</u> 1. This shall be no more than <u>six percent (6%)</u> of Item (F). 2. This shall be the total mark-up permitted for Contractor.		
(H)	<u>TOTAL (F+G)</u>		
(I)	<u>Time</u>	_____ Days	

17.8.2. All Proposed Change Order requests by Contractor for a change shall include a complete itemized breakdown with the following detail:

17.8.2.1. Labor. Labor breakdown by trade classification, wage rates, and estimated hours. Labor costs shall only include fringe benefits indicated by governing trade organizations. Wages shall not exceed current prevailing wages in the locality for performance of the changes.

17.8.2.1.1. The Contractor's or Subcontractors' labor burden and Workers' Compensation premium shall only be charged as indicated herein. In no event shall Contractor include any other charges than as indicated herein without the prior written approval of the District.

17.8.2.2. Material. Material quantities, and types of products, and transportation costs, if applicable.

17.8.2.3. Equipment. Equipment breakdown by make, type, size, rental rates (if not owned), equipment hours and transportation costs, if applicable.

17.8.2.3.1. The equipment costs shall not exceed one hundred percent (100%) of the Association of Equipment Distributors (AED) rental rates and delay factors or Caltrans rates and delay factors, whichever is less. Hourly, daily, weekly, or monthly rates shall be used, whichever is lower. Hourly rates including operator shall not be used.

17.8.2.3.2. The time to be paid for equipment shall be the actual time that the equipment is in (1) productive operation on the Work or (2) idled because of the event or circumstance giving rise to the Proposed Change Order.

17.8.2.3.2.1. To calculate the costs of idle equipment, the Contractor must use the applicable idle equipment rate. For example, and clarification purposes only, if the rate for "X" piece of equipment is \$100 and the applicable delay factor is .20 for that piece of equipment, then the hourly rate for idle equipment shall be \$20 (\$100 x .20), which shall be applied against the number of hours idle. In no event shall Contractor charge an amount greater than 50% of the applicable equipment rate for idle equipment.

17.8.2.3.2.2. In computing the hourly rental of equipment, any time less than thirty (30) minutes shall be considered one-half (1/2) hour.

17.8.2.3.2.3. No payment will be made for time while equipment is inoperative due to breakdown, or for non-workdays.

17.8.2.3.2.4. The rental time shall not include the time required to move the equipment to and from the project site. No mobilization or demobilization will be allowed for equipment already on site. If equipment is not moved by its own power, then loading and transportation costs will be paid in lieu of rental time thereof. However, neither moving time nor loading and transportation costs will be paid if the equipment is used on the Project Site in any other way than upon the work directly related to the event or circumstance giving rise to the Proposed Change Order.

17.8.2.3.3. Individual pieces of equipment having a replacement value of one thousand dollars (\$1,000) or less shall be considered to be small tools or small equipment, and no payment will be made since the costs of these tools and equipment is included as part of the markup for overhead and profit defined herein.

17.8.2.3.4. Payment to the Contractor for the use of equipment as set forth above shall constitute full compensation to the Contractor for the cost of fuel, power, oil, lubricants,

supplies, small equipment, necessary attachments, repairs and maintenance of any kind, depreciation, storage, insurance, labor (except for equipment operators), and any and all costs to the Contractor incidental to the use of the equipment.

17.8.2.3.5. Should Contractor, or any of its owners, officers, directors or agents, hold any ownership interest in any company, organization, association or corporation from whom rental equipment is secured. Contractor shall immediately notify District of such and the price set for any such rental shall be agreed upon in advance by the Contractor and the District.

17.8.2.4. Overhead, Profit, Bond and Insurance Costs. Markup for overhead and profit, which shall be used to compensate Contractor for all costs for all administration, general conditions, and supervision, including, without limitation:

17.8.2.4.1. All home office overhead, field office overhead, field office personnel including, but not limited to, principals, project managers, superintendents, supervisory foremen, estimators, project engineers, detailers, draftsmen, schedulers, consultants, watchmen, payroll clerks, administrative assistants, labor compliance costs and secretaries.

17.8.2.4.2. All field and field office expenses including, but not limited to, field trailers, parking, storage sheds, office equipment and supplies, telephone service and long distance telephone calls, computers, fax machines, temporary utilities, sanitary facilities and services, janitorial services, small tools and equipment with a cost under \$1000 each, portable scaffolding, blocking, shores, appliances, job vehicles, security and fencing, conformance to regulatory requirements including compliance to safety regulations, safety programs and meetings, cartage, warranties, As-Built Drawings, as well as any related maintenance costs.

17.8.2.4.3. Administrative functions such as, but not limited to, reviewing, coordinating, distributing, processing, posting, recording, estimating, negotiating, expediting, engineering, drawing, detailing, revising shop drawings, carting, cleaning, protecting the work, and other incidental Work related to the change.

17.8.2.4.4. All other costs and taxes required to be paid, but not included under direct costs as defined above including, without limitation, payroll taxes, social security, etc.

17.8.2.4.5. All costs for Contractor's bonds and insurance.

17.8.2.4.6. Taxes: Federal excise tax shall not be included. District will issue an exemption on request.

17.8.2.5. Contract Time. Justification for any adjustment in Contract Time including a schedule analysis identifying critical schedule activities delayed by the request. Contract Time shall be extended or reduced by Change Orders, Unilateral Change Orders, or Force Account Directives for a period of time commensurate with the time reasonably necessary to perform a Change. This time must be requested in writing by the Contractor with the Price Request, PCO, or expressly in writing as part of its documentation for Unilateral Change Orders, or Force Account Directives. The Contractor shall justify any Contract Time extension by submittal of a schedule analysis as required in this Changes section of these General Conditions accurately portraying the impact of the change on the critical path of the Construction Schedule. Changes performed within available float shall not justify an extension to the Contract Time. The District shall make the final determination of the amount of Contract Time to allocate to any Change.

17.8.2.6. Supporting Documentation. Contractor shall include with each PCO, along with the itemized breakdown as required herein, reasonable documentation substantiating the

requested change in the Contract Price and Contract Time. If the District deems Contractor's supporting documentation incomplete or inadequate to substantiate the requested change to the Contract Price and Contract Time, the District may request that Contractor supplement the PCO with additional, reasonable supporting documentation.

17.9. Change Order Certification

17.9.1. All Change Orders and PCOs shall include the following certification by the Contractor. The Parties acknowledged that if a Change Order is approved that does not include this language, that Change Order shall be deemed to include this certification language:

The Contractor approves the foregoing as to the changes, if any, and the price specified for each item and the extension of time allowed, if any, for completion of the entire Work as stated herein, and agrees to furnish all labor, materials, and service, and perform all work necessary to complete all additional work specified for the consideration stated herein. Submission of sums that have no basis in fact or which Contractor knows are false are at the sole risk of Contractor and may be a violation of the False Claims Act set forth under Government Code section 12650 et seq. It is understood that the changes herein to the Contract shall only be effective when approved by the governing board of the District. It is expressly understood that the value of the extra Work or changes includes all of the Contractor's costs, expenses, field overhead, home office overhead, profit, both direct and indirect, resulting from additional time required on the Project or resulting from delay to the Project. Any costs, expenses, damages, or time extensions not included are deemed waived.

17.10. Determination of Change Order Cost

17.10.1. The amount of the increase or decrease in the Contract Price from a Change Order, if any, shall be determined in one or more of the following ways as applicable to a specific situation and at the District's discretion:

17.10.1.1. District acceptance of a PCO;

17.10.1.2. By agreement between District and Contractor.

17.10.1.3. By unit prices or alternates contained in Contractor's original bid. If the Bid for the Work included proposal(s) for Alternate Bid Item(s), during Contractor's performance of the Work, the District may elect to add any such Alternate Bid Item(s) if the that item did not form a basis for award of the Contract or delete any such Alternate Bid Item(s) if that item formed a basis for award of the Contract. If the District elects to add or delete an Alternate Bid Item(s) pursuant to the foregoing, the cost or credit for that Alternate Bid Item(s) shall be as set forth in the Contractor's Bid, at the District's discretion. If any Alternate Bid Item is added or deleted from the Work pursuant to the foregoing, the Contract Time shall be adjusted by the number of days allocated for the added or deleted Alternate Bid Item in the Contract Documents; if days are not allocated for any Alternate Bid Item added or deleted pursuant to the foregoing, the Contract Time shall be equitably adjusted.

17.10.1.4. By the District, based upon actual and necessary costs incurred by the Contractor as determined by the District on the basis of the Contractor's records. Promptly upon determining the extent of adjustment to the Contract Price, the District shall notify the Contractor in writing of the same; the Contractor shall be deemed to have accepted the District's determination of the amount of adjustment to the Contract Price on account of a Change to the

Work unless Contractor shall notify the District, in writing, not more than fifteen (15) days from the date of the District's written notice, of any objection to the District's determination. Failure of the Contractor to timely notify the District of Contractor's objections to the District's determination of the extent of adjustment to the Contract Price shall be deemed Contractor's acceptance of the District's determination and a waiver of any right or basis of the Contractor to thereafter protest or otherwise object to the District's determination. Notwithstanding any objection of the Contractor to the District's determination of the extent of any adjustment to the Contract Price pursuant to this provision, Contractor shall diligently proceed to perform and complete any such Change.

17.11. Deductive Change Orders

If Contractor offers a proposed amount for a deductive Change Order(s), Contractor shall include a minimum of five percent (5%) total overhead and profit to be deducted with the amount of the work of the Change Order(s). If Subcontractor work is involved, Subcontractors shall also include a minimum of five percent (5%) overhead and profit to be deducted with the amount of its deducted work, for a total minimum of ten percent (10%) total overhead and profit to be deducted. Any deviation from this provision shall not be allowed.

17.12. Discounts, Rebates and Refunds

For purposes of determining the cost, if any, of any change, addition, or omission to the Work hereunder, all trade discounts, rebates, refunds, and all returns from the sale of surplus materials and equipment shall accrue and be credited to the Contractor, and the Contractor shall make provisions so that such discounts, rebates, refunds, and returns may be secured, and the amount thereof shall be allowed as a reduction of the Contractor's cost in determining the actual cost of construction for purposes of any change, addition, or omission in the Work as provided herein.

17.13. Accounting Records

With respect to portions of the Work performed by Change Orders, Unilateral Change Orders, or Force Account Directives, Contractor shall keep and maintain cost-accounting records satisfactory to the District, which shall be available to the District on the same terms as any other books and records Contractor is required to maintain pursuant to the Contract Documents.

17.14. Notice Required

If Contractor is seeking an adjustment in the Contract Price, or any extension in the Contract Time for Completion, it shall notify District pursuant to the provisions of the Contract Documents. No adjustment in the Contract Price or Contract Time shall be considered unless made in accordance with the Contract Documents. Contractor shall proceed to execute the Work even though the adjustment may not have been agreed upon. Any change in the Contract Price or extension of the Contract Time resulting from such contract adjustment shall only be authorized by a Change Order.

17.15. Applicability to Subcontractors

Any requirements under this Article shall be equally applicable to Change Orders, Unilateral Change Orders, or Force Account Directives issued to Subcontractors by the Contractor to the extent as required by the Contract Documents.

17.16. Alteration to Change Order Language

Contractor shall not alter Change Orders or reserve time in Change Orders. Contractor shall execute finalized Change Orders and proceed under the provisions herein with proper notice.

17.17. Failure of Contractor to Execute Change Order

Contractor shall be in default of the Contract if Contractor fails to execute a Change Order when the Contractor agrees with the addition and/or deletion of the Work in that Change Order.

18. REQUEST FOR INFORMATION

18.1. Any Request for Information (“RFI”) shall reference all applicable Contract Document(s), including Specification section(s), detail(s), page number(s), drawing number(s), and sheet number(s), etc. Contractor shall make suggestions and interpretations of the issue raised by each RFI. An RFI cannot modify the Contract Price, Contract Time, or the Contract Documents.

18.2. Contractor shall be liable to the District for all costs incurred by the District associated with the processing, reviewing, evaluating and responding to any RFI, including without limitation, fees of the Architect and any other design consultant to the Architect or the District, that District reasonably determines:

18.2.1. Does not reflect adequate or competent supervision or coordination by the Contractor or any Subcontractor; or

18.2.2. Does not reflect the Contractor's adequate or competent knowledge of the requirements of the Work or the Contract; or

18.2.3. Requests an interpretation or decision of a matter where the information sought is equally available to the Contractor; or

18.2.4. Is not justified for any other reason.

18.3. Prior to submitting the RFI, Contractor shall diligently review the Contract Documents for information responsive to the RFI, including information incorporated by reference. Contractor should not issue an RFI regarding information contained in or inferable from the Contract Documents, including information incorporated by reference. An RFI is invalid if the RFI response is contained in or inferable from the Contract Documents.

18.4. Contractor shall be responsible for preparing and submitting each RFI so as to not cause delay to the progress of the Work nor to cause any impact to the Contractor’s labor productivity. An RFI may be considered untimely if not submitted within **Forty Eight (48) hours** of receipt from a Contractor’s subcontractor. Untimely submission of any RFI will preclude Contractor from asserting any claims for delay or for labor impact against the District.

18.5. If the Contractor fails to timely notify the Architect in writing of any Conditions encountered and the Contractor proceeds to perform any portion of the Work containing or affected by such Conditions the Contractor shall bear all costs associated with or required to correct, remove, or otherwise remedy any portion of the Work affected thereby without adjustment of the Contract Time or the Contract Price. In requesting information of the District to address and resolve any conditions, the Contractor shall act with promptness in submitting any written request so as to allow the District a reasonable period of time to review, evaluate and respond to any request, taking into account the then current status of the progress and completion of the Work and the actual or potential impact of any conditions upon the completion of the Work within the Contract Time. The Contract Time shall not be subject to adjustment in the event that the Contractor shall fail to timely request information from the District.

19. PAYMENTS

19.1. Contract Price

19.1.1. The Contract Price is stated in the Agreement and, including authorized adjustments, is the total amount payable by the District to the Contractor for performance of the Work pursuant to the Contract Documents. If all or a portion of the Project is being funded by funds requiring approval by the State Allocation Board (SAB), payment may be subject to that approval being received, funding by the SAB, and funds being released by the Office of Public School Construction (OPSC).

19.2. Applications for Progress Payments

19.2.1. Procedure for Applications for Progress Payments

19.2.1.1. Application for Progress Payment

19.2.1.1.1. Not before the fifth (5th) day of each calendar month during the progress of the Work, Contractor shall submit to the District and the Architect an itemized Application for Payment for Work completed in accordance with the Schedule of Values. The Application for Payment shall be notarized, if required, and supported by the following or each portion thereof unless waived by the District in writing:

19.2.1.1.1.1. The amount paid to the date of the Application for Payment to the Contractor, to all its Subcontractors, and all others furnishing labor, material, or equipment for its Contract;

19.2.1.1.1.2. The amount being requested by the Application for Payment by the Contractor on its own behalf and separately stating the amount requested on behalf of each of the Subcontractors and all others furnishing labor, material, and equipment under the Contract;

19.2.1.1.1.3. The balance that will be due to each of the entities after payment is made;

19.2.1.1.1.4. A certification that the As-Built Drawings and annotated Specifications are current;

19.2.1.1.1.5. An Itemized breakdown of Work performed;

19.2.1.1.1.6. An updated and acceptable construction schedule in conformance with the provisions herein;

19.2.1.1.1.7. The additions to and subtractions from the Contract Price and Contract Time;

19.2.1.1.1.8. A total of the retention held;

19.2.1.1.1.9. The material invoices, evidence of equipment purchases, rentals, and other support and details of cost as the District may require from time to time;

19.2.1.1.1.10. The percentage of completion of the Contractor's Work by line item;

19.2.1.1.1.11. The Schedule of Values updated from the preceding Application for Payment;

19.2.1.1.1.12. A duly completed and executed conditional waiver and release upon progress payment compliant with Civil Code section 8132 from each subcontractor of any tier and supplier to be paid from the current progress payment;

19.2.1.1.1.13. A duly completed and executed unconditional waiver and release upon progress payment compliant with Civil Code section 8134 from each subcontractor of any tier and supplier that was paid from the previous progress payment; and

19.2.1.1.1.14. A certification by the Contractor of the following:

The Contractor warrants title to all Work performed as of the date of this payment application. The Contractor further warrants that all Work performed as of the date of this payment application is free and clear of liens, claims, security interests, or encumbrances in favor of the Contractor, Subcontractors, material and equipment suppliers, workers, or other persons or entities making a claim by reason of having provided labor, materials, and equipment relating to the Work, except those of which the District has been informed.

19.2.1.1.1.15. If requested by the District, a third party, or as required by the California Department of Industrial Relations, all requested or required certified payroll record ("CPR(s)") for each journeyman, apprentice, worker, or other employee employed by the Contractor and/or each Subcontractor in connection with the Work for the period of the Application for Payment.

19.2.1.1.2. Except as expressly provided for herein, no payments shall be made by the District on account of any item of the Work, including without limitation, materials or equipment that, at the time of the Contractor's submittal of an Application for Progress Payment, has/have not been incorporated into and made a part of the Work.

19.2.1.1.3. Contractor shall be subject to the False Claims Act set forth under Government Code section 12650 et seq., for information provided with any Application for Progress Payment.

19.2.2. Prerequisites for Progress Payments

19.2.2.1. First Payment Request: The following items, if applicable, must be completed before District will accept and/or process Contractor's first payment request:

19.2.2.1.1. Installation of the Project sign;

19.2.2.1.2. Installation of field office;

19.2.2.1.3. Installation of temporary facilities and fencing;

19.2.2.1.4. Schedule of Values;

19.2.2.1.5. Contractor's Construction Schedule;

19.2.2.1.6. Schedule of unit prices, if applicable;

19.2.2.1.7. Submittal Schedule;

19.2.2.1.8. Receipt by Architect of all submittals due as of the date of the payment application;

19.2.2.1.9. Copies of necessary permits;

- 19.2.2.1.10. Copies of authorizations and licenses from governing authorities;
- 19.2.2.1.11. Initial progress report;
- 19.2.2.1.12. Surveyor qualifications;
- 19.2.2.1.13. Written acceptance of District's survey of rough grading, if applicable;
- 19.2.2.1.14. List of all Subcontractors, with names, license numbers, telephone numbers, and Scope of Work;
- 19.2.2.1.15. All bonds and insurance endorsements; and
- 19.2.2.1.16. Resumes of Contractor's project manager, and if applicable, job site secretary, record documents recorder, and job site superintendent.

19.2.2.2. Second Payment Request: District will not process the second payment request until and unless all submittals and Shop Drawings have been accepted for review by the Architect.

19.2.2.3. No Waiver of Criteria: Any payment made to Contractor where criteria set forth herein have not been met shall not constitute a waiver of said criteria by District. The approval of any Application for Progress Payment or the disbursement of any Progress Payment to the Contractor shall not be deemed nor constitute acceptance of defective Work or Work not in conformity with the Contract Documents. Instead, such payment shall be construed as a good faith effort by District to resolve differences so Contractor may pay its Subcontractors and suppliers. Contractor agrees that failure to submit such items may constitute a material breach of the Contract by Contractor and may subject Contractor to termination.

19.3. Progress Payments

19.3.1. District's Approval of Application for Payment

19.3.1.1. Upon receipt of an Application for Payment, District shall act in accordance with the following:

19.3.1.1.1. Each Application for Payment shall be reviewed by the District as soon as practicable after receipt for the purpose of determining that the Application for Payment is a proper Application for Payment.

19.3.1.1.2. Any Application for Payment determined not to be a proper Application for Payment suitable for payment shall be returned to the Contractor as soon as practicable, but not later than seven (7) days, after receipt. An Application for Payment returned pursuant to this paragraph shall be accompanied by a document setting forth in writing the reasons why the Application for Payment is not proper. The number of days available to the District to make a payment without being subject to any applicable statute regarding prompt payment or interest accrual, shall be reduced by the number of days by which the District exceeds this seven-day return requirement.

19.3.1.1.3. An approved Application for Payment shall be considered payable if funds are available for payment after the deduction of amounts allowed by law and/or pursuant to the section herein entitled "Decisions to Withhold Payment,"

19.3.1.2. The District's review of the Contractor's Application for Payment will be based

on the District's and the Architect's observations at the Site and the data comprising the Application for Payment that the Work has progressed to the point indicated and that, to the best of the District's and the Architect's knowledge, information, and belief, the quality of the Work is in accordance with the Contract Documents. The foregoing representations are subject to:

19.3.1.2.1. Observation of the Work for general conformance with the Contract Documents,

19.3.1.2.2. Results of subsequent tests and inspections,

19.3.1.2.3. Minor deviations from the Contract Documents correctable prior to Completion, and

19.3.1.2.4. Specific qualifications expressed by the Architect.

19.3.1.3. District's approval of each Application for Payment shall be based on Contractor complying with all requirements for a fully complete and valid Application for Payment.

19.3.2. Payments to Contractor

19.3.2.1. Within thirty (30) days after District's receipt of each undisputed and properly submitted Application for Payment, Contractor shall be paid a sum equal to ninety-five percent (95%) of the value of the Work performed (as verified by Architect and Inspector and certified by Contractor) up to the last day of the previous month, less the aggregate of previous payments and amount to be withheld. The value of the Work completed shall be Contractor's best estimate. No inaccuracy or error in Contractor's estimate shall operate to release the Contractor, or any Surety upon any bond, from damages arising from such Work, or from the District's right to enforce each and every provision of this Contract, and the District shall have the right subsequently to correct any error made in any estimate for payment.

19.3.2.2. District shall withhold five percent (5%) retention from all Progress Payments.

19.3.2.3. District may withhold ten percent (10%) retention from all Progress Payments pursuant to Public Contract Code section 7201, if the Project is determined to be "substantially complex."

19.3.2.4. The Contractor shall not be entitled to have any payment requests processed, or be entitled to have any payment made for Work performed, so long as any lawful or proper direction given by the District concerning the Work, or any portion thereof, remains incomplete.

19.3.2.5. In accordance with Public Contract Code §20104.50, in the event that the District shall fail to make any Progress Payment within thirty (30) days after receipt of an undisputed and properly submitted Application for Progress Payment, the District shall pay the Contractor interest on the undisputed amount of such Application for Progress Payment equal to the legal rate of interest set forth in California Code of Civil Procedure §685.010(a).

19.3.3. No Waiver

No payment by District hereunder shall be interpreted so as to imply that District has inspected, approved, or accepted any part of the Work. Notwithstanding any payment, the District may enforce each and every provision of this Contract. The District may correct or require correction of any error subsequent to any payment.

19.3.4. Warranty of Title

19.3.4.1. If a lien or a claim based on a stop notice or stop payment notice of any nature should at any time be filed against the Work or any District property, by any entity that has supplied material or services at the request of the Contractor, Contractor and Contractor's Surety shall promptly, on demand by District and at Contractor's and Surety's own expense, take any and all action necessary to cause any such lien or a claim based on a stop notice or stop payment notice to be released or discharged immediately therefrom.

19.3.4.2. If the Contractor fails to furnish to the District within ten (10) calendar days after demand by the District, satisfactory evidence that a lien or a claim based on a stop notice or stop payment notice has been so released, discharged, or secured, the District may discharge such indebtedness and deduct the amount required therefore, together with any and all losses, costs, damages, and attorney's fees and expense incurred or suffered by District from any sum payable to Contractor pursuant to the Contract.

19.4. Decisions to Withhold Payment

19.4.1. Reasons to Withhold Payment

District may withhold payment in whole, or in part, to the extent reasonably necessary to protect the District if, in the District's opinion, the representations to the District required herein cannot be made. District may withhold payment, in whole, or in part, to such extent as may be necessary to protect the District from loss because of, but not limited to:

19.4.1.1. Defective Work not remedied within **FORTY-EIGHT (48)** hours of written notice to Contractor;

19.4.1.2. Stop notices, stop payment notices or other liens served upon the District as a result of the Contract;

19.4.1.3. Liquidated damages assessed against the Contractor;

19.4.1.4. The cost to complete the Work if there exists reasonable doubt that the Work can be completed for the unpaid balance of the Contract Price or by the Completion Date;

19.4.1.5. Damage to the District or other contractor(s);

19.4.1.6. Unsatisfactory performance of the Work by Contractor;

19.4.1.7. Failure to store and properly secure materials;

19.4.1.8. Failure of the Contractor to submit, on a timely basis, proper, sufficient, and acceptable documentation required by the Contract Documents, including, without limitation, a Construction Schedule, Schedule of Submittals, Schedule of Values, Monthly Progress Schedules, Shop Drawings, Product Data and samples, Proposed product lists, executed Change Orders, and/or verified reports;

19.4.1.9. Failure of the Contractor to maintain As-Built Drawings;

19.4.1.10. Erroneous estimates by the Contractor of the value of the Work performed, or other false statements in an Application for Payment;

19.4.1.11. Unauthorized deviations from the Contract Documents;

19.4.1.12. Failure of the Contractor to perform the Work in a timely manner in compliance with the Construction Schedule, established progress schedules, and/or completion dates;

19.4.1.13. If requested by the District, or the failure to provide to the DIR, certified payroll records acceptable to the District and the DIR for each journeyman, apprentice, worker, or other employee employed by the Contractor and/or each Subcontractor in connection with the Work for the period of the Application for Payment;

19.4.1.14. Failure to properly pay prevailing wages as defined in Labor Code sections 1720 et seq. and/or failure to comply with any other Labor Code requirements;

19.4.1.15. Failure to properly maintain or clean up the Site;

19.4.1.16. Failure to timely indemnify, defend or hold harmless the District;

19.4.1.17. Any payments due to the District, including but not limited to payments for failed tests, utilities changes, or permits;

19.4.1.18. Failure to pay Subcontractor(s) or supplier(s) as required by law and by the Contract Documents;

19.4.1.19. Failure to pay any royalty, license or similar fees;

19.4.1.20. Failure of the Contractor to submit on a timely basis all Closeout Documentation in a manner and form that is proper, sufficient, and reasonably acceptable to the District, and to not cause a delay in the Completion or approval of the Project; or

19.4.1.21. Failure to perform any implementation and/or monitoring required by any SWPPP for the Project and/or the imposition of any penalties or fines imposed therefore against Contractor or District.

19.4.1.22. Payment is delayed due to an audit inquiry by the State, the County Office of Education, the County, or any entity with jurisdiction related to the Project.

19.4.1.23. Contractor is otherwise in breach, default or in substantial violation of any provision of the Contract;

19.4.2. Reallocation of Withheld Amounts

19.4.2.1. District may, in its discretion, apply any withheld amount to pay outstanding claims or obligations as defined herein. In so doing, District shall make such payments on behalf of Contractor. If any payment is so made by District, then that amount shall be considered a payment made pursuant to the Contract and District shall not be liable to Contractor for any payment made in good faith. These payments may be made without prior judicial determination of claim or obligation. District will render Contractor an accounting of funds disbursed on behalf of Contractor.

19.4.2.2. If Contractor defaults or neglects to perform the Work in accordance with the Contract Documents or fails to perform any provision thereof, District may, after **FORTY-EIGHT (48)** hours written notice to the Contractor and, without prejudice to any other remedy, make good such deficiencies. District shall adjust the total Contract Price by reducing the amount thereof by the cost of making good such deficiencies. If District deems it inexpedient to correct Work that is damaged, defective, or not done in accordance with Contract provisions, an

equitable reduction in the Contract Price (of at least one hundred twenty-five percent (125%) of the estimated reasonable value of the nonconforming Work) shall be made therefor.

19.4.3. Payment After Cure

When Contractor cures the grounds for declining approval, payment shall be made for amounts so withheld. No interest shall be paid on any retention or amounts withheld due to the failure of the Contractor to perform in accordance with the terms and conditions of the Contract Documents.

19.5. Subcontractor Payments

19.5.1. Payments to Subcontractors. No later than seven (7) days after receipt, or pursuant to Business and Professions Code section 7108.5 and Public Contract Code section 7107, the Contractor shall pay to each Subcontractor, out of the amount paid to the Contractor on account of such Subcontractor's portion of the Work, the amount to which said Subcontractor is entitled. Contractor shall, by appropriate agreement with each Subcontractor, require each Subcontractor to make payments to its Sub-subcontractors in a similar manner.

19.5.2. No Obligation of District for Subcontractor Payment. District shall have no obligation to pay, or to see to the payment of, money to a Subcontractor except as may otherwise be required by law.

19.5.3. Joint Checks. District shall have the right in its sole discretion, if necessary for the protection of the District, to issue joint checks made payable to the Contractor and Subcontractors and material or equipment suppliers. The joint check payees shall be responsible for the allocation and disbursement of funds included as part of any such joint payment. In no event shall any joint check payment be construed to create any contract between the District and a Subcontractor of any tier, any obligation from the District to such Subcontractor, or rights in such Subcontractor against the District.

20. COMPLETION OF THE WORK

20.1. Completion

20.1.1. The Project may only be accepted by action of the governing board of the District.

20.1.2. District shall accept the Project and may have a Notice of Completion recorded when Project Completion has been achieved in accordance with the Contract Documents and to the satisfaction of District. For purposes of the payment of Retention, Completion is defined in Public Contract Code section 7107. For purposes of the timely filing of Stop Payment Notices, Completion is defined in California Civil Code section 9200, et seq.

20.1.3. There is no "*substantial completion*" for this Project. Even so, the District, at its sole option, may accept the Project and record a Notice of Completion when Project Completion has been completed to the satisfaction of District, except for minor corrective items, as distinguished from incomplete items. If Contractor fails to complete all minor corrective items within thirty-five (35) days after the date of the District's acceptance of the Project, District shall withhold from the final payment one hundred fifty percent (150%) of an estimate of the amount sufficient to complete the corrective items, as determined by District, until the item(s) are completed.

20.1.4. At the end of the thirty-five (35) day period, if there are any items remaining to be corrected, District may elect to proceed as provided herein related to adjustments to Contract Price, and/or District's right to perform the Work of the Contractor.

20.2. Closeout Procedures

20.2.1. Punch List

Contractor shall notify the Architect when Contractor considers the Work complete. Upon notification, Architect will prepare a list of minor items to be completed or corrected (“Punch List”). Contractor and/or its Subcontractors shall proceed promptly to complete and correct items on the Punch List. Failure to include an item on Punch List does not alter the responsibility of the Contractor to complete all Work in accordance with the Contract Documents.

20.2.2. Closeout Requirements

20.2.2.1. Utility Connections

Buildings shall be connected to water, gas, sewer, and electric services, complete and ready for use. Service connections shall be made and existing services reconnected.

20.2.2.2. As-Built Drawings

20.2.2.2.1. In addition to its requirement to provide monthly As-Built Drawings to the District, the Contractor shall provide a final set of As-Built Drawings, sometimes referred to as “Record Drawings,” showing all of the Work as actually constructed upon Completion of the Project as indicated in the Specifications.

20.2.2.2.2. Contractor is liable and responsible for any and all inaccuracies in the As-Built Drawings, even if inaccuracies become evident at a future date.

20.2.2.2.3. Upon Completion of the Work and as a condition precedent to approval of final payment, Contractor shall obtain the Inspector’s approval of the final set of As-Built Drawings.

20.2.2.3. Operations & Maintenance Manuals: Contractor shall prepare all operation and maintenance manuals and date as indicated in the Specifications.

20.2.2.4. Closeout Documentation: Contractor shall provide all Closeout Documentation, which shall include the following, without limitation:

20.2.2.4.1. A full set of final As-Built Drawings, as further defined herein.

20.2.2.4.2. All Operations & Maintenance Manuals and information, as further defined herein.

20.2.2.4.3. All Warranties, as further defined herein.

20.2.2.4.4. Verified report(s) for all scope(s) of work (DSA 6-C, Rev 03/22/13, or more recent revision if available).

20.3. Final Inspection

20.3.1. Contractor shall comply with Punch List procedures as provided herein, and maintain the presence of Contractor’s superintendent and project manager until the Punch List is complete to ensure proper and timely completion of the Punch List. Under no circumstances shall Contractor demobilize its forces prior to completion of the Punch List. Upon receipt of Contractor’s written notice that all of the Punch List items have been fully completed and the Work is ready for final inspection and acceptance, Architect and Project Inspector will inspect the Work and shall submit to Contractor and District a final inspection report noting the Work, if any, required in order to complete in accordance with the Contract

Documents. Absent unusual circumstances, this report shall consist of the Punch List items not yet satisfactorily completed.

20.3.2. Upon Contractor's completion of all items on the Punch List and any other uncompleted portions of the Work, the Contractor shall notify the District and Architect, who shall again inspect such Work. If the Architect finds the Work complete and acceptable under the Contract Documents, the Architect will notify Contractor, who shall then jointly submit to the Architect and the District its final Application for Payment.

20.3.3. Final Inspection Requirements

20.3.3.1. Before calling for final inspection, Contractor shall determine that the following have been performed:

20.3.3.1.1. The Work has been completed.

20.3.3.1.2. All life safety items are completed and in working order.

20.3.3.1.3. Mechanical and electrical Work are complete and tested, fixtures are in place, connected, and ready for tryout.

20.3.3.1.4. Electrical circuits scheduled in panels and disconnect switches labeled.

20.3.3.1.5. Painting and special finishes complete.

20.3.3.1.6. Doors complete with hardware, cleaned of protective film, relieved of sticking or binding, and in working order.

20.3.3.1.7. Tops and bottoms of doors sealed.

20.3.3.1.8. Floors waxed and polished as specified.

20.3.3.1.9. Broken glass replaced and glass cleaned.

20.3.3.1.10. Grounds cleared of Contractor's equipment, raked clean of debris, and trash removed from Site.

20.3.3.1.11. Work cleaned, free of stains, scratches, and other foreign matter, of damaged and broken material replaced.

20.3.3.1.12. Finished and decorative work shall have marks, dirt, and superfluous labels removed.

20.3.3.1.13. Final cleanup, as provided herein.

20.4. Costs of Multiple Inspections

More than two (2) requests of the District to make a final inspection shall be considered an additional service of District, Architect, Construction Manager, and/or Project Inspector, and all subsequent costs will be invoiced to Contractor and if funds are available, withheld from remaining payments.

20.5. Partial Occupancy or Use Prior to Completion

20.5.1. District's Rights to Occupancy. The District may occupy or use any completed or partially completed portion of the Work at any stage. Neither the District's Final Acceptance, the making of Final

Payment, any provision in Contract Documents, nor the use or occupancy of the Work, in whole or in part, by District shall constitute acceptance of Work not in accordance with the Contract Documents nor relieve the Contractor or the Contractor's Performance Bond Surety from liability with respect to any warranties or responsibility for faulty or defective Work or materials, equipment and workmanship incorporated therein. The District and the Contractor shall agree in writing to the responsibilities assigned to each of them for payments, security, maintenance, heat, utilities, damage to the Work, insurance, the period for correction of the Work, and the commencement of warranties required by the Contract Documents. Any dispute as to responsibilities shall be resolved pursuant to the Claims provisions herein, with the added provision that during the dispute process, the District shall have the right to occupy or use any portion of the Work that it needs or desires to use.

20.5.2. Inspection Prior to Occupancy or Use. Immediately prior to partial occupancy or use, the District, the Contractor, and the Architect shall jointly inspect the area to be occupied or portion of the Work to be used in order to determine and record the condition of the Work.

20.5.3. No Waiver. Unless otherwise agreed upon, partial or entire occupancy or use of a portion or portions of the Work shall not constitute beneficial occupancy or acceptance of the Work not complying with the requirements of the Contract Documents.

21. FINAL PAYMENT AND RETENTION

21.1. Final Payment

21.1.1. Upon receipt and approval of a valid and final Application for Payment, the Architect will issue a final Certificate of Payment or similar document indicating Architect's agreement that the Project has reached Completion. The District shall thereupon jointly inspect the Work and either accept the Work as complete or notify the Architect and the Contractor in writing of reasons why the Work has not reached Completion to the satisfaction of the District.

21.1.2. Upon acceptance of the Work of the Contractor as having reached Completion to the satisfaction of the District (that, absent unusual circumstances, will occur when the Punch List items have been satisfactorily completed), the District may record a Notice of Completion with the County Recorder, and the Contractor shall, upon receipt of final payment from the District, pay all the amount(s) due to its Subcontractors.

21.2. Prerequisites for Final Payment

The following conditions must be fulfilled prior to Final Payment:

21.2.1. A full and final waiver or release of all stop notices and stop payment notices in connection with the Work shall be submitted by Contractor, including a release of stop notice or stop payment notice in recordable form, together with (to the extent permitted by law) a copy of the full and final release of all stop notice or stop payment notice rights.

21.2.2. A duly completed and executed conditional waiver and release upon final payment compliant with Civil Code section 8136 from each subcontractor of any tier and supplier to be paid from the current progress payment.

21.2.3. A duly completed and executed unconditional waiver and release upon final payment compliant with Civil Code section 8138 from each subcontractor of any tier and supplier that was paid from the previous progress payment.

21.2.4. Contractor shall have made all corrections to the Work that are required to remedy any defects therein, to obtain compliance with the Contract Documents or any requirements of applicable codes and

ordinances, or to fulfill any of the orders or directions of District required under the Contract Documents.

21.2.5. Each Subcontractor shall have delivered to the Contractor all written guarantees, warranties, applications, and bonds required by the Contract Documents for its portion of the Work.

21.2.6. Contractor must have completed all requirements set forth under "Closeout Procedures," including, without limitation, submission of an approved set of complete As-Built Drawings.

21.2.7. Architect shall have issued its written approval that final payment can be made.

21.2.8. Contractor shall have delivered to the District all manuals and materials required by the Contract Documents.

21.2.9. Contractor shall have completed final clean up as provided herein.

21.3. Retention

21.3.1. The retention, less any amounts disputed by the District or that the District has the right to withhold pursuant to provisions herein, shall be paid:

21.3.1.1. After approval of the District by the Architect's Certificate of Payment;

21.3.1.2. After the satisfaction of the conditions set forth herein;

21.3.1.3. Within sixty (60) days after Completion;

21.3.1.4. No earlier than thirty-five (35) days of the recording of the Notice of Completion by District, if a Notice of Completion is recorded by the District.

21.3.2. No interest shall be paid on any retention, or on any amounts withheld due to a failure of the Contractor to perform, in accordance with the terms and conditions of the Contract Documents, except as provided to the contrary in any Escrow Agreement between the District and the Contractor pursuant to Public Contract Code section 22300.

21.4. Substitution of Securities

The District will permit the substitution of securities in accordance with the provisions of Public Contract Code section 22300.

21.5. Claims Asserted After Final Payment

Any lien, stop payment notice or other claim filed or asserted after the Contractor's acceptance of the Final Payment by any Subcontractor, of any tier, laborer, Material Supplier or others in connection with or for Work performed under the Contract Documents shall be the sole and exclusive responsibility of the Contractor pursuant to the indemnification obligations of the Contract Documents. In the event any lien, stop payment notice or other claim of any Subcontractor, Laborer, Material Supplier or others performing Work under the Contract Documents remain unsatisfied after Final Payment is made, Contractor shall refund to District all monies that the District may pay or be compelled to pay in discharging any lien, stop payment notice or other claim, including, without limitation all costs and reasonable attorneys' fees incurred by District in connection therewith.

22. UNCOVERING WORK, CORRECTION OF WORK AND RIGHT TO TAKEOVER WORK

22.1. Uncovering of Work

If a portion of the Work is covered without Project Inspector or Architect approval or not in compliance with the Contract Documents, it must, if required in writing by the District, the Project Inspector, or the Architect, be uncovered for the Project Inspector's or the Architect's observation and be replaced at the Contractor's expense without change in the Contract Price or Contract Time.

22.2. Rejection of Work

Prior to the District's Acceptance of the Work, any Work or materials or equipment forming a part of the Work or incorporated into the Work that is defective or not in conformity with the Contract Documents may be rejected by the District, the Architect or the Project Inspector and the Contractor shall correct all rejected Work without any adjustment to the Contract Price or the Contract Time, even if the Work, materials or equipment have been previously inspected by the Architect or the Project Inspector or even if they failed to observe the defective or non-conforming Work, materials or equipment.

22.3. Nonconforming Work

22.3.1. Contractor shall promptly remove from Premises all Work identified by District as failing to conform to the Contract Documents whether incorporated or not. Contractor shall promptly replace and re-execute its own Work to comply with the Contract Documents without additional expense to the District and shall bear the expense of making good all work of other contractors destroyed or damaged by any removal or replacement pursuant hereto and/or any delays to the District or other Contractors caused thereby.

22.3.2. If Contractor does not remove Work that District has identified as failing to conform to the Contract Documents within a reasonable time, not to exceed **FORTY-EIGHT (48)** hours, District may remove it and may store any material at Contractor's expense. If Contractor does not pay expense(s) of that removal within ten (10) days' time thereafter, District may, upon ten (10) days' written notice, sell any material at auction or at private sale and shall deduct all costs and expenses incurred by the District and/or District may withhold those amounts from payment(s) to Contractor.

22.4. Correction of Work

22.4.1. Correction of Rejected Work. Pursuant to the notice provisions herein, the Contractor shall promptly correct the Work rejected by the District, the Architect, or the Project Inspector as failing to conform to the requirements of the Contract Documents, whether observed before or after Completion and whether or not fabricated, installed, or completed. The Contractor shall bear costs of correcting the rejected Work, including additional testing, inspections, and compensation for the Inspector's or the Architect's services and expenses made necessary thereby.

22.4.2. One-Year Warranty Corrections. If, within one (1) year after the date of Completion of the Work or a designated portion thereof, or after the date for commencement of warranties established hereunder, or by the terms of an applicable special warranty required by the Contract Documents, any of the Work is found to be not in accordance with the requirements of the Contract Documents, the Contractor shall correct it promptly after receipt of written notice from the District to do so. This period of one (1) year shall be extended with respect to portions of the Work first performed after Completion by the period of time between Completion and the actual performance of the Work. This obligation hereunder shall survive acceptance of the Work under the Contract and termination of the Contract. The District shall give such notice promptly after discovery of the condition.

22.5. District's Right to Takeover Work

22.5.1. If the Contractor should neglect to prosecute the Work properly or fail to perform any provisions of this Contract, the District, after **FORTY-EIGHT (48)** hours written notice to the Contractor, may, without prejudice to any other remedy it may have, make good such deficiencies and may deduct the cost thereof

from the payment then or thereafter due the Contractor.

22.5.2. If it is found at any time, before or after Completion of the Work, that Contractor has varied from the Drawings and/or Specifications, including, but not limited to, variation in material, quality, form, or finish, or in the amount or value of the materials and labor used, District may require at its option:

22.5.2.1. That all such improper Work be removed, remade or replaced, and all work disturbed by these changes be made good by Contractor at no additional cost to the District;

22.5.2.2. That the District deduct from any amount due Contractor the sum of money equivalent to the difference in value between the work performed and that called for by the Drawings and Specifications; or

22.5.2.3. That the District exercise any other remedy it may have at law or under the Contract Documents, including but not limited to the District hiring its own forces or another contractor to replace the Contractor's nonconforming Work, in which case the District shall either issue a deductive Change Order, a Unilateral Change Order, or invoice the Contractor for the cost of that work. Contractor shall pay any invoices within thirty (30) days of receipt of same or District may withhold those amounts from payment(s) to Contractor.

22.5.3. Acceptance of Defective or Non-Conforming Work. The District may, in its sole and exclusive discretion, elect to accept Work that is defective or that is not in accordance with the requirements of the Contract Documents, instead of requiring its removal and correction, in which case the Contract Price shall be reduced as appropriate and equitable.

23. TERMINATION AND SUSPENSION

23.1. District's Right to Terminate Contractor for Cause

23.1.1. Grounds for Termination. The District, in its sole discretion, may terminate the Contract and/or terminate the Contractor's right to perform the work of the Contract based upon the following:

23.1.1.1. Contractor refuses or fails to execute the Work or any separable part thereof with sufficient diligence as will ensure its completion within the time specified or any extension thereof, or

23.1.1.2. Contractor fails to complete said Work within the time specified or any extension thereof, or

23.1.1.3. Contractor persistently fails or refused to perform Work or provide material of sufficient quality as to be in compliance with Contract Documents; or

23.1.1.4. Contractor files a petition for relief as a debtor, or a petition is filed against the Contractor without its consent, and the petition not dismissed within sixty (60) days; or

23.1.1.5. Contractor makes a general assignment for the benefit of its creditors, or a receiver is appointed on account of its insolvency; or

23.1.1.6. Contractor persistently or repeatedly refuses fails, except in cases for which extension of time is provided, to supply enough properly skilled workers or proper materials to complete the Work in the time specified; or

23.1.1.7. Contractor fails to make prompt payment to Subcontractors, or for material, or for labor; or

23.1.1.8. Contractor persistently disregards laws, or ordinances, or instructions of District; or

23.1.1.9. Contractor fails to supply labor, including that of Subcontractors, that can work in harmony with all other elements of labor employed or to be employed on the Work; or

23.1.1.10. Contractor or its Subcontractor(s) is/are otherwise in breach, default, or in substantial violation of any provision of this Contract.

23.1.2. Notification of Termination

23.1.2.1. Upon the occurrence at District's sole determination of any of the above conditions, District may, without prejudice to any other right or remedy, serve written notice upon Contractor and its Surety of District's termination of this Contract and/or the Contractor's right to perform the work of the Contract. This notice will contain the reasons for termination. Unless, within three (3) days after the service of the notice, any and all condition(s) shall cease, and any and all violation(s) shall cease, or arrangement satisfactory to District for the correction of the condition(s) and/or violation(s) be made, this Contract and/or the Contractor's right to perform the Work shall cease and terminate. Upon termination, Contractor shall not be entitled to receive any further payment until the entire Work is finished.

23.1.2.2. Upon termination, District may immediately serve written notice of tender upon Surety whereby Surety shall have the right to takeover and perform this Contract only if Surety:

23.1.2.2.1. Within three (3) days after service upon it of the notice of tender, gives District written notice of Surety's intention to takeover and perform this Contract; and

23.1.2.2.2. Commences performance of the Contract within seven (7) days from date of serving of its notice to District.

23.1.2.3. If Surety fails to notify District or begin performance as indicated herein, District may takeover the Work and execute the Work to completion by any method it may deem advisable at the expense of Contractor and/or its Surety. Contractor and/or its Surety shall be liable to District for any excess cost or other damages the District incurs thereby. Time is of the essence in the Contract. If the District takes over the Work as herein provided, District may, without liability for so doing, take possession of and utilize in completing the Work such materials, appliances, plan, and other property belonging to Contractor as may be on the Site of the Work, in bonded storage, or previously paid for.

23.1.2.4. **Conversion to Termination for Convenience.** In the event the Contract is terminated under this "District's Right to Terminate Contractor for Cause" section and it is finally determined by an arbitrator, court, jury or other tribunal having jurisdiction, for any reason, that the Contractor was not in default under the provisions hereof or that the District's exercise of its rights under this section was defective, deficient, ineffective, invalid or improper for any reason, the termination shall be deemed a termination for convenience of the District under the "Termination of Contractor for Convenience" section herein and thereupon, the rights and obligations of the District and the Contractor shall be determined in accordance with the "Termination of Contractor for Convenience" section herein.

23.1.3. Effect of Termination

23.1.3.1. Contractor shall, only if ordered to do so by the District, immediately remove from the Site all or any materials and personal property belonging to Contractor that have not

been incorporated in the construction of the Work, or which are not in place in the Work. District retains the right, but not the obligation, to keep and use any materials and personal property belonging to Contractor that have not been incorporated in the construction of the Work, or which are not in place in the Work. Contractor and its Surety shall be liable upon the performance bond for all damages caused the District by reason of the Contractor's failure to complete the Contract.

23.1.3.2. In the event that the District shall perform any portion of, or the whole of the Work, pursuant to the provisions of the General Conditions, the District shall not be liable nor account to the Contractor in any way for the time within which, or the manner in which, the Work is performed by the District or for any changes the District may make in the Work or for the money expended by the District in satisfying claims and/or suits and/or other obligations in connection with the Work.

23.1.3.3. In the event that the Contract is terminated for any reason, no allowances or compensation will be granted for the loss of any anticipated profit by the Contractor or any impact or impairment of Contractor's bonding capacity.

23.1.3.4. If the expense to the District to finish the Work exceeds the unpaid Contract Price, Contractor and Surety shall pay difference to District within twenty-one (21) days of District's request.

23.1.3.5. Assignment and Assumption of Subcontracts. District shall have the right (but shall have no obligation) to assume and/or assign to a general contractor or construction manager or other third party who is qualified and has sufficient resources to complete the Work, the rights of the Contractor under its subcontracts with any or all Subcontractors. In the event of an assumption or assignment by the District, no Subcontractor shall have any claim against the District or third party for Work performed by Subcontractor or other matters arising prior to termination of the Contract. The District or any third party, as the case may be, shall be liable only for obligations to the Subcontractor arising after assumption or assignment. Should the District so elect, the Contractor shall execute and deliver all documents and take all steps, including the legal assignment of its contractual rights, as the District may require, for the purpose of fully vesting in the District the rights and benefits of its Subcontractor under Subcontracts or other obligations or commitments. All payments due the Contractor hereunder shall be subject to a right of offset by the District for expenses and damages suffered by the District as a result of any default, acts, or omissions of the Contractor. Contractor must include this assignment provision in all of its contracts with its Subcontractors.

23.1.3.6. The foregoing provisions are in addition to and not in limitation of any other rights or remedies available to District.

23.2. Emergency Termination of Public Contracts Act of 1949

23.2.1. The Contract is subject to termination as provided by sections 4410 and 4411 of the Government Code of the State of California, being a portion of the Emergency Termination of Public Contracts Act of 1949.

23.2.1.1. Section 4410 of the Government Code states:

In the event a national emergency occurs, and public work, being performed by contract, is stopped, directly or indirectly, because of the freezing or diversion of materials, equipment or labor, as the result of an order or a proclamation of the President of the United States, or of an order of any federal authority, and the circumstances or conditions are such that it is impracticable within a reasonable time to proceed with a substantial portion of the work,

then the public agency and the contractor may, by written agreement, terminate said contract.

23.2.1.2. Section 4411 of the Government Code states:

Such an agreement shall include the terms and conditions of the termination of the contract and provision for the payment of compensation or money, if any, which either party shall pay to the other or any other person, under the facts and circumstances in the case.

23.2.2. Compensation to the Contractor shall be determined at the sole discretion of District on the basis of the reasonable value of the Work done, including preparatory work. As an exception to the foregoing and at the District's discretion, in the case of any fully completed separate item or portion of the Work for which there is a separate previously submitted unit price or item on the accepted Schedule of Values, that price shall control. District, in its sole discretion, may adopt the Contract Price as the reasonable value of the Work performed or any portion thereof.

23.3. Termination of Contractor for Convenience

23.3.1. District in its sole discretion may terminate the Contract upon three (3) days written notice to the Contractor. Under a termination for convenience, the District retains the right to all the options available to the District if there is a termination for cause. In case of a termination for convenience, Contractor shall have no claims against the District except:

23.3.1.1. The actual cost for labor, materials, and services performed that is unpaid and can be documented through timesheets, invoices, receipts, or otherwise, and

23.3.1.2. Five percent (5%) of the total cost of work performed as of the date of termination, or five percent (5%) of the value of the Work yet to be performed, whichever is less. This five percent (5%) amount shall be full compensation for all Contractor's and its Subcontractor(s)' mobilization and/or demobilization costs and any anticipated loss profits resulting from termination of the Contractor for convenience.

23.4. Suspension of Work

23.4.1. District may, without cause, order Contractor in writing to suspend, delay or interrupt the Project in whole or in part for such period of time as District may determine. When the District resumes the Project, the Parties will attempt to negotiate an adjustment in the Contract Price for increases or decreases in the cost of performance of the Project caused by suspense, delay or interruption. If the Parties cannot agree on an adjusted Contract Price, the District may terminate the Contract as permitted herein.

23.4.2. In the event the District shall order suspension of the Work, an adjustment shall be made to the Contract Price for increases in the direct cost of performance of the Work of the Contract Documents, actually caused by suspension, delay or interruption ordered by the District; provided however that no adjustment of the Contract Price shall be made to the extent: (i) that performance is, was or would have been so suspended, delayed or interrupted by another cause for which the Contractor is responsible under the Contract Documents; or (ii) that an equitable adjustment is made or denied under another provision of the Contract Documents. The foregoing notwithstanding, any adjustment of the Contract Price shall not include any adjustment to increase the Contractor's overhead, general administrative costs or profit, all of which will remain as reflected in the Schedule of Values submitted by the Contractor pursuant to the Contract Documents. In the event of the District's suspension of the Work, the Contract Time shall be equitably adjusted.

23.5. Scope Reduction

In cases of suspension, partial or complete termination, or at the discretion of the District, the District reserves the right to unilaterally approve a deductive Change Order to reduce scope of work or perform work with other forces or its own forces.

24. CLAIMS RESOLUTION

24.1. Exclusive Remedy.

24.1.1. Compliance with the claim resolution process and timelines described in this Claims Resolution section as well as the notice provisions of the Contract are express conditions precedent to Contractor's right to commence litigation or arbitration, file a claim under the California Government Code, or commence any other legal action related to the Project ("Claims Resolution Process").

24.1.2. Contractor acknowledges that its failure, for any reason, to provide written notice and all required supporting documentation to permit the District's review and evaluation within the time frame required by this Claims Resolution Process, shall be deemed Contractor's waiver, release, discharge and relinquishment of any right to assert, request, or demand any entitlement to an adjustment of the Contract Time or the contract Price on account of any instruction, request, drawings, specifications, action, condition, omission, default or other situation.

24.1.3. To the extent any provision(s) of this Claims Resolution Process conflict with or otherwise impair the timeframes and procedures of Public Contract Code section 9204, the provisions of Section 9204 shall control. If provisions of this Claims Resolution Process are supplementary and/or in addition to the requirements of Section 9204, but do not conflict with or otherwise impair the timeframes and procedures of Section 9204, the provisions of this Claims Resolution Process and the Contract shall control.

24.2. Performance during Claim Resolution Process.

The Contractor shall diligently proceed with Work on the Project at the same time that Claims are addressed under the Claims Resolution Process. It is the intent of District to resolve Claims with the Contractor as close to the events giving rise to the Claims as possible, and to avoid stale or late Claims and the late documenting of Claims. Contractor's failure to diligently proceed in accordance with the District's instructions or the Contract terms will be considered a material breach of the Contract and a waiver of Contractor's rights under this Contract.

24.3. Waiver.

If Contractor fails to timely submit any written notices required under the terms of the Contract or in this Claims Resolution section, Contractor waives and releases its rights regarding further review of its Claim, unless Contractor and District mutually agree in writing to other time limits.

24.4. Intention.

The Claims Resolution Process required herein is intended to provide a concise mechanism for resolving Claims as they arise during the Project, while requiring accurate documentation related to contested issues as to those Claims that are not contemporaneously resolved.

24.5. Other Provisions.

If portions of the Contract, other than this Claims Resolution Process, establish a specific process regarding a specific subject, then that process shall govern and control the resolutions of any disagreements thereunder. Otherwise, the provisions in this Claims Resolution Process shall control the resolution of all Claims.

24.6. Claim Presentation

24.6.1. Claim: A claim is a written demand by Contractor (or by Contractor on behalf of a Subcontractor) that the Contractor must submit by **registered mail or certified mail return receipt requested** for:

24.6.1.1. An extension to the Contract Time, including relief from damages or penalties assessed by the District for delay;

24.6.1.2. Payment of money or damages arising from work done by, or on behalf of, the Contractor pursuant to the Contract and payment that is not otherwise expressly provided for in the Contract Documents or the Contractor is not otherwise entitled; or

24.6.1.3. Payment that is disputed by the District.

(“Claim”)

24.6.2. A PCO may be a Claim, but the Parties agree that a PCO shall only be a Claim if:

24.6.2.1. The District states in writing that it disagrees with the terms of a PCO and directs the Contractor to utilize the Claim Resolution Process, or

24.6.2.2. The District rejects in whole or in part a PCO and the Contractor states in writing that it is utilizing the Claim Resolution Process for the portion of the PCO that the District rejected.

24.6.3. Subcontractor Claims.

24.6.3.1. Public Contract Code section 9204(d)(5) states that the Contractor may present to the District a Claim on behalf of a Subcontractor or lower tier Subcontractor. A Subcontractor may request in writing, either on his or her own behalf or on behalf of a lower tier Subcontractor, that the Contractor present a claim for Work which was performed by the Subcontractor or by a lower tier Subcontractor on behalf of the Subcontractor. The Subcontractor requesting that the Claim be presented to the District shall furnish reasonable documentation to support the Claim. Within 45 days of receipt of this written request, the Contractor shall notify the Subcontractor in writing as to whether the Contractor presented the claim to the District and, if the Contractor did not present the Claim, provide the Subcontractor with a statement of the reasons for not having done so.

24.6.3.2. Contractor is responsible for providing this Claims Resolution Process to its Subcontractors and for ensuring that all Subcontractors or others who may assert Claims by and through Subcontractors and/or the Contractor are informed of this Claims Resolution Process. No Claim submitted by any party that fails to follow the provisions of this Claims Resolution Process will be considered. Contractor shall indemnify, keep and hold harmless the District and its consultants, against all suits, claims, damages, losses, and expenses, including but not limited to attorney’s fees, caused by, arising out of, resulting from, or incidental to, the failure to provide this Claims Resolution Process to its Subcontractors or others who may assert Claims by and through Subcontractors and/or the Contractor.

24.6.4. Contractor Must Timely Identify, Present and Document Any Claim

24.6.4.1. Every Claim shall be stated with specificity in writing and signed by Contractor under penalty of perjury and presented to the District within ten (10) calendar days from the date Contractor discovers or reasonably should discover, that an act, error or omission of District, its agents or employees, or action, condition or other situation has occurred that may entitle

Contractor to make a Claim. This shall include the Contractor's actual or constructive knowledge of any instruction, request, drawings, specifications, action, condition, omission, default or other situation for which the contractor believes there should an adjustment of the Contract Price or Contract Time. Contractor shall provide this writing even if Contractor has not yet been damaged, delayed, or incurred extra cost when Contractor discovers, or reasonably should discover, the act, error, omission, action, condition or situation giving rise to the incidents giving rise to the Claim. The writing shall:

24.6.4.1.1. Identify all of the issues, events, conditions, circumstances and/or causes giving rise to the Claim;

24.6.4.1.2. Identify all pertinent dates and/or durations and all actual and/or anticipated effects on the Contract Price, milestones and/or Contract Time adjustments; and

24.6.4.1.3. Identify in detail line-item costs if the Claim seeks money.

24.6.4.1.4. If the Claim involves extra work, a detailed cost breakdown of the amounts the Contractor is seeking, including actual cost records (including without limitation, payroll records, material and rental invoices and the like) demonstrating that those costs have actually been incurred. To the extent costs have not yet been incurred at the time the Claim is submitted, actual cost records must be submitted on a current basis not less than once a week during any periods costs are incurred. A cost record will be considered current if submitted within seven (7) days of the date the cost reflected in the record is incurred. At the request of District, extra costs may be subject to further verification procedures (such as having an inspector verify the performance of alleged extra work on a daily basis).

24.6.4.1.5. If the Claim involves an error or omission in the Contract Documents:

24.6.4.1.5.1. An affirmative representation under penalty of perjury by Contractor and any affected Subcontractors and suppliers that the error or omission was not discovered prior to submitting a proposal for the Work, and

24.6.4.1.5.2. A detailed statement demonstrating that the error or omission reasonably should not have been discovered, by Contractor, its Subcontractors and suppliers, prior to submitting a proposal for the Work.

24.6.4.1.6. If the Claim involves a request for additional compensation for escalation of materials costs, then this provision exclusively governs those request(s) by Contractor and the following are **all** conditions precedent to Contractor's submission of a Change Order Request or Claim for additional compensation for escalation of materials costs.

24.6.4.1.6.1. Contractor shall not be entitled to submit a request for compensation for escalation of materials unless the actual increase in the cost of the materials in question exceeds ten percent (10%) of the **total** material costs on the Project at the time of bid.

24.6.4.1.6.2. The cost escalation is the result of unusual and unforeseeable market conditions not reasonably foreseeable at the time of award of the Contract and was not an escalated cost resulting from any action or inaction of the Contractor.

24.6.4.1.6.3. Contractor timely ordered and/or purchased the materials at issue, based on (1) Contractor's constructive knowledge of the supply chain for required materials and (2) Contractor's request to utilize the provisions in the Contract Documents related to the District's payment for materials and equipment purchased

and stored on Site or offsite.

24.6.4.1.6.4. Contractor's material costs were reasonable at the time of Contractor's bid for the Project.

24.6.4.1.6.5. Contractor demonstrates an actual increase in the cost of materials in its Contract Price at the time of award of the Contract and/or as reflected in Contractor's escrowed bid documents compared to Contractor's actual material payment cost paid either at time of purchase or delivery, whichever is earlier.

24.6.4.1.6.6. An actual year-to-date price increase has occurred and can be substantiated by the E.N.R. 20-City Average Material Cost Index for the material at issue that demonstrates the claim for an increase in price of the material at the time of delivery of the higher priced material to the Project.

24.6.4.2. The writing shall be accompanied by all documents substantiating Contractor's position regarding the Claim.

24.6.4.3. A Claim that asserts an effect on any schedule milestones and/or Contract Time shall include all pertinent scheduling data demonstrating the impact(s) on the critical path(s), milestone(s) and/or Contract Time.

24.6.4.4. Contractor agrees that it shall not base its damages, its calculations or its Claim on a "total cost" approach, a "modified total cost" approach or a "jury verdict method" approach.

24.6.5. Certification. Each copy of the Claim Documentation shall be certified by a responsible officer of the Contractor in accordance with the requirements of the Contract Documents. This certification shall be under penalty of perjury and must include the following language immediately above or before the Contractor's signature: ***"I declare under penalty of perjury under the laws of the State of California that the information provided and statements made in this Claim are true and correct, substantiated and of merit."*** The Contractor acknowledges that this requirement is not a mere formality but is intended to ensure that the Contractor only submits Claims that it believes are true and correct, substantiated and have merit. Should Contractor fail to submit the foregoing written statement signed under penalty of perjury, Contractor waives and releases its Claim, including all rights and remedies in connection therewith. This certification must include a certification of any portion of the Claim from Subcontractor(s) or others who are asserting Claims by and through Subcontractors and/or the Contractor

24.6.6. District's Written Statement/Decision on Claim. The District shall issue a written statement/decision regarding the Claim to the Contractor within forty-five (45) days of receipt of the written Claim from the Contractor, or three (3) days after the District's first regular governing board meeting after that 45-day period if the District's governing board does not meet within that first 45-day period. If the District fails to timely provide a written statement/decision regarding the Claim, the Claim shall be deemed rejected in its entirety.

24.6.7. Contractor Must Demand an Informal Meet and Confer Conference if Contractor Pursues Any Claim

24.6.7.1. FAILURE OF A CONTRACTOR TO TIMELY DEMAND A MEET AND CONFER CONFERENCE IS A WAIVER OF ITS RIGHT TO PURSUE ALL OR A PORTION OF ITS CLAIM.

24.6.7.2. Where There Is No Agreement: If there is no agreement between Contractor and the District on a Claim, then within ten (10) calendar days of the date of the District's written statement/decision in response to a Claim or PCO, if Contractor pursues that Claim, then

Contractor must demand, by **registered mail or certified mail return receipt requested**, a meet and confer conference with District staff. A meet and confer conference with District staff shall be a condition precedent to Contractor seeking any further relief, including a mediation as indicated below.

24.6.7.3. Where There Is Partial Agreement: If Contractor and the District partially agree on a Claim but do not reach complete agreement, then the Parties shall complete a Change Order, if applicable, for the issues and/or amounts agreed to. For those issues not agreed to, if Contractor pursues those issues from that Claim, then Contractor must demand, by **registered mail or certified mail return receipt requested**, a meet and confer conference with District staff regarding those issues. A meet and confer conference with District staff shall be a condition precedent to Contractor seeking any further relief, including a mediation as indicated below, in connection with the District's rejection.

24.6.7.4. Meet and Confer Conference. District and Contractor shall schedule the meet and confer conference as soon as reasonably possible after Contractor's written demand for a meet and confer conference, but in no case later than thirty (30) days after Contractor's demand.

24.6.7.5. District's Written Decision. Within ten (10) **business** days of the meet and confer conference, the District shall issue a written decision. If the District fails to timely provide a written statement/decision after the meet and confer conference, all Claim issues that were part of the meet and confer conference shall be deemed rejected in their entirety.

24.6.7.5.1. If the District's decision completely resolves the Claim, then the Parties shall complete a Change Order, if applicable, for the issues and/or amounts agreed to.

24.6.7.5.2. If the District rejects the Contractor's Claim in whole or in part or does not issue a timely written response, then the parties shall mediate the remaining issues of the Claim.

24.6.7.5.3. Contractor's costs incurred in seeking relief for Claims are not recoverable from District.

24.6.8. Mediation.

24.6.8.1. At the District's sole discretion, this mediation may be a multiple-party mediation with the Architect, the Construction Manager, the Inspector, and/or other District consultants.

24.6.8.2. The District and Contractor shall mutually agree to a mediator within ten (10) **business** days after the disputed portion of the Claim has been identified in writing. If the parties cannot agree upon a mediator, each party shall select a mediator and those mediators shall select a qualified neutral third party to mediate with regard to the disputed portion of the Claim. Each party shall bear the fees and costs charged by its respective mediator in connection with the selection of the neutral mediator.

24.6.9. Contractor's Obligation to File a Government Code Claim. Nothing in this Contract, including this Claims Resolution Process, waives, modifies or tolls the Contractor's obligation to present a timely claim under Government Code section 910, et seq. Therefore, in addition to complying with this Claims Resolution Process, the Contractor is required to present claims to the District pursuant to Government Code section 910, et seq. If after the requirements of this Claims Resolution Process are satisfied, and all or a portion of the Claim remains unresolved, and if the Government Code claim is rejected by the District, the Contractor may proceed under the post-mediation provisions of this Claims Resolution Process.

24.6.10. Post Mediation Provisions

24.6.10.1. Claims of \$375,000 or Less: The provisions of Public Contract Code § 20104.4 shall apply. Pursuant to Public Contract Code § 20104.4(a), within sixty (60) days, but no earlier than thirty (30) days, following the filing of responsive pleadings, the court shall submit the matter to nonbinding mediation unless waived by mutual stipulation of both parties. Pursuant to Public Contract Code § 9204(d)(2)(D), a mediation conducted pursuant to this Claims Resolution Process shall excuse the obligation under Public Contract Code § 20104.4(a) to mediate after litigation has been commenced unless otherwise agreed to by the parties in writing.

24.6.10.2. Litigation of Claims in Excess of \$375,000. If, after a mediation as indicated above, the Parties have not resolved the Claim, either Party may commence an action in a court of competent jurisdiction to contest that decision within ninety (90) days following the conclusion of that mediation or one (1) year following the accrual of the cause of action, whichever is later. By mutual agreement, the Parties can agree to instead resolve the Claim through arbitration.

24.6.11. The District shall be entitled to remedy any false claims, as defined in California Government Code section 12650 *et seq.*, made to the District by the Contractor or any Subcontractor under the standards set forth in Government Code section 12650 *et seq.* Any Contractor or Subcontractor who submits a false claim shall be liable to the District for three times the amount of damages that the District sustains because of the false claim. A Contractor or Subcontractor who submits a false claim shall also be liable to the District for (a) the costs, including attorney fees, of a civil action brought to recover any of those penalties or damages, and (b) a civil penalty of up to \$11,000 for each false claim. In addition, Contractor may be subject to criminal prosecution under California Penal Code §72 and/or civil liability under False Claims Act. If so, the District may be entitled to recover its costs incurred to investigate any False Claim, including but not limited to attorneys' fees and expert fees incurred in connection with that investigation.

24.7. Documentation of Resolution.

If a Claim is resolved, the District shall determine if that resolution shall be documented in an Agreement and Release of Any and All Claims form or other document, as appropriate.

24.8. Claim Resolution Process – Non-Applicability.

The procedures and provisions in this Claims Resolution section shall **not** apply to:

24.8.1. District's determination of what Work is or will be constructed, or whether the Work complies with the Contract Documents for purposes of accepting the Work;

24.8.2. District's rights and obligations as a public entity, such as, but without limitation, the revocation of prequalified or qualified status, barring a contractor from District contracts, the imposition of penalties or forfeitures prescribed by statute or regulation; provided, however, that penalties imposed against a public entity by statutes such as Public Contract Code section 7107, shall be subject to the mandatory dispute resolution provisions of this Claims Resolution section and the Contract;

24.8.3. Personal injury, wrongful death or property damage claims;

24.8.4. Latent defect or breach of warranty or guarantee to repair;

24.8.5. Stop notices or stop payment notices; or

24.8.6. Any other District rights as set forth herein.

24.9. The District's failure to respond to a Claim from the Contractor within the time periods described herein or to otherwise meet the time requirements of Public Contract Code section 9204 shall automatically result in the Claim being deemed rejected in its entirety, with no admission by the District as to the merits of the Claim.

24.10. If District fails to timely issue payment for any Claim or portion of a Claim as required pursuant to these Claim Resolution Procedures, the Contractor is permitted to assess interest indicated in Public Contract Code section 9204. Notwithstanding this provision, and in accordance with Public Contract Code section 7107, the District is entitled to withhold up to 150% of disputed amounts and the District shall not be liable for payment of interest on such disputed amounts pending final adjudication of such disputes.

25. LABOR, WAGE & HOUR, APPRENTICE AND RELATED PROVISIONS

25.1. Contractor & Subcontractor Registration

25.1.1. Contractor shall comply with the registration and compliance monitoring provisions of Labor Code section 1771.4, including furnishing its CPRs to the Labor Commissioner of California and complying with any applicable enforcement by the Department of Industrial Relations. Labor Code section 1771.1(a) states the following:

“A contractor or subcontractor shall not be qualified to bid on, be listed in a bid proposal, subject to the requirements of Section 4104 of the Public Contract Code, or engage in the performance of any contract for public work, as defined in this chapter, unless currently registered and qualified to perform public work pursuant to Section 1725.5. It is not a violation of this section for an unregistered contractor to submit a bid that is authorized by Section 7029.1 of the Business and Professions Code or by Section 10164 or 20103.5 of the Public Contract Code, provided the contractor is registered to perform public work pursuant to Section 1725.5 at the time the contract is awarded.”

25.1.2. Contractor acknowledges that, for purposes of Labor Code section 1725.5, all or some of the Work is a public work to which Labor Code section 1771 applies. Contractor shall comply with Labor Code section 1725.5, including without limitation the registration requirements. Additionally, all Contractor's Subcontractors shall comply with Labor Code section 1725.5 to be qualified to bid on, be listed in a bid proposal, subject to the requirements of Section 4104 of the Public Contract Code, or engage in the performance of the Contract. Contractor represents that all of its Subcontractors are registered pursuant to Labor Code section 1725.5.

25.1.3. The Project is subject to compliance monitoring and enforcement by the Department of Industrial Relations. Contractor shall post job site notices, as prescribed by regulation. Contractor shall comply with all requirements of Labor Code section 1771.4, except the requirements that are exempted by the Labor Commissioner for the Project.

25.2. Wage Rates, Travel and Subsistence

25.2.1. Pursuant to the provisions of article 2 (commencing at section 1770), chapter 1, part 7, division 2, of the Labor Code of California, the general prevailing rate of per diem wages and the general prevailing rate for holiday and overtime work in the locality in which this public work is to be performed for each craft, classification, or type of worker needed to execute this Contract are on file at the District's principal office and copies will be made available to any interested party on request and are available to any interested party on request or at www.dir.ca.gov/oprl/statistics_and_databases.html. Contractor shall obtain and post a copy of these wage rates at the job site.

25.2.2. Holiday and overtime work, when permitted by law, shall be paid for at a rate of at least one and one-half times the above specified rate of per diem wages, unless otherwise specified. The holidays upon

which those rates shall be paid need not be specified by the District, but shall be all holidays recognized in the applicable collective bargaining agreement. If the prevailing rate is not based on a collectively bargained rate, the holidays upon which the prevailing rate shall be paid shall be as provided in Section 6700 of the Government Code.

25.2.3. Contractor shall pay and shall cause to be paid each worker engaged in Work on the Project not less than the general prevailing rate of per diem wages determined by the Director of the Department of Industrial Relations (“DIR”) (“Director”), regardless of any contractual relationship which may be alleged to exist between Contractor or any Subcontractor and such workers.

25.2.4. If during the period this bid is required to remain open, the Director determines that there has been a change in any prevailing rate of per diem wages in the locality in which the Work under the Contract is to be performed, such change shall not alter the wage rates in the Invitation to Bid or the Contract subsequently awarded.

25.2.5. Pursuant to Labor Code section 1775, Contractor shall, as a penalty to District, forfeit the statutory amount, (currently not to exceed two hundred dollars (\$200) for each calendar day, or portion thereof), for each worker paid less than the prevailing rates, as determined by the District and/or the Director, for the work or craft in which that worker is employed for any public work done under Contract by Contractor or by any Subcontractor under it.

25.2.5.1. The amount of the penalty shall not be less than forty dollars (\$40) for each calendar day, or portion thereof, unless the failure of Contractor was a good faith mistake and, if so, the error was promptly and voluntarily corrected when brought to the attention of Contractor.

25.2.5.2. The amount of the penalty shall not be less than eighty dollars (\$80) for each calendar day or portion thereof, if Contractor has been assessed penalties within the previous three (3) years for failing to meet Contractor’s prevailing wage obligations on a separate contract, unless those penalties were subsequently withdrawn or overturned.

25.2.5.3. The amount of the penalty may not be less than one hundred twenty dollars (\$120) for each calendar day, or portion thereof, if the Labor Commissioner determines the Contractor willfully violated Labor Code section 1775.

25.2.5.4. The difference between such prevailing wage rates and the amount paid to each worker for each calendar day or portion thereof for which each worker was paid less than the prevailing wage rate, shall be paid to each worker by Contractor.

25.2.6. Any worker employed to perform Work on the Project, which Work is not covered by any classification listed in the general prevailing wage rate of per diem wages determined by the Director, shall be paid not less than the minimum rate of wages specified therein for the classification which most nearly corresponds to Work to be performed by him, and such minimum wage rate shall be retroactive to time of initial employment of such person in such classification.

25.2.7. Pursuant to Labor Code section 1773.1, per diem wages are deemed to include employer payments for health and welfare, pension, vacation, travel time, subsistence pay, and apprenticeship or other training programs authorized by section 3093, and similar purposes.

25.2.8. Contractor shall post at appropriate conspicuous points on the Site of Project, a schedule showing all determined minimum wage rates and all authorized deductions, if any, from unpaid wages actually earned. In addition, Contractor shall post a sign-in log for all workers and visitors to the Site, a list of all subcontractors of any tier on the Site, and the required Equal Employment Opportunity poster(s).

25.3. Hours of Work

25.3.1. As provided in article 3 (commencing at section 1810), chapter 1, part 7, division 2, of the Labor Code, eight (8) hours of labor shall constitute a legal days work. The time of service of any worker employed at any time by Contractor or by any Subcontractor on any subcontract under this Contract upon the Work or upon any part of the Work contemplated by this Contract shall be limited and restricted by Contractor to eight (8) hours per day, and forty (40) hours during any one week, except as hereinafter provided. Notwithstanding the provisions hereinabove set forth, Work performed by employees of Contractor in excess of eight (8) hours per day and forty (40) hours during any one week, shall be permitted upon this public work upon compensation for all hours worked in excess of eight (8) hours per day at not less than one and one-half times the basic rate of pay.

25.3.2. Contractor shall keep and shall cause each Subcontractor to keep an accurate record showing the name of and actual hours worked each calendar day and each calendar week by each worker employed by Contractor in connection with the Work or any part of the Work contemplated by this Contract. The record shall be kept open at all reasonable hours to the inspection of District and to the Division of Labor Standards Enforcement of the DIR.

25.3.3. Pursuant to Labor Code section 1813, Contractor shall as a penalty to the District forfeit the statutory amount (believed by the District to be currently twenty five dollars (\$25)) for each worker employed in the execution of this Contract by Contractor or by any Subcontractor for each calendar day during which such worker is required or permitted to work more than eight (8) hours in any one calendar day and forty (40) hours in any one calendar week in violation of the provisions of article 3 (commencing at section 1810), chapter 1, part 7, division 2, of the Labor Code.

25.3.4. Any Work necessary to be performed after regular working hours, or on Sundays or other holidays shall be performed without additional expense to the District.

25.4. Payroll Records

25.4.1. Contractor and all Subcontractors must comply with the compliance monitoring provisions of Labor Code section 1771.4, including furnishing its certified payroll records ("CPR(s)") to the Labor Commissioner of California and complying with any applicable enforcement by DIR. Labor Code section 1771.4 requires Contractor and Subcontractors to provide electronic copies of CPRs to the Labor Commissioner of California at least once every thirty (30) days, and within thirty (30) days of Project Completion. The failure to timely provide the CPRs could result in penalties as determined by Labor Code section 1771.4, applicable laws, and regulations

25.4.2. If requested by the District, Contractor shall provide to the District and shall cause each Subcontractor performing any portion of the Work to provide the District and an accurate CPR(s), showing the name, address, social security number, work classification, straight time, and overtime hours worked each day and week, and the actual per diem wages paid to each journeyman, apprentice, worker, or other employee employed by the Contractor and/or each Subcontractor in connection with the Work.

25.4.3. In addition to any other requirements pursuant to Labor Code sections 1770, et seq., the CPRs enumerated hereunder shall be certified and shall be provided to the District on a weekly basis. The CPRs from the Contractor and each Subcontractor for each week shall be provided on or before Wednesday of the week following the week covered by the CPRs. District shall not make any payment to Contractor until:

25.4.3.1. Contractor and/or its Subcontractor(s) provide CPRs acceptable to the District, and

25.4.3.2. The District is given sufficient time to review and/or audit the CPRs to

determine their acceptability. Any delay in Contractor and/or its Subcontractor(s) providing CPRs to the District in a timely manner will directly delay the District's review and/or audit of the CPRs and Contractor's payment.

25.4.4. All CPRs shall be available for inspection at all reasonable hours at the principal office of Contractor on the following basis:

25.4.4.1. A certified copy of an employee's CPR shall be made available for inspection or furnished to the employee or the employee's authorized representative on request.

25.4.4.2. CPRs shall be made available for inspection or furnished upon request to a representative of District, Division of Labor Standards Enforcement, Division of Apprenticeship Standards, and/or the Department of Industrial Relations.

25.4.4.3. CPRs shall be made available upon request by the public for inspection or copies thereof made; provided, however, that a request by the public shall be made through either the District, Division of Apprenticeship Standards, or the Division of Labor Standards Enforcement. If the requested CPRs have not been provided pursuant to the provisions herein, the requesting party shall, prior to being provided the records reimburse the costs of preparation by Contractor, Subcontractors, and the entity through which the request was made. The public shall not be given access to the records at the principal office of Contractor.

25.4.5. The form of certification for the CPRs shall be as follows:

I, _____ (Name-Print), the undersigned, am the _____
_____ (Position in business) with the authority to act for and on behalf of _____
_____ (Name of business and/or Contractor), certify under penalty of perjury that the records or copies thereof submitted and consisting of _____
(Description, number of pages) are the originals or true, full, and correct copies of the originals which depict the payroll record(s) of actual disbursements by way of cash, check, or whatever form to the individual or individual named, and (b) we have complied with the requirements of sections 1771, 1811, and 1815 of the Labor Code for any work performed by our employees on the Project.

Date: _____ Signature: _____
(Section 16401 of Title 8 of the California Code of Regulations)

25.4.6. Each Contractor shall file a certified copy of the CPRs with the entity that requested the records within ten (10) days after receipt of a written request.

25.4.7. Any copy of records made available for inspection as copies and furnished upon request to the public or any public agency by District, Division of Apprenticeship Standards, or Division of Labor Standards Enforcement shall be marked or obliterated in such a manner as to prevent disclosure of an individual's name, address, and social security number. The name and address of Contractor awarded Contract or performing Contract shall not be marked or obliterated.

25.4.8. Contractor shall inform District of the location of the records enumerated hereunder, including the street address, city, and county, and shall, within five (5) Business Days, provide a notice of change of location and address.

25.4.9. In the event of noncompliance with the requirements of this section, Contractor shall have ten (10) days in which to comply subsequent to receipt of written notice specifying in what respects Contractor must comply with this section. Should noncompliance still be evident after the ten (10) day period, Contractor shall, as a penalty to District, forfeit one hundred dollars (\$100) for each calendar day,

or portion thereof, for each worker, until strict compliance is effectuated. Upon the request of Division of Apprenticeship Standards or Division of Labor Standards Enforcement, these penalties shall be withheld from progress payments then due.

25.4.10. It shall be the responsibility of Contractor to ensure compliance with the provisions of Labor Code section 1776.

25.5. Apprentices

25.5.1. Contractor acknowledges and agrees that, if this Contract involves a dollar amount greater than or a number of working days greater than that specified in Labor Code section 1777.5, then this Contract is governed by the provisions of Labor Code Section 1777.5. It shall be the responsibility of Contractor to ensure compliance with this Article and with Labor Code section 1777.5 for all apprenticeship occupations.

25.5.2. Apprentices of any crafts or trades may be employed and, when required by Labor Code section 1777.5, shall be employed provided they are properly registered in full compliance with the provisions of the Labor Code.

25.5.3. Every apprentice shall be paid the standard wage paid to apprentices under the regulations of the craft or trade at which the apprentice is employed, and shall be employed only at the work of the craft or trade to which the apprentice is registered.

25.5.4. Only apprentices, as defined in section 3077 of the Labor Code, who are in training under apprenticeship standards and written apprentice agreements under chapter 4 (commencing at section 3070), division 3, of the Labor Code, are eligible to be employed. The employment and training of each apprentice shall be in accordance with the provisions of the apprenticeship standards and apprentice agreements under which the apprentice is training.

25.5.5. Pursuant to Labor Code section 1777.5, if that section applies to this Contract as indicated above, Contractor and any Subcontractors employing workers in any apprenticeable craft or trade in performing any Work under this Contract shall apply to the applicable joint apprenticeship committee for a certificate approving the Contractor or Subcontractor under the applicable apprenticeship standards and fixing the ratio of apprentices to journeymen employed in performing the Work.

25.5.6. Pursuant to Labor Code section 1777.5, if that section applies to this Contract as indicated above, Contractor and any Subcontractor may be required to make contributions to the apprenticeship program.

25.5.7. If Contractor or Subcontractor willfully fails to comply with Labor Code section 1777.5, then, upon a determination of noncompliance by the Administrator of Apprenticeship, it shall:

25.5.7.1. Be denied the right to bid on any subsequent project for one (1) year from the date of such determination;

25.5.7.2. Forfeit as a penalty to District the full amount as stated in Labor Code section 1777.7. Interpretation and enforcement of these provisions shall be in accordance with the rules and procedures of the California Apprenticeship Council and under the authority of the Chief of the Division of Apprenticeship Standards.

25.5.8. Contractor and all Subcontractors shall comply with Labor Code section 1777.6, which section forbids certain discriminatory practices in the employment of apprentices.

25.5.9. Contractor shall become fully acquainted with the law regarding apprentices prior to commencement of the Work. Special attention is directed to sections 1777.5, 1777.6, and 1777.7 of the

Labor Code, and title 8, California Code of Regulations, section 200 et seq. Questions may be directed to the State Division of Apprenticeship Standards, 455 Golden Gate Avenue, San Francisco, California 94102.

25.5.10. Contractor shall ensure compliance with all certification requirements for all workers on the Project including, without limitation, the requirements for electrician certification in Labor Code sections 108, et seq.

25.6. Non-Discrimination

25.6.1. Contractor herein agrees not to discriminate in its recruiting, hiring, promotion, demotion, or termination practices on the basis of race, religious creed, national origin, ancestry, sex, age, or physical handicap in the performance of this Contract and to comply with the provisions of the California Fair Employment and Housing Act as set forth in part 2.8 of division 3 of the California Government Code, commencing at section 12900; the Federal Civil Rights Act of 1964, as set forth in Public Law 88-352, and all amendments thereto; Executive Order 11246, and all administrative rules and regulations found to be applicable to Contractor and Subcontractor.

25.6.2. Special requirements for Federally Assisted Construction Contracts: During the performance of this Contract, Contractor agrees to incorporate in all subcontracts the provisions set forth in Chapter 60-1.4(b) of Title 41 published in Volume 33 No. 104 of the Federal Register dated May 28, 1968.

25.7. Labor First Aid

Contractor shall maintain emergency first aid treatment for Contractor's workers on the Project which complies with the Federal Occupational Safety and Health Act of 1970 (29 U.S.C. § 651 et seq.) the California Occupational Safety and Health Act of 1973, and all related regulations, including without limitation section 330 et seq. of Title 8 of the California Code of Regulations.

26. MISCELLANEOUS

26.1. Assignment of Antitrust Actions

26.1.1. Section 7103.5(b) of the Public Contract Code states:

In entering into a public works contract or subcontract to supply goods, services, or materials pursuant to a public works contract, the Contractor or subcontractor offers and agrees to assign to the awarding body all rights, title, and interest in and to all causes of action it may have under Section 4 of the Clayton Act (15 U.S.C. Sec. 15) or under the Cartwright Act (Chapter 2 (commencing with Section 16700) of Part 2 of Division 7 of the Business and Professions Code), arising from purchases of goods, made and become effective at the time the awarding body tenders final payment to the Contractor, without further acknowledgment by the parties.

26.1.2. Section 4552 of the Government Code states:

In submitting a bid to a public purchasing body, the bidder offers and agrees that if the bid is accepted, it will assign to the purchasing body all rights, title, and interest in and to all causes of action it may have under Section 4 of the Clayton Act (15 U.S.C. Sec. 15) or under the Cartwright Act (Chapter 2 (commencing with Section 16700) of Part 2 of Division 7 of the Business and Professions Code), arising from purchases of goods, materials, or services by the bidder for sale to the purchasing body pursuant to the bid. Such assignment shall be made and become effective at the time the purchasing body tenders final payment to the bidder.

26.1.3. Section 4553 of the Government Code states:

If an awarding body or public purchasing body receives, either through judgment or settlement, a monetary recovery for a cause of action assigned under this chapter, the assignor shall be entitled to receive reimbursement for actual legal costs incurred and may, upon demand, recover from the public body any portion of the recovery, including treble damages, attributable to overcharges that were paid by the assignor but were not paid by the public body as part of the bid price, less the expenses incurred in obtaining that portion of the recovery.

26.1.4. Section 4554 of the Government Code states:

Upon demand in writing by the assignor, the assignee shall, within one year from such demand, reassign the cause of action assigned under this part if the assignor has been or may have been injured by the violation of law for which the cause of action arose and (a) the assignee has not been injured thereby, or (b) the assignee declines to file a court action for the cause of action.

26.1.5. Under this Article, “public purchasing body” is District and “bidder” is Contractor.

26.2. **Excise Taxes**

If, under Federal Excise Tax Law, any transaction hereunder constitutes a sale on which a Federal Excise Tax is imposed and the sale is exempt from such Federal Excise Tax because it is a sale to a State or Local Government for its exclusive use, District, upon request, will execute documents necessary to show (1) that District is a political subdivision of the State for the purposes of such exemption, and (2) that the sale is for the exclusive use of District. No Federal Excise Tax for such materials shall be included in any Contract Price.

26.3. **Taxes**

Contract Price is to include any and all applicable sales taxes or other taxes that may be due in accordance with section 7051 of the Revenue and Taxation Code; Regulation 1521 of the State Board of Equalization or any other tax code that may be applicable.

26.4. **Shipments**

All shipments must be F.O.B. destination to Site or sites, as indicated in the Contract Documents. There must be no charge for containers, packing, unpacking, drayage, or insurance. The total Contract Price shall be all inclusive (including sales tax) and no additional costs of any type will be considered.

26.5. **Compliance with Government Reporting Requirements**

If this Contract is subject to federal or other governmental reporting requirements because of federal or other governmental financing in whole or in part for the Project which it is part, or for any other reason, Contractor shall comply with those reporting requirements at the request of the District at no additional cost.

END OF DOCUMENT

DOCUMENT 00 71 00

SPECIAL CONDITIONS

1. **Site Specific Conditions**

- a. **Access.** Access to the school buildings and entry to buildings, classrooms, restrooms, mechanical rooms, electrical rooms, or other rooms, for construction purposes, must be coordinated with District and onsite District personnel before Contractor commences Work. Unless agreed to otherwise in writing, only a school custodian will be allowed to unlock and lock doors in existing building(s). The custodian will be available only while school is in session. If a custodian is required to arrive before 7:00 a.m. or leave after 3:30 p.m. to accommodate Contractor's Work, the overtime wages for the custodian will be paid by Contractor, unless, at the discretion of District, other arrangements are made in advance.
- b. **Master Key.** Upon request, District may, at its own discretion, provide a master key to the school site for the convenience of Contractor. Contractor agrees to pay all expenses to re-key the entire school site and all other affected District buildings if the master key is lost or stolen or if any unauthorized party obtains a copy of the key or access to the school.
- c. **Maintaining Services.** Contractor is advised that Work is to be performed in spaces regularly scheduled for instruction. Interruption and/or periods of shutdown of public access, electrical service, water service, lighting, or other utilities shall be only as arranged in advance with District. Contractor shall provide temporary services to all facilities interrupted by Contractor's Work.
- d. **Maintaining Utilities.** Contractor shall maintain in operation during term of Contract, drainage lines, storm drains, sewers, water, gas, electrical, steam, and other utility service lines within working area.

2. **Insurance Policy Limits.** Contractor's insurance shall be with insurance companies with an A.M. Best rating of no less than B+ The limits of insurance shall not be less than:

Commercial General Liability	Includes: Bodily Injury, Property Damage, Personal & Advertising Injury, Product Liability and Completed Operations	\$1,000,000 each occurrence; \$2,000,000 general aggregate
Automobile Liability – Any Auto	Combined Single Limit	\$1,000,000 per occurrence
Excess Liability (Umbrella)		\$2,000,000 per occurrence; \$2,000,000 aggregate
Workers Compensation		Statutory limits pursuant to State law
Employers' Liability		\$1,000,000 each incident, each disease; \$1,000,000 policy limit

END OF DOCUMENT

SECTION 11 61 14

ORCHESTRA SHELL TOWERS & WALL PANELS

PART 1 - GENERAL

1.1 SUMMARY

A. Section Includes:

1. Services as listed herein and related to the provision and installation of orchestra shell towers. Towers shall match ceiling clouds provided in base construction contract.
2. The Orchestra Shell Contractor shall provide all items necessary for a complete, safe, fully functional system as described herein, including all tools, scaffolding, labor, and supervision, even though they may not be specifically enumerated.
3. Contractor shall inform themselves of the current state of construction, project drawings, and shop drawings. Contractor shall survey all relevant areas to verify critical dimensions, clear heights and storage areas prior to submittals of shop drawings.

B. Base building contract drawings and trade shop drawings can be made available upon request.

1.2 RELATED SECTIONS

A. Review the work of the following base building sections in carrying out this work:

1. Floor and adjacent architectural finishes

1.3 SCHEDULE

A. See Division 1 for project delivery schedules.

1.4 REFERENCES

- A. Comply with all national, state and local regulations. In the event of conflict between these specifications and the applicable regulations, the more stringent shall govern.
- B. Equipment shall be provided per the related trade and regulatory guidelines including but not limited to UL, NEC, IEEE, and all manufacturer's recommendations and requirements. Contractor shall be responsible in the event that work under their control voids or jeopardizes manufacturers' warranties.
- C. Labor shall be provided per applicable labor regulations and practices.

1.5 DEFINITIONS

- A. District Representative: For the scope in this Section, authorized personnel representing the District and The Shalleck Collaborative, Inc., Theatre Consultants.

1.6 SYSTEM DESCRIPTION

A. Provide Orchestra Shell Towers

1. Orchestra shell towers shall have integral seismic tethers with custom overhead anchorage.
2. The shell towers shall have integral zero-throw casters for positioning.
 - a) Separate shell movers are not acceptable.
3. The shell towers shall have curved wing panels as shown on the drawings in the appendix.

B. Orchestra shell wall panels

1. Provide wall panels which will mount to the existing P1000 Unistrut, as shown on drawings, to the rear wall of the stage.
2. Rear wall panels shall be provided with backbox and wiring to accept pathway lighting fixtures, provided by owner, for field installation. It is under the work of this section to provide contract with a qualified field electrician to install fixtures and terminate wiring to the provided building connection points.

1.7 SCHEDULE

- A. See Division 1 for overall schedule.

1.8 SUBSTITUTIONS

- A. All requests for substitutions from the specified materials, assemblies or related services shall be submitted for review by the District's Representative at least (13) days prior to bid. Substitution requests made after bid shall be neither reviewed nor accepted. Requests shall be made in a timely fashion so as to not affect the project schedule in either case of the substitution being accepted or rejected.
- B. Documentation for the substitution shall be submitted with supporting material and shall include the related information for the item as specified so that equivalence can be demonstrated. The burden of proof rests solely upon the Contractor. The District's Representative shall be the sole evaluator of the fitness of the substitution.
- C. All expenses related to the substitution including, but not be limited to, all fees and expenses incurred in the evaluation of the substitution, and any effect on the costs and schedule of other trades whether or not the substitution is accepted, shall be borne by the Contractor.
- D. See Section 00 73 00 Special Conditions for additional requirements.

1.9 SUBMITTALS

- A. Submittals shall be made in accordance with Division 1.
- B. Submittals shall be made electronically in PDF format except where noted otherwise.
 - 1. Hard copy submittals shall be made upon request of the District's Representative.
 - 2. Samples, color cards and color swatches shall not be electronic.
- C. Submittals shall be made in a timely fashion so as to not affect the project schedule, and shall allow adequate time for review and resubmittal. Partial submittals shall not be acceptable and shall be returned without review.
- D. Complete shop drawings and relevant calculations shall be fully engineered and bear the stamp of a Professional Structural Engineer licensed in the state of CA.
- E. Submittals shall be reviewed and field dimensions verified prior to commencing acquisition for, and fabrication of the work in this section. All services and parts of the work in this section shall be verified through the submittal process. Approval does not relieve the Contractor of the responsibility of providing equipment in accordance with the specifications.
- F. Shop Drawings:
 - 1. Submit component and installation drawings and schedules showing all information necessary to fully explain the design features, wiring, appearance, function, fabrication, installation, and use of system components in all phases of operation.
 - 2. Shop drawing plans and section shall be at 1/4" scale minimum. Details shall be larger scales to fully explain the component.
 - 3. Include a simplified reflected ceiling plan showing dimensional information of extents of ceiling panels with orchestra shell towers for layout info only.
 - 4. Provide clear space on all shop drawings for comments and approval stamps.
 - 5. Shop drawings shall show shell fitting within storage requirements.
 - 6. Shop drawings shall show finish grain or pattern direction, as applies to laminate surfaces.
 - 7. Dimensions: submit shop drawings illustrating field verification of dimensions. Dimension needing field verifications include (but are not limited to):
 - 8. Any dimensions listed as "V.I.F." on the attached drawings
 - 9. Distances between shell ceiling battens, as well as between the shell battens and the nearest catwalk hanger or other physical obstruction on both the upstage and downstage sides of the shell slot openings.
 - 10. All shop drawings shall be submitted electronically.
- G. Product Data:
 - 1. Submit data sheets for all standard component parts, which shall include all information necessary to verify compliance with this Section.
 - 2. Product data shall properly identify each component's intended use. Any options or variations must be clearly noted.

H. Finish Selection:

1. Within two weeks of award of the contract contractor shall submit full finish selection cards or samples for review and selection by the District's Representative.

I. Samples:

1. Upon 14 days of request by the District's Representative, submit samples for review. Samples may include, but are not limited to:
 - a. Plastic laminate color/pattern selector chip. Chips shall be actual finish product and not a facsimile.
 - b. 2" section of finished trim strip.
 - c. 12" x 12" sample of the panel assembly with the inset trim channel detail.

J. Record Documents:

1. At time of final acceptance, submit regulatory listings and certifications as required by prevailing building codes.
2. Within 30 days, submit record documents as (3) three hard copies and one electronic copy in PDF format on CD or USB memory stick. Hardcopies shall be delivered in a 3-ring binder. Flame certificates, warranty and any instruction booklets shall be in clear plastic sleeves.

1.10 WARRANTY

- A. Warranty shall provide coverage of material and product defects and assembly workmanship for a period of five years following the date of acceptance by the District.
- B. Items under warranty shall be serviced to the satisfaction of the District with 14 days of notification to the Contractor, except for safety related items, which shall be corrected within 48 hours of notification.

1.11 QUALITY ASSURANCE

- A. Equipment in this Section shall be provided by specialty contractors and manufacturers meeting the qualifications listed herein.
- B. Specialty contractor responsible for installation in the field shall have been continuously engaged in the sales and integration of orchestra shell equipment similar to that specified herein for a minimum of (15) fifteen years, and shall have successfully completed at least twenty (20) installations of this type and scope. The District's Representative shall be the final judge of the suitability of experience and past performance.
 1. Manufacturer shall have been continuously engaged in the manufacturing of orchestra shell equipment similar to that specified herein for a minimum of (20) years.
- C. Specialty contractors shall have at time of bid and continuously maintain throughout the project and warranty period any contractor's license required in the state of the project appropriate for the work in this Section.
- D. All equipment shall be UL listed and bear the appropriate labels.

1.12 DELIVERY, STORAGE AND HANDLING

- A. Packing shall prevent damage to the equipment during transit. Costs to repair or replace all equipment damaged during the course of the contract services shall be borne by the Contractor.
- B. Do not deliver materials in this Section until building is ready for installation. Contractor is responsible to properly sequence the work and to protect from damage during delivery, handling, storage and installation.
- C. Contractor is responsible to coordinate and provide secure and protected storage as required for the execution of the Contract.

1.13 PROJECT CONDITIONS

- A. Defects in the field which may impact the work in this Section shall be reported to the District's Representative and corrected in accordance with the requirements of the applicable Section of work prior to commencement of the work in this Section.
- B. Field Conditions: All bidders shall fully inform themselves of the conditions under which the work is to be performed. No additional compensation shall be allowed for any labor or item the bidder could have been fully informed of prior to the bid date.

1.14 MAINTENANCE

- A. Provide maintenance stock of User-serviceable components within the system. Maintenance stock shall be packaged in labeled long term storage packaging and turned over to the District at time of system commissioning.
 - 1. Replacement caster of each type
 - 2. Replacement door latch system
 - 3. Replacement door stay system
 - 4. Replacement tether system
 - 5. Finish touch-up kit

PART 2 - PRODUCTS

2.1 PRE-APPROVED SPECIALTY MANUFACTURERS

- A. Requirements: reference section 116113.1.11.
- B. The following production systems specialty Manufacturers have been pre-approved for supplying the product and are not precluded for providing installation services:

Sightline Commercial Solutions
7008 Northland Drive
Minneapolis, MN 55428
Contact: Ray Byrnes
T: 619.550.6432
E-mail: rbyrnes@sightlinecommercial.com

Wenger Corporation
Contact: Jeff Kirkpatrick
555 Park Drive
Owatonna, MN 55060
T: 1-800-326-8373 ext: 260
E-mail: jeff.kirkpatrick@wengercorp.com

Stage Right
495 Pioneer Parkway
Clare, Michigan 48617
Contact: Kip Weis
T:800.438-4499 ext. 349
E-mail: kweis@stageright.com

- C. All other manufacturers must be approved prior to bid. Other manufacturers seeking acceptance must submit the following information at least (13) days prior to the bid opening date. Approval of contractors will be by addenda. Failure to submit any of the required information will automatically disqualify the contractor from consideration of approval.
 - 1. A listing of 20 equivalent completed installations including:
 - a) Name, address and telephone number of District;
 - b) Name, address and telephone number of Theatre Consultant;
 - c) Scope of work and dollar value.
 - 2. List of personnel who will be working on this job, including skills, experience, and accreditations.
 - 3. A brief written description of the contractor's operation including facilities, financial capabilities, and experience of key personnel.
 - 4. A statement from a bonding company agreeing to provide the required bonds in the amount required for the project.
 - 5. Documentation necessary to show compliance with quality assurance section, 116113.1.11.

2.2 MATERIALS

- A. All components supplied under this Section shall be new. Used or factory reconditioned components shall not be acceptable.
- B. All structural framing shall be extruded aluminum components.
- C. All panels shall be constructed from rigid honeycomb core and hard panel stressed-skin surface.
 - 1. Finish of shall be standard high pressure plastic laminate
 - a. Shell finishes shall be
 - 1) Vertical grade high pressure laminate, matt finish
 - 2) or as required to match shell ceiling
 - b. Colors as follows:
 - 1) Formica #1545 Raw Cedar
 - 2) grain direction to run vertically
 - 3) or as required to match shell ceiling
 - c. All front surface panels shall be free of exposed fasteners.
 - d. Panel finishes shall match and be free of major variation.
 - 2. Finish of exposed framing shall be black.
 - 3. Core shall be 1-1/2" thick minimum honeycomb.
 - 4. Finish of exposed aluminum shall be painted black..
 - 5. Lamination shall be by means of permanently-cured urethane adhesive. Contact adhesive is not acceptable.
 - 6. Panels shall include integral extruded aluminum caps along the straight edges.
- D. Materials shall conform to the following ASTM and ANSI standard specifications:
 - 1. A-36 - Specification for structural steel
 - 2. A-47 -Specification for malleable iron casting
 - 3. A-48 - Specification for gray iron casting
 - 4. A-120 - Specification for black and hot-dipped zinc-coated (galvanized) steel pipe for ordinary use
 - 5. B18.2.1&2 - Specification for square and hex bolts and nuts
 - 6. B221-02 - Specification for aluminum alloy
- E. In order to establish minimum standards of safety, the following factors shall be used:
 - 1. Cables, hardware and fittings - 8:1 Safety Factor
 - 2. Cable bending ratio - Sheave tread diameter is 30 times cable diameter
 - 3. Steel – per AISC specifications
 - 4. Bolts - Minimum SAE J429 Grade 5 (ISO R898 Class 8.8), zinc plated
 - 5. Overhead lifting rings – Minimum Grade 80, alloy
- F. All turnbuckles, clips, tracks, chains and other items of incidental hardware shall be furnished plated or painted black.

- G. All nuts shall be new lock nuts or shall be provided with lockwashers. No exceptions.
- H. Fabrication:
 - 1. The mechanical fabrication and workmanship shall incorporate best practices for good fit and finish. There shall be no burrs or sharp edges to cause a hazard nor shall there be any sharp corners accessible to personnel.
 - 2. All moving parts shall have specified tolerances.
 - 3. All equipment shall be built and installed to facilitate future maintenance and replacement.
- I. Recommended Working Load: This specification calls for minimum recommended working loads for hardware. The manufacturer's recommended working load is the maximum load which the manufacturer recommends be applied to properly installed, maintained, and operated new equipment. Manufacturer's recommended working loads shall be determined by calculations by a Licensed Professional Engineer and destructive testing by an independent testing laboratory. These calculations and reports shall be available for review.

2.3 SHELL WALL TOWERS

A. Configuration

- 1. Each tower shall consist of one center panel and two adjustable wing panels.
- 2. Lower wing panels include doors.
- 3. Door shall have a minimum opening clearance of 36". Adjacent doors shall allow access for concert grand piano.
- 4. Towers shall be moved through the use of permanently mounted casters. Air mover or traction drive mover not acceptable.
- 5. Tower face shall have shape as shown on drawings.
- 6. Mark each tower with its own 6" tall white letter on the back at about 6 feet above the floor so that it can be clearly seen.
- 7. Attach to the back of each tower a clear plastic laminated 11x17 plan of tower layout (showing all configurations) with each tower numbered.

B. Framework

- 1. Framework of towers shall be extruded aluminum alloy joined at connections by formed steel components.
- 2. Vertical frame shall be constructed of aluminum.
- 3. Horizontal frame shall be constructed of aluminum which shall join vertical frame members.

C. Base

- 1. Each tower shall be equipped with a counterweighted base assembly for stability.
- 2. Framework of base shall be aluminum alloy or steel joined at connections by formed steel components.

3. Counterweight shall be profiled steel plate. Weight shall be as required to counterbalance towers from overturning in the seismic zone of the Project.
4. Provide diagonal braces that shall ensure a perpendicular connection between base and tower frames, and distribute loads throughout the base assembly.
5. Provide 2 removable handles for moving the tower sections at the rear of the base above the counterweight.

D. Hardware

1. Casters
 - a. Provide non-marking fixed and orbital tri-casters in configurations as shown on drawings for all towers
 - b. Casters shall be steel ball bearing with steel housings, with treads appropriate for wood and concrete floors.
 - 1) Separated motive systems for towers are not acceptable.
2. Wing-stays
 - a. Telescoping wing-stay shall allow the locking of tower wings in performance or storage positions.
 - b. Wing-stay shall position wing panels at repeatable positions, and shall include locks operable from the floor.
3. Wing and Door Hinges
 - a. Wing and door panels shall be mounted to frame with split aluminum or steel hinges and shall include self-lubricating Delrin thrust and radial bearings.
4. Door Hardware
 - a. Doors shall feature a slide-lock mechanism to lock door to wing for use when transporting and storing towers.
 - b. Doors shall incorporate inside door handles.
5. Seismic tether system - Deployed
 - a. Provide 1/4" wire rope tethers that attach to the tops of the tower vertical tubes. Method of attachment shall be sufficient to resist the forces imposed by major seismic activity.
 - b. Wire rope assembly shall terminate in a thimble and copper swage sleeves.
 - c. Wire rope shall clip to eyebolt at 4'-0" above finished floor at rear of panel while not in use, so that when the handline (described below) is dropped from the walking surface above it may be attached to the wire rope and lifted up for attachment to structure.

- d. For each tower, provide 1/2" black synthetic hand line, 7,900 lbs. minimum breaking strength, one end with eye splice, locking carabiner and rope thimble and other end whipped and dipped. Multiline II, or equal. Provide in length sufficient to extend from 10'-0" above overhead walking surface to stage floor.
 - e. Provide storage bag or hook or other device for storage of hand line when not in use. At overhead walking surface provide tie point on Unistrut rigging beams, provide supplemental beams where required. Provide one 1.5" eye-bolt per tower, install on Unistrut overhead at each point of deployment for each configuration.
6. Wing bottom strip
- a. Provide 3/16" metal or UHMW edge strip on the bottom of the wing wall tht is 1/4" beyond the face of the wall. This is intended to be in contact with the wing wall guide at the storage zone to prevent the face of the tower wings from scraping along walls or impacting wall mounted equipment.
- E. Leveling
1. Each tower shall incorporate leveling adjustment means. Leveling shall hold positively and not be required to be re-set when the tower is moved.
- F. Storage
1. Each tower shall be designed to nest within another to minimize storage space, and shall fit within overall criteria shown on Drawings.
 2. Lower portion of center shell tower panel shall be removable to allow nesting of towers, as well as provide visual access for tower positioning.
 3. Removable panel shall be removable from the back side of the shell tower, or shall swing upward and lock in a storage position.
 4. If removable, the center panel shall store securely on the back side of the shell tower during storage and transport.
 5. The storage area of the shells shall be marked in yellow paint, designed for and suitable to floor marking, which shall endure the wear of heavy traffic.
 - a. The outline of the storage area shall be a 2" thick solid line.
 - b. The interior of the space shall be hatched with 1/2" thick solid lines.
 - c. The center of the area shall be painted with legible text, 4" character heights, with the phrase: "Shell Tower Storage Area".
 - d. Two (2) 1" thick dashed lines within the area to align the base unit centered in the area.
- G. Trim Strip
1. Provide rear mounted trim strip to prevent view to the hinges and backstage light from shining between panels of shell towers at hinges and seams between tower sections. Trim strips shall be provided as shown on drawings.
- H. Provide towers in the quantity as shown on the drawings.

1. Product shall be:
 - a. Crescendo or Bravado by Sightline Commercial
 - b. Maestro or Diva by Wenger
 - c. Opus II or equal by Stage Right

2.4 TOWER STORAGE AREA GUIDES

- A. Review field conditions prior to fabrication of the storage track components.
- B. Provide guide tracks, bump stops and tie downs for shell towers in storage zone.
- C. Guide track shall consist of 2 guides, one catching a front rigid caster, and one catching a guide point at the center of the rear of the base.
 1. Wheel Guide
 - a. Wheel guide shall be built of two angle sections of 2"x1" with 1" flange oriented upward, capturing a single front rigging caster of each tower.
 - b. Inner walls of the track shall be 1/4" wider than a wheel and shall be lined with UHMW strip or other non-abrasive surface to protect the wheels from wear.
 - c. The outer track guide shall be straight and shall continue 2' beyond the tower stack, minimum, the Inner guide shall be straight to the point of the extent of the track and shall bend inward with a 3' radius to create a flared/conical catchment for wheel to enter guide.
 - d. Provide wedged blocking in track to stop the first tower at it's storage position.
 2. Center guide
 - a. Provide angle iron in floor of storage space, anchored to the concrete, with "leg up" to act as a fin/rail guide in the floor at/near the center of the tower wheel span.
 - b. Provide notched "guide rail shoe" of UHMW, below the tower framing at the rear of the rolling tower base.
 - c. Provide rear stop in floor or angle iron or wood and rubber pad, to stop first tower from impacting the walls.
 3. Side wall protection
 - a. Provide angle iron or wood side rails with UHMW strip to, aligned with the metal trim at the base of the wood wall, to prevent wings which are not compacted from impacting or scraping walls or wall mounted devices.
 4. Seismic Restraint - Storage
 - a. Provide two seismic restraints for use when the tower is in storage.
 - b. Provide soft, wide restraint, non-abrasive and non-marking, such as a span set or other nylon strap, to span between points.
 - c. Attachment points shall be using painted steel plates with D-ring, anchored into wall structure (studs or backing spanning studs on wall surface).

- d. Restraint straps shall be placed just above and just below the center point of gravity. Provide means of adjustment if necessary.
5. Paint
 - a. Paint all guide components on the floor bright yellow.

2.5 ORCHESTRA SHELL WALL PANELS

A. Configuration

1. Orchestra shell wall panels shall match the form and finish of the shell towers, but shall be permanently mounted to Unistrut provided at the rear wall of the stage (Unistrut is installed under the base construction contract).
2. Wall panels shall be provided with radiused panels, and installed to mimic the appearance of adjacent towers.

B. Wall Panel Lighting

1. Wall panels shall have integral lighting fixtures mounted where shown on drawings.
2. The lighting fixtures shall be provided by the owner and may need to be removed from the current housing in the rear wall.
3. Provide new housings within the panel to accept the lighting fixtures, housings shall be the specific back boxes from the fixtures manufacturer.
 - 1) Housing shall exist within a recess, centered on the panel and 18" above the finished floor. Adjust height downward if in conflict with rear Unistrut.
 - 2) Construct a flat plane in the recess no larger than 1/2" beyond the rim of the fixture, and as close to the front as possible. Finish black.
 - 3) Trim the cut edge of the shell panel and the cutout wall reveals.
4. Fixtures shall connect to the building wiring using flexible metal conduit which shall terminate to a flush panel in the fixtures housing face. Assume a 15' flex conduit/wire length each for bidding with right angle connector to the faceplate.
5. Provide complete integration and installation services for these fixtures. Control will have already been programmed during the base construction process.
6. Product Data for the fixture type is available upon request to the architect.

- C. Provide wall panels in the quantity as shown on the drawings, and install in the locations indicated.

PART 3 - EXECUTION

3.1 PERFORMANCE OF THE WORK

- A. The Orchestra Shell Contractor shall be responsible for storage of stage equipment, tools, and equipment during the period of the installation.
- B. Extent: All specified equipment shall be installed by fully trained superintendents and workmen. Equipment shall be installed in a workman like manner, per plans and specifications. Equipment shall be aligned, adjusted, and trimmed for the most efficient operation, the greatest safety and for the best visual appearance.
- C. Standards: Installation practices shall be in accordance with OSHA Safety and Health Standards and all local codes. All welding must be performed in full compliance with the latest edition of the Structural Welding Code (ANSI/AWS D1.1).
- D. Attachments: All equipment shall be securely attached.
- E. Finishes:
 - 1. All welds must be touched up to match disturbed finishes.
 - 2. All finishes which are disturbed during shipping and installation shall be touched up to match the original.

3.2 CLEAN UP

- A. The Contractor shall be responsible for clean up, including removal of packing materials etc. and the protection of surfaces or equipment provided by other contractors.

3.3 INSPECTION AND TESTING

- A. Upon completion of the installation, the Contractor shall notify the District's Representative that the system is available for formal checkout. Notification shall be provided in writing. Checkouts shall be scheduled in accordance with the District's Representative's schedule.
- B. During the periods where movable systems are operated, the Theatre shall be quiet.
- C. Inspection shall include, but shall not be limited to:
 - 1. Visual observation and operation of all systems specified herein.
- D. Make available for review by the District's Representative:
 - 1. Access to all components for physical inspection.
 - 2. All systems shall be complete, and will be operated by the District's Representative for approval.
 - 3. Spare parts inventory.
- E. The Contractor shall be liable for any return visits by the specialty sub-contractor, factory engineer or District's Representative as a result of incomplete or incorrect installation, or erroneous representation that the systems are complete and ready for the related Contractor or District's representative to carry out their work.

3.4 TRAINING

- A. Upon final approval of the system by the District's Representative, representatives from the Orchestra Shell Contractor shall instruct designated District staff or representatives in the safe use and maintenance of all systems specified herein. Training shall include:
 - 1. Review of all instructional and maintenance documentation.
 - 2. Complete run-through of shell deployment from storage to performance position, and strike for storage.
- B. Schedule training sessions shall be scheduled in advance to the District staff or representatives' schedules. Training shall be 4 hours minimum.
- C. Note, Installation must be coordinated well in advance to work with Owners use schedule as the jobsite will be an active school facility at the time of installation.

3.5 APPENDIX

- A. Appendix A : 11 61 14 A1-A6 Orchestra Shell Towers
- B. This specification is incomplete without the drawings listed above.

END OF SECTION

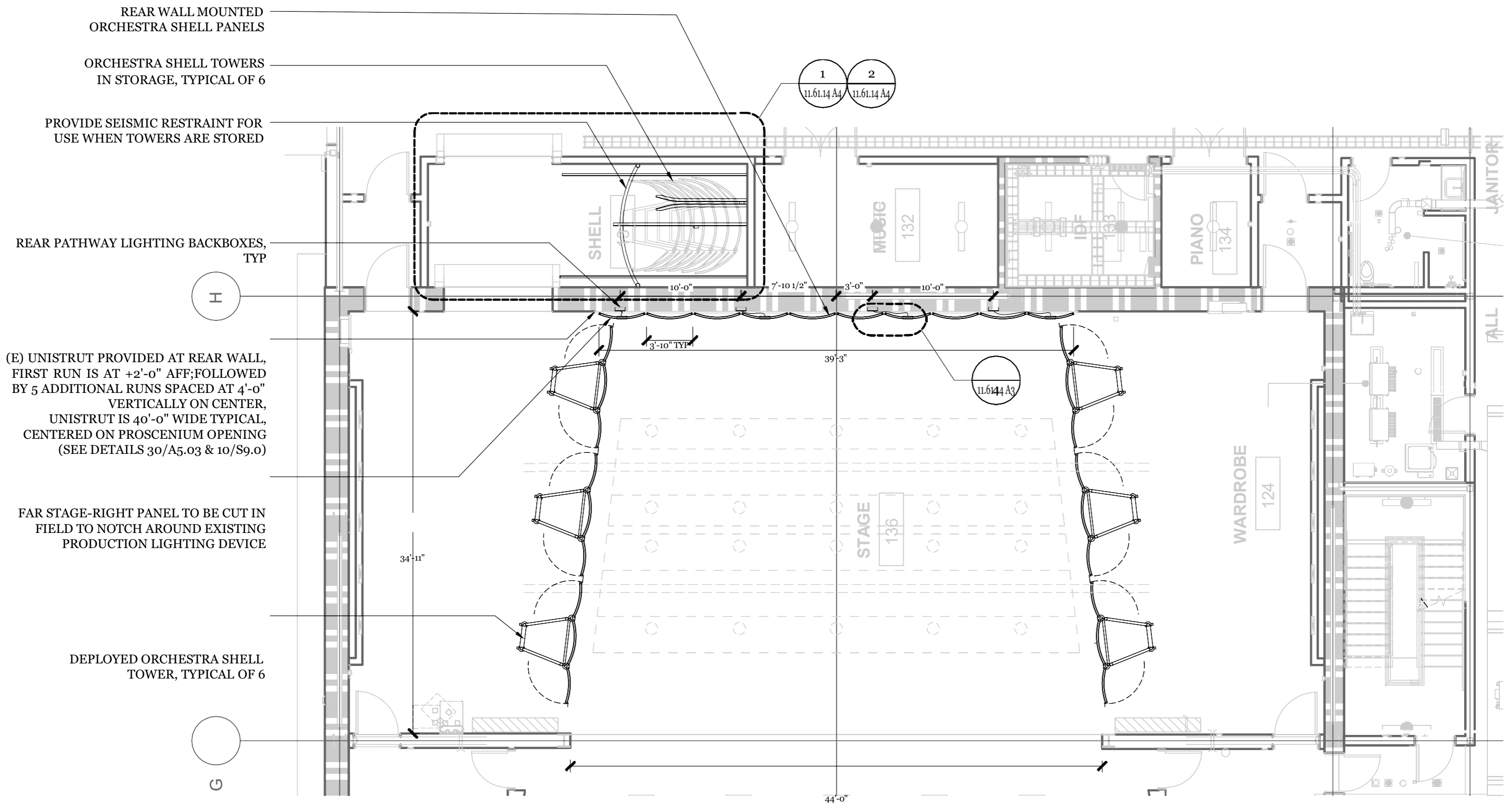

1 ORCHESTRA SHELL TOWERS
1/8" = 1'-0"

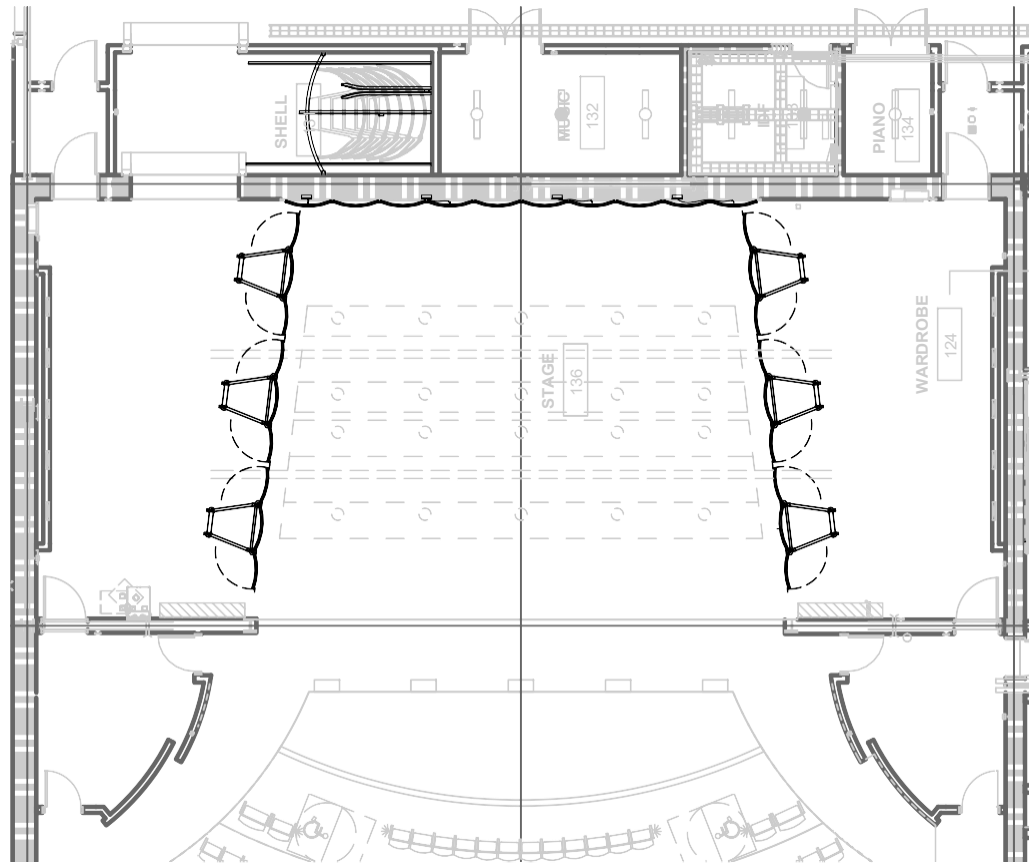

1 ORCHESTRA SHELL TOWER - CONFIG #1
1/16" = 1'-0"

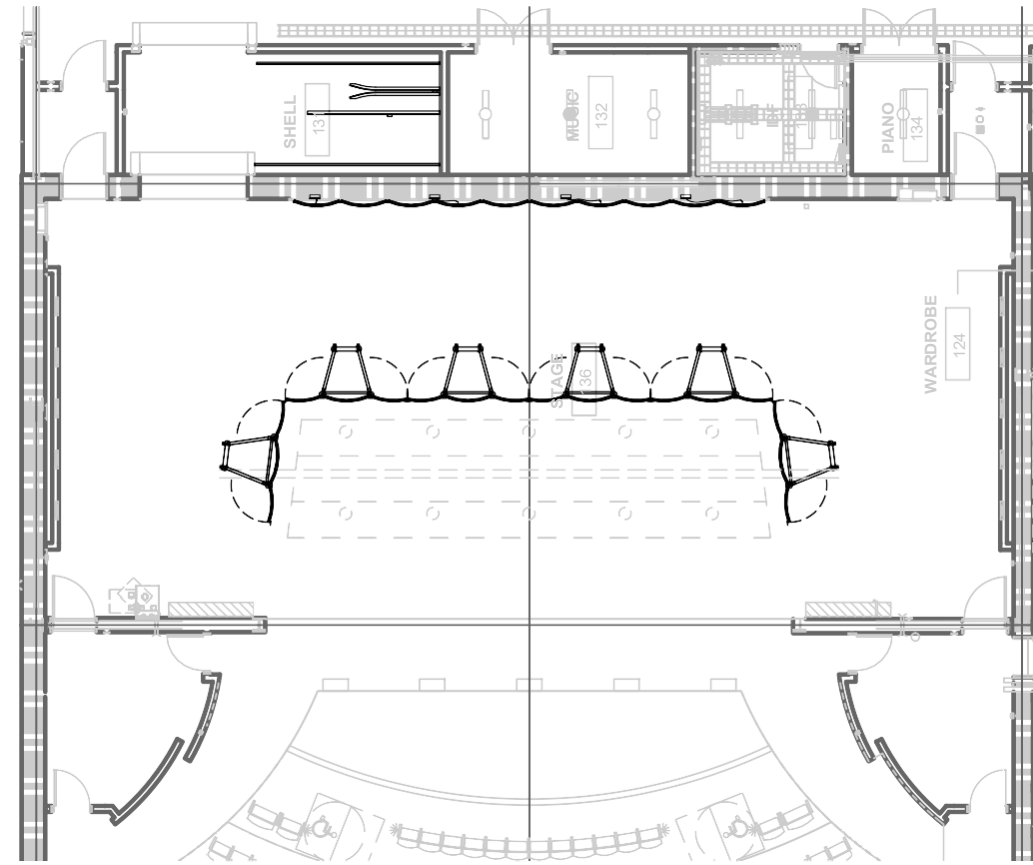

2 ORCHESTRA SHELL TOWER - CONFIG #2
1/16" = 1'-0"

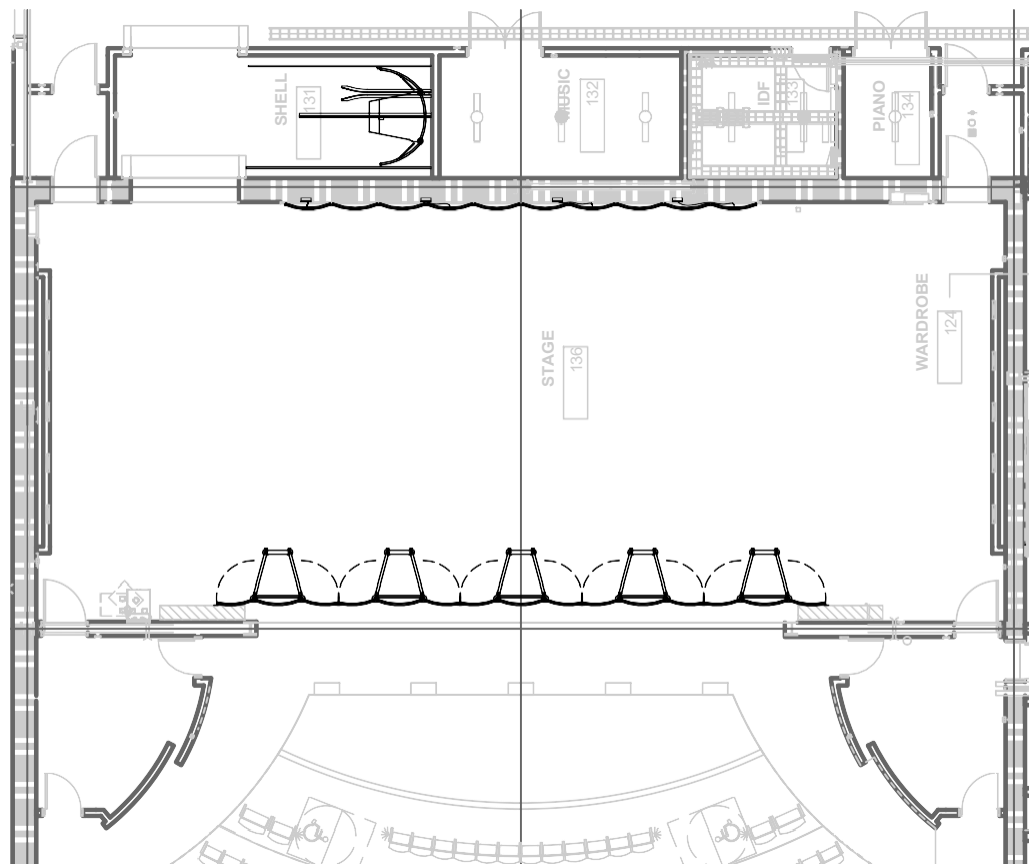

3 ORCHESTRA SHELL TOWER - CONFIG #3
1/16" = 1'-0"

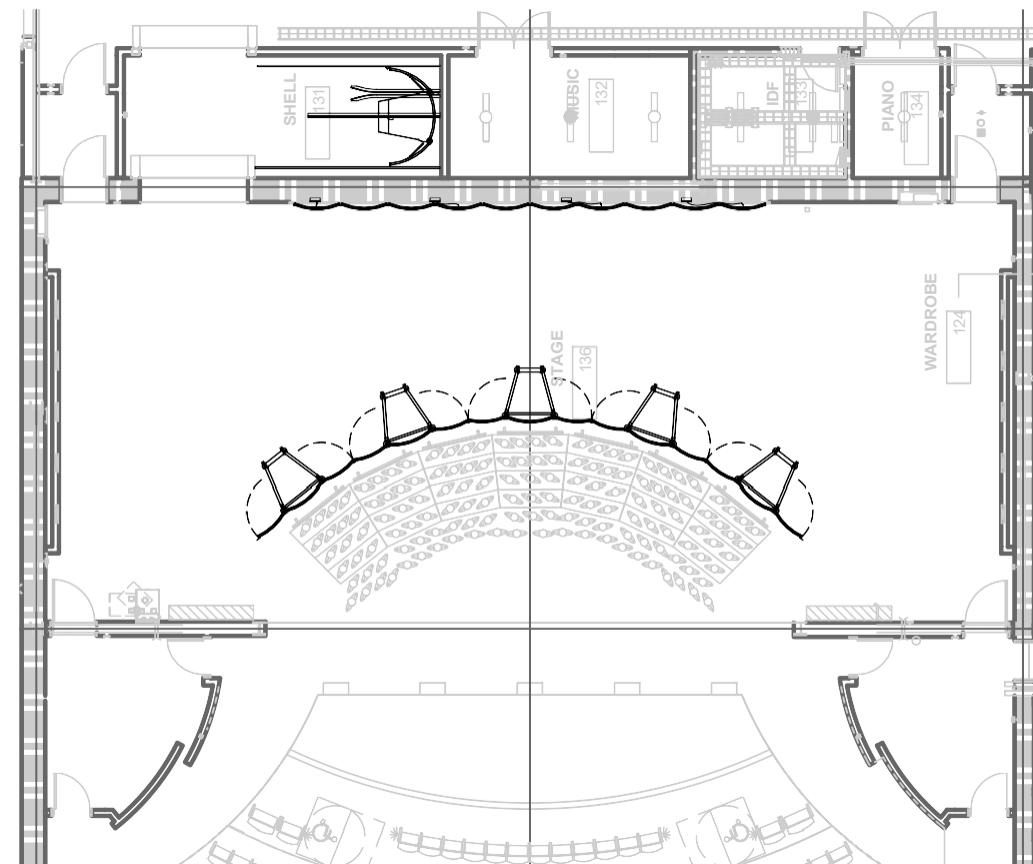

4 ORCHESTRA SHELL TOWER - CONFIG #4
1/16" = 1'-0"

HY HIBSER YAMAUCHI
Architects, Inc.
300 - 27th Street
Oakland, CA 94612
510.446.2222 tel | 510.446.2211 fax

Title: HAYWARD USD - ORCHESTRA SHELL TOWERS
Date: 2023-12-18
Scale: As Noted
Drawn By: ECC
Drawing Number:
11.61.14 A2

The Shalleck Collaborative Inc.
Planning and Design of Theatres | Production Systems | AV
1553 Martin Luther King Jr Way
Berkeley, CA 94709
tel 415-956-4100
www.shalleck.com

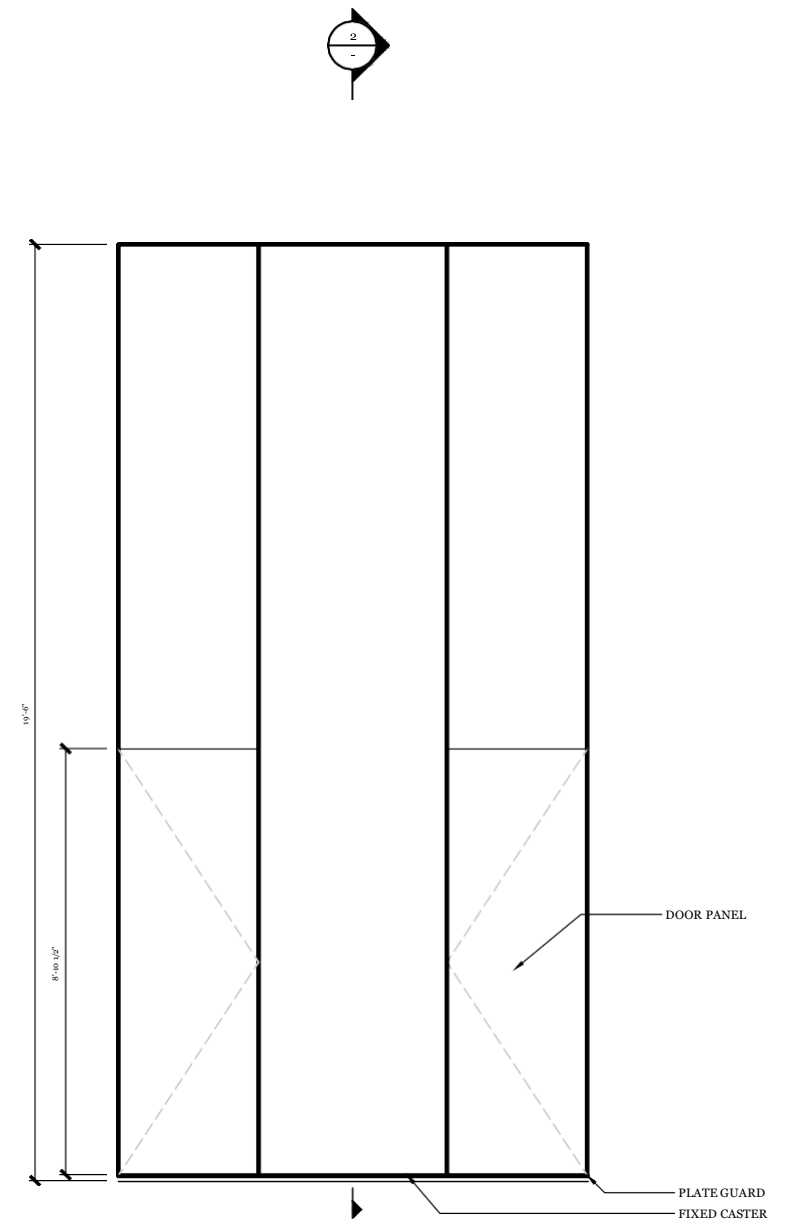
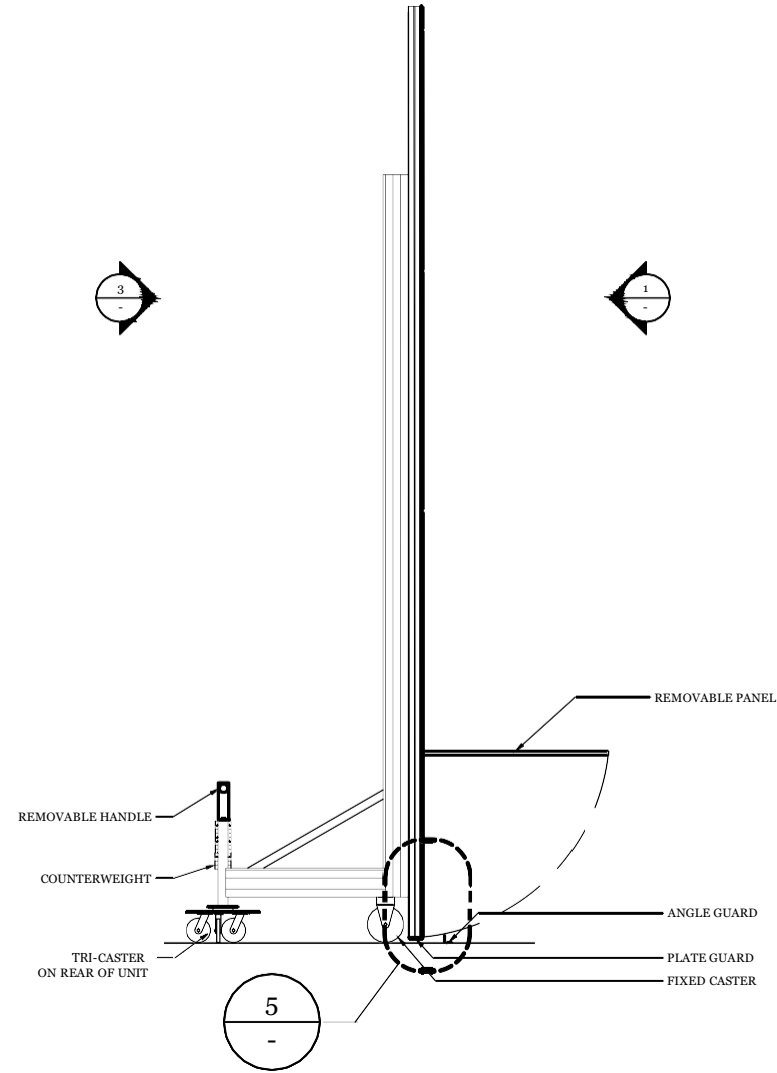
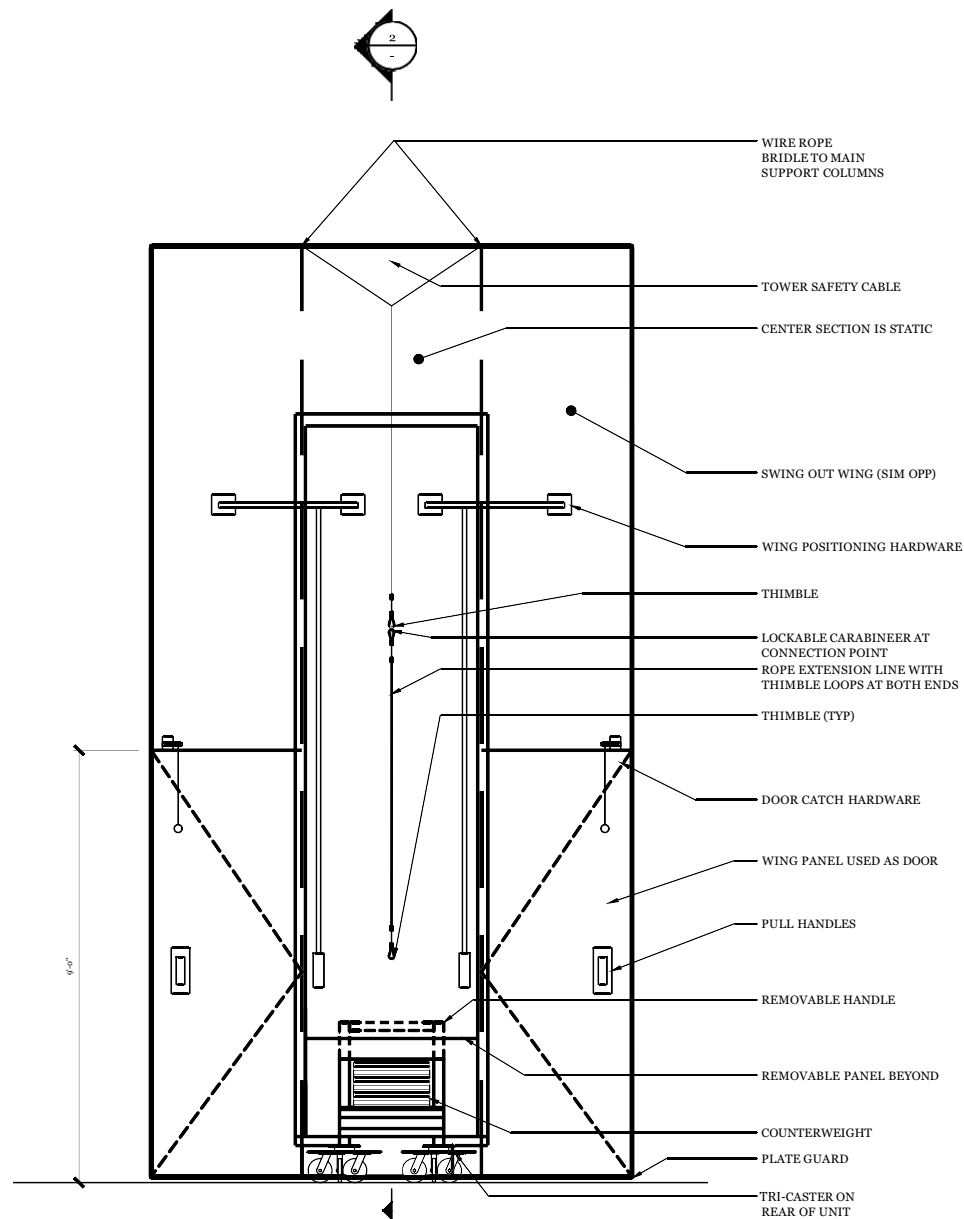

3 ORCHESTRA SHELL TOWER REAR ELEVATION
1/4" = 1'-0"

2 ORCHESTRA SHELL TOWER DETAIL SECTION
1/4" = 1'-0"

1 ORCHESTRA SHELL TOWER TYPICAL FRONT ELEVATION
1/4" = 1'-0"

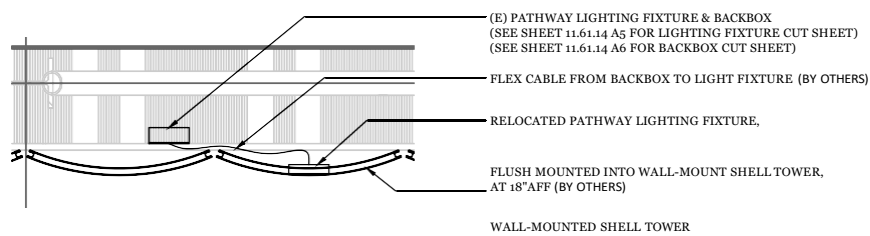

1" MAX GAP

1/4" PLATE GUARD OVERHANG

UHMW FACE ON GUARD TRACK
STEEL GUARD TRACK WITH UHMW FACE,
MOUNTED TO FLOOR
(SEE 2/11.61.14 A4 FOR PLAN LOCATIONS)
UHMW PLATE GUARD.

HY HIBSER YAMAUCHI
Architects, Inc.

300 - 27th Street
Oakland, CA 94612
510.446.2222 tel | 510.446.2211 fax

Title: HAYWARD USD - ORCHESTRA SHELL TOWERS

Date: 2023-12-18
Scale: As Noted
Drawn By: ECC

Drawing Number:
11.61.14 A3

4 LIGHT FIXTURE DETAIL
1-1/2" = 1'-0"

COORDINATE WITH DISTRICT'S ELECTRICAL
SUBCONTRACTOR FOR INSTALLATION OF LIGHT
FIXTURE IN PANELS.

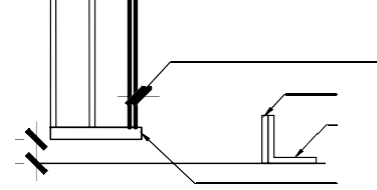

ATTACHED TO BOTTOM OF PANELS,
WITH 1/4" OVERHANG ON FRONT AND SIDES

5 PLATE GUARD DETAIL
1-1/2" = 1'-0"

The Shalleck Collaborative Inc.

Planning and Design of Theatres | Production Systems | AV

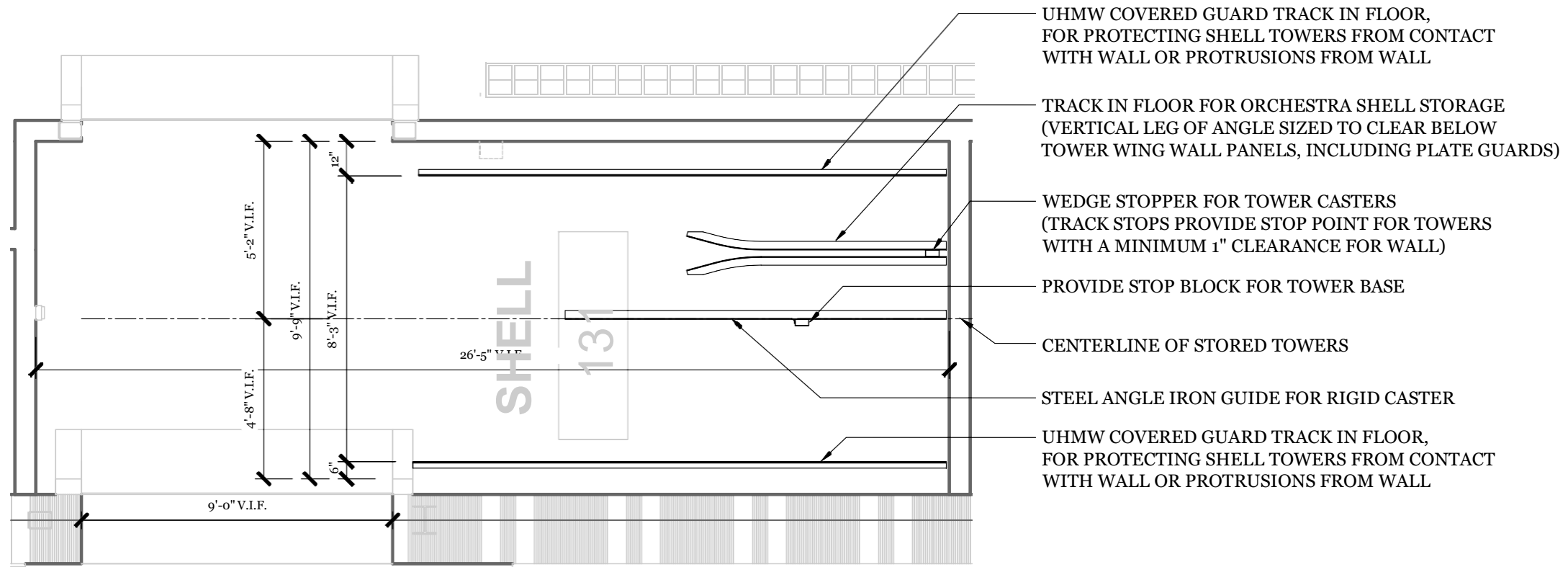

2 ORCHESTRA SHELL TOWER STORAGE TRACK DETAIL
 1/4" = 1'-0"

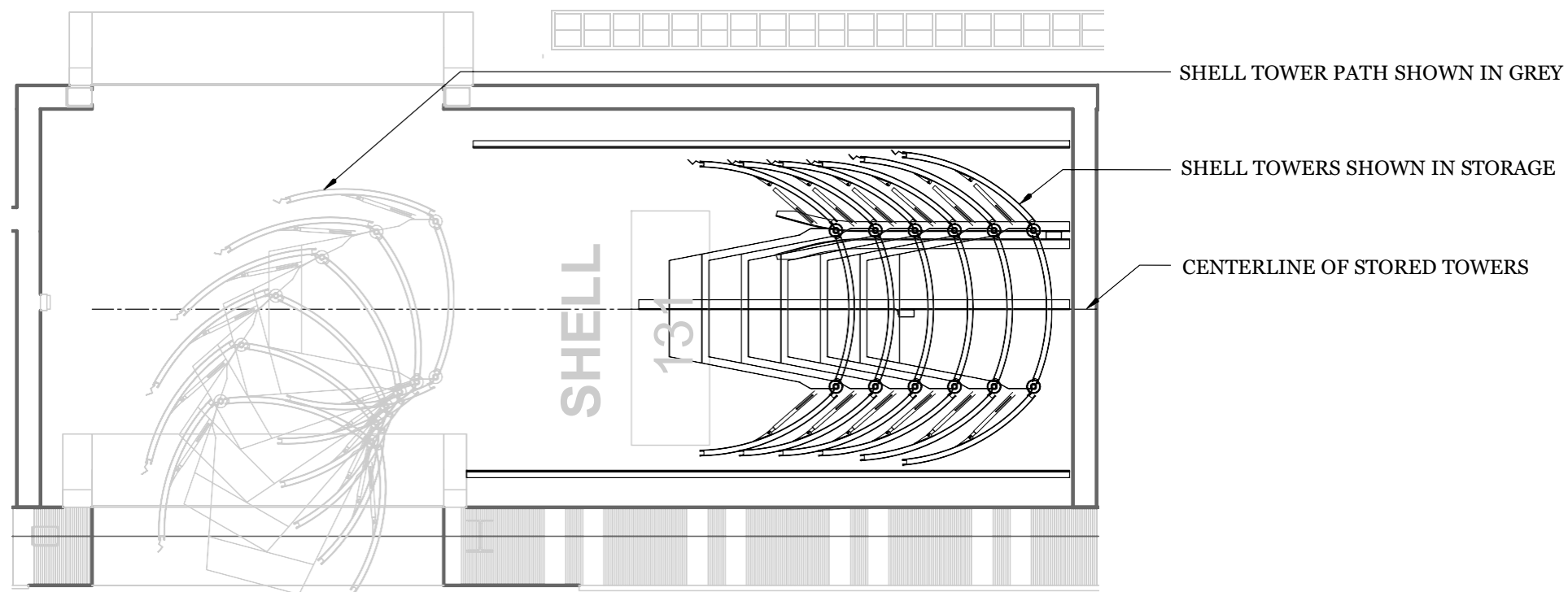

HY HIBSER YAMAUCHI
 Architects, Inc.
 300 - 27th Street
 Oakland, CA 94612
 510.446.2222 tel | 510.446.2211 fax
 Title: HAYWARD USD - ORCHESTRA SHELL TOWERS
 Date: 2023-12-18
 Scale: As Noted
 Drawn By: ECC
11.61.14 A4

1

ORCHESTRA SHELL TOWER STORAGE LAYOUT (6 TOWERS)

1/4" = 1'-0"

The **Shalleck Collaborative** Inc.

Planning and Design of Theatres | Production Systems | AV

LED recessed wall luminaires - shielded with louvers



Application
 LED recessed wall luminaire with unshielded light and louvers for use as location luminaires for means of way finding.

Materials
 Luminaire housing constructed of die-cast aluminum marine grade, copper free (≤ 0.3% copper content) A360.0 aluminum alloy
 White safety glass
 Silicone applied robotically to plasma treated casting for increased adhesion
 High temperature silicone gasket
 Mechanically captive stainless steel fasteners
 Stainless steel screw clamps
 Composite installation housing

NRTL listed to North American Standards, suitable for wet locations
 Protection class IP65
 Weight: 1.8 lbs

Electrical
 Operating voltage 120-277V AC
 Minimum start temperature -40° C
 LED module wattage 2.7 W
 System wattage 5.0 W
 Controllability 0-10V dimmable
 Color rendering index Ra > 80
 Luminaire lumens 44 lumens (3000K)
 Lifetime at Ta=15° C 120,000 h (L70)
 Lifetime at Ta=40° C 78,000 h (L70)

LED color temperature ADVISE
 2700K - Product number + K27
 3000K - Product number + K3
 3500K - Product number + K35
 4000K - Product number + K4

BEGA can supply you with suitable LED replacement modules for up to 20 years after the purchase of LED luminaires - see website for details

Finish ADVISE STANDARD FINISH
 All BEGA standard finishes are matte, textured polyester powder coat with minimum 3 mil thickness.

Available colors	Black (BLK)	White (WHT)	RAL:
	Bronze (BRZ)	Silver (SLV)	CUS:

Type:
BEGA Product:
Project:
Modified: BLUE LENS

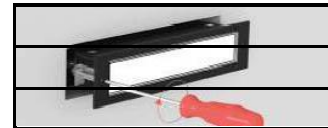

Fully enclosed luminaire with installation housing ensures seamless integration and weathertight operation.

Provide black finish

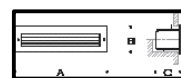
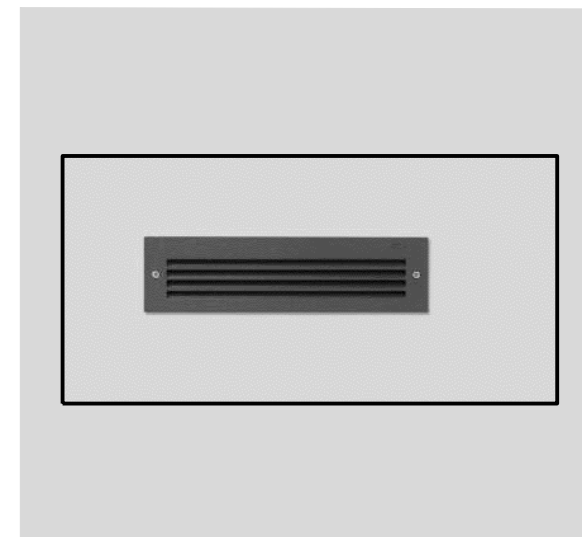

LED recessed wall luminaires - unshielded location luminaires

LED	A	B	C
33 018	2.7 W	10 18	2 3/4 5

BEGA 1000 BEGA Way, Carpinteria, CA 93013 (805) 684-0533 info@bega-us.com

Due to the dynamic nature of lighting products and the associated technologies, luminaire data on this sheet is subject to change at the discretion of BEGA North America. For the most current technical data, please refer to bega-us.com
 © copyright BEGA 2018 Updated 04/08/21

FOR REFERENCE ONLY
 INSTALLATION OF LUMINAIRES IN PANELS
 TO BE PROVIDED BY OTHERS (DISTRICT'S
 ELECTRICAL SUBCONTRACTOR)

HY

HIBSER YAMAUCHI
 Architects, Inc.

300 – 27th Street
 Oakland, CA 94612
 510.446.2222 tel | 510.446.2211 fax

Title: HAYWARD USD - ORCHESTRA SHELL TOWERS
 Date: 2023-12-18
 Scale: As Noted
 Drawn By: ECC

11.61.14 A5

The Shalleck Collaborative Inc.

Planning and Design of Theatres | Production Systems | AV

1553 Martin Luther King Jr Way
 Berkeley, CA 94709

tel 415-956-4100
 www.shalleck.com

NOTES: LUMINAIRE # 33 018 – SEE SPECIFICATIONS

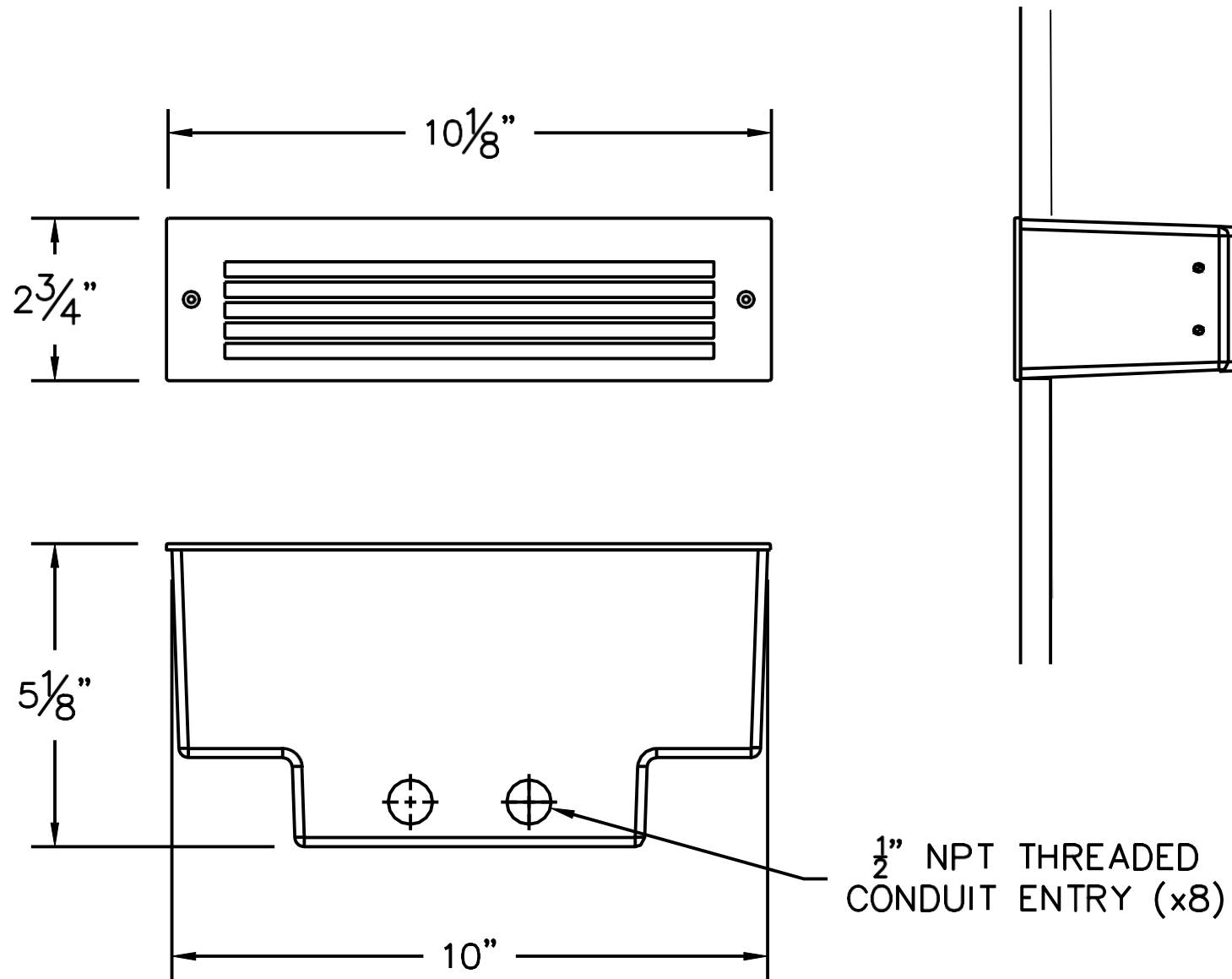

FOR REFERENCE ONLY
 INSTALLATION OF LUMINAIRES IN PANELS
 TO BE PROVIDED BY OTHERS (DISTRICT'S
 ELECTRICAL SUBCONTRACTOR)

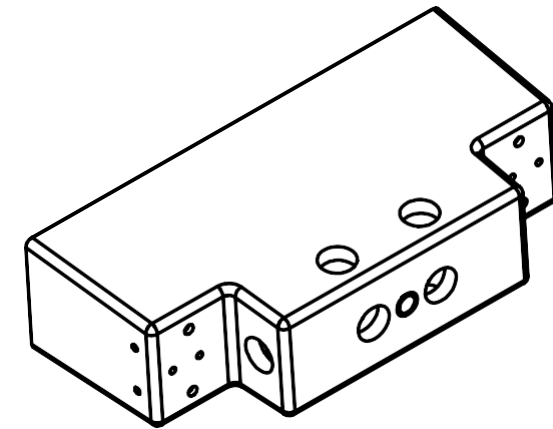

ISOMETRIC VIEW
 INSTALLATION HOUSING
 (NOT TO SCALE)

HY HIBSER YAMAUCHI
 Architects, Inc.
 300 – 27th Street
 Oakland, CA 94612
 510.446.2222 tel | 510.446.2211 fax
 Title: HAYWARD USD - ORCHESTRA SHELL TOWERS
 Date: 2023-12-18 Drawing Number:
 Scale: As Noted 11.61.14 A6
 Drawn By: ECC

Shalleck Collaborative

1553 Martin Luther King Jr Way
 Berkeley, CA 94709

tel 415-956-4100
 www.shalleck.com

TYPE: _____

SUBMITTAL APPROVAL

APPROVED BY: _____ DATE: _____

SIGNED: _____

REV. DATE DESCRIPTION

CAT NO.: 33 018

PROJECT: -

LOCATION: -

DRAWN: SB DATE: 8/9/2018 FILE NAME: 33018.DXF

BEGA

1000 Bega Way
 Carpinteria, Ca. 93013
 (805) 684-0533

This print contains confidential information which is the property of BEGA U.S. By acceptance this information, the borrower agrees that it will not be used for any other purpose other than that which is loaned.