

2025 - 2026
COURSE OFFERINGS DESCRIPTIONS &
CAREER EXPLORATION INFORMATION

Grades 9th-12th

Waller
Independent School District

www.wallerisd.net 936.931.3685

Mission Statement

Waller ISD believes that all students will be successful learners and graduate with skills that will allow them to compete in the 21st century workplace. It is therefore the intent of the District to serve all students regardless of their ability, environment, or national origin. Students will be provided opportunities to develop intellectually, physically, and socially through a quality system of teaching and learning. Through these opportunities, students will become responsible and productive members of a constantly changing society and world.

How To Use This Planning Guide

You have a unique opportunity to make some decisions that will influence your future. The planning of your high school program is an important transition in your life. This process does not need to be overwhelming, but it should be taken seriously. Keep in mind that the decisions you make regarding your high school program will affect the rest of your life.

College students change their majors an average of three times, and you will probably change your mind about your career several times. You do need to be aware that each decision you make now will affect the options you will have later. It is better to develop a plan that keeps all of your options open rather than to create one that may limit you later. For that reason, it is important for you to plan as challenging a program as you can. If your career plans change, then it will be easier to move to another program. Although it may appear tempting to create an easier program so that you can enjoy the many activities that happen during your high school career, this may have drastic and negative consequences for you in the long run. You should try to find courses that meet your needs and that prepare you for your potential careers rather than just taking courses that will allow you to graduate. Waller ISD has a wide range of programs designed to prepare students for post-high school experiences: college, business or technical school, military service, fine arts, immediate employment and many others. These programs allow you to choose the one that is best suited to your needs.

On the following pages, you will see the graduation requirements and the graduation plans that are available to you. There is also information relating to career planning that may be helpful. These pages should assist you in personalizing your plan. You will find a description of the courses offered along with any information on prerequisites or grade level placement. A worksheet for your four-year plan will assist you in making sure that you include the necessary courses for the graduation plan you select. Please devote some time and make a serious effort in planning YOUR future.

Students and Parents:

- Review the graduation requirements on page 2. Review records of the high school courses you have already taken.
- Think about your post-secondary education plans and career goals. Decide which college and/or articulated credit opportunities you might want to pursue in high school.
- Update your Four-Year Graduation Plan as needed.
- Choose courses for next year's schedule that support your Four-Year Graduation Plan and career goals.
- Be sure you have completed the prerequisite requirement for the courses you select.
- Complete your course requests by the due date.

Table of Contents

| | |
|---|----|
| General Registration Information..... | 1 |
| Graduation Requirements- Class of 2026, 2027, 2028 & 2029..... | 2 |
| Other Graduation Requirements..... | 5 |
| Course Work..... | 8 |
| Student Classification..... | 8 |
| Minimum Course Load..... | 8 |
| Working During School Hours..... | 8 |
| Early Dismissal/Late Arrival for High School Work Based Learning or Other Regular Arrangements..... | 8 |
| Credits Required for Graduation..... | 8 |
| Attendance..... | 8 |
| Course Selection and Schedule Changes..... | 8 |
| Acceleration Alternatives..... | 9 |
| Advanced Placement (AP)..... | 9 |
| Entrance/Exit Information for Honors/AP/DC Courses..... | 9 |
| Entrance Information Regarding Advanced Courses..... | 9 |
| Exit Information Regarding Advanced Courses..... | 10 |
| Gifted/Talented..... | 10 |
| State Programs Supporting Texas Students..... | 10 |
| Top Ten Percent Admissions..... | 10 |
| Texas First Early High School Completion Program and Texas First Scholarship Program (19 TAC Part I, §21.54)..... | 10 |
| Texas Leadership Scholarship..... | 10 |
| Toward Excellence, Access, and Success (TEXAS) Grant Program..... | 10 |
| Texas Educational Opportunity Grant (TEOG)..... | 11 |
| Other Texas Financial Aid Programs..... | 11 |
| Dual Credit Courses..... | 11 |
| Class Loads and Grades..... | 11 |
| Textbooks and Tuition..... | 12 |
| Requirements..... | 12 |
| Withdrawal..... | 12 |
| Distance Learning /Correspondence Courses..... | 12 |
| Early Graduation..... | 13 |
| Summer School..... | 13 |
| Hope Academy..... | 13 |
| Testing Information..... | 13 |
| Credit by Exam for Placement/Recovery and Acceleration Credit..... | 13 |
| State of Texas Assessment of Academic Readiness (STAAR)..... | 13 |
| ACT & SAT..... | 13 |
| ASVAB..... | 13 |
| PSAT..... | 14 |
| TSIA2..... | 14 |

| | |
|--|----|
| Special Programs..... | 14 |
| Special Education..... | 14 |
| 504..... | 14 |
| Dyslexia..... | 14 |
| ESL..... | 14 |
| New Arrival Courses (NAC)..... | 15 |
| Multi-Tiered System of Support (MTSS)..... | 15 |
| Career and Technical Education..... | 15 |
| Honors/Recognition..... | 15 |
| Nine Weeks Honor Roll..... | 15 |
| Annual Honor Roll..... | 15 |
| Top 10%..... | 15 |
| Honor Graduates..... | 15 |
| Determination of Class Rank..... | 16 |
| Cumulative GPA..... | 16 |
| Limitations and Exclusions..... | 16 |
| Class Rank..... | 16 |
| Ties..... | 17 |
| Transfer Students..... | 17 |
| Transfer Credit..... | 17 |
| UIL Eligibility Exempt Courses..... | 17 |
| NCAA Information..... | 18 |
| Core Courses..... | 18 |
| Test Scores..... | 18 |
| Grade-Point Average..... | 18 |
| Division I – 16 Core Courses..... | 18 |
| Division II – 16 Core Courses..... | 18 |
| Nontraditional Courses..... | 19 |
| WHS Core Courses Not Approved though NCAA..... | 19 |
| ENGLISH..... | 21 |
| MATHEMATICS..... | 25 |
| SCIENCE..... | 30 |
| SOCIAL STUDIES..... | 33 |
| HEALTH/PHYSICAL EDUCATION..... | 38 |
| AIR FORCE JUNIOR RESERVE OFFICER TRAINING CORPS (AFJROTC)..... | 40 |
| LANGUAGES OTHER THAN ENGLISH..... | 41 |
| FINE ARTS..... | 44 |
| SKILLS DEVELOPMENT..... | 49 |
| AGRICULTURE, FOOD AND NATURAL RESOURCES..... | 53 |
| ARCHITECTURE AND CONSTRUCTION..... | 58 |
| ARTS, A/V TECHNOLOGY, AND COMMUNICATION..... | 61 |
| BUSINESS, MARKETING AND FINANCE..... | 79 |
| EDUCATION & TRAINING..... | 83 |
| ENGINEERING..... | 86 |

| | |
|---------------------------------------|----|
| HEALTH SCIENCE..... | 88 |
| HOSPITALITY & TOURISM..... | 90 |
| HUMAN SERVICES..... | 92 |
| INFORMATION TECHNOLOGY..... | 94 |
| LAW AND PUBLIC SERVICE..... | 97 |
| MANUFACTURING..... | 99 |
| Appendix..... | 1 |
| Graduation Preparation Timelines..... | 2 |
| NINTH GRADE – CLASS OF 2029..... | 2 |
| TENTH GRADE – CLASS OF 2028..... | 2 |
| ELEVENTH GRADE – CLASS OF 2027..... | 3 |
| TWELFTH GRADE – CLASS OF 2026..... | 3 |

General Registration Information

The high school in Waller operates on a semester system on a traditional schedule (seven instructional class periods). One year's work will provide one credit in each course or a maximum total of seven credits per regular school year. Additional credits may be earned in summer school, night school, correspondence, credit-by-exam, or college courses taken for dual credit.

New Students

A high school student new to the school district should provide the registrar's office with the documents listed below:

1. Birth certificate
2. Immunization records as follows: Immunization records from a previous school **or** a validated document of immunization by a public health clinic or one signed by a licensed physician.

IMMUNIZATION REQUIREMENTS

A student shall show acceptable evidence of vaccination prior to entry, attendance, or transfer to a child-care facility or public or private elementary or secondary school in Texas:

1. Copy of the student's academic record from the previous school
2. A copy of his/her STAAR Confidential Student Report for the most recent test administration (students enrolling from another Texas school)
3. Social Security number
4. Proof of residency in the district (lease agreement, proof of home ownership, etc.)
5. Documentation of participation in any special programs (Special Education, 504, Gifted and Talented, and ESL.)

This chart summarizes the vaccine requirements incorporated in the Texas Administrative Code (TAC), Title 25 Health Services, § 97.61-97.72. This chart is not intended as a substitute for consulting the TAC, which has other provisions and details. The Department of State Health Services is granted authority to set immunization requirements by the Education Code, Chapter 38, Health & Safety, Subchapter A, General Provisions.

| Vaccine Required | Minimum Number of Doses Required by Grade Level | | | NOTES |
|---|---|--|---|---|
| | K-6th | 7th | 8th - 12th | |
| Diphtheria/Tetanus/Pertussis (DTaP/DTP/DT/Td/Tdap) ¹ | 5 doses or 4 doses | 3 doses primary series and 1 Tdap/Td booster within last 5 years | 3 doses primary series and 1 Tdap/Td booster <i>within last 5 years</i> | <p>For K- 6th grade: 5 doses of diphtheria-tetanus-pertussis vaccine; one dose must have been received on or after the 4th birthday. However, 4 doses meet the requirement if the 4th dose was received on or after the 4th birthday.</p> <p>For 7th grade: 1 dose of Tdap is required if at least 5 years have passed since the last dose of tetanus-diphtheria-containing vaccine.</p> <p>For 8th – 12th grade: 1 dose of Tdap is required when 10 years have passed since the last dose of tetanus-diphtheria-containing vaccine. Td is acceptable in place of Tdap if a medical contraindication to pertussis exists.</p> |
| Polio ¹ | 4 doses or 3 doses | | | <p>For K – 12th grade: 4 doses of polio; 1 dose must be received on or after the 4th birthday.1 However, 3 doses meet the requirement if the 3rd dose was received on or after the 4th birthday.1</p> |
| Measles, Mumps, and Rubella ^{1,2} (MMR) | 2 doses of MMR | 2 doses of measles and 1 dose each of rubella and mumps vaccine | | <p>The 1st dose of MMR must be received on or after the 1st birthday. For K -6th grade, 2 doses of MMR are required.</p> |
| Hepatitis B ² | 3 doses | | | <p>For students aged 11-15 years, 2 doses meet the requirement if adult hepatitis B vaccine (Recombivax) was received. Dosage and type of vaccine must be clearly documented. (Two 10 mcg/1.0 ml of Recombivax). If Recombivax was not the vaccine received; a 3-dose series is required.</p> |
| Varicella ^{1,2,3} | 2 doses | | | <p>For K – 12th grade: 2 doses are required, with the 1st dose received on or after the 1st birthday.1</p> |
| Meningococcal | | 1 dose | | <p>For 7th – 12th grade, 1 dose of quadrivalent meningococcal conjugate vaccine is required on or after the student's 11th birthday.</p> <p>NOTE: If a student received the vaccine at 10 years of age, this will satisfy the requirement.</p> |
| Hepatitis A ^{1,2} | 2 doses | | | <p>For K – 12th grade: 2 doses are required, with the 1st dose received on or after the 1st birthday.1</p> |

Receipt of the dose up to (and including) 4 days before the birthday will satisfy the school entry immunization requirement. 2 Serologic evidence of infection or serologic confirmation of immunity to measles, mumps, rubella, hepatitis B, hepatitis A, or varicella is acceptable in place of vaccine. 3 Previous illness may be documented with a written statement from a physician, school nurse, or the child's parent or guardian containing wording such as: "This is to verify that (name of student) had varicella disease (chickenpox) on or about (date) and does not need varicella vaccine." This written statement will be acceptable in place of any and all varicella vaccine doses required. Information on exclusions from immunization requirements, provisional enrollment, and acceptable documentation of immunizations may be found in §97.62, §97.66, and §97.68 of the Texas Administrative Code, respectively and online at <https://www.dshs.texas.gov/immunize/school/default.shtm>.

Exemptions

Texas law allows (a) physicians to write medical exemption statements which clearly state a medical reason exists that the person cannot receive specific vaccines, and (b) parents/guardians to choose an exemption from immunization requirements for reasons of conscience, including a religious belief. The law does not allow parents/guardians to elect an exemption simply because of inconvenience (for example, a record is lost or incomplete and it is too much trouble to go to a physician or clinic to correct the problem). Schools should maintain an up-to-date list of students with exemptions, so they may be excluded in times of emergency or epidemic declared by the commissioner of public health. Instructions for requesting the official exemption affidavit that must be signed by parents/guardians choosing the exemption for reasons of conscience, including a religious belief, can be found at www.dshs.texas.gov/immunize/school/exemptions.aspx. The original Exemption Affidavit must be completed and submitted to the school.

Graduation Requirements- Class of 2026, 2027, 2028 & 2029

All students graduating from Waller High School on the Foundation High School Program with Endorsements must complete 26 units of credit. House Bill 5 sets the end-of-course assessment instruments for secondary-level courses in Algebra I, Biology, English I, English II, and United States History for high school graduation. The purpose of the end-of-course (EOC) assessments are to measure students' academic performance in core high school courses and to become part of the graduation requirements beginning with the freshman class of 2011-2012. Students are enrolled in the Foundation High School Program with Endorsements when entering as a freshman at Waller High School in order to complete graduation requirements for Texas public schools. The appropriate State of Texas Seal designating which plan was completed will be attached to the student's transcript. High school courses taken in junior high will allow students to earn credit toward the 26 credits required for the Foundations High School Program with Endorsements, but junior high grades are not included in student's grade point average (G.P.A.). Credit by exam, distance learning, or correspondence courses can meet credit requirements, but will not be factored into the students G.P.A (Texas Virtual School courses are factored in G.P.A.).

In order to participate in graduation exercises, all 26 credits, as listed below, must be completed with official grades turned in to the registrar's/counselor's office prior to the time of the graduation ceremony and documentation of satisfactory performance on all necessary STAAR/EOC exams as designated by Texas Education Agency.

| Discipline | Credits | Foundation Plan with Endorsements * |
|------------------------------------|---------|---|
| English | 4 | English I English II English III 4 th Year English Course** |
| Mathematics | 4 | Algebra I Geometry 3 rd Year Mathematics Course** 4 th Year Mathematics Course** |
| Science | 4 | Biology IPC, Chemistry or Physics 3 rd Year Science Course** 4 th Year Science Course** |
| Social Studies | 3 | World Geography or World History US History US Government (½ credit) Economics (½ credit) Or Personal Financial Literacy and Economics (½ credit) |
| Language Other Than English (LOTE) | 2 | Spanish I, II or French I, II or Computer Science I, II |
| Fine Arts | 1 | Music, Art, Theatre, Dance, Choir, or Introduction to Floral Design |
| Physical Education (or equivalent) | 1 | Students may substitute the fall semester of marching band, cheerleading, or a full year of AFJROTC, Athletics, Drill Team I or Pre-Drill. |
| Elective Courses | 7 | Must be state approved courses and include at least two additional credits in an endorsement area. |
| Total Credits | 26 | |

*A student may graduate under the Foundation High School Program (22 credits) without earning an Endorsement with proper documentation and parent signature after the sophomore year. ** Refer to the list of eligible courses in the Course Offerings within each subject area

Endorsements

Students shall specify in writing an endorsement the student intends to earn upon entering Grade 9.

Students must earn at least twenty-six (26) credits to earn an endorsement:

- Must demonstrate proficiency for the Foundation High School Program (22 credits)
- An additional credit (1.0) in mathematics
- An additional credit (1.0) in science
- Two (2.0) additional electives that may be selected from the endorsement area.

| STEM <i>Science, Technology, Engineering, & Math</i> | Business & Industry | Public Services | Arts & Humanities | Multidisciplinary Studies |
|---|---|---|--|--|
| <p>Students may earn a STEM endorsement by selecting and completing the requirements from among the 5 options.</p> <p>Note: Algebra II, Chemistry, and Physics are required for the STEM endorsement regardless of the option the student selects from below.</p> <p>Option 1: CTE Students earn four (4) CTE credits by taking at least two (2) courses in the same career cluster and at least one advanced CTE course. The final course must be in the STEM cluster or Engineering and Information Technology program of study.</p> <p>Option 2: Computer Science Students take 4 computer science courses.</p> <ul style="list-style-type: none"> • Fundamentals of Computer Science • AP Computer Science Principles • Game Programming and Design • Computer Science I • Computer Science II • Computer Science III | <p>Students may earn a Business & Industry endorsement by selecting and completing the requirements from among these 3 options.</p> <p>Option 1: CTE Students earn four (4) CTE credits by taking at least two (2) courses in the same career cluster and at least one advanced CTE course. The final course must be in one of the following areas:</p> <ul style="list-style-type: none"> • Agriculture, Food, and Natural Resources • Architecture and Construction • Arts, Audio/Video Technology, and Communication • Business, Marketing, & Finance • Hospitality and Tourism • Information Technology • Manufacturing | <p>Students may earn a Public Services endorsement by selecting and completing the requirements from among these 2 options.</p> <p>Option 1: CTE Students earn four (4) CTE credits by taking at least two (2) courses in the same career cluster and at least one advanced CTE course. The final course must be in one of the following areas:</p> <ul style="list-style-type: none"> • Education and Training • Health Science • Human Services- Child Guidance & Cosmetology • Law and Public Service • Career Preparation I and II <p>Option 2: AFJROTC Students take four (4) courses in AFJROTC.</p> | <p>Students may earn an Arts & Humanities endorsement by selecting and completing the requirements from among these 5 options.</p> <p>Option 1: Social Studies Students take five (5) social studies courses for 5 credits.</p> <p>Option 2: Foreign Language- Same Language Students take four (4) levels of the same foreign language.</p> <p>Option 3: Foreign Language- Two Languages Students take two (2) levels of one foreign language AND two (2) levels of a different foreign language (two levels in each of two different foreign languages for 4 credits).</p> <p>Option 4: Fine Arts Students take four (4) courses in one or two fine arts areas for 4 credits.</p> | <p>Students may earn a Multidisciplinary endorsement by selecting and completing the requirements from among these 3 options.</p> <p>Option 1: Advanced CTE Students take four advanced courses for four (4) credits that prepare them to enter the workforce or postsecondary education without remediation from within one endorsement area or among endorsement areas not in a coherent sequence.</p> <p>Option 2: Four by Four (4 X 4) Students take four (4) courses in each of the four-core content areas.</p> <ul style="list-style-type: none"> • Four (4) English credits including English IV • Four (4) math credits • Four (4) science credits including biology and chemistry and/or physics • Four (4) social studies credits |

| STEM <i>Science, Technology, Engineering, & Math</i> | Business & Industry | Public Services | Arts & Humanities | Multidisciplinary Studies |
|--|--|------------------------|--|---|
| <p>Option 3: Math Students take Algebra I, Geometry, and Algebra II AND two (2) of the following courses for which Algebra II is a prerequisite.</p> <ul style="list-style-type: none"> • Pre-Calculus (all levels) • AP Calculus AB • AP Statistics • AQR • College Algebra/Trig/Stat <p>Option 4: Science Students take Biology, Chemistry, and Physics, AND two (2) of the following courses:</p> <ul style="list-style-type: none"> • Advanced Animal Science • Advanced Plant and Soil Science • Anatomy & Physiology • AP Physics B • Aquatic Science • AP Biology • AP Chemistry • Earth Systems Science • AP Environmental Science • Environmental Systems • Pathophysiology • Forensic Science • Special Topics in Science • Scientific Research & Design (Biology Dual Credit) <p>Option 5: Combination Students take Algebra II, Chemistry, and Physics, AND a coherent sequence of three (3) additional credits from no more than two of the above options.</p> | <p>Option 2: English Students take four (4) English elective credits that include three levels in one of the following areas:</p> <ul style="list-style-type: none"> • Advanced Journalism: Yearbook • Debate <p>Option 3: Combination Students take a coherent sequence of four (4) credits from the above options.</p> | | <p>Option 5: English Students take four (4) English credits selected from the following courses:</p> <ul style="list-style-type: none"> • English IV • Creative Writing • Humanities • Communication Application • AP English Literature & Composition • AP English Language & Composition | <p>Option 3: AP or Dual Credit Students take four (4) Advanced Placement (AP) or Dual Credit (DC) courses for four (4) credits in English, math, science, social studies, foreign language, or fine arts.</p> |

Testing Requirements for Graduation

Students take EOC (End-of-Course) assessments for courses in which they are enrolled as part of their graduation requirement. The five (5) EOC assessments required for graduation are:

- English I
- English II
- Biology
- US History
- Algebra I *

Students must earn an “approaches grade level” score on each of the five (5) assessments.

**Students who took Algebra I in JH will be required to take the SAT/ACT in high school as a requirement for Federal Accountability.*

HB4545/1416

Texas law requires all students who do not achieve approaches or higher on STAAR grades 3 through 8 or EOC assessments be provided accelerated instruction. These requirements, established by House Bill 4545 from the 87th legislature and modified with the passage of House Bill 1416 in the 88th legislature, provide that qualifying students must be:

- Assigned a TIA designated teacher for the subsequent school year in the applicable subject area;

OR

- Provided supplemental instruction aligned with the research on high impact tutoring in the TEKS for the applicable grade levels and subject area in the following manner:
 - No less than 15 or 30 hours depending on student performance and is provided in the summer or at least once per week in the school year;
 - Limited to two subjects per year, prioritizing math and RLA;
 - Provided in a group of no more than four students, unless the parent or guardian of each student in the group authorizes a larger group;
 - Designed to assist the student in achieving satisfactory performance in the applicable grade level and subject area and includes effective instructional materials designed for supplemental instruction;
 - Provided by one person with training in the applicable instructional materials for the supplemental instruction and for the entirety of their accelerated instruction, to the greatest extent possible by the LEA.

Other Graduation Requirements

Financial Aid Requirement

§74.1023. Financial Aid Application Requirement for High School Graduation- Beginning with students enrolled in Grade 12 during 2021-2022, each student in Grade 12 must complete and submit a free application for federal student aid (FAFSA), a Texas application for state aid (TASFA), or submit the TEA provided financial aid application Opt Out Form. Counselors will provide more detailed information to seniors each year.

Speech Requirement

§74.11(a)(3). Speech Requirement Students must demonstrate proficiency, in Grade 8 or higher, as determined by the district in which the student is enrolled, in delivering clear verbal messages; choosing effective nonverbal behaviors; listening for desired results; applying valid critical-thinking and problem-solving processes; and identifying, analyzing, developing, and evaluating communication skills needed for professional and social success in interpersonal situations, group interactions, and personal and professional presentations.

CPR and AED Requirement

§74.38(a)(1-2) Requirements for Instruction in Cardiopulmonary Resuscitation and Use of an Automated External Defibrillator A school district or open-enrollment school shall provide instruction to students in Grades 7-12 in cardiopulmonary resuscitation (CPR) and the use of an automated external defibrillator (AED). The instruction may be provided as part of any course; and must be provided to each student at least once before graduation from high school.

Proper Interaction with Peace Officer

§74.39. Requirements for Instruction on Proper Interaction with Peace Officers. A school district or open-enrollment charter school shall provide instruction to students in Grades 9-12 on proper interaction with peace officers during traffic stops and other in-person encounters.

Graduation Requirements for Students in Special Education

Graduation requirements for students in special education are determined by the student’s admission, review and dismissal (ARD) committee. Special education students will take either the STAAR or STAAR – Alt II as determined by the student’s ARD committee.

Individual Graduation Committee

Texas Education Code §28.0258 revises the state’s assessment graduation requirements for students enrolled in the 11th or 12th grade. A student who has failed the EOC assessment graduation requirement for not more than two courses may receive a Texas High school diploma if the student has qualified to graduate by means of an individual graduation committee (IGC) determination.

Performance Acknowledgments

A student may earn a [performance acknowledgment](#) for outstanding performance in the areas of:

1. Dual credit;
2. Bilingual / Bi-literacy;
3. College Board Advanced Placement (AP) exams;
4. PSAT, ACT ASPIRE, SAT, or ACT performance; or
5. Nationally or Internationally Recognized Business or Industry Certification or License.

Dual Credit

A student may earn a performance acknowledgment by successfully completing at least 12 hours of college credit taken through dual credit enrollment, advanced technical credit courses, and locally articulated courses with a grade of A or B or earn an Associate Degree.

Bilingual / Bi-literacy

A student may earn a performance acknowledgment by completing all English requirements with a grade of 80+ AND by satisfying 1 of the 4 following additional requirements.

1. Complete 3 credits in the same foreign language with a grade of 80+.
2. Demonstrate proficiency in Level IV or higher in a foreign language with a grade of 80+.
3. Complete 3 credits in any foreign language with a grade of 80+.
4. Demonstrate proficiency in a foreign language through 1 of the 2 following methods.
 - Earn a score of 3 or higher on a foreign language Advanced Placement (AP) exam.
 - Earn performance on a national assessment of language proficiency in a foreign language of at least Intermediate High or equivalent.

An English learner (EL student) must also have participated in and met exit criteria of a bilingual or English as a second language (ESL) program AND scored Advanced High on the Texas English Language Proficiency Assessment System (TELPAS).

College Board Advanced Placement (AP) Exam

A student may earn a performance acknowledgment by earning a score of 3 or above on an Advanced Placement (AP) exam.

PSAT, ACT-Aspire 10, SAT, or ACT Performance

A student may earn a performance acknowledgment by earning a qualifying score on one of the following exams.

1. Earn a score on the PSAT that qualifies the student for recognition as a commended scholar or higher by the College Board and National Merit Scholarship Corporation, as part of the National Hispanic Recognition Program or National Achievement Scholarship Program.
2. Achieve the college readiness benchmark score on at least 2 of the 4 subject tests on the ACT –Aspire 10 exam.
3. Earn a combination critical reading and mathematics score of at least 1250 on the SAT.
4. Earn a composite score on the ACT exam of 28 (excluding the writing sub score).

Nationally or Internationally Recognized Business or Industry Certification or License

Students may earn a performance acknowledgment for earning a nationally or internationally recognized business or industry certification or license.

Nationally or internationally recognized business or industry certification must be endorsed by:

- a national/international business, industry, or professional organization.
- a state agency or government entity, or
- a state-based industry association.

Certifications or licensures shall:

- be age appropriate for high school students.
- represent a student's substantial course of study and/or end-of-program knowledge and skills.
- include an industry recognized exam, an industry validated skills test, or demonstrated proficiency through documented supervised field experience; and
- represent substantial knowledge and multiple skills needed for successful entry into a high-skill occupation.

Distinguished Level of Achievement

A student may earn a distinguished level of achievement by successfully completing the curriculum requirements for the Foundation High School Program and the curriculum requirements for at least one endorsement required by the Texas Education Code (TEC), §28.025(b-15), including four credits in science and four credits in mathematics to **include Algebra II**.

| Waller ISD Endorsement, Program of Study, and Pathway Chart | | |
|--|---|--|
| Endorsement | Career Cluster | Program of Study |
| STEM | Engineering | Drone (Unmanned Vehicle) |
| | Information Technology | Cybersecurity |
| | | Programming and Software Development |
| Business & Industry | Agriculture, Food, and Natural Resources | Plant Science |
| | | Animal Science |
| | | Agricultural Technology and Mechanical Systems |
| | | Agriculture Business, Leadership and Communications |
| | Architecture and Construction | Architectural Drafting and Design |
| | | Carpentry |
| | | Electrical |
| | | HVAC and Sheet Metal |
| | Manufacturing | Robotics and Automation Technology |
| | | Welding |
| | Business, Marketing, and Finance | Accounting and Financial Services |
| | | Entrepreneurship |
| | | Marketing and Sales |
| | | Real Estate |
| | Arts, Audio Visual Technology, and Communication | Digital Communications |
| | | Graphic Design and Interactive Media |
| Hospitality and Tourism | Culinary Arts | |
| Public Service | Health Science | Diagnostic and Therapeutic Services |
| | Education and Training | Early Learning |
| | | Teaching and Training |
| | Human Services | Cosmetology and Personal Care Services |
| Law and Public Service | Law Enforcement | |
| Arts & Humanities | Fine Arts | Performing Arts |
| | | Visual Arts |
| | Social Studies | History, Geography |
| | Languages other than English | Spanish, French |
| English | English, Literature | |

***Waller High School also offers the Multidisciplinary endorsement which can include courses from various areas.

Course Work

Student Classification

The following shows the credits needed at the beginning of the fall semester for appropriate classification:

Sophomore - 6 credits
Junior - 12 credits
Senior - 19 credits

Students are reclassified the following set times per year to ensure appropriate grade classification based on course credits. Reclassification will occur:

- 15th school day of the spring semester
- 3rd Monday in July
- 2nd Monday in September
- Last day of each semester (12th grade reclassification only)

Minimum Course Load

All students are required to enroll in seven instructional classes each semester. EXCEPTIONS:

- Students enrolled in work-based learning programs must enroll in a minimum of five classes including the work-based learning class.
- Seniors enrolled in courses that are on track to complete their graduation requirements, have an application on file, and have their own transportation, will have the option of early dismissal and/or late arrival.
- Fifth year seniors
- HOPE Academy Students

Working During School Hours

Students may be employed during school hours, only if enrolled in a work-based learning program. Because employment is a required component of the work-based learning, these programs are only open to students who are at least 16 years of age. Work based learning programs are training programs designed to provide occupationally specific training. The training is planned and supervised cooperatively by the school and employers. A student may enter a work-based learning program at the beginning of the school year only. Students are required to work at least 15 hours per week. If not scheduled for a class, the students must be off campus.

Early Dismissal/Late Arrival for High School Work Based Learning or Other Regular Arrangements

A student scheduled for early dismissal must leave the campus within the class change period after their last scheduled class. Any student remaining on campus without authorization and without supervision is subject to disciplinary action.

A student scheduled for Late Arrival should arrive during the class change period prior to their first scheduled class.

For 12th Grade scheduled early dismissal and late arrival, parents and students will be required to sign a statement agreeing that the student will have his/her own transportation and will be on campus only during scheduled classes. The student must be enrolled in courses that complete his or her graduation requirements and an approved application on file.

Credits Required for Graduation

All students graduating from Waller High School on the Foundation High School Program with Endorsements must complete 26 credits and meet satisfactory performance on all the specified STAAR/EOC assessments. A student may graduate under the Foundation High School Program (22 credits) without earning an endorsement if, after the student's sophomore year:

1. the student and the student's parent or person standing in parental relation are advised by a school counselor of the specific benefits of graduating from high school with one or more endorsements; and
2. the student's parent or person standing in parental relation files written permission with a school counselor, on a form adopted by the Texas Education Agency (TEA), allowing the student to graduate under the Foundation High School Program without earning an endorsement.

Attendance

State law requires that "every student must attend at least 90% of the semester TO RECEIVE CREDIT." If a student is denied credit because of absences, they have until the end of the next semester to make up attendance hours through a principal's plan. However, if the course is a required prerequisite, the plan must be completed before the start of the next semester. Please be aware that if a student is denied credit in a required prerequisite course and has not completed the principal's plan before the first day of school, they will not be allowed to enroll in the next level course.

Course Selection and Schedule Changes

Students receive information about course offering and advice about appropriate course selection from the counselors either in late

fall or early spring. During that time, students have the opportunity to discuss their course options with parents, teachers, and counselors. Based on input, students may request a change in course selections for the following year until the conclusion of the spring semester. The master schedule and staffing for the following year is built based upon student requests during the spring semester. All requests for changes must be submitted in writing by the last day of the spring semester to the appropriate counselor.

Changes to a schedule or a course may only be made within the published time frame. After the course change deadline, the following guidelines will be used in honoring changes/requests made after that date.

1. Schedule changes will be made through the first three weeks (first 15 days) of a semester for the following reasons:
 - Error in scheduling on part of school such as a data entry error
 - Course completed/credit earned via summer school, Credit by Exam, Correspondence, etc.
 - Student does not meet prerequisite(s) for the course.
 - Student requests a change into or out of courses with Extracurricular requirements (Athletics, Band, Choir, ROTC, etc.)
 - Student did not meet standard on the STAAR/EOC
 - Level changes from an advanced course to an appropriate regular course with parent approval
2. No schedule changes are allowed after the third week (first 15 days) of each semester. The only exception to this rule is removal from advanced courses and AFJROTC within the first grading period. See Exit from Advanced Courses.
3. A student may exit a full year course at the end of the fall semester pending space available in a semester-long course for the spring semester. Requests should be made three weeks before the semester ends.

For questions regarding UIL eligibility and dropped classes, please see the appropriate coach or athletic coordinator.

Acceleration Alternatives

Advanced Placement (AP)

The Advanced Placement Program, administered by the College Board of New York, and taught at Waller High School, allows students to participate in a college level course and possibly earn college credit while still in high school by scoring well on the AP exam. In the program, students are encouraged to take the AP exam in May of each school year, to determine their mastery of the college level course. AP classes are more challenging and stimulating, but they take more time and require more work. AP classes require energetic, involved, and motivated students. The AP courses are taught by high school teachers who use course descriptions that were developed by committees of university professors and experienced AP teachers. The main advantage of taking an AP course is better preparation for college. It has been shown that students master in depth content at the college level more easily after completing AP courses in high school. Students also acquire sophisticated academic skills and increased self-confidence in preparation for college.

Honors courses are also offered to prepare the student who will eventually enroll in AP courses. Honors courses provide a sustained emphasis on promoting the essential academic habits of intellect necessary for success in the College Board Advanced Placement Program.

Entrance/Exit Information for Honors/AP/DC Courses

Advanced courses have a more rigorous and in-depth content focus than on-level/regular classes. Classes often move at a faster pace, include different types of assignments, and require additional outside reading. These classes are designed to challenge students beyond grade-level academic courses and prepare them for success in future advanced coursework. Students may require additional encouragement and support from both family and campus staff to be successful in advanced classes. Students enrolled in advanced classes in English, Math, Science, LOTE, and Social Studies should have an interest in and an aptitude for the subject. Waller ISD is committed to expanded access in challenging courses and recognizes the value of student participation in advanced courses.

Entrance Information Regarding Advanced Courses

We encourage students who are interested in advanced courses to enroll. The following information provides a profile of a student who typically experiences success in advanced courses:

- Successful completion of prerequisite coursework
- Current or previous successful performance in related area/course
- Demonstrates mastery on course-related state-mandated performance assessments including STAAR
- Students must have parent permission to enroll in advanced courses (signed course selection sheet)
- Teacher recommendation
- Careful consideration of demands of extracurricular activities, employment, community service, outside of school activities, and homework

Exit Information Regarding Advanced Courses

- Students in an Advanced course (Honors, AP, or Dual Credit) will be removed and placed in the appropriate regular course if their grade fails to meet the following guidelines:
 - Earn below a 65 for the first grading period in a semester course
 - Earn below a 60 for the first grading period in yearlong course
 - Earn below a 65 for the first semester of a yearlong course
- A student may, upon his/her request and with parent approval, transfer from an advanced course to an appropriate regular course, if an appropriate course is available, during the first grading period pending availability in the on-level course. The student will take the previous grade to the new course but will not receive the 5.0 points in the case of Honors, AP or DC courses.
- Due to the special training required of teachers along with the rigor or classroom interaction required of advanced courses, they cannot be taught in an alternative setting long term. Students who are removed from the classroom and placed in a district disciplinary alternative education placement (DAEP) or Juvenile Justice Alternative Education Placement (JJAEP) may be removed from the advanced course and placed in the appropriate regular course for the remainder of the semester/year. The student will take the previous grade to the new course but will not receive the 5.0 points in the case of Honors, AP or DC courses. The student will also be dropped from their college course with Blinn College.

Gifted/Talented

Gifted/Talented learners are currently being served through the Advanced Placement/Honors and Dual Credit programs. Parents, teachers, and students may nominate throughout the school year those who exhibit G/T traits, such as advanced vocabulary, critical/creative thinking, and an intense curiosity. Nomination forms are available from the high school counselor or the G/T coordinator. Program exiting may be initiated by the teacher, student, or parent at designated times during the school year. Please call 936-931-3685 for further information.

State Programs Supporting Texas Students

The State of Texas has developed several programs to encourage students to pursue a strong academic high school program which will adequately prepare them for further study and to face challenges in the twenty-first century workplace. These programs focus on admissions, grants, tuition exemptions, and financial aid, which will enable well-prepared, eligible students to attend public and non-profit institutions of higher learning in the State of Texas. **Some programs may specify that students must graduate under the Foundation High School Program with Endorsements as well as the Distinguished Level of Achievement.**

Top Ten Percent Admissions

Applicants from accredited Texas schools who graduate in the top ten percent of their high school class shall be admitted to any public university in Texas if the students meet the following conditions:

- Apply no later than two years after graduating from high school;
- Submit a completed application prior to filing deadlines set by the college;
- Graduate under the Foundation High School Program with Endorsements as well as the Distinguished Level of Achievement; and
- Provide additional documents requested by the college, including essays, letters of recommendations, admissions tests, and high school transcript.

Note: Colleges may limit the number of first-time freshmen eligible for admission due to enrollment caps (e.g., University of Texas, 5% for the Class of 2026). In some instances, students may be admitted to the university but not to the college of choice within the university. Colleges may admit students on a first-come-first-admitted basis or may use a lottery system.

Texas First Early High School Completion Program and Texas First Scholarship Program (19 TAC Part I, §21.54)

Students graduating one or two semesters early may qualify for a scholarship under the Texas First Diploma program for one or two semesters in participating colleges. Basic requirements are that a student has Texas Residency, completes a FAFSA, must earn at least 22 credits with a 3.0 or higher GPA, completion of the STAAR EOC tests in English 1, English 2, Algebra, Biology, and US History, and demonstrate mastery in each subject area- ELA, math, science, Social Studies, and LOTE. Additional academic requirements, including college readiness test scores are also required. Please see this link for additional program requirements. [TEXAS FIRST DIPLOMA FLYER](#)

Texas Leadership Scholarship

Eighteen Texas Colleges are offering full ride scholarships for strong leaders. Check their [website](#) for more details.

Toward Excellence, Access, and Success (TEXAS) Grant Program

The Texas Grant Program establishes grants to cover tuition and fees to Texas public colleges and universities including community colleges and technical schools for students with financial need who successfully complete the Foundation High School Graduation Program. To be eligible, students must not have been convicted of a felony or crime involving a controlled substance.

Awards will be made through the financial aid office of the college/university. Persons interested in the program should contact the college/university financial aid office to find out about deadlines and procedures.

Texas Educational Opportunity Grant (TEOG)

The purpose of the program is to provide a grant of money to enable well-prepared eligible students to attend public community colleges, technical colleges, or public state colleges in Texas. Students must be a Texas resident, have financial needs, enroll in the first thirty hours in college, must register with the Selective Services or be exempt, and have not been convicted of a felony or a crime involving a controlled substance.

Other Texas Financial Aid Programs

Other scholarships, grants, and financial aid, including tuition exemption, loans, and work-study are available and may include a tuition rebate program from Texas public universities, the Texas B-On-Time student loan program, a student loan with cancellation program for teachers (Teach for Texas), and the Tuition Equalization Grant (TEG). Students should begin preparing for these opportunities early in their high school years. Students should develop a portfolio which shows evidence of high achievement in a strong academic program as well as contributions to the school and community by participating in extracurricular activities and community organizations and projects.

General Information

Texas Financial Aid Information Center
Toll free: 1-888-311-8881

THECB Info Line for Loans, Grants & Scholarships
1-800-242-3062

Texas Higher Education Coordinating Board (THECB)
Web Address: www.thecb.state.tx.us

Track sheet and links to other sources
Web Address: www.collegeforalltexans.com

Dual Credit Courses

Waller High School offers the dual credit courses in conjunction with The Blinn College System (Blinn College). It is specifically designed for secondary education students who qualify to earn high school and college credit simultaneously while still in high school. Program eligibility is based on the student meeting the eligibility standards. Refer to the chart below to assist in determining exceptional admission. Placement scores that are required by every student in order to be placed in college-level courses are:

| Assessment | Math/Algebra | ELA/Reading Skills | Combined/Composite |
|------------|--------------|--------------------|--------------------|
| ACT1 | 19 | 19 | 23 |
| ACT2 | 22 | 40 | |
| SAT | 530 | 480 | |

1 - ACT administered prior to February 15, 2023; Students must meet both relevant subject and combined/composite score standards
2 - ACT administered on or after February 15, 2023

| TSIA 2.0 Administered on or after January 11, 2021 | |
|--|---|
| Math | ELAR |
| CRC 950 OR CRC 910-949 & Diagnostic Level 6 | CRC 945 & Essay 5-8 OR CRC 910-944 & Diagnostic Level 5-6 & Essay 5-8 |

When deciding which Dual Credit courses to take, make sure you visit the Texas Higher Education Coordinating Board’s Core Web Center at <http://statecore.its.txstate.edu/> to compare Blinn College courses to the institution you are considering attending. If taking dual credit courses on a Blinn campus for early graduation purposes, you are required to have a letter of permission on file with your counselor prior to registration.

Class Loads and Grades

Effective as of May 23, 2015, House Bill 505 prohibits the limitations on the number of dual credit courses or hours in which a public high school student may enroll.

The rule does not limit:

1. the number of dual credit courses or hours in which a student may enroll while in high school
2. the number of dual credit courses or hours in which a student may enroll each semester or academic year; or
3. the grade levels at which a high school student may be eligible to enroll in a dual credit course

In order to remain in the dual credit program, and continue classes, the student must maintain a 2.0 GPA for fall and spring semesters. If a student drops below a 2.0 for two consecutive semesters, they will be put on scholastic suspension. Because college grades are submitted prior to the end of high school semesters, a student in a dual credit class could have different grades for the college as opposed to the high school. Grades shown in Skyward reflect the high school average only. Refer to the college class syllabus to determine which grades are used for the college average. A grade in the dual credit class becomes part of the high school transcript and the college transcript. These are both part of the student’s permanent academic record.

Textbooks and Tuition

The student must purchase at his/her expense all college level textbooks and pay the fees set by Blinn College. The cost of tuition and fees are per credit hour and the tuition (but not the fees) is waived for dual credit students. Dual Credit Scholarships may be available pending available funds. See the WHS Dual Credit Liaison for more information.

| Academic Dual Credit Courses for 2025–2026 School Year | Credit Hours | Placement Testing Required |
|---|---------------------|--|
| ENGL 1301 and ENGL 1302 (English III DC) | 3 each | ELAR & Essay |
| HIST 1301 and HIST 1302 (US History DC) | 3 each | ELAR & Essay |
| ENGL 2322 and ENGL 2323 (English IV DC) | 3 each | ELAR & Essay |
| ENGL 1301 and ENGL 1302 (English IV DC) | 3 each | ELAR & Essay |
| GOVT 2305 (American Government DC)- Fall | 3 | ELAR & Essay |
| GOVT 2306 (State Government DC) - Spring | 3 | ELAR & Essay |
| MATH 1314 (College Algebra DC) - Fall | 3 | Math |
| MATH 1316 (College Trigonometry DC) - Spring | 3 | Math |
| MATH 1342 (Statistics DC) - Spring | 3 | Math |
| BIOL 1406 and BIOL 1407 (Biology DC) | 4 each | Math, ELAR & Essay |
| SPCH 1311 (Communication Applications DC) - Summer | 3 | ELAR & Essay, minimum score not required |
| ECON 2301 (Economics DC) - Summer | 3 | ELAR & Essay, minimum score not required |
| MUSI 1306 - (Music Appreciation DC) Summer | 3 | ELAR & Essay, minimum score not required |

| Technical Dual Credit Courses for 2025–2026 School Year | Credit Hours | Placement Testing Required |
|--|---------------------|--|
| ARTC 1302 (Digital Imaging/Graphic Design II DC) | 3 | ELAR & Essay, minimum score not required |

Requirements

Texas Administrative Code 4.85 does not require test scores for dual credit students for the first 14 semester credit hours earned. An institution of higher education may exempt a non-degree-seeking or non-certificate-seeking student from Texas Success Initiative (TSI) requirements under the Education Code. Dual credit students eligible for this exemption can only have 0 - 14 cumulative semester credit hours. Dual credit students will have to show college readiness by the time they earn 15 cumulative semester credit hours by one of these two options:

- Dual credit student will submit test scores to demonstrate college readiness
 - [Blinn College Testing Information](#)
- Dual credit student successfully completes MATH and ENGL 1301

Withdrawal

Withdrawal from a course after the Census Day will result in a mark of “W” on the student’s college transcript and no college credit will be awarded. It is the student’s responsibility to drop/withdraw before the “W” date by informing the WHS Dual Credit Liaison and then submitting a request to Blinn College for withdrawal from any course. Under Section §51.907 of the Texas Education Code, a student is not permitted to drop more than 6 (six) courses over their college career.

Any questions, please refer to the [Blinn College Course Catalog](#).

Distance Learning /Correspondence Courses

Credit toward state graduation requirement may be granted for correspondence courses only under the following conditions:

- The institution offering the course is The University of Texas at Austin, Texas Tech University, Texas Virtual School or another public institution of higher education approved by the commissioner of education and institute awards

credit for the course.

- The correspondence course includes the state required Texas Essential Knowledge and Skills (TEKS) for such a course.

Prior to enrollment in correspondence/distance learning courses, students shall make a written request to the counselor or designee for approval to enroll in the course. If approval is not granted prior to enrollment, the student will not be awarded credit towards graduation. Graduating seniors who are enrolled in correspondence/distance learning courses to earn credits for graduation must receive the grades prior to graduation. Grades earned in correspondence/distance learning courses (except for Texas Virtual School course credit) will not count toward determination of GPA or class rank.

Early Graduation

Students who attend Waller High School may apply to be an early graduate. This means a student will complete all graduation requirements in three or three and half years. Students who choose this option must advise their counselor and submit the application with their counselor before being considered for early graduation. Students must make this declaration by the completion of their freshman year or before the end of fall semester of student's sophomore year. All credits and state testing requirements must be completed before a student is allowed to participate in graduation ceremonies. Early graduates must meet graduation standards set upon entry into high school.

Summer School

High School students (9th-12th grade) may attend summer school to recover credit in failed courses. Registration information for high school students needing to recover credit will be available to students and parents during the spring semester.

A student may choose to attend summer school in a neighboring school district. Every student who attends these classes must have a permission letter from the counselor's office for registration. Students are responsible for requesting a transcript to be sent to WHS if they participate in a program to recover or accelerate credit.

Hope Academy

Waller High School's Hope Academy is a school of choice program serving students in a non-traditional setting who are 'at-risk' and in danger of becoming a dropout. The Hope Academy provides an alternative for students to be successful with flexible scheduling and a self-paced curriculum. Hope Academy is not a disciplinary setting. It is designed for students who are self-motivated, willing to follow rules and require no disciplinary action.

Testing Information

Credit by Exam for Placement/Recovery and Acceleration Credit

Students may take a credit by exam for courses in which they have had previous instruction or wish to accelerate. The students are allowed three hours to complete the exam, and it is similar to taking a final exam at the end of a semester. To award recovery credit, the score on the exam must be 70 or above on a criterion-referenced test. A score of 80 is required for acceleration credit when no previous instruction has been received. Acceleration credit is awarded when the score on the exam is a 3 or higher for College Board Advanced Placement exam or 80% on any other criterion-referenced test approved by the school district. The only board approved credit by exams are offered through Texas Tech University and the University of Texas. Credit by exam scores are not calculated in GPA and do not average with a semester grade for full year credit. Students should consult their counselor if they choose to take a credit by exam for make-up credit. Exams are administered four times a year. A student may not attempt to earn credit by exam for a specific high school course more than two times. If a student fails to earn credit by examination for a specific high school course before the beginning of the school year in which the student would ordinarily be required to enroll in that course in accordance with the school district's prescribed course sequence, the student must satisfactorily complete the course to receive credit.

State of Texas Assessment of Academic Readiness (STAAR)

In 2007 Senate Bill 1031 was enacted, which called for the development of end-of-course assessment instruments for secondary-level courses. House Bill 5 reduced the testing to the following subjects Algebra I, Biology, English I, English II, and United States History. The purpose of the end-of-course (EOC) assessments is to measure students' academic performance in core high school courses and to become part of the graduation requirements beginning with the freshman class of 2011- 2012.

ACT & SAT

ACT and SAT college entrance exams are recommended to be taken mid-year or early spring semester of the student's junior year. Students should check the college/university admission's deadlines to determine their best test date. Repeat testing can be completed during the senior year if necessary. Most colleges/universities require either ACT or SAT entrance exams for admission. Information and fee waivers concerning SAT and ACT tests may be obtained in the Counseling Center.

ASVAB

ASVAB is a multi-aptitude battery of tests, which helps students to identify their different abilities. The test is given during the fall and spring semesters. The decision to enter college, technical or vocational school, military service, or the civilian world-of-work is an important one. The ASVAB Career Exploration Program may assist students in determining the appropriate course of study based on

their abilities. This test is administered to students during the school year on a voluntary basis. Announcements will be made prior to each administration in which students may sign up in the Counseling Center.

PSAT

PSAT is given each school year during the month of October. Students in 10th and 11th grades are encouraged to take this exam that will prepare them to take the SAT. There is a nominal fee for this test. Juniors taking the test may qualify for National Merit Recognition and Scholarships. Announcements will be made prior to the testing date in which students may register for the test and make payments. Fee waivers may be available for 11th grade students.

TSIA2

The TSIA2 Assessment is a college readiness exam that is required for all students who plan to attend a Texas public institution of higher learning. This assessment is designed to help your institution of choice determine college readiness for course work in the general areas of reading, writing and mathematics. There is a nominal fee for this test. This exam must be taken before the student enters the first semester of college or before taking any dual credit courses, unless they are exempted based on ACT or SAT scores, or other tests as designated by the state of Texas.

Special Programs

Special Education

Through Waller Independent School District's Child Find procedures or the campus' Response to Intervention Team (RTI), students experiencing difficulties in school may be referred for services in Special Education. Please contact the Counseling Center for more information. Before a student can receive special education and /or related services for the first time, an initial evaluation must be conducted, and the evaluation must reflect that the student meets eligibility for special education services. Decisions regarding the provision of special education services are made by an Annual, Review, Dismissal (ARD) Committee. A full array of special education services are available to eligible students. These services are designed to support the student's efforts in the Least Restrictive Environment. If a student is determined to be eligible for services in accordance with the Texas Education Agency guidelines, an Individualized Education Program (IEP) is developed. Instructional settings may include (a) general education classroom with designated supports/modifications, (b) general education classroom with support, (c) resource classroom, (d) self-contained classroom or (e) on a separate campus.

For high school students, the IEP serves as the Personal Graduation Plan (PGP) for the purpose of planning courses to meet graduation requirements including endorsement options. Specialized courses which do not appear in this catalog may be available for students with disabilities as determined by the ARD Committee. Program information can be obtained by contacting Waller High School at 936-372-3654 or the Waller ISD Special Education Department at 936-931-9146.

504

Section 504 is a federal law passed by the United States Congress in 1973 with the purpose of prohibiting discrimination against disabled persons. Under Section 504, a student is considered "disabled" if he or she suffers from a physical or mental impairment that substantially limits one or more major life activities. A request for a Section 504 evaluation should be made to the campus §504 Coordinator. Evaluation data will be gathered by the designated campus coordinator. A committee of knowledgeable persons of the student is convened to determine eligibility and a possible service plan. Periodic reviews are held to review and adjust the service plan, if needed. A 3-year periodic re-evaluation is also held to determine continued eligibility for §504 services. For further information, please call 936-372-3654 to speak with the campus 504 Coordinator.

Dyslexia

Waller Independent School District offers a dyslexia program to students who qualify. The intervention should happen early in the student's academic career but may occur whenever it is needed. Students identified as being dyslexic should be given support throughout their academic career. This includes students in all grades. Waller I.S.D. provides a dyslexia intervention program that is conducted by trained dyslexia specialists. No single program is specified for all dyslexic students; rather, services are based upon individual student needs. W.I.S.D. utilizes reading programs for students with dyslexia that incorporates all of the critical, evidence-based components required by 19 TAC §74.28(c). Dyslexia teachers work closely with regular education teachers and special program teachers in order to provide an appropriate education for dyslexic students. Parent/Guardian permission is required for evaluation, and if eligible, placement into the program.

ESL

English as a Second Language (ESL) is a Waller ISD pull out model approved by TEA and designed for Emergent Bilinguals (EB) who are still acquiring English language proficiency. All courses for ESL students provide instruction based on the Texas Essential Knowledge and Skills (TEKS) and follow the English Language Proficiency Standards (ELPS). The ESL instructional program strives to meet the affective, linguistic, and cognitive needs of EBs [19 TAC Chapter 89.1210(f) (g)].

New Arrival Courses (NAC)

This Emergent Bilingual (EB) placement provides instructional opportunities for secondary recent immigrant students with little or no English proficiency. These students are newcomers within two years or less in U.S. schools and have scored at the very limited English proficiency level of the state approved English oral language proficiency tests. Students will be placed in ESOL I, ESOL II and the English Language Development course. The courses enable students to become increasingly more proficient in English in all four language domains. It will develop language, survival vocabulary, and the basic building blocks of literacy for newly arrived and preliterate students.

Multi-Tiered System of Support (MTSS)

Multi-Tiered System of Support, or MTSS, is the practice of meeting the academic and behavioral needs of all students through a problem-solving process with three key elements: high quality instruction and research-based interventions aligned with student need, frequent monitoring of student progress, and use of student data in making important educational decisions. As principals, teachers, staff, or parents become aware of a student struggling to meet his/her educational needs, the MTSS campus coordinator is contacted. Following the MTSS guidelines, the campus coordinator organizes a student support team consisting of campus personnel who have knowledge concerning that individual student's academic or behavioral concerns. After gathering pertinent information, the MTSS committee problem solves and recommends a course of action for each individual student. The course of action will vary depending upon the individual student's needs.

Career and Technical Education

Waller ISD offers career and technical education programs in:

- Science, Engineering, Technology and Math (STEM)
- Business and Industry
- Public Service

Admission to these programs is based on student interest, age, and grade requirements specified by the Texas Education Agency.

It is the policy of Waller ISD not to discriminate on the basis of race, color, national origin, sex or handicap in its vocational programs, services or activities as required by Title VI of the Civil Rights Act of 1964, as amended; Title IX of the Education Amendments of 1972; and Section 504 of the Rehabilitation Act of 1973, as amended.

Waller ISD will take steps to assure that lack of English language skills will not be a barrier to admission and participation in all educational and vocational programs.

For information about your rights or grievance procedures, contact the Title IX Coordinator, Angie Davis, and/or the Section 504 Coordinator, Shawna Kelley, at 20600 Field Store Road Waller, TX 77484, 936-931-3685.

Honors/Recognition

Nine Weeks Honor Roll

Students making all A's or all A's and B's during a nine weeks grading period are placed on the Nine Weeks Honor Roll.

Annual Honor Roll

Annual honor roll is determined by your GPA for the current year in all courses.

Class Rank

Class ranking is calculated twice yearly following the fall and spring semesters of the student's junior and senior year. The District shall apply the same class rank calculation method and rules for local graduation honors for all students in a graduating class, regardless of the school year in which a student first earned high school credit.

Class Rank Calculation

The District shall include in the calculation of class rank semester grades earned in high school credit courses taken in grades 9-12 and only in the following subject areas:

1. English
2. Mathematics
3. Science
4. Social Studies
5. Languages Other Than English (LOTE)

In addition, semester grades from high school credit courses taken on the high school campus prior to grade 9 shall be used in the calculation.

The class rank calculation shall not include semester grades from a course that is retaken after a passing grade has been earned, and the new grade shall not be recorded on the transcript.

The calculation shall include failing grades.

Exclusions

The calculation of class rank shall exclude grades earned in the following courses:

1. Correspondence courses*
2. Distance learning courses*
3. An audited course (initial or repeat)
4. Credit by examination with prior instruction
5. Credit by examination without prior instruction (acceleration)

* Texas Virtual School Course credit is included in grade point average.

Weighted Grade System

Classes of 2025, 2026, 2027, and 2028: The District shall categorize and weight eligible courses as Honors/Advanced Placement (AP)/Dual Credit, Regular, and Modified in accordance with the provisions located in the [online Waller ISD School Board Policy](#) and as designated in appropriate District publications.

The District shall convert semester grades earned in eligible courses to grade points in accordance with the chart located in the [online Waller ISD School Board Policy](#) and shall calculate a weighted grade point average (GPA). (i.e. 99-1.98 on a 2.0 scale per semester equivalent to the 4.0 scale)

Class of 2029 and after: The District shall categorize and weight eligible courses as Honors/Advanced Placement (AP)/Dual Credit and Regular in accordance with the provisions located in the [online Waller ISD School Board Policy](#) and as designated in appropriate District publications.

The District shall convert semester grades earned in eligible courses to grade points in accordance with the chart located in the [online Waller ISD School Board Policy](#) and shall calculate a weighted grade point average (GPA). (i.e. 99-1.95 on a 2.0 scale per semester equivalent to the 4.0 scale)

Transferred Grades

Students transferring into the district shall receive the numerical grade that was earned in the course at another school. Letter grade shall be recorded as follows:

- A or Advanced: 95
- B or Proficient: 85
- C or Basic: 77
- D or Minimal: 72
- F or No Evidence: 65

When a student enrolls in a Waller ISD secondary campus with a Pass/Fail Grade (P/F) for a high school credit course and the academic records (transcript or report card) received do not have a numerical grade, the secondary campus will not assign GPA weight for the high school credit course if it is a math, science, social studies, English, or LOTE course. Without a numerical grade from the sending campus, the secondary campus can not assign a numerical grade nor assign GPA weight to the high school credit course. Based on the permanent record received from the sending school for a completed semester, the secondary campus will transcribe the P/F on the secondary school transcript.

Classes of 2025, 2026, 2027, and 2028: A student who transfers into the District high school with credits for higher-level courses shall receive similar credits counted toward his or her GPA according to the list of higher-level courses offered in the District and the grade point scale used for credit earned in the District.

Class of 2029 and after: When a student transfers semester grades for courses that would be eligible under the Regular category and the District has accepted the credit, the District shall include the grades in the calculation of class rank.

When a student transfers semester grades for courses that would be eligible to receive additional weight under the District's weighted grade system, the District shall assign additional weight to the grades based on the categories and grade weight system used by the District only if the same or a similar course is offered to the same class of students in the District.

Local Graduation Honors

For the purpose of determining honors to be conferred during graduation activities, the District shall calculate class rank in accordance with this policy and administrative regulations by using grades available at the time of calculation at the end of the third nine-week grading period of the senior year.

For the purpose of determining honors to be conferred during graduation activities, the District shall also calculate class rank as required by state law. The District's eligibility criteria for local graduation honors shall apply only for recognitions and shall not restrict class rank for

the purpose of automatic admission under state law.

[\[See EIC\(LEGAL\)\]](#)

Valedictorian and Salutatorian

The valedictorian and salutatorian honors shall be the eligible students with the highest and second-highest rank, respectively. To be eligible for this local graduation honor, a student must:

1. Have been continuously enrolled in the District high school for the four semesters preceding graduation,
2. Be graduating after exactly eight semesters of enrollment in high school; and
3. Have completed the foundation program with the distinguished level of achievement.

Summa Cum Laude: Top 2 highest-ranking students in graduating class
 The following honors are based on the number of students in the graduating class of the given year.
 Magna Cum Laude: Top 5% students in graduating class
 Cum Laude: Next 10% students in graduating class

Breaking Ties

Classes of 2025, 2026, 2027, and 2028: In case of a tie in weighed GPAs, the District shall apply the following methods, in this order, to determine recognition as valedictorian:

- The weighted GPA shall be computed to a sufficient number of decimal places until the tie is broken
- Count the number of AP courses taken by each student involved in the tie.
- Calculate an unweighted numerical grade average using grades earned in eligible AP courses taken by each student involved in the tie.

Should a tie still remain for valedictorian, covaldictorians shall be declared, and no salutatorian shall be recognized. Should a tie develop for salutatorian, all those tying shall be recognized.

Class of 2029 and after: In case of a tie in weighted GPAs after calculation to the fourth decimal place, the District shall recognize all students involved in the tie as sharing the honor and title.

Highest-Ranking Graduate

The local eligibility criteria for recognition as the valedictorian shall not affect recognition of the highest-ranking graduate for purposes of receiving the honor graduate certificate from the state of Texas.

The District shall calculate class rank for this purpose at the end of the school year.

UIL Eligibility Exempt Courses

| | | |
|--------------------------------------|--|----------------------------------|
| English I (Honors) | World History (Honors) | Chemistry (AP) |
| English II (Honors) | World History Modern (AP) | Physics I (AP) |
| English III (AP) | US History (AP) | Physics II (AP) |
| English IV (AP) | Government (AP) | French III (Honors) |
| Dual Credit English III (1301, 1302) | Macroeconomics (AP) | French IV (AP) |
| Dual Credit English IV (2322, 2323) | European History (AP) | Spanish III (Honors) |
| Geometry (Honors) | Dual Credit United States History (1301, 1302) | Spanish IV, V (AP) |
| Algebra II (Honors) | Dual Credit American Government (2305) | Computer Science I (Honors) |
| Pre-Calculus (Honors) | Dual Credit State Government (2306) | Computer Science II (Honors) |
| Pre-Calculus (AP) | Dual Credit Economics (2301) | Computer Science A (AP) |
| Calculus (AP) | Psychology (Honors) | Computer Science Principles (AP) |

| | | |
|------------------------------------|----------------------------------|---|
| Statistics (AP) | Psychology (AP) | Music Theory (AP) |
| Dual Credit College Algebra (1314) | Environmental Science (AP) | Art History (AP) |
| Dual Credit Trigonometry (1316) | Biology (Honors) | Studio Art: 2-D Design (AP) |
| Dual Credit Statistics (1342) | Biology (AP) | Dual Credit Communication Applications (1311) |
| World Geography (Honors) | Dual Credit Biology (1406, 1407) | Dual Credit Music Appreciation (1306) |
| Human Geography (AP) | Chemistry (Honors) | |

NCAA Information

Core Courses

- NCAA Divisions I and II require 16 core courses. See the information below for the breakdown of this 16 core- course requirement.
- NCAA Division I requires 10 core courses to be completed prior to the seventh semester (seven of the 10 must be a combination of English, math or natural or physical science that meet the distribution requirements below). These 10 courses become "locked in" at the start of the seventh semester and cannot be retaken for grade improvement.
- A Division I college-bound student-athlete may still receive athletics aid and have the ability to practice with the team if he or she fails to meet the 10 course requirement but would not be able to compete.
- Division II will use a sliding scale to match test scores and core grade-point averages (GPA). The sliding scale for those requirements is available at the [NCAA Eligibility Center](#).

Test Scores

- Division I uses a sliding scale to match test scores and core grade-point averages (GPA). The sliding scale for those requirements is available at the [NCAA Eligibility Center](#).
- Division II partial qualifier requires a minimum SAT score of 820 or an ACT sum score of 68 and Division II full qualifier requires a minimum SAT score of 840 and an ACT sum score of 70 (see third bullet under Core Courses above).
- The SAT score used for NCAA purposes includes only the critical reading and math sections. The writing section of the SAT is not used.
- The ACT score used for NCAA purposes is a sum of the following four sections: English, mathematics, reading and science.
- When you register for the SAT or ACT, use the NCAA Eligibility Center code of 9999 to ensure all SAT and ACT scores are reported directly to the NCAA Eligibility Center from the testing agency. Test scores that appear on transcripts will not be used.

Grade-Point Average

- Be sure to look at your high school's list of NCAA Courses on the [NCAA Eligibility Center](#). Only courses that appear on your school's list of NCAA Courses will be used in the calculation of the core GPA. Use the list as a guide.
- Division I GPA required to receive athletics aid and practice is 2.000-2.299 (corresponding test-score requirements are listed on the [NCAA Eligibility Center](#)).
- Division I GPA required to be eligible for competition is 2.300 (corresponding test score requirements are listed on the [NCAA Eligibility Center](#))
- The Division II core GPA requirement for partial qualifier is a minimum of 2.000 and for full qualifier is a minimum of 2.200 (see third bullet under Core Courses above).
- Remember, the NCAA GPA is calculated using NCAA core courses only.

Division I – 16 Core Courses

- 4 years of English
- 3 years of mathematics (Algebra I or higher)
- 2 years of natural/physical science (1 year of lab if offered by high school)
- 1 year of additional English, mathematics or natural/physical science
- 2 years of social science
- 4 years of additional courses (from any area above, foreign language or comparative religion/philosophy)

Division II – 16 Core Courses

- 3 years of English
- 2 years of mathematics (Algebra I or higher)

- 2 years of natural/physical science (1 year of lab if offered by high school)
- 3 years of additional English, mathematics, or natural/physical science.
- 2 years of social science
- 4 years of additional courses (from any area above, foreign language or comparative religion/philosophy)

Nontraditional Courses

Nontraditional courses are classes taught online or through distance learning, independent study, individualized instruction, or correspondence methods.

For a nontraditional course to count as an NCAA core course (per NCAA Bylaw 14.3.1.2.2), it must meet all the following requirements:

1. A student in the course must have regular interaction with the teacher for instruction, evaluation and assistance for the duration of the course. This may include, for example, exchanging emails between the student and teacher, online chats, phone calls, feedback on assignments, and the opportunity for the teacher to engage the student in individual instruction.
2. The course must have a definite time period for completion. For example, it should be clear whether the course is meant to be taken for an entire semester or during a more condensed time period.
3. The course must be clearly identified as nontraditional on students' official high school transcript.

A nontraditional course could fail to meet NCAA core-course requirements for any of the following reasons:

1. Does not require regular and ongoing interaction between the student and teacher.
2. Does not have certified or qualified teachers.
3. Does not require students to complete the entire course.
4. Allows students to complete a course in a short period of time.
5. Allows students to take numerous courses at the same time, especially courses in the same subject area or that are sequential.
6. Does not prepare students for four-year college classwork.
7. Does not verify a student's identity.
8. Does not have formal assessments or has only limited assessments.
9. Does not retain student-specific data regarding course completion.

WHS Core Courses Not Approved though NCAA

The following Waller High School courses are not NCAA approved core courses:

- All coursework completed through Edgenuity (HOPE Academy, Night School, Extended Day, Saturday School, Summer School, etc.)
- English
 - Advanced Journalism I, II, III
 - College Readiness & Study Skills
 - Communications Applications DC
 - ESOL I
 - ESOL II
- Math
 - Accounting II
 - Algebraic Reasoning
 - College Preparatory Math
 - Math Models
 - Strategic Learning for High School Mathematics
 - Mathematical Applications in Food and Natural Resources
- Natural/Physical Science
 - Advanced Animal Science
- Social Science
 - Personal Financial Literacy
 - Personal Financial Literacy and Economics
- Additional Core Courses (Spanish I-V and French I-IV are approved)
 - LOTE Computer Science I, II

COURSE OFFERINGS



www.wallerisd.net 936.931.3685

ENGLISH

4th Year Options for English Credit

The following courses satisfy the 4th year English credit: English IV, English IV AP, English IV DC, College Preparatory English Language Arts, Advanced Integrated Reading and Writing (ENGL 0309), Creative Writing, Humanities, Debate III, Communication Applications DC, Communication Applications, and Advanced Journalism III (Yearbook). Make sure you check the prerequisite courses for each course.

English I (E09RG)
9th 1 credit 4.0

Prerequisite: *None*

Course Description: Students will apply previous learned foundational skills of developing and sustaining foundational skills, comprehension, response, multiple genres, author's purpose and craft, composition, and inquiry with greater depth in increasingly complex texts as they work collaboratively and independently to develop and use metacognitive skills. The strands are integrated and progressive so students think critically as readers and writers as they adapt to the ever-evolving nature of language and literacy. Students will engage in academic discourse, writing, and reading on a daily basis with opportunities for cross-curricular content, close reading routines, independent and self-selected reading, and diverse texts.

English I Honors (E09HN)
9th 1 credit 5.0

Prerequisite: *None*. (Refer to Entrance Information Regarding Advanced Courses)

Course Description: English I Honors courses focus on the same strands as English I on-level (see above), but also emphasize advanced reading, analytical reasoning skills, and writing for the advanced courses, such as Advanced Placement courses in language and literature and Dual Credit English III and IV.

English II (E10RG)
10th 1 credit 4.0

Prerequisite: *None*

Course Description: Students will apply earlier TEKS strands of developing and sustaining foundational skills, comprehension, response, multiple genres, author's purpose and craft, composition, and inquiry with greater depth in increasingly complex texts as they work collaboratively and independently to develop and use meta-cognitive skills. The strands are integrated and progressive, so students think critically as readers and writers as they adapt to the ever-evolving nature of language and literacy. Students will engage in academic discourse, writing, and reading on a daily basis with opportunities for cross-curricular content, close reading routines, independent and self-selected reading, and diverse texts.

English II Honors (E10HN)
10th 1 credit 5.0

Prerequisite: *None*. (Refer to Entrance Information Regarding Advanced Courses)

Course Description: English II Honors courses focus on the same strands as English II on-level (see above), but also emphasize advanced reading, analytical reasoning skills, and writing for the advanced courses, such as Advanced Placement courses in language and literature and Dual Credit English III and IV.

English III (E11RG)
11th 1 credit 4.0

Prerequisite: *None*

Course Description: Students will apply earlier TEKS strands of developing and sustaining foundational skills, comprehension, response, multiple genres, author's purpose and craft, composition, and inquiry with greater depth in increasingly complex texts as they work collaboratively and independently to develop and use meta-cognitive skills. The strands are integrated and progressive so students think critically as readers and writers as they adapt to the ever-evolving nature of language and literacy. Students will engage in academic discourse, writing, and reading on a daily basis with opportunities for cross-curricular content, close reading routines, independent and self-selected reading, and diverse texts.

English III AP- English Language and Composition (E11AP)
11th 1 credit 5.0

Prerequisite: *Recommended* English II

Course Description: This course focuses on the development and revision of evidence-based analytic and argumentative writing, the rhetorical analysis of nonfiction texts, and the decisions authors make as they compose and revise. Students evaluate, synthesize, and cite research to support their arguments. Additionally, they read and analyze rhetorical elements and their effects in nonfiction texts—including images as forms of text—from a range of disciplines and historical periods. This course aligns to an introductory college level rhetoric and writing curriculum and serves as preparation for successful completion of the AP Exam in May. As in the college course, students should be able to read and comprehend college level texts and write grammatically correct, complete sentences.

English III (ENGL 1301 & 1302) Dual Credit**(EN1301)/(EN1302)****11th****1 credit****5.0****Prerequisite:** *College eligibility per Blinn College guidelines. ENGL1302 requires successful completion of ENGL 1301***Course Description:** This college level course for both high school and college credit will be offered through Blinn College. Students must meet placement requirements set by Blinn College, which may include testing at the student's expense. Students must pay the required fees for tuition, books, etc. A student may earn up to three (3) hours of college credit for taking this course each semester.ENGL 1301 Intensive study of and practice in writing processes, from invention and researching to drafting, revising, and editing, both individually and collaboratively. Emphasis on effective rhetorical choices, including audience, purpose, arrangement, and style. Focus on writing the academic essay as a vehicle for learning, communicating, and critical analysis. This writing-intensive first-semester freshman composition course includes (1) study of and practice in all phases of the writing process, both individually and collaboratively, and (2) study of and practice in the strategies and techniques for developing research-based expository and persuasive texts. Essays including a 1500-word documented library research-based paper, are required.ENGL 1302: Intensive study of and practice in the strategies and techniques for developing research-based expository and persuasive texts. Emphasis on effective and ethical rhetorical inquiry; teamwork; critical reading of verbal, visual, and multimedia texts; systematic evaluation, synthesis, and documentation of information sources; and critical thinking about evidence and conclusions. This reading and writing intensive prerequisite for sophomore English offerings further develops the analytical, thinking, and research skills underlying academic success through the study of literature. The student's writing of genre-based essays, including researched papers, reinforces the thinking skills associated with interpretation, explication, evaluation, analysis, and synthesis. Essays, including a 1500-2000 word documented library research-based paper, are required.**English IV****(E12RG)****12th****1 credit****4.0****Prerequisite:** *None***Course Description:** Students will apply earlier TEKS strands of developing and sustaining foundational skills, comprehension, response, multiple genres, author's purpose and craft, composition, and inquiry with greater depth in increasingly complex texts as they work collaboratively and independently to develop and use metacognitive skills. The strands are integrated and progressive, so students think critically as readers and writers as they adapt to the ever-evolving nature of language and literacy. Students will engage in academic discourse, writing, and reading on a daily basis with opportunities for cross-curricular content, close reading routines, independent and self-selected reading, and diverse texts. *This course satisfies the 4th year English credit.***AP English IV - English Literature and Composition****(E12AP)****12th****1 credit****5.0****Prerequisite:** *Recommended English III or AP English Language and Composition***Course Description:** The AP English Literature and Composition course focuses on reading, analyzing, and writing about imaginative literature (fiction, poetry, and drama), from various periods. Students engage in close reading and critical analysis of imaginative literature to deepen their understanding of the ways writers use language to provide both meaning and pleasure for an audience. As they read, students consider a work's structure, style, and theme, as well as its use of figurative language, imagery, and symbolism. Writing assignments include informational, analytical, and argumentative essays that require students to analyze and interpret literary works. This course aligns to an introductory college-level literature and writing curriculum. As in the college course, students should be able to read and comprehend college-level text and write grammatically correct, complete sentences. *This course satisfies the 4th year English credit.***English IV (ENGL 1301 & 1302) Dual Credit****(ENDC01)/(ENDC02)****12th****1 credit****5.0****Prerequisite:** *College eligibility per Blinn College guidelines. ENGL1302 requires successful completion of ENGL 1301***Course Description:** This college level course for both high school and college credit will be offered through Blinn College. Students must meet placement requirements set by Blinn College, which may include testing at the student's expense. Students must pay the required fees for tuition, books, etc. A student may earn up to three (3) hours of college credit for taking this course each semester.ENGL 1301: Intensive study of and practice in writing processes, from invention and researching to drafting, revising, and editing, both individually and collaboratively. Emphasis on effective rhetorical choices, including audience, purpose, arrangement, and style. Focus on writing the academic essay as a vehicle for learning, communicating, and critical analysis. This writing-intensive first-semester freshman composition course includes (1) study of and practice in all phases of the writing process, both individually and collaboratively, and (2) study of and practice in the strategies and techniques for developing research-based expository and persuasive texts. Essays including a 1500-word documented library research-based paper, are required.ENGL 1302: Intensive study of and practice in the strategies and techniques for developing research-based expository and persuasive texts. Emphasis on effective and ethical rhetorical inquiry; teamwork; critical reading of verbal, visual, and multimedia texts; systematic evaluation, synthesis, and documentation of information sources; and critical thinking about evidence and conclusions. This reading and writing intensive prerequisite for sophomore English offerings further develops the analytical, thinking, and research skills underlying academic success through the study of literature. The student's writing of genre-based essays, including researched papers, reinforces the thinking skills associated with interpretation, explication, evaluation, analysis, and synthesis. Essays, including a 1500-2000 word documented library research-based paper, are required.

English IV**(E2322 & E2323)****12th****1 credit****5.0****Prerequisite:** *Dual Credit ENGL 1301 or ENGL 1302, must meet Blinn College guidelines.***Course Description:** This college level course for both high school and college credit will be offered through Blinn College. Students must meet placement requirements set by Blinn College, which may include testing at the student's expense. Students must pay the required fees for tuition, books, etc. A student may earn up to three (3) hours of college credit for taking this course each semester.ENGL 2322: A survey of the development of British literature from the Anglo-Saxon period to the Eighteenth Century. Students will study works of prose, poetry, drama, and fiction in relation to their historical, linguistic, and cultural contexts. Texts will be selected from a diverse group of authors and traditions. This survey introduces students to the principal authors, works, and trends that comprise the canon of British literature from the Anglo-Saxon period through the eighteenth century. Papers are required.ENGL 2323: A survey of the development of British literature from the Romantic period to the present. Students will study works of prose, poetry, drama, and fiction in relation to their historical and cultural contexts. Texts will be selected from a diverse group of authors and traditions.**College Preparatory Course English Language Arts (ELRA)****(ECPREP)****12th****1 credit****4.0****Prerequisites:** *Satisfactory performance on the English I & II STAAR/EOC examinations and successful course completion of English III.**Assessment information: 1) an end-of-course assessment instrument does not meet college readiness standards; or 2) coursework, a college entrance examination or an assessment instrument indicates that the student is not ready to perform entry-level college coursework***Course Description:** This course is appropriate for any 12th grade student whose performance on measures outlined in TEC§28.014 indicates that the student is not on track to perform entry-level college coursework in English Language Arts. This course is designed to advance college and career readiness. For the ELAR and Mathematics College Preparatory Courses, a student earning a grade of 70 or above in a particular course will demonstrate proficiency in the course and will be eligible to enroll in an entry-level college level English composition or Mathematics course at Blinn College, up to twenty four (24) months after high school graduation. The student must enroll in the student's first college-level course in the exempted content area in the student's first year of enrollment at the IHE. If the student does not earn a grade of "C" or higher in the exempted content area, the student must be tested for the remaining area(s) and comply with all other Success Initiative requirements. Students will learn to investigate academic texts, predominantly expository texts such as news articles, op-eds, researched articles, and readings across the curriculum, construct supported interpretations and arguments for an authentic audience, and acquire academic habits of thought. Reading instruction will focus on developing critical reading skills for comprehension, interpretation, and analysis of predominantly expository texts such as news articles, op-eds, researched articles, and readings across the curriculum. In writing, students will develop skills through composing with specific purpose, situation, genre, and audience in mind. Students will write a variety of effective formal and informal texts. To learn to integrate reading and writing, students will use an inquiry approach to analyze, synthesize, and make value judgments regarding text and writing. This course is designed to prepare students for college-level reading and writing intensive courses. Successful completion of this course, as defined by the memorandum of understanding (MOU) with the partnering institution(s), grants the student an exemption to TSI requirements for reading and writing at the partnering institution(s). ***This course satisfies the 4th English credit requirement for HS graduation.*****College Readiness & Study Skills****(COLLRE)****9th – 12th****½ credit****4.0****Prerequisite:** *None***Course Description:** In this course, students acquire techniques for learning from texts, including studying word meanings, identifying and relating key ideas, drawing and supporting inferences, and reviewing study strategies. In all cases, interpretations and understandings will be presented through varying forms, including through use of available technology. Students accomplish many of the objectives through wide reading as well as use of content texts in preparation for post-secondary schooling. ***This course is counted in the GPA as an academic elective.*****Debate I, II, III****(DBAT1)(DBAT2)(DBAT3)****9th – 12th****1 credit****4.0****Prerequisite:** *None***Course Description:** Students will prepare well-articulated cases on specific debate topics. This course is research based and writing intensive. They will learn how to formulate a case, prepare an argument, and successfully debate an opponent. Some of the skills involved include creating a flow chart, researching, and organizing pertinent information, and staying on topic. Students will be expected to maintain familiarity with current issues and events. If participating on the UIL Debate team, there is required after school practice and students will compete at area tournaments on Fridays and Saturdays. ***This course is counted in the GPA as an academic elective.***

Humanities (EHUM1)
11th – 12th 1 credit 4.0

Prerequisite: None

Course Description: Students read widely to understand how various authors craft compositions for various aesthetic purposes. This course includes the study of major historical and cultural movements and their relationship to literature and the other fine arts. This course will allow the students to explore issues involving literature and social sciences. Students will be expected to read, outline, and explore selected texts. Students will research topics in areas such as fine arts, science, geography, poetry, drama, history, and government. The majority of the work will be individual research based. *This course satisfies the 4th year English credit and is counted in the GPA as an academic elective.*

Journalism I (JOUPH)
9th – 12th 1 credit 4.0

Prerequisite: None

Course Description: This course covers general journalism knowledge, with focus on preparation for the production of a class newspaper. Survey portion of the class includes history of journalism in the United States; general guidelines for design, ethics, typography, layout, and photography skills used to produce campus on-line newspapers. *This course is counted in the GPA as an academic elective.*

Advanced Journalism I, II, and III (Yearbook) (JRYB1) (JRYB2) (JRYB3)
10th – 12th 1 credit 4.0

Prerequisite: None

Course Description: Advanced Journalism students will work on elements such as theme development, schedules and deadlines, contact with parents on seniors' ads, and other professional level activities. Students in Yearbook I, II, and III will be responsible for the planning and production of the WHS yearbook, The Bulldog. Activities will include rough draft layout, planning of ladder and assignment of pages; acquisition, formatting in Photoshop, and placement of appropriate photographs; copy-writing and caption-writing; editing and proofreading; production of pages; obtaining interviews and factual data on team records, senior goals, etc; meeting deadlines and dispatching final material to publisher; verifying accuracy of and returning in a timely manner of proof sheets; interaction with other students and staff at WHS. Grade criteria will include professional conduct and demeanor when representing Yearbook; organization and teamwork skills; timeliness and accuracy of submissions; willingness to assist other more junior staff members; continued growth in journalism and yearbook production skills. *Advanced Journalism III satisfies the 4th year English credit. All Advanced Journalism courses count in the GPA.*

Communication Applications (COMAPP)
9th – 12th ½ credit 4.0

Prerequisite: None

Course Description: Understanding and developing skills in communication are fundamental to all other learning and to all levels of human interaction. For successful participation in professional and social life, students must develop effective communication skills. Rapidly expanding technologies and changing social and corporate systems demand that students send clear verbal messages, choose effective nonverbal behaviors, listen for desired results, and apply valid critical-thinking and problem-solving processes. Students enrolled in Communication Applications will be expected to identify, analyze, develop, and evaluate communication skills needed for professional and social success in interpersonal situations, group interactions, and personal and professional presentations. *This course is counted in the GPA as an academic elective. This course could count as ½ credit towards a 4th ELA credit towards graduation.*

Communication Applications Dual Credit (SPCH 1311) (E1315)
9th – 12th ½ credit

Prerequisite: College eligibility per Blinn College guidelines

Course Description: SPCH 1311: Introduces basic human communication principles and theories embedded in a variety of contexts including interpersonal, small group, and public speaking. **Summer**

Reading I, II, III (RE180)(RE182)(RE183)
9th – 12th 1 credit 4.0

Prerequisite: None

Course Description: Reading I, II, III offers students reading instruction to successfully navigate academic demands as well as attain lifelong literacy skills. Specific instruction in word recognition, vocabulary, comprehension strategies, and fluency provides students an opportunity to read with competence, confidence, and understanding. Students learn how traditional and electronic texts are organized and how authors choose language for effect. All of these strategies are applied at an instructional level and independent level. *This course is counted in the GPA as an academic elective.*

ESOL I and ESOL II (ESOL1)(ESOL2)
 9th – 12th 1 credit 4.0

Prerequisite: LPAC Placement/Recommendation/Recommended corequisite English Language Development and Acquisition (ELDA)
Course Description: This course may substitute for English I/II credits for students who are new to the country and whose English proficiency is at the beginner or intermediate level. ESOL I/II learning expectations are the same as those of English I/II with the addition of instruction that is accommodated to meet the needs of students who are at the beginner or intermediate stage of English language acquisition. Emphasis is placed on vocabulary expansion, written and oral communication and reading comprehension to accelerate social and academic English language acquisition. ESOL I/II is taught through sheltered instruction methods for teaching proficiency in listening, speaking, reading, and writing in English as well as content knowledge.

Practical Writing Skills (EPWARG)
 9th – 12th 1 credit 4.0

Prerequisite: LPAC Recommendation/Placement
Course Description: The study of writing allows high school students to earn one-half to one credit while developing skills necessary for practical writing. This course emphasizes skill in the use of conventions and mechanics of written English, the appropriate and effective application of English grammar, the reading comprehension of informational text, and the effective use of vocabulary. Students are expected to understand the recursive nature of reading and writing. Evaluation of students' own writing as well as the writing of others ensures that students completing this course are able to analyze and evaluate their writing. *This course is counted in the GPA as an academic elective.*

Creative Writing (ECIW1)
 9th – 12th 1 credit 4.0

Prerequisite: LPAC Recommendation/Placement
Course Description: The study of creative writing allows high school students to earn one-half to one credit while developing versatility as a writer. Creative and Imaginative Writing, a rigorous composition course, asks high school students to demonstrate their skill in such forms of writing as essays, short stories, poetry, and drama. All students are expected to demonstrate an understanding of the recursive nature of the writing process, effectively applying the conventions of usage and the mechanics of written English. The student's evaluation of his/her own writing as well as the writing of others ensures that students completing this course are able to analyze and discuss published and unpublished pieces of writing, develop and apply criteria for effective writing, and set their own goals as writers. *This course satisfies the 4th year English credit.*

English Language and Acquisition 1 & 2 (ELDA1)/(ELDA2)
 9th – 12th 1 credit 4.0

Prerequisite: concurrent enrollment with corequisite ESOL I or ESOL II
Course Description: This course must be taken concurrently with a corequisite language arts course as outlined in Chapter 110 of this title (relating to Texas Essential Knowledge and Skills for English Language Arts and Reading or this chapter. *This course is counted in the GPA as an academic elective.*

MATHEMATICS

Algebra I, Geometry, and two additional math courses are required for students on the Foundation High School Program with an Endorsement.

3rd Year Options for Math Credit

Math Models with Applications, Algebraic Reasoning, Algebra II, Algebra II Honors, Advanced Quantitative Reasoning, Pre-Calculus, Pre-Calculus Honors, Pre-Calculus AP, Statistics, Calculus AP, College Algebra DC, College Trigonometry DC, College Statistics DC, Computer Science AP, Accounting II, Statistics AP, Mathematical Applications in Agriculture, Food, and Natural Resources, and Robotics II. Make sure you check the prerequisites for each course.

4th Year Options for Math Credit

Algebraic Reasoning, Algebra II, Algebra II Honors, Advanced Quantitative Reasoning, Pre-Calculus, Pre-Calculus Honors, Pre-Calculus AP, Statistics, Calculus AP, College Algebra DC, College Trigonometry DC, College Statistics DC, College Prep Math, Computer Science AP, Accounting II, Statistics AP, and Robotics II. Make sure you check the prerequisites for each course.

Algebra 1 (MALG1)
 9th 1 credit 4.0

Prerequisites: Required Mathematics grade 8 or its equivalent
Course Description: In Algebra I, students will build on the knowledge and skills for mathematics in Grades 6-8, which provide a foundation in linear relationships, number and operations, and proportionality. Students will study linear, quadratic, and exponential functions and their related transformations, equations, and associated solutions. Students will connect functions and their associated solutions

in both mathematical and real-world situations. Students will use technology to collect and explore data and analyze statistical relationships. In addition, students will study polynomials of degree one and two, radical expressions, sequences, and laws of exponents. Students will generate and solve linear systems with two equations and two variables and will create new functions through transformations. All ninth-grade students who did not take Algebra I in the eighth grade will enroll in this course. ***Algebra I is a required math course for all students. Algebra I is a prerequisite for all other math courses. Students that fail Algebra I will be required to attend mandatory Summer School the following summer to make up the Algebra I credit. Students who took Algebra I in JH will be required to take the SAT/ACT in high school as a requirement for Federal Accountability.***

Geometry (MGEOM)
9th – 10th 1 credit 4.0

Prerequisites: *Required* Algebra I (Per SB 1374, a student may enroll concurrently in Algebra I and Geometry)

Course Description: In Geometry, students will build on the knowledge and skills for mathematics in Kindergarten-Grade 8 and Algebra I to strengthen their mathematical reasoning skills in geometric contexts. Within the course, students will begin to focus on more precise terminology, symbolic representations, and the development of proofs. Students will explore concepts covering coordinate and transformational geometry; logical argument and constructions; proof and congruence; similarity, proof, and trigonometry; two- and three-dimensional figures; circles; and probability. Students will connect previous knowledge from Algebra I to Geometry through the coordinate and transformational geometry strand. In the logical arguments and constructions strand, students are expected to create formal constructions using a straightedge and compass. In proof and congruence, students will use deductive reasoning to justify, prove and apply theorems about geometric figures. Proportionality is the unifying component of the similarity, proof, and trigonometry strand. Students will use their proportional reasoning skills to prove and apply theorems and solve problems in this strand. The two- and three-dimensional figure strand focuses on the application of formulas in multi-step situations since students have developed background knowledge in two- and three- dimensional figures. Using patterns to identify geometric properties, students will apply theorems about circles to determine relationships between special segments and angles in circles. ***Geometry or Geometry Honors is a required math course for all students.***

Geometry Honors (MGEOHN)
9th – 10th 1 credit 5.0

Prerequisites: *Required* Algebra I

Course Description: In Geometry, students will build on the knowledge and skills for mathematics in Kindergarten-Grade 8 and Algebra I to strengthen their mathematical reasoning skills in geometric contexts. Within the course, students will begin to focus on more precise terminology, symbolic representations, and the development of proofs. Students will explore concepts covering coordinate and transformational geometry; logical argument and constructions; proof and congruence; similarity, proof, and trigonometry; two- and three-dimensional figures; circles; and probability. Students will connect previous knowledge from Algebra I to Geometry through the coordinate and transformational geometry strand. In the logical arguments and constructions strand, students are expected to create formal constructions using a straightedge and compass. In proof and congruence, students will use deductive reasoning to justify, prove and apply theorems about geometric figures. Proportionality is the unifying component of the similarity, proof, and trigonometry strand. Students will use their proportional reasoning skills to prove and apply theorems and solve problems in this strand. The two- and three-dimensional figure strand focuses on the application of formulas in multi-step situations since students have developed background knowledge in two- and three- dimensional figures. Using patterns to identify geometric properties, students will apply theorems about circles to determine relationships between special segments and angles in circles. Higher level and critical thinking skills addressed by providing opportunities for discovery and more detailed proof writing. The level of instruction/curriculum will focus on preparing the student for Advanced Placement courses. ***Geometry or Geometry Honors is a required math course for all students.***

Mathematical Models with Applications (MMTMA)
10th-12th 1 credit 4.0

Prerequisites: *Required* Algebra I

Course Description: Mathematical Models with Applications is designed to build on the knowledge and skills for mathematics in Kindergarten-Grade 8 and Algebra I. This mathematics course provides a path for students to succeed in Algebra II and prepares them for various post-secondary choices. Students learn to apply mathematics through experiences in personal finance, science, engineering, fine arts, and social sciences. Students use algebraic, graphical, and geometric reasoning to recognize patterns and structure, model information, solve problems, and communicate solutions. Students will select from tools such as physical objects; manipulatives; technology, including graphing calculators, data collection devices, and computers; and paper and pencil and from methods such as algebraic techniques, geometric reasoning, patterns, and mental math to solve problems. ***This course satisfies the 3rd year Mathematics credit.***

Algebraic Reasoning (MALGRE)
10th-12th 1 credit 4.0

Prerequisites: *Required* Algebra I

Course Description: In Algebraic Reasoning, students will build on the knowledge and skills for mathematics in Kindergarten-Grade 8 and Algebra I, continue with the development of mathematical reasoning related to algebraic understandings and processes, and deepen a foundation for studies in subsequent mathematics courses. Students will broaden their knowledge of functions and relationships, including linear, quadratic, square root, rational, cubic, cube root, exponential, absolute value, and logarithmic functions. Students will study these functions through analysis and application that includes explorations of patterns and structure, number and algebraic methods, and modeling from data using tools that build to workforce and college readiness such as probes, measurement tools, and software tools, including spreadsheets. ***This course satisfies the 3rd or 4th year Mathematics credit.***

Mathematical Applications in Agriculture, Food, and Natural Resources (CTAGMT)
10th-12th 1 credit 4.0

Prerequisite: *Required* Algebra I. *Recommended* one credit Ag, Food, & Natural Resources Program of Study

Course Description: Mathematical Applications in Agriculture, Food, and Natural Resources, students will apply knowledge and skills related to mathematics, including algebra, geometry, and data analysis in the context of agriculture, food, and natural resources. To prepare for careers in agriculture, food, and natural resources, students must acquire technical knowledge in the discipline as well as apply academic skills in mathematics. To prepare for success, students need opportunities to reinforce, apply, and transfer their knowledge and skills related to mathematics in a variety of contexts. This course satisfies the 3rd or 4th year math credit and is counted in the GPA as an academic elective. *This course satisfies the 3rd year Mathematics credit.*

Algebra II (MALG2)
10th – 12th 1 credit 4.0

Prerequisites: *Required* Algebra I

Course Description: In Algebra II, students will build on the knowledge and skills for mathematics in Kindergarten-Grade 8 and Algebra I. Students will broaden their knowledge of quadratic functions, exponential functions, and systems of equations. Students will study logarithmic, square root, cubic, cube root, absolute value, rational functions, and their related equations. Students will connect functions to their inverses and associated equations and solutions in both mathematical and real-world situations. In addition, students will extend their knowledge of data analysis and numeric and algebraic methods. Students will use technology to build understanding and make connections. It is highly recommended that students have access to a graphing tool, either a calculator or an online option, to work with on a daily basis. *To graduate on the Distinguished Level of Achievement and to also be eligible for top 10% automatic college acceptance, the student must take Algebra II. This course satisfies the 3rd or 4th year Mathematics credit.*

Algebra II Honors (MAL2HN)
10th-12th 1 credit 5.0

Prerequisites: *Required* Algebra I

Course Description: Students will broaden their knowledge of quadratic functions, exponential functions, and systems of equations. Students will study logarithmic, square root, cubic, cube root, absolute value, rational functions, and their related equations. Students will connect functions to their inverses and associated equations and solutions in both mathematical and real-world situations. In addition, students will extend their knowledge of data analysis and numeric and algebraic methods. Students will use technology to build understanding and make connections. It is highly recommended that students have access to a graphing tool, either a calculator or an online option, to work with on a daily basis. *To graduate on the Distinguished Level of Achievement and to also be eligible for top 10% automatic college acceptance, the student must take Algebra II. This course satisfies the 3rd or 4th year Mathematics credit.*

Advanced Quantitative Reasoning (AQR) (MTAQR)
11th – 12th 1 credit 4.0

Prerequisite: *Required* Algebra, Geometry, and Algebra II

Course Description: In Advanced Quantitative Reasoning, students will develop and apply skills necessary for college, careers, and life. Course content consists primarily of applications of high school mathematics concepts to prepare students to become well-educated and highly informed 21st century citizens. Students will develop and apply reasoning, planning, and communication to make decisions and solve problems in applied situations involving numerical reasoning, probability, statistical analysis, finance, mathematical selection, and modeling with algebra, geometry, trigonometry, and discrete mathematics. *This course satisfies the 3rd or 4th year Mathematics credit.*

Pre-Calculus (MPRCL)
11th – 12th 1 credit 4.0

Prerequisite: *Required* Algebra I, Geometry, and Algebra II

Course Description: Pre-Calculus is the preparation for calculus. The course approaches topics from a function point of view, where appropriate, and is designed to strengthen and enhance conceptual understanding and mathematical reasoning used when modeling and solving mathematical and real-world problems. Students systematically work with functions and their multiple representations. The study of Pre-Calculus deepens students' mathematical understanding and fluency with algebra and trigonometry and extends their ability to make connections and apply concepts and procedures at higher levels. Students investigate and explore mathematical ideas, develop multiple strategies for analyzing complex situations, and use technology to build understanding, make connections between representations, and provide support in solving problems. It is highly recommended that students have access to a graphing tool, either a calculator or an online option, to work with on a daily basis. *This course satisfies the 3rd or 4th year Mathematics credit.*

Pre-Calculus Honors (MPCHN)
11th-12th 1 credit 5.0

Prerequisite: *Required* Algebra I, Geometry, and Algebra II

Course Description: Pre-Calculus is the preparation for calculus. The course is function based specifically investigating exponential, logarithmic, rational, polynomial, power, trigonometric, inverse trigonometric, and piecewise defined functions, including step functions. Students systematically work with functions and their multiple representations. The study of Pre-Calculus deepens students' mathematical understanding and fluency with algebra and trigonometry and extends their ability to make connections and apply concepts and procedures at higher levels. Students investigate and explore mathematical ideas, develop multiple strategies for analyzing complex situations, and use technology to build understanding, make connections between representations, and provide support in solving problems. It is highly

recommended that students have access to a graphing tool, either a calculator or an online option, to work with on a daily basis. *This course satisfies the 3rd or 4th year Mathematics credit.*

AP Pre-Calculus (MPCAP)
11th-12th 1 credit 5.0

Prerequisite: *Recommended* Algebra I, Geometry, and Algebra II

Course Description: Pre-Calculus is the preparation for Calculus. In AP Precalculus, students will examine functions through multiple representations. Students will apply the mathematical tools they acquire in real-world modeling situations. By examining scenarios, conditions, and data sets and determining and validating an appropriate function model, students gain a deeper understanding of the nature and behavior of each function type. At the conclusion of this course, students may take the Advanced Placement Pre-Calculus Exam which provides students the opportunity to earn college credit. *This course satisfies the 3rd or 4th year Mathematics credit.*

Statistics (MSTAT)
10th – 12th 1 credit 4.0

Prerequisite: *Required* Algebra I

Course Description: In Statistics, students will build on the knowledge and skills for mathematics in Kindergarten-Grade 8 and Algebra I. Students will broaden their knowledge of variability and statistical processes. Students will study sampling and experimentation, categorical and quantitative data, probability and random variables, inference, and bivariate data. Students will connect data and statistical processes to real-world situations. In addition, students will extend their knowledge of data analysis. *This course satisfies the 3rd or 4th year Mathematics credit.*

AP Statistics (MSTAP)
11th – 12th 1 credit 5.0

Prerequisite: *Recommended* Algebra II and Geometry (Refer to Entrance Information Regarding Advanced Courses)

Course Description: This is an Advanced Placement course designed to meet the requirements of statistics as outlined in the Course Description of the Advanced Placement Program in Mathematics. The purpose of the AP course in statistics is to introduce students to the major concepts and tools for collecting, analyzing, and drawing conclusions from data. Students are exposed to four broad conceptual themes: exploring data, planning a study, anticipating patterns, and statistical inference. Students will use technology to build understanding and make connections. It is highly recommended that students have access to a graphing tool, either a calculator or an online option, to work with on a daily basis. At the conclusion of this course, students may take the Advanced Placement Calculus Exam which provides students the opportunity to earn college credit. *This course satisfies the 3rd or 4th year Mathematics credit.*

AP Calculus (AB) (MCLAP)
11th-12th 1 credit 5.0

Prerequisite: *Recommended* Pre-Calculus. (Refer to Entrance Information Regarding Advanced Courses)

Course Description: Advanced Placement Calculus is a course designed to meet the requirements of Calculus AB as outlined in the Course Description of the Advanced Placement Program in Mathematics. This course primarily develops the students' understanding of the concepts of calculus and provides experience with its methods and applications. Topics include limits, derivatives, integrals, and their applications. At the conclusion of this course, students may take the Advanced Placement Calculus Exam which provides students the opportunity to earn college credit. Graphing calculators will be extensively integrated in the coursework. It is highly recommended that students have access to a graphing tool, either a calculator or an online option, to work with on a daily basis. *This course satisfies the 3rd or 4th year Mathematics credit.*

College Algebra (MATH 1314) Dual Credit (MADC1)
11^h – 12th ½ credit 5.0

Prerequisite: *Required* Algebra I, Geometry and Algebra II; College eligibility per Blinn College guidelines

Course Description: This college level course for both high school and college credit will be offered through Blinn College. Students must meet placement requirements set by Blinn College, which may include testing at the student's expense. Students must pay the required fees for tuition, books, etc. A student may earn up to three (3) hours of college credit for taking this course each semester.

MATH 1314 College Algebra: In-depth study and applications of polynomial, rational, radical, exponential and logarithmic functions, and systems of equations using matrices. Additional topics such as sequences, series, probability, and conics may be included. *This course satisfies the 3rd or 4th year Mathematics credit. Fall*

College Trigonometry (MATH 1316) Dual Credit (MADC2)
11^h – 12th ½ credit 5.0

Prerequisite: *Required* Algebra I, Geometry and Algebra II; College eligibility per Blinn College guidelines

Course Description: This college level course for both high school and college credit will be offered through Blinn College. Students must meet placement requirements set by Blinn College, which may include testing at the student's expense. Students must pay the required fees for tuition, books, etc. A student may earn up to three (3) hours of college credit for taking this course each semester.

MATH 1316 (Trigonometry): In-depth study and applications of trigonometry including definitions, identities, inverse functions, solutions of equations, graphing, and solving triangles. Additional topics such as vectors, polar coordinates and parametric equations may be included. *This course satisfies the 3rd or 4th year of Mathematics credit. Spring*

Statistics (MATH 1342) Dual Credit (MASTDC)
11th – 12th ½ credit 5.0

Prerequisite: *Required* Algebra I, Geometry and Algebra II; College eligibility per Blinn College guidelines

Course Description: This college level course for both high school and college credit will be offered through Blinn College. Students must meet placement requirements set by Blinn College, which may include testing at the student's expense. Students must pay the required fees for tuition, books, etc. A student may earn up to three (3) hours of college credit for taking this course each semester.

MATH 1342 (Statistics): Collection, analysis, presentation and interpretation of data, and probability. Analysis includes descriptive statistics, correlation and regression, confidence intervals and hypothesis testing. Use of appropriate technology is recommended. ***This course satisfies the 3rd or 4th year Mathematics credit. Spring***

College Prep Math (MCPREP)

11th-12th 1 credit 4.0

Prerequisites: *Assessment information: 1) an end-of-course assessment instrument does not meet college readiness standards; or 2) coursework, a college entrance examination or an assessment instrument indicates that the student is not ready to perform entry-level college coursework.*

Course Description: Target students are those students failing to meet the college readiness standard as defined by House Bill 5, particularly students who did not take Algebra II or did not maintain a C average in Algebra II. For the ELAR and Mathematics College Preparatory Courses, a student earning a grade of 70 or above in a particular course will demonstrate proficiency in the course and will be eligible to enroll in an entry-level college level English composition or Mathematics course at Blinn College, up to twenty four (24) months after high school graduation. The student must enroll in the student's first college-level course in the exempted content area in the student's first year of enrollment at the IHE. If the student does not earn a grade of "C" or higher in the exempted content area, the student must be tested for the remaining area(s) and comply with all other Success Initiative requirements. Intermediate Algebra is the study of factoring rules, rational expressions, rational exponents, radicals, complex numbers, inequalities, inequalities containing absolute values, quadratic equations, linear equations, and equations with radicals, rational expressions, exponents, and functions. Calculator use is not recommended for this course (including the department final examination) as calculators are not allowed in classes when taught on campus. An average of C or better indicates the student has met the Blinn College criteria for Math 0312, and the student is prepared for Blinn College Math 1314, College Algebra, without further assessment remediation. ***This course satisfies the 4th year Mathematics credit.***

AP Computer Science A-LOTE (Languages Other Than English) and Math (TACSAP)(TACSAL)
11th & 12th 2 credits 5.0

Prerequisite: *Recommended* Algebra I

Course Description: Students continue the study of software design, writing well-designed well-structured computer programs that solve problems in the fields of Math and Science. Students will work in the Java programming language as the focus on the design and structure of Java classes. Students will also be introduced to advanced topics like Binary Trees, Graph Theory, and Digital Electronics. Students will prepare for the Computer Science Advanced Placement Exam. ***This course satisfies the 3rd or 4th year Mathematics credit as well as a LOTE credit for graduation.*** This course provides an opportunity to earn college credit upon completion of AP exam and receiving a satisfactory score. Students must co-enroll in Computer Science AP Math and LOTE.

Strategic Learning for High School Mathematics (MSTRAL)
9th – 10th ½ or 1 credit 4.0

Prerequisite: *Placement Only*

Course Description: This course is intended to create strategic mathematical learners from underprepared mathematics students. The basic understandings will stimulate students to think about their approach to mathematical learning. These basic understandings will include identifying errors in the teaching and learning process, input errors, physiological concerns, and key cognitive skills. The essential knowledge and skills will foster a deeper understanding of the task of learning mathematical concepts. Use of personal data and statistical analysis will establish relevance and aid in creation of individualized learning plans. ***This course is counted in the GPA as an academic elective.***

Accounting II

See Accounting. This course satisfies the 3rd or 4th Mathematics credit.

Robotics II

See Robotics II. This course satisfies the 3rd or 4th Mathematics credit.

SCIENCE

By the end of Grade 12, students are expected to gain sufficient knowledge of the scientific and engineering practices across the disciplines of science to make informed decisions using critical thinking and scientific problem solving.

2nd Year Options for Science Credit

Integrated Physics/Chemistry (IPC), Chemistry, Chemistry Honors, Physics, and AP Physics 1. Make sure you check the pre-requisites for each course.

3rd or 4th Year Options for Science Credit

AP Biology, Dual Credit Biology, Chemistry, Chemistry Honors, AP Chemistry, AP Environmental Science, AP Physics I, AP Physics II, Aquatic Science, Earth Systems Science, Environmental Systems, Anatomy/Physiology, Advanced Animal Science, Advanced Plant and Soil Science, Forensics, Pathophysiology. Make sure you check the prerequisites for each course.

Biology (SBLRG)
9th – 11th 1 credit 4.0

Prerequisite: None

Course Description: Students in Biology focus on patterns, processes, and relationships of living organisms through four main concepts: biological structures, functions, and processes; mechanisms of genetics; biological evolution; and interdependence within environmental systems. Students may be required to conduct dissections.

Biology Honors (SBLHN)
9th – 11th 1 credit 5.0

Prerequisite: None. (Refer to Entrance Information Regarding Advanced Courses)

Course Description: Students in Honors Biology focus on patterns, processes, and relationships of living organisms through four main concepts: biological structures, functions, and processes; mechanisms of genetics; biological evolution; and interdependence within environmental systems. Students may also be required to conduct dissections.

Integrated Physics/Chemistry (SINPC)
9th-10th 1 credit 4.0

Prerequisite: None

Course Description: In Integrated Physics and Chemistry, students conduct laboratory and field investigations, use engineering practices, use scientific practices during investigation, and make informed decisions using critical thinking and scientific problem solving. This course integrates the disciplines of physics and chemistry in the following topics: force, motion, energy, and matter. *This course satisfies the 2nd year Science credit.*

Chemistry (SCHRG)
10th-12th 1 credit 4.0

Prerequisite: Required one credit of high school science and Algebra I; *Recommended* completion of or concurrent enrollment in second year of math

Course Description. In Chemistry, students conduct laboratory and field investigations, use scientific practices during investigations, and make informed decisions using critical thinking and scientific problem solving. Students study a variety of topics that include characteristics of matter, use of the Periodic Table, development of atomic theory and chemical bonding, chemical stoichiometry, gas laws, solution chemistry, thermochemistry, and nuclear chemistry. Students will investigate how chemistry is an integral part of our daily lives. *This course satisfies the 2nd, 3rd, or 4th year Science credit.*

Chemistry Honors (SCHHN)
10th-12th 1 credit 5.0

Prerequisite: Required one credit of high school science and Algebra I; *Recommended* completion of or concurrent enrollment in the second year of math. (Refer to Entrance Information Regarding Advanced Courses).

Course Description: In Chemistry, students conduct laboratory and field investigations, use scientific practices during investigations, and make informed decisions using critical thinking and scientific problem solving. Students study a variety of topics that include characteristics of matter, use of the Periodic Table, development of atomic theory and chemical bonding, chemical stoichiometry, gas laws, solution chemistry, thermochemistry, and nuclear chemistry. Students will investigate how chemistry is an integral part of our daily lives. *This course satisfies the 2nd, 3rd, or 4th year Science credit.*

Physics (SPHYS)
9th – 12th 1 credit 4.0

Prerequisite: *Recommended* Algebra I or concurrent enrollment in Algebra I

Course Description: In Physics, students conduct laboratory and field investigations, use scientific practices during investigations, and make informed decisions using critical thinking and scientific problem solving. Students study a variety of topics that include: laws of motion; changes within physical systems and conservation of energy and momentum; forces; thermodynamics; characteristics and behavior of waves; and atomic, nuclear, and quantum physics. Students who successfully complete Physics will acquire factual knowledge within a conceptual framework, practice experimental design and interpretation. *This course satisfies the 2nd, 3rd, or 4th year Science credit.*

| | | |
|--|-----------------|-------------------------------|
| AP Physics I 10 th -12 th | 1 credit | (SPHAP) 5.0 |
| Prerequisite: <i>Recommended</i> Students should have completed Geometry and be concurrently taking Algebra II or an equivalent course (refer to Entrance Information regarding Advanced Courses) | | |
| Course Description: AP Physics is an algebra-based, introductory college-level physics course. Students cultivate their understanding of physics by developing models of physical phenomena through inquiry-based investigations. Students build their understanding of physical models as they explore and solve problems in these content areas: Kinematics, Forces & Translational Dynamics, Work, Energy, & Power, Linear Momentum, Torque & Rotational Dynamics, Energy & Momentum of Rotation Systems, Oscillations, and Fluids. AP Physics 1 is a full-year course that is the equivalent of a first-semester introductory college course based in algebra-based physics. <i>This course satisfies the 2nd, 3rd, or 4th year Science credit.</i> | | |
| AP Physics II 11 th -12 th | 1 credit | (SPHAP2) 5.0 |
| Prerequisite: <i>Recommended</i> Students should have completed AP Physics I or a comparable introductory physics course and be concurrently taking Pre-Calculus or an equivalent course (Refer to Entrance Information regarding Advanced Courses) | | |
| Course Description: AP Physics 2 is an algebra-based, introductory college-level physics course. Students cultivate their understanding of physics by developing models of physical phenomena through inquiry-based investigations. Students build their understanding of physical models as they explore and solve problems in these topics: Thermodynamics, Electric Force, Field, and Potential, Electric Circuits, Magnetism and Electromagnetism, Geometric Optics, Waves, Sound, and Physical Optics, and Modern Physics. AP Physics 2 is a full-year course that is the equivalent of a second-semester introductory college course in algebra-based physics. <i>This course satisfies the 3rd or 4th Science credit.</i> | | |
| Advanced Animal Science 11 th -12 th | 1 credit | (CTAAAS) 4.0 |
| Prerequisite: <i>Required</i> Biology and Chemistry or Integrated Physics and Chemistry (IPC); Algebra I and Geometry; and either Small Animal Management, Equine Science, or Livestock Production; <i>Recommended</i> Veterinary Medical Applications. | | |
| Course Description: Advanced Animal Science examines the interrelatedness of human, scientific and technological dimensions of livestock production. Instruction is designed to allow for the application of scientific and technological aspects of animal science through field and laboratory experiences. To prepare for careers in the field of animal science, students must attain academic skills and knowledge, acquire knowledge and skills relating to animal systems, and develop knowledge and skills regarding career opportunities, entry requirements, and industry standards. To prepare for success, students need opportunities to learn, reinforce, apply, and transfer their knowledge and skills in a variety of settings. To receive credit in Science, students must meet the 40% laboratory and fieldwork requirement. <i>This course satisfies the 3rd or 4th year Science credit.</i> | | |
| Advanced Plant and Soil Science 11 th -12 th | 1 credit | (CTAAPS) 4.0 |
| Prerequisite: <i>Recommended</i> Biology, Integrated Physics and Chemistry (IPC), Chemistry, or Physics and a minimum of one credit from the courses in the Agriculture, Food, and Natural Resources Career Cluster. | | |
| Course Description: Advanced Plant and Soil Science provides a way of learning about the natural world. Students should know how plant and soil science has influenced a vast body of knowledge, that there are still applications to be discovered, and that plant and soil science is the basis for many other fields of science. To prepare for careers in plant and soil science, students must attain academic skills and knowledge, acquire technical knowledge and skills related to plant and soil science and the workplace, and develop knowledge and skills regarding career opportunities, entry requirements, and industry expectations. To prepare for success, students need opportunities to learn, reinforce, apply, and transfer their knowledge and skills and technologies in a variety of settings. <i>This course satisfies the 3rd or 4th Science credit.</i> | | |
| Anatomy and Physiology 10 th – 12 th | 1 credit | (CTAPR) 4.0 |
| Prerequisite: <i>Required</i> Biology and one credit in Chemistry, IPC, or Physics); <i>Recommended</i> a course from the Health Science Career Cluster. | | |
| Course Description: The Anatomy and Physiology course is designed for students to conduct laboratory and field investigations, use scientific methods during investigations, and make informed decisions using critical thinking and scientific problem solving. Students in Anatomy and Physiology will study a variety of topics, including the structure and function of the human body and the interaction of body systems for maintaining homeostasis. <i>This course satisfies the 3rd or 4th year Science credit.</i> | | |
| AP Environmental Science 11 th - 12 th | 1 credit | (SAPESA) 5.0 |
| Prerequisite: <i>Recommended</i> Algebra I and two years of high school laboratory science including one year of life science and one year of physical science. (Refer to Entrance Information Regarding Advanced Courses) | | |
| Course Description: The AP Environmental Science course is designed to engage students with the scientific principles, concepts, and methodologies required to understand the interrelationships within the natural world. The course requires that students identify and analyze natural and human-made environmental problems, evaluate the relative risks associated with these problems, and examine alternative | | |

solutions for resolving or preventing them. Environmental science is interdisciplinary, embracing topics from geology, biology, environmental studies, environmental science, chemistry, and geography. The AP Environmental Science course is designed to be the equivalent of a one-semester, introductory college course in environmental science. *This course satisfies the 3rd or 4th year Science credit.*

AP Chemistry (SCHAP)
11th-12th 1 credit 5.0

Prerequisite: *Recommended* Students should have successfully completed an introductory high school Chemistry course and Algebra II, or an equivalent course. (Refer to Entrance Information Regarding Advanced Courses)

Course Description: The AP Chemistry course provides students with a college-level foundation to support future advanced coursework in chemistry. Students cultivate their understanding of chemistry through inquiry-based investigations, as they explore content such as: Atomic Structure and Properties, Compound Structure and Properties, Properties of Substances and Mixtures, Chemical Reactions, Kinetics, Thermochemistry, Equilibrium, Acids and Bases, Thermodynamics, and Electrochemistry. The AP Chemistry course is designed to be the equivalent of the general chemistry course usually taken during the first college year. *This course satisfies the 3rd or 4th year Science credit.*

Aquatic Science (SAQUS)
10th-12th 1 credit 4.0

Prerequisite: *Required* Biology *Recommended* IPC, Chemistry, or concurrent enrollment in either.

Course Description: In Aquatic Science, students study the interactions of biotic and abiotic components in aquatic environments, including natural and human impacts on aquatic systems. Investigations and field work in this course may emphasize freshwater or marine aspects of aquatic science depending primarily upon the natural resources available for study near the school. Students who successfully complete Aquatic Science acquire knowledge about how the properties of water and fluid dynamics affect aquatic ecosystems and acquire knowledge about a variety of aquatic systems. Students who successfully complete Aquatic Science conduct investigations and observations of aquatic environments, work collaboratively with peers, and develop critical-thinking and problem-solving skills. *This course satisfies the 3rd or 4th year Science credit.*

AP Biology (SBLAP)
11th – 12th 1 credit 5.0

Prerequisite: *Recommended* Biology and Chemistry. (Refer to Entrance Information Regarding Advanced Courses)

Course Description: AP Biology course is an introductory college-level biology course. Students cultivate their understanding of biology through inquiry-based investigations as they explore the following topics: evolution, cellular processes, energy and communication, genetics, information transfer, ecology, and interactions. The AP Biology course is equivalent to a two-semester college introductory biology course for biology majors. *This course satisfies the 3rd or 4th year Science credit.*

Biology Dual Credit (BIOL 1406 & 1407)- Scientific Research & Design (SB1406)(SB1407)
11th – 12th 1 credit 5.0

Prerequisite: College eligibility per Blinn College guidelines

Course Description: This college level course for both high school and college credit will be offered through Blinn College. Students must meet placement requirements set by Blinn College, which may include testing at the student's expense. Students must pay the required fees for tuition, books, etc. A student may earn up to four (4) hours of college credit for taking this course each semester.

BIOL 1406: Fundamental principles of living organisms will be studied, including physical and chemical properties of life, organization, function, evolutionary adaptation, and classification. Concepts of cytology, reproduction, genetics, and scientific reasoning are included. Lab activities reinforce lecture topics. **Fall**

BIOL 1407: The diversity and classification of life will be studied, including animals, plants, protists, fungi, and prokaryotes. Special emphasis will be given to anatomy, physiology, ecology, and evolution of plants and animals. Lab activities reinforce lecture topics. **Spring.** *Due to the number of instructional minutes required by Blinn College for this course, students will be required to complete one hour of outside coursework per week. This course satisfies the 3rd or 4th year Science credit.*

Earth Systems Science (SESS)
11th -12th 1 credit 4.0

Prerequisite: *Required* Algebra and two credits of high school Science

Course Description: The Earth Systems Science course is designed to build on students' prior scientific and academic knowledge and skills to develop their understanding of Earth's systems. These systems (the atmosphere, hydrosphere, geosphere, and biosphere) interact through time to produce the Earth's landscapes, climate, and resources. Students explore the geologic history of individual dynamic systems through the flow of energy and matter, their current states, and how these systems affect and are affected by human use. *This course satisfies the 3rd or 4th year Science credit.*

Environmental Systems (SEN12)
10th-12th 1 credit 4.0

Prerequisite: *Required* Biology, *Recommended* Integrated Physics and Chemistry (IPC), Chemistry, or concurrent enrollment in either course.

Course Description: In Environmental Systems, students conduct laboratory and field investigations, use scientific methods during investigations, and make informed decisions using critical thinking and scientific problem solving. Students study a variety of topics that include biotic and abiotic factors in habitats, ecosystems and biomes, interrelationships among resources and an environmental system,

sources, and flow of energy through an environmental system, relationship between carrying capacity and changes in populations and ecosystems, natural changes in the environment, and human activities that impact the natural environment. *This course satisfies the 3rd or 4th year Science credit.*

Pathophysiology (CTPATH)
 11th - 12th 1 credit 4.0

Prerequisite: *Required* Biology, Chemistry, and at least one credit in a level 2 or higher course from the health science career cluster.; *Recommended* Anatomy and Physiology.

Course Description: The Pathophysiology course is designed for students to conduct laboratory and field investigations, use scientific methods during investigations, and make informed decisions using critical thinking and scientific problem solving. Students in Pathophysiology will study disease processes and how humans are affected. Emphasis is placed on prevention and treatment of disease. Students will differentiate between normal and abnormal physiology. *This course satisfies the 3rd or 4th year Science credit.*

Forensic Science (CTFORE)
 11th-12th 1 credit 4.0

Prerequisite: *Required* Biology and one credit of IPC, Chemistry, or Physics

Course Description: Forensic Science is a survey course that introduces students to the application of science to law. Students learn terminology and procedures related to the collection and examination of physical evidence using scientific processes performed in a field or laboratory setting. Students also learn the history and the legal aspects of forensic science. Using scientific methods, students will collect and analyze evidence such as fingerprints, bodily fluids, hairs, fibers, paint, glass, and cartridge cases. Students must meet the 40% laboratory and fieldwork requirement. *This course satisfies the 3rd or 4th year Science graduation requirement.*

SOCIAL STUDIES

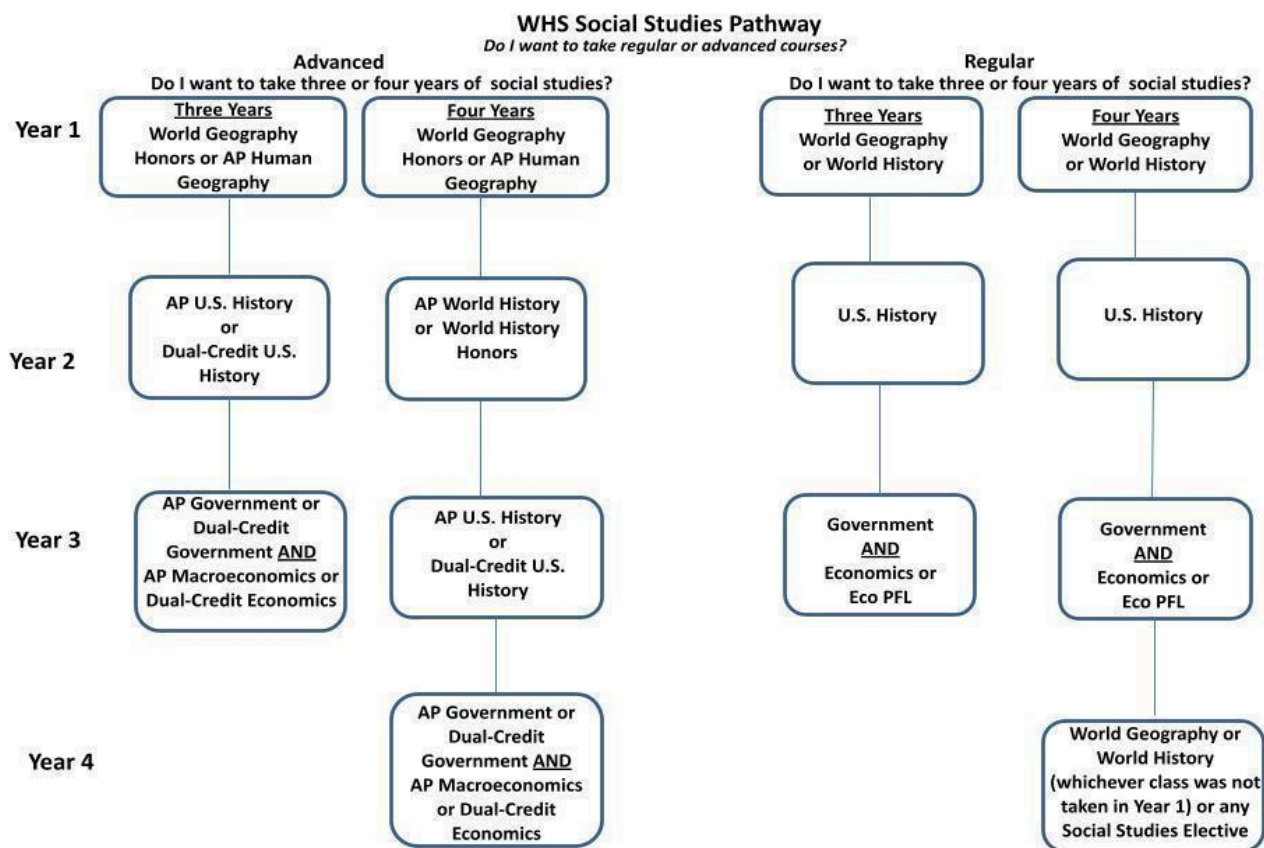

*Three years of social studies meets the Foundation High School Plan graduation requirements. Depending on your endorsements or university admission requirements, a student may need three or four years of social studies. Always verify university admission requirements because most universities require high school graduates to have four years of social studies.

*Dual Credit Courses – Always verify that your potential university accepts Texas community college dual credit courses.

World Geography Studies (HWGRG)
 9th – 12th 1 credit 4.0
Prerequisite: None
Description: In World Geography Studies, students examine people, places, and environments at local, regional, national, and international scales from the spatial and ecological perspectives of geography. Students describe the influence of geography on events of the past and present with emphasis on contemporary issues. A significant portion of the course centers around the physical processes that shape patterns in the physical environment; the characteristics of major landforms, climates, and ecosystems and their interrelationships; the political, economic, and social processes that shape cultural patterns of regions; types and patterns of settlement; the distribution and movement of the world population; relationships among people, places, and environments; and the concept of region. Students analyze how location affects economic activities in different economic systems. Students identify the processes that influence political divisions of the planet and analyze how different points of view affect the development of public policies. Students compare how components of culture shape the characteristics of regions and analyze the impact of technology and human modifications on the physical environment. Students use problem-solving and decision-making skills to ask and answer geographic questions. *As of the 2015- 2016 school year, the one-credit AP Human Geography course must provide instruction in the TEKS for World Geography, and students are not able to earn credit for both World Geography Studies and the one-credit AP Human Geography course.*

World Geography Honors (HWGHN)
 9th – 12th 1 credit 5.0
Prerequisite: None (Refer to Entrance Information Regarding Advanced Courses)
Course Description: In World Geography Studies, students examine people, places, and environments at local, regional, national, and international scales from the spatial and ecological perspectives of geography. Students describe the influence of geography on events of the past and present with emphasis on contemporary issues. A significant portion of the course centers around the physical processes that shape patterns in the physical environment; the characteristics of major landforms, climates, and ecosystems and their interrelationships; the political, economic, and social processes that shape cultural patterns of regions; types and patterns of settlement; the distribution and movement of the world population; relationships among people, places, and environments; and the concept of region. Students analyze how location affects economic activities in different economic systems. Students identify the processes that influence political divisions of the planet and analyze how different points of view affect the development of public policies. Students compare how components of culture shape the characteristics of regions and analyze the impact of technology and human modifications on the physical environment. Students use problem-solving and decision-making skills to ask and answer geographic questions. *As of the 2015- 2016 school year, the one-credit AP Human Geography course must provide instruction in the TEKS for World Geography, and students are not able to earn credit for both World Geography Studies and the one-credit AP Human Geography course.*

AP Human Geography (HHMGAP)
 9th – 12th 1 credit 5.0
Prerequisite: None (Refer to Entrance Information Regarding Advanced Courses)
Course Description: The purpose of the AP course in Human Geography is to introduce students to the systematic study of patterns and processes that have shaped human understanding, use, and alteration of Earth’s surface. Students employ spatial concepts and landscape analysis to analyze human social organization and its environmental consequences. They also learn about the methods and tools geographers use in their science and practice. This course provides the opportunity to earn college credit upon satisfactory performance on the AP exam. Please check the College Board website to see information on how credits transfer to universities. *As of the 2015- 2016 school year, the one-credit AP Human Geography course must provide instruction in the TEKS for World Geography, and students are not able to earn credit for both World Geography Studies and the one-credit AP Human Geography course.*

World History Studies (HWHRG)
 9th – 12th 1 credit 4.0
Prerequisite: None
Course Description: World History Studies is a survey of the history of humankind. Due to the expanse of world history and the time limitations of the school year, the scope of this course should focus on "essential" concepts and skills that can be applied to various eras, events, and people within the standards in subsection (c) of this section. The major emphasis is on the study of significant people, events, and issues from the earliest times to the present. Traditional historical points of reference in world history are identified as students analyze important events and issues in western civilization as well as in civilizations in other parts of the world. Students evaluate the causes and effects of political and economic imperialism and of major political revolutions since the 17th century. Students examine the impact of geographic factors on major historic events and identify the historic origins of contemporary economic systems. Students analyze the process by which constitutional governments evolved as well as the ideas from historic documents that influenced that process. Students trace the historical development of important legal and political concepts. Students examine the history and impact of major religious and philosophical traditions. Students analyze the connections between major developments in science and technology and the growth of industrial economies, and they use the process of historical inquiry to research, interpret, and use multiple sources of evidence. *Students can take either World History Honors or AP World History: Modern to satisfy the World History credit, and students are not able to earn credit for both World History Honors and the one-credit AP World History course.*

| | | |
|---|-----------------|--------------------------------------|
| World History Honors 9 th – 12 th | 1 credit | (HWHHN) 5.0 |
| Prerequisite: <i>None</i> (Refer to Entrance Information Regarding Advanced Courses) | | |
| Course Description: World History Studies is a survey of the history of humankind. Due to the expanse of world history and the time limitations of the school year, the scope of this course should focus on "essential" concepts and skills that can be applied to various eras, events, and people within the standards in subsection (c) of this section. The major emphasis is on the study of significant people, events, and issues from the earliest times to the present. Traditional historical points of reference in world history are identified as students analyze important events and issues in western civilization as well as in civilizations in other parts of the world. Students evaluate the causes and effects of political and economic imperialism and of major political revolutions since the 17th century. Students examine the impact of geographic factors on major historic events and identify the historic origins of contemporary economic systems. Students analyze the process by which constitutional governments evolved as well as the ideas from historic documents that influenced that process. Students trace the historical development of important legal and political concepts. Students examine the history and impact of major religious and philosophical traditions. Students analyze the connections between major developments in science and technology and the growth of industrial economies, and they use the process of historical inquiry to research, interpret, and use multiple sources of evidence. <i>Students can take either World History Honors or AP World History: Modern to satisfy the World History credit, and students are not able to earn credit for both World History Honors and the one-credit AP World History course.</i> | | |
| AP World History 10 th – 12 th | 1 credit | (HWHIAP) 5.0 |
| Prerequisite: <i>None</i> (Refer to Entrance Information Regarding Advanced Courses) | | |
| Course Description: AP World History: Modern focuses on developing students' abilities to think conceptually about world history from approximately 8000 BCE to the present and apply historical thinking skills as they learn about the past. Five themes of equal importance focusing on the environment, cultures, state-building, economic systems, and social structures provide areas of historical inquiry for investigation throughout the course. AP World History Modern encompasses the history of the five major geographical regions of the globe: Africa, the Americas, Asia, Europe, and Oceania, with special focus on historical developments and processes that cross multiple regions. This course provides the opportunity to earn college credit upon satisfactory performance on the AP exam. Please check with each university for score requirements. <i>Students can take either World History Honors or AP World History: Modern to satisfy the World History credit, and students are not able to earn credit for both World History Honors and the one-credit AP World History course.</i> | | |
| United States History Studies Since 1877 10 th -11 th | 1 credit | (HUSRG) 4.0 |
| Prerequisite: <i>None</i> | | |
| Course Description: In United States History Studies Since 1877, which is the second part of a two-year study that begins in Grade 8, students study the history of the United States from 1877 to the present. The course content is based on the founding documents of the U.S. government, which provide a framework for its heritage. Historical content focuses on the political, economic, and social events and issues related to industrialization and urbanization, major wars, domestic and foreign policies, and reform movements, including civil rights. Students examine the impact of geographic factors on major events and eras and analyze their causes and effects. Students examine the impact of constitutional issues on American society, evaluate the dynamic relationship of the three branches of the federal government, and analyze efforts to expand the democratic process. Students describe the relationship between the arts and popular culture and the times during which they were created. Students analyze the impact of technological innovations on American life. Students use critical-thinking skills and a variety of primary and secondary source material to explain and apply different methods that historians use to understand and interpret the past, including multiple points of view and historical context. | | |
| AP United States History 10 th -11 th | 1 credit | (HUSAP) 5.0 |
| Prerequisite: <i>None</i> (Refer to Entrance Information Regarding Advanced Courses) | | |
| Course Description: This college level course is a required study of the nation's economic, social, and political development. It is designed to give students an understanding of the issues that have grown out of the significant events in the nation's history, of the forces that have helped shape our political, social, and economic institutions and the ways in which each generation has approached solutions to the problems. Students will learn to think about history in an analytical way. This course also requires outside reading and independent study and research. This course covers material from the Age of Discovery to the present. This course provides the opportunity to earn college credit upon satisfactory performance on the AP exam. Please check with each university for score requirements. | | |
| United States History (HIST 1301 & HIST 1302) Dual Credit 10 th -12 th | 1 credit | (H1301)/(H1302) 5.0 |
| Prerequisite: <i>College eligibility per Blinn College guidelines</i> | | |
| Course Description: This college level course for both high school and college credit will be offered through Blinn College. Students must meet placement requirements set by Blinn College, which may include testing at the student's expense. Students must pay the required fees for tuition, books, etc. A student may earn up to three (3) hours of college credit for taking this course each semester. | | |
| HIST 1301: A survey of United States history that begins with the migrations of people to the western hemisphere and continues through the Civil War and Reconstruction period. The course focuses on the periods of discovery, colonization, revolution, and nation building. Material presented covers a wide variety of topics encompassing social, cultural, intellectual, military, and political history. 48 contact hours. Credit: Three semester hours. Fall | | |

HIST 1302: A survey of United States history from 1877 to the present. The course covers industrial, social, and political problems from 1877 to the emergence of the United States as a world power in the twentieth century. Material presented covers a wide variety of topics including the Gilded Age, the Progressive Period, World War I, the Depression and the New Deal, World War II, the Cold War, and contemporary events. 48 contact hours. Credit: Three semester hours. **Spring**

United States Government (HGOVRG)
11th-12th ½ credit 4.0

Prerequisite: *None*

Course Description: The focus is on the principles and beliefs upon which the United States was founded and on the structure, functions, and powers of government at the national, state, and local levels. Students learn major political ideas and forms of government in history. A significant focus of the course is on the U.S. Constitution, its underlying principles and ideas, and the form of government it created. Students analyze major concepts of republicanism, federalism, checks and balances, separation of powers, popular sovereignty, and individual rights and compare the U.S. system of government with other political systems. Students identify examples of government policies that encourage scientific research and use critical- thinking skills to create a product on a contemporary government issue.

AP United States Government and Politics (HGOVAP)
11th-12th ½ credit 5.0

Prerequisite: *None* (Refer to Entrance Information Regarding Advanced Courses)

Course Description: AP United States Government and Politics is a one semester, college level, intensive study of the formal and informal structure of American Government and the processes of the American political system with an emphasis on policy- making and implementation. This course includes both the general concepts used to interpret U.S. politics and the analysis of specific examples. This course provides the opportunity to earn college credit upon satisfactory performance on the AP exam. Please check with each university for score requirements.

Federal Government (GOVT 2305) Dual Credit (HG2305)
11th-12th ½ credit 5.0

Prerequisite: College eligibility per Blinn College guidelines

Course Description: This course for both high school and college credit will be offered through Blinn College. Students must meet placement requirements set by Blinn College, which may include testing at the student's expense. Students must pay the required fees for tuition, books, etc. An examination of the institutional elements of the American political system: legislature, executive, judiciary, and bureaucracy. These elements are examined at the national, state, and local levels with a special emphasis on their roles in the development of public policy. A student may earn up to three (3) hours of college credit for taking this course.

GOVT 2305: Government 2305 is a study of the organization, functions, and administration of the several branches and agencies of the national government, including a study of the federal constitution. The primary factors considered relate to the three branches of government – judicial, executive, legislative – major historical documents, the events that shaped the nation, and current events. Emphasis will be placed on the interaction of these subsystems. 48 contact hours. Credit: Three semester hours. **Fall**

State Government (GOVT 2306) Dual Credit- Special Topics in Social Studies (HG2306)
11th-12th ½ credit 5.0

Prerequisite: *College eligibility per Blinn College guidelines*

Course Description: This course for both high school and college credit will be offered through Blinn College. Students must meet placement requirements set by Blinn College, which may include testing at the student's expense. Students must pay the required fees for tuition, books, etc. This course will cover the Special Topics in Social Studies TEKS, as well as Celebrate Freedom Week, which educates students about the sacrifices made for freedom in the founding of this country and the values on which this country was founded. A student may earn up to three (3) hours of college credit for taking this course during the summer in addition to high school Social Studies elective credit for "Special Topics in Social Studies."

GOVT 2306: Government 2306 is a study of the organization, functions, and administration of the several branches and bureaucracy of the Texas state and local government, including a study of the numerous Texas constitutions. The primary factors considered relate to the three branches of government – judicial, executive, legislative – current Texas Constitution, events that shaped the state, and current events. Emphasis will be placed on the interaction of these subsystems. 48 contact hours. Credit: Three semester hours. **Spring**

Economics (HECORG)
11th – 12th ½ credit 4.0

Prerequisite: *None*

Course Description: The focus is on the basic principles concerning production, consumption, and distribution of goods and services (the problem of scarcity) in the United States and a comparison with those in other countries around the world. Students analyze the interaction of supply, demand, and price. Students will investigate the concepts of specialization and international trade, economic growth, key economic measurements, and monetary and fiscal policy. Students will study the roles of the Federal Reserve System and other financial institutions, government, and businesses in a free enterprise system. Types of business ownership and market structures are discussed. The course also incorporates instruction in personal financial literacy. Students apply critical-thinking skills using economic concepts to evaluate the costs and benefits of economic issues.

Personal Financial Literacy and Economics (HPFECO)
11th – 12th ½ credit 4.0

Prerequisite: None

Course Description: The Personal Financial Literacy and Economics Course emphasizes the economic way of thinking, which serves as a framework for the personal financial decision-making opportunities introduced in the course. Students will demonstrate the ability to anticipate and address financial challenges as these challenges occur over their lifetime. In addition, students are introduced to common economic and personal financial planning terms and concepts. As a result of learning objective concepts and integrating subjective information, students gain the ability to lead productive and financially self-sufficient lives. This class meets the state Economics requirement. *Students may not be awarded credit for both this course and the Personal Financial Literacy course.*

AP Macroeconomics (HECOMP)
11th-12th ½ credit 5.0

Prerequisite: None (Refer to Entrance Information Regarding Advanced Courses)

Course Description: This course introduces students to the principles of economics that apply to an economic system in the aggregate. Emphasis is placed on the study of national income, fiscal and Federal Reserve policy. It also develops the student's familiarity with economic performance measures, economic growth and international economics. It is extremely useful in understanding the extraordinary changes that the world is undergoing today. A strong math background is recommended for the success of this course. This course provides the opportunity to earn college credit upon satisfactory performance on the AP exam. Please check with each university for score requirements.

Macroeconomics (ECON 2301) Dual Credit (HE2301)
11th-12th ½ credit 5.0

Prerequisite:

Course Description: This course for both high school and college credit will be offered through Blinn College. Students must meet placement requirements set by Blinn College, which may include testing at the student's expense. Students must pay the required fees for tuition, books, etc. This course will cover the Economics TEKS. A student may earn up to three (3) hours of college credit for taking this course during the summer in addition to high school credit for Economics.

ECON 2301: An analysis of the economy as a whole including measurement and determination of Aggregate Demand and Aggregate Supply, national income, inflation, and unemployment. Other topics include international trade, economic growth, business cycles, and fiscal policy and monetary policy. **Summer.**

Personal Financial Literacy (HPFLIT)
10th-12th ½ credit 4.0

Prerequisite: None

Course Description: Personal Financial Literacy will develop citizens who have the knowledge and skills to make sound, informed financial decisions that will allow them to lead financially secure lifestyles and understand personal financial responsibility. The knowledge gained in this course has far-reaching effects for students personally as well as the economy as a whole. When citizens make wise financial decisions, they gain opportunities to invest in themselves, build businesses, consume goods and services in a responsible way, and secure a future without depending on outside assistance. The economy benefits from the optimal use of resources, increased consumption, and strong local businesses. State and local governments benefit with steady revenue streams and reduced future obligations as our society ages. *Students may not be awarded credit for both this course and the Personal Financial Literacy and Economics course. This course will count into the GPA as an academic elective.*

AP European History (HEHAP)
11th – 12th 1 credit 5.0

Prerequisite: None

Description: Students will learn about the cultural, economic, political, and social developments that have shaped today's world through the study of European history from the year 1450 to the present. They will analyze historical evidence and interpretation and express your historical understanding through writing as they explore principal themes of modern European history. This course provides the opportunity to earn college credit upon satisfactory performance on the AP exam. Please check with each university for score requirements. *This course will count into the GPA as an academic elective.*

Psychology (HPSYRG)
11th – 12th ½ credit 4.0

Prerequisite: None

Course Description: In Psychology, an elective course, students study the science of behavior and mental processes. Students examine the full scope of the science of psychology such as the historical framework, methodologies, human development, motivation, emotion, sensation, perception, personality development, cognition, learning, intelligence, biological foundations, mental health, and social psychology. *This course will count into the GPA as an academic elective.*

Psychology Honors/AP Psychology**(HPSYAP)/(HPSYHN)**11th – 12th**1 credit****5.0****Prerequisite:** *None* (Refer to Entrance Information Regarding Advanced Courses) *Corequisite* Psychology Honors**Course description:** The AP Psychology course is designed to introduce students to the systematic and scientific study of the behavior and mental processes of human beings and other animals. Students are exposed to the psychological facts, principles, and phenomena associated with each of the major subfields within psychology. They also learn about the ethics and methods psychologists use in their science and practice. The aim of the course is to provide the student with a learning experience equivalent to that obtained in most college introductory psychology courses. This course provides the opportunity to earn college credit upon satisfactory performance on the AP exam. Please check with each university for score requirements. ***This course will count into the GPA as an academic elective.*****Sociology****(HSOCRG)**11th–12th**½ credit****4.0****Prerequisite:** *None***Course Description:** Sociology, an elective course, is an introductory study in social behavior and organization of human society. This course will describe the development of the field as a social science by identifying methods and strategies of research leading to an understanding of how the individual relates to society and the ever-changing world. Students will also learn the importance and role of culture, social structure, socialization, and social change in today's society. ***This course will count into the GPA as an academic elective.***

HEALTH/PHYSICAL EDUCATION

Health

(HHLTH)**Health**9th – 12th**½ credit****Prerequisite:** *None***Course Description:** Provides opportunities for students to acquire facts, to develop proper attitudes, and to establish practices and habits that contribute to personal and community health. Students will also have the opportunity to be certified in Adult CPR/AED and First Aid through the American Red Cross. With parent permission, this course may be delayed until 11th or 12th grade.

Physical Education

Fitness TestsSenate Bill 8, passed by the Texas Legislature in 2011 requires that each student enrolled in PE credit courses in grades 3-12 be given an annual fitness test. The instrument to be used is the Fitness Gram which includes Body Mass Index, cardiovascular test (one mile run/walk), curl ups, push-ups, shoulder stretch, and trunk lift. **Students in PE are required to dress in appropriate personal athletic clothing and athletic footwear.****Off Campus Physical Activity****(OFFPE1)(OFFPE2)(OFFPE3)(OFFPE4)**Private or commercially sponsored physical activity programs may be substituted for physical education credits in grades 9-12, if substitute facility is approved by the school district and the Texas Education Agency. See your school counselor for information regarding Level I or II off campus physical activity substitutes. *Requests for this must be made no later than the last day of the spring semester of the previous year for the fall semester and December 1st for the spring semester to the student's counselor.***Lifetime Fitness and Wellness Pursuits****(PHLFW)**9th – 12th**1 credit****Prerequisite:** *None***Course Description:** The Lifetime Fitness and Wellness Pursuits course offers current approaches for the foundation of personal fitness, wellness, physical literacy, lifetime wellness, and healthy living. Students in Lifetime Fitness and Wellness Pursuits will apply the knowledge and skills to demonstrate mastery of the concepts needed to achieve lifetime wellness. Students will participate in a variety of physical activities for attaining personal fitness and lifetime wellness. **Students in PE are required to dress in appropriate personal athletic clothing and athletic footwear.****Skill-Based Lifetime Activities****(PHSBLA)**9th – 12th**1 credit****Prerequisite:** *None***Course Description:** The Skill-Based Lifetime Activities course offers students the opportunity to demonstrate mastery in basic skills, basic sport knowledge, and health and fitness principles. Students experience opportunities that promote physical literacy and lifetime wellness. Students in Skill-Based Lifetime Activities will participate in at least one activity from the following categories: Target games, striking and fielding games, fitness activities, rhythmic activities, and innovative games/international games. **Students in PE are required to dress in appropriate personal athletic clothing and athletic footwear.**

Competitive Athletics

One unit of credit from athletics may be substituted for the Physical Education requirement and the three other units of credit may count as state electives.

If a student/athlete is dismissed from athletics due to behavior/ discipline problems, grade deficiencies etc., or if a student quits athletics, a schedule change to a physical education class may be requested by the athletic coordinator.

Boys' Athletics

9th – 12th

½-1 credit

Football

(PHB1)(PHB2)(PHB3)(PHB4)

Soccer

(PHBS1)(PHBS2)(PHBS3) (PHBS4)

Wrestling

(PHWR1)(PHWR2)(PHWR3)(PHWR4)

Cross Country

(PHCC1)(PHCC2)(PHCC3)(PHCC4)

Tennis

(PHTN1)(PHTN2)(PHTN3)(PHTN4)

Track

(PHBTK1)(PHBTK2)(PHBTK3)(PHBTK4)

Baseball

(PHBBS1)(PHBBS2)(PHBBS3)(PHBBS4)

Basketball

(PHBBK1)(PHBBK2)(PHBBK3)(PHBBK4)

Prerequisite: Tryouts or Coach Request; **Current Athletic Physical on file with Athletic Training staff.**

Practice time: 3:00 p.m. until 6:00 p.m., or as determined by the coach. Some Saturdays

Course Description: Includes mandatory after-school training and/or before school, participation in competitive sports and off-season training. Off-season is NOT a weight training class. Students are responsible for all equipment issued and must pay for equipment not returned. Students are required to get a new physical each school year.

- Athletics – Participants should be enrolled in Fall and Spring semesters.
- Golf and Powerlifting participants will practice after school during their respective seasons. Participants are not required to be in the athletic period.

Girls' Athletics

9th-12th

½-1 credit

Soccer

(PHGS1)(PHGS2)(PHGS3)(PHGS4)

Wrestling

(PHWR1)(PHWR2)(PHWR3)(PHWR4)

Cross Country

(PHCC1)(PHCC2)(PHCC3)(PHCC4)

Tennis

(PHTN1)(PHTN2)(PHTN3)(PHTN4)

Track

(PHGTK1)(PHGTK2)(PHGTK3)(PHGTK4)

Volleyball

(PHVB1)(PHVB2)(PHVB3)(PHVB4)

Basketball

(PHGBK1)(PHGBK2)(PHGBK3)(PHGBK4)

Softball

(PHGSB1)(PHGSB2)(PHGSB3)(PHGSB4)

Prerequisite: Tryouts or Coach Request; **Current Athletic Physical on file with Athletic Training staff.**

Practice time: 3:00 p.m. until 6:00 p.m., or as determined by the coach. Some Saturdays

Course Description: Includes mandatory after-school training and/or before school, participation in competitive sports and off-season training. Off season is NOT a weight training class. Students are responsible for all equipment issued and must pay for equipment not returned. Students are required to get a new physical each school year.

- Athletics – Participants should be enrolled in Fall and Spring semesters.
- Golf and Powerlifting participants will practice after school during their respective seasons. Participants are not required to be in the athletic period.

Cheerleading

9th-12th

Year-1 PE substitution (PHCIA)
Year 2, 3, 4-LOCALELECTIVE(PHCH2A)(PHCH3A)(PHCH4A)

Prerequisites: Tryout selection during the previous spring

Course Description: Students selected for the team are required to attend summer camp and summer practices. Students must be enrolled in this course to participate in the cheerleading program. Students are required to attend practices, sports, events, parades, and special events which are outside of the school day. All cheerleaders must adhere to program requirements as stated in the cheerleading constitution. **During year 1, this course is for PE Substitution Credit. During year 2, 3, 4, this course is for LOCAL credit and WILL NOT count towards graduation.**

Sports Medicine I

9th-12th

1 credit

(PHSM1)

Prerequisite: Licensed Athletic Trainer Approval.

Course Description: This course provides an opportunity for the study and application of the components of sports medicine but not limited to sports medicine related careers, organizational and administrative considerations, prevention of athletic injuries, rehabilitation and management skills, taping and wrapping techniques, first aid/CPR/AED, emergency procedures, nutrition, sports psychology, human anatomy and physiology, therapeutic modalities, and therapeutic exercise. Students will be required to help with practice and game setup during class period. Practice and game coverage is required. Students must be available for before- and after-school treatments, practices, games, and clinics held on Saturday and during the summer. **This course will not count for PE credit.**

Sports Medicine II**(PHSM2)****10th-12th****1 credit****Prerequisite:** *Required* Sports Medicine I; Must be in Athletic Training Program; Licensed Athletic Trainer Approval.**Course Description:** This course is designed for athletic training students. It provides an in-depth study and application of the components of sports medicine including but not limited to basic rehabilitative techniques, therapeutic modalities, wound care, taping and bandaging techniques, prevention, recognition and care of musculoskeletal injuries; injuries to the young athlete; drugs in sports; modern issues in sports medicine. Individualized and independent assignments will be included in this course. This course will involve outside-of-class time homework and time required working with athletes and athletic teams. Students will be required to help with practice and game setup during class period. Practice and game coverage is required. ***This course will not count for PE credit.*****Sports Medicine III****(PHSM3)****11th-12th****1 credit****Prerequisite:** *Required* Sports Medicine I & II; Must be in Athletic Training Program; Licensed Athletic Trainer Approval**Course Description:** This course will provide a logical progression for students that have advanced through the sports medicine courses and provide them with an opportunity to apply the knowledge and skills they have gained to athletic injury recognition, evaluation, management, treatment, and rehabilitation through research investigations and applications related to sports medicine. ***This course will not count for PE credit.*****Basic Athletic Training****(PHBAT)****12th****1 credit****Prerequisite:** Must be in Athletic Training Program; Licensed Athletic Trainer Approval.**Course Description:** Will provide a basic knowledge and skills of athletic injury assessment, management, and use of modalities. The course will be curriculum based and will cover basic preventative taping, first aid, training room management and provide a general knowledge of athletic injuries and their management. This course will also include scientific/medical terminology, human anatomy, kinesiology, and exercise physiology. Students will also receive certification in CPR/AED and First Aid. After-school work at games and practices is required. ***This course is for local credit and will not count towards graduation requirements for PE.***

AIR FORCE JUNIOR RESERVE OFFICER TRAINING CORPS **(AFJROTC)**

The AFJROTC program at Waller High School offers four courses—AFJROTC 1, 2, 3, and 4—each consisting of three components: Aerospace Science (AS), Leadership Education (LE), and Wellness. Students enrolled in AFJROTC receive Physical Education (PE) credit (1 credit per academic year). All classes are blended and can be taken in any order during their high school years allowing ease of scheduling for both student and counselor.

Students active in the AFJROTC program are called cadets. The AFJROTC program requires cadets to sign a behavior contract pledging to properly care for issued uniform items, textbooks, and other equipment. Furthermore, cadets are required to meet AFJROTC grooming standards and properly wear an Air Force uniform once a week.

AFJROTC I-IV**(ROTC1)(ROTC2)(ROTC3)(ROTC4)****9th – 12th****1 credit****Prerequisite:** Must sign a behavior contract. (NOTE: AFJROTC 1, AFJROTC 2, AFJROTC 3, and AFJROTC 4 rotate course offerings on four-year rotation allowing blended classes and better ability to schedule cadets for four-year programs.**Course Description:****Aerospace Studies Component: The Science of Flight: A Gateway to New Horizons** is an introductory course and customized textbook that focuses on how airplanes fly, how weather conditions affect flight, flight, flight and the human body, and flight navigation. The course is designed to complement materials taught in math, physics, and other science-related courses and is aligned with the National Science Education Standards, the Math Standards and Expectations, and ISTE National Educational Technology Standards for Students. In this course, every lesson includes a “Quick Write” and a short story related to the lesson; a “Learn About” that tells students what they’ll learn from the lesson; a list of vocabulary words in the lesson; “Wing Tips” that highlight specific and interesting facts; and many biographies and profiles. Each lesson closes with “Checkpoints” that will allow students to review what they have learned. An “Applying Your Learning” section at the end of each lesson presents discussion questions that will give them a chance to use what they have learned and provides another way to reinforce their understanding of the lesson’s content. The text has four chapters, each of which contains a number of lessons.**Course Outcomes:**

1. Analyze the elements of flight.
2. Evaluate how atmospheric conditions affect flight.
3. Evaluate how flight affects the human body.
4. Analyze flight navigation and the purpose of aerial navigation aids.

Leadership Component: Life Skills and Career Opportunities provide an essential component of leadership education for today's high school students. This course is designed to prepare students for life after high school in the high-tech, globally oriented, and diverse workplace of the 21st century. Students will learn how to become a more confident financial planner and to save, invest, and spend money wisely, as well as how to avoid the credit trap. They will learn about real-life issues such as understanding contracts, leases, warranties, legal notices, personal bills, practical and money-saving strategies for grocery shopping, apartment selection, and life with roommates. The Holland Interest Inventory and other self-assessments will help them to reveal their attitudes, aptitudes, and personal skills. This self-understanding will allow them to explore career paths and understand the requirements that they will need to be successful at work and in life. To help students increase their potential for success through education, they will learn how to select a school that is right for them; how to apply for admission to a vocational or technical school, community college, or college/university; and how to succeed in these learning environments. Information is provided on how to conduct the job search for students who wish to enter the workforce right after high school or after additional education and training. They will learn how to prepare a winning résumé, and how to develop effective interviewing skills. Students will become more skilled at using the Internet for career research and learn how to network safely using social media. The text also provides information on working for the federal government to include careers in the military, aerospace industry, and public service. Finally, students will consider the most important elements of life skills for all Americans: civic responsibilities, such as volunteering, registering to vote, jury duty, and draft registration.

Course Outcomes:

1. Analyze the elements of successful financial management skills.
2. Create a plan to safeguard personal resources.
3. Analyze the different ways of pursuing a career path.
4. Analyze the requirements for applying to a college or university.
5. Analyze positive and negative impact of college life in meeting career goals.
6. Evaluate the essential process for successfully pursuing a desired career or job.
7. Evaluate the benefits of working for the Federal Government.
8. Create a plan for successful career development.

Wellness component: Includes President's Physical Fitness Program and Fitness gram participation. Also includes team sports and fitness-promoting activities developed and led by cadets.

Course Outcomes:

1. Motivate cadets to lead active, healthy lifestyles beyond program requirements and into their adult lives
2. Create an individualized training program based on national standards by age and gender.
3. Identify areas of improvements for each cadet and provide guidance for improvement.
4. Incorporate a physical training program to reach fitness goals.

LANGUAGES OTHER THAN ENGLISH

Spanish I **(FLSP1)**
9th – 11th **1 credit** **4.0**

Prerequisite: *None*

Course Description: An elementary introduction to the Spanish language beginning with oral Spanish of everyday life situations. It progresses to more difficult language patterns and a study of two simple tenses. Grammar patterns necessary for the comprehension of the language are studied. Speaking, writing, reading, and comprehension of the language are studied and experienced. Materials used include audiovisuals made by native Spanish teachers.

Spanish I for Native Speakers **(FLNS1)**
9th – 11th **1 credit** **4.0**

Prerequisite: *None*

Course Description: An elementary introduction to the Spanish language beginning with oral Spanish of everyday life situations. It progresses to more difficult language patterns and a study of two simple tenses. Grammar patterns necessary for the comprehension of the language are studied. Speaking, writing, reading, and comprehension of the language are studied and experienced. Materials used include audiovisuals made by native Spanish teachers.

Spanish II **(FLSP2)**
9th – 12th **1 credit** **4.0**

Prerequisite: *Required* Spanish I or demonstrated equivalent proficiency as determined by the district

Course Description: Grammar patterns are extended to include additional tenses. Reading lessons are concerned with the Hispanic nations, their history, culture, economy, etc. More time is devoted to reading and writing language than the first year. Speaking and comprehending the spoken language are still primary aims.

Spanish II for Native Speakers **(FLSNS2)**
9th – 12th **1 credit** **4.0**

Prerequisite: *Required* Spanish I or demonstrated equivalent proficiency as determined by the district

Course Description: Grammar patterns are extended to include additional tenses. Reading lessons are concerned with the Hispanic nations, their history, culture, economy, etc. More time is devoted to reading and writing language than the first year. Speaking and comprehending the spoken language are still primary aims.

Spanish III Honors (FLSP3)
9th – 12th 1 credit 5.0

Prerequisite: *Required* Spanish II or demonstrated equivalent proficiency as determined by the district

Course Description: This course concentrates on oral communication skills, written communication skills, and reading skills. Activities are theme related and reflect the grammar and vocabulary taught. Literary works by well-known Hispanic writers are studied. The subtleties and nuances of the language and the “art” of translation are addressed in detail and a “refresher review” of grammar is also included. This course provides an opportunity to earn college credit upon completion of AP exam and receiving a score of 3 or higher.

Spanish IV AP (FLSP4)
9th – 12th 1 credit 5.0

Prerequisite: *Required* Spanish III or demonstrated equivalent proficiency as determined by the district

Course Description: This course introduces students to outstanding examples of Spanish and Hispano-American literature through diverse literary genres: short story, poetry, novel, biography, essay, and drama. The history and culture of Spain and Latin America are interwoven, with emphasis on the influence of the “mother country” on the Americas. The subtleties and nuances of the language and the “art” of translation are addressed in detail and a “refresher review” of grammar is also included. Opportunity for original conversation, memorization, written expression, and dramatization is presented throughout the course. This course provides an opportunity to earn college credit upon completion of AP exam and receiving a score of 3 or higher.

Spanish V AP (FLSP5)
9th – 12th 1 credit 5.0

Prerequisite: *Required* Spanish IV or demonstrated equivalent proficiency as determined by the district

Course Description: This course introduces students to outstanding examples of Spanish and Hispano-American literature through diverse literary genres: short story, poetry, novel, biography, essay, and drama. The history and culture of Spain and Latin America are interwoven, with emphasis on the influence of the “mother country” on the Americas. The subtleties and nuances of the language and the “art” of translation are addressed in detail and a “refresher review” of grammar is also included. Opportunity for original conversation, memorization, written expression, and dramatization is presented throughout the course. This course provides an opportunity to earn college credit upon completion of the AP exam and receiving a score of 3 or higher.

French I (FLFR1)
9th – 12th 1 credit 4.0

Prerequisite: *None*

Course Description: An elementary introduction to the French language beginning with oral French of everyday life situations. It progresses to more difficult language patterns and a study of everyday life situations. Grammar patterns necessary for the comprehension of the language are studied. Speaking, writing, reading, and comprehension of the language are experienced.

French II (FLFR2)
9th – 12th 1 credit 4.0

Prerequisite: *Required* French I or demonstrated equivalent proficiency as determined by the district

Course Description: Grammar patterns are extended to include the past, future, imperative and conditional tenses. Reading lessons concern France, its history, culture, economy, etc. More time is devoted to reading and writing the language than the first year. Speaking and comprehending the spoken language are still the primary aims.

French III Honors (FLFR3)
10th – 12th 1 credit 5.0

Prerequisite: *Required* French II or demonstrated equivalent proficiency as determined by the district

Course Description: Helps students to continue to develop proficiency in the four basic skills: listening, speaking, reading, and writing. Students will solidify and expand upon the grammar learned in levels I and II. Readings will include popular fairy tales and other native sources. This course aims to increase the student’s knowledge and appreciation of French culture.

French IV AP (FLFR4)
10th-12th 1 credit 5.0

Prerequisite: *Required* French III or demonstrated equivalent proficiency as determined by the district

Course Description: This course concentrates on oral communication skills, written communication skills, and reading skills. Activities are theme related and reflect the grammar and vocabulary taught. Literary works by well-known Francophone writers are studied. This class focuses more on nuances of grammar rather than direct grammar instruction and attempts to “speed up” the students’ thought process in French to allow for more natural communication. This course provides an opportunity to earn college credit upon completion of AP exam and receiving a score of 3 or higher.

LOTE Computer Science I (FLCS1)
9th – 12th 1 credit 4.0

Prerequisite: *Required* Algebra I or concurrent enrollment in Algebra I

Course Description: Students will design well-structured computer programs that solve problems of various varieties. Students will work in the Java programming language as they develop their algorithms. Students will also be introduced to advanced topics like Boolean Logic, Digital Circuitry, and Number Systems. *Credits earned for Computer Science I and II satisfy the LOTE credit requirement.*

LOTE Computer Science I Honors (FLCP1H)
9th – 12th 1 credit 5.0

Prerequisite: *Required* Algebra I or concurrent enrollment in Algebra I

Course Description: Students will design well-structured computer programs that solve problems of various varieties. Students will work in the Java programming language as they develop their algorithms. Students will also be introduced to advanced topics like Boolean Logic, Digital Circuitry, and Number Systems. *Credits earned for Computer Science I and II satisfy the LOTE credit requirement.*

LOTE Computer Science II (FLCS2)
10th – 12th 1 credit 4.0

Prerequisite: *Required* Algebra I and LOTE Computer Science or AP Computer Science Principles

Course Description: Computer Science II will extend the depth of Computer Science II skills with advanced projects giving students opportunities to design, implement, and present meaningful programs through a variety of media. By using computer science knowledge and skills that support the work of individuals and groups in solving problems, students will select the technology appropriate for the task, synthesize knowledge, create solutions, and evaluate the results. Students will learn digital citizenship by researching current laws and regulations and by practicing integrity and respect. Students will gain an understanding of computer science through the study of technology operations, systems, and concepts. *Credits earned for Computer Science I and II satisfy the LOTE credit requirement.*

LOTE Computer Science II Honors (FLCS2H)
10th – 12th 1 credit 5.0

Prerequisite: *Required* Algebra I and LOTE Computer Science or AP Computer Science Principles

Course Description: Computer Science II Honors will extend the depth of Computer Science II skills with advanced projects giving students' opportunities to design, implement, and present meaningful programs through a variety of media. By using computer science knowledge and skills that support the work of individuals and groups in solving problems, students will select the technology appropriate for the task, synthesize knowledge, create solutions, and evaluate the results. Students will learn digital citizenship by researching current laws and regulations and by practicing integrity and respect. Students will gain an understanding of computer science through the study of technology operations, systems, and concepts. *Credits earned for Computer Science I and II satisfy the LOTE credit requirement.*

AP Computer Science A LOTE (Languages Other Than English) and Math (TACSAL)(TACSAP)
11th – 12th 2 credits 5.0

Prerequisite: *Recommended* Algebra I

Course Description: Students continue the study of software design, writing well-designed well-structured computer programs that solve problems in the fields of Math and Science. Students will work in the Java programming language as the focus on the design and structure of Java classes. Students will also be introduced to advanced topics like Binary Trees, Graph Theory, and Digital Electronics. Students will prepare for the Computer Science Advanced Placement Exam. *This course satisfies the 3rd or 4th year Mathematics credit as well as a LOTE credit for graduation.* This course provides an opportunity to earn college credit upon completion of AP exam and receiving a satisfactory score. Students must co-enroll in Computer Science AP Math and LOTE.

Special Topics in Language and Culture (FLSTLC)
9th – 12th 1 credit 4.0

Prerequisite: *Approval by:* (1) the student's level I LOTE classroom teacher or our LOTE designee, the principal or designee, and the student's parent or person standing in parental relation who determine that the student is not likely to be successful in a level II LOTE course; (2) the student's admission, review, and dismissal (ARD) committee if the student receives special education services or (3) the committee established for the student under Section 504.

Course Description: The study of world languages is an essential part of education. In the 21st century language classroom, students gain an understanding of two basic aspects of human existence: the nature of communication and the complexity of culture. Students become aware of multiple perspectives and means of expression, which lead to an appreciation of difference and diversity. Further benefits of foreign language study include stronger cognitive development, increased creativity, and divergent thinking. Students who effectively communicate in more than one language, with an appropriate understanding of cultural context, are globally literate and possess the attributes of successful participants in the world community. This course cannot be considered a part of the coherent sequence of Languages other than English (LOTE) courses required for any endorsement. This course will not count as a level II LOTE course. Students who desire to continue with LOTE study will need to take level II or higher LOTE courses. This course may be substituted for a level II LOTE course upon approval as stated above.

FINE ARTS

All students must complete one (1) credit of fine arts. Courses that satisfy this requirement are Choir, Dance, Art, Theatre Arts, and Floral Design in the CTE department. Band and Drill Team may also satisfy this requirement during the spring semester only.

Art

Art I (FAAR1)
9th – 12th 1 credit

Prerequisite: *None*

Course Description: Four basic strands—perception, creative expression/performance, historical and cultural heritage, and critical evaluation—provide broad, unifying structures for organizing the knowledge and skills students are expected to acquire. Students will rely on their perceptions of the environment, developed through increasing visual awareness and sensitivity to surroundings, memory, imagination, and life experiences, as a source for creating artworks. Students will express their thoughts and ideas creatively, while challenging their imagination, foster reflective thinking, and develop disciplined effort and problem-solving skills. By analyzing artistic styles and historical periods students develop respect for traditions and contributions of diverse cultures. Students will respond to and analyze artworks, thus contributing to the development of lifelong skills of making informed judgments and evaluations. ***This course will satisfy the fine arts requirement for graduation.***

Art II – IV- Drawing (FADR2) (FADR3) (FADR4)
9th – 12th 1 credit

Prerequisite: *Required* one credit of Art in the previous course

Course Description: This advanced course includes developing the skills learned in Art I through the use of various dry media including pencil, pastel, oil pastel, charcoal, and colored pencil. Different styles of art will be explored while building technique. ***This course will satisfy the fine arts requirement for graduation.***

Art II – IV- Painting (FAPT2) (FAPT3) (FAPT4)
9th – 12th 1 credit

Prerequisite: *Required* one credit of Art in the previous course

Course Description: This advanced course includes developing the skills learned in Art I through the use of various wet media including acrylic, tempera, and watercolor. Different styles of art will be explored while building technique. ***This course will satisfy the fine arts requirement for graduation.***

Art II- IV- Ceramics (FACR2) (FACR3)(FACR4)
9th – 12th 1 credit

Prerequisite: *Required* one credit of Art in the previous course

Course Description: This advanced course includes developing the skills learned in Art I through the use of clay. Different styles of hand-building pottery and sculpture will be explored while building technique. ***This course will satisfy the fine arts requirement for graduation.***

Art II – IV- Photography (FAPH2) (FAPH3) (FAPH4)
9th – 12th 1 credit

Prerequisite: *Required* one credit of Art in the previous course

Course Description: Focuses on artistic expression through the photographic medium. Students will express their thoughts and improve their problem-solving skills by using their camera to compose artwork. Students learn film processing and printing techniques. Students will learn digital photo editing. Students must have a personal camera. ***This course will satisfy the fine arts requirement for graduation.***

AP Art History (FAAHAP)
9th – 12th 1 credit

Prerequisite: *None*

Course Description: The AP Art History course is equivalent to a two-semester introductory college course that explores the nature of art, art making, and responses to art. By investigating specific course content of 250 works of art characterized by diverse artistic traditions from prehistory to the present, the course fosters in-depth, holistic understanding of the history of art from a global perspective. Students become active participants in the global art world, engaging with its forms and content. They experience, research, discuss, read, and write about art, artists, art making, responses to, and interpretations of art. ***This course will satisfy the fine arts requirement for graduation.***

AP Studio Art: 2-D Design (FASAAP)
10th – 12th 1 credit

Prerequisite: Successful completion of Art II

Course Description: Students will learn to use 2-D design principles to organize an image on a picture plane in order to communicate content. They will demonstrate mastery through any two-dimensional medium or process, such as graphic design, digital imaging, photography, collage, fabric design, weaving, fashion design, fashion illustration, painting and printmaking. They

will also Develop technical skills and familiarize themselves with the functions of visual elements as they create an individual portfolio of work for evaluation at the end of the course. ***This course will satisfy the fine arts requirement for graduation.***

Music Appreciation (MUSI 1306) Dual Credit

(FAMADC)

9th-12th **1 credit**

Prerequisite: *College eligibility per Blinn College guidelines*

Course Description: Understanding music through the study of cultural periods, major composers, and musical elements. Illustrated with audio recordings and live performances. (Does not apply to a music major degree.) ***This course will satisfy the fine arts requirement for graduation. SUMMER ONLY***

Band

Concert Band I – II

(FABN1/FABN1B) (FABN2/FABN2B)

Symphonic Band I – II

(FACB1/FACB1B)(FACB2/FACB2B)

Wind Ensemble I – II

(FAMSP1/FASB1B)(FAMSP2/FASB2B)

9th – 12th **1 credit**

Prerequisite: *None*

Course Description: Band is a “performing arts” class. The purpose of band class is to increase understanding and appreciation of music through ensemble performance. The performing arts class requires time for public performance. There are some events in which the band will participate that are extracurricular, but the majority of the band is curricular. Students must attend performances and rehearsals scheduled outside of class time. In order to meet the various levels of development of individual students, there are several band classes set up each semester. Each class has similar goals and criteria but utilizes music and exercises that best suit the current level of musical skills. Students without pre-existing band experience will be enrolled in Concert Band with director’s approval. These students will participate in both fall/spring semester band activities. During the fall semester, marching band is a primary component of the curriculum for all band classes and therefore participation is required for enrollment in the band program. An evaluation of a student's basic knowledge, tone, rehearsal skills, musicianship, and technical skill determine class (band) placement. **Fall – P.E. Substitution Credit/Spring – Fine Arts Credit**

Concert Band III - IV

(FACB3) (FACB4)

Symphonic Band III - IV

(FASB3) (FASB4)

Wind Ensemble III – IV

(FABN3) (FABN4)

11th – 12th **1 credit**

Prerequisite: *Required Band I and Band II*

Course Description: Band is a “performing arts” class. The purpose of band class is to increase understanding and appreciation of music through ensemble performance. The performing arts class requires time for public performance. There are some events in which the band will participate that are extracurricular, but the majority of the band is curricular. Students must attend performances and rehearsals scheduled outside of class time. In order to meet the various levels of development of individual students, there are several band classes set up each semester. Each class has similar goals and criteria but utilizes music and exercises that best suit the current level of musical skills. Students without pre-existing band experience will be enrolled in Concert Band with director’s approval. These students will participate in both fall/spring semester band activities. During the fall semester, marching band is a primary component of the curriculum for all band classes and therefore participation is required for enrollment in the band program. An evaluation of a student's basic knowledge, tone, rehearsal skills, musicianship, and technical skill determine class (band) placement. This course will satisfy the fine arts requirement for graduation.

Instrumental Techniques

(FAAPM)

9th – 12th **1 credit**

Prerequisite: Concurrent enrollment in Concert, Symphonic, or Wind Ensemble Band

Course Description: Student will receive an intense study of his or her instrument through one on one instruction. The student will receive a private lesson at least once a week during the applied music class. The student will spend the remainder of class working independently to prepare for his or her next lesson. Students will also receive advanced instruction in the use of music based computer programs, music history, and music theory. Students enrolled in this class will be required to prepare an audition for the region band as well as prepare for all solo contests. To enroll the student must have teacher approval and must also be enrolled in at least one concert band class.

Jazz Ensemble I – IV

(FAJB1) (FAJB2) (FAJB3) (FAJB4)

9th – 12th **1 credit**

Prerequisite: *None*

Course Description: Jazz Band is a “performing arts” class. Through ensemble performance and rehearsal, students will gain knowledge of the jazz idiom. Within the context of jazz music, students will be given opportunities to experiment with creative improvisation and solo performances. Students will be exposed to musical history and theory as it pertains to jazz music. These students will participate in both fall/spring semester band activities. During the fall semester, marching band is a primary component of the curriculum for all band classes and therefore participation is required for enrollment in the band program. An evaluation of a student's basic knowledge, tone, rehearsal skills, musicianship, and technical skill determine class (band) placement. Concurrent enrollment in a band course or band/director approval

Fall Color Guard/Winter Guard I - II9th – 12th**1 credit****(FAMCG1/FACG1B)(FAMCG2/FACG2B)****Prerequisite:** *None*

Course Description: The color guard utilizes various equipment and props to enhance the visual presentation of the marching band. Members will learn various dance movements and choreography during the course of the season. All students are welcome to audition for both the fall and winter color guards. Auditions for fall color guard will take place in the spring preceding the upcoming school year. Auditions for winter color guard will be at the conclusion of the marching season. Winter color guard performs choreography in a gym to recorded music. While classes are assigned during the day for rehearsal, students must also attend performances and rehearsals scheduled outside of class time. ***Fall – P.E. Credit/Spring – Fine Arts Credit***

Fall Color Guard/Winter Guard III – IV11th – 12th**1 credit****(FACG3) (FACG4)****Prerequisite:** Fall Color Guard/Winter Guard II

Course Description: The color guard utilizes various equipment and props to enhance the visual presentation of the marching band. Members will learn various dance movements and choreography during the course of the season. All students are welcome to audition for both the fall and winter color guards. Auditions for fall color guard will take place in the spring preceding the upcoming school year. Auditions for winter color guard will be at the conclusion of the marching season. Winter color guard performs choreography in a gym to recorded music. While classes are assigned during the day for rehearsal, students must also attend performances and rehearsals scheduled outside of class time.

Choir**Chorale I - IV– Varsity**9th – 12th**1 credit****(FAAC1) (FAAC2) (FAAC3) (FAAC4)****Prerequisite:** Director Approval

Course Description: Chorale is a competitive mixed choir composed of serious and dedicated advanced musicians who are devoted to the success of the choir by participating in co-curricular programs and extracurricular contests. The purpose of the class is to give students an increased understanding and appreciation of choral music through ensemble performance. This ensemble requires time outside of class for rehearsals and performances that are mandatory, included in the curriculum and is essential to the learning process. Uniforms will be provided by WHS for rental to be paid by students. Also, purchase of a uniform shirt is required. ***This course will satisfy the fine arts requirement for graduation.***

Treble Choir I - IV – Junior Varsity9th – 12th**1 credit****(FATC1) (FATC2) (FATC3) (FATC4)****Prerequisite:** Director Approval

Course Description: Treble Choir is a competitive women’s choir composed of serious and dedicated musicians who are devoted to the success of the choir by participating in co-curricular programs and extracurricular contests. The purpose of the class is to give students an increased understanding and appreciation of choral music through ensemble performance. This ensemble requires time outside of class for rehearsals and performances that are mandatory, included in the curriculum and is essential to the learning process. Uniforms will be provided by WHS for rental to be paid by students. Also, purchase of a uniform shirt is required. ***This course will satisfy the fine arts requirement for graduation.***

Concert Women’s Choir I - IV– Non-Varsity9th – 12th**1 credit****(FAWC1)(FAWC2)(FAWC3)(FAWC4)****Prerequisite:** *None*

Course Description: Concert Women’s Choir is a choir composed of beginning or inexperienced female students who desire to participate in a performing ensemble. The purpose of the class is to give students a fundamental understanding and appreciation of choral music through ensemble performance. Concert Women’s Choir members must attend rehearsals and performances outside of school hours as scheduled by the director, which are included in the state mandated curriculum for a fine arts credit. Uniforms will be provided by WHS for rental to be paid by students. Also, purchase of a uniform shirt is required. ***This course will satisfy the fine arts requirement for graduation.***

Concert Men’s Choir I - IV– Non-Varsity9th – 12th**1 credit****(FACH1)(FACH2)(FACH3)(FACH4)****Prerequisite:** *None*

Course Description: Concert Men’s Choir is a choir composed of beginning or inexperienced male students who desire to participate in a performing ensemble. The purpose of the class is to give students a fundamental understanding and appreciation of choral music through ensemble performance. Concert Men’s Choir members must attend rehearsals and performances outside of school hours as scheduled by the director, which are included in the state mandated curriculum for a fine arts credit. Uniforms will be provided by WHS for rental to be paid by students. Also, purchase of a uniform shirt is required. ***This course will satisfy the fine arts requirement for graduation.***

Music Appreciation (FAFUM)
9th – 12th 1 credit

Prerequisite: None

Course Description: This course is specifically designed for students who need a Fine Arts Credit, but don't find themselves to be the performer type. Students will learn beginning skills in the following areas: Music Theory, Music History, the various types of Instruments, Important Composers, and Vocal Technique. This class will also serve as a Technical Team to the Choral Department. Students will learn how to operate all mechanical systems in the WHS Auditorium, set up and tear down the stage, etc. so they can assist during the Choir Concerts. Students who take this course will learn to appreciate Music without having to perform, but rather by attending Concerts and supporting the performers. *This course will satisfy the fine arts requirement for graduation.*

Music Theory AP (FAPMUS)
11th-12th 1 credit

Prerequisite: Required At least one year in advanced Choir or Band

Course Description: The AP Music Theory course is designed to develop a student's ability to aurally and visually analyze the basic concepts and processes of music. This is achieved by incorporating lessons, assignments, and creative projects that cultivate the aural, sight-singing, compositional and analytical skills of students. Throughout the course, students will complete excerpts from sample exams found in the *AP Music Theory Course Description Book*. Students will complete the sample multiple choice questions, free-response and the sight-reading exercises. In the weeks leading up to the exam, students will complete College Board released exams. Through lectures, analyses, and sample exams students will compile a comprehensive lexicon of theory terms and concepts that will be used as a final review for the AP Music Theory Exam. Students who successfully complete the AP Music Theory Exam, and plan to major in music in college, may be able to enroll in an advanced music theory course, depending upon the individual college's policy. *This course will satisfy the fine arts requirement for graduation.*

Music Appreciation (MUSI 1306) Dual Credit (FAMADC)
9th-12th 1 credit

Prerequisite: College eligibility per Blinn College guidelines

Course Description: Understanding music through the study of cultural periods, major composers, and musical elements. Illustrated with audio recordings and live performances. (Does not apply to a music major degree.) *This course will satisfy the fine arts requirement for graduation. SUMMER ONLY*

Dance

Dance I (FADN1)
9th – 12th 1 credit

Prerequisite: None

Course Description: Focuses on fundamental skills in the following dance techniques: ballet, modern jazz, lyrical, tap, folk, character, and ethnic. Students will develop creative expression through movement using improvisation, exploration of basic concepts and movement problems. Students will develop an awareness of space, time, and energy as design factors in dance technique and composition. Students will develop self-confidence through the use of the body as an expressive instrument. Most importantly, students will gain an appreciation of dance as an art form through viewing performances on tape and live performances. Students will learn the history of various dance styles. Student is required to perform a dance choreographed by the teacher. One outside performance a semester is required. Each student will also be asked to choreograph a complete dance during the second semester. *This course will satisfy the fine arts requirement for graduation.*

Dance II (FADN2)
9th – 12th 1 credit

Prerequisite: Required Dance I

Course Description: Students will acquire intermediate skills and increase their kinesthetic awareness in all above Dance I areas. One outside performance a semester is required. Each student will also be asked to choreograph a complete dance during the second semester. *This course will satisfy the fine arts requirement for graduation.*

Dance III (FADN3)
10th-12th 1 credit

Prerequisite: Required Dance II

Course Description: Students will continue mastering dance skills through advanced movements. They will develop musically in performing dance techniques for performances, analyze dance styles and understand the relationship of the art forms. One outside performance a semester is required. Each student will also be asked to choreograph a complete dance during the second semester. *This course will satisfy the fine arts requirement for graduation.*

Dance IV (FADN4)
11th-12th 1 credit

Prerequisite: Required Dance III

Course Description: Students will acquire advanced skills in all dance techniques and create efficiency of movements through kinesthetic awareness, muscle memory, and visual recall. The students will choreograph a complete movement statement, present movement study in

performance, evaluate movement ideas and express concrete or abstract ideas in movement. Students will explore the history of dance as it relates to other art forms. One outside performance a semester is required. Each student will also be asked to choreograph a complete dance during the second semester. *This course will satisfy the fine arts requirement for graduation.*

Drill Team I (FADTM1)
9th – 12th 1 credit

Prerequisite: *Audition*

Course Description: Prepare for performances during the fall at football and basketball games, various parades, and various intense competitions as well as spring show during the second semester. Wranglerettes act as a marching-drill unit, promote school spirit, build character, and encourage sportsmanship. The members of this organization are expected to perform and compete the entire year. Members shall be enrolled in drill team class entire year—the director must approve exception. Before/after school practice is required. **PE Substitution Credit**

Drill Team II, III & IV (FADTM2)(FADTM3)(FADTM4)
10th – 12th 1 credit

Prerequisites: *Required* Drill Team I; *Audition*

Course Description: Prepare for performances during the fall at football and basketball games, various parades and various intense competitions as well as spring show during the second semester. Wranglerettes act as a marching-drill unit, promote school spirit, build character, and encourage sportsmanship. The members of this organization are expected to perform and compete the entire year. Members shall be enrolled in drill team class the entire year-the director must approve exceptions. Before/after school practice is required. *This course will satisfy the fine arts requirement for graduation.*

Pre-Drill/JV Training I - PE (FAJVD)
9th – 12th 1 credit

Prerequisites: *Audition*

Course Description: This class will focus on preparing students for drill team tryouts. Different dance technical skills will be learned. Students will learn stretching to improve flexibility for splits, leaps, kicks, high kick techniques, precision in pom, and jazz. Strength and conditioning will also be included in this course. Outside performances are required. *This course will satisfy the PE substitution credit.*

Pre-Drill/JV Training I - IV (FAJVD1)(FAJVD2)(FAJVD3)(FAJVD4)
9th – 12th 1 credit

Prerequisites: *Audition*

Course Description: This class will focus on preparing students for drill team tryouts. Different dance technical skills will be learned. Students will learn stretching to improve flexibility for splits, leaps, kicks, high kick techniques, precision in pom, and jazz. Strength and conditioning will also be included in this course. Outside performances are required. *This course will satisfy the fine arts credit.*

Dance Performance Ensemble I - IV (FADPE1)(FADPE2)(FADPE3)(FADPE4)
9th – 12th 1 credit

Prerequisite: *None*

Course Description: Intense interdisciplinary program that combines performance elements such as dance, music, costume, and theatrical design with performance opportunities for smaller dance ensembles.

Theatre

Theatre Production I – IV (FATP1)(FATP2)(FATP3)(FATP4)
9th – 12th 1 credit

Prerequisite: *Required* one credit of Theatre in the previous course.

Course Description: Theatre Production class focuses on the acting side of theatre. Students will have an opportunity to explore all performance aspects of theatre including, but not limited to; auditioning, acting, technical theatre, theatre evaluation and theatre careers. Participation in public performances is a requirement of this course. Students are required to participate in at least one production per semester, including after school rehearsals and performances. Enrollment in this course is required for participation in the UIL One Act Play Contest. This course may be repeated for credit. *This course will satisfy the fine arts requirement for graduation.*

Technical Theatre I (FATT1)
9th – 12th 1 credit

Prerequisite: *None*

Course Description: Technical Theatre gives students an opportunity to explore what goes on behind-the-scenes in the world of theatre. This course will explore a variety of technical theatre areas including basic sound and lighting principles, set and prop design, makeup design and application, and costuming. *This course will satisfy the fine arts requirement for graduation.*

Technical Theatre II-IV (FATT2)(FATT3)(FATT4)
10th – 12th 1 credit

Prerequisite: *Recommended* one credit of Technical Theatre in the previous course.

Course Description: This course focuses on the production of and preparation for specific plays produced by the Waller High School Theatre Department with respect to sound, lighting, set building, properties construction, costuming and makeup. Advanced students may also focus on areas of specific interest such as sound, lighting, costuming, set design, makeup design, publicity, playwriting, script analysis and dramaturgy. *This course will satisfy the fine arts requirement for graduation.*

SKILLS DEVELOPMENT

Office Aide/Teacher Aide

(OFAID)

12th

½ -1 credit

Prerequisite: Senior standing; Office and/or teacher approval; No discipline referrals or failing grades

Course Description: Students should have the willingness and ability to perform the skills and duties assigned. Students will be removed from the position of Office Aide if he or she receives any disciplinary action or takes advantage of the privilege or confidential nature of the position. Teacher Aides are assigned to one or more teachers and do not rotate. Students can only be an office aide one period of the day.

This course is for local credit and will not count towards graduation.

Leadworthy The Course

(LDWRTY)

9th – 12th

½ credit

Prerequisite: None

Course Description: Leadworthy The Course is designed to develop personal responsibility, leadership, and professional skills through explicit social-emotional participatory learning experiences. The course provides students the opportunity to develop an awareness of personal image, a healthy self-concept, and healthy relationships. Students learn the concepts of consequential thinking and principle-based decision making. Students examine their awareness of social media, the effects of peer pressure and bullying, along with effective strategies to counteract those effects. This course will provide students opportunities to improve their public speaking and communication skills and their personal vision, mission statement, and goals. They will develop an understanding of what it means to be an effective member of the community through community service.

Texas Virtual School Network 9th - 12th

Prerequisite: None

Course Description: Texas Virtual School Network is a web-based learning initiative designed to meet the needs of secondary public, private, and charter schools in Texas. Its current curriculum includes core subjects, electives, and Advanced Placement courses, all aligned to state TEKS. Please visit texasvirtualschool.org for more info. Payment of the tuition costs for the Texas Virtual Network courses will be the responsibility of the student. Courses will be offered during the summer for early graduates. Only courses that are not offered at WHS will be available during the school year. **Prior to enrollment in TxVSN, students shall make a written request to the counselor to enroll in the course.**

Early Release/Late Arrival

(LEARLY/LATEYR)

Seniors, whose parents request early release/late arrival and who are approved, may be allowed to either arrive on campus 1 class period late or leave campus 1 class period early. Students receiving approval for early release/late arrival must have reliable transportation to leave or arrive at the approved time, every day. Students should not return to the campus unless they have tutoring (must have a pass from the teacher), need to take a make-up test at the end of the day (must have a pass from the teacher), or participate in an extracurricular activity that meets or practices at the end of the day, such as athletics, band, choir, drill team, club, etc. In addition, students approved for early release/late arrival may also attend school functions such as ball games, theater, music performances, dances and banquets. **Additionally, to have a release period students must be on track to earn an Endorsement, meet all STAAR EOC requirements, and have an application approved.**

Double Early Release/ Double Late Arrival/Early AND Late Arrival

(LEARY2/LATEY2)

Seniors, whose parents request early release/late arrival and who are approved, may be allowed to either arrive on campus 2 class periods late or leave campus 2 class periods early or have one period of each. Students receiving approval for early release/late arrival must have reliable transportation to leave or arrive at the approved time, every day. Students should not return to the campus unless they have tutoring (must have a pass from the teacher), need to take a make-up test at the end of the day (must have a pass from the teacher), or participate in an extracurricular activity that meets or practices at the end of the day, such as athletics, band, choir, drill team, club, etc. In addition, students approved for early release/late arrival may also attend school functions such as ball games, theater, music performances, dances and banquets. **Additionally, to have multiple release periods students must be on track to earn an Endorsement, meet all STAAR EOC requirements, and have an application approved.**

CAREER AND TECHNICAL EDUCATION



www.wallerisd.net 936.931.3685

All Waller ISD graduates are expected to meet at least one of the Texas College, Career and Military Readiness (CCMR) standards prior to graduation.

Indicators include meeting criteria:

- Earn a qualifying score on common college readiness exams:
 - SAT
 - ACT
 - TSIA2
- Earn college credit through:
 - Advanced Placement (AP)
 - Dual Credit courses
- Enlistment in the US Armed Forces
- CTE students complete a coherent sequence of CTE courses and earn an industry-based certification or license in one of the following Programs of Study:

| | | |
|---|---|--|
| <p>AGRICULTURE, FOOD AND NATURAL RESOURCES</p>  | <p>ARCHITECTURE AND CONSTRUCTION</p>  | <p>ARTS, AUDIO VISUAL TECHNOLOGY AND COMMUNICATIONS</p>  |
| <p>BUSINESS, MARKETING AND FINANCE</p>  | <p>EDUCATION AND TRAINING</p>  | <p>ENGINEERING</p>  |
| <p>HEALTH SCIENCE</p>  | <p>HOSPITALITY AND TOURISM</p>  | <p>HUMAN SERVICES</p>  |
| <p>INFORMATION TECHNOLOGY</p>  | <p>LAW AND PUBLIC SERVICE</p>  | <p>MANUFACTURING</p>  |

Agriculture, Food, and Natural Resources Career Cluster



The Agriculture, Food, and Natural Resources (AFNR) career cluster focuses on the essential elements of life, food, water, land, and air. This career cluster includes occupations ranging from farmer, rancher, and veterinarian to geologist, land conservationist, and florist.

Statewide Program of Study: Agriculture Business, Leadership, and Communications

The Agriculture Business, Leadership, and Communications program of study focuses on occupational and educational opportunities associated with farming and agriculturally related businesses that supply farm inputs, such as machinery and seeds. This program of study includes exploration of farm product marketing, the purchase of farm products either for processing or resale, and the process of grading or classifying unprocessed food or other agricultural products.

Secondary Courses for High School Credit

- Level 1**
 - Principles of Agriculture, Food, and Natural Resources (1 credit) [offered at JH]
 - Professional Communications (½ credit) [offered at JH]

- Level 2**
 - Professional Standards in Agribusiness (½ credit)
 - Mathematical Applications in Agriculture, Food, and Natural Resources (1 credit)
 - Entrepreneurship I (1 credit)

- Level 4**
 - Practicum in Agriculture, Food, and Natural Resources (2 credits)
 - Career Preparation for Programs of Study (2 credits)
 - Career Preparation for Programs of Study + Extended Career Preparation (3 credits)

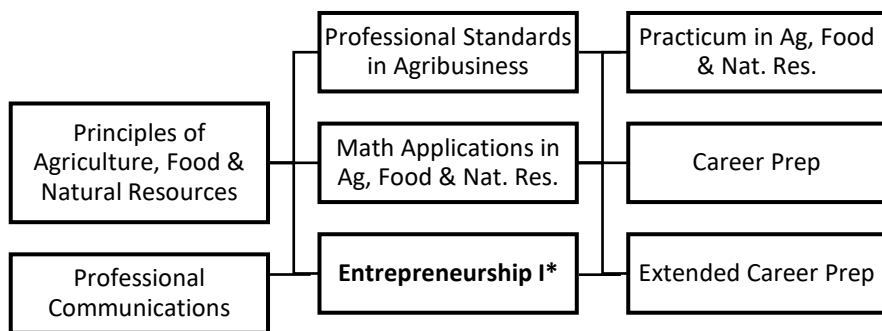

*course where Industry Based Certification can be earned

Aligned Advanced Academic Courses

AP AP Statistics

Students should be advised to consider these course opportunities to enrich their preparation. AP or IB courses not listed under the Secondary Courses for High School Credit section of this framework document do not count towards concentrator/completer status for this program of study.

Work-Based Learning and Expanded Learning Opportunities

Work-Based Learning Activities

- Shadow at a farm or ranch that manages livestock and crops to learn about processing and sales
- Intern at an agrochemical manufacturer to learn about new technologies in agribusiness

Expanded Learning Opportunities

- Participate in an FFA career, leadership, and speaking contest like an agriscience fair
- Attend an agricultural industry seminar

Aligned Industry-Based Certifications

- Entrepreneurship and Small Business
- Microsoft Office Specialist: Microsoft Excel Expert (2019)

Successful completion of the Agriculture Business, Leadership, and Communications program of study will fulfill requirements of the Business and Industry endorsement.



Example Postsecondary Opportunities

Associate Degrees

- Accounting
- Agribusiness

Bachelor's Degrees

- Agriculture Economics
- Agribusiness

Master's, Doctoral, and Professional Degrees

- Accounting
- Applied Economics

Additional Stackable IBCs/License

- Accredited Farm Manager



Example Aligned Occupations

Loan Interviewers and Clerks

Median Wage: \$46,572
Annual Openings: 2,307
10-Year Growth: 10%

Loan Officers

Median Wage: \$66,285
Annual Openings: 2,261
10-Year Growth: 14%

Farmers, Ranchers, and Other Agricultural Managers

Median Wage: \$65,490
Annual Openings: 28,020
10-Year Growth: 4%

Data Source: TexasWages, Texas Workforce Commission. Retrieved 3/8/2024



For more information visit:
<https://tea.texas.gov/academics/college-career-and-military-prep/career-and-technical-education/programs-of-study-additional-resources>



Agriculture, Food, and Natural Resources Career Cluster

The Agriculture, Food, and Natural Resources (AFNR) career cluster focuses on the essential elements of life, food, water, land, and air. This career cluster includes occupations ranging from farmer, rancher, and veterinarian to geologist, land conservationist, and florist.

Statewide Program of Study: Agricultural Technology and Mechanical Systems

The Agricultural Technology and Mechanical Systems program of study focuses on occupational and educational opportunities associated with applying engineering technology and biological science to agricultural problems related to power and machinery, electrification, structures, soil and water use, and processing agricultural products. This program of study includes diagnosing, repairing, or overhauling farm machinery and vehicles, such as tractors, harvesters, dairy equipment, and irrigation systems.



Secondary Courses for High School Credit

- Level 1**
 - Principles of Agriculture, Food, and Natural Resources (1 credit) [offered at JH]

- Level 2**
 - Agricultural Mechanics and Metal Technologies (1 credit)

- Level 3**
 - Agricultural Structures Design and Fabrication (1 credit)

- Level 4**
 - Agricultural Equipment Design and Fabrication + Agricultural Laboratory and Field Experience (2 credits)
 - Practicum in Agriculture, Food, and Natural Resources (2 credits)
 - Career Preparation for Programs of Study (2 credits)
 - Career Preparation for Programs of Study + Extended Career Preparation (3 credits)



Example Postsecondary Opportunities

- Apprenticeships**
 - Farm Equipment Mechanic I
- Associate Degrees**
 - Diesel Mechanics Technology
 - Industrial Mechanics and Maintenance Technology



- Bachelor's Degrees**
 - Agricultural Engineering
 - Agricultural Systems Management

- Master's, Doctoral, and Professional Degrees**
 - Agricultural Engineering
 - Industrial Technology

- Additional Stackable IBCs/License**
 - Diesel Equipment Technology-Off Highway Specialization CER1
 - Accredited Farm Manager

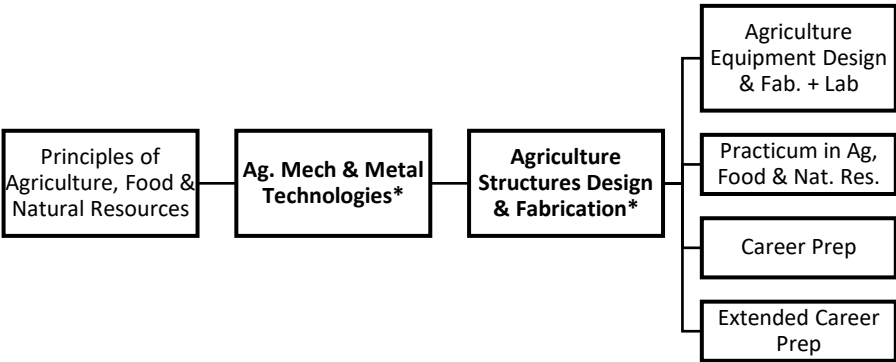

*course where Industry Based Certification can be earned

Work-Based Learning and Expanded Learning Opportunities

| | |
|--|---|
| Work-Based Learning Activities | <ul style="list-style-type: none"> • Participate in a farm mechanic apprenticeship at an equipment production company • Intern at an equipment manufacturing facility working with agricultural engineers |
| Expanded Learning Opportunities | <ul style="list-style-type: none"> • Participate in an FFA career, leadership, and speaking contest like an agriscience fair • Participate in an agriculture robotics event |

Aligned Industry-Based Certifications

- AWS D1.1 Structural Steel
- AWS D9.1 Sheet Metal Welding



Example Aligned Occupations

Farm Equipment Mechanics and Service Technicians
 Median Wage: \$46,582
 Annual Openings: 326
 10-Year Growth: 23%

Mobile Heavy Equipment Mechanics
 Median Wage: \$57,943
 Annual Openings: 2,637
 10-Year Growth: 31%

Farmers, Ranchers, and Other Agricultural Managers
 Median Wage: \$65,490
 Annual Openings: 28,020
 10-Year Growth: 4%

Agricultural Technology and Mechanical Systems



Agriculture, Food, and Natural Resources Career Cluster



The Agriculture, Food, and Natural Resources (AFNR) career cluster focuses on the essential elements of life, food, water, land, and air. This career cluster includes occupations ranging from farmer, rancher, and veterinarian to geologist, land conservationist, and florist.

Statewide Program of Study: Animal Science

The Animal Science program of study focuses on occupational and educational opportunities associated with the science, research, and business of animals and other living organisms. This program of study includes applying biology and life science to real-world life processes of animals and wildlife, either in laboratories or in the field, which could include a veterinary office, a farm or ranch, or any outdoor area harboring animal life. Students will research and analyze the growth and destruction of species and research or diagnose diseases and injuries of animals.

Secondary Courses for High School Credit

- Level 1**
 - Principles of Agriculture, Food, and Natural Resources (1 credit) [offered at JH]
- Level 2**
 - Small Animal Management (½ credit)
 - Equine Science (½ credit)
 - Entrepreneurship I (1 credit)
- Level 3**
 - Livestock Production (1 credit)
- Level 4**
 - Advanced Animal Science (1 credit)
 - Veterinary Medical Applications (1 credit)
 - Practicum in Agriculture, Food, and Natural Resources (2 credits)
 - Career Preparation for Programs of Study (2 credits)
 - Career Preparation for Programs of Study + Extended Career Preparation (3 credits)

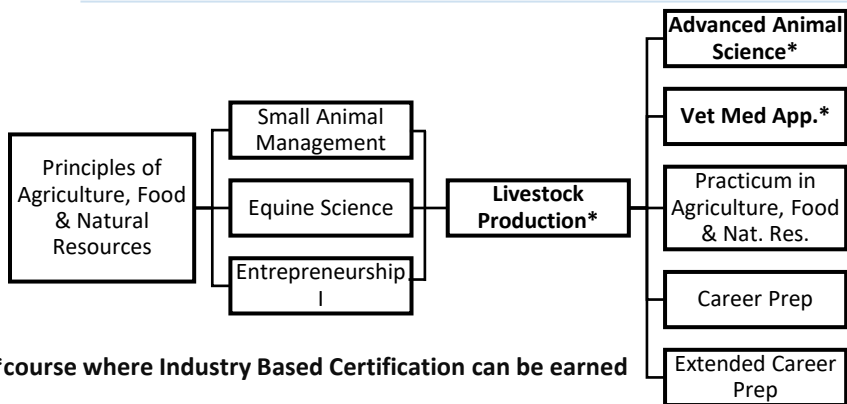

*course where Industry Based Certification can be earned

Aligned Advanced Academic Courses

| | |
|--------------------|-----------------------|
| AP | AP Biology |
| Dual Credit | BIOL 1406 & BIOL 1407 |

Students should be advised to consider these course opportunities to enrich their preparation. AP or IB courses not listed under the Secondary Courses for High School Credit section of this framework document do not count towards concentrator/completer status for this program of study.

Work-Based Learning and Expanded Learning Opportunities

| | |
|--|--|
| Work-Based Learning Activities | <ul style="list-style-type: none"> • Shadow an animal scientist in a biology lab to learn about applying science to understand animals and wildlife • Intern in a veterinary clinic, caring for animals and wildlife being treated in the clinic |
| Expanded Learning Opportunities | <ul style="list-style-type: none"> • Participate in an FFA career, leadership, and speaking contest like an agriscience fair • Attend an agricultural industry seminar |

Aligned Industry-Based Certifications

- Elanco Fundamentals of Animal Science Certification
- Elanco Veterinary Medical Applications Certification
- Small Animal Science and Technology

Successful completion of the Animal Science program of study will fulfill requirements of a Business and Industry endorsement.

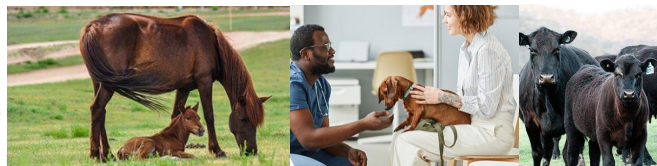

Example Postsecondary Opportunities

Apprenticeships

- Reproduction Technician

Associate Degrees

- Biological and Physical Sciences
- Entomology

Bachelor's Degrees

- Animal Science
- Zoology/Animal Biology

Master's, Doctoral, and Professional Degrees

- Marine Sciences
- Biotechnology

Additional Stackable IBCs/License

- Veterinarian
- Certified Veterinary Technician



Example Aligned Occupations

Veterinary Assistants and Laboratory Animal Caretakers

Median Wage: \$29,906
Annual Openings: 1,348
10-Year Growth: 24%

Veterinary Technologists and Technicians

Median Wage: \$33,679
Annual Openings: 1,217
10-Year Growth: 24%

Veterinarian

Median Wage: \$103,160
Annual Openings: 347
10-Year Growth: 26%

Data Source: TexasWages, Texas Workforce Commission. Retrieved 3/8/2024

For more information visit:

<https://tea.texas.gov/academics/college-career-and-military-prep/career-and-technical-education/programs-of-study-additional-resources>





Agriculture, Food, and Natural Resources Career Cluster

The Agriculture, Food, and Natural Resources (AFNR) career cluster focuses on the essential elements of life, food, water, land, and air. This career cluster includes occupations ranging from farmer, rancher, and veterinarian to geologist, land conservationist, and florist.

Statewide Program of Study: Plant Science

The Plant Science program of study focuses on occupational and educational opportunities associated with the science, research, and business of plants and other living organisms. This program of study includes the application of biology and life science to real-world life processes of plants and vegetation, either in laboratories or in the field.

Secondary Courses for High School Credit

- Level 1**
 - Principles of Agriculture, Food, and Natural Resources (1 credit) [offered at JH]

- Level 2**
 - Landscape Design and Management (½ credit)
 - Turf Grass Management (½ credit)
 - Entrepreneurship I (1 credit)

- Level 3**
 - Horticultural Science (1 credit)
 - Floral Design (1 credit)

- Level 4**
 - Advanced Plant and Soil Science (1 credit)
 - Advanced Floral Design (1 credit)
 - Practicum in Agriculture, Food, and Natural Resources (2 credits)
 - Career Preparation for Programs of Study (2 credits)
 - Career Preparation for Programs of Study + Extended Career Preparation (3 credits)

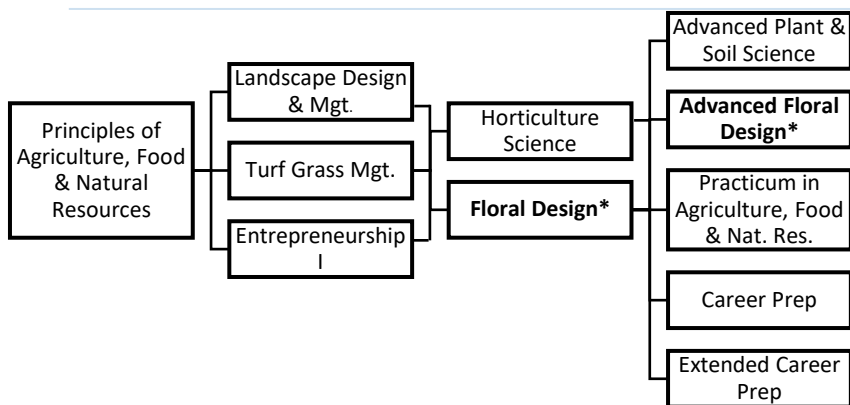

*course where Industry Based Certification can be earned

Aligned Advanced Academic Courses

| | | |
|--------------------|--|--------------|
| AP | AP Biology AP Environmental Science | AP Chemistry |
| Dual Credit | BIOL 1406 & BIOL 1407 | |

Students should be advised to consider these course opportunities to enrich their preparation. AP or IB courses not listed under the Secondary Courses for High School Credit section of this framework document do not count towards concentrator/completer status for this program of study.

Work-Based Learning and Expanded Learning Opportunities

| | |
|--|---|
| Work-Based Learning Activities | <ul style="list-style-type: none"> • Work in a part-time job at a landscaping company to learn about production and management of plants. • Intern at an agricultural research company, working alongside a biological technician to learn about application of biology to plant production |
| Expanded Learning Opportunities | <ul style="list-style-type: none"> • Participate in an FFA career, leadership, and speaking contest like an agriscience fair • Participate in an industry-related competition like an agriscience fair |

Aligned Industry-Based Certifications

- Texas State Florists' Association Knowledge Based Floral Certification
- Texas State Florists' Association Level I Floral Certification
- Texas State Florists' Association Level II Floral Certification



Example Postsecondary Opportunities

Apprenticeships

- Horticulturist

Associate Degrees

- Biology/Biological Sciences
- Biological and Physical Sciences

Bachelor's Degrees

- Horticulture
- Plant Pathology/Phytopathology

Master's, Doctoral, and Professional Degrees

- Plant Breeding
- Botany/Plant Biology

Additional Stackable IBCs/License

- Nursery Floral License
- Horticulturist Certification



Example Aligned Occupations

Pesticide Handlers, Sprayers, and Applicators, Vegetation

Median Wage: \$46,153
Annual Openings: 205
10-Year Growth: 17%

Biological Technicians

Median Wage: \$45,787
Annual Openings: 879
10-Year Growth: 14%

Farmers, Ranchers, and Other Agricultural Managers

Median Wage: \$65,490
Annual Openings: 28,020
10-Year Growth: 4%

Data Source: TexasWages, Texas Workforce Commission. Retrieved 3/8/2024.



For more information visit:
<https://tea.texas.gov/academics/college-career-and-military-prep/career-and-technical-education/programs-of-study-additional-resources>

AGRICULTURE, FOOD AND NATURAL RESOURCES

Professional Communications (CTATPC)

9th – 12th ½ credit

Prerequisite: *None*

Course Description: Professional Communications blends written, oral, and graphic communication in a career-based environment. Careers in the global economy require individuals to be creative and have a strong background in computer and technology applications, a strong and solid academic foundation, and a proficiency in professional oral and written communications. Within this context, students will be expected to develop and expand the ability to write, read, edit, speak, listen, apply software applications, manipulate computer graphics, and conduct Internet research.

Principles of Agriculture, Food, and Natural Resources (CTAFNR)

9th – 12th 1 credit

Prerequisite: *None*

Course Description: Principles of Agriculture, Food, and Natural Resources will allow students to develop knowledge and skills regarding career and educational opportunities, personal development, globalization, industry standards, details, practices, and expectations. To prepare for careers in agriculture, food, and natural resources, students must attain academic skills and knowledge in agriculture. To prepare for success, students need opportunities to learn, reinforce, experience, apply and transfer their knowledge and skills in a variety of settings.

Agriculture Mechanics and Metal Technologies (CTAMMT)

10th – 12th 1 credit

Prerequisite: *Recommended* Principles of Agriculture, Food, and Natural Resources

Course Description: Agricultural Mechanics and Metal Technologies is designed to develop an understanding of agricultural mechanics as it relates to safety and skills in tool operation, electrical wiring, plumbing, carpentry, fencing, concrete, and metalworking techniques. To prepare for careers in agricultural power, structural, and technical systems, students must attain academic skills and knowledge; acquire technical knowledge and skills related to power, structural, and technical agricultural systems and the industry; and develop knowledge and skills regarding career opportunities, entry requirements, industry certifications, and industry expectations. To prepare for success, students need opportunities to learn, reinforce, apply, and transfer knowledge and skills and technologies in a variety of settings.

Horticultural Science (CTAHOT)

10th – 12th 1 credit

Prerequisite: *None*

Course Description: Horticultural Science is designed to develop an understanding of common horticultural management practices as they relate to food and ornamental plant production. To prepare for careers in horticultural systems, students must attain academic skills and knowledge, acquire technical knowledge and skills related to horticulture and the workplace, and develop knowledge and skills regarding career opportunities, entry requirements, and industry expectations. To prepare for success, students need opportunities to learn, reinforce, apply, and transfer knowledge and skills in a variety of settings.

Livestock Production (CTALSP)

10th – 12th 1 credit

Prerequisite: *None*

Course Description: In Livestock Production, students will acquire knowledge and skills related to livestock and the livestock production industry. Livestock Production may address topics related to beef cattle, dairy cattle, swine, sheep, goats, and poultry. To prepare for careers in the field of animal science, students must attain academic skills and knowledge, acquire knowledge and skills related to animal systems and the workplace, and develop knowledge and skills regarding career opportunities, entry requirements, and industry expectations. To prepare for success, students need opportunities to learn, reinforce, apply, and transfer their knowledge and skills in a variety of settings.

Equine Science (CTEQSC)

10th – 12th ½ credit

Prerequisite: *None*

Course Description: In Equine Science, students will acquire knowledge and skills related to equine animal systems and the equine industry. Equine Science may address topics related to horses, donkeys, and mules. To prepare for careers in the field of animal science, students must enhance academic knowledge and skills, acquire knowledge and skills related to animal systems, and develop knowledge and skills regarding career opportunities, entry requirements, and industry expectations. To prepare for success, students need opportunities to learn, reinforce, apply, and transfer their knowledge and skills in a variety of settings.

Small Animal Management (CTSAMG)

10th-12th ½ credit

Prerequisite: *None*

Course Description: In Small Animal Management, students will acquire knowledge and skills related to small animals and the small animal management industry. Small Animal Management may address topics related to small mammals such as dogs and cats, amphibians,

reptiles, and birds. To prepare for careers in the field of animal science, students must enhance academic knowledge and skills, acquire knowledge and skills related to animal systems, and develop knowledge and skills regarding career opportunities, entry requirements, and industry expectations. To prepare for success, students need opportunities to learn, reinforce, apply, and transfer knowledge and skills in a variety of settings.

Floral Design (CTAFLP)

9th – 12th 1 credit

Prerequisite: None

Fee: Program fee - \$125.00

Course Description: Floral Design is designed to develop students' ability to identify and demonstrate the principles and techniques related to floral design as well as develop an understanding of the management of floral enterprises. Through the analysis of artistic floral styles and historical periods, students will develop respect for the traditions and contributions of diverse cultures. Students will respond to and analyze floral designs, thus contributing to the development of lifelong skills of making informed judgments and evaluations. To prepare for careers in floral design, students must attain academic skills and knowledge, acquire technical knowledge and skills related to horticultural systems, and develop knowledge and skills regarding career opportunities, entry requirements, and industry expectations. To prepare for success, students need opportunities to learn, reinforce, apply, and transfer their knowledge and skills and technologies in a variety of settings. *This course will satisfy the fine arts credit for graduation.*

Advanced Floral Design (CTAAF)

11th – 12th 1 credit

Prerequisite: Required Floral Design

Fee: Program fee - \$150.00

Course Description: In this course, students build on the knowledge from the Floral Design course and are introduced to more advanced floral design concepts, with an emphasis on specialty designs and specific occasion planning. This course focuses on building skills in advanced floral design and providing students with a thorough understanding of the design elements and planning techniques used to produce unique specialty floral designs that support the goals and objectives of a specific occasion or event. Through the analysis and evaluation of various occasion and event types, students explore the design needs and expectations of clients and propose and evaluate appropriate creations. From conception to evaluation, students are challenged to create and design appropriate specialty floral designs that meet the needs of the client. Furthermore, an emphasis on budgetary adherence and entrepreneurship equips students with many of the necessary skills needed for success in floral enterprises.

Professional Standards in Agribusiness (CTPSAG)

10th - 12th ½ credit

Prerequisite: None

Course Description Professional Standards in Agribusiness primarily focuses on leadership, communication, employer-employee relations, and problem solving as they relate to agribusiness. To prepare for careers in agribusiness systems, students must attain academic skills and knowledge, acquire technical knowledge and skills related to leadership development and the workplace, and develop knowledge and skills regarding agricultural career opportunities, entry requirements, and industry expectations. To prepare for success, students need opportunities to learn, reinforce, apply, and transfer their knowledge and skills in a variety of settings.

Mathematical Applications in Agriculture, Food, and Natural Resources (CTAGMT)

10th-12th 1 credit 4.0

Prerequisite: Required Algebra I. *Recommended* one credit Ag, Food, & Natural Resources Program of Study

Course Description: Mathematical Applications in Agriculture, Food, and Natural Resources, students will apply knowledge and skills related to mathematics, including algebra, geometry, and data analysis in the context of agriculture, food, and natural resources. To prepare for careers in agriculture, food, and natural resources, students must acquire technical knowledge in the discipline as well as apply academic skills in mathematics. To prepare for success, students need opportunities to reinforce, apply, and transfer their knowledge and skills related to mathematics in a variety of contexts. This course satisfies the 3rd or 4th year math credit and is counted in the GPA as an academic elective. *This course satisfies the 3rd year Mathematics credit.*

Entrepreneurship (CTENT)

10th– 12th 1 credit

Prerequisite: *Recommended* Principles of Business, Marketing, and Finance

Course Description: In Entrepreneurship, students will gain the knowledge and skills needed to become an entrepreneur. Students will learn the principles necessary to begin and operate a business. The primary focus of the course is to help students understand the process of analyzing a business opportunity, preparing a business plan, determining feasibility of an idea using research, and developing a plan to organize and promote the business and its products and services. In addition, students will understand the capital required, the return on investment desired, and the potential for profit.

Agricultural Structures Design & Fabrication (CTASDF)

11th-12th 1 credit

Prerequisite: *Recommended* Ag Mechanics and Metal Technologies

Course Description: In Agricultural Structures Design and Fabrication, students will explore career opportunities, entry requirements, and

industry expectations. To prepare for careers in mechanized agriculture and technical systems, students must attain knowledge and skills related to agricultural structures design and fabrication. ***Students will construct metal projects for exhibition.***

Agriculture Equipment Design and Fabrication/Agricultural Laboratory and Field Experience (CTAEDL)
11th-12th **2 credits**

Prerequisite: *Recommended* Ag Mechanics and Metal Technologies

Course Description: In Agricultural Equipment Design and Fabrication, students will acquire knowledge and skills related to the design and fabrication of agricultural equipment. To prepare for careers in mechanized agriculture and technical systems, students must attain knowledge and skills related to agricultural equipment design and fabrication. To prepare for success, students reinforce, apply, and transfer their academic knowledge and technical skills in a variety of settings. ***Students will construct metal projects for exhibition.***

Veterinary Medical Applications (CTAVMA)
11th-12th **1 credit**

Prerequisite: *Required* Equine Science, Small Animal Management, or Livestock Production.

Course Description: Veterinary Medical Applications covers topics relating to veterinary practices, including practices for large and small animal species. To prepare for careers in the field of animal science, students must attain academic skills and knowledge, acquire technical knowledge and skills related to animal systems and the workplace, and develop knowledge and skills regarding career opportunities, entry requirements, and industry expectations. To prepare for success, students need opportunities to learn, reinforce, apply, and transfer knowledge and skills and technologies in a variety of settings. ***Upon completion of course, students have the option to pursue their Certified Veterinary Assistant certification. This entails working in a Veterinary Office under the supervision of a Licensed Veterinarian. More information on this certification will be given to students by their teacher.***

Landscape Design & Management (CTALDD)
10th – 12th **½ credit**

Prerequisite: *None*

Course Description: Landscape Design and Management is designed to develop an understanding of landscape design and management techniques and practices. To prepare for careers in horticultural systems, students must attain academic skills and knowledge, acquire technical knowledge and skills related to horticultural systems and the workplace, and develop knowledge and skills regarding career opportunities, entry requirements, and industry expectations. To prepare for success, students need opportunities to learn, reinforce, apply, and transfer their knowledge and skills and technologies in a variety of settings.

Turf Grass Management (CTTGMG)
10th – 12th **½ credit**

Prerequisite: *None*

Course Description: Turf Grass Management is designed to develop an understanding of turf grass management techniques and practices. To prepare for careers in horticultural systems, students must attain academic skills and knowledge, acquire technical knowledge and skills related to horticultural systems and the workplace, and develop knowledge and skills regarding career opportunities, entry requirements, and industry expectations. To prepare for success, students need opportunities to learn, reinforce, apply, and transfer their knowledge and skills and technologies in a variety of settings.

Advanced Animal Science (CTAAAS)
11th-12th **1 credit** **4.0**

Prerequisite: *Required* Biology and Chemistry or Integrated Physics and Chemistry (IPC); Algebra I and Geometry; and either Small Animal Management, Equine Science, or Livestock Production; *Recommended* Veterinary Medical Applications.

Course Description: Advanced Animal Science examines the interrelatedness of human, scientific, and technological dimensions of livestock production. Instruction is designed to allow for the application of scientific and technological aspects of animal science through field and laboratory experiences. To prepare for careers in the field of animal science, students must attain academic skills and knowledge, acquire knowledge and skills related to animal systems, and develop knowledge and skills regarding career opportunities, entry requirements, and industry standards. To prepare for success, students need opportunities to learn, reinforce, apply, and transfer their knowledge and skills in a variety of settings. To receive credit in science, students must meet the 40% laboratory and fieldwork requirement. ***This course satisfies the 3rd or 4th year science credit and is counted in the GPA as an academic elective.***

Advanced Plant and Soil Science (CTAAPS)
11th-12th **1 credit** **4.0**

Prerequisite: *Recommended* Biology, Integrated Physics and Chemistry (IPC), Chemistry, or Physics and a minimum of one credit from the courses in the Agriculture, Food, and Natural Resources Career Cluster.

Course Description: Advanced Plant and Soil Science provides a way of learning about the natural world. Students should know how plant and soil science has influenced a vast body of knowledge, that there are still applications to be discovered, and that plant and soil science is the basis for many other fields of science. To prepare for careers in plant and soil science, students must attain academic skills and knowledge, acquire technical knowledge and skills related to plant and soil science and the workplace, and develop knowledge and skills regarding career opportunities, entry requirements, and industry expectations. To prepare for success students need opportunities to learn, reinforce, apply, and transfer their knowledge and skills and technologies in a variety of settings. ***This course satisfies the 3rd or 4th year science credit and is counted in the GPA as an academic elective.***

Practicum in Agriculture- Ag Leadership and Communications Pathway or Ag Mechanics Pathway

(CTPRAC)

11th & 12th

2 credits

Prerequisite: *Recommended* a minimum of one credit from the courses in the Agriculture, Food, and Natural Resources Career Cluster.

Course Description: Practicum in Agriculture, Food, and Natural Resources is designed to give students supervised practical application of knowledge and skills. Practicum experiences can occur in a variety of locations appropriate to the nature and level of experiences such as employment, independent study, internships, assistantships, mentor ships, or laboratories. To prepare for careers in agriculture, food and natural resources, students must attain academic skills and knowledge, acquire technical knowledge and skills related to the workplace, and develop knowledge and skills regarding career opportunities, entry requirements, and industry expectations. To prepare for success, students need opportunities to learn, reinforce, apply, and transfer their knowledge and skills and technologies in a variety of settings. The practicum course is a paid or unpaid capstone experience for students participating in a coherent sequence of career and technical education courses in the Ag, Food, and Natural Resources Program of Study.

Career Preparation for Programs of Study + (Extended Career Prep) 3 credits

15+ hours/week (CTPS1X)(CTPS2X)

12th

2 credits

10-14 hours/week (CTPS1)(CTPS2)

Course Requirement: Employment must be secured within 15 days of enrollment in course and maintained throughout remainder of the course; Valid social security number

Prerequisite: at least one Level 2 or higher CTE course

Course Description: Career Preparation for Programs of Study provides additional opportunities for students to develop business and industry employment experiences, which must be related to the student's current program of study alongside advanced classroom instruction. The goal is to prepare students with a variety of skills to transition from job- to career-mindedness. This course provides a continuing focus on collaborative feedback between the employer, teacher, and student. Career Preparation for Programs of Study expands on Career Preparation General by increasing rigor, supporting student attainment of academic standards, and effectively preparing students for college and career success. Employment locations must be available for instructor visitation once per nine weeks and no more than 30 minutes drive time from the school campus.



Architecture and Construction Career Cluster

The Architecture and Construction career cluster focuses on designing, planning, managing, building, and maintaining the built environment. This career cluster includes occupations ranging from architect, carpenter, and construction manager to electrician, plumber and heating, air conditioning, and refrigeration technician.

Statewide Program of Study: *Architectural Drafting and Design*

The Architectural Drafting and Design program of study focuses on occupational and educational opportunities associated with developing, engineering, and designing building structures and facilities. This program of study includes reading, interpreting, and drawing blueprints for interior and exterior construction projects.

Secondary Courses for High School Credit



- Level 1**
 - Principles of Architecture (1 credit)
 - Principles of Construction (1 credit)

- Level 2**
 - Architectural Design I (1 credit)

- Level 3**
 - Architectural Design II (2 credits)

- Level 4**
 - Practicum in Construction Technology (2 credits)
 - Career Preparation for Programs of Study (2 credits)
 - Career Preparation for Programs of Study + Extended Career Preparation for Programs of Study (3 credits)

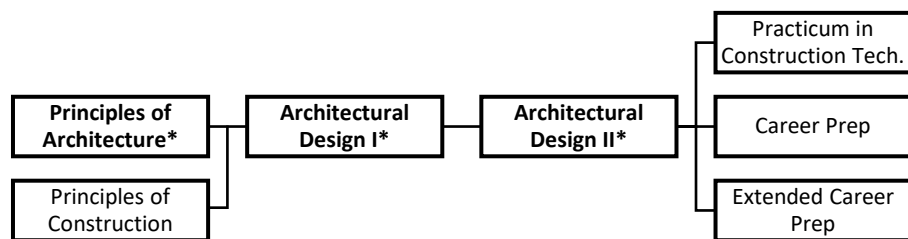

*course where Industry Based Certification can be earned

Work-Based Learning and Expanded Learning Opportunities

| | |
|--|--|
| Work-Based Learning Activities | <ul style="list-style-type: none"> • Intern at an architectural firm to develop CADD drafting and design technology skills • Shadow a civil engineer to learn more about their day-to-day responsibilities |
| Expanded Learning Opportunities | <ul style="list-style-type: none"> • Conduct an informational interview with an architect to learn about their role and responsibilities • Participate in SkillsUSA or TSA |

Aligned Industry-Based Certifications

- Autodesk Associate (Certified User) AutoCAD
- Autodesk Associate (Certified User) Revit Architecture



Example Postsecondary Opportunities

Apprenticeships

- Drafter



Associate Degrees

- CAD/CADD Drafting and/or Design Technology
- Drafting and Design Technology
- Surveying Technology/Surveying
- Architectural Drafting and Architectural CAD/CADD

Bachelor's Degrees

- Civil Engineering
- Construction Engineering
- Surveying Engineering
- Drafting and Design Technology

Master's, Doctoral, and Professional Degrees

- Civil Engineering
- Geographic Information Science and Cartography
- Construction Engineering Technology



Example Aligned Occupations

Architectural and Civil Drafters

Median Wage: \$57,424
Annual Openings: 1,366
10-Year Growth: 15%

Architects

Median Wage: \$80,903
Annual Openings: 966
10-Year Growth: 18%

Construction Managers

Median Wage: \$95,072
Annual Openings: 6,325
10-Year Growth: 24%

Data Source: TexasWages, Texas Workforce Commission. Retrieved 3/8/2024

For more information visit:

<https://tea.texas.gov/academics/college-career-and-military-prep/career-and-technical-education/programs-of-study-additional-resources>





Architecture and Construction Career Cluster

The Architecture and Construction career cluster focuses on designing, planning, managing, building, and maintaining the built environment. This career cluster includes occupations ranging from architect, carpenter, and construction manager to electrician, plumber, and heating, air conditioning, and refrigeration technician.

Statewide Program of Study: Carpentry

The Carpentry program of study focuses on occupational and educational opportunities related to constructing, installing, and repairing structures and fixtures made of wood (including frameworks, partitions, joists, studding, rafters, and stairways). The program of study includes installing, dismantling, or moving machinery and heavy equipment according to layout plans, blueprints, or other drawings.

Secondary Courses for High School Credit



| | |
|---------|--|
| Level 1 | <ul style="list-style-type: none"> Principles of Construction (1 credit) Principles of Architecture (1 credit) |
| Level 2 | <ul style="list-style-type: none"> Construction Technology I (2 credits) Entrepreneurship I (1 credit) |
| Level 3 | <ul style="list-style-type: none"> Construction Technology II (2 credits) |
| Level 4 | <ul style="list-style-type: none"> Practicum in Construction Technology (2 credits) Career Preparation for Programs of Study (2 credits) Career Preparation for Programs of Study + Extended Career Preparation (2 credits) |

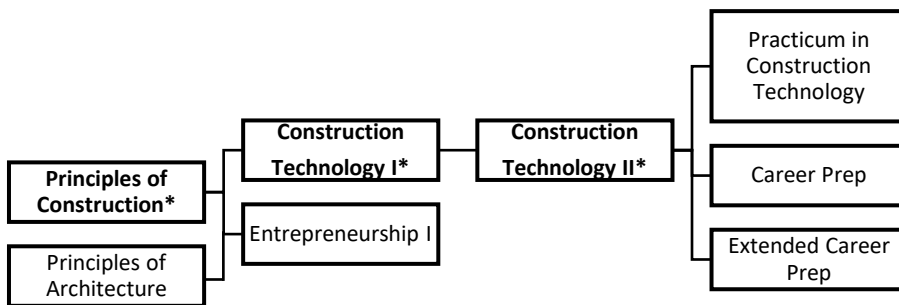

*course where Industry Based Certification can be earned

Work-Based Learning and Expanded Learning Opportunities

| | |
|---------------------------------|--|
| Work-Based Learning Activities | <ul style="list-style-type: none"> Intern with a carpenter to practice skills such as measuring materials and assembling structures Participate in a pre-apprenticeship that includes activities like installing cabinets, drywall, and siding |
| Expanded Learning Opportunities | <ul style="list-style-type: none"> Shadow a construction manager to learn more about how construction teams work together to complete projects Participate in SkillsUSA |

Aligned Industry-Based Certifications

- NCCER Carpentry Level I
- NCCER Carpentry Level II
- NCCER Commercial Carpenter
- NCCER Construction Technology Certification Level I
- NCCER Core



Example Postsecondary Opportunities

Apprenticeships

- Carpenter

Associate Degrees

- Construction Management
- Construction Engineering Technology
- Building Construction Technology

Bachelor's Degrees

- Construction Engineering
- Construction Science
- Construction Site Management

Master's, Doctoral, and Professional Degrees

- Construction Engineering Technology
- Construction Engineering
- Construction Management
- Project Management



Example Aligned Occupations

Drywall and Ceiling Tile Installers

Median Wage: \$44,699
Annual Openings: 758
10-Year Growth: 14%

Carpenters

Median Wage: \$46,272
Annual Openings: 5,623
10-Year Growth: 15%

Construction Managers

Median Wage: \$95,072
Annual Openings: 6,325
10-Year Growth: 24%

Data Source: TexasWages, Texas Workforce Commission. Retrieved 3/8/2024.



For more information visit:

<https://tea.texas.gov/academics/college-career-and-military-prep/career-and-technical-education/programs-of-study-additional-resources>



Architecture and Construction Career Cluster

The Architecture and Construction career cluster focuses on designing, planning, managing, building, and maintaining the built environment. This career cluster includes occupations ranging from architect, carpenter, and construction manager to electrician, plumber and heating, air conditioning and refrigeration technician.

Statewide Program of Study: *Electrical*

The Electrical program of study focuses on occupational and educational opportunities associated with installing, maintaining, and repairing electrical wiring, equipment, and fixtures. The program of study also addresses installing and repairing telecommunications cable including fiber optics.



Secondary Courses for High School Credit

- | | |
|---------|--|
| Level 1 | <ul style="list-style-type: none"> Principles of Architecture (1 credit) Principles of Construction (1 credit) |
| Level 2 | <ul style="list-style-type: none"> Electrical Technology I (1 credit) Entrepreneurship I (1 credit) |
| Level 3 | <ul style="list-style-type: none"> Electrical Technology II (2 credits) |
| Level 4 | <ul style="list-style-type: none"> Practicum in Construction Technology (2 credits) Career Preparation for Programs of Study (2 credits) Career Preparation for Programs of Study + Extended Career Preparation (3 credits) |

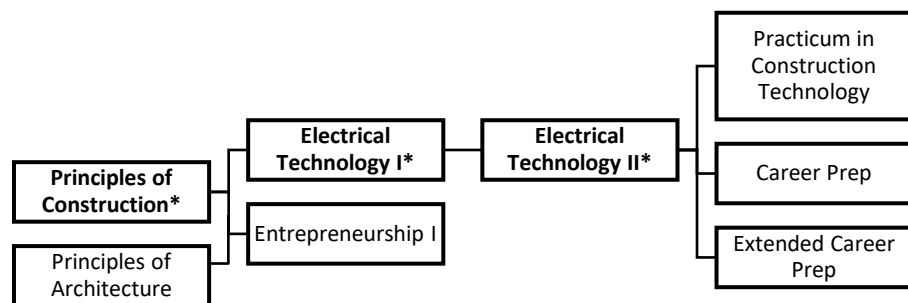

*course where Industry Based Certification can be earned

Work-Based Learning and Expanded Learning Opportunities

| | |
|---------------------------------|---|
| Work-Based Learning Activities | <ul style="list-style-type: none"> Participate in an internship with an electrical company to develop installation skills Join a pre-apprenticeship program that involves determining if electrical wiring is up to code Interview an electrician about their training and education |
| Expanded Learning Opportunities | <ul style="list-style-type: none"> Participate in SkillsUSA Participate in trade competitions |

Aligned Industry-Based Certifications

- NCCER Core
- NCCER Electrical Level I
- NCCER Electrical Level II



Example Postsecondary Opportunities

Apprenticeships

- Electrician

Associate Degrees

- Electrical and Power Transmission Installation
- Electrical Power and Controls
- Electromechanical Technology

Bachelor's Degrees

- Construction Engineering
- Electrical, Electronic, and Communications
- Engineering Electrical Engineering

Master's, Doctoral, and Professional Degrees

- Construction Engineering
- Construction Management

Additional Stackable IBCs/License

- Journeyman Electrician
- Master Electrician



Example Aligned Occupations

Electricians Helpers

Median Wage: \$38,140
Annual Openings: 1,632
10-Year Growth: 20%

Electricians

Median Wage: \$54,769
Annual Openings: 9,221
10-Year Growth: 27%

Construction Managers

Median Wage: \$95,072
Annual Openings: 6,325
10-Year Growth: 24%

Data Source: TexasWages, Texas Workforce Commission. Retrieved 3/8/2024



For more information visit:

<https://tea.texas.gov/academics/college-career-and-military-prep/career-and-technical-education/programs-of-study-additional-resources>



Architecture and Construction Career Cluster

The Architecture and Construction career cluster focuses on designing, planning, managing, building, and maintaining the built environment. This career cluster includes occupations ranging from architects, carpenters, and construction managers to electricians, plumbers, and heating, air conditioning, and refrigeration technicians.

Statewide Program of Study: HVAC and Sheet Metal

The HVAC and Sheet Metal program of study focuses on occupational and educational opportunities associated with installing, servicing, or repairing heating and air conditioning systems. The program of study addresses fabrication, assembly, installation, and repair of sheet metal products and equipment, such as ducts, control boxes, drainpipes, and furnace casings.

Secondary Courses for High School Credit



- Level 1**
 - Principles of Architecture (1 credit)
 - Principles of Construction (1 credit)

- Level 2**
 - Heating, Ventilation, and Air Conditioning (HVAC) and Refrigeration Technology I (1 credit)
 - Entrepreneurship I (1 credit)

- Level 3**
 - Heating, Ventilation, and Air Conditioning (HVAC) and Refrigeration Technology II (2 credits)

- Level 4**
 - Practicum in Construction Technology (2 credits)
 - Career Preparation for Programs of Study (2 credits)
 - Career Preparation for Programs of Study + Extended Career Preparation (3 credits)



Example Postsecondary Opportunities

Apprenticeships

- Heating and Air Conditioning Installer



Associate Degrees

- Heating, Air Conditioning, Ventilation and Refrigeration Maintenance Technology
- Construction Site Management
- Property Maintenance
- Sheet Metal Technology/Sheetworking

Bachelor's Degrees

- Construction Engineering
- Construction Management
- Building/Construction Site Management
- Heating, Air Conditioning, Ventilation and Refrigeration Maintenance Technology

Master's, Doctoral, and Professional Degrees

- Construction Engineering
- Construction Management

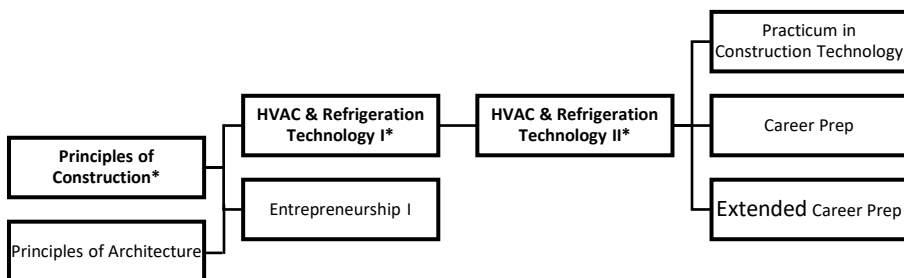

*course where Industry Based Certification can be earned

Work-Based Learning and Expanded Learning Opportunities

| | |
|--|---|
| Work-Based Learning Activities | <ul style="list-style-type: none"> • Participate in a pre-apprenticeship in HVAC and refrigeration • Intern with an HVAC company to practice installing and repairing heating and cooling systems |
| Expanded Learning Opportunities | <ul style="list-style-type: none"> • Job shadow an HVAC technician or cost estimator • Participate in SkillsUSA |

Aligned Industry-Based Certifications

- NCCER Core
- NCCER Heating, Ventilation, Air Conditioning Level I
- Refrigerant Handling (EPA 608)



Example Aligned Occupations

Helpers—Installation, Maintenance, and Repair Workers

Median Wage: \$33,348
Annual Openings: 2,366
10-Year Growth: 22%

Heating, Air Conditioning, and Refrigeration Mechanics and Installers

Median Wage: \$48,722
Annual Openings: 3,719
10-Year Growth: 21%

Construction Managers

Median Wage: \$95,072
Annual Openings: 6,325
10-Year Growth: 24%

Data Source: TexasWages, Texas Workforce Commission. Retrieved 3/8/2024



For more information visit:
<https://tea.texas.gov/academics/college-career-and-military-prep/career-and-technical-education/programs-of-study-additional-resources>

ARCHITECTURE AND CONSTRUCTION

Principles of Architecture

(CTPARC)

9th – 12th

1 credit

Prerequisite: None

Course Description: Principles of Architecture provides an overview to the various fields of architecture, interior design, and construction management. Achieving proficiency in decision making and problem solving is an essential skill for career planning and lifelong learning. Studies use self-knowledge, education, and career information to set and achieve realistic career and educational goals. Job-specific training can be provided through training modules that identify career goals in trade and industry areas. Classroom studies include topics such as safety, work ethics, communication, information technology applications, systems, health, environment, leadership, teamwork, ethical and legal responsibility, employability, and career development and include skills such as problem solving, critical thinking, and reading technical drawings.

Principles of Construction

(CTPCON)

9th – 12th

1 credit

Prerequisite: None

Course Description: Principles of Construction is intended to provide an introduction and lay a solid foundation for those students entering the construction or craft skilled areas. The course provides a strong knowledge of construction safety, construction mathematics, and common hand and power tools. *Students will earn NCCER Core Curriculum Certification*

Architectural Design I

(CTAADS)

10th – 12th

1 credit

Prerequisite: *Required* Algebra I and English I; *Recommended* Geometry, Principles of Architecture, and Principles of Construction.

Course Description: In Architectural Design I, students will gain knowledge and skills needed to enter a career in architecture or construction or prepare a foundation toward a postsecondary degree in architecture, construction science, drafting, interior design, or landscape architecture. Architectural Design I include the knowledge of the design, design history, techniques, and tools related to the production of drawings, renderings, and scaled models for nonresidential or residential architectural purposes.

Architectural Design II

(CTADAD)

11th – 12th

2 credits

Prerequisite: *Required* Architectural Design I and Geometry; *Recommended* Principles of Architecture and Principles of Construction.

Course Description: In Architectural Design II, students will gain advanced knowledge and skills needed to enter a career in architecture or construction or prepare a foundation toward a postsecondary degree in architecture, construction science, drafting, interior design, or landscape architecture. Architectural Design II includes the advanced knowledge of the design, design history, techniques, and tools related to the production of drawings, renderings, and scaled models for nonresidential or residential architectural purposes.

Construction Technology I

(CTCTBT)

10th – 12th

2 credits

Prerequisite: *Recommended* Principles of Construction or Principles of Architecture.

Course Description: In Construction Technology I, students will gain knowledge and skills needed to enter the workforce as carpenters or building maintenance supervisors or to prepare for a postsecondary degree in construction management, architecture, or engineering. Students will acquire knowledge and skills in safety, tool usage, building materials, codes, and framing. *Students will earn NCCER Carpentry I Industry Certification.*

Entrepreneurship

(CTENT)

10th– 12th

1 credit

Prerequisite: *Recommended* Principles of Business, Marketing, and Finance

Course Description: In Entrepreneurship, students will gain the knowledge and skills needed to become an entrepreneur. Students will learn the principles necessary to begin and operate a business. The primary focus of the course is to help students understand the process of analyzing a business opportunity, preparing a business plan, determining feasibility of an idea using research, and developing a plan to organize and promote the business and its products and services. In addition, students will understand the capital required, the return on investment desired, and the potential for profit.

Construction Technology II

(CTACBT)

11th – 12th

2 credits

Prerequisite: *Required* Construction Technology I.

Course Description: In Construction Technology II, students will gain advanced knowledge and skills needed to enter the workforce as carpenters, building maintenance technicians, or supervisors or to prepare for a postsecondary degree in construction management, architecture, or engineering. Students will build on the knowledge base from Construction Technology I and are introduced to exterior and interior finish out skills. *Students will earn Shop Bot Level 1 Certification.*

Practicum in Construction Technology (CTBTPR)
12th **2 credits**
Prerequisite: *Required* Construction Technology II, Electrical Technology II or Heating, Ventilation and Air Conditioning (HVAC) and Refrigeration Technology II.
Course Description: In Practicum in Construction Technology, students will be challenged with the application of gained knowledge and skills from Construction Technology I and II. In many cases students will be allowed to work at a job (paid or unpaid) outside of school or be involved in local projects the school has approved for this class.

Electrical Technology I (CTET1)
10th – 12th **1 credit**
Prerequisite: *Recommended* Principles of Construction or Principles of Architecture
Course Description: In Electrical Technology I, students will gain knowledge and skills needed to enter the workforce as an electrician or building maintenance supervisor, prepare for a postsecondary degree in a specified field of construction or construction management, or pursue an approved apprenticeship program. Students will acquire knowledge and skills in safety, electrical theory, tools, codes, installation of electrical equipment, and the reading of electrical drawings, schematics, and specifications.

Electrical Technology II (CTET2)
11th-12th **2 credits**
Prerequisite: *Required* Electrical Technology I. *Recommended:* Principles of Architecture or Principles of Construction
Course Description: In Electrical Technology II, students will gain advanced knowledge and skills needed to enter the workforce as an electrician, a building maintenance technician, or a supervisor; prepare for a postsecondary degree in a specified field of construction or construction management; or pursue an approved apprenticeship program. Students will acquire knowledge and skills in safety, electrical theory, tools, codes, installation of electrical equipment, alternating current and direct current motors, conductor installation, installation of electrical services, and electric lighting installation.

Heating, Ventilation, and Air Conditioning (HVAC) and Refrigeration Technology I (CTHVA1)
10th – 12th **1 credit**
Prerequisite: *Recommended* Principles of Architecture, Principles of Construction, or Construction Technology 1
Course Description: In Heating, Ventilation, and Air Conditioning (HVAC) and Refrigeration Technology I, students will gain knowledge and skills needed to enter the industry as technicians in the HVAC and refrigeration industry or building maintenance industry, prepare for a postsecondary degree in a specified field of construction management, or pursue an approved apprenticeship program. Students will acquire knowledge and skills in safety, principles of HVAC theory, use of tools, codes, and installation of HVAC and refrigeration equipment.

Heating, Ventilation, and Air Conditioning (HVAC) and Refrigeration Technology II (CTHVA2)
11th – 12th **2 credits**
Prerequisite: *Recommended* Principles of Architecture, Principles of Construction or Construction Technology 1
Course Description: In Heating, Ventilation, and Air Conditioning (HVAC) and Refrigeration Technology II, students will gain advanced knowledge and skills needed to enter the industry as HVAC and refrigeration technicians or building maintenance technicians or supervisors, prepare for a postsecondary degree in a specified field of construction or construction management, or pursue an approved apprenticeship program. Students will acquire knowledge and skills in safety, electrical theory, use of tools, codes, installation of commercial HVAC equipment, heat pumps, troubleshooting techniques, various duct systems, and maintenance practices.

Career Preparation for Programs of Study + (Extended Career Prep) **3 credits** **15+ hours/week (CTPS1X)(CTPS2X)**
12th **2 credits** **10-14 hours/week (CTPS1)(CTPS2)**
Course Requirement: Employment must be secured within 15 days of enrollment in course and maintained throughout remainder of the course; Valid social security number
Prerequisite: at least one Level 2 or higher CTE course
Course Description: Career Preparation for Programs of Study provides additional opportunities for students to develop business and industry employment experiences, which must be related to the student's current program of study alongside advanced classroom instruction. The goal is to prepare students with a variety of skills to transition from job- to career-mindedness. This course provides a continuing focus on collaborative feedback between the employer, teacher, and student. Career Preparation for Programs of Study expands on Career Preparation General by increasing rigor, supporting student attainment of academic standards, and effectively preparing students for college and career success. Employment locations must be available for instructor visitation once per nine weeks and no more than 30 minutes drive time from the school campus. (pending board approval)

Arts, Audio Visual Technology, and Communication Career Cluster

The Arts, Audio Visual Technology, and Communication (AAVTC) career cluster focuses on designing, producing, exhibiting, performing, writing, and publishing multimedia content requiring creative aptitude, fluency in computer and technology applications, and proficiency in oral and written communication. This career cluster includes occupations ranging from camera operator, audio and video technician, director, and producer to graphic designer and web and digital interface designer.

Statewide Program of Study: Digital Communications

The Digital Communications program of study focuses on occupational and educational opportunities associated with the production of audio and visual media formats for various purposes, such as TV broadcasts, advertising, video production, or motion pictures. The program of study includes operating machines and equipment such as microphones, sound speakers, video screens, projectors, video monitors, sound and mixing boards, and related electronic equipment to record sound and images.

Secondary Courses for High School Credit

- Level 1**
 - Principles of Arts, Audio/Video Technology, and Communications (1 credit)
 - Professional Communications (½ credit) [offered at JH]

- Level 2**
 - Audio/Video Production I (1 credit)
 - Entrepreneurship I (1 credit)

- Level 3**
 - Audio/Video Production II + Audio/Video Production II Lab (2 credits)

- Level 4**
 - Practicum in Audio/Video Production (2 credits)
 - Career Preparation for Programs of Study (2 credits)
 - Career Preparation for Programs of Study + Extended Career Preparation (3 credits)

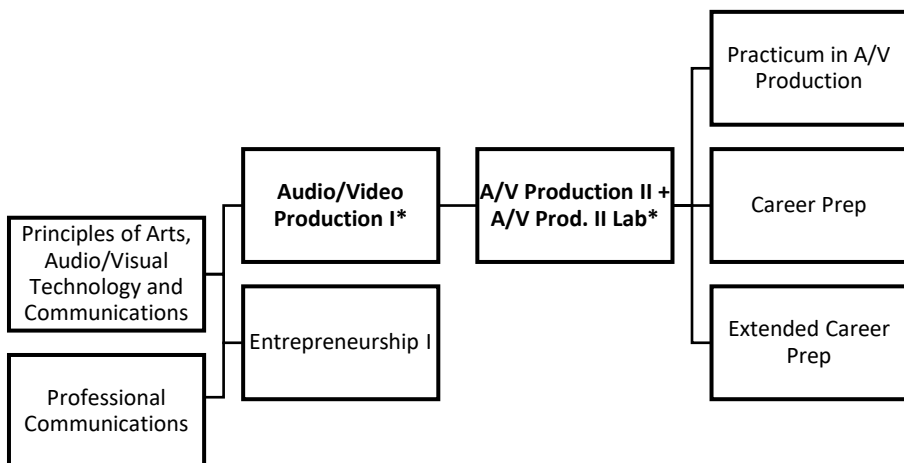

*course where Industry Based Certification can be earned

Work-Based Learning and Expanded Learning Opportunities

| | |
|--|---|
| Work-Based Learning Activities | <ul style="list-style-type: none"> • Shadow a sound designer to learn how sound and foley are created for movies or podcasts • Intern with a technical director at a sports team, recording studio, or radio station • Shadow a technician on a live news broadcast, concert, or other event |
| Expanded Learning Opportunities | <ul style="list-style-type: none"> • Participate in SkillsUSA or TSA • Participate in Student Television Network • Capture and edit film and audio for a podcast with a local community organization |

Aligned Industry-Based Certifications

- Adobe Certified Professional in Digital Video Using Adobe Premiere Pro
- Adobe Certified Professional in Visual Design Using Adobe Photoshop



Example Postsecondary Opportunities

Apprenticeships

- Light Technician

Associate Degrees

- Commercial and Advertising Art
- Animation, Interactive Technology, Video Graphics, and Special Effects

Bachelor's Degrees

- Cinematography and Film/Video Production
- Recording Arts Technology

Master's, Doctoral, and Professional Degrees

- Animation, Interactive Technology, Video Graphics, and Special Effects
- Communications Technology

Additional Stackable IBCs/License

- CompTIA Digital Media and Entertainment Professional Certification (DMEP)

Example Aligned Occupations

Camera Operators, Television, Video, and Film

Median Wage: \$48,422
Annual Openings: 155
10-Year Growth: 20%

Audio and Video Technicians

Median Wage: \$46,319
Annual Openings: 626
10-Year Growth: 30%

Producers and Directors

Median Wage: \$65,029
Annual Openings: 522
10-Year Growth: 12%

Data Source: TexasWages, Texas Workforce Commission. Retrieved 3/8/2024.



For more information visit:
<https://tea.texas.gov/academics/college-career-and-military-prep/career-and-technical-education/programs-of-study-additional-resources>

Arts, Audio Visual Technology, and Communication Career Cluster



The Arts, Audio Visual Technology, and Communication (AAVTC) career cluster focuses on designing, producing, exhibiting, performing, writing, and publishing multimedia content requiring creative aptitude, fluency in computer and technology applications, and proficiency in oral and written communication. This career cluster includes occupations ranging from camera operator, audio and video technician, director, and producer to graphic designer and web and digital interface designer.

Statewide Program of Study: *Graphic Design and Interactive Media*

The Graphic Design and Interactive Media program of study focuses on occupational and educational opportunities associated with designing or creating graphics to meet specific commercial or promotional needs, such as packaging, displays, or logos. The program of study includes designing clothing and accessories and creating special effects, animation, or other visual images using film, video, computers, or other electronic tools and media for use in computer games, movies, music videos, and commercials.



Secondary Courses for High School Credit

- | | |
|---------|--|
| Level 1 | <ul style="list-style-type: none"> Principles of Arts, Audio/Video Technology, and Communications (1 credit) Digital Media (1 credit) |
| Level 2 | <ul style="list-style-type: none"> Graphic Design and Illustration I (1 credit) Game Programming and Design (1 credit) Entrepreneurship I (1 credit) |
| Level 3 | <ul style="list-style-type: none"> Graphic Design and Illustration II + Graphic Design and Illustration II Lab (2 credits) |
| Level 4 | <ul style="list-style-type: none"> Practicum in Graphic Design and Illustration (2 credits) Career Preparation for Programs of Study (2 credits) Career Preparation for Programs of Study + Extended Career Preparation (3 credits) |

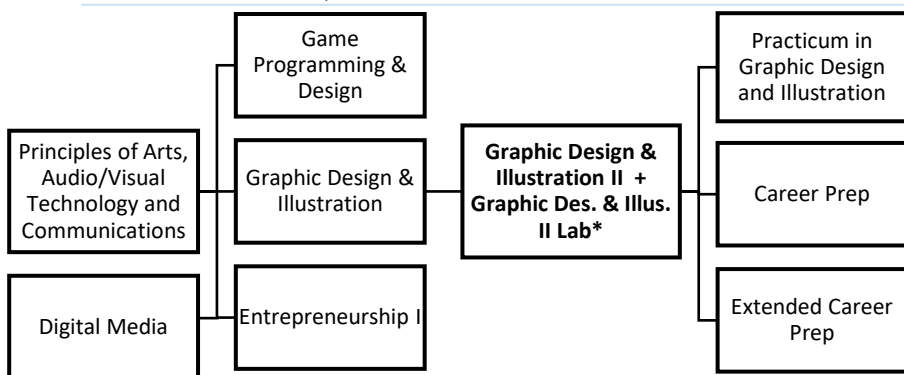

*course where Industry Based Certification can be earned

Aligned Advanced Academic Courses

| | |
|--------------------|---|
| AP | AP Studio Art: Two-Dimensional Design Portfolio |
| Dual Credit | ARTC 1302 Digital Imaging (Graphic Design II) |

Students should be advised to consider these course opportunities to enrich their preparation. AP or IB courses not listed under the Secondary Courses for High School Credit section of this framework document do not count towards concentrator/completer status for this program of study.

Work-Based Learning and Expanded Learning Opportunities

| | |
|--|---|
| Work-Based Learning Activities | <ul style="list-style-type: none"> Shadow an art director at a branding firm or design agency Intern in the marketing and communications department of a technology company |
| Expanded Learning Opportunities | <ul style="list-style-type: none"> Participate in SkillsUSA or TSA Participate in Student Television Network Join a related co-curricular or extracurricular club such as web development or computer coding |

Aligned Industry-Based Certifications

- Adobe Certified Professional in Graphic Design and Illustration Using Adobe Illustrator
- Adobe Certified Professional in Visual Design Using Adobe Photoshop

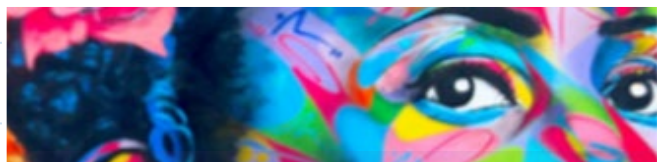

Example Postsecondary Opportunities

Associate Degrees

- Graphic Design
- Digital Arts



Bachelor's Degrees

- Web Page, Digital/Multimedia and Information Resources Design
- Design and Visual Communications

Master's, Doctoral, and Professional Degrees

- Game and Interactive Media Design
- Animation, Interactive Technology, Video Graphics, and Special Effects

Additional Stackable IBCs/License

- Certified Textile Designer (CTD)



Example Aligned Occupations

Software Developers

Median Wage: \$111,705
Annual Openings: 15,324
10-Year Growth: 36%

Graphic Designers

Median Wage: \$50,973
Annual Openings: 1,766
10-Year Growth: 10%

Art Directors

Median Wage: \$81,926
Annual Openings: 619
10-Year Growth: 18%

Data Source: TexasWages, Texas Workforce Commission. Retrieved 3/8/2024



For more information visit:
<https://tea.texas.gov/academics/college-career-and-military-prep/career-and-technical-education/programs-of-study-additional-resources>

ARTS, A/V TECHNOLOGY, AND COMMUNICATION

Professional Communications

(CTATPC)

9th – 12th

½ credit

Prerequisite: *None*

Course Description: Professional Communications blends written, oral, and graphic communication in a career-based environment. Careers in the global economy require individuals to be creative and have a strong background in computer and technology applications, a strong and solid academic foundation, and a proficiency in professional oral and written communications. Within this context, students will be expected to develop and expand the ability to write, read, edit, speak, listen, apply software applications, manipulate computer graphics, and conduct Internet research.

Principles of Arts, Audio/Video Technology, and Communications

(CTPAAV)

9th

1 credit

Prerequisite: *None*

Course Description: Careers in the Arts, Audio/Video Technology, and Communications Career Cluster require a creative aptitude, a strong background in computer and technology applications, a strong academic foundation, and a proficiency in oral and written communication. Within this context, students will be expected to develop an understanding of the various and multifaceted career opportunities in this cluster and the knowledge, skills, and educational requirements for those opportunities.

Audio/Video Production I

(CTAUPP)

9th – 12th

1 credit

Prerequisite: *Recommended* Principles of Arts, Audio/Video Technology, and Communications

Course Description: Careers in audio and video technology and film production span all aspects of the audio/video communications industry. Within this context, in addition to developing technical knowledge and skills needed for success in the Arts, Audio/Video Technology, and Communications Career Cluster, students will be expected to develop an understanding of the industry with a focus on pre-production, production, and post-production audio and video products.

Entrepreneurship

(CTENT)

10th– 12th

1 credit

Prerequisite: *Recommended* Principles of Business, Marketing, and Finance

Course Description: In Entrepreneurship, students will gain the knowledge and skills needed to become an entrepreneur. Students will learn the principles necessary to begin and operate a business. The primary focus of the course is to help students understand the process of analyzing a business opportunity, preparing a business plan, determining feasibility of an idea using research, and developing a plan to organize and promote the business and its products and services. In addition, students will understand the capital required, the return on investment desired, and the potential for profit.

Audio/Video Production II/Lab

(CTAVP2)

10th – 12th

2 credits

Prerequisite: *Required* Audio/Video Production I

Course Description: Careers in audio and video technology and film production span all aspects of the audio/video communications industry. Building upon the concepts taught in Audio/Video Production, in addition to developing advanced knowledge and skills needed for success in the Arts, Audio/Video Technology, and Communications Career Cluster, students will be expected to develop an advanced understanding of the industry with a focus on pre-production, production, and post- production products. This course may be implemented in an audio format or a format with both audio and video.

Practicum in Audio/Video Production

(CTPAVP)

11th - 12th

2 credits

Prerequisite: *Required* Audio/Video Production II and Audio/Video Production II Lab

Course Description: Careers in audio/video production span all aspects of the audio/video communications industry. Building upon the concepts taught in Audio/Video Production II and its co-requisite Audio/Video Production II Lab, in addition to developing advanced technical knowledge and skills needed for success in the Arts, Audio/Video Technology, and Communications Career Cluster students will be expected to develop an increasing understanding of the industry with a focus on applying pre-production, production, and post-production audio and video products in a professional environment. This course may be implemented in an advanced audio/video or audio format. Instruction may be delivered through lab-based classroom experiences or career preparation opportunities.

Game Programming and Design

(TACGPG)

9th – 12th

1 credit

Prerequisite: *Required* Algebra I

Course Description: Game Programming and Design will foster student creativity and innovation by presenting students with opportunities to design, implement, and present meaningful programs through a variety of media. Students will collaborate with one another, their instructor, and various electronic communities to solve gaming problems. Through data analysis, students will include the

identification of task requirements, plan search strategies, and use programming concepts to access, analyze, and evaluate information needed to design games. By acquiring programming knowledge and skills that support the work of individuals and groups in solving problems, students will select the technology appropriate for the task, synthesize knowledge, create solutions, and evaluate the results. Students will learn digital citizenship by researching current laws and regulations and by practicing integrity and respect. Students will create a computer game that is presented to an evaluation panel.

Digital Media (CTDIME)

9th – 12th 1 credit

Prerequisite: None

Course Description: In Digital Media, students will analyze and assess current and emerging technologies, while designing and creating multimedia projects that address customer needs and resolve a problem. Students will implement personal and interpersonal skills to prepare for a rapidly evolving workplace environment. The knowledge and skills acquired and practiced will enable students to successfully perform and interact in a technology-driven society. Students will enhance reading, writing, computing, communication, and critical thinking and apply them to the IT environment.

Graphic Design and Illustration I (CTGD1)

10th – 12th 1 credit

Prerequisite: *Recommended* Principles of Arts, Audio/Video Technology, and Communications

Course Description: In Graphic Design, students will apply academic knowledge in art and design projects. Students will use personal information management, email, Internet, writing and publishing, and presentation applications for art and design projects. Laws regarding use and technology as well as cyber security procedures will also be applied. Students will conduct oral and written critiques of design while learning about the history of design. Students will create original two- or three- dimensional projects.

Graphic Design and Illustration II (ARTC 1302) Technical Dual Credit (CTGD2)

10th – 12th 2 credits

Prerequisite: *Required* Graphic Design and Illustration I

Course Description: Within this context, students will be expected to develop an advanced understanding of the industry with a focus on mastery of content knowledge and skills. Focuses on careers in designing, producing, exhibiting, performing, writing, and publishing multimedia content, including visual and performing arts and design, journalism, and entertainment services. Students who enroll in this course are eligible to earn dual credit for ARTC 1302: Digital Imaging 1 through Blinn College. Students must complete an Apply Texas Application and submit the Dual Credit Application with Blinn College.

Practicum in Graphic Design and Illustration (CTGDPR)

10th – 12th 2 credits

Prerequisite: Graphic Design and Illustration II

Course Description: The Arts, Audio/Video Technology, and Communications Career Cluster is focused on careers in designing, producing, exhibiting, performing, writing, and publishing multimedia content, including visual and performing arts and design, journalism, and entertainment services. Careers in graphic design and illustration span all aspects of the advertising and visual communications industry. Within this context, in addition to developing technical knowledge and skills needed for success in the Arts, Audio/Video Technology, and Communications Career Cluster, students will be expected to develop a technical understanding of the industry with a focus on skill proficiency. Instruction may be delivered through lab-based classroom experiences or career preparation opportunities.

Career Preparation for Programs of Study + (Extended Career Prep) 3 credits 15+ hours/week (CTPS1X)(CTPS2X)

12th 2 credits 10-14 hours/week (CTPS1)(CTPS2)

Course Requirement: Employment must be secured within 15 days of enrollment in course and maintained throughout remainder of the course; Valid social security number

Prerequisite: at least one Level 2 or higher CTE course

Course Description: Career Preparation for Programs of Study provides additional opportunities for students to develop business and industry employment experiences, which must be related to the student's current program of study alongside advanced classroom instruction. The goal is to prepare students with a variety of skills to transition from job- to career-mindedness. This course provides a continuing focus on collaborative feedback between the employer, teacher, and student. Career Preparation for Programs of Study expands on Career Preparation General by increasing rigor, supporting student attainment of academic standards, and effectively preparing students for college and career success. Employment locations must be available for instructor visitation once per nine weeks and no more than 30 minutes drive time from the school campus.

Business, Marketing, and Finance Career Cluster

The Business, Marketing, and Finance career cluster focuses on careers in planning, organizing, directing, and evaluating business functions essential to efficient and productive business operations. This career cluster includes occupations ranging from business owner and entrepreneur to accountant, retail manager, and market analyst.

Statewide Program of Study: Accounting and Financial Services

The Accounting and Financial Services program of study focuses on occupational and educational opportunities associated with examining, analyzing, and interpreting financial records. It includes exploration of financial services, preparing financial statements, auditing financial statements prepared by others, and interpreting accounting records. This program of study also introduces students to mathematical modeling tools.



Secondary Courses for High School Credit

- Principles of Business, Marketing, and Finance (1 credit) [offered at JH]
- | | |
|----------------|--|
| Level 1 | <ul style="list-style-type: none"> • Business Information Management I (1 credit) • Money Matters (1 credit) |
| Level 2 | <ul style="list-style-type: none"> • Accounting I (1 credit) • Entrepreneurship I (1 credit) |
| Level 3 | <ul style="list-style-type: none"> • Accounting II (1 credit) |
| Level 4 | <ul style="list-style-type: none"> • Practicum in Business Management (2 credits) • Career Preparation for Programs of Study (2 credits) • Career Preparation for Programs of Study + Extended Career Preparation (3 credits) |

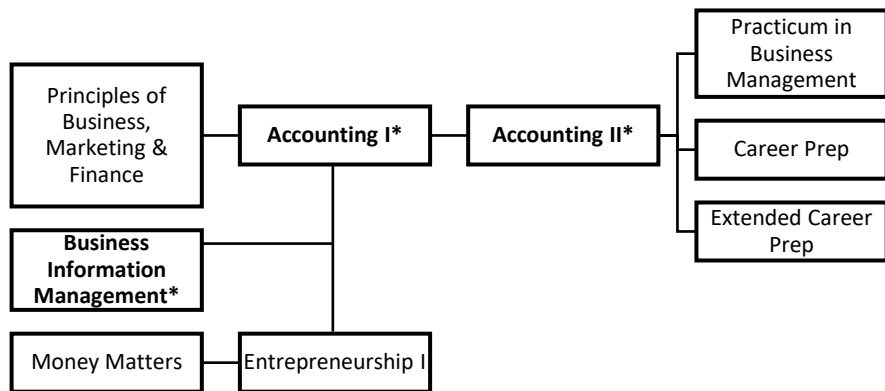

*course where Industry Based Certification can be earned

Work-Based Learning and Expanded Learning Opportunities

| | |
|--|--|
| Work-Based Learning Activities | <ul style="list-style-type: none"> • Intern with a certified public accountant (CPA) at a local business • Intern with a city or county auditor’s office • Shadow a financial advisor as an intern at an investment company |
| Expanded Learning Opportunities | <ul style="list-style-type: none"> • Participate in BPA, DECA, or FBLA • Explore student membership in professional organizations such as AICPA, CIMA, or TXCPA |

Aligned Industry-Based Certifications

- Accounting – Basic
- Accounting Foundations
- Microsoft Office Specialist: Microsoft Excel Expert (Excel 2019)
- Microsoft Office Specialist: Microsoft Access Expert (Access 2019)



Successful completion of the Accounting and Financial Services program of study will fulfill requirements of the Business and Industry endorsement.

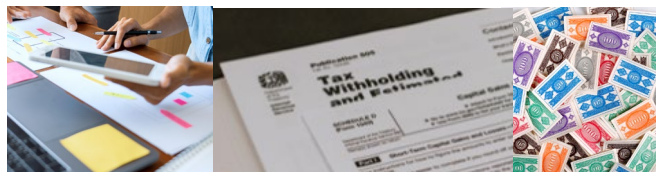

Example Postsecondary Opportunities

Associate Degrees

- Accounting
- Bookkeeping

Bachelor’s Degrees

- Accounting
- Banking and Financial Support Services

Master’s, Doctoral, and Professional Degrees

- Business Administration and Management
- Finance

Additional Stackable IBCs/License

- Project Management Professional
- Property Tax Consultants Service Contract Providers



Example Aligned Occupations

Tax Preparers

Median Wage: \$56,956
Annual Openings: 898
10-Year Growth: 14%

Accountants and Auditors

Median Wage: \$78,022
Annual Openings: 12,989
10-Year Growth: 20%

Personal Financial Advisors

Median Wage: \$77,605
Annual Openings: 1,877
10-Year Growth: 21%

Data Source: TexasWages, Texas Workforce Commission. Retrieved 3/8/2024..



For more information visit:

<https://tea.texas.gov/academics/college-career-and-military-prep/career-and-technical-education/programs-of-study-additional-resources>

Business, Marketing, and Finance Career Cluster

The Business, Marketing, and Finance career cluster focuses on careers in planning, organizing, directing, and evaluating business functions essential to efficient and productive business operations. This career cluster includes occupations ranging from business owner and entrepreneur, to accountant, retail manager, and market analyst.

Statewide Program of Study: *Entrepreneurship*

The Entrepreneurship program of study focuses on occupational and educational opportunities associated with planning, launching, directing, and coordinating public or private sector ventures. This program of study includes formulating policies, launching businesses or organizations, managing daily operations, analyzing management structures, and planning for the use of materials and human resources.

Secondary Courses for High School Credit



- Level 1**
 - Principles of Business, Marketing, and Finance (1 credit) [offered at JH]
 - Business Information Management I (1 credit)
- Level 2**
 - Entrepreneurship I (1 credit)
- Level 3**
 - Practicum in Business Management (2 credits)
 - Career Preparation for Programs of Study (2 credits)
- Level 4**
 - Career Preparation for Programs of Study + Extended Career Preparation (3 credits)

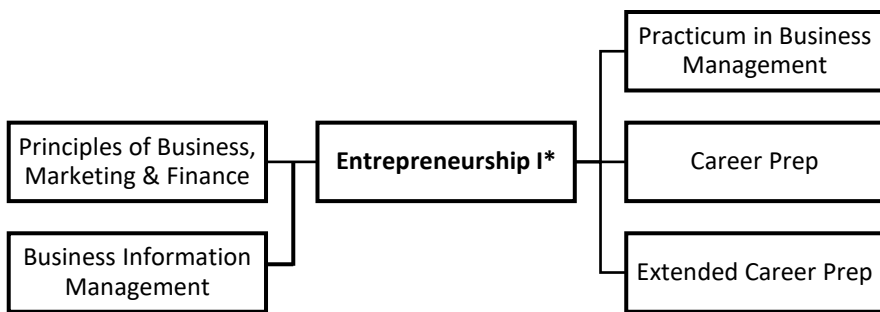

*course where Industry Based Certification can be earned

Aligned Advanced Academic Courses

| | |
|----|---------------|
| AP | AP Statistics |
|----|---------------|

Students should be advised to consider these course opportunities to enrich their preparation. AP or IB courses not listed under the Secondary Courses for High School Credit section of this framework document do not count towards concentrator/completer status for this program of study.

Work-Based Learning and Expanded Learning Opportunities

| | |
|--|--|
| Work-Based Learning Activities | <ul style="list-style-type: none"> • Intern at a local start-up or a business incubator • Participate in the development and launch of a school-based enterprise |
| Expanded Learning Opportunities | <ul style="list-style-type: none"> • Job shadow an entrepreneur • Participate in BPA, DECA, FBLA, or related UIL events |

Aligned Industry-Based Certifications

- Customer Service and Sales: Certified Specialist
- Entrepreneurship and Small Business

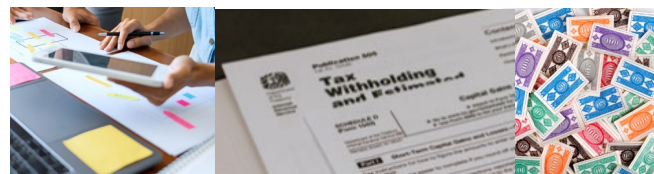

Example Postsecondary Opportunities

Associate Degrees

- Operations Management and Supervision
- Organizational Leadership



Bachelor's Degrees

- Business Administration and Management
- Public Administration

Master's, Doctoral, and Professional Degrees

- Business Administration
- Public Administration

Additional Stackable IBCs/License

- Salesforce
- Service Contract Providers



Example Aligned Occupations

General and Operations Managers

Median Wage: \$83,220
Annual Openings: 25,450
10-Year Growth: 23%

Management Analysts

Median Wage: \$93,983
Annual Openings: 6,030
10-Year Growth: 25%

Chief Executives

Median Wage: \$163,567
Annual Openings: 648
10-Year Growth: 3%

Entrepreneurship

Data Source: TexasWages, Texas Workforce Commission. Retrieved 3/8/2024.



For more information visit:
<https://tea.texas.gov/academics/college-career-and-military-prep/career-and-technical-education/programs-of-study-additional-resources>

Business, Marketing, and Finance Career Cluster

The Business, Marketing, and Finance career cluster focuses on careers in planning, organizing, directing, and evaluating business functions essential to efficient and productive business operations. This career cluster includes occupations ranging from business owner and entrepreneur to accountant, retail manager, and market analyst.

Statewide Program of Study: *Marketing and Sales*

The Marketing and Sales program of study focuses on occupational and educational opportunities associated with collecting information to estimate potential sales of a product or service and create campaigns to market or distribute goods and services. It includes applying data related to customer demographics, preferences, needs, and buying habits.

Secondary Courses for High School Credit

- Level 1**
 - Principles of Business, Marketing, and Finance (1 credit) [offered at JH]
 - Digital Media (1 credit)

- Level 2**
 - Sports and Entertainment Marketing (½ credit)
 - Virtual Business (½ credit)
 - Entrepreneurship I (1 credit)

- Level 3**
 - Fundamentals of Real Estate (2 credits)
 - Retail Management (1 credit)

- Level 4**
 - Career Preparation for Programs of Study (2 credits)
 - Career Preparation for Programs of Study + Extended Career Preparation (3 credits)

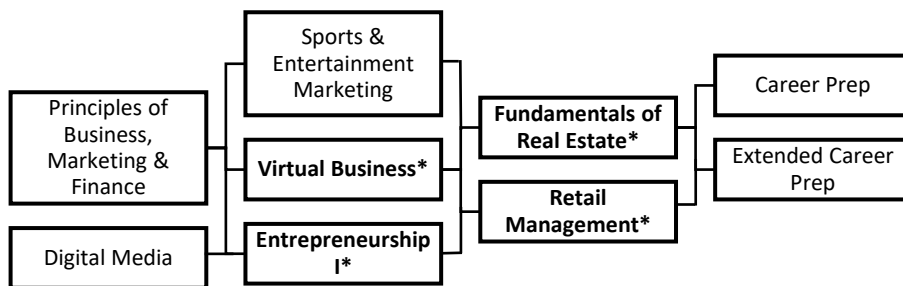

*course where Industry Based Certification can be earned

Aligned Advanced Academic Courses

AP or IB AP Statistics

Students should be advised to consider these course opportunities to enrich their preparation. AP or IB courses not listed under the Secondary Courses for High School Credit section of this framework document do not count towards concentrator/completer status for this program of study.

Work-Based Learning and Expanded Learning Opportunities

- | | |
|--|---|
| Work-Based Learning Activities | <ul style="list-style-type: none"> • Intern at a marketing and advertising company • Job shadow a pharmaceutical sales representative • Intern at a local retail company |
| Expanded Learning Opportunities | <ul style="list-style-type: none"> • Job shadow an account representative at a marketing firm • Participate in BPA, DECA, FBLA, or related UIL events |

Aligned Industry-Based Certifications

- Customer Service and Sales: Certified Specialist
- Facebook Digital Marketing Associate Certification
- Real Estate Sales Agent License

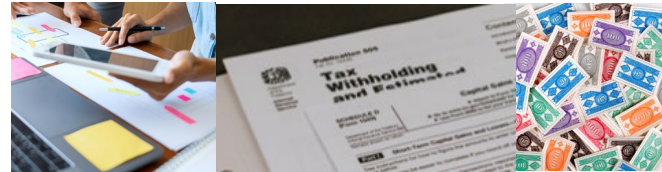

Example Postsecondary Opportunities

Associate Degrees

- Marketing/Marketing Management
- Retail Management

Bachelor's Degrees

- Business Administration
- Marketing/Marketing Management
- Fashion Merchandising

Master's, Doctoral, and Professional Degrees

- Business Administration
- Applied Economics
- Business Analytics

Additional Stackable IBCs/License

- Salesforce
- Service Contract Providers



Example Aligned Occupations

Retail Salespersons

Median Wage: \$28,356
Annual Openings: 56,132
10-Year Growth: 15%

Market Research Analysts

Median Wage: \$60,926
Annual Openings: 5,688
10-Year Growth: 35%

Sales Managers

Median Wage: \$123,729
Annual Openings: 3,368
10-Year Growth: 21%

Data Source: TexasWages, Texas Workforce Commission. Retrieved 3/8/2024.



For more information visit:
<https://tea.texas.gov/academics/college-career-and-military-prep/career-and-technical-education/programs-of-study-additional-resources>

Business, Marketing, and Finance Career Cluster

The Business, Marketing, and Finance career cluster focuses on careers in planning, organizing, directing, and evaluating business functions essential to efficient and productive business operations. This career cluster includes occupations ranging from business owner and entrepreneur to accountant, retail manager, and market analyst.

Statewide Program of Study: Real Estate

The Real Estate program of study focuses on occupational and educational opportunities associated with financing, selling, and contracting real estate. This program of study includes management, economics, marketing, and financial principles of real estate evaluation. It also addresses commercial real estate including lending, developing, brokering, and financing.

Secondary Courses for High School Credit

- Level 1**
 - Principles of Business, Marketing, and Finance (1 credit) [offered at JH]
 - Professional Communications (½ credit) [offered at JH]

- Level 2**
 - Entrepreneurship I (1 credit)

- Level 3**
 - Fundamentals of Real Estate (2 credits)

- Level 4**
 - Practicum in Business Management (2 credits)
 - Career Preparation for Programs of Study (2 credits)
 - Career Preparation for Programs of Study + Extended Career Preparation (3 credits)

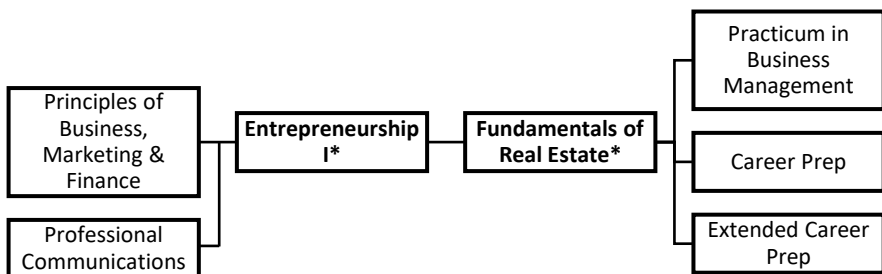

*course where Industry Based Certification can be earned

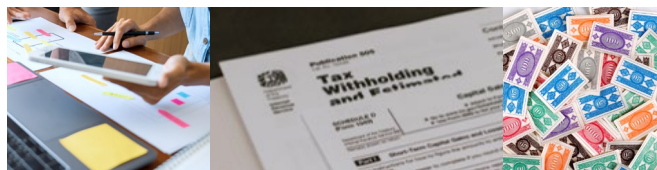

Example Postsecondary Opportunities

Associate Degrees

- Business Administration and Management
- Real Estate



Bachelor's Degrees

- Business Administration and Management
- Real Estate

Master's, Doctoral, and Professional Degrees

- Business Administration and Management
- Parks, Recreation, and Leisure Facilities Management

Additional Stackable IBCs/License

- Real Estate Broker

Work-Based Learning and Expanded Learning Opportunities

| | |
|--|--|
| Work-Based Learning Activities | <ul style="list-style-type: none"> • Intern with a local real estate company or commercial realtor • Job shadow a property manager or local realtor • Conduct informational interviews with employees at a real estate investment company |
| Expanded Learning Opportunities | <ul style="list-style-type: none"> • Participate in BPA, DECA, FBLA, or UIL-related events • Explore student membership in related professional organizations |

Aligned Industry-Based Certifications

- Customer Service and Sales: Certified Specialist
- Real Estate Sales Agent License



Example Aligned Occupations

Real Estate Sales Agents

Median Wage: \$50,746
Annual Openings: 5,058
10-Year Growth: 15%

Property, Real Estate, and Community Association Managers

Median Wage: \$59,788
Annual Openings: 3,457
10-Year Growth: 15%

Title Examiners, Abstractors, and Searchers

Median Wage: \$58,593
Annual Openings: 819
10-Year Growth: 12%

Real Estate



BUSINESS, MARKETING AND FINANCE

Principles of Business, Marketing and Finance

(CTPRMK)

9th – 11th

1 credit

Prerequisite: *None*

Course Description: In Principles of Business, Marketing, and Finance, students gain knowledge and skills in economies and private enterprise systems, the impact of global business, the marketing of goods and services, advertising, and product pricing. Students analyze the sales process and financial management principles. This course allows students to reinforce, apply, and transfer academic knowledge and skills to a variety of interesting and relevant activities, problems, and settings in business, marketing, and finance.

Professional Communications

(CTATPC)

9th – 12th

½ credit

Prerequisite: *None*

Course Description: Professional Communications blends written, oral, and graphic communication in a career-based environment. Careers in the global economy require individuals to be creative and have a strong background in computer and technology applications, a strong and solid academic foundation, and a proficiency in professional oral and written communications. Within this context, students will be expected to develop and expand the ability to write, read, edit, speak, listen, apply software applications, manipulate computer graphics, and conduct Internet research.

Digital Media

(CTDIME)

9th – 12th

1 credit

Prerequisite: *None*

Course Description: In Digital Media, students will analyze and assess current and emerging technologies, while designing and creating multimedia projects that address customer needs and resolve a problem. Students will implement personal and interpersonal skills to prepare for a rapidly evolving workplace environment. The knowledge and skills acquired and practiced will enable students to successfully perform and interact in a technology-driven society. Students will enhance reading, writing, computing, communication, and critical thinking and apply them to the IT environment.

Virtual Business

(CTVB)

10th – 12th

½ credit

Prerequisite: *Recommended* Touch Systems Data Entry

Course Description: Virtual Business is designed for students to start a virtual business by creating a web presence, conducting online and off-line marketing, examining contracts appropriate for an online business, and demonstrating project-management skills. Students will also demonstrate book-keeping skills for a virtual business, maintain business records, and understand legal issues associated with a virtual business.

Sports and Entertainment Marketing

(CTSPET)

9th – 12th

½ credit

Prerequisite: *Recommended* Principles of Business, Marketing and Finance

Course Description: Sports and Entertainment Marketing will provide students with a thorough understanding of the marketing concepts and theories that apply to sports and entertainment. The areas this course will cover include basic marketing concepts, publicity, sponsorship, endorsements, licensing, branding, event marketing, promotions, and sports and entertainment marketing strategies.

Business Information Management I

(CTBM1)

9th – 12th

1 credit

Prerequisite: *Recommended* Touch Systems Data Entry

Course Description: In Business Information Management I, students implement personal and interpersonal skills to strengthen individual performance in the workplace and in society and make a successful transition to the workforce and postsecondary education. Students apply technical skills to address business applications of emerging technologies, create word-processing documents, develop a spreadsheet, formulate a database, and make an electronic presentation using appropriate software.

Entrepreneurship I

(CTENT)

10th – 12th

1 credit

Prerequisite: *Recommended* Principles of Business, Marketing, and Finance

Course Description: In Entrepreneurship I, students will gain the knowledge and skills needed to become an entrepreneur. Students will learn the principles necessary to begin and operate a business. The primary focus of the course is to help students understand the process of analyzing a business opportunity, preparing a business plan, determining feasibility of an idea using research, and developing a plan to organize and promote the business and its products and services. In addition, students will understand the capital required, the return on investment desired, and the potential for profit.

Money Matters (CTMON)

9th– 12th 1 credit

Prerequisite: *Recommended* Principles of Business, Marketing, and Finance.

Course Description: In Money Matters, students will investigate money management from a personal financial perspective. Students will apply critical-thinking skills to analyze financial options based on current and projected economic factors. Students will gain knowledge and skills necessary to establish short-term and long-term financial goals. Students will examine various methods of achieving short-term and long-term financial goals through various methods such as investing, tax planning, asset allocating, risk management, retirement planning, and estate planning.

Retail Management (CTREMG)

10th– 12th 1 credit

Prerequisite: *Recommended* Principles of Business, Marketing, and Finance

Course Description: Retail Management is designed as a comprehensive introduction to the principles and practices of retail management. The course explores the process of promoting greater sales and customer satisfaction by gaining a better understanding of the consumers of the goods and services provided by a company. The course provides an overview of the strategies involved in the retail process, such as distributing finished products created by the business to consumers and determining what buyers want and require from the retail market.

Accounting I (CTACT1)

10th– 12th 1 credit

Prerequisite: *Recommended* Principles of Business, Marketing, and Finance

Course Description: In Accounting I, students will investigate the field of accounting, including how it is impacted by industry standards as well as economic, financial, technological, international, social, legal, and ethical factors. Students will reflect on this knowledge as they engage in the process of recording, classifying, summarizing, analyzing, and communicating accounting information. Students will formulate and interpret financial information for use in management decision making.

Accounting II (CTACT2)

11th– 12th 1 credit 4.0

Prerequisite: *Required* Accounting I

Course Description: In Accounting II, students will continue the investigation of the field of accounting, including how it is impacted by industry standards as well as economic, financial, technological, international, social, legal, and ethical factors. Students will reflect on this knowledge as they engage in various managerial, financial, and operational accounting activities. Students will formulate, interpret, and communicate financial information for use in management decision making. Students will use equations, graphical representations, accounting tools, spreadsheet software, and accounting systems in real-world situations to maintain, monitor, control, and plan the use of financial resources. *This course satisfies the 3rd year math credit and is counted in the GPA as an academic elective.*

Fundamentals of Real Estate (CTREAL)

11th- 12th 2 credits

Prerequisite: Recommended Principles of Business, Marketing, and Finance.

Fee: TREC Application fee - \$185.00, State Exam fee - \$43.00, Fingerprint and background check - \$38.25 (paid direct to vendor)

Course Description: In Fundamentals of Real Estate, students gain knowledge and skills in general principles of real estate, the law of agency, the law of contracts, use of promulgated forms and real estate finance. Students analyze the elements of a real estate transaction, including representation, financing, title, closing and deeds. This course allows students to reinforce, apply, and transfer academic knowledge and skills to a variety of interesting and relevant principles of real estate. This course contains the curriculum necessary to complete the pre-licensure education requirements of the Texas Real Estate Commission (TREC) to obtain a real estate salesperson license..

Requirements and Completion

Texas Real Estate Licensing consists of six individual courses within the program. The following courses and hours are as followed:

180 classroom hours of the following qualifying real estate courses

- Course # 121 - Principles of Real Estate I (30 hours)
- Course # 122 - Principles of Real Estate II (30 hours)
- Course # 1151 - Law of Agency (30 hours)
- Course # 1251 - Law of Contracts (30 hours)
- Course # 351 - Promulgated Contract Forms (30 hours)
- Course # 451 - Real Estate Finance (30 hours)

Career Preparation General 3 credits 15+ hours/week (CTCC1X)(CTCC2X)

11th – 12th 2 credits 10-14 hours/week (CTCC1)(CTCC2)

Course Requirement: Employment must be secured within 15 days of enrollment in course and maintained throughout remainder of the course; Valid social security number

Prerequisite: at least one credit in a CTE course

Course Description: Career Preparation General provides opportunities for students to participate in a work-based learning environment that incorporates continuous collaborative feedback between the employer, teacher, and student. This course combines classroom instruction with business and industry employment experiences that may be outside the student's current program of study. The goal is for students to obtain entry-level employment developing a variety of skills for obtaining and maintaining employment. Career preparation is relevant and rigorous, supports student attainment of academic standards, and effectively prepares students for college and career success. Employment locations must be available for instructor visitation once per nine weeks and no more than 30 minutes drive time from the school campus.

Career Preparation for Programs of Study + (Extended Career Prep) 3 credits 15+ hours/week (CTPS1X)(CTPS2X)
12th 2 credit 10-14 hours/week (CTPS1)(CTPS2)

Course Requirement: Employment must be secured within 15 days of enrollment in course and maintained throughout remainder of the course; Valid social security number

Prerequisite: at least one Level 2 or higher CTE course

Course Description: Career Preparation for Programs of Study provides additional opportunities for students to develop business and industry employment experiences, which must be related to the student's current program of study alongside advanced classroom instruction. The goal is to prepare students with a variety of skills to transition from job- to career-mindedness. This course provides a continuing focus on collaborative feedback between the employer, teacher, and student. Career Preparation for Programs of Study expands on Career Preparation General by increasing rigor, supporting student attainment of academic standards, and effectively preparing students for college and career success. Employment locations must be available for instructor visitation once per nine weeks and no more than 30 minutes drive time from the school campus. (pending board approval)

Practicum in Business Management

(CTPRBM)

11th -12th

2 credits

Prerequisite: *Recommended* Touch System Data Entry and Business Management or Business Information Management II

Course Description: Practicum in Business Management is designed to give students supervised practical application of previously studied knowledge and skills. Practicum experiences occur in a paid or unpaid arrangement and a variety of locations appropriate to the nature and level of experience. Students implement personal and interpersonal skills to strengthen individual performance in the workplace and in society and to make a successful transition to the workforce or postsecondary education. Students apply technical skills to address business applications of emerging technologies.



Education and Training Career Cluster

The Education and Training career cluster focuses on planning, managing, and providing education and training services and related learning support services. This career cluster includes occupations ranging from teaching assistant and classroom teacher to school administrator.

Statewide Program of Study: Early Learning

The Early Learning program of study focuses on occupational and educational opportunities associated with instructing and supporting preschool and early elementary school students. This program of study addresses social, physical, and intellectual growth and skills necessary for planning, directing, and coordinating activities for young children.

Secondary Courses for High School Credit



- Level 1**
 - Principles of Education and Training (1 credit)
 - Principles of Human Services (1 credit)

- Level 2**
 - Child Development (1 credit)

- Level 3**
 - Child Guidance (2 credits)

- Level 4**
 - Career Preparation for Programs of Study (2 credits)
 - Career Preparation for Programs of Study + Extended Career Preparation (3 credits)

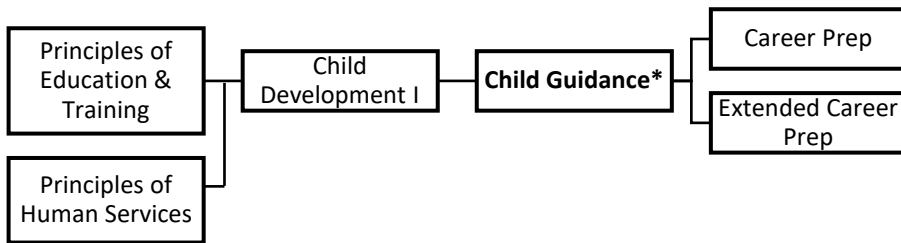

*course where Industry Based Certification can be earned



Example Postsecondary Opportunities

Apprenticeships

- Child Care Development Specialist

Associate Degrees

- Teacher Education, Multiple Levels
- Child Care Provider/Assistant

Bachelor's Degrees

- Elementary Education and Teaching
- Early Childhood and Family Studies

Master's, Doctoral, and Professional Degrees

- Educational Leadership and Administration, General
- Education, General

Additional Stackable IBCs/License

- Certified Child Care Professional



Work-Based Learning and Expanded Learning Opportunities

| | |
|--|--|
| Work-Based Learning Activities | <ul style="list-style-type: none"> • Serve as a summer camp counselor for pre-school or kindergarten students • Serve as a teaching assistant at a lab school or daycare |
| Expanded Learning Opportunities | <ul style="list-style-type: none"> • Participate in FCCLA • Participate in TAFE |

Aligned Industry-Based Certifications

- Educational Aide I



Example Aligned Occupations

Child Care Workers

Median Wage: \$23,528
Annual Openings: 12,823
10-Year Growth: 17%

Preschool Teachers, Except Special Education

Median Wage: \$24,127
Annual Openings: 4,148
10-Year Growth: 26%

Elementary School Teachers, Except Special Education

Median Wage: \$61,389
Annual Openings: 11,712
10-Year Growth: 13%

Data Source: TexasWages, Texas Workforce Commission. Retrieved 3/8/2024.



For more information visit:
<https://tea.texas.gov/academics/college-career-and-military-prep/career-and-technical-education/programs-of-study-additional-resources>

Education and Training Career Cluster

The Education and Training career cluster focuses on planning, managing, and providing education and training services and related learning support services. All parts of courses are designed to introduce learners to the various careers available within the Education and Training career cluster. This career cluster includes a diverse spectrum of occupations, ranging from teaching assistant, classroom teacher, to school administrator.

Statewide Program of Study: Teaching and Training

The Teaching and Training program of study focuses on occupational and educational opportunities associated with careers related to teaching, instructing, and creating instructional and enrichment materials. The program of study includes recognizing a variety of student groups and their corresponding needs, identifying processes for developing curriculum and coordinating educational content, and coaching groups and individuals.



Secondary Courses for High School Credit

- Level 1**
 - Principles of Education and Training (1 credit)
 - Principles of Human Services (1 credit)

- Level 2**
 - Child Development (1 credit)

- Level 3**
 - Instructional Practices (2 credits)

- Level 4**
 - Practicum in Education and Training (2 credits)
 - Career Preparation for Programs of Study (2 credits)
 - Career Preparation for Programs of Study + Extended Career Preparation (3 credits)

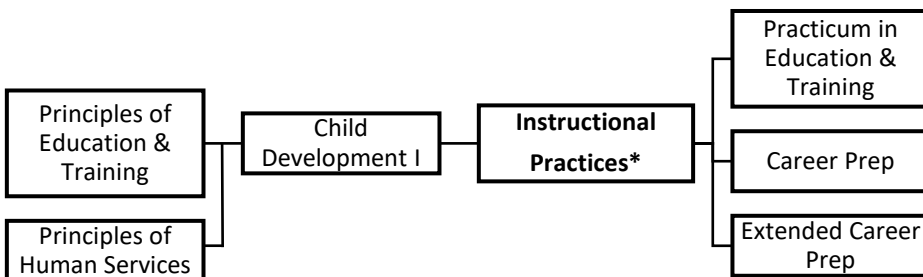

*course where Industry Based Certification can be earned

Work-Based Learning and Expanded Learning Opportunities

| | |
|--|---|
| Work-Based Learning Activities | <ul style="list-style-type: none"> • Serve as a camp counselor to learn mentoring, facilitation, and lesson planning skills • Volunteer in a tutoring center to learn lesson planning and skills assessment |
| Expanded Learning Opportunities | <ul style="list-style-type: none"> • Participate in FCCLA • Participate in TAFE |

Aligned Industry-Based Certifications

- Educational Aide I



Example Postsecondary Opportunities

Apprenticeships

- Teacher Apprentice

Associate Degrees

- Adult and Continuing Education and Teaching
- Educational/Instructional Technology

Bachelor's Degrees

- Elementary Education and Teaching
- Secondary Education and Teaching

Master's, Doctoral, and Professional Degrees

- Educational Leadership and Administration, General
- Curriculum and Instruction

Additional Stackable IBCs/License

- Generalist, Grades EC-4



Example Aligned Occupations

Teaching Assistants, Except Postsecondary

Median Wage: \$28,066
Annual Openings: 10,000
10-Year Growth: 15%

Secondary School Teachers, Except Special Education and CTE

Median Wage: \$61,035
Annual Openings: 8,288
10-Year Growth: 14%

Education Administrators, Kindergarten through Secondary

Median Wage: \$81,976
Annual Openings: 2,676
10-Year Growth: 14%

Data Source: TexasWages, Texas Workforce Commission. Retrieved 3/8/2024.



For more information visit:
<https://tea.texas.gov/academics/college-career-and-military-prep/career-and-technical-education/programs-of-study-additional-resources>

EDUCATION & TRAINING

Principles of Education and Training (CTPEDT)
9th – 10th 1 credit

Prerequisite: *None*

Course Description: Principles of Education and Training is designed to introduce learners to the various careers available within the Education and Training Program of Study. Students use self-knowledge as well as educational and career information to analyze various careers within the Education and Training Program of Study. Students will develop a graduation plan that leads to a specific career choice in the student's interest area.

Principles of Human Services (CTHSPP)
9th – 12th 1 credit

Prerequisite: *None*

Course Description: Principles of Human Services is a laboratory course that will enable students to investigate careers in the Human Services Program of Study, including counseling and mental health, early childhood development, family and community, personal care, and consumer services. Each student is expected to complete the knowledge and skills essential for success in high-skill, high-wage, or high-demand human services careers.

Child Development (CTCHDV)
10th – 12th 1 credit

Prerequisite: *Recommended* Principles of Human Services or Principles of Education and Training

Course Description: Child Development is a technical laboratory course that addresses knowledge and skills related to child growth and development from prenatal through school-age children, equipping students with child development skills. Students use these skills to promote the well-being and healthy development of children and investigate careers related to the care and education of children.

Child Guidance (CTCGE1)
11th-12th 2 credits

Prerequisite: *Required* Child Development

Course Description: Child Guidance is a course that addresses the knowledge and skills related to child growth and guidance, equipping students to develop positive relationships with children and effective caregiver skills. Students use these skills to promote the well-being and healthy development of children, strengthen a culturally diverse society, and pursue careers related to the care, guidance, and education of children, including those with special needs. Instruction may be delivered through school-based laboratory training or through work-based delivery arrangements such as cooperative education, mentoring, and job shadowing.

Instructional Practices (CTEDTR)
11th- 12th 2 credits

Prerequisite: *Required* At least one credit in a course from the Education and Training Career Cluster. *Recommended* Principles of Education and Training, Human Growth and Development, or Child Development.

Course Description: Instructional Practices is a field-based (practicum) internship that provides students with background knowledge of child and adolescent development as well as principles of effective teaching and training practices. Students work under the joint direction and supervision of both a teacher with knowledge of early childhood, middle childhood, and adolescence education and exemplary educators or trainers in direct instructional roles with elementary-, middle school-, and high school-aged students. Students learn to plan and direct individualized instruction and group activities, prepare instructional materials, develop materials for educational environments, assist with record keeping, and complete other responsibilities of teachers, trainers, paraprofessionals, or other educational personnel.

Practicum in Education and Training (CTPRED)
12th 2 credits

Prerequisite: *Required* Instructional Practices; *Recommended* Principles of Education and Training, Human Growth and Development, or Child Development.

Course Description: Practicum in Education and Training is a field-based internship that provides students background knowledge of child and adolescent development principles as well as principles of effective teaching and training practices. Students in the course work under the joint direction and supervision of both a teacher with knowledge of early childhood, middle childhood, and adolescence education and exemplary educators in direct instructional roles with elementary-, middle school-, and high school-aged students. Students learn to plan and direct individualized instruction and group activities, prepare instructional materials, assist with record keeping, make physical arrangements, and complete other responsibilities of classroom teachers, trainers, paraprofessionals, or other educational personnel.

Career Preparation for Programs of Study + (Extended Career Prep) 3 credits 15+ hours/week (CTPS1X)(CTPS2X)
12th 2 credits 10-14 hours/week (CTPS1)(CTPS2)

Course Requirement: Employment must be secured within 15 days of enrollment in course and maintained throughout remainder of the course; Valid social security number

Prerequisite: at least one Level 2 or higher CTE course

Course Description: Career Preparation for Programs of Study provides additional opportunities for students to develop business and industry employment experiences, which must be related to the student's current program of study alongside advanced classroom instruction. The goal is to prepare students with a variety of skills to transition from job- to career-mindedness. This course provides a continuing focus on collaborative feedback between the employer, teacher, and student. Career Preparation for Programs of Study expands on Career Preparation General by increasing rigor, supporting student attainment of academic standards, and effectively preparing students for college and career success. Employment locations must be available for instructor visitation once per nine weeks and no more than 30 minutes drive time from the school campus.

Engineering Career Cluster

The Engineering career cluster focuses on planning, designing, testing, building, and maintaining of machines, structures, materials, systems, and processes using empirical evidence and science, technology, and math principles. This career cluster includes occupations ranging from mechanical engineer and drafter to electrical engineer and to mapping technician.

Regional Program of Study: Drone (Unmanned Vehicle)

The Drone (Unmanned Vehicle) regional program of study focuses on the occupational and educational opportunities associated with operating or designing an unmanned aircraft using a ground-based controller. This program of study includes understanding and designing systems of communications between the controller and the aircraft to ensure compliance with federal aviation safety regulations.

Secondary Courses for High School Credit

Level 1

- Level 2**
- Introduction to Unmanned Aerial Vehicles (UAV) (1 credit)
 - Robotics I (1 credit)

- Level 3**
- Robotics II (2 credits)

- Level 4**
- Practicum in Manufacturing (2 credits)
 - Career Preparation for Programs of Study (2 credits)
 - Career Preparation for Programs of Study + Extended Career Preparation (3 credits)

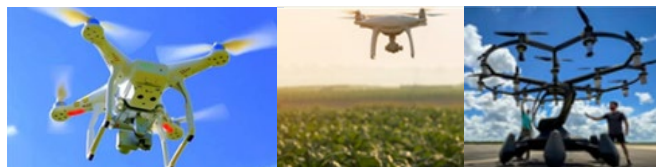

Example Postsecondary Opportunities

Associate Degrees

- Airline/Commercial/Professional Pilot and Flight Crew
- Manufacturing Engineering Technology/Technician

Bachelor's Degrees

- Aviation Science
- Aeronautical/Aerospace Engineering Technology

Master's, Doctoral, and Professional Degrees

- Aerospace, Aeronautical, and Astronautical/Space Engineering, General

Additional Stackable IBCs/License

- Aerial Mapping and 3D Modeling Certification

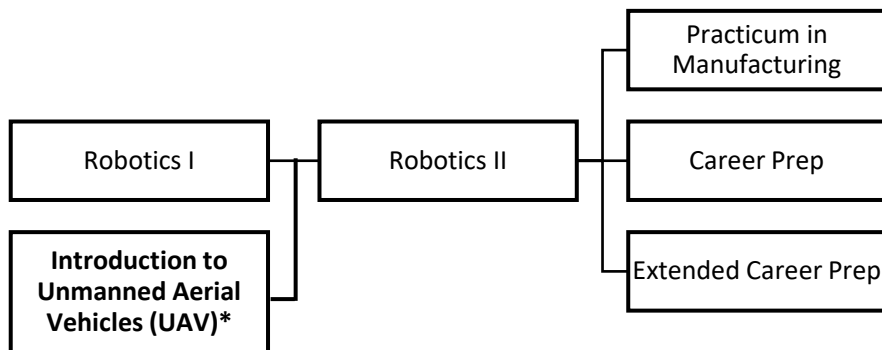

*course where Industry Based Certification can be earned

Work-Based Learning and Expanded Learning Opportunities

Work-Based Learning Activities

- Intern with a public service, engineering, construction, or transportation firm
- Practice drone operations with an industry professional at a work site

Expanded Learning Opportunities

- Participate in an aerial drone competition
- Participate in SkillsUSA or TSA

Aligned Industry-Based Certifications

- FAA Part 107 Remote Drone Pilot



Example Aligned Occupations

Aerospace Engineering and Operations Technicians

Median Wage: \$48,204
Annual Openings: 192
10-Year Growth: 21%

Avionics Technicians

Median Wage: \$72,461
Annual Openings: 255
10-Year Growth: 16%

Drone (Unmanned Vehicle)

Data Source: TexasWages, Texas Workforce Commission. Retrieved 3/8/2024.



For more information visit:

<https://tea.texas.gov/academics/college-career-and-military-prep/career-and-technical-education/programs-of-study-additional-resources>

ENGINEERING

Introduction to Unmanned Aerial Vehicle (UAV) Flight

(CTUMF)

10th – 12th

1 credit

Prerequisite: *None*

Course Description: The Introduction to Unmanned Aerial Vehicle (UAV) Flight course is designed to prepare students for entry-level employment or continuing education in piloting UAV operations. Principles of UAV is designed to instruct students in UAV flight navigation, industry laws and regulations, and safety regulations. Students are also exposed to mission planning procedures, environmental factors, and human factors involved in the UAV industry.

Robotics I

(CTROB1)

9th-10th

1 credit

Prerequisite: *Recommended* Principles of Applied Engineering

Course Description: In Robotics I, students will transfer academic skills to component designs in a project-based environment through implementation of the design process. Students will build prototypes or use simulation software to test their designs. Additionally, students will explore career opportunities, employer expectations, and educational needs in the robotic and automation industry.

Robotics II

(CTROB2)

10th – 12th

1 credit

Prerequisite: *Required* Robotics I

Course Description: In Robotics II, students will explore artificial intelligence and programming in the robotic and automation industry. Through implementation of the design process, students will transfer academic skills to component designs in a project-based environment. Students will build prototypes and use software to test their designs. *This course satisfies a 3rd or 4th year high school mathematics graduation requirement and will be counted in the GPA as an academic elective.*

Practicum in Manufacturing- Robotics

(CTROPR)

12th

2 credits

Prerequisite: *None*

Course Description: The Practicum in Manufacturing course is designed to give students supervised practical application of previously studied knowledge and skills. Practicum experiences can occur in a variety of locations appropriate to the nature and level of experience.

Career Preparation for Programs of Study + (Extended Career Prep) 3 credits

15+ hours/week (CTPS1X)(CTPS2X)

12th

2 credits 10-14 hours/week (CTPS1)(CTPS2)

Course Requirement: Employment must be secured within 15 days of enrollment in course and maintained throughout remainder of the course; Valid social security number

Prerequisite: at least one Level 2 or higher CTE course

Course Description: Career Preparation for Programs of Study provides additional opportunities for students to develop business and industry employment experiences, which must be related to the student's current program of study alongside advanced classroom instruction. The goal is to prepare students with a variety of skills to transition from job- to career-mindedness. This course provides a continuing focus on collaborative feedback between the employer, teacher, and student. Career Preparation for Programs of Study expands on Career Preparation General by increasing rigor, supporting student attainment of academic standards, and effectively preparing students for college and career success. Employment locations must be available for instructor visitation once per nine weeks and no more than 30 minutes drive time from the school campus. (pending board approval)

Health Science Career Cluster

The Health Science career cluster focuses on planning, managing, and providing therapeutic services, diagnostics services, health informatics, support services, and biotechnology research and development. This career cluster includes occupations ranging from medical assistant, registered nurse, and physical therapist to forensic science technician and athletic trainer.

Statewide Program of Study: *Diagnostic and Therapeutic Services - CNA*

The Diagnostic and Therapeutic Services program of study focuses on occupational and educational opportunities associated with diagnosing and treating acute, episodic, or chronic illness independently or as part of a healthcare team. This program of study includes exploration of patient treatment and rehabilitative programs that help build or restore daily living skills to persons with disabilities or developmental delays.

Secondary Courses for High School Credit

- Level 1**
 - Principles of Health Science (1 credit)

- Level 2**
 - Medical Terminology (1 credit)
 - Pharmacy I (1 credit)

- Level 3**
 - Anatomy and Physiology (1 credit)
 - Emergency Medical Technician – Basic (2 credits)
 - Health Science Theory (1 credit)
 - Health Science Theory + Health Science Clinical (2 credits)

- Level 4**
 - Pathophysiology (1 credit)
 - Practicum in Health Science – CNA (2 credits)
 - Career Preparation for Programs of Study (2 credits)
 - Career Preparation for Programs of Study + Extended Career Preparation (3 credits)

Certified Nurse Aide (CNA) Pathway

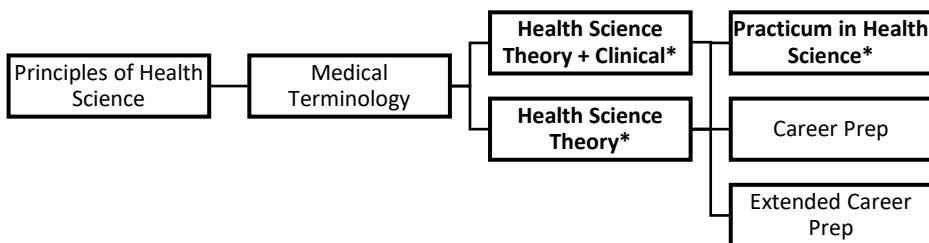

*course where Industry Based Certification can be earned

Aligned Advanced Academic Courses

| | | |
|--------------------|-----------------------|--------------|
| AP | AP Biology | AP Chemistry |
| Dual Credit | BIOL 1406 & BIOL 1407 | |

Students should be advised to consider these course opportunities to enrich their preparation. AP or IB courses not listed under the Secondary Courses for High School Credit section of this framework document do not count towards concentrator/completer status for this program of study.

Work-Based Learning and Expanded Learning Opportunities

| | |
|--|---|
| Work-Based Learning Activities | <ul style="list-style-type: none"> Intern with a medical assistant at a community clinic, hospital, assisted living, or long-term care facility Participate in job shadowing experiences such as Emergency Medical Services (EMS) ride along or hospital/clinical job |
| Expanded Learning Opportunities | <ul style="list-style-type: none"> Participate in Health Occupation Students of America (HOSA) or SkillsUSA Participate in Advanced Medical Ambulance Bus (AMBUS) event or Community Emergency Response Team (CERT) event |

Aligned Industry-Based Certifications

- Certified EKG Technician
- Certified Nurse Aide (CNA)

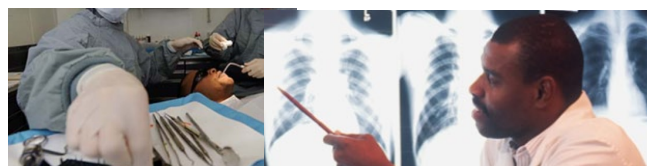

Example Postsecondary Opportunities

Apprenticeships

- Medical Assistant

Associate Degrees

- Emergency Medical Technology
- Radiologic Technology/Science

Bachelor's Degrees

- Emergency Medical Technology
- Medical Insurance Coding

Master's, Doctoral, and Professional Degrees

- Medicine
- Occupational Therapy

Additional Stackable IBCs/License

- Registered Diagnostic Medical Sonographer



Example Aligned Occupations

Medical Assistants

Median Wage: \$36,834
Annual Openings: 11,638
10-Year Growth: 29%

Dental Hygienists

Median Wage: \$79,663
Annual Openings: 1,352
10-Year Growth: 32%

Physician Assistants

Median Wage: \$127,332
Annual Openings: 974
10-Year Growth: 41%

Data Source: TexasWages, Texas Workforce Commission. Retrieved 3/8/2024.



For more information visit:
<https://tea.texas.gov/academics/college-career-and-military-prep/career-and-technical-education/programs-of-study-additional-resources>

Health Science Career Cluster



The Health Science career cluster focuses on planning, managing, and providing therapeutic services, diagnostics services, health informatics, support services, and biotechnology research and development. This career cluster includes occupations ranging from medical assistant, registered nurse, and physical therapist to forensic science technician and athletic trainer.

Statewide Program of Study: *Diagnostic and Therapeutic Services - EMT*

The Diagnostic and Therapeutic Services program of study focuses on occupational and educational opportunities associated with diagnosing and treating acute, episodic, or chronic illness independently or as part of a healthcare team. This program of study includes exploration of patient treatment and rehabilitative programs that help build or restore daily living skills to persons with disabilities or developmental delays.

Secondary Courses for High School Credit

- Level 1**
 - Principles of Health Science (1 credit)

- Level 2**
 - Medical Terminology (1 credit)
 - Pharmacy I (1 credit)

- Level 3**
 - Anatomy and Physiology (1 credit)
 - Emergency Medical Technician – Basic (2 credits)
 - Health Science Theory (1 credit)
 - Health Science Theory + Health Science Clinical (2 credits)

- Level 4**
 - Pathophysiology (1 credit)
 - Practicum in Health Science – CNA (2 credits)
 - Career Preparation for Programs of Study (2 credits)
 - Career Preparation for Programs of Study + Extended Career Preparation (3 credits)

Emergency Medical Technician (EMT) Pathway

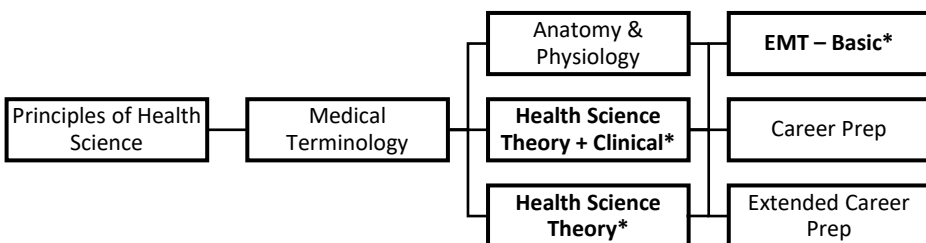

*course where Industry Based Certification can be earned

Aligned Advanced Academic Courses

| | | |
|--------------------|-----------------------|--------------|
| AP | AP Biology | AP Chemistry |
| Dual Credit | BIOL 1406 & BIOL 1407 | |

Students should be advised to consider these course opportunities to enrich their preparation. AP or IB courses not listed under the Secondary Courses for High School Credit section of this framework document do not count towards concentrator/completer status for this program of study.

Work-Based Learning and Expanded Learning Opportunities

| | |
|--|---|
| Work-Based Learning Activities | <ul style="list-style-type: none"> • Intern with a medical assistant at a community clinic, hospital, assisted living, or long-term care facility • Participate in job shadowing experiences such as Emergency Medical Services (EMS) ride along or hospital/clinical job |
| Expanded Learning Opportunities | <ul style="list-style-type: none"> • Participate in Health Occupation Students of America (HOSA) or SkillsUSA • Participate in Advanced Medical Ambulance Bus (AMBUS) event or Community Emergency Response Team (CERT) event |

Aligned Industry-Based Certifications

- Certified EKG Technician
- Emergency Medical Technician–Basic

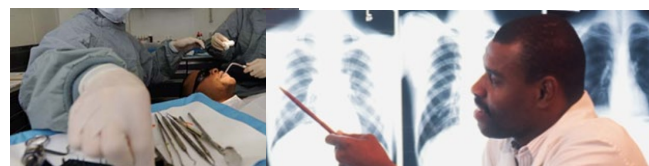

Example Postsecondary Opportunities

Apprenticeships

- Medical Assistant

Associate Degrees

- Emergency Medical Technology
- Radiologic Technology/Science

Bachelor's Degrees

- Emergency Medical Technology
- Medical Insurance Coding

Master's, Doctoral, and Professional Degrees

- Medicine
- Occupational Therapy

Additional Stackable IBCs/License

- Registered Diagnostic Medical Sonographer



Example Aligned Occupations

Medical Assistants

Median Wage: \$36,834
Annual Openings: 11,638
10-Year Growth: 29%

Dental Hygienists

Median Wage: \$79,663
Annual Openings: 1,352
10-Year Growth: 32%

Physician Assistants

Median Wage: \$127,332
Annual Openings: 974
10-Year Growth: 41%

Data Source: TexasWages, Texas Workforce Commission. Retrieved 3/8/2024.



For more information visit:
<https://tea.texas.gov/academics/college-career-and-military-prep/career-and-technical-education/programs-of-study-additional-resources>

Health Science Career Cluster



The Health Science career cluster focuses on planning, managing, and providing therapeutic services, diagnostics services, health informatics, support services, and biotechnology research and development. This career cluster includes occupations ranging from medical assistant, registered nurse, and physical therapist to forensic science technician and athletic trainer.

Statewide Program of Study: *Diagnostic and Therapeutic Services – Pharmacy Tech.*

The Diagnostic and Therapeutic Services program of study focuses on occupational and educational opportunities associated with diagnosing and treating acute, episodic, or chronic illness independently or as part of a healthcare team. This program of study includes exploration of patient treatment and rehabilitative programs that help build or restore daily living skills to persons with disabilities or developmental delays.

Secondary Courses for High School Credit

- Level 1**
 - Principles of Health Science (1 credit)

- Level 2**
 - Medical Terminology (1 credit)
 - Pharmacy I (1 credit)

- Level 3**
 - Anatomy and Physiology (1 credit)
 - Emergency Medical Technician – Basic (2 credits)
 - Health Science Theory (1 credit)
 - Health Science Theory + Health Science Clinical (2 credits)

- Level 4**
 - Pathophysiology (1 credit)
 - Practicum in Health Science – Pharm Tech. (2 credits)
 - Career Preparation for Programs of Study (2 credits)
 - Career Preparation for Programs of Study + Extended Career Preparation (3 credits)

Pharmacy Technician Pathway



*course where Industry Based Certification can be earned

Aligned Advanced Academic Courses

| | | |
|--------------------|-----------------------|--------------|
| AP | AP Biology | AP Chemistry |
| Dual Credit | BIOL 1406 & BIOL 1407 | |

Students should be advised to consider these course opportunities to enrich their preparation. AP or IB courses not listed under the Secondary Courses for High School Credit section of this framework document do not count towards concentrator/completer status for this program of study.

Work-Based Learning and Expanded Learning Opportunities

| | |
|--|---|
| Work-Based Learning Activities | <ul style="list-style-type: none"> • Intern with a medical assistant at a community clinic, hospital, assisted living, or long-term care facility • Participate in job shadowing experiences such as Emergency Medical Services (EMS) ride along or hospital/clinical job |
| Expanded Learning Opportunities | <ul style="list-style-type: none"> • Participate in Health Occupation Students of America (HOSA) or SkillsUSA • Participate in Advanced Medical Ambulance Bus (AMBUS) event or Community Emergency Response Team (CERT) event |

Aligned Industry-Based Certifications

- Pharmacy Technician

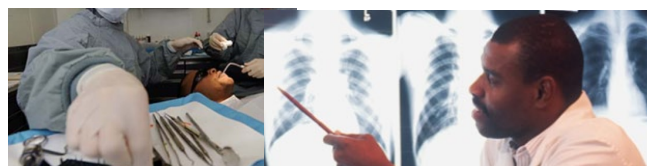

Example Postsecondary Opportunities

Apprenticeships

- Medical Assistant

Associate Degrees

- Emergency Medical Technology
- Radiologic Technology/Science

Bachelor's Degrees

- Emergency Medical Technology
- Medical Insurance Coding

Master's, Doctoral, and Professional Degrees

- Medicine
- Occupational Therapy

Additional Stackable IBCs/License

- Registered Diagnostic Medical Sonographer



Example Aligned Occupations

Medical Assistants

Median Wage: \$36,834
Annual Openings: 11,638
10-Year Growth: 29%

Dental Hygienists

Median Wage: \$79,663
Annual Openings: 1,352
10-Year Growth: 32%

Physician Assistants

Median Wage: \$127,332
Annual Openings: 974
10-Year Growth: 41%

Data Source: TexasWages, Texas Workforce Commission. Retrieved 3/8/2024.



For more information visit:
<https://tea.texas.gov/academics/college-career-and-military-prep/career-and-technical-education/programs-of-study-additional-resources>

HEALTH SCIENCE

Principles of Health Science (CTPPHS)
9th – 10th 1 credit

Prerequisite: *None*

Course Description: The Principles of Health Science course is designed to provide an overview of the therapeutic, diagnostic, health informatics, support services, and biotechnology research and development systems of the healthcare industry.

Medical Terminology (CTMDTM)
9th-12th 1 credit

Prerequisite: *None*

Course Description: The Medical Terminology course is designed to introduce students to the structure of medical terms, including prefixes, suffixes, word roots, singular and plural forms, and medical abbreviations. The course allows students to achieve comprehension of medical vocabulary appropriate to medical procedures, human anatomy and physiology, and pathophysiology.

Pharmacy I (CTPH1)
10th-12th 1 credit

Prerequisite: *None*

Course Description: The Pharmacy I course is designed for students to build on their existing foundation of knowledge and skills needed to pursue a career in the pharmaceutical field such as a pharmacy technician or pharmacist. Instruction includes pharmacokinetics, pharmacy law, medication safety, the dispensing process, and inventory. This course is aligned with the standards of the national certification exams that students might take, such as Pharmacy Technician Certification Examination (PTCE) and/or Exam for the Certification of Pharmacy Technicians (ExCPT). Recommended participants are students who wish to become certified pharmacy technicians.

Anatomy and Physiology (CTAPR)
10th-12th 1 credit 4.0

Prerequisite: *Required* Biology and one credit in Chemistry, Integrated Physics and Chemistry (IPC), or Physics; *Recommended* a course from the Health Science Career Cluster.

Course Description: The Anatomy and Physiology course is designed for students to conduct laboratory and field investigations, use scientific methods during investigations, and make informed decisions using critical thinking and scientific problem solving. Students in Anatomy and Physiology will study a variety of topics, including the structure and function of the human body and the interaction of body systems for maintaining homeostasis. *This course satisfies the 3rd or 4th year Science credit and is counted in the GPA as an academic elective.*

Pathophysiology (CTPATH)
11th-12th 1 credit 4.0

Prerequisite: *Required* Biology, Chemistry, and at least one credit in a Level 2 or high course from the health science career cluster; *Recommended* Anatomy and Physiology

Course Description: The Pathophysiology course is designed for students to conduct laboratory and field investigations, use scientific methods during investigations, and make informed decisions using critical thinking and scientific problem solving. Students in Pathophysiology will study disease processes and how humans are affected. Emphasis is placed on prevention and treatment of disease. Students will differentiate between normal and abnormal physiology. *This course satisfies the 3rd or 4th year Science credit and is counted in the GPA as an academic elective.*

Health Science Theory (CTHSTY)
10th-12th 1 credit

Prerequisite: *Required* Biology and one credit in a course from the health science career cluster; *Recommended* Medical Terminology

Course Description: The Health Science Theory course is designed to provide for the development of advanced knowledge and skills related to a wide variety of health careers. Students will employ hands-on experiences for continued knowledge and skill development. The Health Science Theory course is designed to provide for the development of advanced knowledge and skills related to a wide variety of health careers. Students will employ hands-on experiences for continued knowledge and skill development.

Health Science Theory with Clinical (CTHSTH)
10th - 12th 2 credits

Prerequisite: *Required* Biology and one credit in a course from the health science career cluster; *Recommended* Medical Terminology; Transportation to clinical site preferred

Fee: Lab fee - Approx. \$20

Course Description: The Health Science Theory course is designed to provide for the development of advanced knowledge and skills related to a wide variety of health careers. Students will employ hands-on experiences for continued knowledge and skill development.

The Health Science Clinical course is designed to provide for the development of advanced knowledge and skills related to a wide variety of health careers. Students will employ hands-on experiences for continued knowledge and skill development. Job shadowing off campus is incorporated for various clinical rotations. Health Science courses must be taken in sequence to participate in Job Shadowing. Student enrollment is limited due to medical facility guidelines. Students will be responsible for submitting vaccination records based on clinical site requirements.

Practicum in Health Science- Certified Nurse Aide (CNA) (CTHST2)
12th 2 credits

Fee: Program fee - \$35

Prerequisite: *Required* Health Science Theory and Biology; Transportation to clinical site; Valid social security number or Tax ID and Texas Driver's License; Pass a mandatory background check

Course Description: The Practicum in Health Science course is designed to give students practical application of previously studied knowledge and skills. Practicum experiences can occur in a variety of locations appropriate to the nature and level of experience. This course is an occupational specific course designed to provide knowledge and skills for certification as a Certified Nurse Aide. Students will be required to purchase liability insurance, and scrubs. Students will be responsible for signing the Certified Nurse Aide Program Rules and Regulations the first week of class.

Practicum in Health Science- Pharmacy Technician (CTPHT)
12th 2 credits

Prerequisite: *Required* Health Science Theory and Biology; Transportation to clinical site; Valid social security number; Pass a mandatory background check; Random drug screening

Fee: Lab fee - Approx. \$20

Course Description: The Practicum in Health Science course is designed to give students practical application of previously studied knowledge and skills. Practicum experiences can occur in a variety of locations appropriate to the nature and level of experience. This course is an occupational specific course designed to provide knowledge and skills for certification as a Certified Pharmacy Technician. Students will learn federal and state law pertaining to the pharmacy industry, drug classifications, medical terminology, ethical and legal issues, safety, aseptic technique, calculations, career opportunities, and pharmacy operations. Upon completion of the course, students will be eligible to test for national Certified Pharmacy Technician certification. The Pharmacy Technician certification provides the knowledge and skills needed to prepare, distribute, label and package pharmaceuticals, and to transcribe patients' medication profiles in specified records or forms. Students must be a senior to be enrolled in the course. Students must provide their own transportation to clinical rotations. *Upon completion of the program, students with proof of a high school diploma will be eligible to sit for the board exam and become certified pharmacy technicians.* Students will be responsible for signing Certified Pharmacy Technician Program Rules and Regulations the first week of class.

Emergency Medical Technician (EMT) – Basic (CTEMTB)
11th-12th 2 credits

Prerequisite: *Required* Biology; *Recommended* Principles of Law and Anatomy and Physiology

Fee: Approx. \$150.00 (paid direct to vendor)

Course Description: Emergency Medical Technician (EMT)—Basic is a preparation course for certification as an EMT—Basic. The course includes all the skills necessary to provide emergency medical care at a basic life support level with either an emergency service or other specialized service. The curriculum includes skills necessary for a student to provide entry level emergency medical care, life support, and ambulance service. Students will be responsible for signing the Program Rules and Regulations the first week of class. Students must provide transportation to the clinical site; valid social security number or Tax ID and Texas Driver's License; pass a mandatory background check, program fees.

Career Preparation for Programs of Study + (Extended Career Prep) 3 credits 15+ hours/week (CTPS1X)(CTPS2X)
12th 2 credits 10-14 hours/week (CTPS1)(CTPS2)

Course Requirement: Employment must be secured within 15 days of enrollment in course and maintained throughout remainder of the course; Valid social security number

Prerequisite: at least one Level 2 or higher CTE course

Course Description: Career Preparation for Programs of Study provides additional opportunities for students to develop business and industry employment experiences, which must be related to the student's current program of study alongside advanced classroom instruction. The goal is to prepare students with a variety of skills to transition from job- to career-mindedness. This course provides a continuing focus on collaborative feedback between the employer, teacher, and student. Career Preparation for Programs of Study expands on Career Preparation General by increasing rigor, supporting student attainment of academic standards, and effectively preparing students for college and career success. Employment locations must be available for instructor visitation once per nine weeks and no more than 30 minutes drive time from the school campus.



Hospitality and Tourism Career Cluster

The Hospitality and Tourism career cluster focuses on the management, marketing, and operations of restaurants, lodging, attractions, recreation events, and travel-related services. This career cluster includes occupations ranging from reservation and transportation ticket agent to event planner and general manager.

Statewide Program of Study: **Culinary Arts**

The Culinary Arts program of study focuses on occupational and educational opportunities associated with the planning, directing, or coordinating activities of a food and beverage organization or department. This program of study includes opportunities involved in directing and participating in the preparation of food.



Secondary Courses for High School Credit

- Level 1**
 - Principles of Hospitality and Tourism (1 credit) [offered at JH]
 - Introduction to Culinary Arts (1 credit)

- Level 2**
 - Culinary Arts (2 credits)
 - Entrepreneurship I (1 credit)

- Level 3**
 - Advanced Culinary Arts (2 credits)

- Level 4**
 - Practicum in Culinary Arts (2 credits)
 - Career Preparation for Programs of Study (2 credits)
 - Career Preparation for Programs of Study + Extended Career Preparation (3 credits)



Example Postsecondary Opportunities

Associate Degrees

- Culinary Arts
- Baking and Pastry Arts

Bachelor's Degrees

- Hotel/Motel Administration/Management
- Culinary Science

Master's, Doctoral, and Professional Degrees

- Organizational Leadership
- Foodservice Systems Administration/Management

Additional Stackable IBCs/License

- Food Manager License

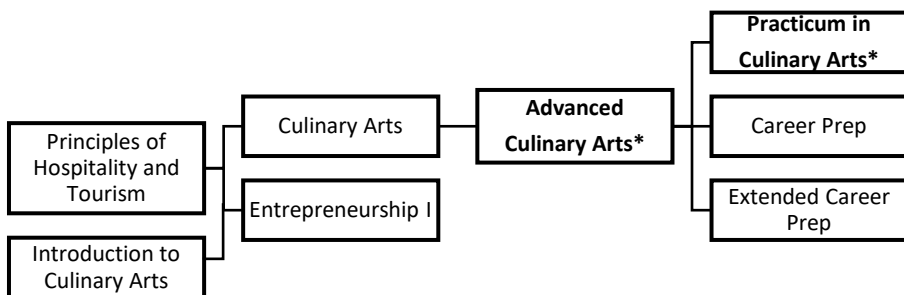

*course where Industry Based Certification can be earned

Aligned Advanced Academic Courses

AP AP Chemistry

Students should be advised to consider these course opportunities to enrich their preparation. AP or IB courses not listed under the Secondary Courses for High School Credit section of this framework document do not count towards concentrator/completer status for this program of study.

Work-Based Learning and Expanded Learning Opportunities

Work-Based Learning Activities

- Shadow a director of a non-profit that produces and delivers food for communities in need
- Intern at a catering company and learn about food production for large-scale events
- Work part-time in a restaurant as a line cook or chef

Expanded Learning Opportunities

- Participate in FCCLA
- Participate in SkillsUSA
- Participate in American Culinary Association or the Texas Restaurant Association

Aligned Industry-Based Certifications

- ServSafe Manager



Example Aligned Occupations

Bakers

Median Wage: \$29,466
Annual Openings: 2,942
10-Year Growth: 26%

Chefs and Head Cooks

Median Wage: \$44,761
Annual Openings: 950
10-Year Growth: 37%

General and Operations Managers

Median Wage: \$83,220
Annual Openings: 25,450
10-Year Growth: 23%

Data Source: TexasWages, Texas Workforce Commission. Retrieved 3/8/2024.



For more information visit:
<https://tea.texas.gov/academics/college-career-and-military-prep/career-and-technical-education/programs-of-study-additional-resources>

HOSPITALITY & TOURISM

Principles of Hospitality and Tourism

9th – 12th

1 credit

(CTHTPR)

Prerequisite: *None*

Course Description: Principles of Hospitality and Tourism introduces students to an industry that encompasses lodging, travel and tourism, recreation, amusements, attractions, and food/beverage operations. Students learn knowledge and skills focusing on communication, time management, and customer service that meet industry standards. Students will explore the history of the hospitality and tourism industry and examine characteristics needed for success in that industry.

Introduction to Culinary Arts

9th – 10th

1 credit

(CTICUL)

Prerequisite: *Recommended* Principles of Hospitality and Tourism

Course Description: Introduction to Culinary Arts will emphasize the principles of planning, organizing, staffing, directing, and controlling the management of a variety of food service operations. The course will provide insight into the operation of a well-run restaurant. Introduction to Culinary Arts will provide insight into food production skills, various levels of industry management, and hospitality skills. This is an entry level course for students interested in pursuing a career in the food service industry. This course is offered as a classroom and laboratory-based course.

Culinary Arts

10th – 12th

2 credits

(CTHTCA)

Prerequisite: *Recommended* Principles of Hospitality and Tourism and Introduction to Culinary Arts

Fee: \$50.00

Course Description: Culinary Arts begins with the fundamentals and principles of the art of cooking and the science of baking and includes management and production skills and techniques. This course is offered as a laboratory-based course.

Entrepreneurship

10th– 12th

1 credit

(CTENT)

Prerequisite: *Recommended* Principles of Business, Marketing, and Finance

Course Description: In Entrepreneurship, students will gain the knowledge and skills needed to become an entrepreneur. Students will learn the principles necessary to begin and operate a business. The primary focus of the course is to help students understand the process of analyzing a business opportunity, preparing a business plan, determining feasibility of an idea using research, and developing a plan to organize and promote the business and its products and services. In addition, students will understand the capital required, the return on investment desired, and the potential for profit.

Advanced Culinary Arts

10th – 12th

2 credits

(CTHTAC)

Prerequisite: *Required* Culinary Arts

Fee: \$50.00

Course Description: Advanced Culinary Arts will extend content and enhance skills introduced in Culinary Arts by in-depth instruction of industry-driven standards in order to prepare students for success in higher education, certifications, and/or immediate employment.

Practicum in Culinary Arts

11th-12th

2 credits

(CTHPOA)

Prerequisite: *Required* Culinary Arts

Fee: \$50.00

Course Description: Practicum in Culinary Arts is a unique practicum that provides occupationally specific opportunities for students to participate in a learning experience that combines classroom instruction with actual business and industry career experiences. Practicum in Culinary Arts integrates academic and career and technical education; provides more interdisciplinary instruction; and supports strong partnerships among schools, businesses, and community institutions with the goal of preparing students with a variety of skills in a fast-changing workplace. Instructions may be delivered through school- based laboratory training or through work-based delivery arrangements such as cooperative education, mentoring and job shadowing.

Career Preparation for Programs of Study + (Extended Career Prep) 3 credits

15+ hours/week (CTPS1X)(CTPS2X)

12th 2 credits 10-14 hours/week (CTPS1)(CTPS2)

Course Requirement: Employment must be secured within 15 days of enrollment in course and maintained throughout remainder of the course; Valid social security number

Prerequisite: at least one Level 2 or higher CTE course

Course Description: Career Preparation for Programs of Study provides additional opportunities for students to develop business and industry employment experiences, which must be related to the student's current program of study alongside advanced classroom instruction. The goal is to prepare students with a variety of skills to transition from job- to career-mindedness. This course provides a continuing focus on collaborative feedback between the employer, teacher, and student. Career Preparation for Programs of Study expands on Career Preparation General by increasing rigor, supporting student attainment of academic standards, and effectively preparing students for college and career success. Employment locations must be available for instructor visitation once per nine weeks and no more than 30 minutes drive time from the school campus. (pending board approval)



Human Services Career Cluster

The Human Services career cluster focuses on preparing individuals for employment in career pathways that relate to families and human needs, such as counseling and mental health services, family and community services, personal care services, and consumer services. This career cluster includes occupations ranging from community health workers to cosmetologists and nutritionists.

Regional Program of Study: *Cosmetology and Personal Care Services*

The Cosmetology and Personal Care Services regional program of study focuses on occupational and educational opportunities associated with providing beauty and personal care services. This program of study includes managing personal care facilities and coordinating or supervising personal service workers.



Secondary Courses for High School Credit

Level 1

- Level 2**
- Introduction to Cosmetology (1 credit)
 - Entrepreneurship I (1 credit)

- Level 3**
- Cosmetology I (2 credits)

- Level 4**
- Cosmetology II (2 credits)
 - Career Preparation for Programs of Study (2 credits)
 - Career Preparation for Programs of Study + Extended Career Preparation (3 credits)

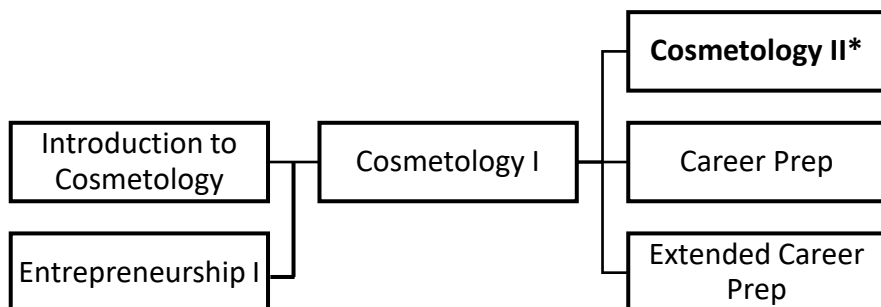

*course where Industry Based Certification can be earned

Work-Based Learning and Expanded Learning Opportunities

| | |
|--|--|
| Work-Based Learning Activities | <ul style="list-style-type: none"> • Work part-time in a salon, spa, or barbershop • Participate in an apprenticeship at a salon to become an apprentice stylist |
| Expanded Learning Opportunities | <ul style="list-style-type: none"> • Tour a salon, spa, or barbershop • Participate in SkillsUSA |

Aligned Industry-Based Certifications

- Cosmetology Operator License



Example Postsecondary Opportunities

Apprenticeships

- Apprentice Stylist

Associate Degrees

- Cosmetology Operator
- Esthetics and Skin Care

Additional Stackable IBCs/License

- Class A Barber
- Eyelash Extension Specialist
- Hair Weaving Specialist



Example Aligned Occupations

Hairdressers, Hairstylists, and Cosmetologists

Median Wage: \$27,286
Annual Openings: 8,014
10-Year Growth: 25%

Skincare Specialists

Median Wage: \$35,112
Annual Openings: 778
10-Year Growth: 38%

First-Line Supervisors of Personal Service Workers

Median Wage: \$36,795
Annual Openings: 2,253
10-Year Growth: 29%

Data Source: TexasWages, Texas Workforce Commission. Retrieved 3/8/2024.



For more information visit:
<https://tea.texas.gov/academics/college-career-and-military-prep/career-and-technical-education/programs-of-study-additional-resources>

HUMAN SERVICES

Introduction to Cosmetology

9th – 10th

1 credit

(CTICOS)

Prerequisite: *None*

Fee: \$175.00

Course Description: In Introduction to Cosmetology, students explore careers in the cosmetology industry. To prepare for success. Students must have academic and technical knowledge and skills relative to the industry. Students may begin to earn hours toward state licensing requirements. Attendance is critical to the earning of the 1000 clock hours of supervised classroom instruction and demonstration needed before students qualify to take the state board test for licensing.

Entrepreneurship

10th– 12th

1 credit

(CTENT)

Prerequisite: *Recommended* Principles of Business, Marketing, and Finance

Course Description: In Entrepreneurship, students will gain the knowledge and skills needed to become an entrepreneur. Students will learn the principles necessary to begin and operate a business. The primary focus of the course is to help students understand the process of analyzing a business opportunity, preparing a business plan, determining feasibility of an idea using research, and developing a plan to organize and promote the business and its products and services. In addition, students will understand the capital required, the return on investment desired, and the potential for profit.

Cosmetology I

10th-11th

2 credits

(CTCOS1)

Prerequisite: *Recommended* Introduction to Cosmetology.

Fee: \$30.00

Course Description: In Cosmetology I, students coordinate integration of academic, career, and technical knowledge and skills in this laboratory instructional sequence course designed to provide job-specific training for employment in cosmetology careers. Instruction includes sterilization and sanitation procedures, hair care, nail care, and skin care and meets the Texas Department of Licensing and Regulation (TDLR) requirements for licensure upon passing the state examination. Analysis of career opportunities, license requirements, knowledge and skills expectations, and development of workplace skills are included. Attendance is critical to the earning of the monitored 1000 clock hours required for qualification for taking the state examination for licensing.

Cosmetology II

11th-12th

2 credits

(CTCOS2)

Prerequisite: *Required* Cosmetology I;

Fee: \$30.00

Course Description: In Cosmetology II, students will demonstrate proficiency in academic, technical, and practical knowledge and skills. The content is designed to provide the occupational skills required for licensure. Instruction includes advanced training in professional standards/employability skills; Texas Department of Licensing and Regulation (TDLR) rules and regulations; use of tools, equipment, technologies, and materials; and practical skills. This course provides the final advanced training for employment in cosmetology careers. This course meets the Texas Department of Licensing and Regulation requirements for licensure upon completing the required 1000 clock hours of licensed instructor monitoring student classroom instruction/ application and a passing grade on the state examination. Good attendance is necessary to be successful in this lucrative career path training.

Career Preparation for Programs of Study + (Extended Career Prep) 3 credits 15+ hours/week (CTPS1X)(CTPS2X)

12th 2 credits 10-14 hours/week (CTPS1)(CTPS2)

Course Requirement: Employment must be secured within 15 days of enrollment in course and maintained throughout remainder of the course; Valid social security number

Prerequisite: at least one Level 2 or higher CTE course

Course Description: Career Preparation for Programs of Study provides additional opportunities for students to develop business and industry employment experiences, which must be related to the student's current program of study alongside advanced classroom instruction. The goal is to prepare students with a variety of skills to transition from job- to career-mindedness. This course provides a continuing focus on collaborative feedback between the employer, teacher, and student. Career Preparation for Programs of Study expands on Career Preparation General by increasing rigor, supporting student attainment of academic standards, and effectively preparing students for college and career success. Employment locations must be available for instructor visitation once per nine weeks and no more than 30 minutes drive time from the school campus.

Information Technology Career Cluster

The Information Technology (IT) career cluster focuses on the design, development, support, and management of hardware, software, multimedia, and systems integration services. This career cluster includes occupations ranging from Software Developer and Programmer to Cybersecurity Specialists and Network Analysts.

Statewide Program of Study: Cybersecurity

The Cybersecurity program of study focuses on occupational and educational opportunities associated with planning, implementing, upgrading, or monitoring security measures for the protection of computer networks and information. This program of study includes responding to computer security breaches and viruses and administering network security measures.

Secondary Courses for High School Credit

- Level 1**
 - Principles of Information Technology (1 credit)
 - Fundamentals of Computer Science (1 credit) [offered only at JH]
- Level 2**
 - Computer Science I (1 credit)
 - AP Computer Science Principles (1 credit)
- Level 3**
 - AP Computer Science A (1 math & 1 LOTE credit)
- Level 4**
 - Independent Study in Evolving/Emerging Technologies (1 credit)
 - Career Preparation for Programs of Study (2 credits)
 - Career Preparation for Programs of Study + Extended Career Preparation (3 credits)

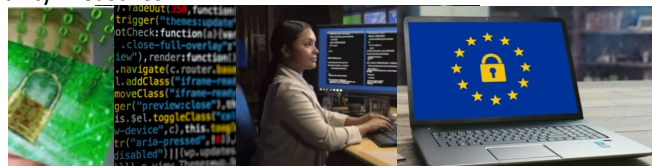

Examples Postsecondary Opportunities

Associate Degrees

- Computer and Information Systems Security
- Computer Programming

Bachelor's Degrees

- Computer Science
- Computer Software Engineering

Master's, Doctoral, and Professional Degrees

- Computer and Information Systems Security/Auditing/Information Assurance
- Computer Software Engineering

Additional Stackable IBCs/License

- Certified Ethical Hacker (CEH)

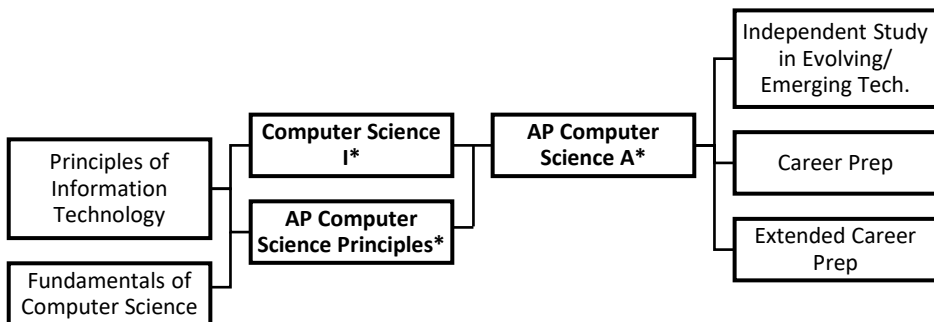
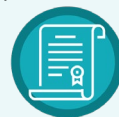

*course where Industry Based Certification can be earned

Aligned Advanced Academic Courses

- | | |
|----|---|
| AP | AP Computer Science Principles AP Computer Science A |
|----|---|

Students should be advised to consider these course opportunities to enrich their preparation. AP or IB courses not listed under the Secondary Courses for High School Credit section of this framework document do not count towards concentrator/completer status for this program of study.

Work-Based Learning and Expanded Learning Opportunities

Work-Based Learning Activities

- Intern at a local bank, hospital, or government office to develop skills in implementing security measures
- Interview with an information security analyst to learn how they plan for, monitor, and upgrade security measures at their organization

Expanded Learning Opportunities

- Participate in a Hackathon
- Participate in TSA or SkillsUSA

Aligned Industry-Based Certifications

- CompTIA IT Fundamentals+



Example Aligned Occupations

Computer User Support Specialists

Median Wage: \$51,411
Annual Openings: 5,757
10-Year Growth: 21%

Software Developers

Median Wage: \$111,705
Annual Openings: 15,324
10-Year Growth: 36%

Information Security Analysts

Median Wage: \$110,268
Annual Openings: 1,719
10-Year Growth: 49%

Data Source: TexasWages, Texas Workforce Commission. Retrieved 3/8/2024.



For more information visit:

<https://tea.texas.gov/academics/college-career-and-military-prep/career-and-technical-education/programs-of-study-additional-resources>

Information Technology Career Cluster



The Information Technology (IT) career cluster focuses on the design, development, support, and management of hardware, software, multimedia, and systems integration services. This career cluster includes occupations ranging from Software Developer and Programmer to Cybersecurity Specialists and Network Analysts.

Statewide Program of Study: Programming and Software Development

The Programming and Software Development program of study focuses on occupational and educational opportunities associated with researching, designing, developing, testing, and operating systems-level software, compilers, and network distribution software for medical, industrial, military, communications, aerospace, business, scientific, and general computer applications. This program of study includes creating, modifying, and testing the codes, forms, and script that allow computer applications to run.



Secondary Courses for High School Credit

- Level 1**
 - Principles of Information Technology (1 credit)
 - Fundamentals of Computer Science (1 credit) [offered at JH]

- Level 2**
 - Computer Science I (1 credit)
 - Game Programming and Design (1 credit)
 - AP Computer Science Principles (1 credit)
 - Entrepreneurship I (1 credit)

- Level 3**
 - Computer Science II (1 credit)
 - AP Computer Science A (1 math & 1 LOTE credit)

- Level 4**
 - Computer Science III (1 credit)
 - Independent Study in Evolving/Emerging Technologies (1 credit)
 - Practicum in Audio/Video Production (2 credits)
 - Career Preparation for Programs of Study (2 credits)
 - Career Preparation for Programs of Study + Extended Career Preparation (3 credits)



Example Postsecondary Opportunities

Apprenticeships

- Computer Programmer Apprenticeship

Associate Degrees

- Computer Programming
- Web Page, Digital/Multimedia and Information Resources Design

Bachelor's Degrees

- Data Science
- Computer Engineering

Master's, Doctoral, and Professional Degrees

- Management Science
- Computer Software Engineering

Additional Stackable IBCs/License

- AWS Certified Developer Associate

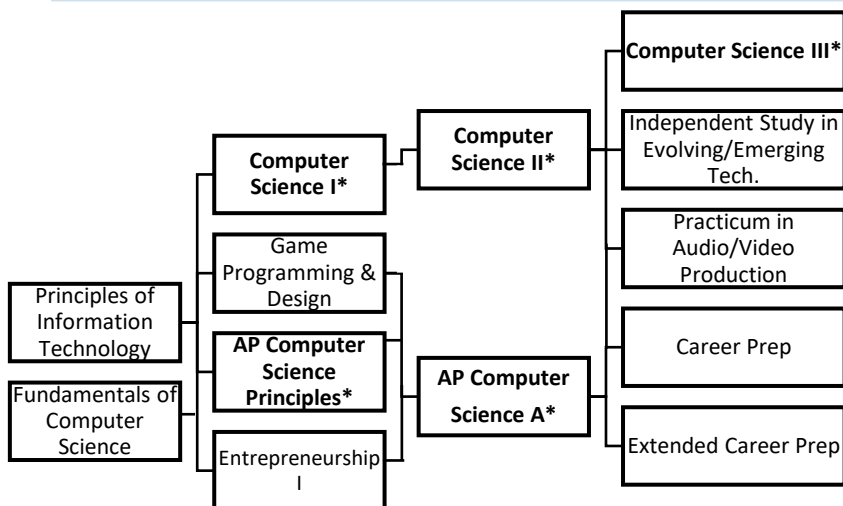

*course where Industry Based Certification can be earned
Aligned Advanced Academic Courses

- | | |
|----|---------------------------------|
| AP | AP Calculus AB AP Statistics |
|----|---------------------------------|

Students should be advised to consider these course opportunities to enrich their preparation. AP or IB courses not listed under the Secondary Courses for High School Credit section of this framework document do not count towards concentrator/completer status for this program of study.

Work-Based Learning and Expanded Learning Opportunities

Work-Based Learning Activities

- Intern at a local IT company to develop skills in programming and coding
- Shadow a software developer to learn how they create and improve software to support efficient processes at their company

Expanded Learning Opportunities

- Program and create a game
- Participate in SkillsUSA or TSA

Aligned Industry-Based Certifications

- Certified Entry-Level Python Programmer (PCEP)
- CompTIA IT Fundamentals+

Successful completion of the Programming and Software Development program of study will fulfill requirements of the Business and Industry endorsement or the STEM endorsement if the math and science requirements are met.



Example Aligned Occupations

Computer User Support Specialists

Median Wage: \$51,411
 Annual Openings: 5,757
 10-Year Growth: 21%

Software Developers

Median Wage: \$111,705
 Annual Openings: 15,324
 10-Year Growth: 36%

Computer Programmers

Median Wage: \$87,997
 Annual Openings: 1,176
 10-Year Growth: 4%

Data Source: TexasWages, Texas Workforce Commission. Retrieved 3/8/2024.



For more information visit:
<https://tea.texas.gov/academics/college-career-and-military-prep/career-and-technical-education/programs-of-study-additional-resources>

INFORMATION TECHNOLOGY

Principles of Information Technology

9th–10th

1 credit

(CTPINF)

Prerequisite: *None*

Course Description: In Principles of Information Technology, students will develop computer literacy skills to adapt to emerging technologies used in the global marketplace. Students will implement personal and interpersonal skills to prepare for a rapidly evolving workplace environment. Students will enhance reading, writing, computing, communication, and reasoning skills and apply them to the information technology environment.

LOTE Computer Science I

See LOTE Computer Science I

LOTE Computer Science I Honors

See LOTE Computer Science I Honors

LOTE Computer Science II

See LOTE Computer Science II

LOTE Computer Science II Honors

See LOTE Computer Science II Honors

Computer Science II AP A -LOTE and Math

See Computer Science II AP A -LOTE and Math

AP Computer Science Principles

10th–12th

1 credit

(TACSPR)

Prerequisite: *Recommended* Algebra I

Course Description: The course introduces the central ideas in computer science, instilling the ideas and practices of computational thinking and inviting students to understand how computing changes the world. The students will develop computational artifacts and will think creatively while using simulations to explore various situations. The focus of the class is beyond the machine. The students will design and implement innovative solutions using an iterative process similar to what artists, writers, computer scientists, and engineers use. ***This course does not satisfy the mathematics credit required for graduation.*** This course provides an opportunity to earn college credit upon completion of the AP exam and receiving a score of 3 or higher.

Game Programming and Design

9th – 12th

1 credit

(TACGPG)

Prerequisite: *Required* Algebra I

Course Description: Game Programming and Design will foster student creativity and innovation by presenting students with opportunities to design, implement, and present meaningful programs through a variety of media. Students will collaborate with one another, their instructor, and various electronic communities to solve gaming problems. Through data analysis, students will include the identification of task requirements, plan search strategies, and use programming concepts to access, analyze, and evaluate information needed to design games. By acquiring programming knowledge and skills that support the work of individuals and groups in solving problems, students will select the technology appropriate for the task, synthesize knowledge, create solutions, and evaluate the results. Students will learn digital citizenship by researching current laws and regulations and by practicing integrity and respect. Students will create a computer game that is presented to an evaluation panel.

Entrepreneurship

10th– 12th

1 credit

(CTENT)

Prerequisite: *Recommended* Principles of Business, Marketing, and Finance

Course Description: In Entrepreneurship, students will gain the knowledge and skills needed to become an entrepreneur. Students will learn the principles necessary to begin and operate a business. The primary focus of the course is to help students understand the process of analyzing a business opportunity, preparing a business plan, determining feasibility of an idea using research, and developing a plan to organize and promote the business and its products and services. In addition, students will understand the capital required, the return on investment desired, and the potential for profit.

Computer Science III

11th–12th

1 credit

(CTACS3)

Prerequisite: *Required* Computer Science II or Advanced Placement (AP) Computer Science A.

Course Description: Computer Science III will foster students' creativity and innovation by presenting opportunities to design, implement, and present meaningful programs through a variety of media. Students will collaborate with one another, their instructor, and various electronic communities to solve the problems presented throughout the course. Through data analysis, students will

identify task requirements, plan search strategies, and use computer science concepts to access, analyze, and evaluate information needed to solve problems. By using computer science knowledge and skills that support the work of individuals and groups in solving problems, students will select the technology appropriate for the task, synthesize knowledge, create solutions, and evaluate the results. Students will learn digital citizenship by researching current laws and regulations and by practicing integrity and respect. Students will gain an understanding of advanced computer science data structures through the study of technology operations, systems, and concepts.

Independent Study in Evolving/Emerging Technologies (Computer Science- Problems and Solutions) (TACS4)
9th – 12th 1 credit

Prerequisite: *Recommended* a minimum of one credit from the Information Technology Program of Study

Course Description: In the Independent Study in Evolving/Emerging Technologies course, through the study of evolving/emerging technologies, including technology-related terms, concepts, and data input strategies, students will communicate information in different formats and to diverse audiences using a variety of technologies. Students will learn to make informed decisions, develop and produce original work that exemplifies the standards identified by the selected profession or discipline, and publish the product in electronic media and print. Students will demonstrate efficient acquisition of information by identifying task requirements, using search strategies, and using technology to access, analyze, and evaluate the acquired information. By using technology as a tool that supports the work of individuals and groups in solving problems, students will select the technology appropriate for the task, synthesize knowledge, create solutions, and evaluate the results. The six strands include creativity and innovation; communication and collaboration; research and information fluency; critical thinking; problem solving, and decision making; digital citizenship; and technology operations and concepts.

Practicum in Audio/Video Production (CTPAVP)
12th 2 credits

Prerequisite: *Required* Audio/Video Production II and Audio/Video Production II Lab

Course Description: Careers in audio/video production span all aspects of the audio/video communications industry. Building upon the concepts taught in Audio/Video Production II and its co-requisite Audio/Video Production II Lab, in addition to developing advanced technical knowledge and skills needed for success in the Arts, Audio/Video Technology, and Communications Program of Study, students will be expected to develop an increasing understanding of the industry with a focus on applying pre-production, production, and post-production audio and video products in a professional environment. This course may be implemented in an advanced audio/video or audio format. Instruction may be delivered through lab-based classroom experiences or career preparation opportunities.

Career Preparation for Programs of Study + (Extended Career Prep) 3 credits 15+ hours/week (CTPS1X)(CTPS2X)
12th 2 credits 10-14 hours/week (CTPS1)(CTPS2)

Course Requirement: Employment must be secured within 15 days of enrollment in course and maintained throughout remainder of the course; Valid social security number

Prerequisite: at least one Level 2 or higher CTE course

Course Description: Career Preparation for Programs of Study provides additional opportunities for students to develop business and industry employment experiences, which must be related to the student's current program of study alongside advanced classroom instruction. The goal is to prepare students with a variety of skills to transition from job- to career-mindedness. This course provides a continuing focus on collaborative feedback between the employer, teacher, and student. Career Preparation for Programs of Study expands on Career Preparation General by increasing rigor, supporting student attainment of academic standards, and effectively preparing students for college and career success. Employment locations must be available for instructor visitation once per nine weeks and no more than 30 minutes drive time from the school campus. (pending board approval)



Law and Public Service Career Cluster

The Law and Public Service career cluster focuses on planning, managing, and providing legal services, public safety, protective services, and homeland security, including professional and technical support services. This career cluster includes occupations ranging from police officer and firefighter to political scientist and lawyer.

Statewide Program of Study: Law Enforcement

The Law Enforcement program of study focuses on occupational and educational opportunities associated with the development and enforcement of laws by various branches of law enforcement. This program of study includes the history, organization, and functions of local, state, and federal law enforcement. Students will understand the role of constitutional law at local, state, and federal levels; the U.S. legal system; criminal law; and law enforcement terminology and the classification and elements of crime.



Secondary Courses for High School Credit

- Level 1**
 - Principles of Law, Public Safety, Corrections, and Security (1 credit)

- Level 2**
 - Law Enforcement I (1 credit)

- Level 3**
 - Law Enforcement II (1 credit)
 - Correctional Services (1 credit)

- Level 4**
 - Forensic Science (1 credit)
 - Career Preparation for Programs of Study (2 credits)
 - Career Preparation for Programs of Study + Extended Career Preparation (3 credits)

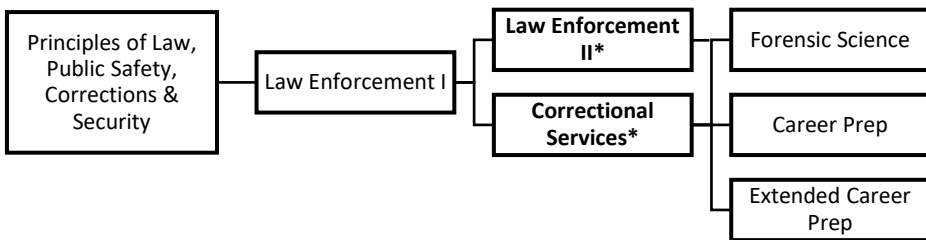

*course where Industry Based Certification can be earned

Work-Based Learning and Expanded Learning Opportunities

| | |
|--|---|
| Work-Based Learning Activities | <ul style="list-style-type: none"> • Shadow a detective to learn about investigations and the role of detectives in law enforcement • Intern in dispatch at a local law enforcement agency to learn about first responder roles and processes |
| Expanded Learning Opportunities | <ul style="list-style-type: none"> • Visit a police department • Participate in TSA or SkillsUSA |

Aligned Industry-Based Certifications

- Non-Commissioned Security Officer Level II License
- Forensic Technician



Example Postsecondary Opportunities

- Apprenticeships**
- Security Specialist
- Associate Degrees**
- Criminal Justice
 - Law Enforcement



- Bachelor's Degrees**
- Forensic Science
 - Criminal Justice

- Master's, Doctoral, and Professional Degrees**
- Criminal Justice
 - Criminology and Criminal Justice

- Additional Stackable IBCs/Licensures**
- Jailer – Basic County Corrections
 - Basic Telecommunicator



Example Aligned Occupations

Police and Sheriff's Patrol Officers

Median Wage: \$64,373
Annual Openings: 5,424
10-Year Growth: 13%

Detectives and Criminal Investigators

Median Wage: \$82,090
Annual Openings: 1,536
10-Year Growth: 8%

First-Line Supervisors of Police and Detectives

Median Wage: \$97,571
Annual Openings: 5,461
10-Year Growth: 12%

Data Source: TexasWages, Texas Workforce Commission. Retrieved 3/8/2024.



For more information visit:
<https://tea.texas.gov/academics/college-career-and-military-prep/career-and-technical-education/programs-of-study-additional-resources>

LAW AND PUBLIC SERVICE

Principles of Law, Public Safety, Corrections, and Security (CTPPLS)
9th -12th 1 credit

Prerequisite: *None*

Course Description: Principles of Law, Public Safety, Corrections, and Security introduces students to professions in law enforcement, protective services, corrections, firefighting, and emergency management services. Students will examine the roles and responsibilities of police, courts, corrections, private security, and protective agencies of fire and emergency services. The course provides students with an overview of the skills necessary for careers in law enforcement, fire service, protective services, and corrections.

Law Enforcement I (CTLAWF)
10th – 12th 1 credit

Prerequisite: *Recommended* Principles of Law, Public Safety, Corrections, and Security

Course Description: Law Enforcement I is an overview of the history, organization, and functions of local, state, and federal law enforcement. Students will understand the role of constitutional law at local, state, and federal levels; the U.S. legal system; criminal law; and law enforcement terminology and the classification and elements of crime.

Law Enforcement II (CTLAW2)
10th – 12th 1 credit

Prerequisite: *Recommended* Law Enforcement I

Course Description: Law Enforcement II provides the knowledge and skills necessary to prepare for a career in law enforcement. Students will understand ethical and legal responsibilities, patrol procedures, first responder roles, telecommunications, emergency equipment operations, and courtroom testimony.

Correctional Services (CTLCRS)
10th - 12th 1 credit

Prerequisite: *Recommended* Principles of Law, Public Safety, Corrections, and Security

Course Description: In Correctional Services, students prepare for certification required for employment as a municipal, county, state, or federal correctional officer. Students will learn the role and responsibilities of a county or municipal correctional officer; discuss relevant rules, regulations, and laws of municipal, county, state, or federal facilities; and discuss defensive tactics, restraint techniques, and first aid procedures as used in the municipal, county, state, or federal correctional setting. Students will analyze rehabilitation and alternatives to institutionalization for inmates. *Students that are 18 may be able to participate in on the job shadowing and training opportunities with local agencies.*

Forensic Science (CTFORE)
11th-12th 1 credit 4.0

Prerequisite: *Required* one credit Biology, one credit Integrated Physics and Chemistry (IPC), Chemistry or Physics

Course Description: Forensic Science is a survey course that introduces students to the application of science to law. Students learn terminology and procedures related to the collection and examination of physical evidence using scientific processes performed in a field or laboratory setting. Students also learn the history and the legal aspects of forensic science. *This course satisfies a 3rd or 4th year Science graduation requirement and will be counted in the GPA as an academic elective.*

Career Preparation for Programs of Study + (Extended Career Prep) 3 credits 15+ hours/week (CTPS1X)(CTPS2X)
12th 2 credits 10-14 hours/week (CTPS1)(CTPS2)

Course Requirement: Employment must be secured within 15 days of enrollment in course and maintained throughout remainder of the course; Valid social security number

Prerequisite: at least one Level 2 or higher CTE course

Course Description: Career Preparation for Programs of Study provides additional opportunities for students to develop business and industry employment experiences, which must be related to the student's current program of study alongside advanced classroom instruction. The goal is to prepare students with a variety of skills to transition from job- to career-mindedness. This course provides a continuing focus on collaborative feedback between the employer, teacher, and student. Career Preparation for Programs of Study expands on Career Preparation General by increasing rigor, supporting student attainment of academic standards, and effectively preparing students for college and career success. Employment locations must be available for instructor visitation once per nine weeks and no more than 30 minutes drive time from the school campus.

Manufacturing Career Cluster

The Manufacturing career cluster focuses on planning, managing, and performing the processing of materials into intermediate or final products and related professional and technical support activities such as production planning and control, maintenance, and process engineering. This career cluster includes occupations ranging from welder and machinist to industrial engineering technician and semi-conductor processing technician.

Statewide Program of Study: Robotics and Automation Technology

The Robotics and Automation Technology program of study focuses on occupational and educational opportunities associated with the assembly, operation, maintenance, and repair of electromechanical equipment or devices. This program of study includes exploration of a variety of mechanical fields, including robotics, refinery and pipeline systems, deep ocean exploration, and hazardous waste removal.

Secondary Courses for High School Credit



- Level 1**
 - Principles of Manufacturing (1 credit)
 - Principles of Applied Engineering (1 credit)

- Level 2**
 - Robotics I (1 credit)

- Level 3**
 - Robotics II (1 credit)

- Level 4**
 - Practicum in Manufacturing (2 credits)
 - Career Preparation for Programs of Study (2 credits)
 - Career Preparation for Programs of Study + Extended Career Preparation (3 credits)

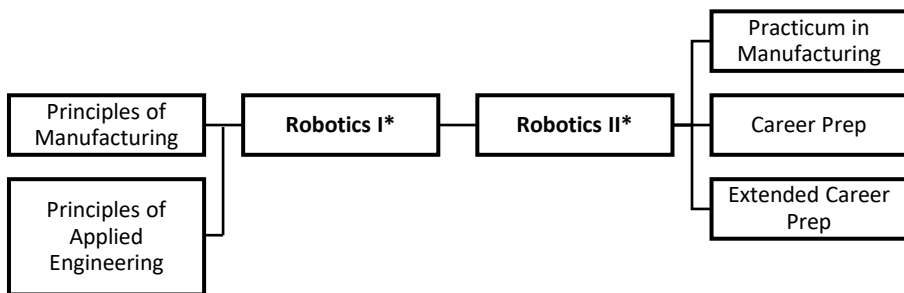

*course where Industry Based Certification can be earned

Work-Based Learning and Expanded Learning Opportunities

| | |
|--|---|
| Work-Based Learning Activities | <ul style="list-style-type: none"> • Intern with a robotics technician working at a manufacturing plant • Shadow a PLC programmer |
| Expanded Learning Opportunities | <ul style="list-style-type: none"> • Tour a manufacturing facility • Participate in SkillsUSA or TSA • Build a robot and participate in a robotics competition |

Aligned Industry-Based Certifications

- C-101 Certified Industry 4.0 Associate - Basic Operations
- C-103 Certified Industry 4.0 Associate - Robot System Operations
- C-200 Certified Industry 4.0 Automation System Specialist I - 216 Robotic System Integration 1
- C-200 Certified Industry 4.0 Automation Systems Specialist I - 208 Programmable Controller Troubleshooting I
- C-200 Certified Industry 4.0 Automation Systems Specialist I - 215 Robotic Operations I

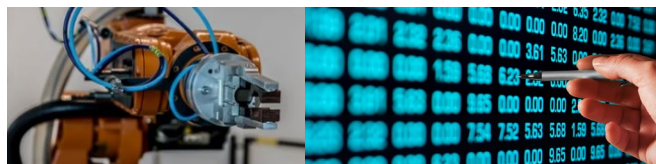

Example Postsecondary Opportunities

Associate Degrees

- Instrumentation Technology
- Industrial Technology
- Robotics Technology
- Automation Engineer Technology



Bachelor's Degrees

- Mechanical Engineering
- Electrical Electronics Engineering
- Electrical, Electronic, and Communications Engineering Technology
- Electromechanical Engineering Technology

Master's, Doctoral, and Professional Degrees

- Mechanical Engineering
- Engineering/Industrial Management
- Industrial Engineering
- Electrical and Electronics Engineering



Example Aligned Occupations

Computer Numerically Controlled Tool Operators

Median Wage: \$46,353
Annual Openings: 1,146
10-Year Growth: 10%

Semiconductor Processing Technicians

Median Wage: \$36,902
Annual Openings: 621
10-Year Growth: 9%

Industrial Engineers

Median Wage: \$100,000
Annual Openings: 1,898
10-Year Growth: 26%

Data Source: TexasWages, Texas Workforce Commission. Retrieved 3/8/2024.



For more information visit:
<https://tea.texas.gov/academics/college-career-and-military-prep/career-and-technical-education/programs-of-study-additional-resources>

Manufacturing Career Cluster

The Manufacturing career cluster focuses on planning, managing, and performing the processing of materials into intermediate or final products and related professional and technical support activities such as production planning and control, maintenance, and process engineering. This career cluster includes occupations ranging from welder and machinist to industrial engineering technician and semi-conductor processing technician.

Statewide Program of Study: Welding

The Welding Program of Study focuses on the development and use of automatic and computer-controlled machines, tools, and robots that perform work on metal or plastic. CTE learners will learn how to modify parts to make or repair machine tools or maintain individual machines and how to use hand-welding or flame-cutting equipment.



Secondary Courses for High School Credit

- Level 1**
 - Principles of Manufacturing (1 credit)
 - Introduction to Welding (1 credit)

- Level 2**
 - Welding I (2 credits)
 - Entrepreneurship I (1 credit)

- Level 3**
 - Welding II (2 credits)

- Level 4**
 - Practicum in Manufacturing (2 credits)
 - Career Preparation for Programs of Study (2 credits)
 - Career Preparation for Programs of Study + Extended Career Preparation (3 credits)

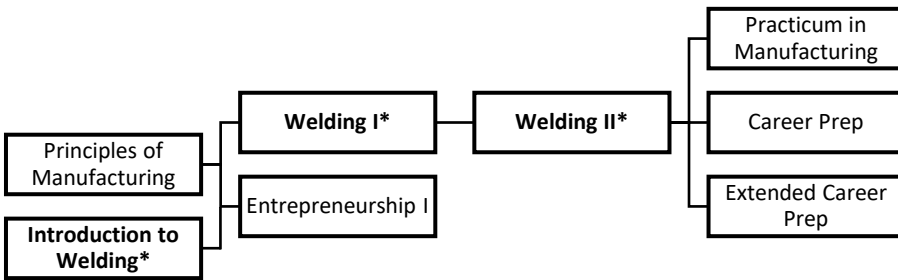

*course where Industry Based Certification can be earned

Work-Based Learning and Expanded Learning Opportunities

| | |
|--|--|
| Work-Based Learning Activities | <ul style="list-style-type: none"> • Job shadow a welder • Intern for a local welding company |
| Expanded Learning Opportunities | <ul style="list-style-type: none"> • Tour a welding shop • Participate in SkillsUSA or TSA • Participate in a welding project that benefits the community |

Aligned Industry-Based Certifications

- AWS D1.1 Structural Steel
- AWS D9.1 Sheet Metal Welding



Example Postsecondary Opportunities

Apprenticeships

- Welding



Associate Degrees

- Welding Technology
- Building/Construction Site Management
- Operations Management and Supervision

Bachelor's Degrees

- Welding Technology
- Construction Management
- Project Management
- Building/Construction Site Management

Master's, Doctoral, and Professional Degrees

- Engineering
- Engineering/Industrial Management
- Manufacturing Engineering
- Construction Engineering



Example Aligned Occupations

Welders, Cutters, Solderers, and Brazers

Median Wage: \$48,177
Annual Openings: 6,792
10-Year Growth: 23%

First-Line Supervisors of Production and Operating Workers

Median Wage: \$62,584
Annual Openings: 5,926
10-Year Growth: 17%

Industrial Production Managers

Median Wage: \$119,691
Annual Openings: 1,296
10-Year Growth: 19%

Data Source: TexasWages, Texas Workforce Commission. Retrieved 3/8/2024.



For more information visit:

<https://tea.texas.gov/academics/college-career-and-military-prep/career-and-technical-education/programs-of-study-additional-resources>

MANUFACTURING

Principles of Applied Engineering

9th – 10th

1 credit

(CTPENG)

Prerequisite: *None*

Course Description: Principles of Applied Engineering provides an overview of the various fields of science, technology, engineering, and mathematics and their interrelationships. Students will develop engineering communication skills, which include computer graphics, modeling, and presentations, by using a variety of computer hardware and software applications to complete assignments and projects. Upon completing this course, students will understand the various fields of engineering and will be able to make informed career decisions.

Principles of Manufacturing

9th – 12th

1 credit

(CTAPOM)

Prerequisite: *Recommended* Algebra I or Geometry

Course Description: In Principles of Manufacturing, students are introduced to knowledge and skills used in the proper application of principles of manufacturing. The study of manufacturing technology allows students to reinforce, apply, and transfer academic knowledge and skills to a variety of interesting and relevant activities. Students will gain an understanding of what employers require to gain and maintain employment in manufacturing careers.

Robotics I

9th – 10th

1 credit

(CTROB1)

Prerequisite: *Recommended* Principles of Applied Engineering

Course Description: Students enrolled in this course will demonstrate the knowledge and skills necessary for the robotic and automation industry. Through implementation of the design process, students will transfer advanced academic skills to component designs in a project-based environment. Students will build prototypes or use simulation software to test their designs. Additionally, students explore career opportunities, employer expectations, and educational needs in the robotic and automation industry.

Robotics II

10th – 12th

1 credit

(CTROB2)

Prerequisite: *Required* Robotics I

Course Description: Robotics II students will explore artificial intelligence and programming in the robotic and automation industry. Through implementation of the design process, students will transfer academic skills to component designs in a project-based environment. Students will build prototypes and use software to test their designs. *This course satisfies a high school mathematics graduation requirement and will be counted in the GPA as an academic elective.*

Introduction to Welding

9th – 12th

1 credit

(CTIWEL)

Prerequisite: *Recommended or co-requisite:* Algebra I

Fee: \$50.00

Course Description: Introduction to Welding will provide an introduction to welding technology with an emphasis on basic welding laboratory principles and operating procedures. Students will be introduced to the three basic welding processes. Topics include industrial safety and health practices, hand tool and power machine use, measurement, laboratory operating procedures, welding power sources, welding career potentials, and introduction to welding codes and standards. Introduction to Welding will provide students with the knowledge, skills, and technologies required for employment in welding industries. Students will develop knowledge and skills related to welding and apply them to personal career development. This course supports integration of academic and technical knowledge and skills. Students will reinforce, apply, and transfer knowledge and skills to a variety of settings and problems. Knowledge about career opportunities, requirements, and expectations and the development of workplace skills will prepare students for future success.

Welding I

10th-12th

2 credits

(CTWELD)

Prerequisite: *Recommended* Algebra I, and Principles of Manufacturing, or Introduction to Welding

Fee: \$50.00

Course Description: Welding I provides the knowledge, skills, and technologies required for employment in metal technology systems. Students will develop knowledge and skills related to this system and apply them to personal career development. This course supports integration of academic and technical knowledge and skills. Students will reinforce, apply, and transfer knowledge and skills to a variety of settings and problems. Knowledge about career opportunities, requirements, and expectations and the development of workplace skills prepare students for future success.

Entrepreneurship**(CTENT)****10th– 12th****1 credit****Prerequisite:** *Recommended* Principles of Business, Marketing, and Finance

Course Description: In Entrepreneurship, students will gain the knowledge and skills needed to become an entrepreneur. Students will learn the principles necessary to begin and operate a business. The primary focus of the course is to help students understand the process of analyzing a business opportunity, preparing a business plan, determining feasibility of an idea using research, and developing a plan to organize and promote the business and its products and services. In addition, students will understand the capital required, the return on investment desired, and the potential for profit.

Welding II**(CTAWEL)****11th – 12th****2 credits****Prerequisite:** *Required* Welding I; *Recommended* Algebra I or Geometry**Fee:** \$50.00

Course Description: Welding II builds on the knowledge and skills developed in Welding I. Students will develop advanced welding concepts and skills as related to personal and career development. Students will integrate academic and technical knowledge and skills. Students will have opportunities to reinforce, apply, and transfer knowledge and skills to a variety of settings and problems.

Practicum in Manufacturing**(CTPRMF)****12th****2 credits****Prerequisite:** *None*

Course Description: The Practicum in Manufacturing course is designed to give students supervised practical application of previously studied knowledge and skills. The practicum course is a paid or unpaid capstone experience for students participating in a coherent sequence of career and technical education courses in the Manufacturing Career Cluster. Practicum experiences can occur in a variety of locations appropriate to the nature and level of experience

Career Preparation for Programs of Study + (Extended Career Prep) 3 credits 15+ hours/week (CTPS1X)(CTPS2X)**12th 2 credits 10-14 hours/week (CTPS1)(CTPS2)**

Course Requirement: Employment must be secured within 15 days of enrollment in course and maintained throughout remainder of the course; Valid social security number

Prerequisite: at least one Level 2 or higher CTE course

Course Description: Career Preparation for Programs of Study provides additional opportunities for students to develop business and industry employment experiences, which must be related to the student's current program of study alongside advanced classroom instruction. The goal is to prepare students with a variety of skills to transition from job- to career-mindedness. This course provides a continuing focus on collaborative feedback between the employer, teacher, and student. Career Preparation for Programs of Study expands on Career Preparation General by increasing rigor, supporting student attainment of academic standards, and effectively preparing students for college and career success. Employment locations must be available for instructor visitation once per nine weeks and no more than 30 minutes drive time from the school campus.

Appendix

Graduation Preparation Timelines

NINTH GRADE – CLASS OF 2029

Students in the ninth grade will take classes in English, Math, Social Studies, and Science. Suggested electives include courses in Fine Arts (choir, band, color guard, dance, theatre, and art), Athletics, AFJROTC or some CTE courses. If a student began the study of a Language Other Than English (LOTE) in junior high, it is strongly recommended that the study continue in the ninth grade. If a student has not yet begun the study of a Language Other Than English in middle school, the student must make a plan that will allow for the study of levels 1 and 2 in consecutive years.

Testing: End – of – Course (EOC) English I, Algebra I, Biology

Required courses: English I, Algebra I or Geometry, Biology & Social Studies

Ninth Grade Timeline (check off the items you have completed)

- Sign up to take the most challenging classes that you can.
- Get to know your counselor and other college resources available.
- Talk to adults to see what they like/dislike about their careers and what education is needed.
- Become involved in extracurricular activities.
- Start saving your report cards, certificates and other accolades.
- Become involved in volunteer activities and keep a log of time spent volunteering.
- Start thinking about your dream career and check out career websites.
- Attend Career Days and College Nights at WHS or through other organizations.
- Check out how to obtain college credit for classes taken during high school.
- Do your best on the EOC exams.

TENTH GRADE – CLASS OF 2028

Tenth grade students should ensure required classes from ninth grade are either successfully completed or included in this year's course requests. Select electives with an eye toward an ultimate career goal or college major. Tenth grade requirements include English II, US History, the next sequential math class, and the next sequential science class.

Testing: Required – End-of-Course (EOC) Testing in English II, US History

Recommended – PSAT (Practice SAT test)

Required courses: English II, Geometry or Algebra II, IPC, Chemistry or Physics & Social Studies

Tenth Grade Timeline (check off the items you have completed)

- Attend Career Days and College Nights at WHS or through other organizations.
- Check out how to obtain college credit for classes taken during high school.
- Do your best on the EOC exams.
- Continue 9th grade activities and get involved in even more activities.
- Keep up with your classes. Grades are one of the top things universities consider.
- Start a savings account.
- Get to know your graduation plan. Learn about AP and dual credit courses and what endorsement or CTE pathway you plan to complete.
- Work on a four-year draft of your high school course plan.
- Become familiar with college entrance requirements.
- Register for and take the PSAT test.
- Research summer programs that focus on particular subjects, such as science or math.

ELEVENTH GRADE – CLASS OF 2027

Eleventh grade students should carefully check required courses for graduation and make sure the proper courses have been selected. Any required courses not successfully completed should be included in this year’s course requests. AP courses are also available in English, Science, Social Studies, foreign language, and some mathematics courses. Opportunities for dual credit in English and History are available. All selections should be made with an ultimate college major or career goal in mind.

Testing: Recommended – PSAT, SAT and ACT in spring (necessary for college application process for fall of senior year)

Required Courses – English III, 3rd Math, 3rd Science & Social Studies

Eleventh Grade Timeline (check off the items you have completed)

| | |
|-----------|---|
| August | <input type="checkbox"/> Check to see that you’re scheduled for the correct courses <input type="checkbox"/> Continue 10 th Grade extracurricular activities |
| September | <input type="checkbox"/> Begin attending college sessions at your high school <input type="checkbox"/> Search for the colleges /universities that you are interested in attending <input type="checkbox"/> Prepare for the PSAT by reviewing practice tests |
| October | <input type="checkbox"/> Attend Career Day & College Night at WHS <input type="checkbox"/> Take the PSAT (Practice SAT) & use your results to help you prepare for the SAT |
| November | <input type="checkbox"/> Set up a working résumé for yourself Visit the College & Career Center |
| December | <input type="checkbox"/> Begin writing your personal essays for applications, scholarships, etc <input type="checkbox"/> Learn how your GPA is computed |
| January | <input type="checkbox"/> Research the colleges you are interested in to see if you will need to take SAT Subject specific tests <input type="checkbox"/> Register and take ACT and/or SAT |
| February | <input type="checkbox"/> Make sure you keep up with all of your community service hours <input type="checkbox"/> Begin deciding on courses for senior year |
| March | <input type="checkbox"/> Compile your recommendation letters Narrow your college choices to 3 to 5 <input type="checkbox"/> Take SAT School Day |
| April | <input type="checkbox"/> Check that your graduation requirements are in order |
| May | <input type="checkbox"/> Take the EOC test seriously. <input type="checkbox"/> Study and take AP Exams. |
| June | <input type="checkbox"/> Last Chance to take ACT or SAT before senior year <input type="checkbox"/> Visit the colleges that interest you. |

Reminder –All graduation requirements, including passing all parts of the End-of-Course (EOC) Tests, must be met before you can take part in the graduation ceremony.

TWELFTH GRADE – CLASS OF 2026

It is critical that each student and his or her parent(s) carefully review the requirements for graduation and the student’s transcript to ensure the proper classes are selected to meet graduation requirements. The counselor will work diligently with you to select the proper classes, but remember, your graduation is ultimately your responsibility. Opportunities to retake classes failed during the senior year typically do not exist. Those classes must be made up outside of school hours, sometimes at considerable expense.

Testing:

Required – End-of-Course (EOC) Tests, all parts (if not passed during 9th, 10th, or 11th grade year)

Recommended – SAT, ACT, Texas Success Initiative (TSIA2) Exam (if needed), AP Tests, SAT Subject Tests (as appropriate)

Required Courses: 4th Year English, 4th Year Math, 4th Year Science & any other required course not previously passed.

By senior year, you need to have plans for post-graduation, and you need to make sure your selections adequately prepare you for your future plans.

- College – choose 3 to 5 schools: one dream school that may seem like a stretch, one sure thing, and several choices in between. Make sure you meet the admission requirements and are registered for the proper entrance exams. Apply early! Do not wait until just before the deadline or you may be too late.
- Technical school – check with several to make sure they have the kind of training you are seeking. Compare their cost of tuition, accreditations, job placement rates, and financial aid opportunities to determine what the best choice is for you.
- Military – talk to recruiters from several branches of the service. See which one offers you the best opportunities. Make an appointment to take the ASVAB and keep in touch with the recruiter of the branch you select.
- Work – make sure you have adequate job skills for a career with a future, not just a temporary job. See if the jobs you are considering offer incentives for furthering your education.

Twelfth Grade Timeline (check off the items you have completed)

| | |
|-----------|---|
| August | <input type="checkbox"/> Make sure that you have the classes needed in your graduation plan and required at the college or university that you are planning to attend. <input type="checkbox"/> Take as many challenging (possibly AP or Dual Credit) courses as you can. <input type="checkbox"/> Start college applications at https://www.applytexas.org/ or https://apply.commonapp.org/ |
| September | <input type="checkbox"/> Keep a calendar with deadlines posted for easy visibility. <input type="checkbox"/> Register and take ACT and/or the SAT if you have not done so! <input type="checkbox"/> Difficulty paying for ACT or SAT registration fees? See about getting a fee waiver. <input type="checkbox"/> Keep up with the College & Career newsletters throughout the year. <input type="checkbox"/> Request your FAFSA ID at www.pin.ed.gov . <input type="checkbox"/> Register for AP exams. |
| October | <input type="checkbox"/> Attend Career Day & College Night at WHS. <input type="checkbox"/> Check that you are scheduled to graduate at the end of the year. <input type="checkbox"/> Meet with your Counselor early to discuss your plans, transcript requests, fee waiver, and letters of recommendation (2 weeks' notice). <input type="checkbox"/> Be aware of College Early Decision or Early Admission deadlines. <input type="checkbox"/> Apply early! |
| November | <input type="checkbox"/> Check for scholarship opportunities in the College & Career Center, websites, etc. and complete and submit application forms before deadlines. <input type="checkbox"/> Prepare your application carefully. Follow the instructions and pay close attention to deadlines! Be sure to ask your counselor and teachers at least two weeks before your application deadlines to submit the necessary documents to colleges (your transcript, letter of recommendation, etc.). |
| December | <input type="checkbox"/> Submit applications for college admission at www.applytexas.org (Texas higher education institutions)/ www.commonapp.org and housing (if applicable). <input type="checkbox"/> Be ready to send out Mid-Year Reports in January. <input type="checkbox"/> Begin the FAFSA (Free Application for Federal Student Aid www.fafsa.ed.gov) |
| January | <input type="checkbox"/> Verify that the college admissions office has all your paperwork. <input type="checkbox"/> Register for and take the ACT and SAT, and SAT Subject Tests, or any other exams required for admission to the colleges to which you are applying if you have not done so. |

| | |
|----------|---|
| February | <input type="checkbox"/> Continue to check the status of your applications. <input type="checkbox"/> Complete all necessary financial aid forms; check with the colleges you are applying to see if they have additional forms that need to be filled out. <input type="checkbox"/> Check to see if you will need to fill out a CSS/Financial Aid Profile. |
| March | <input type="checkbox"/> Look for your Student Aid Report (SAR) in the mail. Pay particular attention to the Expected Family Contribution (EFC) and discuss it with your parents. |
| April | <input type="checkbox"/> Watch the mail for acceptance letters and financial aid award letters; compare the financial aid packages. <input type="checkbox"/> Register for and take the Texas Success Initiative (TSIA-2) Exam if needed. <input type="checkbox"/> Determine which college/university you will be attending. <input type="checkbox"/> Finalize college housing arrangements and send a deposit to the college you choose. |
| May | <input type="checkbox"/> Study and take AP Exams. <input type="checkbox"/> Inform each college of your acceptance or rejection of their offer of admission/financial aid by May 1. <input type="checkbox"/> RSVP for summer orientation programs. <input type="checkbox"/> Request a final transcript to be sent to your college/university. <input type="checkbox"/> Graduate! |
| June | <input type="checkbox"/> Review your financial aid package; determine if you will need additional money for college. <input type="checkbox"/> Take part in summer orientation programs for incoming freshmen. <input type="checkbox"/> See your academic advisor and register for classes. |

WALLER INDEPENDENT SCHOOL DISTRICT

It is the policy of Waller ISD not to discriminate on the basis of race, color, national origin, sex or handicap in its vocational programs, services or activities as required by Title VI of the Civil Rights Act of 1964, as amended; Title IX of the Education Amendments of 1972; and Section 504 of the Rehabilitation Act of 1973, as amended.

It is the policy of Waller ISD not to discriminate on the basis of race, color, national origin, sex, handicap, or age in its employment practices as required by Title VI of the Civil Rights Act of 1964, as amended; Title IX of the Education Amendments of 1972; the Age Discrimination Act of 1975, as amended; and Section 504 of the Rehabilitation Act of 1973 as amended.