



Course Registration
Industry, Engineering & Technology



2025-2026 School Year



Registration

Registration is
open in
Student
Portal

Course
selection is
due by
January 16th

School
Counselors
are available



GRADUATION
REQUIREMENTS



24 CREDITS



GRADUATION PROJECT



KEYSTONES - must attain
proficiency through one
of five pathways

4-Year Planning Guide

- ▶ Most students will need 1.0 credit of English, 1.0 credit of Social Studies, 1.0 credit of Math and 0.5 credit of PE
- ▶ What other graduation requirements will you need?
- ▶ Let's go to the Registration Screen/4-Year Planning Guide



Registration Page

Career Pathway

Industry and Engineering Technology

[Click here for career pathway information](#)

Course Registration Mode

Grades 9-12

Required Courses 24 Credits Minimum 23.7 Credits Earned/Planned	Grade 9 7.9 Credits Earned	Grade 10 7.9 Credits Earned	Grade 11 7.9 Credits Earned	Grade 12 6 Credits Minimum 0 Credits Planned
English 4 Credits Required (1 Cr/Year) 3 Credits Earned/Planned	HON ENGLISH 9 0125 (1 Cr)	HON ENGLISH 10 0135 (1 Cr)	AP LANGUAGE/COMP 0146 (1 Cr)	Add +
Social Studies 4 Credits Required (1 Cr/Year) 3 Credits Earned/Planned	HON US HISTORY 1 0225 (0.5 Cr) HON US HISTORY 2 0226 (0.5 Cr)	AP WORLD HISTORY: MODERN 0237 (1 Cr)	AP US HISTORY 0247 (1 Cr)	Add +
Math 4 Credits Required (1 Cr/Year) 3 Credits Earned/Planned	HON GEOMETRY 0325 (1 Cr)	CHS ALGEBRA 2 0335 (1 Cr)	CHS PRECALCULUS/TRIG 0355 (1 Cr)	Add +
Science 2 Credits Required 2.8 Credits Earned/Planned	HON BIOLOGY 0435 (1.4 Cr)	CHS CHEMISTRY 0465 (1.4 Cr)		Add +
Physical Education 2 Credits Required (0.5 Cr/Year) 1.5 Credits Earned/Planned	PHYS ED (FEMALE)-WR (F) 0721 (0.5 Cr)	PHYS ED 10 5730 (0.5 Cr)	PHYS ED 11 5740 (0.5 Cr)	Add +
Health 0.5 Credits Required 0.5 Credits Earned/Planned		HEALTH 0735 (0.5 Cr)		Add +
Arts/Humanities 2 Credits Required 2 Credits Earned/Planned	JOURNALISM: FUND WRIT/ETH 0170 (0.5 Cr) HON GERMAN 3 0536 (1 Cr) ART MEDIA 0762 (0.5 Cr)			Add +
STEM 1 Credit Required 1 Credit Earned/Planned			AP/CHS PSYCHOLOGY 0276 (1 Cr)	Add +
Electives 4.5 Credits Required 6.9 Credits Earned/Planned	↓SYMPHONIC BAND 0920 (1 Cr)	↓ADV CREATIVE WRITING 0175 (0.5 Cr) ↓HON GERMAN 4 0537 (1 Cr) ↓SYMPHONIC BAND 0920 (1 Cr)	↓CHS SPEECH 0172 (0.5 Cr) ↓AP/CHS BIOLOGY 0436 (1.4 Cr) ↓POTTERY/CERAMIC TECH 0772 (0.5 Cr) ↓SYMPHONIC BAND 0920 (1 Cr)	Add +
Substitute Elective #1 Course cancellations and conflicts are possible. Please select four (4) substitute electives to ensure a complete schedule.				Add +
Substitute Elective #2				Add +
Substitute Elective #3				Add +
Substitute Elective #4				Add +
Full-time Cyber & Release Choose Fall, Spring or both depending on course selections.				Add +

Career Pathway





Industry and Engineering Technology



[Click here for career pathway information](#)

Course Registration Mode

Grades 9-12

Required Courses	Grade 12 
	6 Credits Minimum 0 Credits Planned
English	Add +
Social Studies	Add +
Math	Add +
Science	Add +
Physical Education	Add +
Health	Add +
Arts/Humanities	Add +
STEM	Add +
Electives	Add +
Substitute Elective #1  Course cancellations and conflicts are possible. Please select four (4) substitute electives to ensure a complete schedule.	Add +
Substitute Elective #2 	Add +
Substitute Elective #3 	Add +
Substitute Elective #4 	Add +
Full-time Cyber & Release Choose Fall, Spring or both depending on course selections.	Add +

Science class offerings - Mr. Levo (College bound)

► What science classes should I be taking for an engineering/technology path?

Engineering

- *AP Physics (12th grade)*
- *Honors Physics*
- *Physics: Models and interactions*

- *AP Chem*
- *AP Biology*

Engineering/Technology

- *Physics: Models and interactions*

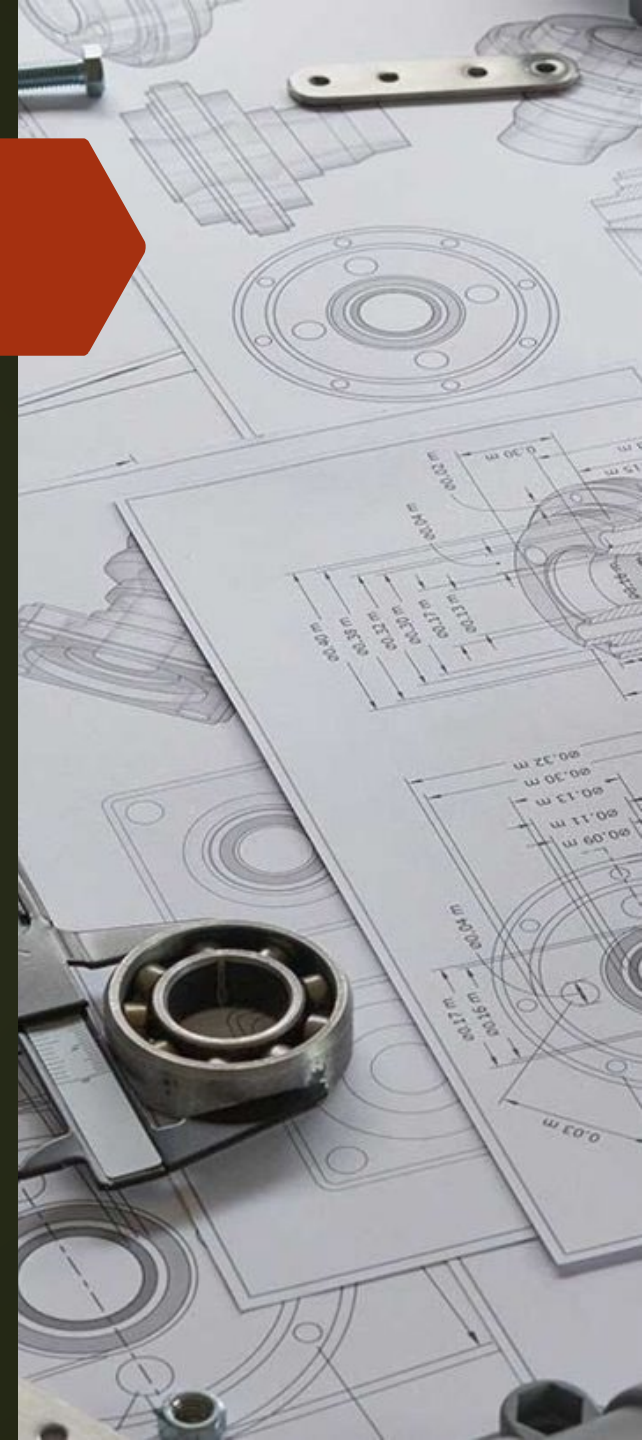

Science class offerings - Mr. Levo (Career/Trade school bound/Elective)

- ❓ What science classes should I be taking if I am considering a path directly into industry or if I need an elective credit for engineering?
- ❓ Physics: Models and interactions
- ❓ Principles of physics (half year)
- ❓ Field Biology (half year)
- ❓ Horticulture (half year)
- ❓ Astronomy 1 and 2 (half year)

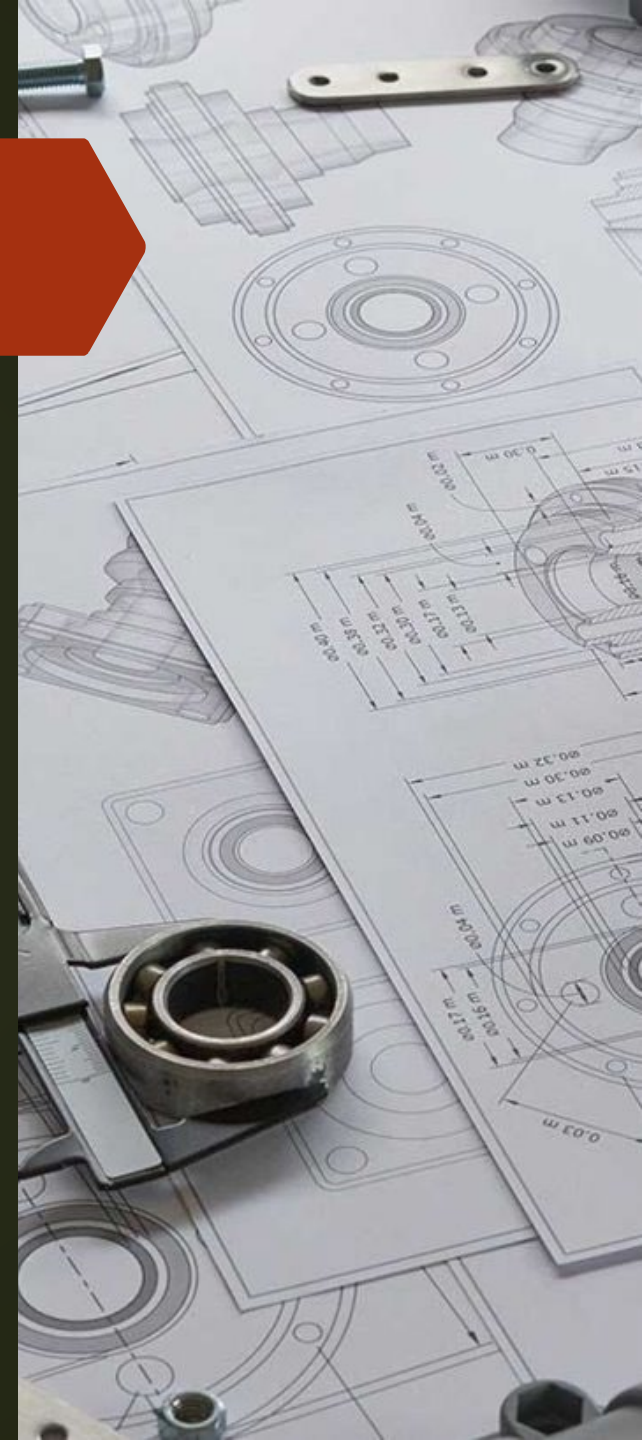

Engineering/Technology

Mr. Fortunato

Thinking About a Career in Engineering or STEM? 🚀

- Explore our **Applied Engineering & Technology** courses and start shaping your future today!
- We offer 15 expertly designed courses, all aligned to provide a cohesive learning experience that will prepare you for any path you choose.

Need Guidance?

- **Ask Us for Help:** Have questions about which course is right for you? Our teachers and counselors are here to help!
- **Review Potential College Courses:** We can also help you explore how these courses align with your future college plans and engineering/STEM degrees.

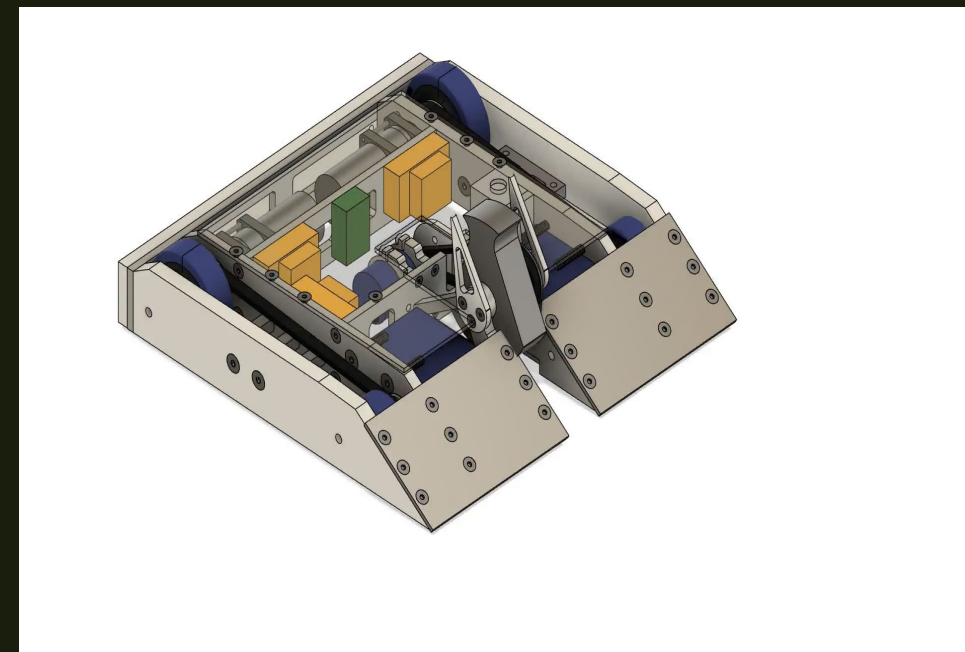

Science/STEM Classes (Blended and Cyber Offerings) **Mr. Macek**

What are my options that best support my pathway with a flexible schedule?

If you want to explore the many careers in gaming, programming, 3D Modeling and Animation...

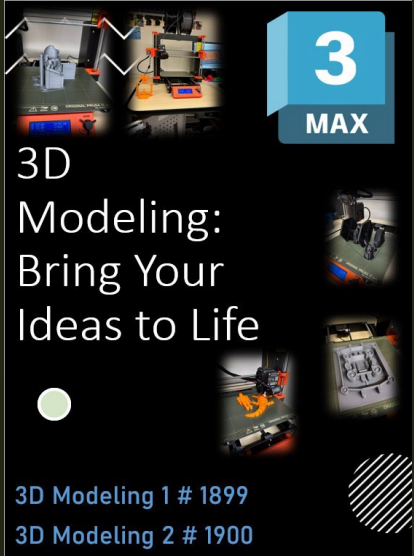

3
MAX

3D Modeling: Bring Your Ideas to Life

3D Modeling 1 # 1899
3D Modeling 2 # 1900

This block features a collage of 3D models and a computer monitor displaying a 3D scene. A blue box with the number '3' and 'MAX' is in the top right. A white circle is in the bottom left, and a hatched circle is in the bottom right.



Motion Capture & Animation: Bring Characters to Life

Mo Cap 1 # 1901
Mo Cap 1 # 1902
CHS Animation # 1904

This block shows a person in a motion capture suit and a computer screen displaying a 3D character model. A white circle is in the bottom left, and a hatched circle is in the bottom right.



Gmemaker & Unity 3D: Code Your Own Games

GameMaker™
GameMaker 1 # 1894
GameMaker 2 # 1895

unity

Unity 3D Programming # 1896
Hon Unity 3D Pro 2 # 1897

This block includes the GameMaker and Unity logos, a white circle in the bottom left, and a hatched circle in the bottom right.



Science/STEM Classes (Blended and Cyber Offerings) **Mr. Macek**

Entertainment cont'd



Software
Game Art
Design: Craft
Visual Worlds

●

Software Game Art Design # 1892



Visual Studio Code

Artificial
Intelligence:
Build Your
Own AI

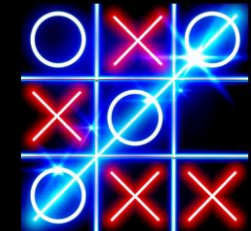

●

Artificial Intelligence #1905



Science/STEM Classes (Blended and Cyber Offerings) **Mr. Macek**

Extending Engineering and Computer Science through cyber learning...

All courses open to students in grades 9-12!

Cyber TECH ED/COMP SCI

Electives

Mr. Macek

Engineering/Technology Courses

Engineering Design (5834)
Introduction to Careers in Architecture and Construction (5851)
Honors Engineering Design 1 (5837)
Honors Engineering Design 2 (5838)
Construction Careers (5886)
Introduction to STEM (5890)

(course number)

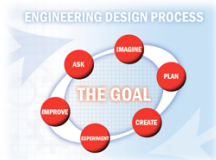

Computer Science Courses

Fundamentals of Computer Systems (5800)
Network System Design (5825)
Software Development Tools (5827)
Intro to Programming (5884)
New Applications: Web Development in the 21st Century (5888)
Fundamentals of Digital Media (5896)
Introduction to Information Technology Support & Services (5897)
Introduction to Network Systems (5898)

SYAOC SOCIAL STUDIES CYBER OPTIONS

5283 HISTORY OF AGRICULTURE - .5 CREDIT

5285 POWER, STRUCTURAL, AND TECHNICAL SYSTEMS - .5 CREDIT

5286 AGRIBUSINESS - .5 CREDIT



Computer Science – Mrs. Koegler

- ❑ 11th & 12th graders can receive a math credit
 - ❑ AP Computer Science Principles
 - ❑ Introduction to Python
 - ❑ CHS Introduction to Programming
 - ❑ AP Computer Science A
(pre-req is CHS Introduction to Programming)

Thinking of pursuing a career in:

- Engineering
- Robotics

Math

Mr. Magill

- 11th & 12th Grade Options
- Engineering of any Kind
 - Honors Precalculus; CHS Precalculus
 - AP Calculus AB; AP Calculus BC
 - Some Type of Programming
- Technology
 - Algebra 2; Honors Algebra 2
 - Honors Precalculus; CHS Precalculus
 - Trigonometry; Intro to Statistics
 - Some type of Programming
- Industry
 - Algebra 2; Honors Algebra 2;
 - Honors Precalculus
 - Trigonometry; Intro to Statistics

In today's creative economy, employers want people who can flex the right side of their brains—that is, those who can think outside the box and use their imaginations.

Visual Arts at SV teach new ways of seeing, thinking and making.

SHS ART CLASSES

DRAWING & (ADVANCED EXPERIENCE DRAWING)

PAINTING & (ADVANCED EXPERIENCE PAINTING)

SENIOR CAREER ART

ART HISTORY

CERAMICS & (ADVANCED EXPERIENCE CERAMICS)

CAREERS

Art Education

Fine Art and Exhibiting Artist

Comic/Graphic Novel Artists

Animators

Graphic Design

Architectural Design

Game Design

Product Design

Museum Curator

Art Therapy

Interior Design

Fashion Design



Engineering is, in many ways, a creative discipline itself, where design and aesthetics play a part in building solutions. Taking Art courses can expand your ability to think outside the box, a trait that is highly valued in the engineering field.

English Options - SENIORS

English Classes for Seniors

- One of the following full year English classes is **required**:
 - Modern Humanities
 - Honors English 12
 - CHS Argument
 - AP Literature

English **Electives** for Seniors

- College in High School is for you!
 - CHS College Writing
 - CHS Speech
- Both courses offer credit through BC3
- Transferrable to many 4 year institutions / required courses
- Fraction of the tuition cost

Social Studies Options – Seniors



- AP Psychology: 1 credit
- Intro. to Psychology: 0.5 credits

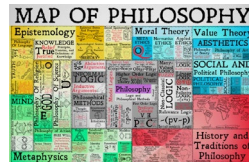

- CHS – Philosophy: 0.5 credits



- AP Economics: 1 credit
- CHS or Regular Economics: 0.5 Credits



The study of the world around us

- CHS – Sociology: 0.5 credits



- Diverse Voices in US History:

.05 credits *11th grade elective – 12th SS credit



- Criminal Investigations

0.5 credits *Elective Only

- * Advanced Experience Criminal Investigations

0.5 Credits *Elective Only



- AP Government: 1 credit
- Honors or Regular Government: 0.5 credits

VOCATIONAL TECHNICAL

- ▶ Vo-Tech requests should submit 6.5 credits
- ▶ A separate Vo-Tech application is required for all new Vo-Tech students.
- ▶ Indicate the Vo-Tech program number during registration



INTERNSHIP & EMPLOYMENT

Seniors:

- ▶ 5651 Fall SR Internship and Employment
AND
- ▶ 5652 Spring SR Internship and Employment (This course meets your Social Studies requirement)

Juniors:

- ▶ 5649 Fall JR Internship and Employment
AND
- ▶ 5650 Spring JR Internship and Employment



SUBSTITUTE COURSES

The substitute course section of the registration is to be filled in completely

- Substitute courses must be different than the original requests
- Substitutes will be used if a scheduling conflict occurs or if a selected course is closed

Course selection changes may be made through **June 6, 2025**



SUMMER SCHOOL/ENRICHMENT

Registration opens **January 9, 2025**

Acceleration:

- ▶ Do not include the course on your registration form
- ▶ Can only request up to 1.0 credit
- ▶ Letter grades are calculated into each nine weeks of the upcoming school year

Credit Recovery:

- ▶ Pass/Fail courses
- ▶ Grade will be applied to this school year





EARLY RELEASE

Seniors will be eligible to request:

- 9th period early release
- 8th and 9th period early release

But:

- Some class selections will not allow it to happen
- Early release does not guarantee a parking pass
- Class sizes will not be compromised to accommodate for early release
- Must have a minimum of 6.0 credits
- Early Release must be added to your course requests. It appears at the bottom on your registration.

EARLY RELEASE

Electives Add +

Substitute Elective #1 ! Add +
Course cancellations and conflicts are possible. Please select four (4) substitute electives to ensure a complete schedule.

Substitute Elective #2 ! Add +

Substitute Elective #3 ! Add +

Substitute Elective #4 ! Add +

Full-time Cyber & Release Add +
Choose Fall, Sp

x

Grade 12 Release Courses

Off Pathway
 Employee Override

Release							
	Type	Video	Course Num	Course Name	Length	Credits	Mtg Per Week
Add +	Traditional		0001	Release Period 8 Fall		0	
Add +	Traditional		0002	Release Period 8 Spring		0	
Add +	Traditional		0003	Release Period 9 Fall		0	
Add +	Traditional		0004	Release Period 9 Spring		0	
Add +	Cyber		5001	Full-time Cyber Fall		0	
Add +	Cyber		5002	Full-time Cyber Spring		0	

End of Grade 12 Release Courses