

School Consolidation Recommended Plan

Board of Education Work Session
January 6, 2025



School Consolidation Work Sessions

JAN 6

Recommended Plan

- Why Consolidation
- Framework
- Overview of Recommended Plan
- Buildings Timeline

JAN 13

Buildings & Process

- Redistricting
- Transportation
- Building Capacities & Classrooms
- Repurposing Buildings
- Staffing

JAN 27

Students & Instruction

- Special Education
- Teaching & Learning
- Title I
- Support Plan

Why school consolidation?

- **Improve Learning Conditions and Educational Opportunities**
 - Greater number of classes at PTR and improved classroom support.
 - Expanding access to special education programs and services.
 - Increasing availability of nursing, counseling and other student support services.
 - Minimizing staff shortages and unfilled positions.
 - Decreasing the number of combination grade-level classrooms, allowing for more focused instruction.
- **Increase Efficiency**
 - Lower costs for facility maintenance and utilities.
 - Address declining enrollment in a strategic and sustainable way.
 - Redirect resources from maintaining underused buildings to enhancing student learning environments and programs.

Why school consolidation?

- **Long-Term Budget Sustainability**

The district is facing a projected **\$16 million deficit** for FY26. Consolidating schools will reduce operational and maintenance expenses, allowing the district to:

- Protect class sizes.
- Invest in classroom resources.
- Support critical student services.

These changes aim to preserve educational quality while addressing growing financial challenges.

- **Declining Population and Declining Enrollment**

The Fairbanks North Star Borough has experienced a steady population decline, driven by lower birth rates and outward migration.

- Over the past 20 years, student enrollment has dropped by **15%** (2,140 fewer students between FY04 and FY24).
- The number of school buildings has increased, leaving the district to maintain more facilities for fewer students.

School consolidation is a necessary step to align resources with enrollment, ensuring our schools remain strong, sustainable, and focused on delivering the best education for every student.

Current Enrollment Capacity

- **Average Capacity:** Elementary schools in the district are currently operating at an average of **67% capacity**.
- **Recommended Capacity:** For best efficiency and educational programming, schools should operate at **85% capacity or higher**.
- **Why It Matters:** Running schools at a recommended capacity means that a greater portion of every dollar spent directly supports students and learning instead of underused buildings - it also means stronger educational programs.

Current School Capacity (Dec 6, 2024)					
SCHOOL	Gross School Sq .Ft.	DEED CAPACITY	Dec 6, 2024 Enrollment	Seats Available	Current % Capacity
Anderson Crawford	63,532	553	362	191	65%
Anne Wien Elementary	63,532	553	367	186	66%
Arctic Light Elementary	68,272	596	367	229	62%
Barnette Elementary	54,895	417	413	4	99%
Denali Elementary	49,210	422	304	118	72%
Hunter Elementary	57,047	494	326	168	66%
Ladd Elementary	63,455	553	375	178	68%
Midnight Sun Elementary	61,686	537	325	212	61%
North Pole Elementary	57,154	495	314	181	63%
Pearl Creek Elementary	62,982	548	386	162	70%
Salcha Elementary	13,608	76	61	15	80%
Ticasuk Brown Elementary	63,761	556	344	212	62%
Two Rivers Elementary	22,200	98	69	29	70%
University Park Elementary	64,699	564	375	189	66%
Weller Elementary	65,259	569	410	159	72%
Woodriver Elementary	64,408	561	348	213	62%
Schools Sub-total		7592	5146	2446	68%

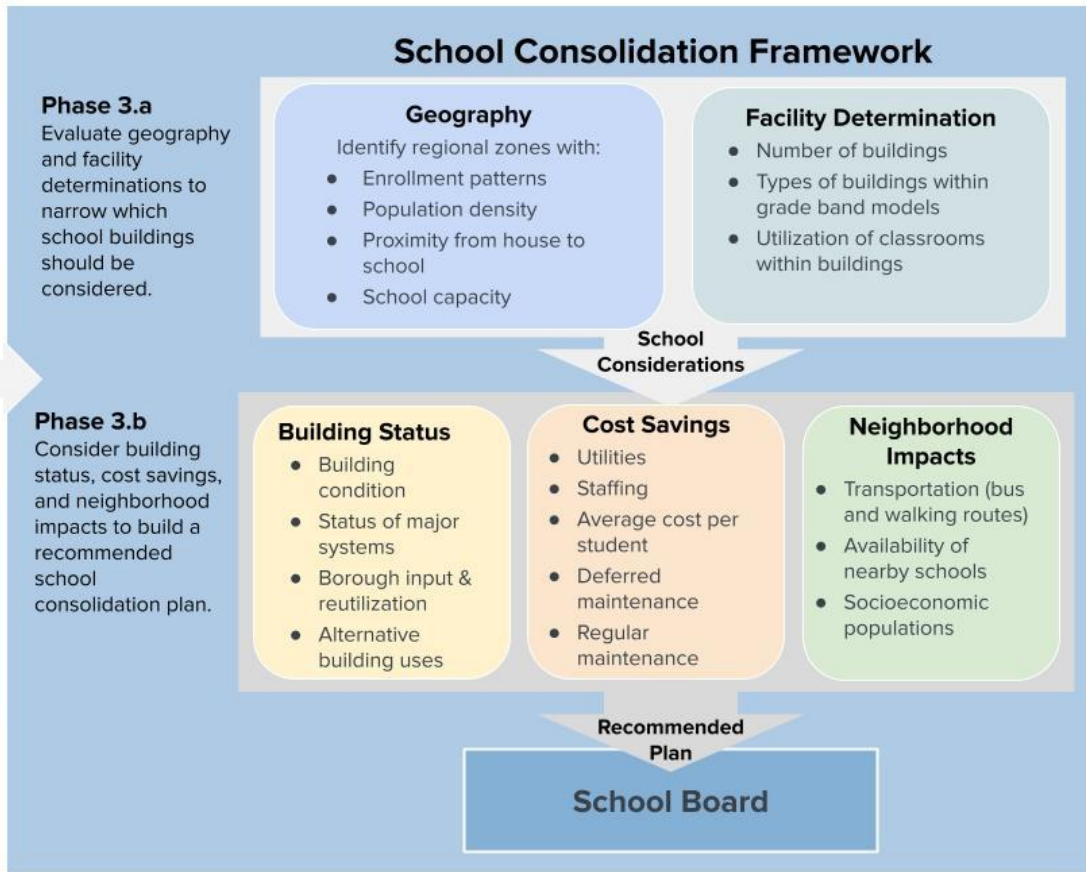

Age 0-4 Population Density

- Analysis of age 0-4 population percentages from the 2022 U.S. Census
- Schools with the highest age 0-4 population density:
 - Anderson-Crawford Elementary
 - Ticasuk Brown Elementary
 - University Park Elementary
 - Woodriver Elementary
- Ft. Wainwright populations have high preschool-age densities, impacting Ladd and Arctic Light Elementaries.

2022 Age 0-4 Populations

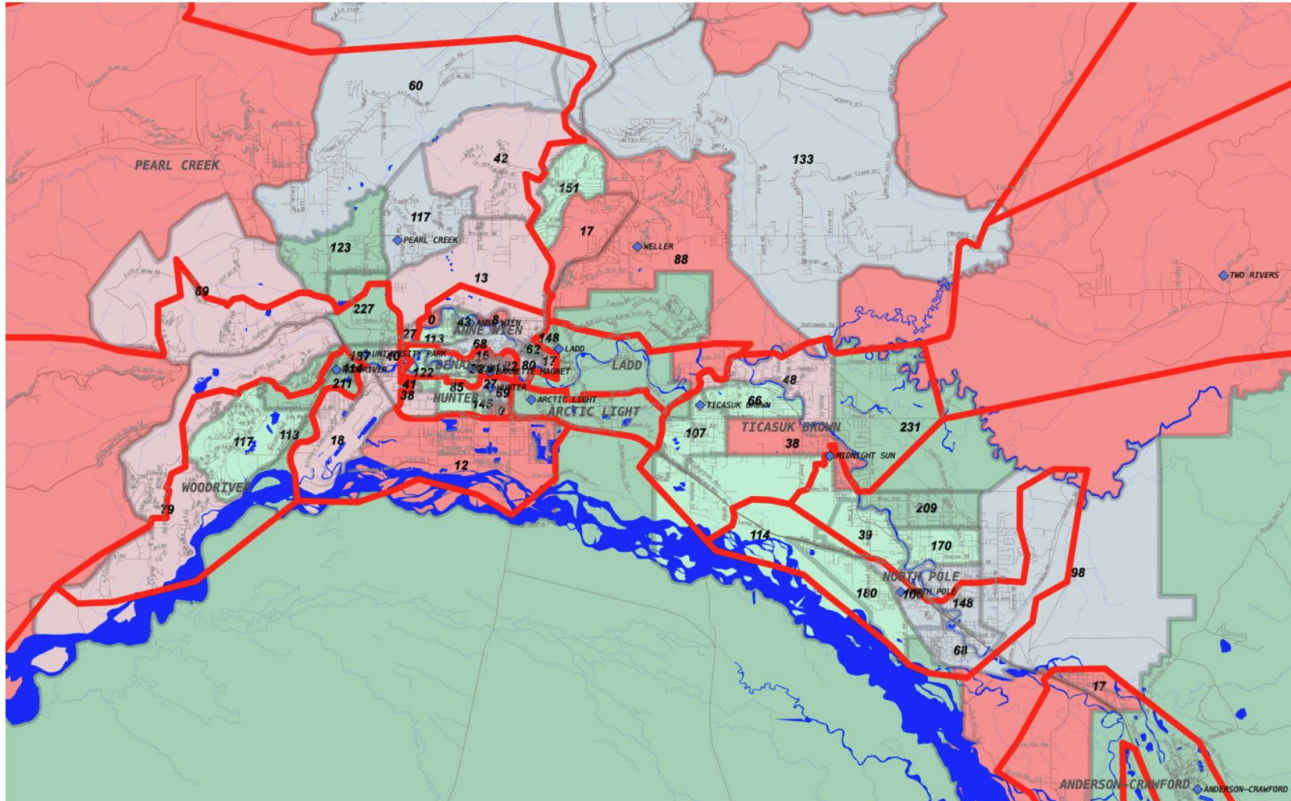

Questions?



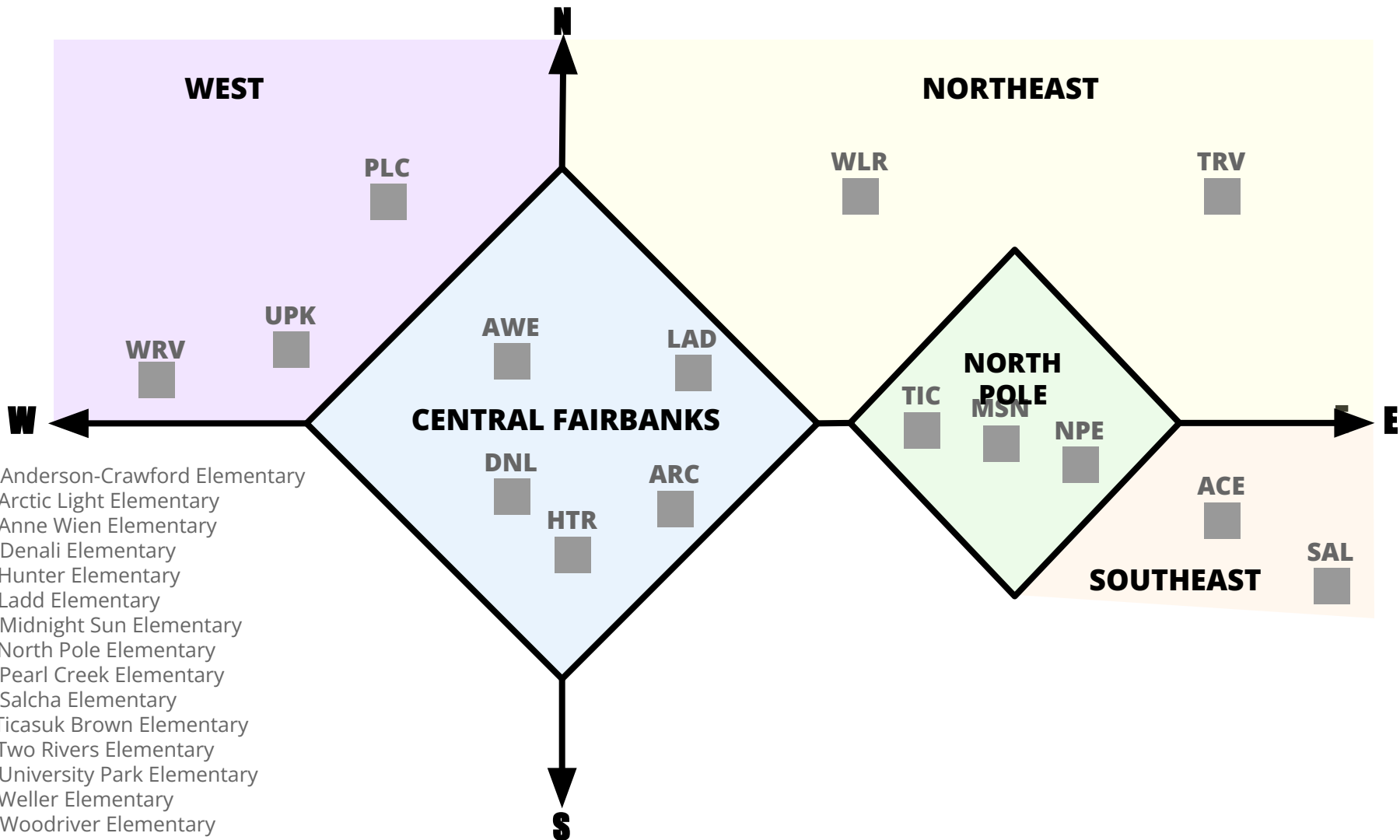

- ACE:** Anderson-Crawford Elementary
- ARC:** Arctic Light Elementary
- AWE:** Anne Wien Elementary
- DNL:** Denali Elementary
- HTR:** Hunter Elementary
- LAD:** Ladd Elementary
- MSN:** Midnight Sun Elementary
- NPE:** North Pole Elementary
- PLC:** Pearl Creek Elementary
- SAL:** Salcha Elementary
- TIC:** Ticasuk Brown Elementary
- TRV:** Two Rivers Elementary
- UPK:** University Park Elementary
- WLR:** Weller Elementary
- WRV:** Woodriver Elementary

Recommended School Consolidation Plan

- **Southeast Region:** Close Salcha Elementary
- **Northeast Region:** Close Two Rivers Elementary
- **North Pole Region:** Close Midnight Sun Elementary
- **Central Fairbanks Region:** Close Hunter Elementary
- **West Region:** Close Pearl Creek Elementary

Southeast Region

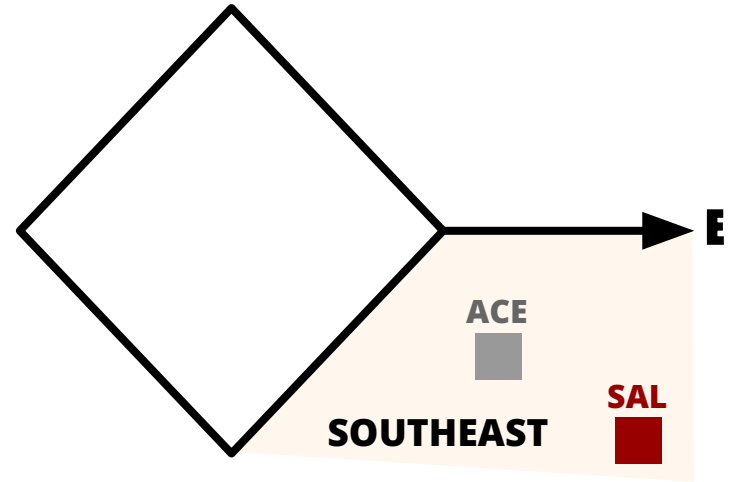

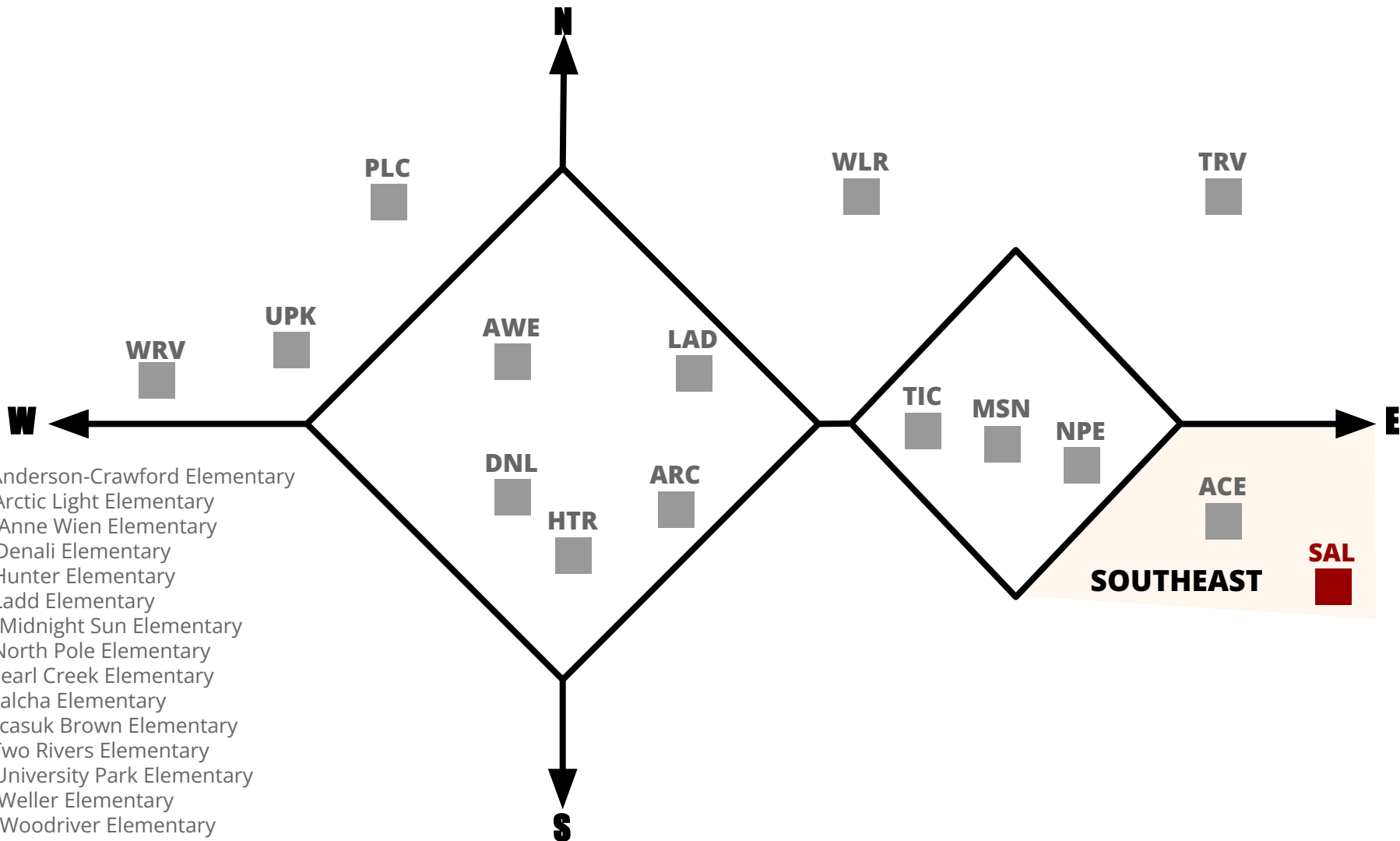

- ACE:** Anderson-Crawford Elementary
- ARC:** Arctic Light Elementary
- AWE:** Anne Wien Elementary
- DNL:** Denali Elementary
- HTR:** Hunter Elementary
- LAD:** Ladd Elementary
- MSN:** Midnight Sun Elementary
- NPE:** North Pole Elementary
- PLC:** Pearl Creek Elementary
- SAL:** Salcha Elementary
- TIC:** Ticasuk Brown Elementary
- TRV:** Two Rivers Elementary
- UPK:** University Park Elementary
- WLR:** Weller Elementary
- WRV:** Woodriver Elementary

Southeast Region

The school closed in the Southeast Region is **Salcha Elementary**.

- Phase 3.B Factors:
 - Low and declining enrollment
 - Capacity at closest elementary school
 - Consistent staffing challenges
 - Limited transportation impact
 - Cost per student
 - Cost savings: \$1.0 million
- Students would move to **Anderson-Crawford Elementary**.

Transition Plan

- **Salcha Elementary** attendance areas are redistributed to **Anderson-Crawford Elementary**.

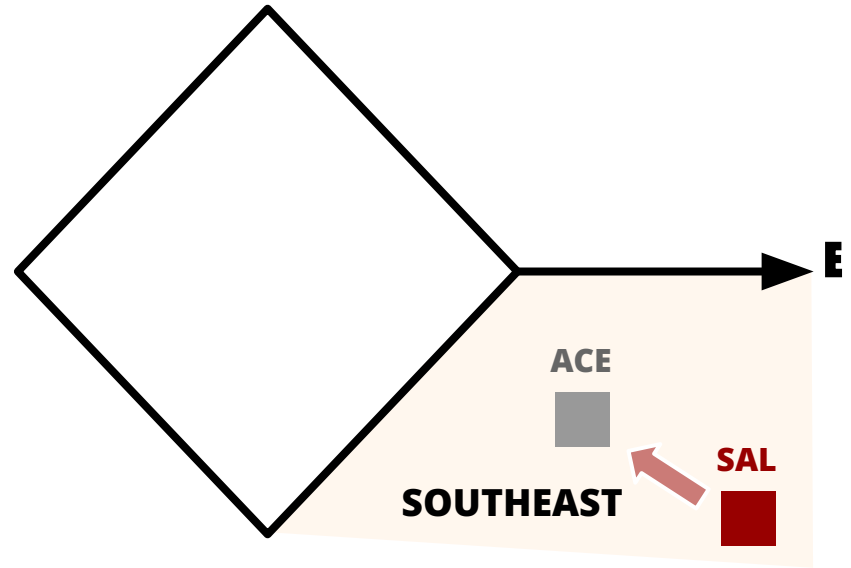

Southeast Region: Enrollment Changes

	Salcha Elementary (SAL)	Anderson-Crawford Elementary	
		SAL OPEN	SAL CLOSED
Enrollment	61	362	424
Seats Available	15	191	129
% Capacity	80%	65%	77%

Enrollment numbers as of December 6, 2024

Questions?



Northeast Region

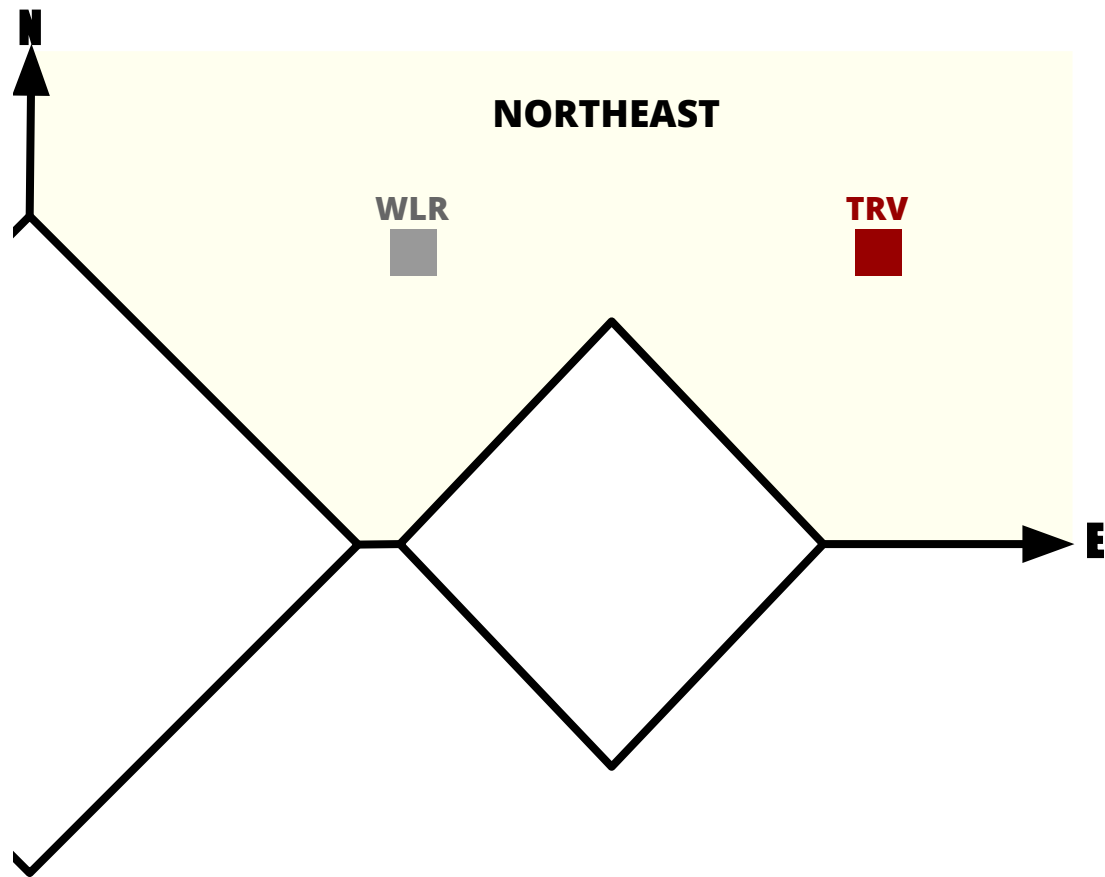

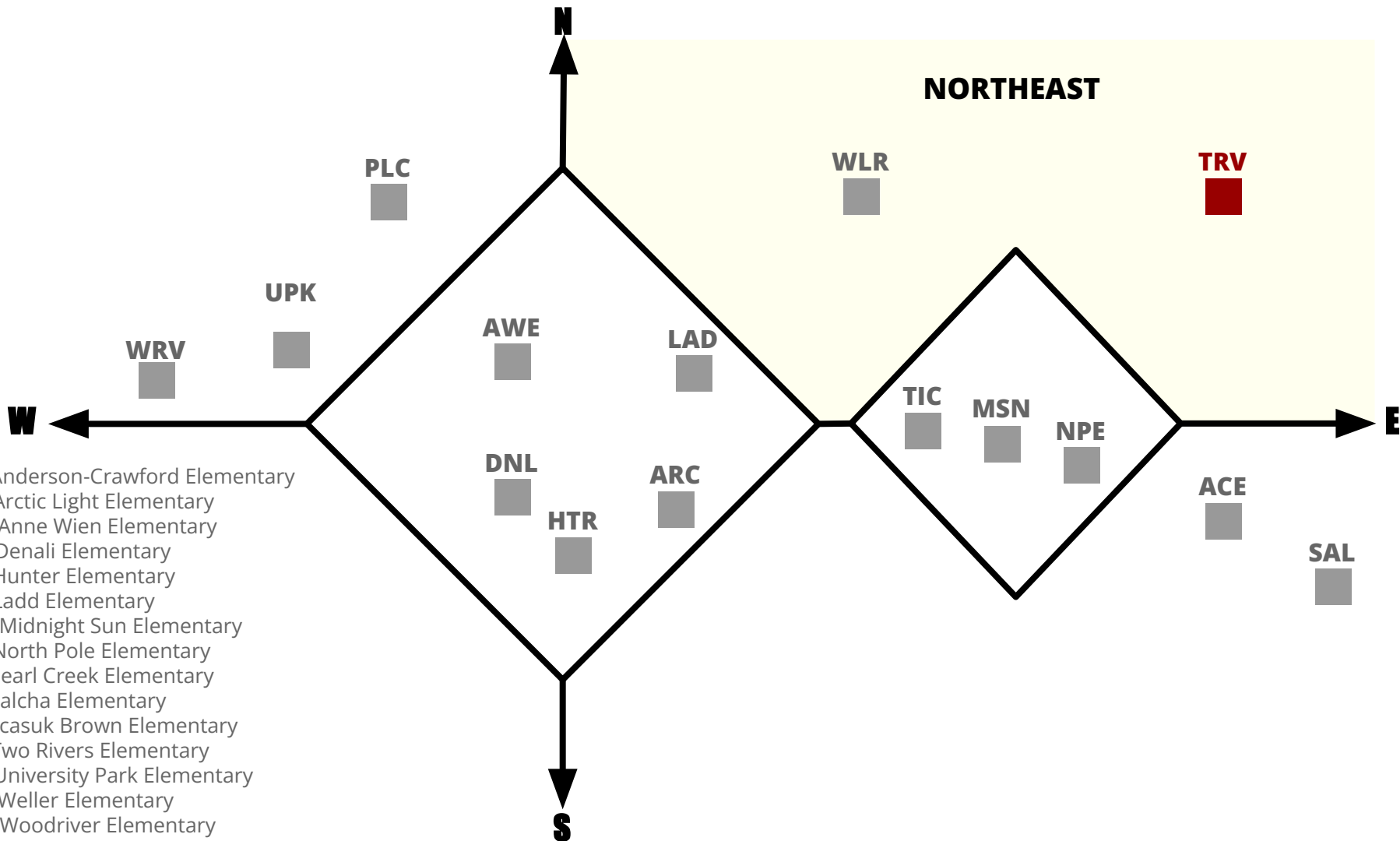

Northeast Region

The school closed in the Northeast Region is **Two Rivers Elementary**.

- Phase 3.B Factors:
 - Low and declining enrollment
 - Capacity at closest elementary school
 - Consistent staffing challenges
 - Limited transportation route impact
 - Cost per student
 - Cost savings: \$1.1 million
- Students would move to **Weller Elementary** (grades K-5) and **Tanana Middle** (grades 6-8).

Transition Plan

- **Two Rivers Elementary** grades K-5 attendance areas are redistributed to **Weller Elementary**.
- **Two Rivers Elementary** grades 6-8 attendance areas are redistributed to **Tanana Middle**.

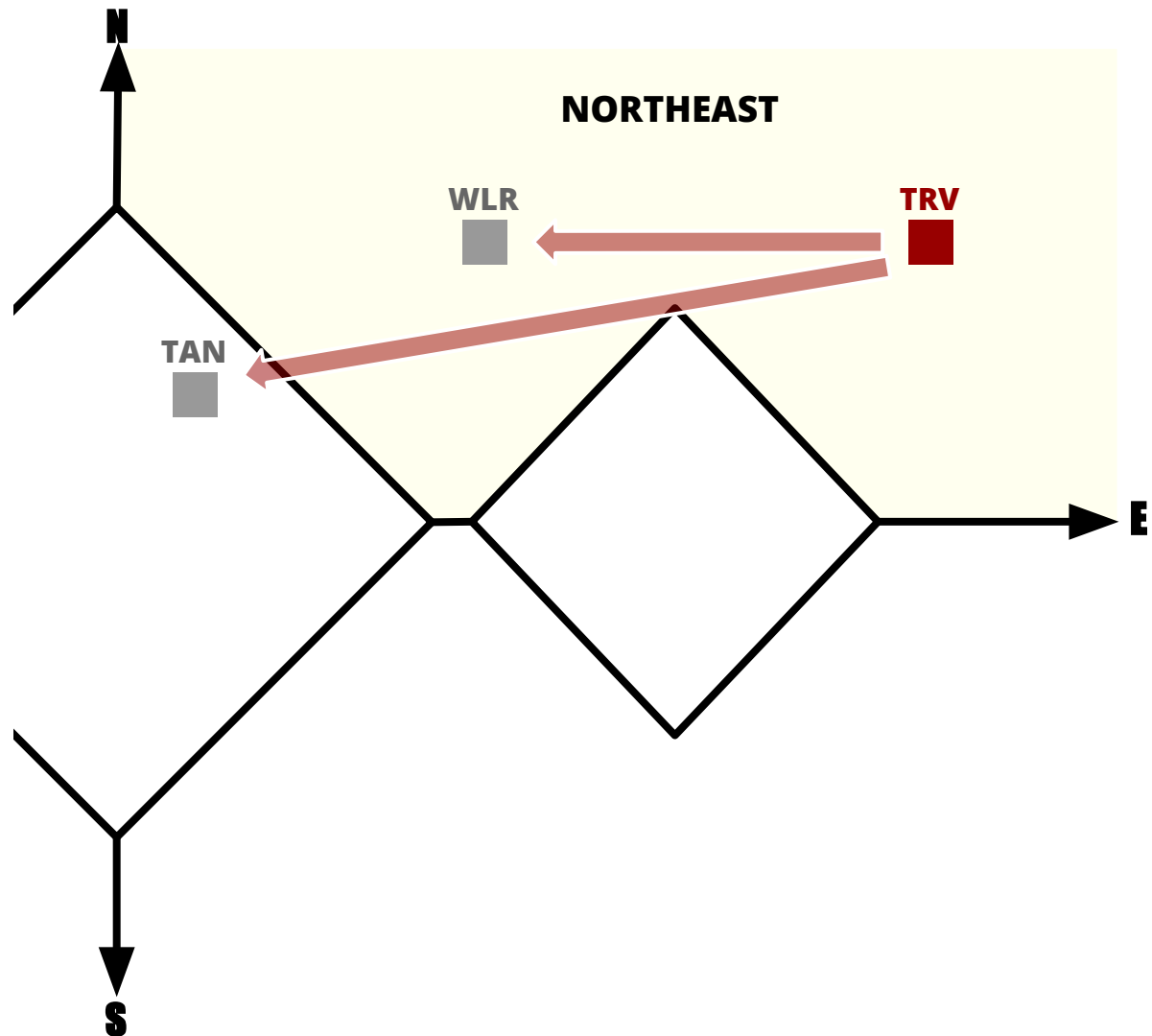

Northeast Region: Enrollment Changes

	Two Rivers Elementary (TRV)	Weller Elementary		Tanana Middle	
		TRV OPEN	TRV CLOSED*	TRV OPEN	TRV CLOSED*
Enrollment	69	410	482	510	530
Seats Available	29	159	87	92	72
% Capacity	70%	72%	85%	85%	88%

*Includes impact of all recommended school closures
Enrollment numbers as of December 6, 2024

Questions?



North Pole Region

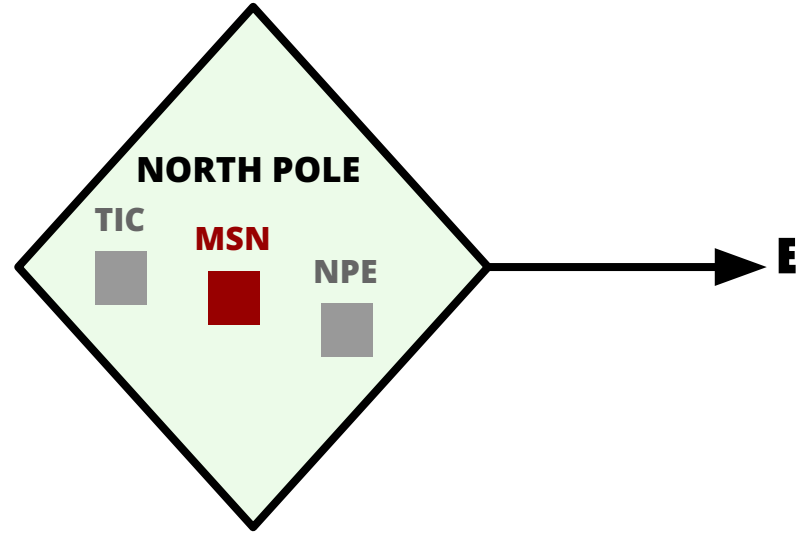

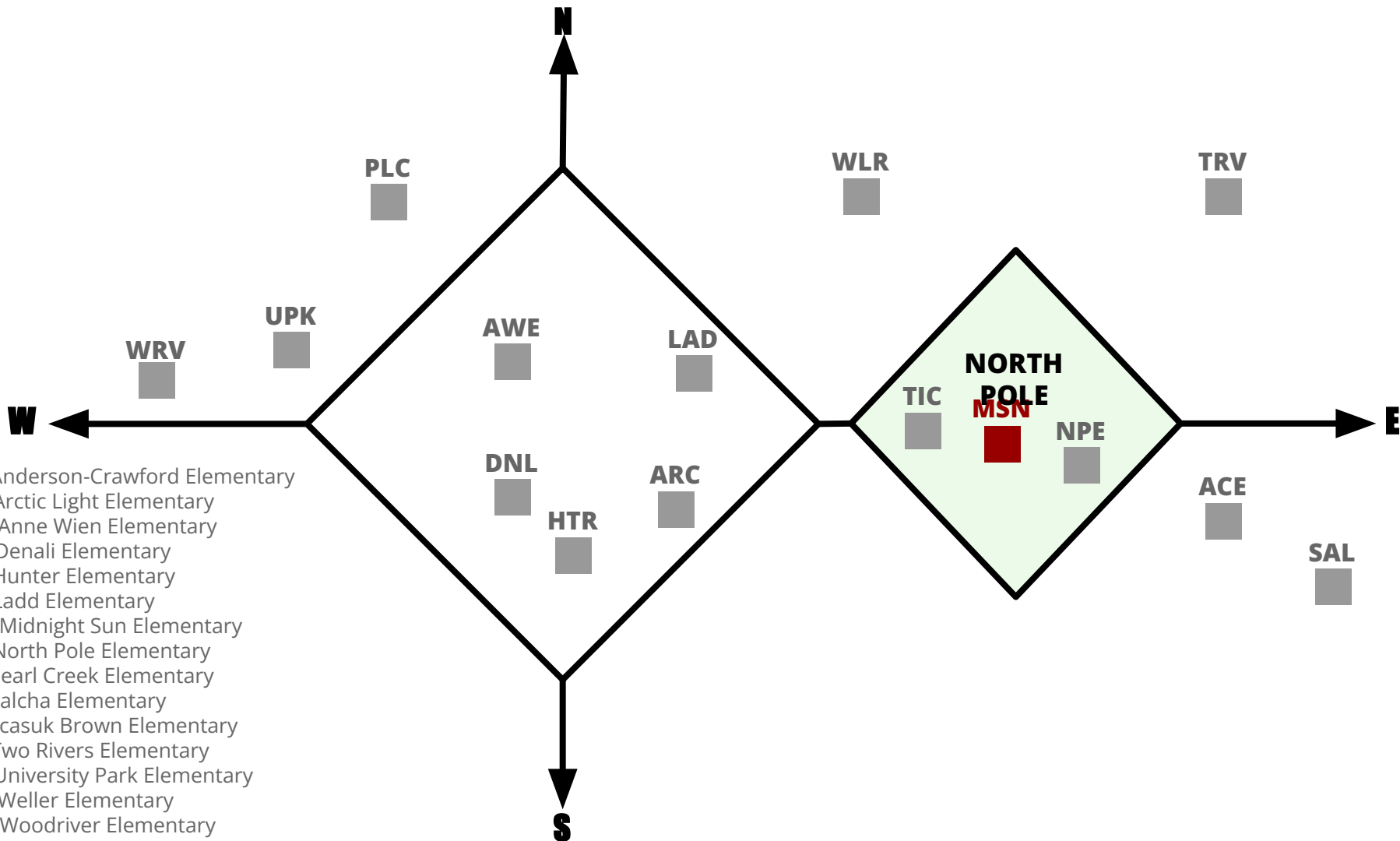

North Pole Region

The school closed in the North Pole Region is **Midnight Sun Elementary**.

- Phase 3.A Factor:
 - Best geographic location to repurpose a building
- Phase 3.B Factors:
 - The building would be repurposed for Star of the North, Child Find, BEST family meetings and potentially other district programs.
 - Avoids moving students to Fort Wainwright - Arctic Elementary
 - Reduced impact to low socioeconomic students
 - Maintains existing feeder system
 - Minimal transportation route impacts
 - Cost savings \$1.5 million
- Students would move to **Ticasuk Brown Elementary** and **North Pole Elementary**.

Transition Plan

- **Midnight Sun Elementary** attendance areas are redistributed to **Ticasuk Brown Elementary** and **North Pole Elementary**.

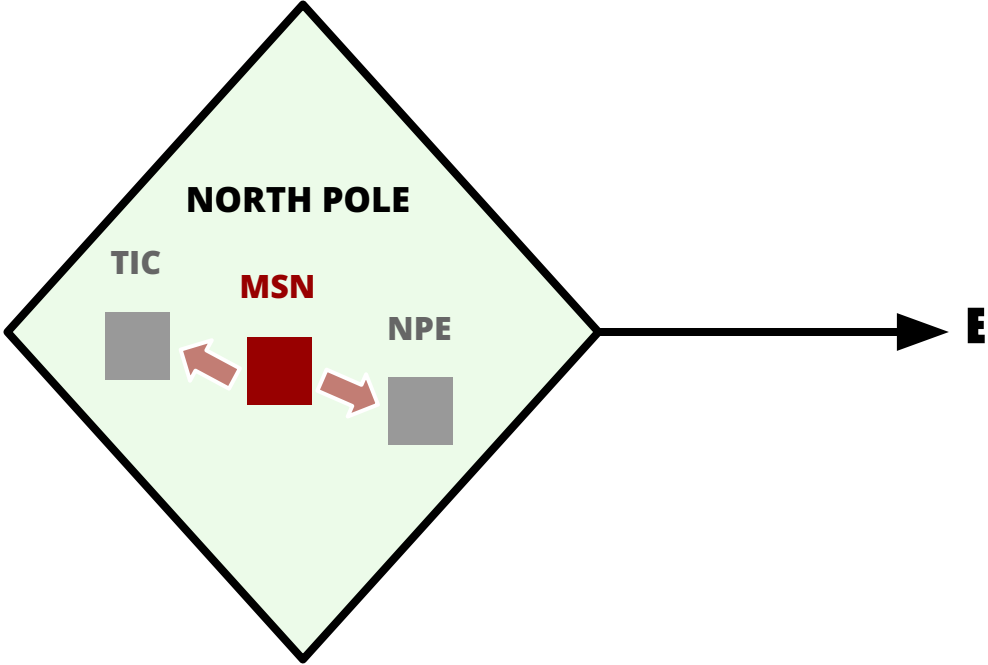

North Pole Region: Enrollment Changes

	Midnight Sun Elementary (MSN)	Ticasuk Brown Elementary		North Pole Elementary	
		MSN OPEN	MSN CLOSED	MSN OPEN	MSN CLOSED
Enrollment	325	344	505	314	472
Seats Available	212	212	51	181	23
% Capacity	61%	62%	91%	63%	95%

Enrollment numbers as of December 6, 2024

Questions?



Central Fairbanks Region

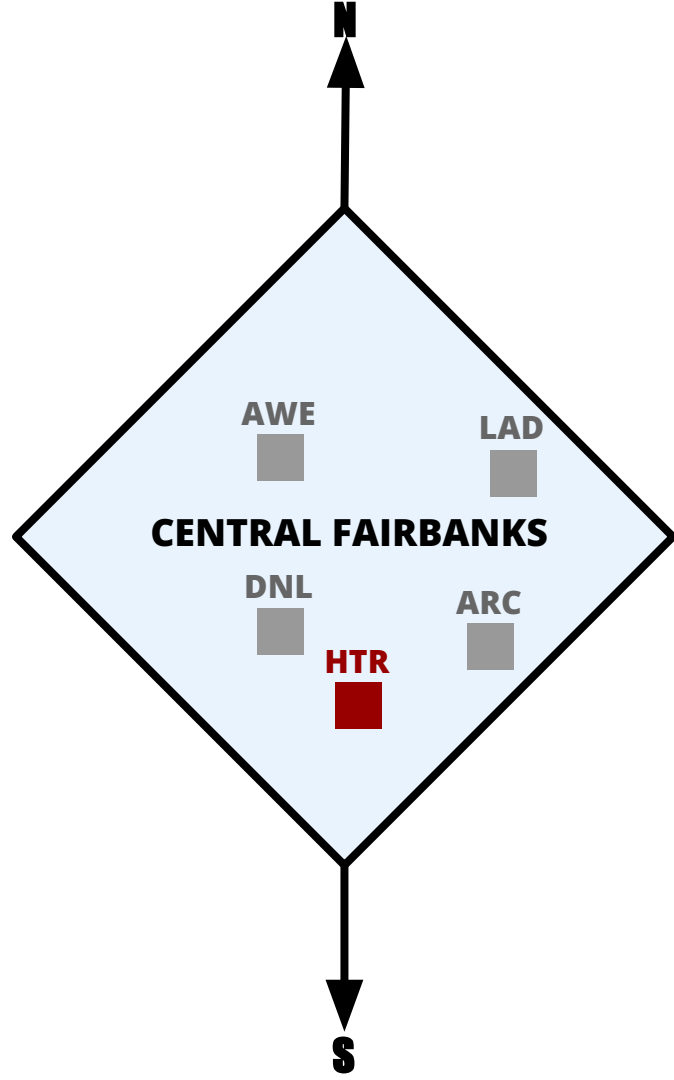

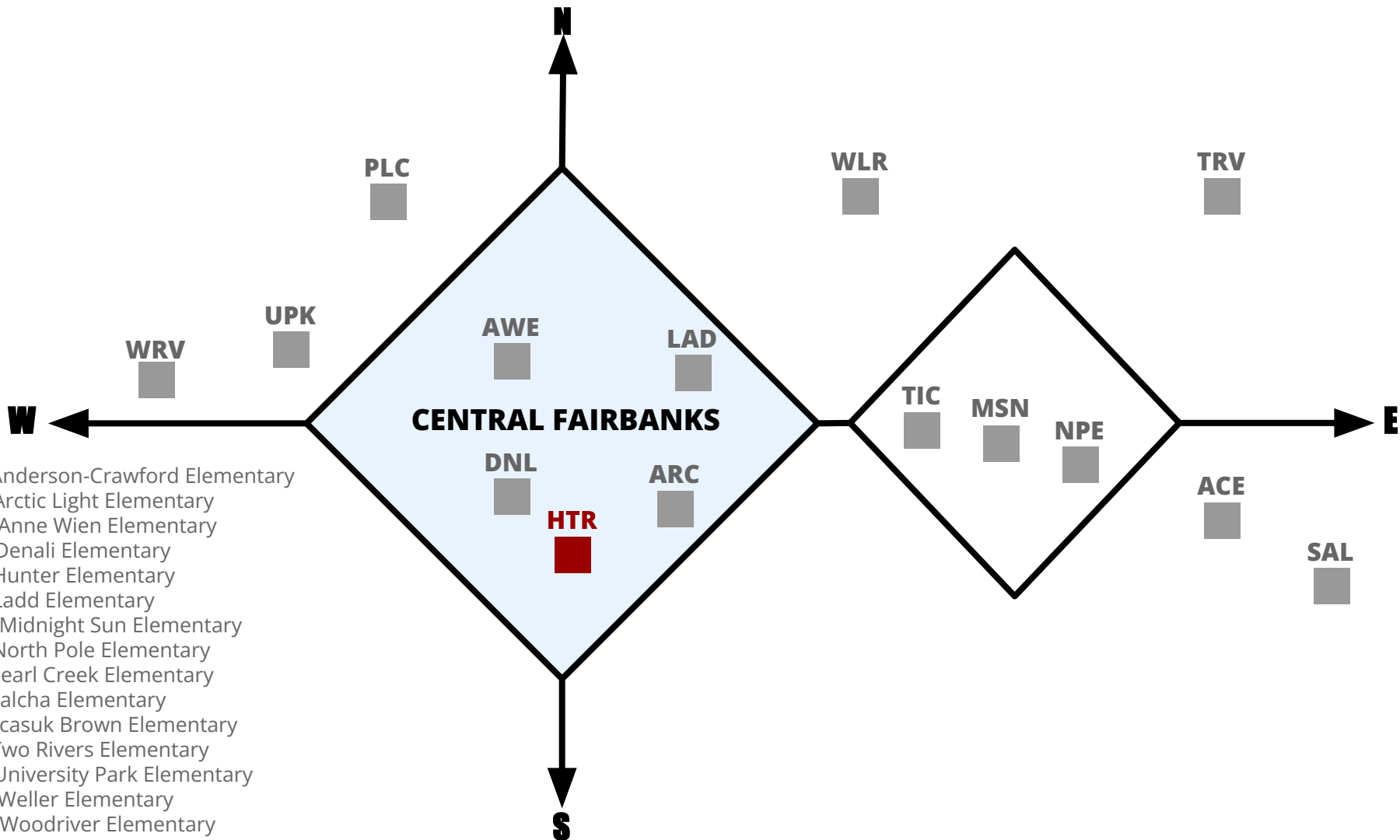

- ACE:** Anderson-Crawford Elementary
- ARC:** Arctic Light Elementary
- AWE:** Anne Wien Elementary
- DNL:** Denali Elementary
- HTR:** Hunter Elementary
- LAD:** Ladd Elementary
- MSN:** Midnight Sun Elementary
- NPE:** North Pole Elementary
- PLC:** Pearl Creek Elementary
- SAL:** Salcha Elementary
- TIC:** Ticasuk Brown Elementary
- TRV:** Two Rivers Elementary
- UPK:** University Park Elementary
- WLR:** Weller Elementary
- WRV:** Woodriver Elementary

Central Fairbanks Region

The school closed in the Central Fairbanks Region is **Hunter Elementary**.

- Phase 3.B Factors:
 - Older building with major systems that are at end of life
 - Significantly lower age 0-4 population
 - Steep decline in enrollment this school year
 - Cost savings of \$1.7 million
- Students would move to **Denali Elementary, University Park Elementary, and Ladd Elementary**.
- Opportunity to expand Barnette Magnet's walk zone.

Transition Plan

- **Hunter Elementary** attendance areas are redistributed to **Denali Elementary**, **Ladd Elementary**, and **University Park Elementary**.
- The **Barnette Magnet** walk zone is increased, shifting some students from **Denali Elementary**.

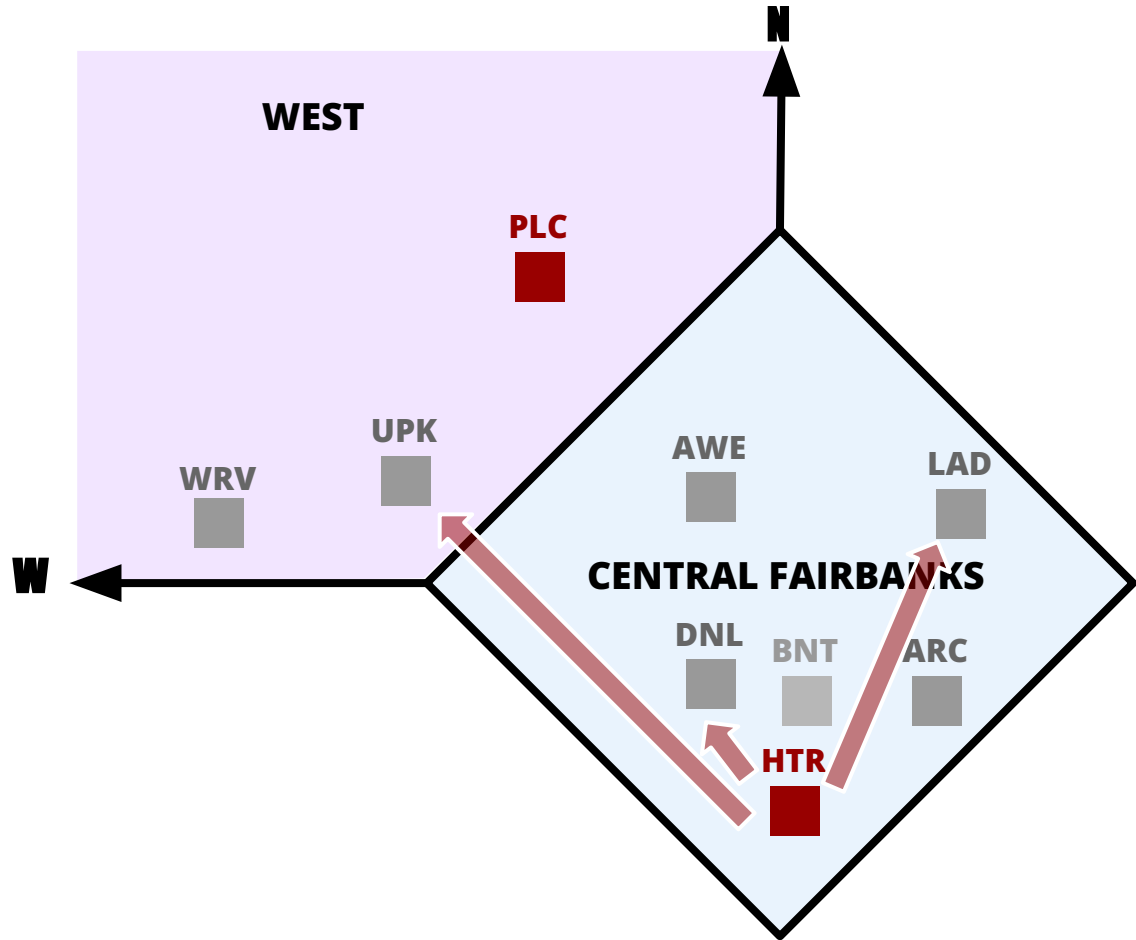

Central Fairbanks Region: Enrollment Changes

	Hunter Elementary (HTR)	Denali Elementary		Ladd Elementary		University Park Elementary	
		HTR OPEN	HTR CLOSED*	HTR OPEN	HTR CLOSED*	HTR OPEN	HTR CLOSED*
Enrollment	326	304	380	375	497	375	498
Seats Available	168	118	42	178	56	189	66
% Capacity	66%	72%	90%	68%	90%	66%	88%

*Includes impact of all recommended school closures
Enrollment numbers as of December 6, 2024

Questions?



West Region

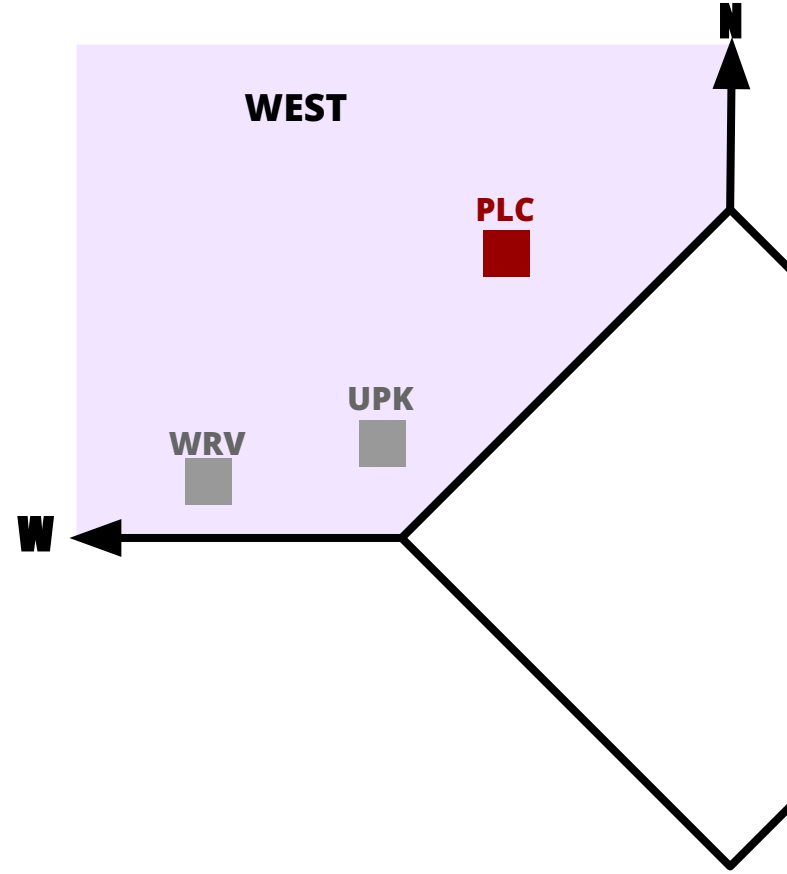

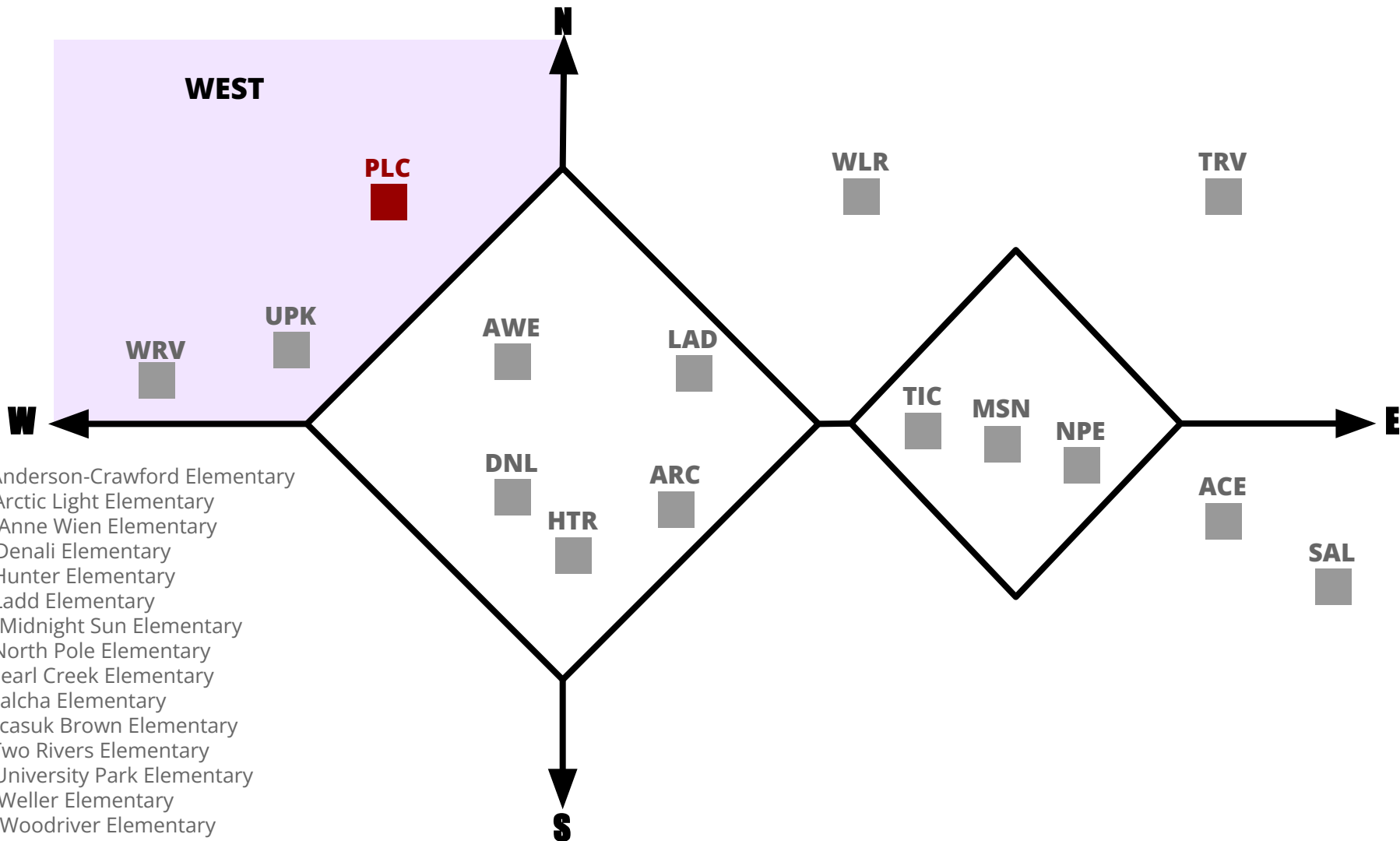

- ACE:** Anderson-Crawford Elementary
- ARC:** Arctic Light Elementary
- AWE:** Anne Wien Elementary
- DNL:** Denali Elementary
- HTR:** Hunter Elementary
- LAD:** Ladd Elementary
- MSN:** Midnight Sun Elementary
- NPE:** North Pole Elementary
- PLC:** Pearl Creek Elementary
- SAL:** Salcha Elementary
- TIC:** Ticasuk Brown Elementary
- TRV:** Two Rivers Elementary
- UPK:** University Park Elementary
- WLR:** Weller Elementary
- WRV:** Woodriver Elementary

West Region

The school closed in the West Region is **Pearl Creek Elementary**.

- Phase 3.B Factors:
 - Minimal walkzone
 - Minimal impact to low socioeconomic populations
 - Greatest amount of major systems at end of life due to deferred maintenance
 - Low age 0-4 population
 - Maintains existing feeder system
 - Cost savings of \$1.7 million
- Students would move to **Woodriver Elementary, University Park Elementary, Anne Wien Elementary, and Weller Elementary**.

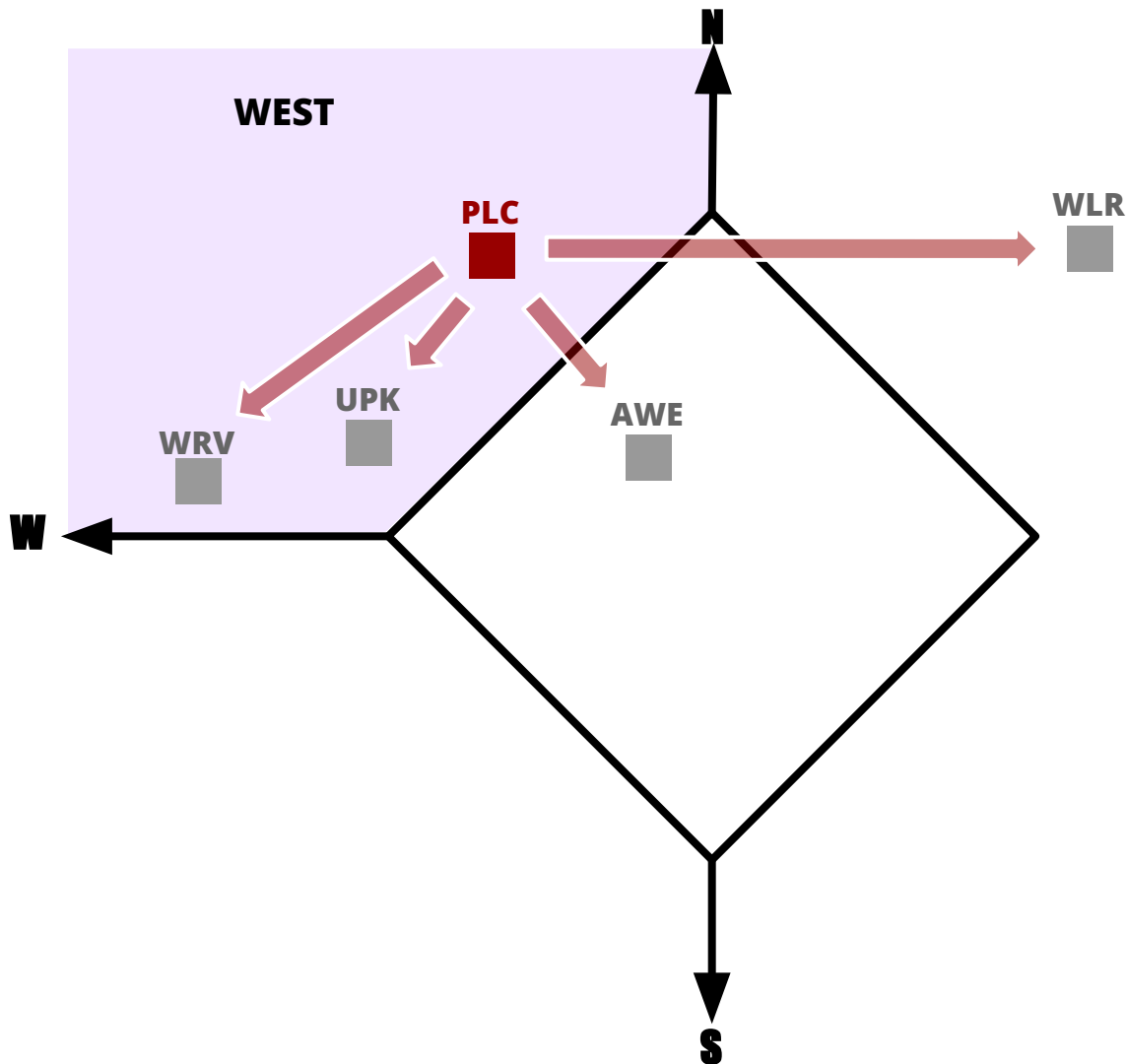

Transition Plan

- **Pearl Creek Elementary** attendance areas are redistributed to **Anne Wien Elementary, University Park Elementary, Woodriver Elementary, and Weller Elementary.**

West Region: Enrollment Changes

	Pearl Creek Elementary (PLC)	Anne Wien Elementary		University Park Elementary		Woodriver Elementary	
		PLC OPEN	PLC CLOSED*	PLC OPEN	PLC CLOSED*	PLC OPEN	PLC CLOSED*
Enrollment	386	367	454	375	498	348	471
Seats Available	162	186	99	189	66	213	90
% Capacity	70%	66%	82%	66%	88%	62%	84%

Weller Elementary	
PLC OPEN	PLC CLOSED*
410	482
159	87
72%	85%

*Includes impact of all recommended school closures
Enrollment numbers as of December 6, 2024

Questions?



Students Impacted by Boundary Changes

Anne Wien Elementary	99
Denali Elementary	50
Hunter Elementary	274
Ladd Elementary	97
Midnight Sun Elementary	276
Pearl Creek Elementary	318
Salcha Elementary	49
Two Rivers Elementary	55
University Park Elementary	48

Total Elementary: 1,266

North Pole High	11
North Pole Middle	2
Randy Smith Middle	25

Total Secondary: 38

Total Students Impacted: 1,304
11% of student body

Example of Cost Savings

Cost savings from closing a school building comes from the following areas:

- Principal
- Music and PE Teachers
- Counselor
- Nurse
- Library Associate
- Administrative & Attendance Secretaries
- Custodians
- Food Service Staff
- Utilities and Maintenance

Cost Savings Summary

Pearl Creek Elementary	\$1.7 million
Hunter Elementary	\$1.7 million
Midnight Sun Elementary	\$1.5 million
Salcha Elementary	\$1.0 million
Two Rivers Elementary	\$1.1 million
Total:	\$7.0 million

FY26 Budget Impact

Projected FY26 Deficit	\$16 million
Contracting Custodians	\$3 million
School Consolidation	\$7 million
Remaining FY26 Deficit:	\$6.0 million

Timeline to Return Buildings to Borough

July 1, 2025	2025-26	2026-27	2027-28
Schools closed and attendance areas changed	Salcha Elementary*	Pearl Creek Elementary <i>(If not repurposed)</i>	Hunter Elementary <i>(If not repurposed)</i>
	Two Rivers Elementary*		

**Recommendation: Repurpose Midnight Sun building for Star of the North, SMART, and a BEST satellite office.

*Option: Salcha & Two Rivers become BEST satellite schools with one certified teacher for each location.

School consolidation is a necessary step to align resources with enrollment, ensuring our schools remain strong, sustainable, and focused on delivering the best education for every student.

What's Next:

JAN 13

Buildings & Process

- Redistricting
- Transportation
- Building Capacities & Classrooms
- Repurposing Buildings
- Staffing

JAN 27

Students & Instruction

- Special Education
- Teaching & Learning
- Title I
- Support Plan

Questions?

