

**UNITED STATES AIR FORCE JROTC**



**OFFICIAL AVIATION QUALIFYING TEST  
INFORMATION PAMPHLET**

**For the  
Chief of Staff of the Air Force Private Pilot Scholarship  
(AFJROTC Flight Academy)**

## **Introduction**

The Aviation Qualifying Test is a compilation of 5 subtests; 4 subtests pulled from the Air Force Officer Qualifying Test (AFOQT) and one ACT/SAT math subtest. The test specifically measures aptitudes used to select candidates for the AFJROTC Flight Academy Program. The subtest scores are combined to generate a composite score. Your composite score is 1 of 5 scoring components used to board applicants (1. Aviation Qualifying Test, 2. Endorsement, 3. Aviation Experience, 4. Physical Fitness, 5. Life Experiences). Additionally, your Aviation Qualifying Test composite score comprises 45% of your overall board score. Therefore, it is imperative that you do your best.

An AQT Practice website has been created and is available at [www.AQTPractice.com](http://www.AQTPractice.com). Feel free to visit this website and provide the link to interested cadets immediately. They may take this practice test as many times as they wish.

## **Scoring**

Your test will be graded on a “percent correct” basis. "Percent Correct" scores will be presented to the Flight Academy for the subtests and for the overall composite. It is important to understand that your score is not measured against a 0-100% scale. Your exam score, as it relates to your selection, is only measured against your fellow cadets who also take this exam. Do your best!

### **CONTROLLED TEST MATERIAL Notice**

Discussing the contents of this test with anyone other than the test administrator is prohibited. Further, discussion, disclosure, or unauthorized possession of CONTROLLED TEST MATERIAL will result in the disqualification of your application.

## **How to Use This Pamphlet**

This pamphlet is designed to familiarize you with examples of the types of questions you will find on each subtest. This pamphlet will not help you “study” for the Aviation Qualifying Test. In fact, because the Aviation Qualifying Test is a test of your general knowledge in several subject areas, there is no “best way” to study for it. The format and style of the questions in this pamphlet are very similar to that of the actual test, although most items in the Aviation Qualifying Test will prove to be more difficult. Taking these practice subtests will give you an idea of what the real test will be like.

For each question, be sure to pick the best one of the possible answers listed. When you have decided which one of the choices is the best answer, write it on a separate piece of paper. The correct answers to the sample questions in this pamphlet are on the last page of this pamphlet (Table 2). If you have any questions about the test after reading this pamphlet, please discuss them with your instructor.

## **Subtest Descriptions**

The subtests and the kinds of knowledge and abilities they measure are described in the sections that follow.

1. Math section (25 questions): Measures your ability to use arithmetic to solve problems.
2. Table Reading (40 questions): Measures your ability to read a table quickly and accurately.
3. Aviation Information (20 Questions): Measures your knowledge of aviation.
4. Instrument Comprehension (25 Questions): Measures your ability to determine the position of an airplane in flight from reading instruments showing its compass direction heading, amount of climb or dive, and degree of bank to right or left.
5. Weight Perception (20 Questions): Measures your ability to reason and see logical relationships between abstract shapes.

**Table 1. Testing Schedule**

	Administration/ Instruction Time (In Minutes)	Testing Time (In Minutes)	Total Time (In Minutes)
<b>Pretest Activities</b>	5		5
Math Knowledge	1	12	13
Table Reading	2	5	7
Instrument Comprehension	3	5	8
Aviation Information	1	8	9
Weight Perception	2	15	17
<b>Collection of Materials</b>	2		2
<b>TOTAL TIME REQUIRED</b>	16	45	61

**What to Expect**

When you arrive for test administration, you will be given complete and specific instructions on how to take the test. The number of questions in each of the subtests and the time you will be given to complete each subtest will vary from subtest to subtest. On most of the subtests, you will likely have more than enough time to answer all the questions. On some subtests, however, you may not finish. Don't worry if this happens, since many people do not finish these subtests. Just work as quickly and accurately as you can.

All of the subtests have multiple-choice questions with four or five possible answers. Each question has only one correct or best answer. If you are not sure of the answer to a question, make a selection anyway, even if you have to guess. Your score on the Aviation Qualifying Test will be based on the number of correct answers you select. You will not lose points or be penalized for guessing.

Before you take some of the subtests, you will have the opportunity to answer some practice questions to be sure that you understand what you are to do on the test. If you are not sure what you are supposed to be doing, ask your test administrator or proctor for help before you start answering the actual test questions. However, test administrators or proctors can only assist you in understanding the directions. They cannot give you guidance concerning test questions and answers or test taking strategy.

It is important that you get a good night's rest before taking the test. You will be asked before you take the test if you are physically able. If you do not feel that you are able to take the test at this time, inform the test administrator and you will be scheduled at a later date. Be relaxed, follow instructions, read each question carefully, and do the best you can.

## Part 1 – Math Knowledge

Directions: The math portion of the AF JROTC Aviation Qualifying Test will focus on the applicant's knowledge of algebraic equations, order of operations, fractions, geometry and probability and statistics. Below is a sample question:

1. The average (arithmetic mean) of  $x$  and  $y$  is 5, the average of  $x$  and  $z$  is 8, and the average of  $y$  and  $z$  is 11. What is the value of  $z$ ?

- a. 2
- b. 5
- c. 7
- d. 14
- e. 28

2. For all integers  $n$ :

$$\boxed{n} = n^2 \quad \text{if } n \text{ is odd}$$

$$\boxed{n} = \sqrt{n} \quad \text{if } n \text{ is even}$$

What is the value of  $\boxed{16} + \boxed{9}$ ?

- a. 7
- b. 25
- c. 85
- d. 97
- e. 337

3. If  $3x+7=12$ , what is the value for  $6x-5$ ?

- a. 5
- b. 10
- c. 12
- d. 17
- e. 19

4. Find the value for  $x$ .

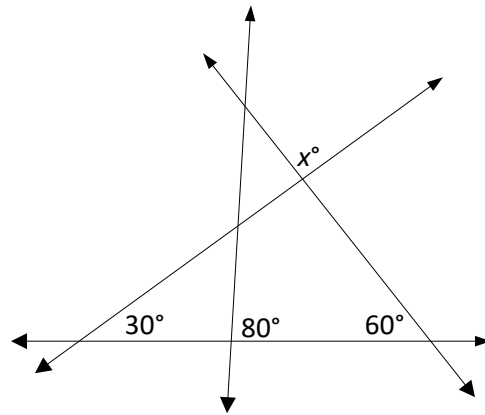

- a. 40
- b. 50
- c. 60
- d. 75
- e. 90

5. If 7 less than 4 times a certain number is 8 more than the number, what is the number?

- a. -5
- b. -11
- c. 3
- d. 5
- e. 25

**PART 2 - Table Reading**

**DIRECTIONS:** This part of the test measures your ability to read a table quickly and accurately. Look at the table below. Notice that the X values appear at the top of the table and the Y values are shown on the left side of the table. The X values are the column values. The Y values are the row values. For each test question, you are given an X and a Y value. Your task will be to find the block where the column and row intersect, note the number that appears there, and then find this number among the five answer options.

		<b>X VALUE</b>						
		-3	-2	-1	0	+1	+2	+3
<b>Y VALUE</b>	+3	25	26	28	30	31	32	33
	+2	26	28	30	32	33	34	35
	+1	27	29	31	33	35	36	37
	0	29	30	32	34	36	37	38
	-1	30	32	33	35	37	38	40
	-2	31	33	34	36	38	39	41
	-3	32	34	35	37	39	40	42

	<b>X</b>	<b>Y</b>	<b>A</b>	<b>B</b>	<b>C</b>	<b>D</b>	<b>E</b>
1.	+1	+2	35	36	30	33	34
2.	0	-3	29	37	39	30	36
3.	-2	+3	26	32	34	28	40
4.	-1	0	33	30	35	36	32
5.	+3	-1	41	27	40	38	39

### Part 3 - Instrument Comprehension

**DIRECTIONS:** This part of the test measures your ability to determine the position of an airplane in flight from reading instruments showing its compass direction heading, amount of climb or dive, and degree of bank to right or left. Each problem consists of two dials and four answer options. In each problem, the left-hand dial is labeled ARTIFICIAL HORIZON. On the face of the dial a stationary indicator in the center represents the airplane, while the positions of the heavy black line, black pointer, and markings along the outer edge vary with changes in the position of the airplane in which the instrument is located.

The heavy black line represents the HORIZON LINE and tilts as the airplane is banked. The white pointer shows the degree of BANK to the right or left. The shaded portions of the instrument face represent the ground.

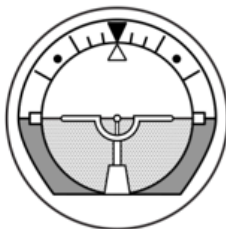

ARTIFICIAL  
HORIZON

**Dial 1**

If the airplane is neither climbing nor diving, the horizon line is directly on the airplane indicator, as in dial 1 above. If the airplane has no bank, the white pointer is seen to point to the black pointer. Dial 1 shows an airplane in straight and level flight.



ARTIFICIAL  
HORIZON

**Dial 2**

If the airplane is climbing, the airplane indicator is seen between the horizon line and the black pointer, as in dial 2 above. The greater the amount of climb, the greater the distance between the horizon line and the airplane indicator. If the airplane is banked to the pilot's right, the white pointer is seen to the right of the black pointer. Dial 2 shows an airplane climbing and banked  $45^\circ$  to the pilot's right.

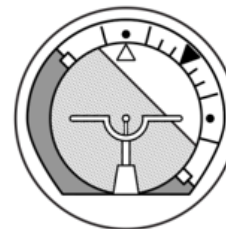

ARTIFICIAL  
HORIZON

**Dial 3**

If the airplane is diving, the horizon line is seen between the airplane indicator and the black pointer, as in dial 3 above. The greater the amount of dive, the greater the distance between the horizon line and the airplane indicator. If the airplane is banked to the pilot's left, the white pointer is seen to the left of the black pointer. Dial 3 shows an airplane diving and banked  $45^\circ$  to the pilot's left.



In each problem the right-hand dial is labeled COMPASS. On this dial, the arrow shows the compass direction in which the airplane is headed. Dial 4 shows the airplane headed north, dial 5 shows it headed west, and dial 6 shows it headed northwest.

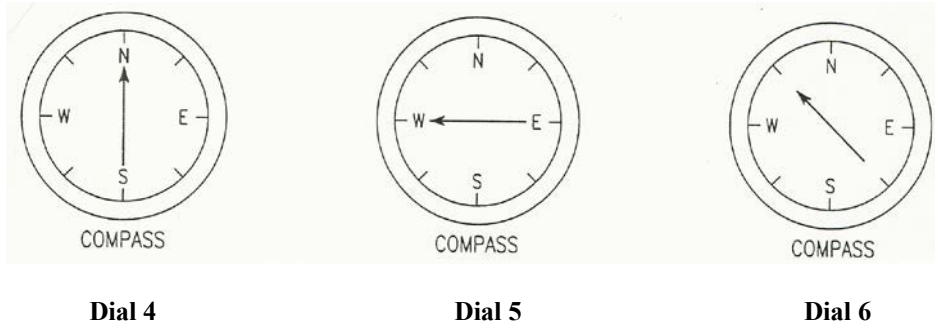

Each problem consists of two dials and four airplanes in flight. Your task is to determine which one of the four airplanes is MOST NEARLY in the position indicated by the two dials. YOU ARE ALWAYS LOOKING NORTH AT THE SAME ALTITUDE AS THE FOUR AIRPLANES. EAST IS ALWAYS TO YOUR RIGHT AS YOU LOOK AT THE PAGE. In the sample question below, the dial labeled ARTIFICIAL HORIZON shows that the airplane is NOT banked, and neither climbing nor diving. The COMPASS shows that it is headed southeast. The only one of the four airplanes that meets these specifications is in the box lettered C; so, the answer to the sample question is C. Note that B is a rear view, whereas D is a front view. Note also that A is banked to the right and that B is banked to the left.

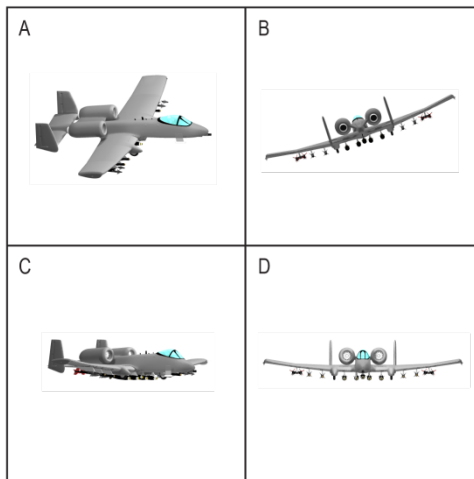
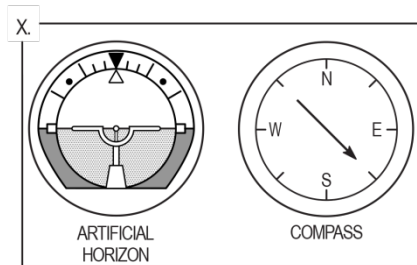

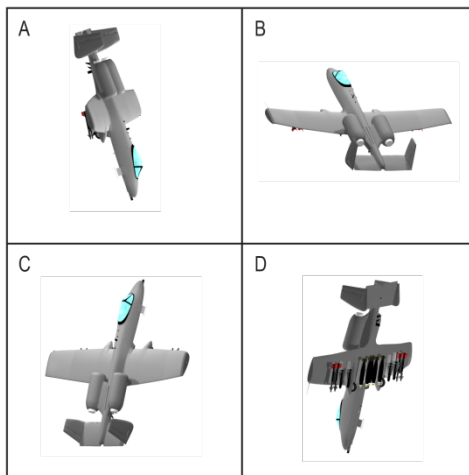
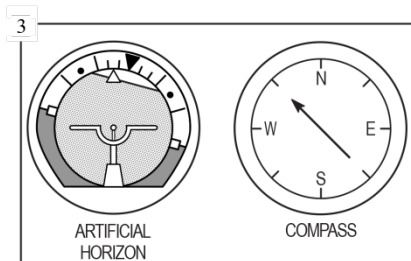
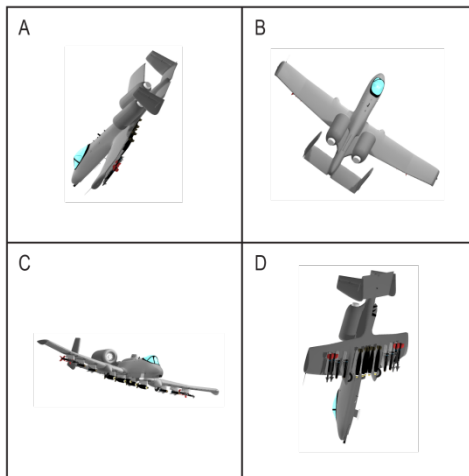
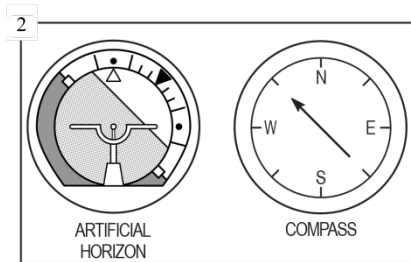
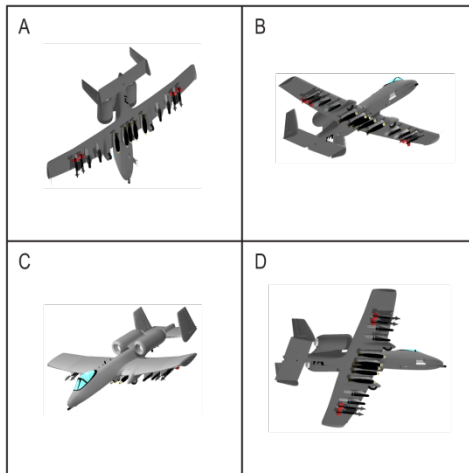
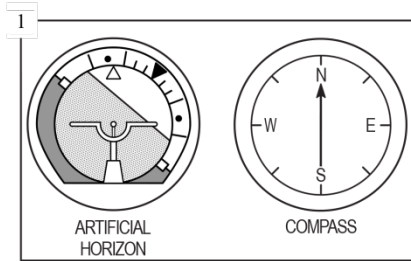

4

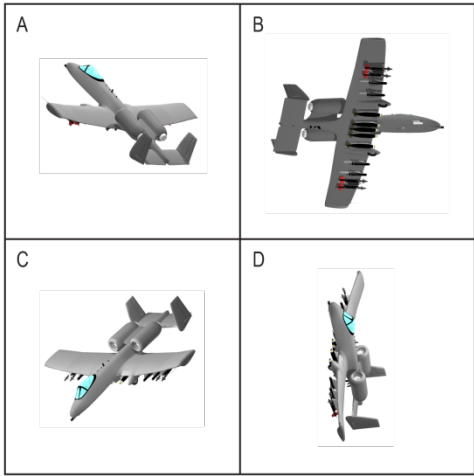
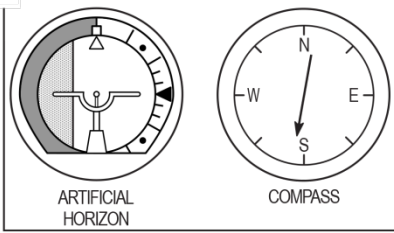

5

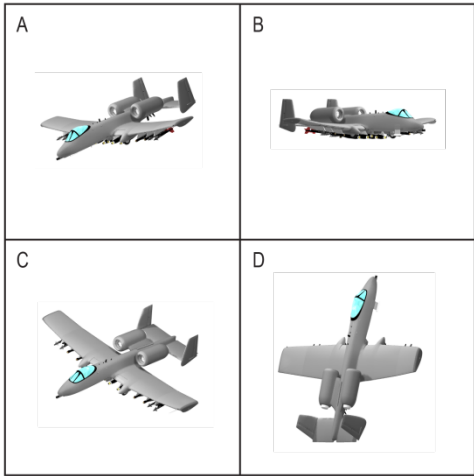
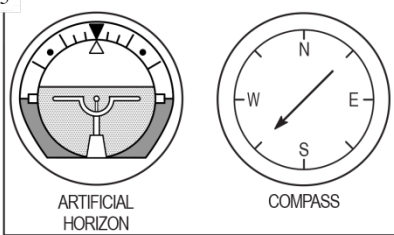

## Part 4 - Aviation Information







**DIRECTIONS:** This part of the test measures your knowledge of aviation. Each of the questions or incomplete statements is followed by five choices. You are to decide which one of the choices best answers the question or completes the statement.

1. The rearward retarding force of airplane drag is opposed by:
  - a. weight
  - b. lift
  - c. thrust
  - d. tension
  - e. compression
  
2. The cowling is located:
  - a. on the landing gear
  - b. around the engine
  - c. close to the tail
  - d. on the wing
  - e. inside the fuselage
  
3. Airport taxiways are identified at night by omnidirectional edge lights. What color are the lights?
  - a. white
  - b. amber
  - c. alternate red and green
  - d. green
  - e. blue
  
4. If the aircraft ammeter is indicating a minus value, this means:
  - a. the generator or alternator output is inadequate
  - b. the electrical system is functioning normally
  - c. the battery should be turned off
  - d. the battery is adequately charged
  - e. the battery requires water
  
5. The angle formed by the chord of an airfoil and the direction of the relative wind is called the:
  - a. angle of incidence
  - b. angle of attack
  - c. stall angle of the wing
  - d. pitch angle
  - e. critical angle of attack

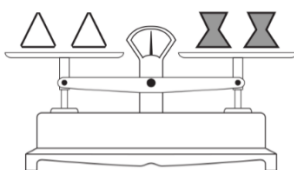
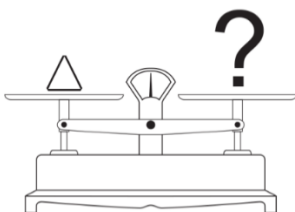
### Part 5 - Weight Perception

**DIRECTIONS:** This part of the test measures your ability to reason and see logical relationships between abstract shapes. On some items you will be shown one balanced scale and one scale with a missing weight. Your task is to use the relationship shown in the balanced scale to choose the response option that fills in the missing weight to keep the second scale balanced. **The relationship shown by the given scale in a particular item applies to that item only.** Assume that different shape/color combinations have different weights unless equal weights can be inferred from the given balanced scale.





1.

Given:		Solve:		
				
				
A	B	C	D	E

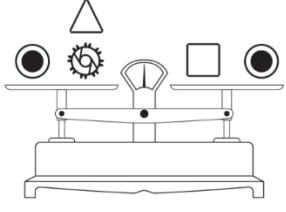
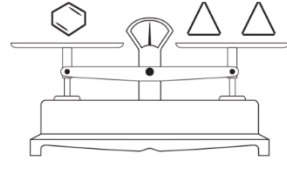
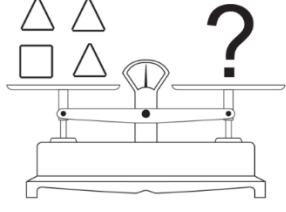
On other items you will be shown two balanced scales and one scale with a missing weight. You must choose the response option that fills in the missing weight to keep the third scale balanced.

2.

Given:		Solve:
		

				
A	B	C	D	E

## **Table 2. Answers to Sample Questions**

### **Math Knowledge**

1. D
2. C
3. A
4. E
5. D

### **Table Reading**

1. D
2. B
3. A
4. E
5. C

### **Instrument Comprehension**

1. A
2. A
3. D
4. D
5. A

### **Aviation Information**

1. C
2. B
3. E
4. A
5. B

### **Weight Perception**

1. C
2. B