

Handwriting

Practice Makes Perfect

~ Lowercase Letters ~



Handwriting practice sheet for the lowercase letter 'a'. It includes a diagram showing the stroke order for writing 'a' (1: counter-clockwise curve, 2: vertical line down), a line drawing of an apple, a name field, and six rows of handwriting lines with dashed 'a's for tracing.

Name: _____

apple

Handwriting by Lavinia Pop © 2013

Thank you for downloading this product; I hope you will enjoy using it and that it will be a valuable resource for you! I value your feedback, so please don't hesitate to contact me if you have any concerns whatsoever as I will endeavour to address them. And if you like what I've done, please let me know by leaving feedback at my online store :)

Lavinia

lavinia@inmyworld.com.au

ILLUSTRATIONS Just So Scrappy 2, Pink Cat Studio, TeacherScrapbook, Little Red, Jessica Weible Illustrations, Classroom Doodle Diva, Graphics From The Pond, Ramona Majdis, Kari Bolt, Whimsy Clips

www.justsoscrappytoo.com www.pinkcatstudio.com www.teacherspayteachers.com/Store/Teacherscrapbook
www.teacherspayteachers.com/Store/Littlered www.shopjwillustrations.com www.teacherspayteachers.com/Store/Classroom-Doodle-Diva
www.teacherspayteachers.com/Store/Graphics-From-The-Pond www.teacherspayteachers.com/Store/Ramona-Majdis
www.teacherspayteachers.com/Store/Kari-Bolt www.teacherspayteachers.com/Store/Whimsy-Clips

FONTS www.schoolfonts.com.au

PRINTING TIP: This resource has been designed for printing on A4-sized paper. If you are printing on a different size, select "shrink to printable area" or "print to fit page" (or a similar option) in order for the contents of this unit to print correctly.

Copyright © 2013-2015 by Lavinia Pop – All rights reserved by author.

Purchase of this item entitles the purchaser the right to reproduce the pages for personal and classroom use. Duplication for other classes, an entire school or commercial purposes is strictly prohibited without written permission from the author. Minor editing is permitted only for personal use, however the document remains under copyright even when edited. Posting this item in whole or in part on the Internet in any form is strictly prohibited and is a violation of the Digital Millennium Copyright Act (DMCA). Please be fair and don't share! If you are not the original purchaser of this file, please visit my blog to obtain a link to one of my online stores. www.inmyworld.com.au

Click to connect...



www.inmyworld.com.au



www.facebook.com/inmyworldlavinipop



www.pinterest.com/lavinipop

Introduction

About this book:

This book contains basic handwriting sheets for children who need extra practice to perfect their letters. Each handwriting sheet displays a letter with correct letter formation, then 5 writing lines for them to trace the letter.

Directions for use:

Children begin by finger tracing the large letter in the top left corner of the page. They then trace the smaller letters. Once finished, older children may write the letter in the blank spaces provided after every traced letter.

The handwriting sheets in this book can be used while working with the entire class or in small groups. They would make a great homework sheet, and would also be ideal for morning work or early finisher work or however you see fit!

I have included 2 versions of each handwriting sheet for your convenience: one with dotted lines and one with a continued tracing line.

* Please note: I have included some extra pages for some letters to accommodate for different formations.

Happy Teaching :)

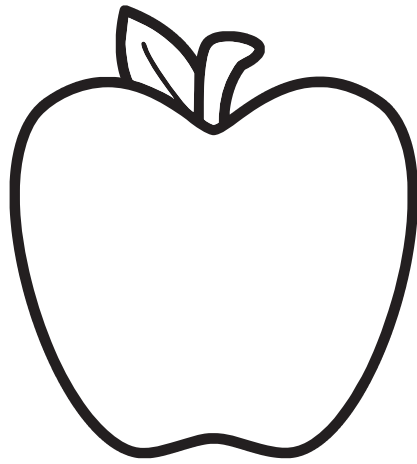
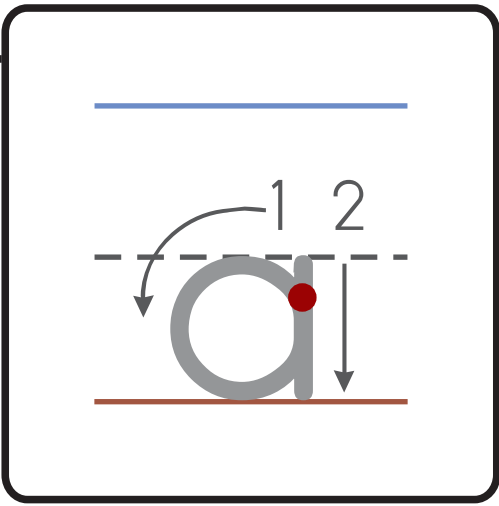

Name: _____

apple

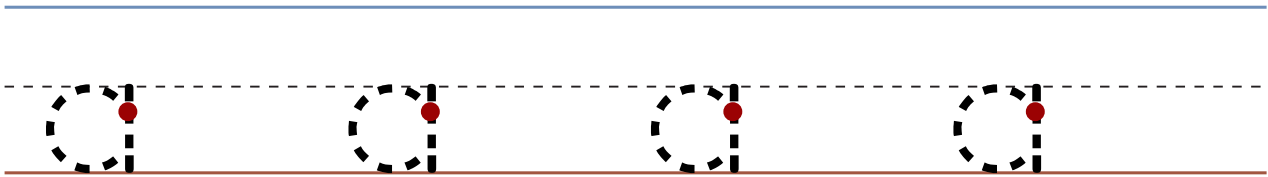
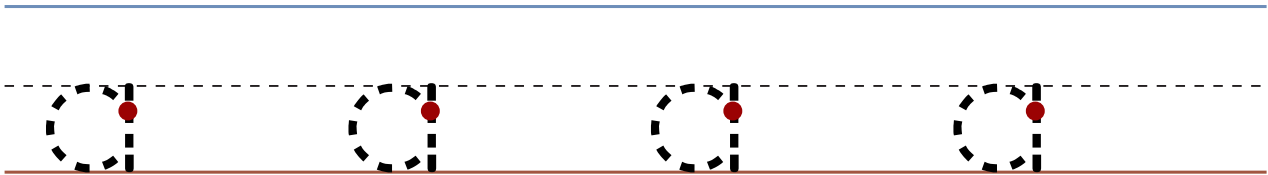
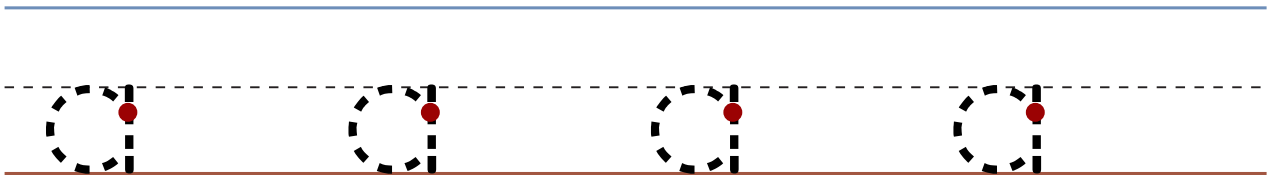
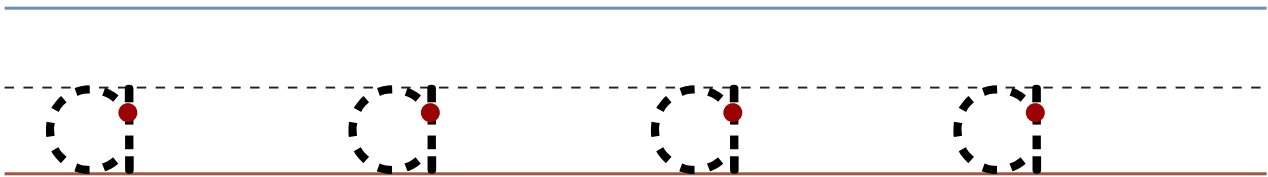
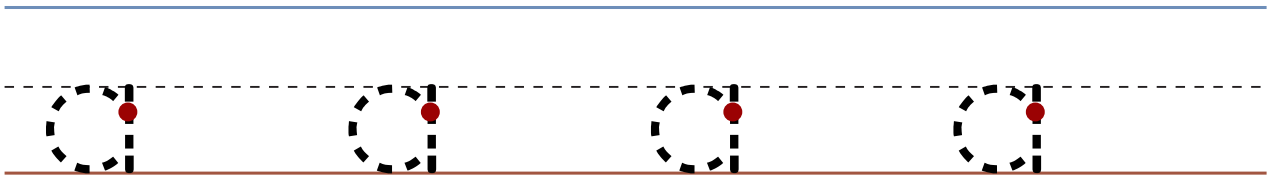

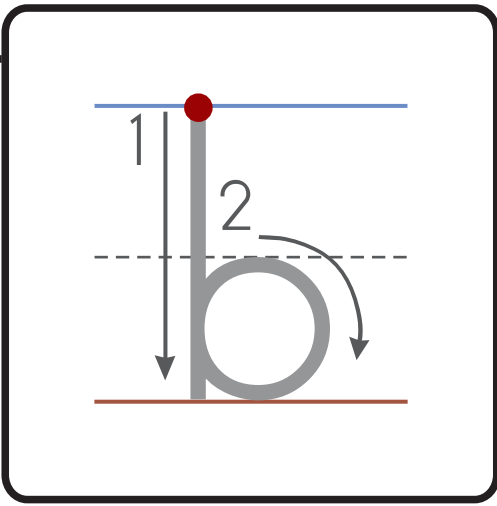

Name: _____

bear

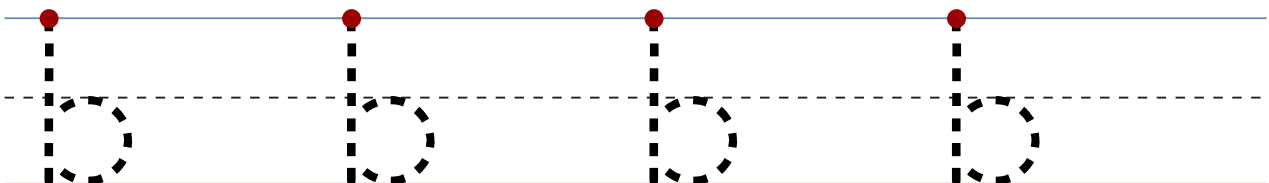
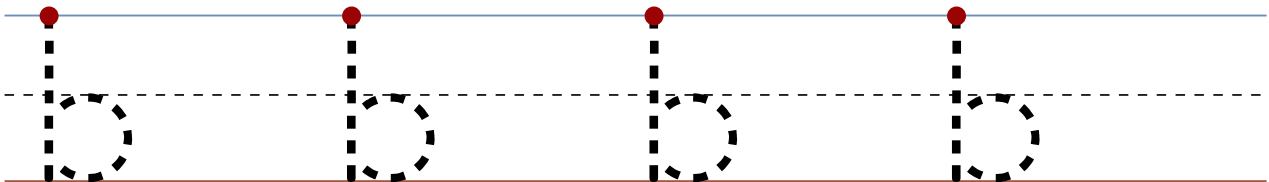
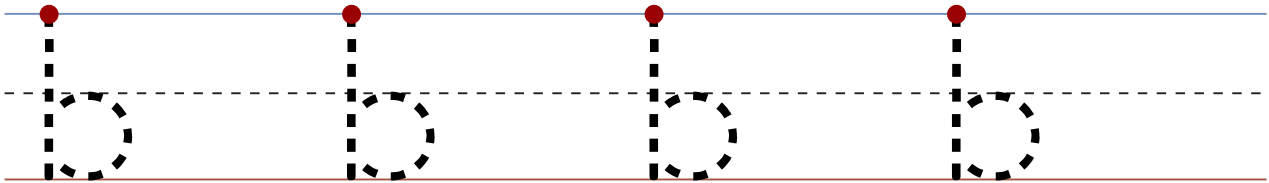
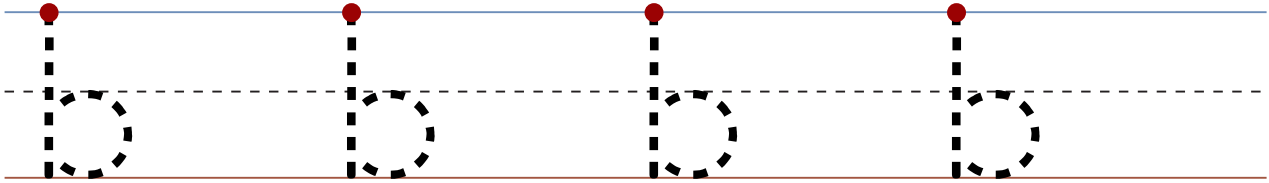
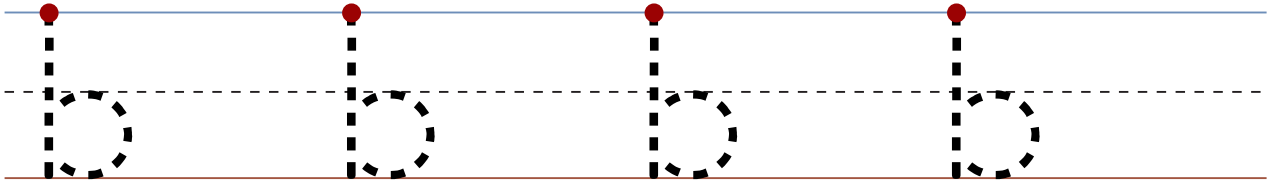

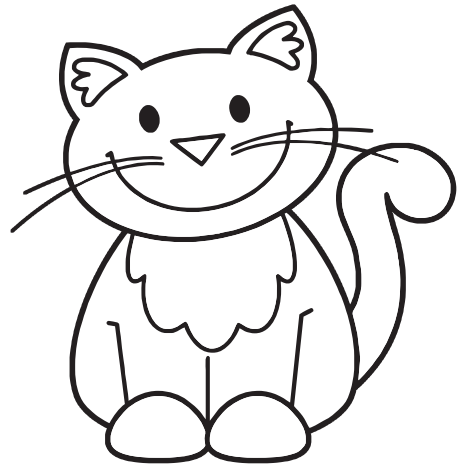
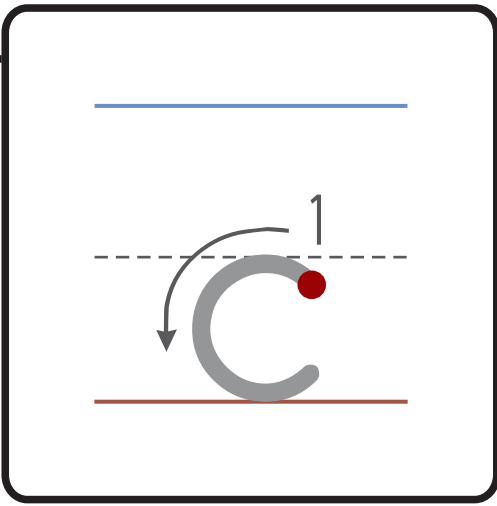

Name: _____

cat

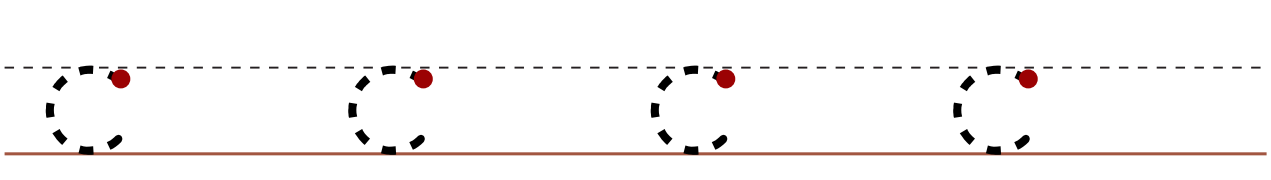
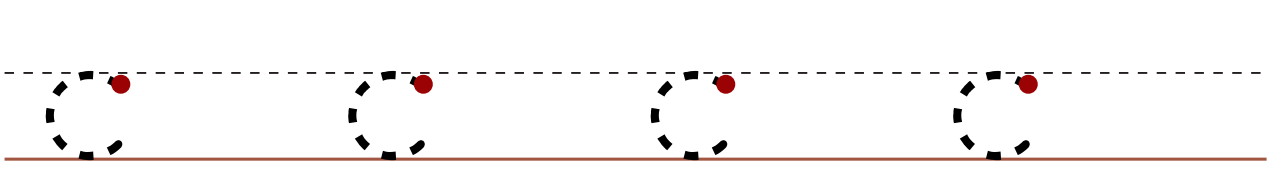
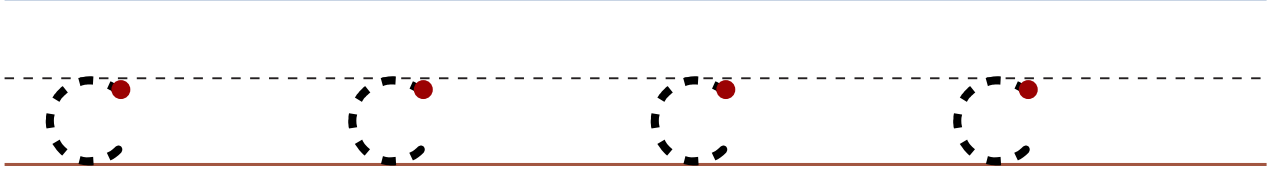
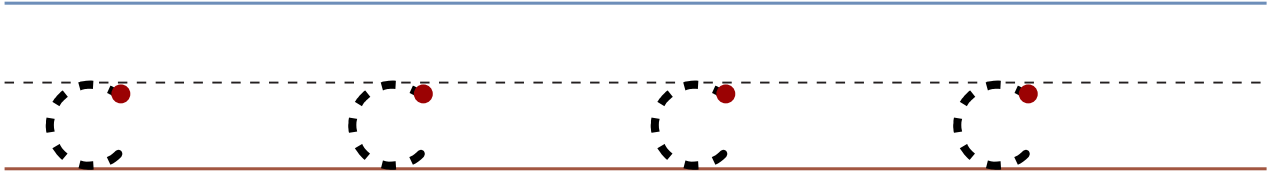
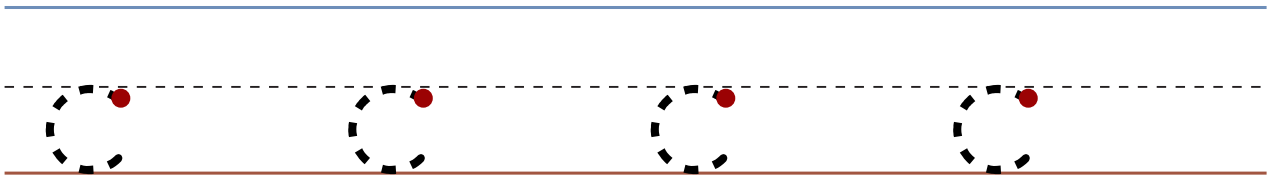

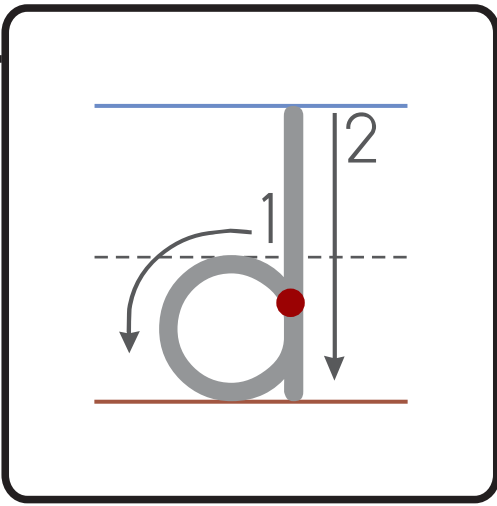

Name: _____

dog

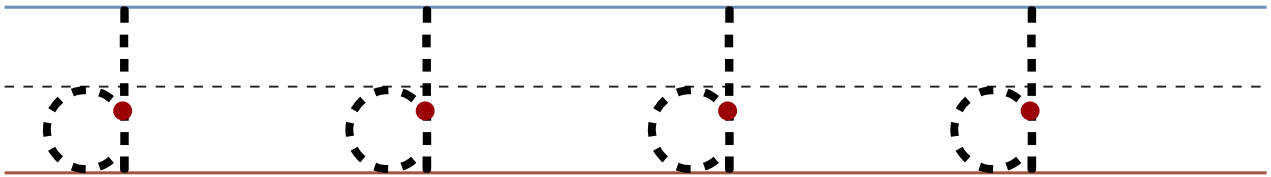
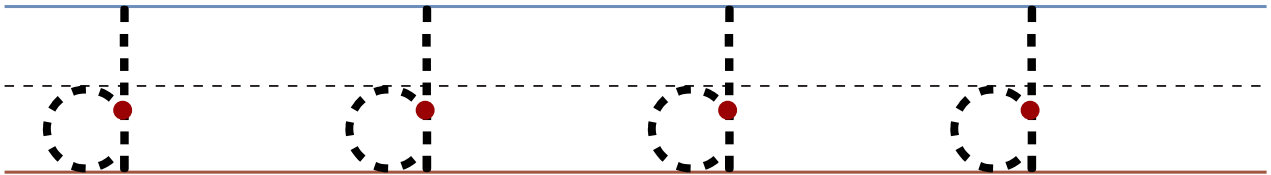
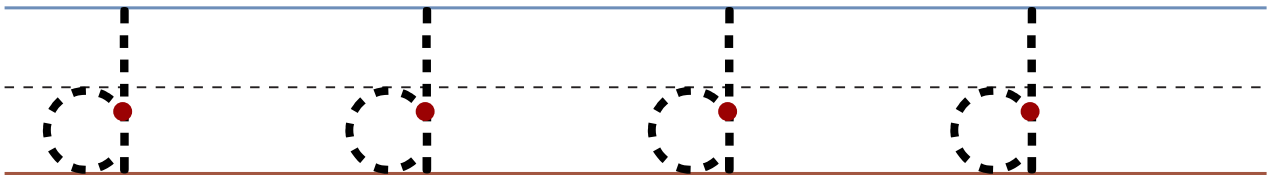
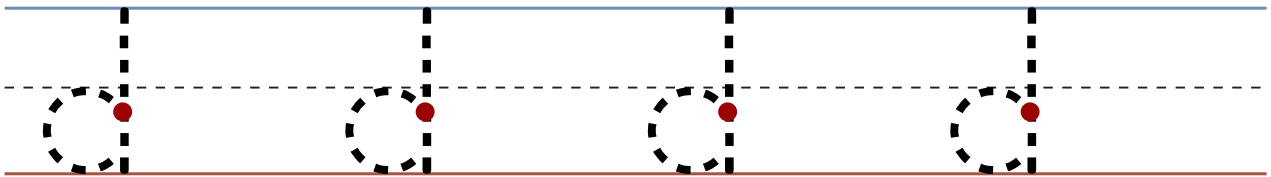
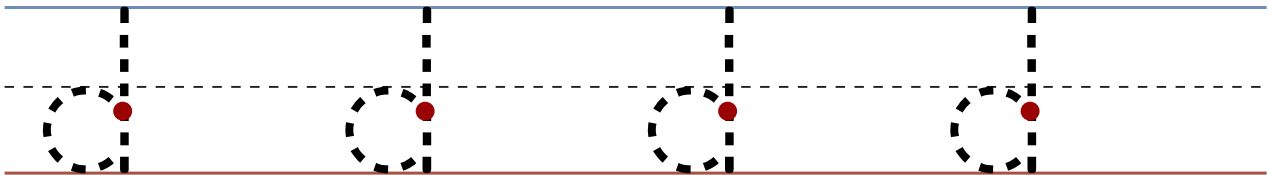

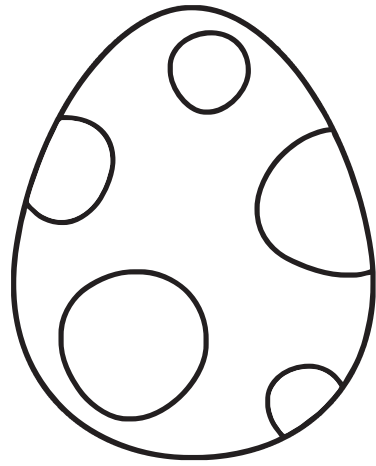
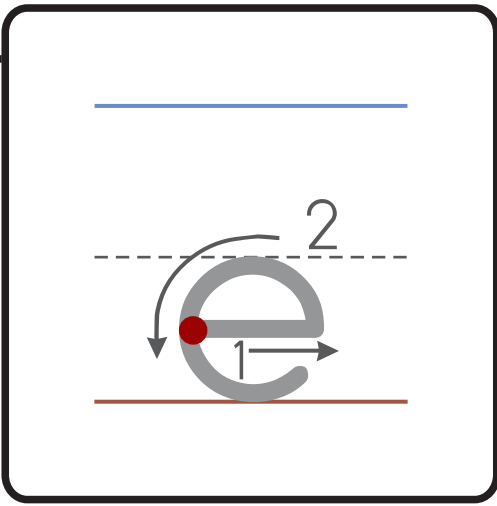

Name: _____

egg

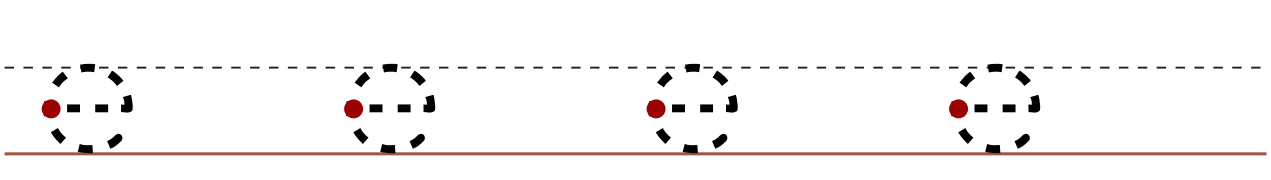
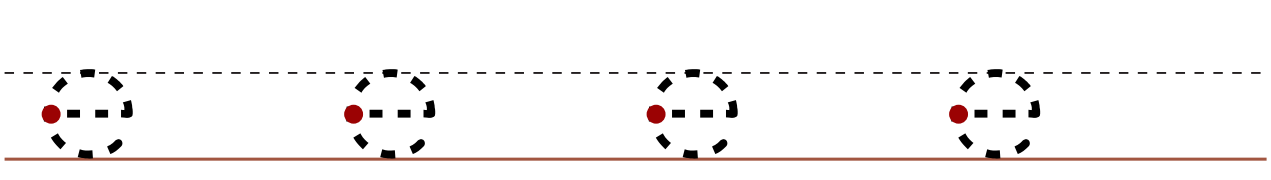
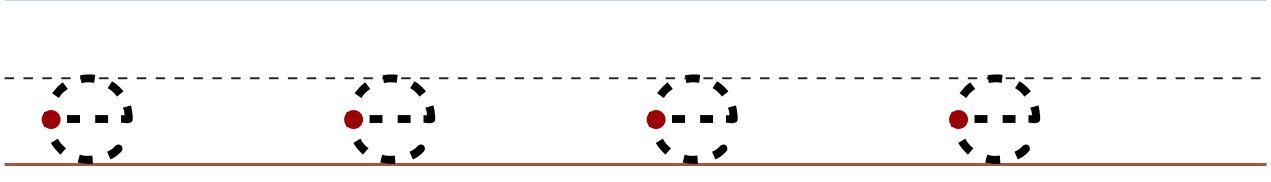
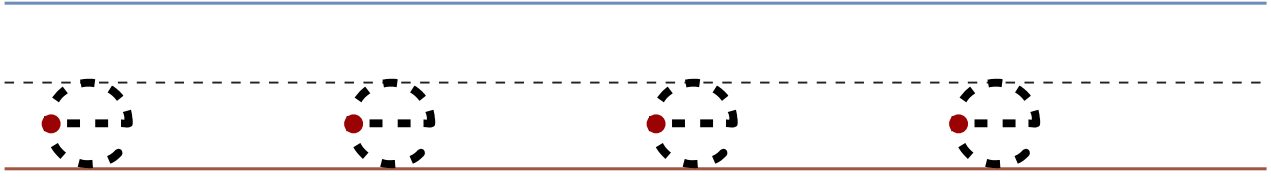
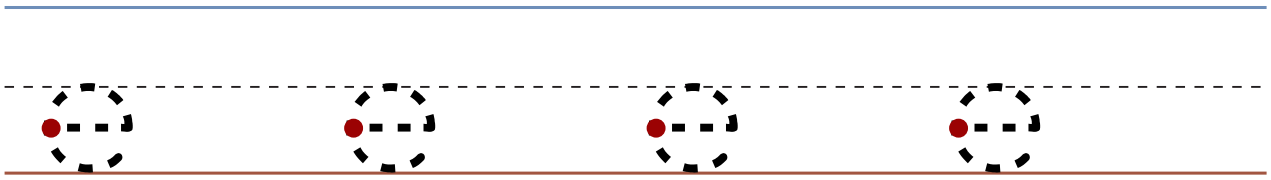

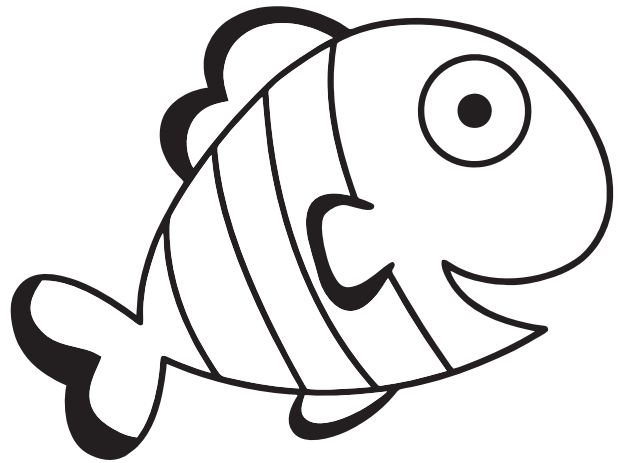
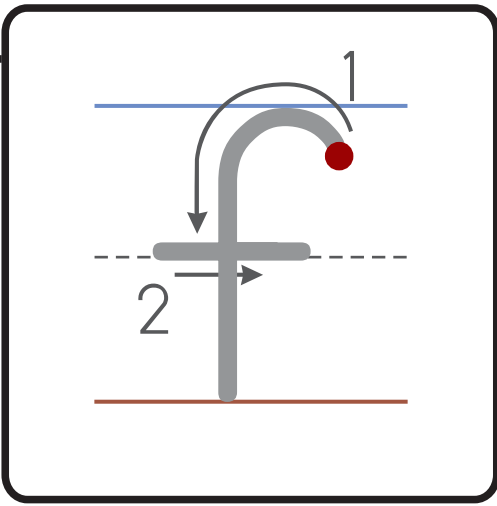

Name: _____

fish

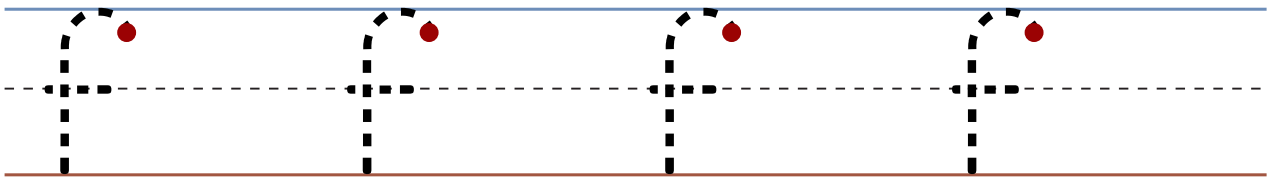
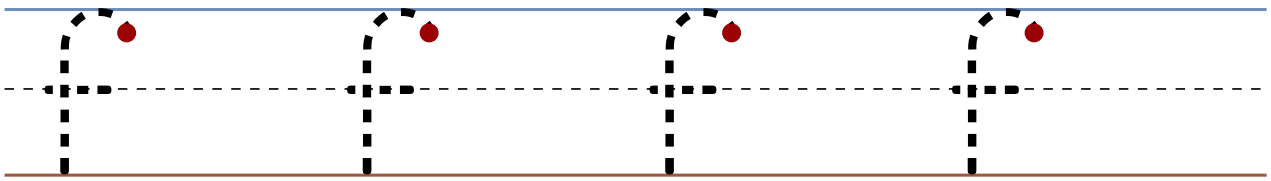
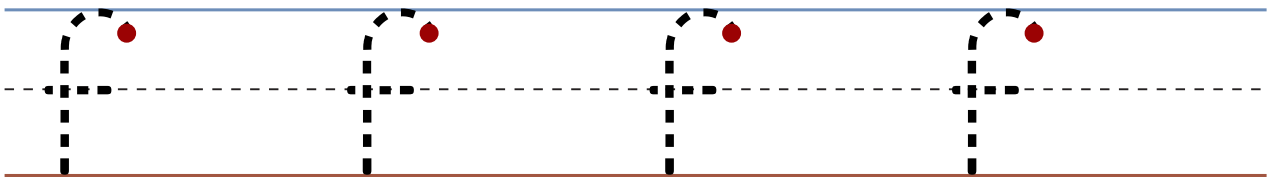
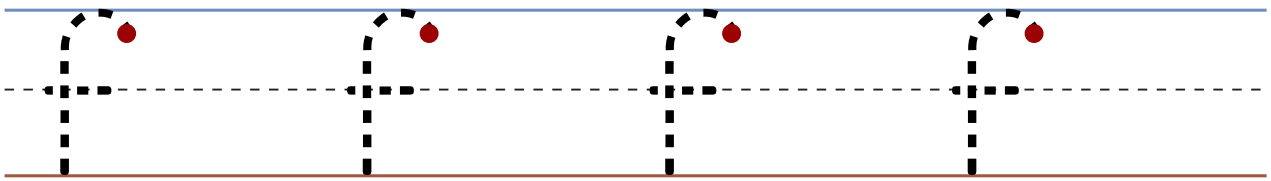
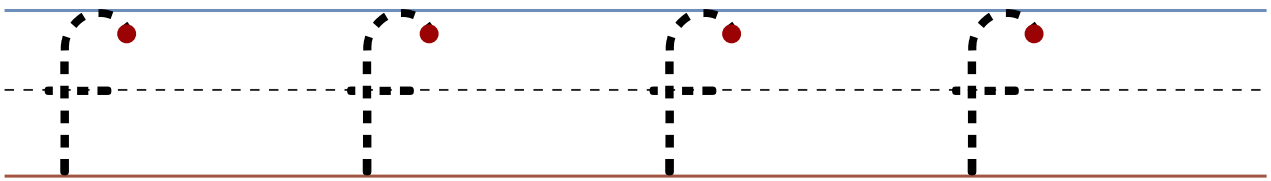

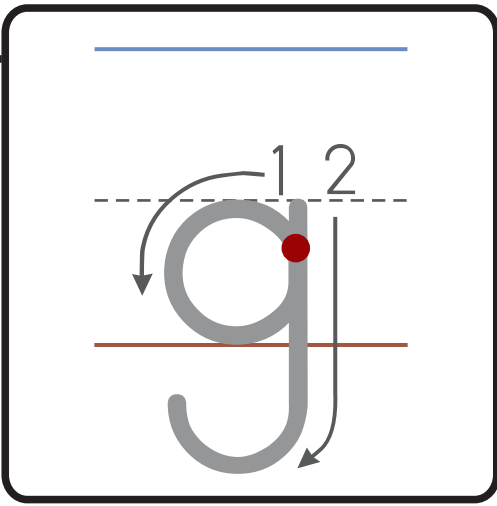

Name: _____

game

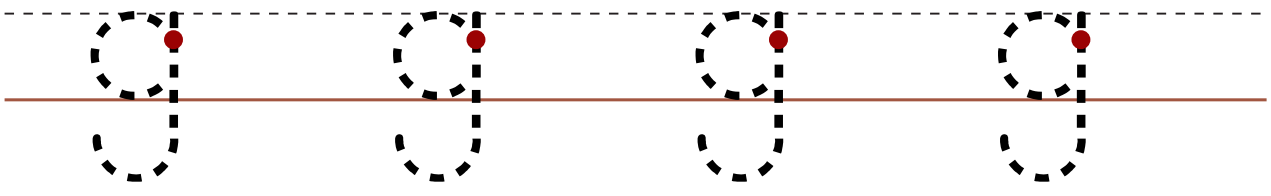
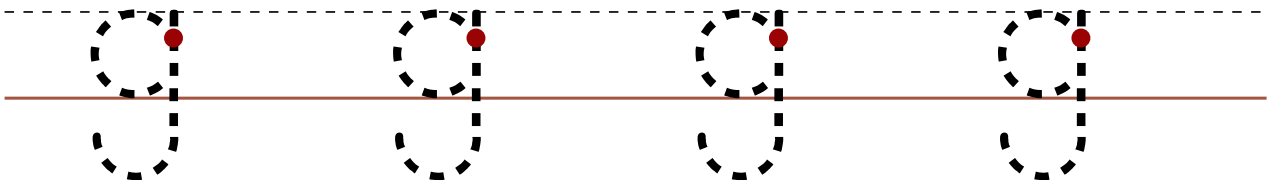
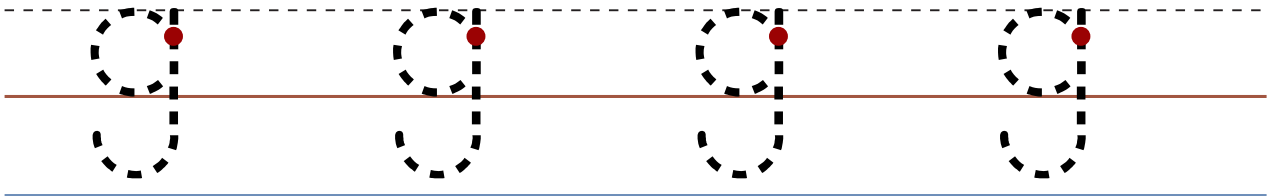
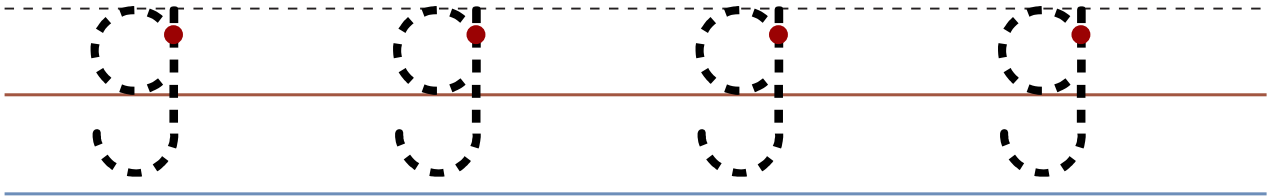
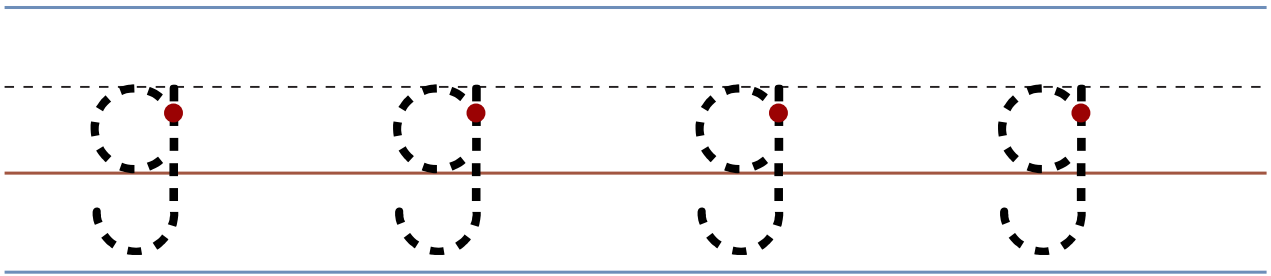

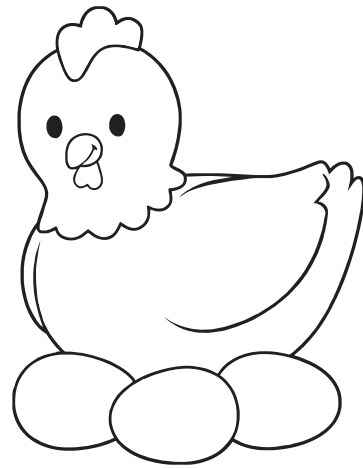
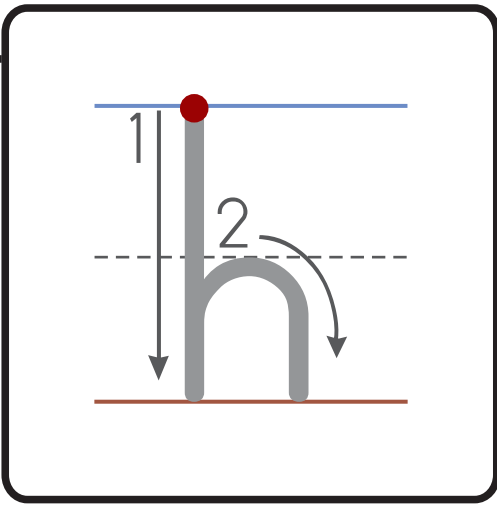

Name: _____

hen

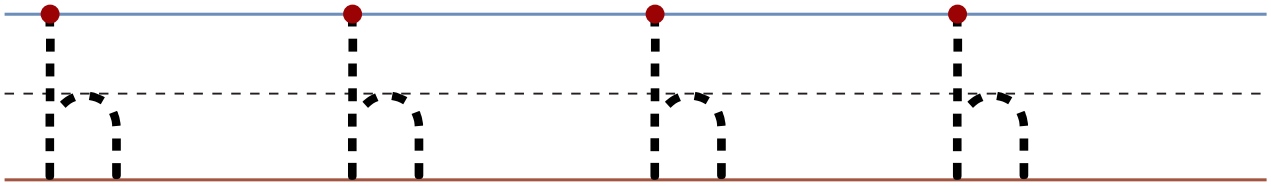
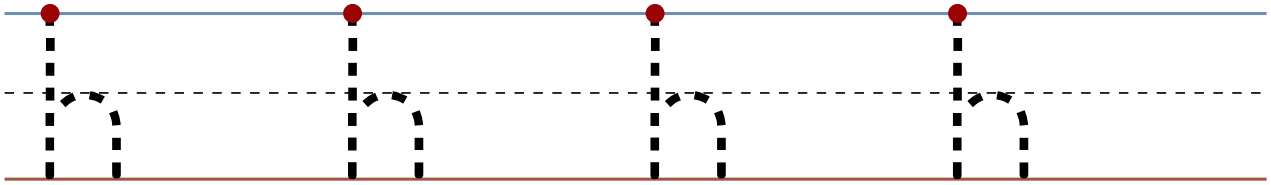
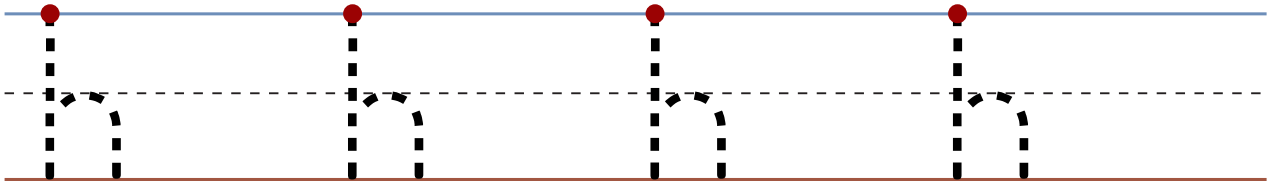
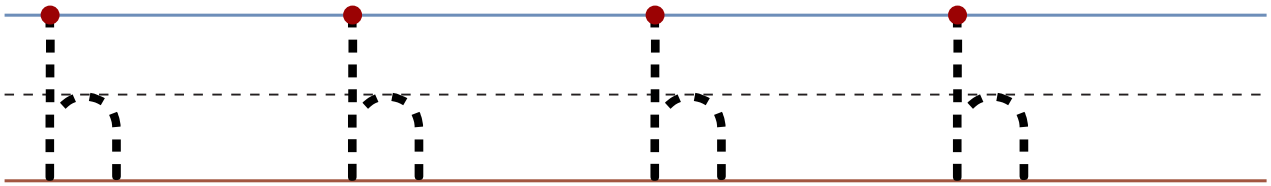
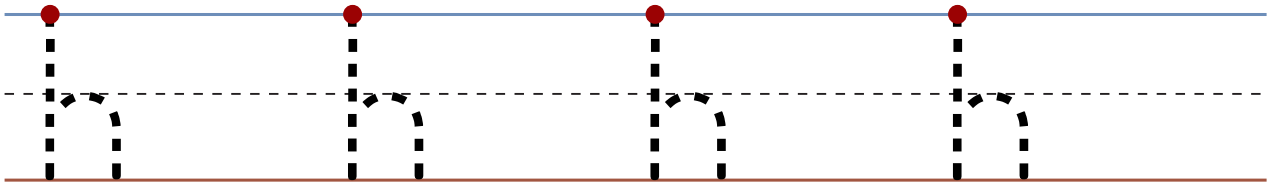

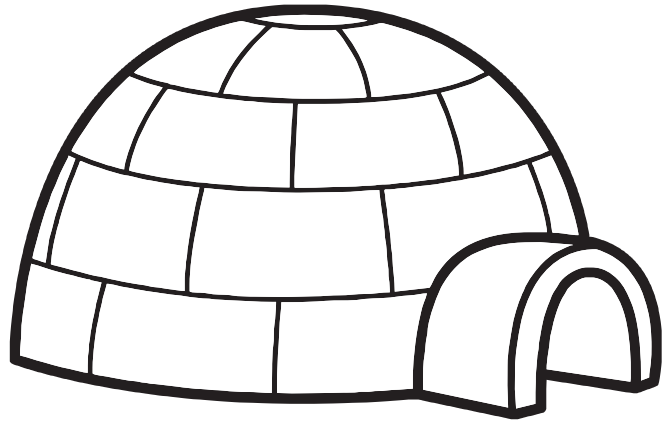
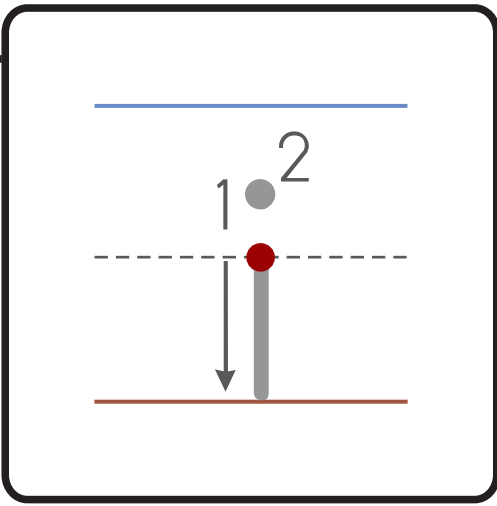

Name: _____

igloo

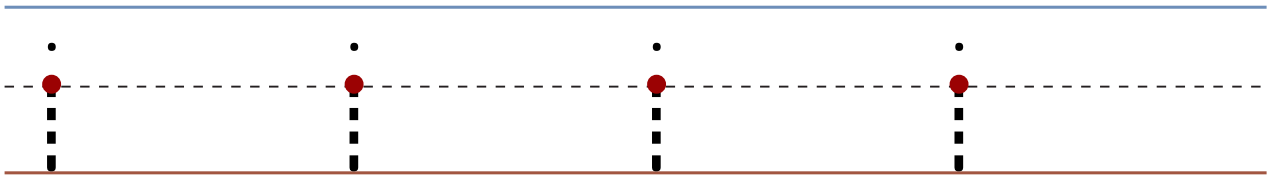
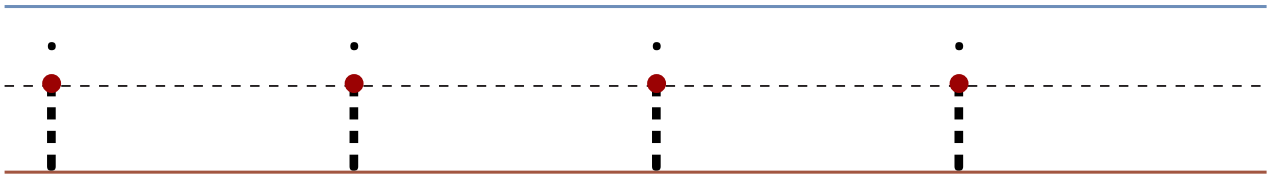
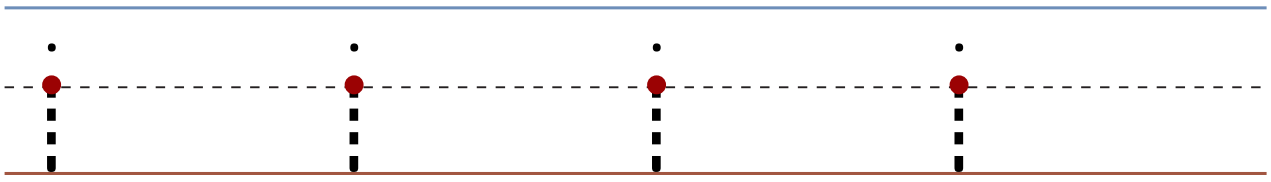
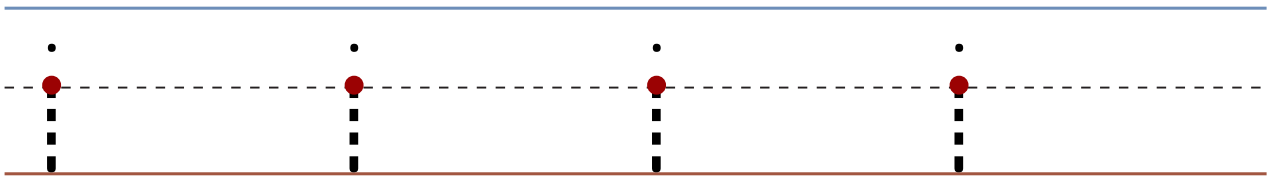
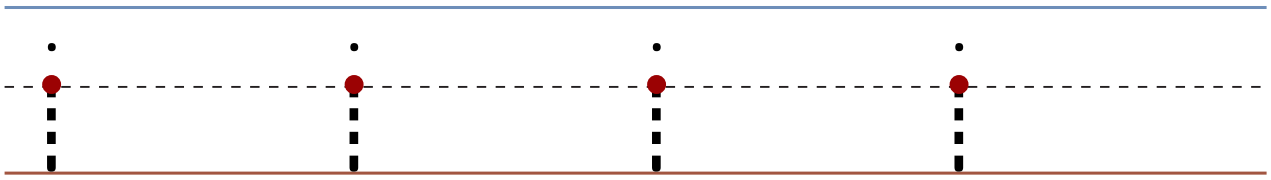

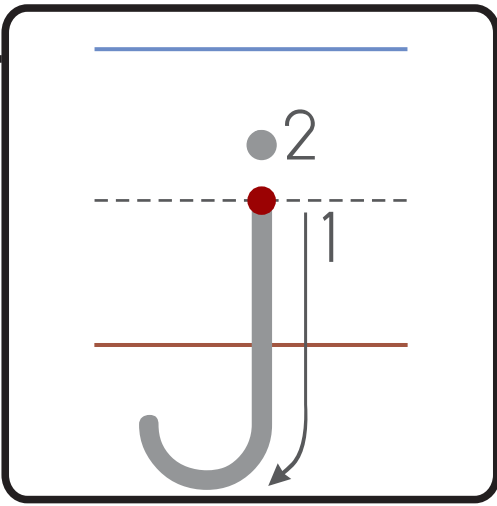

Name: _____

jacket

Handwriting practice section consisting of five rows of three-line guides (top blue, middle dashed, bottom red). Each row contains four dashed lowercase 'j' characters for tracing. Each 'j' has a red dot at the top and a small black dot above it.

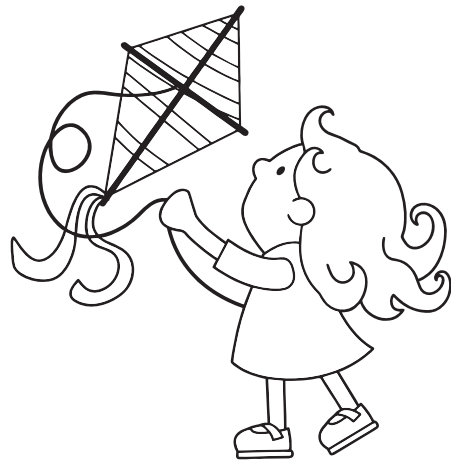
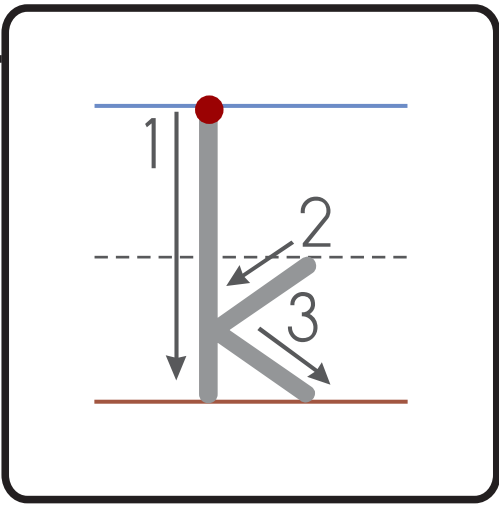

Name: _____

kite

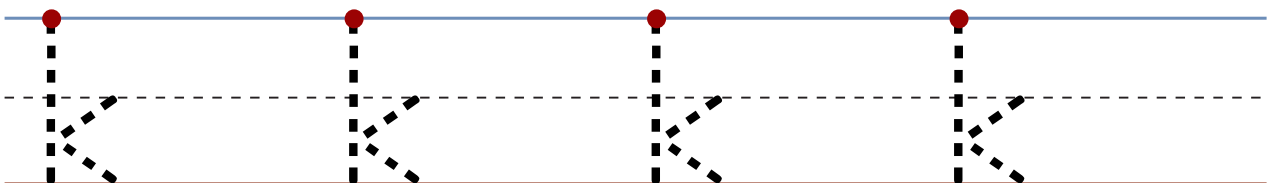
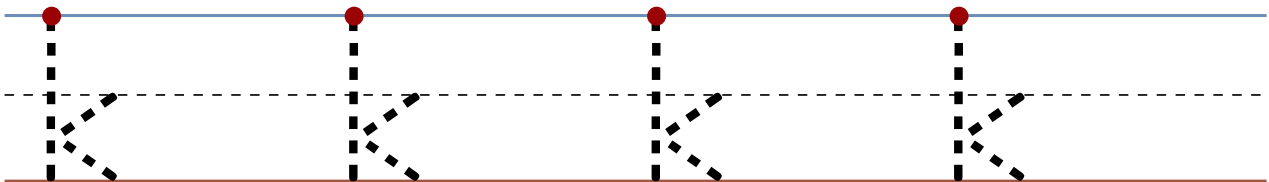
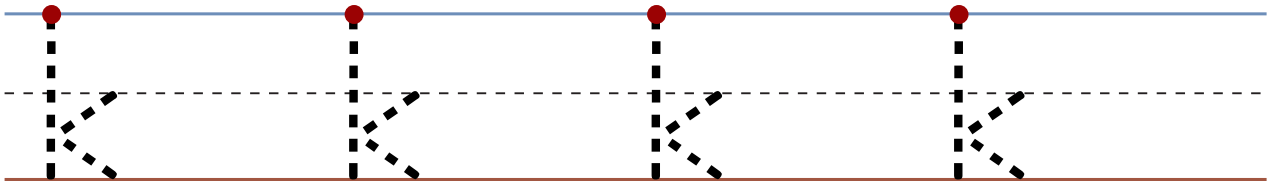
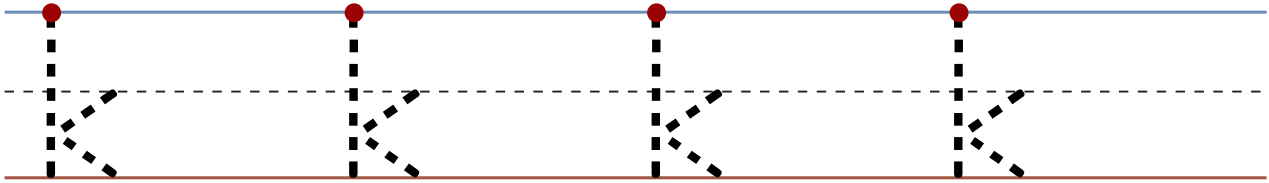
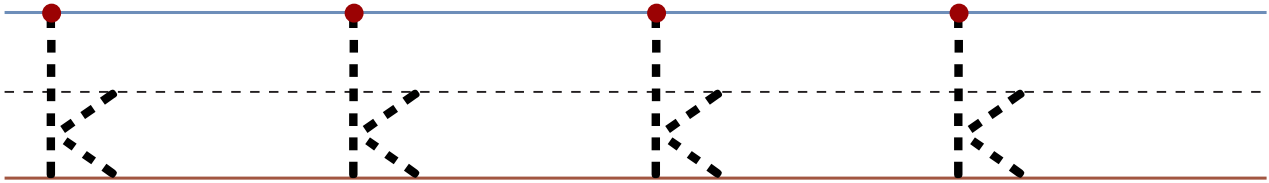

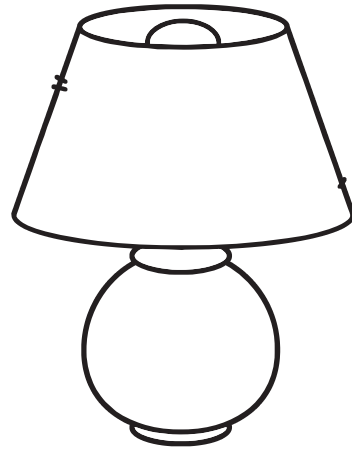
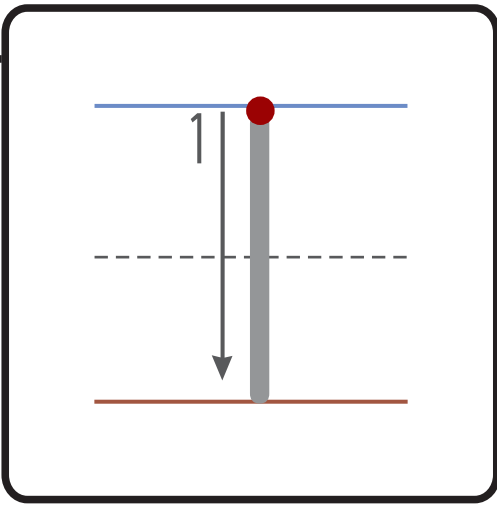

Name: _____

lamp

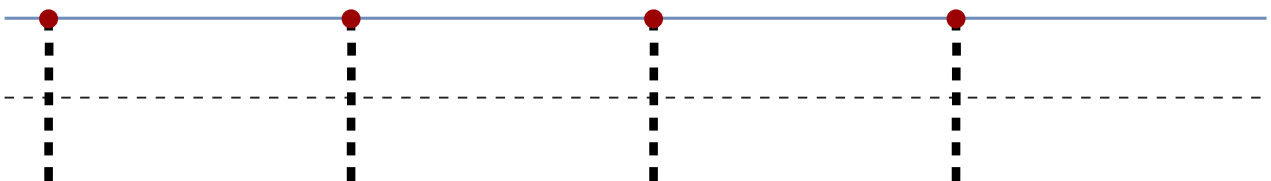
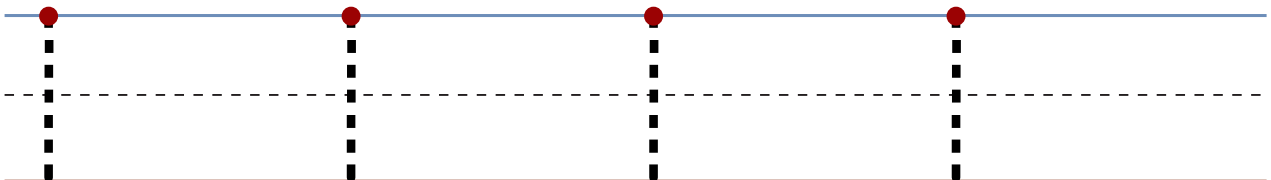
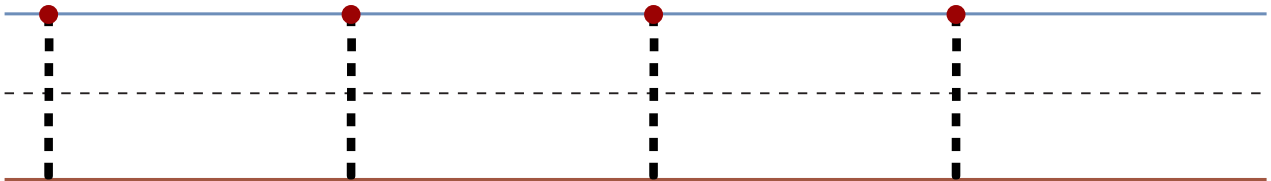
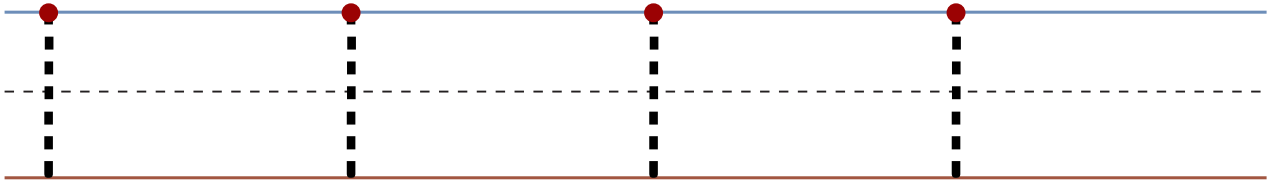
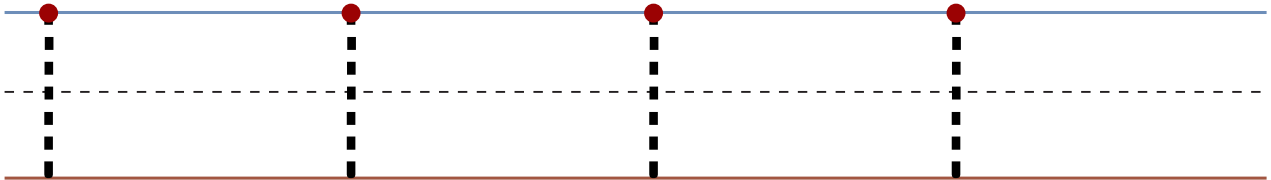

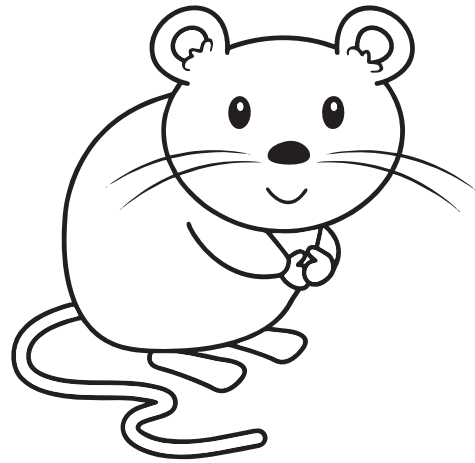
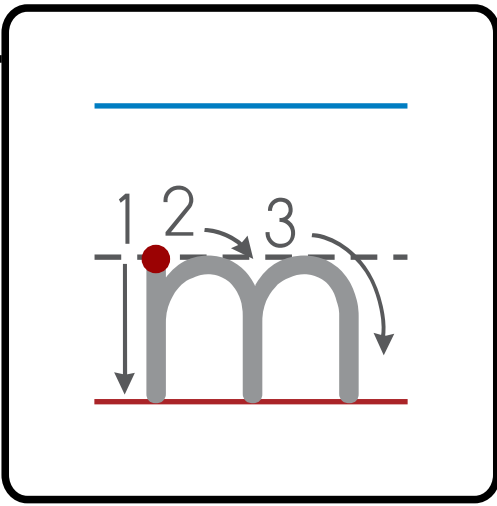

Name: _____

mouse

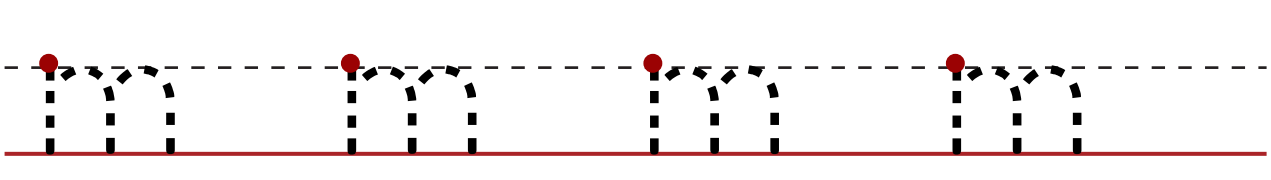
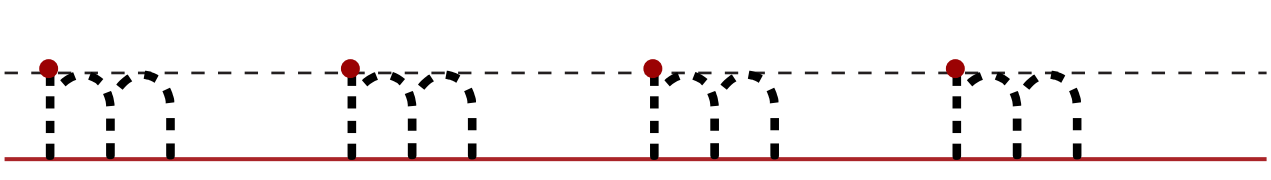
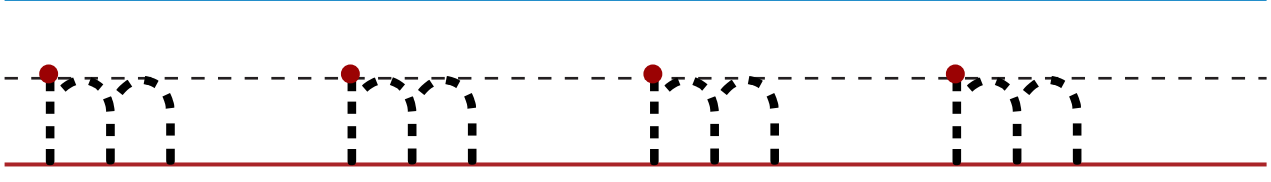
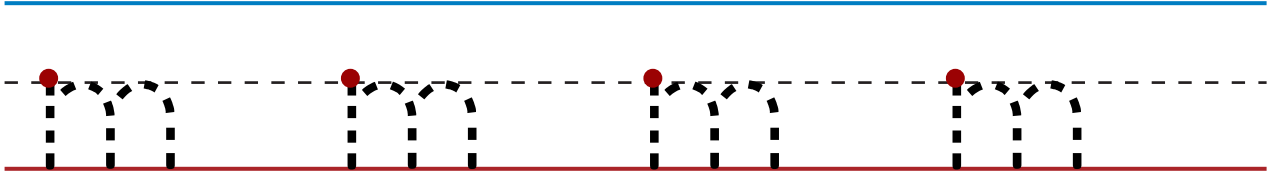
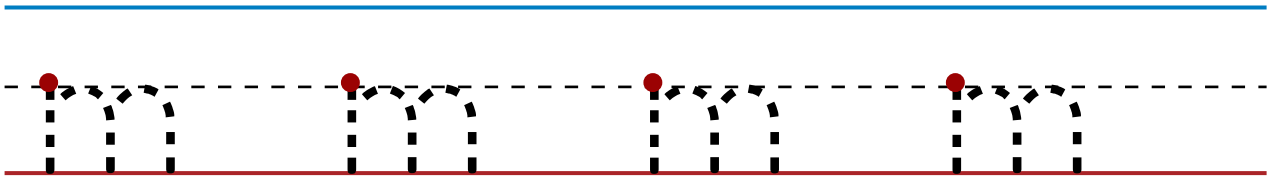

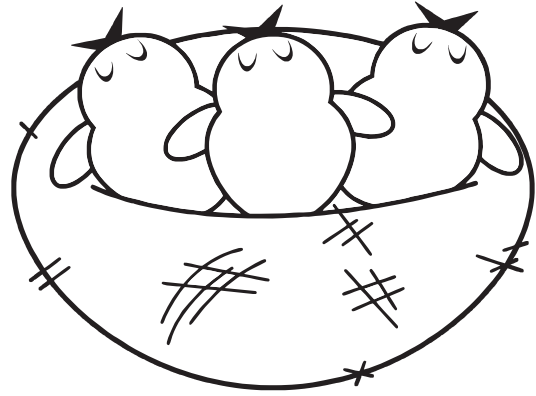
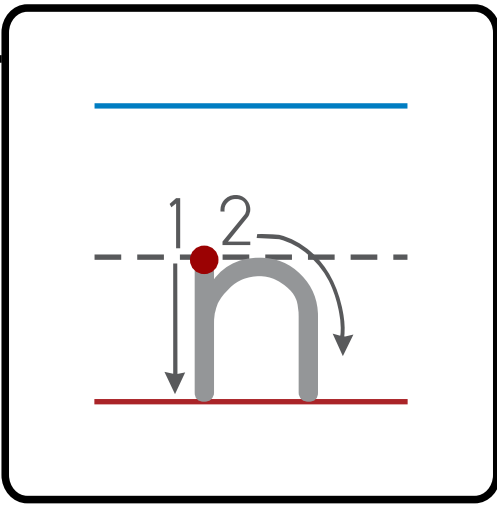

Name: _____

nest

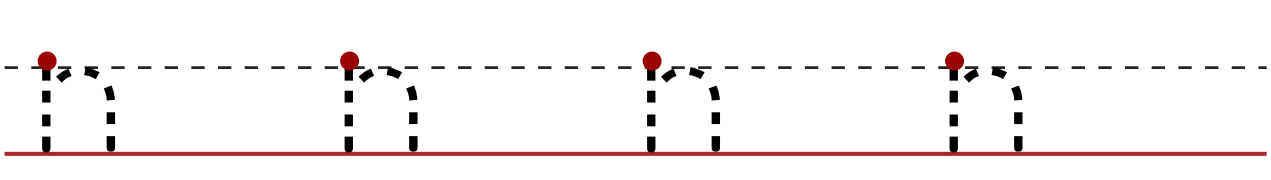
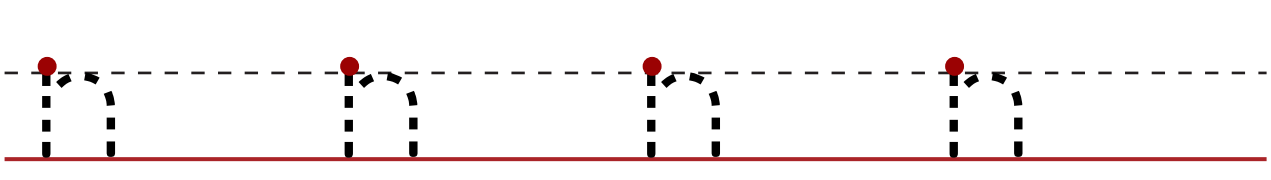
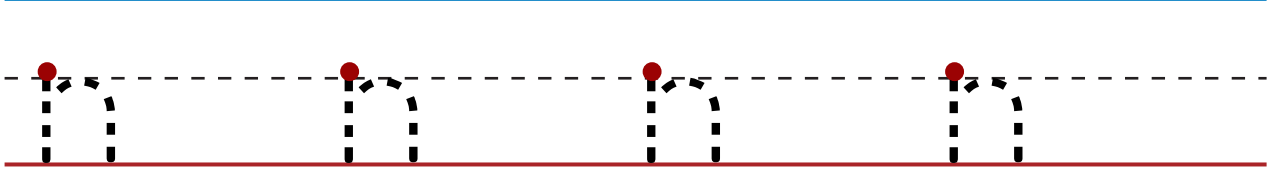
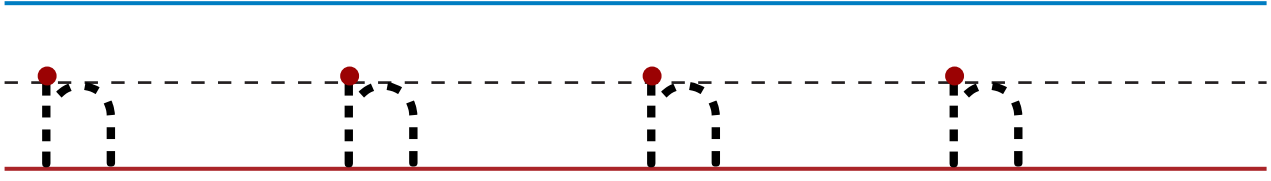
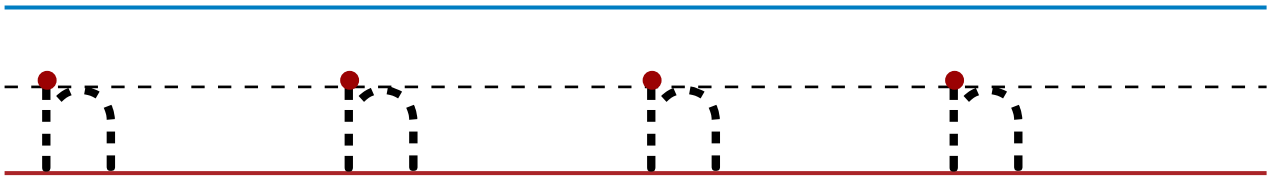

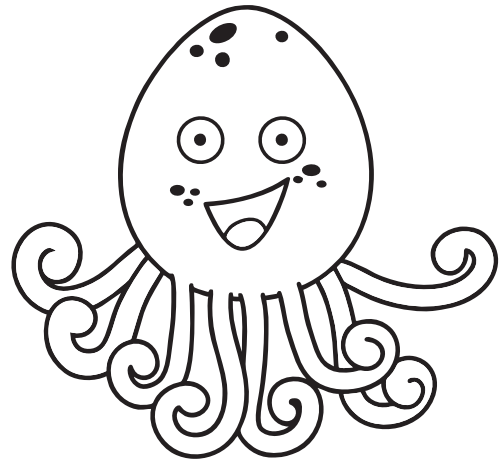
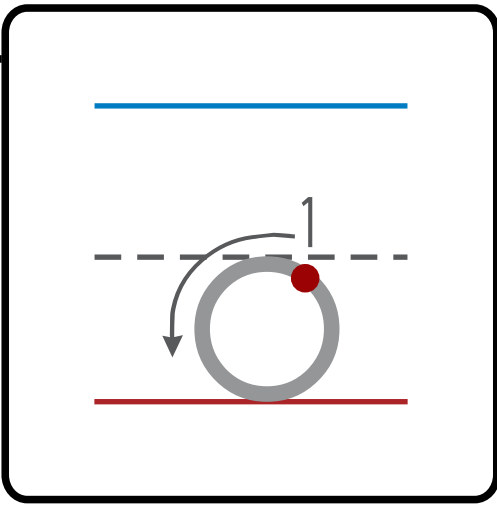

Name: _____

octopus

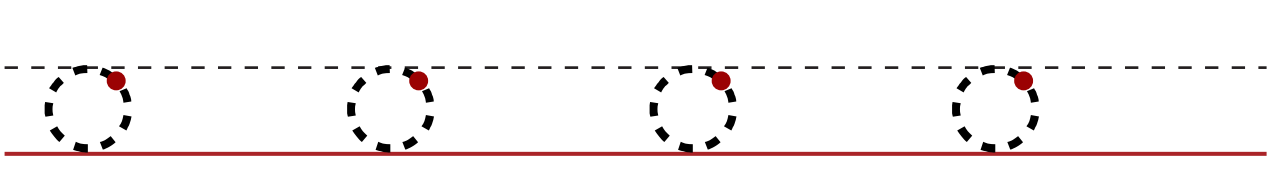
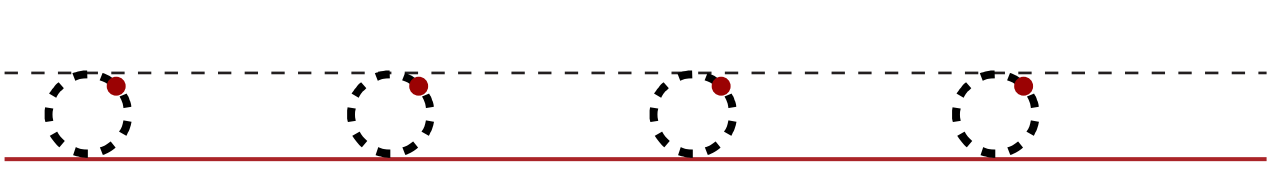
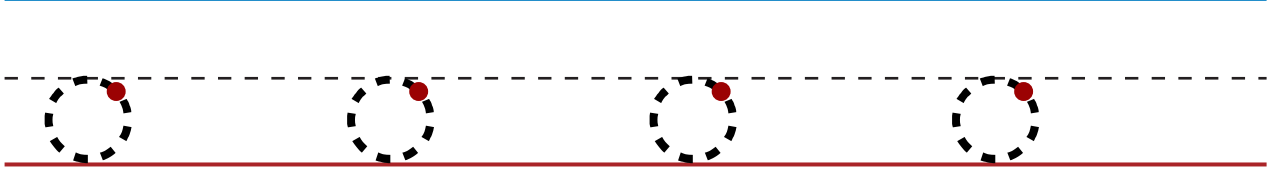
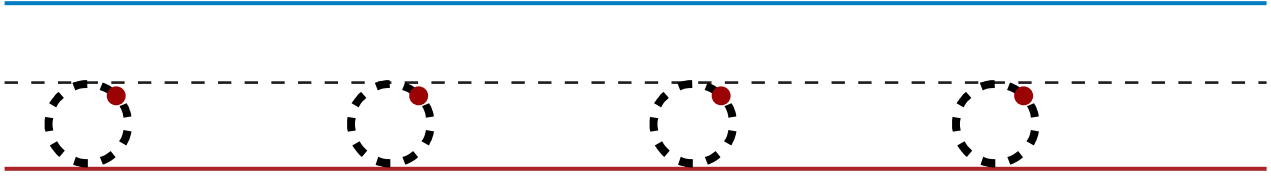
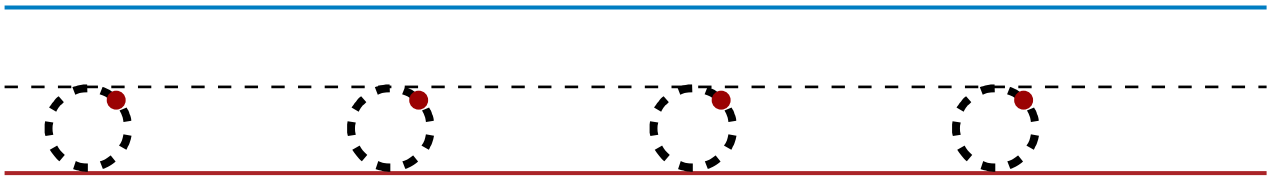

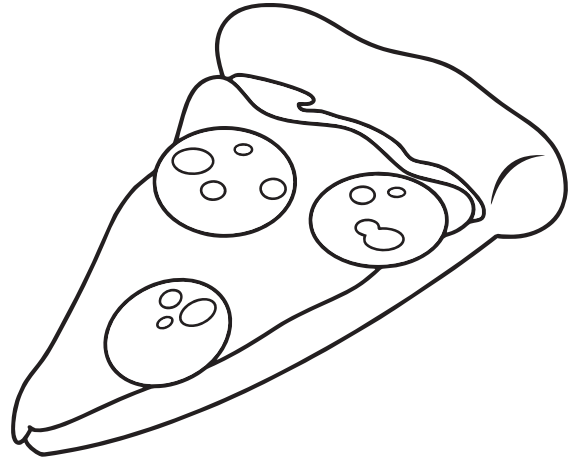
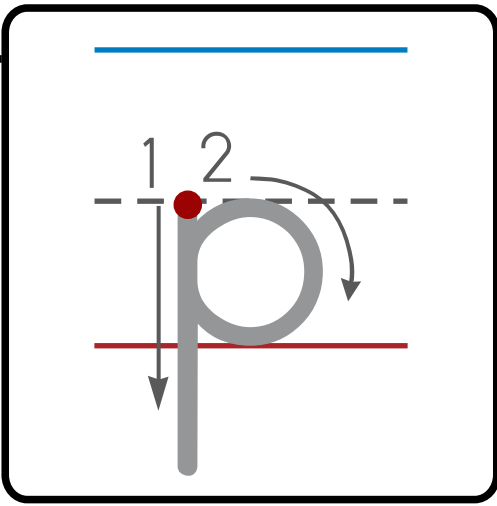

Name: _____

pizza

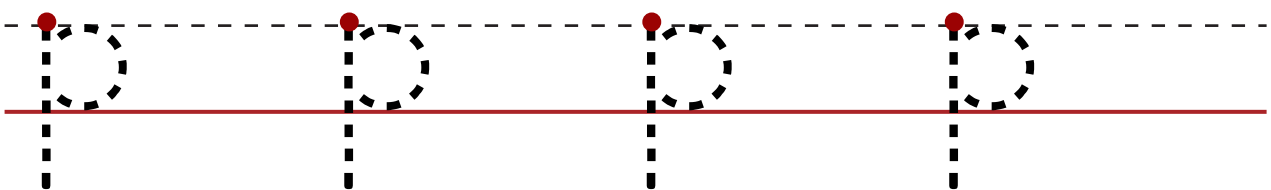
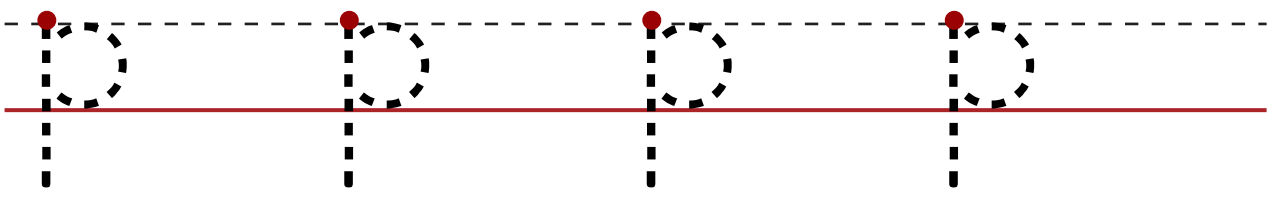
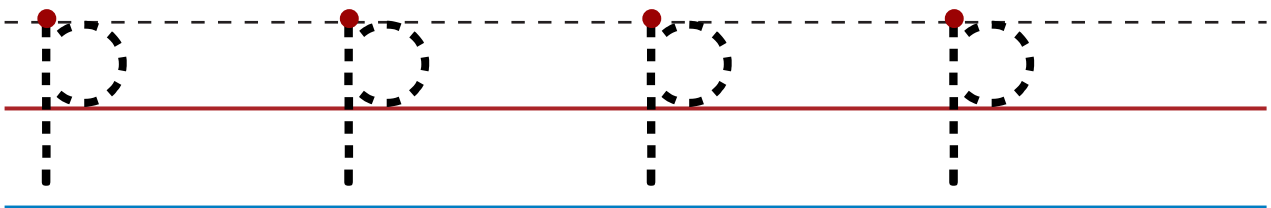
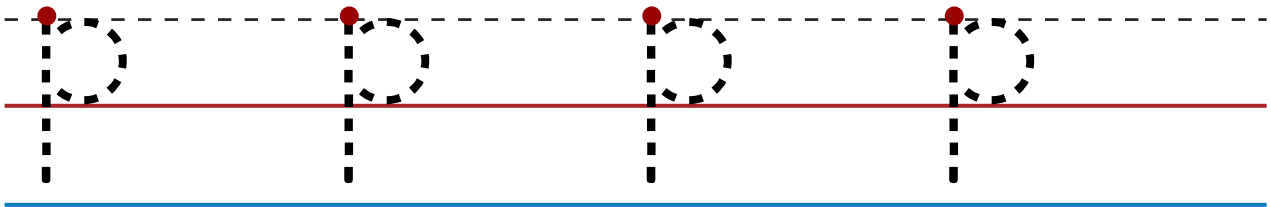
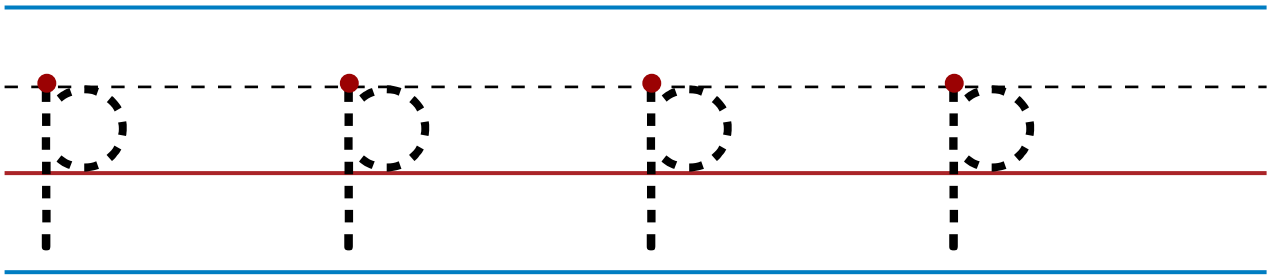

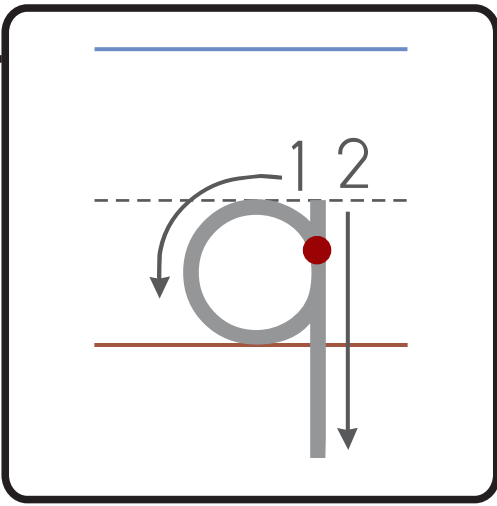

Name: _____

queen

Handwriting practice section consisting of six rows of three-line guides (blue top, dashed middle, red bottom). Each row contains four dashed lowercase 'q' characters for tracing. Each 'q' has a red dot at the top of its stem and a dashed vertical line extending below the red bottom line.

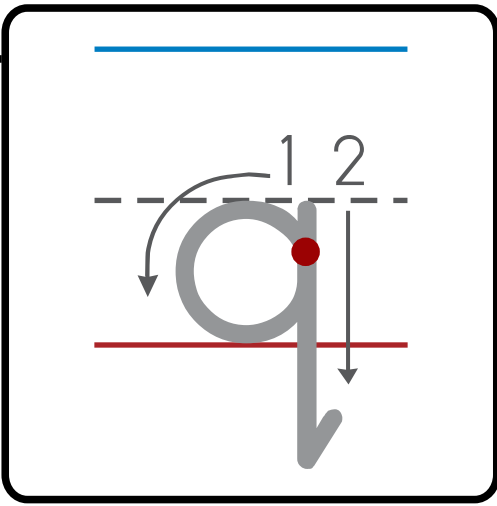

Name: _____

queen

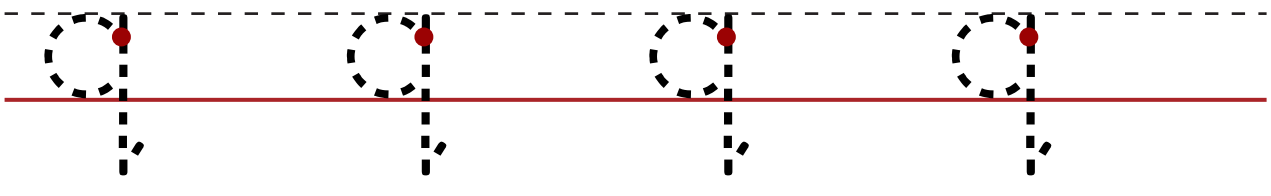
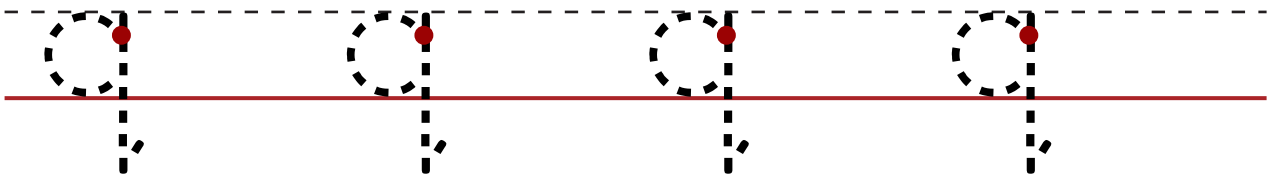
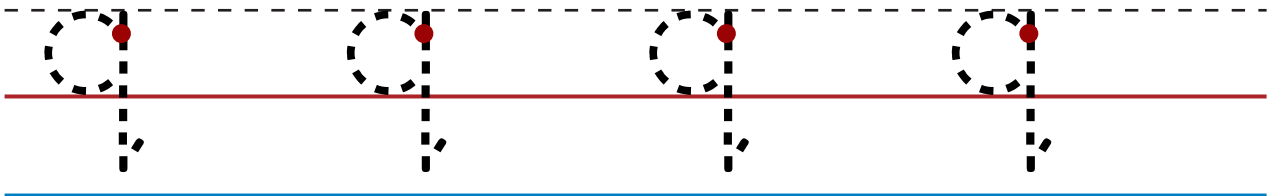
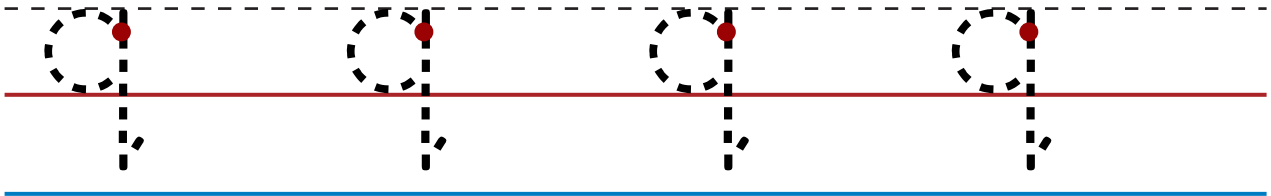
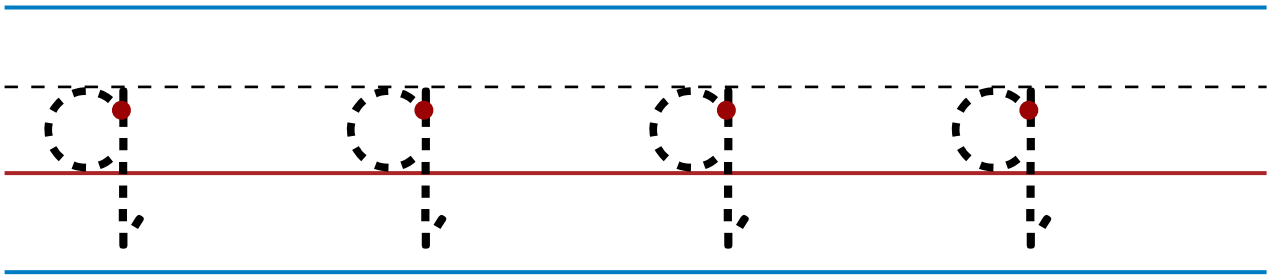

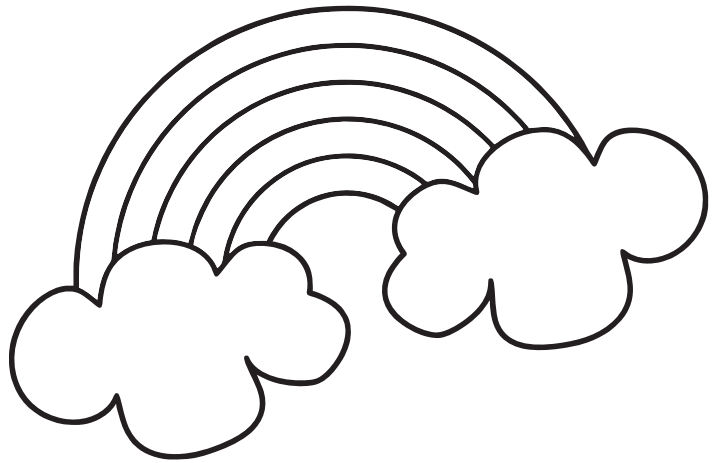
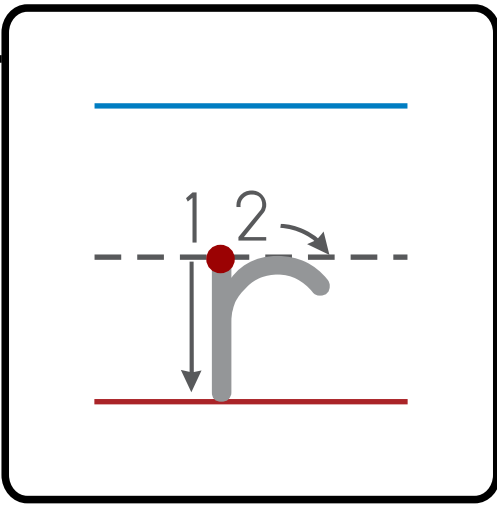

Name: _____

rainbow

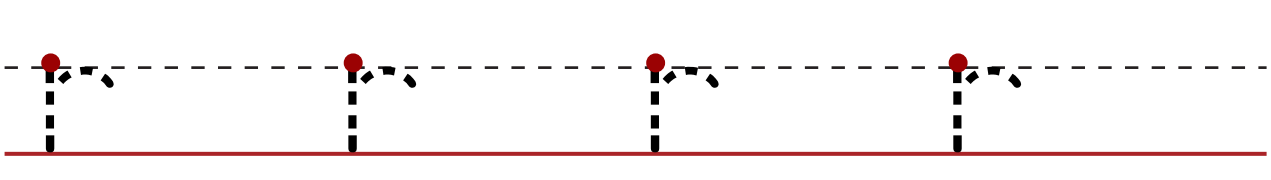
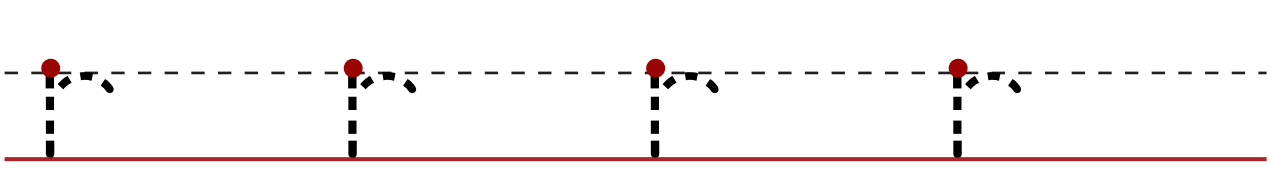
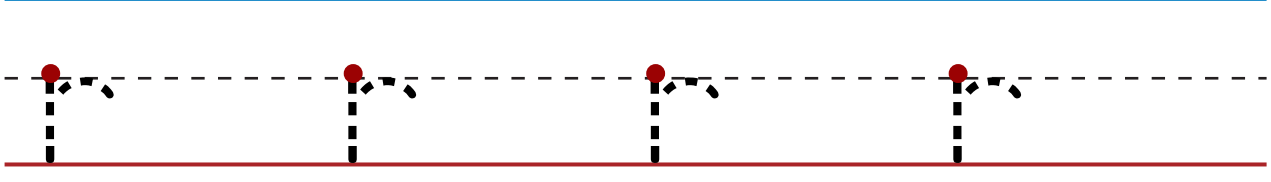
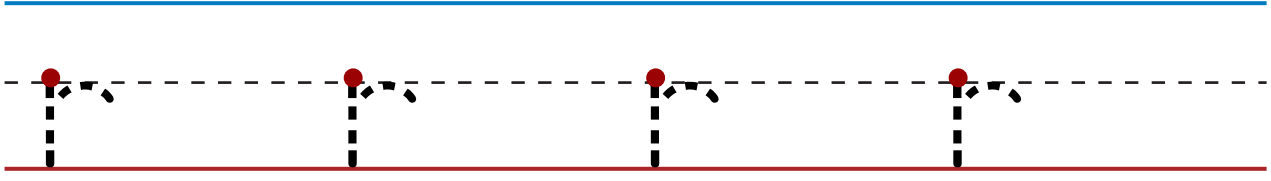
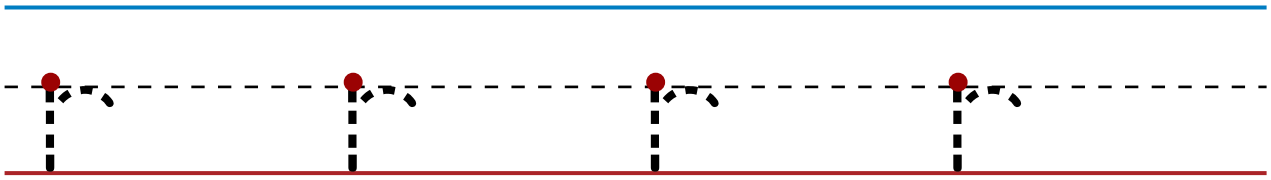

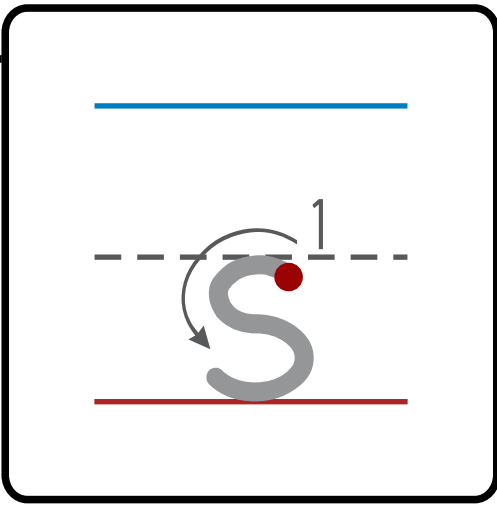

Name: _____

seahorse

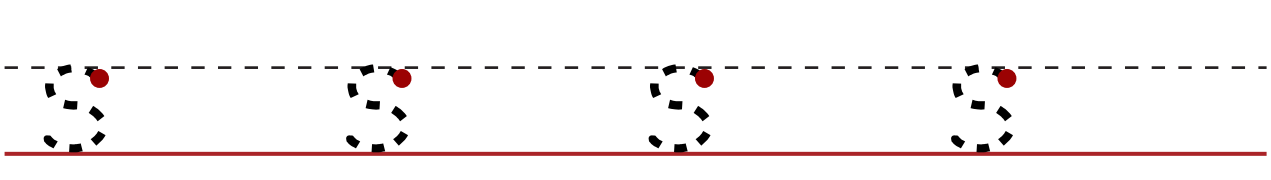
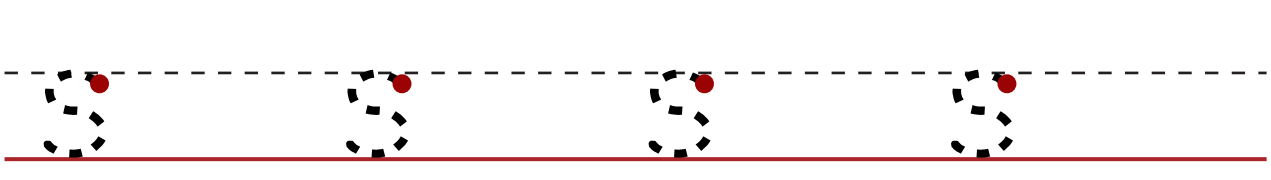
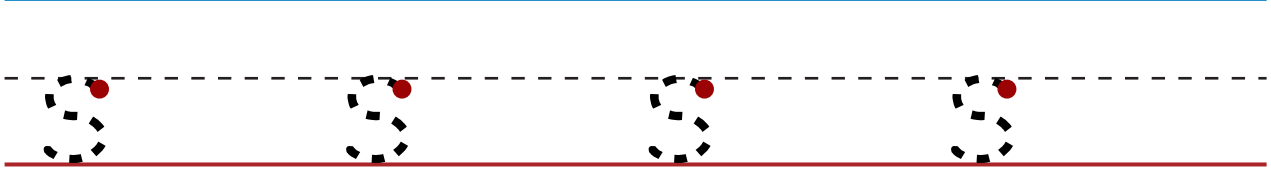
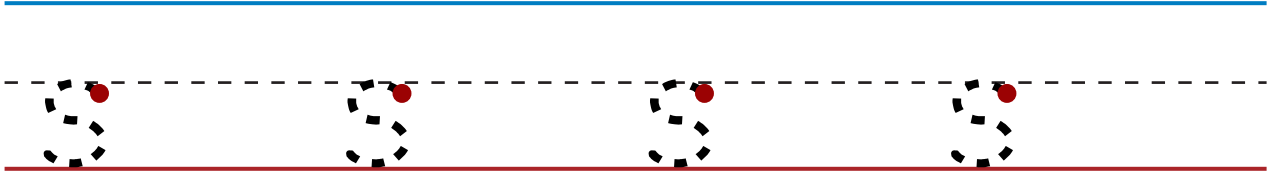
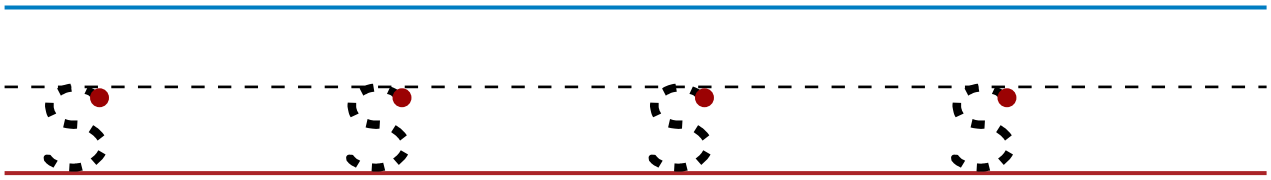

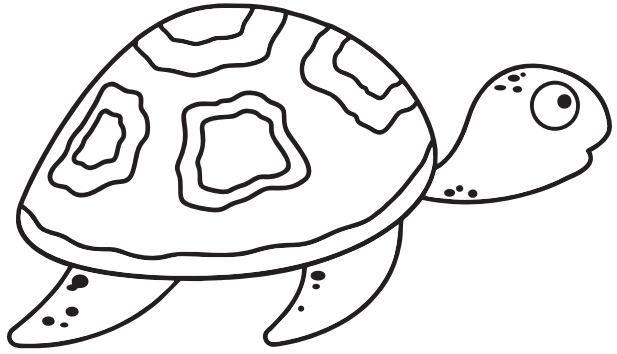
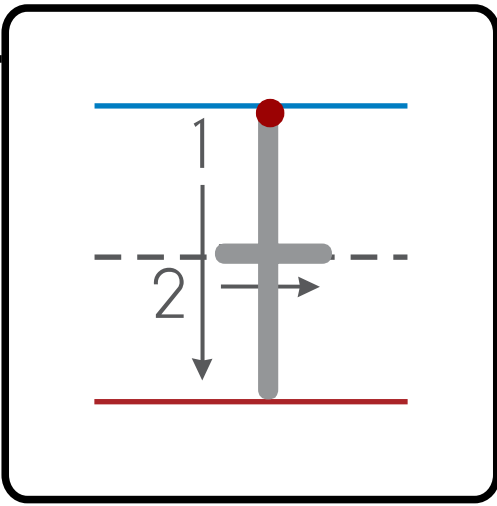

Name: _____

turtle

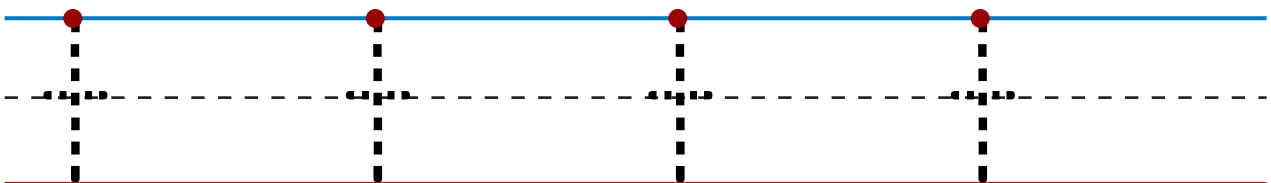
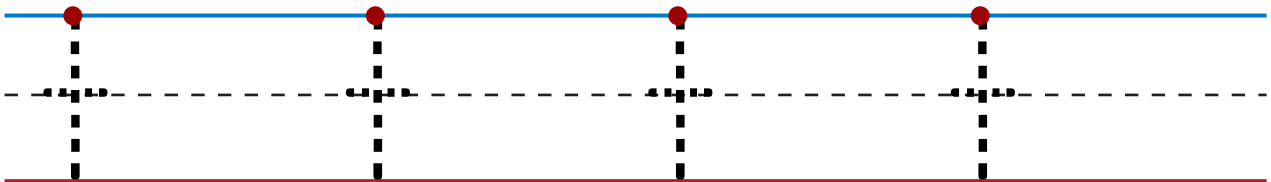
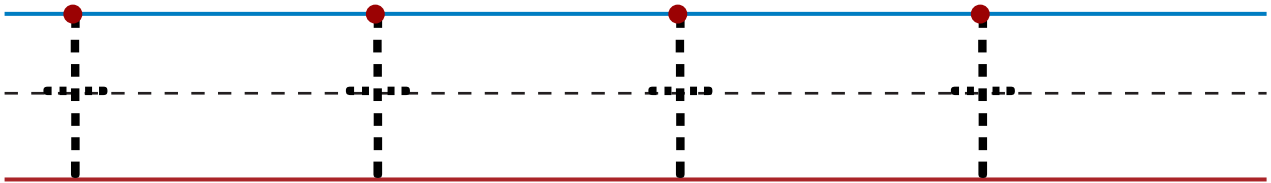
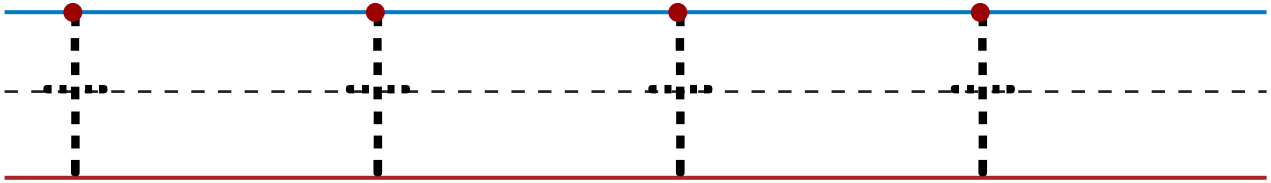
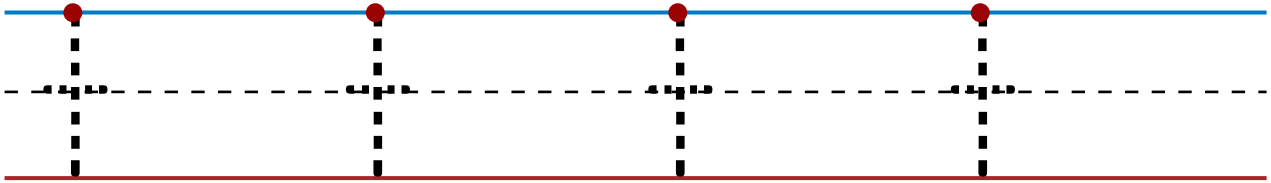

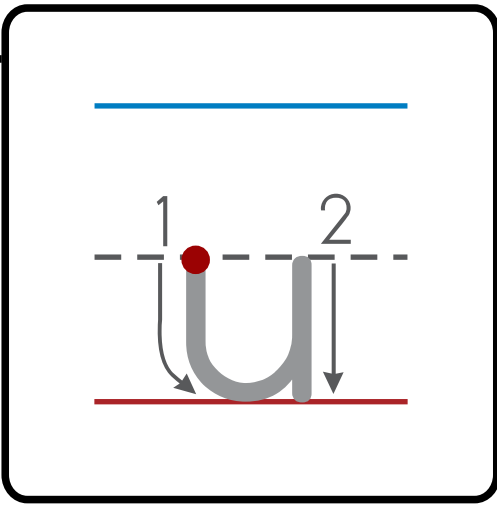

Name: _____

umbrella

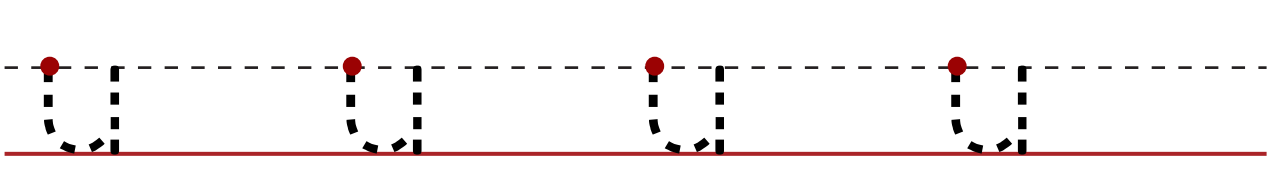
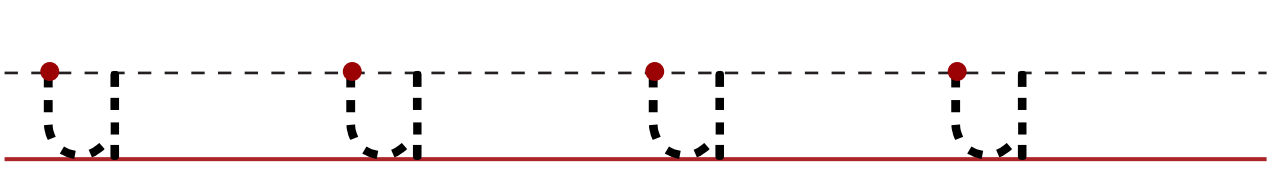
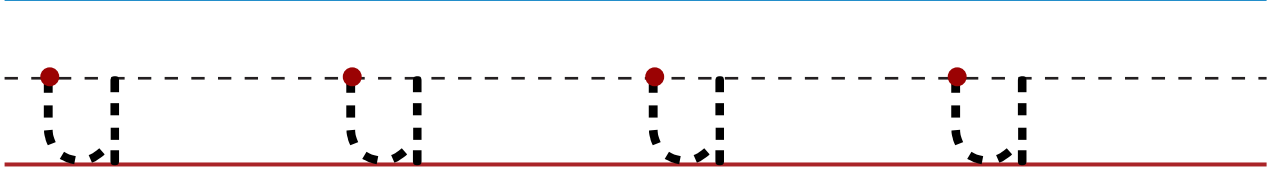
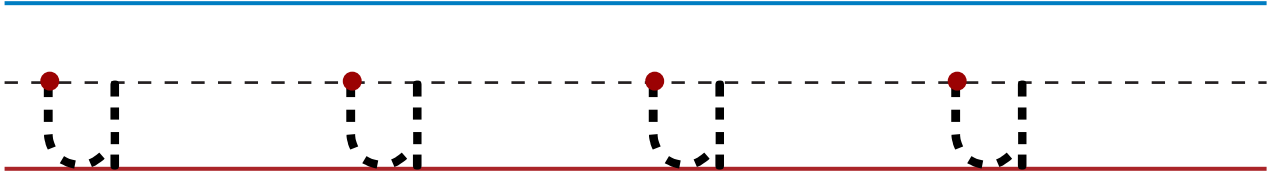
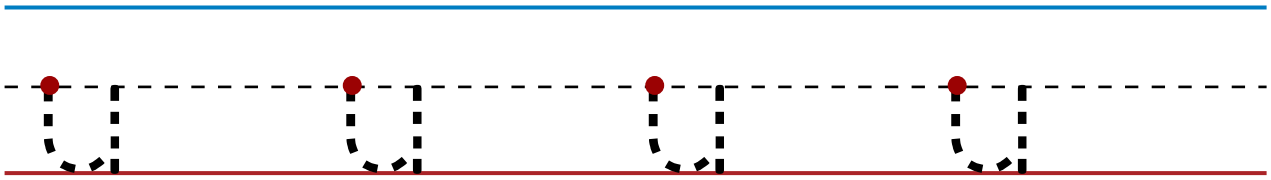

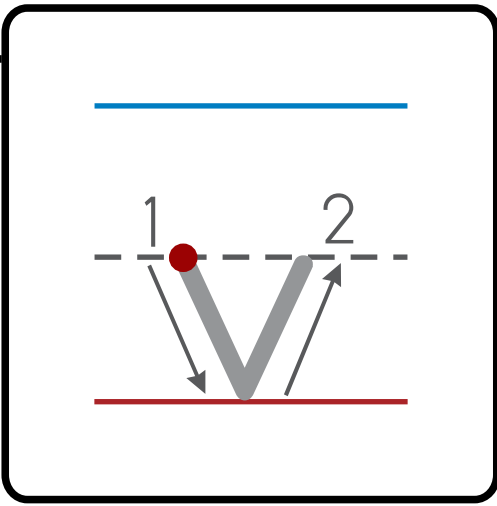

Name: _____

vase

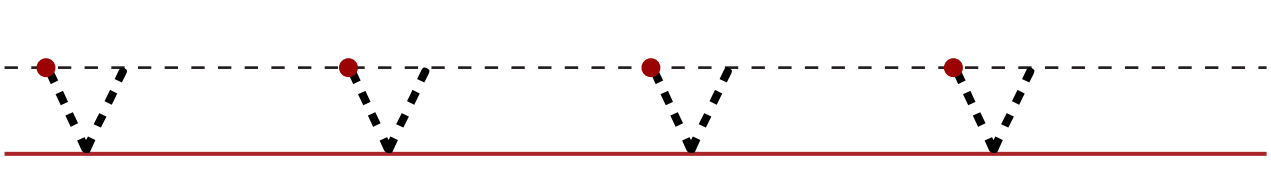
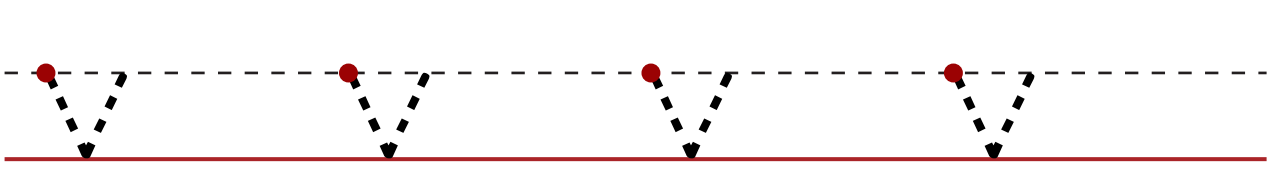
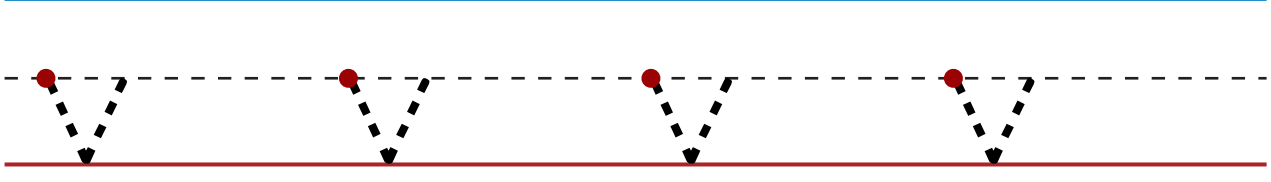
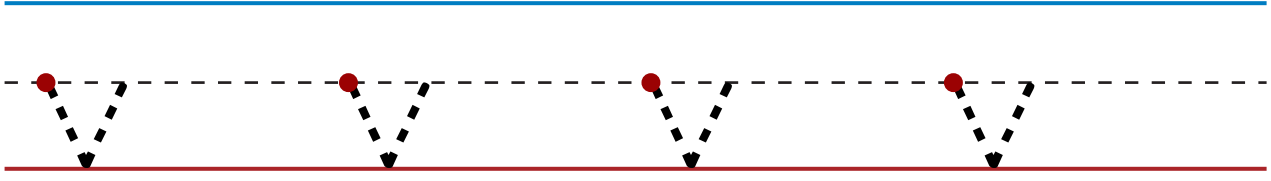
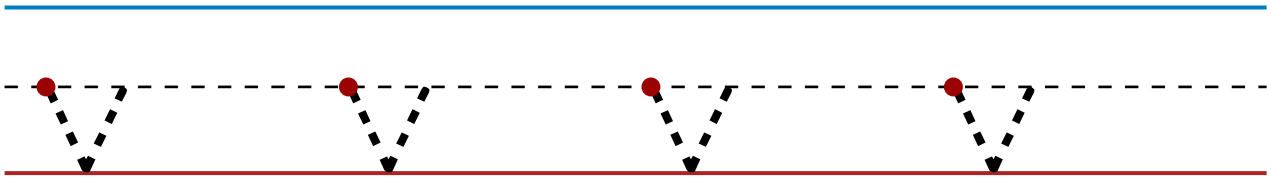

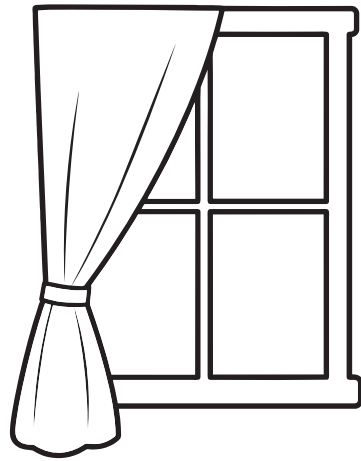
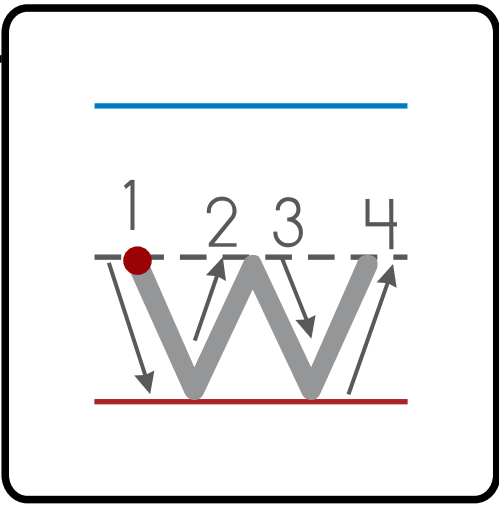

Name: _____

window

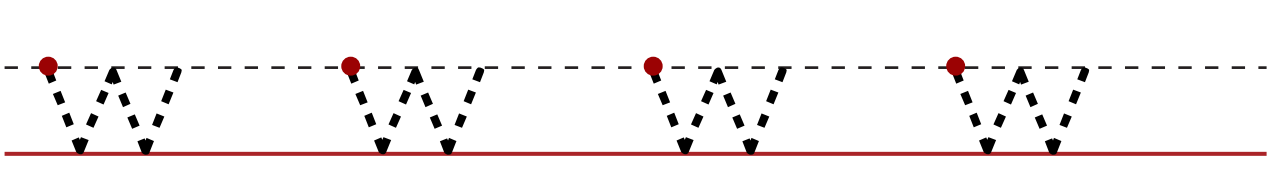
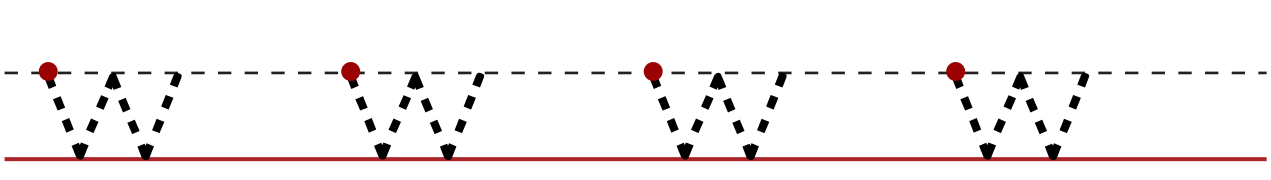
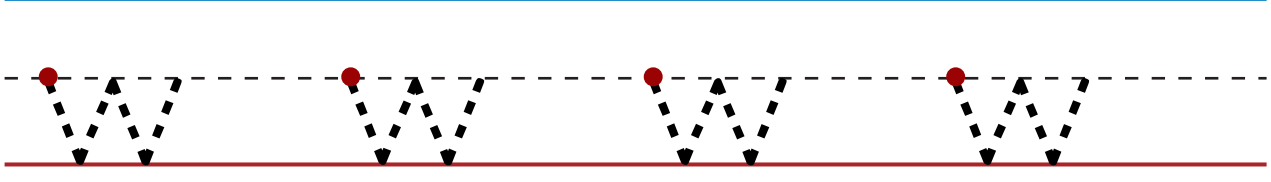
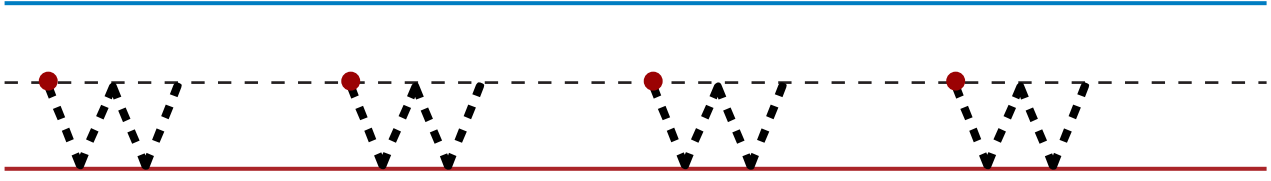
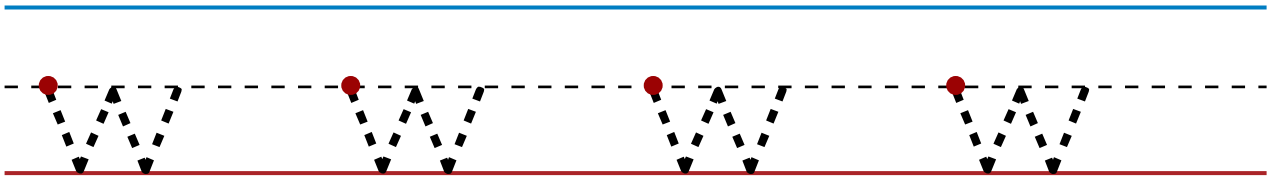

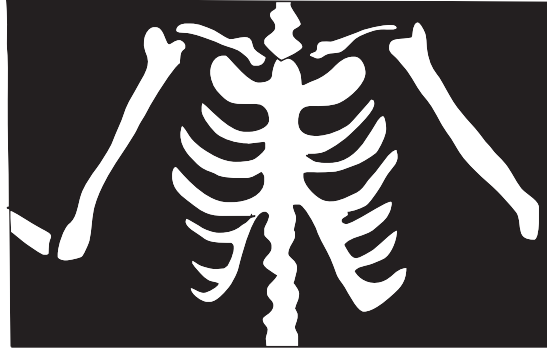
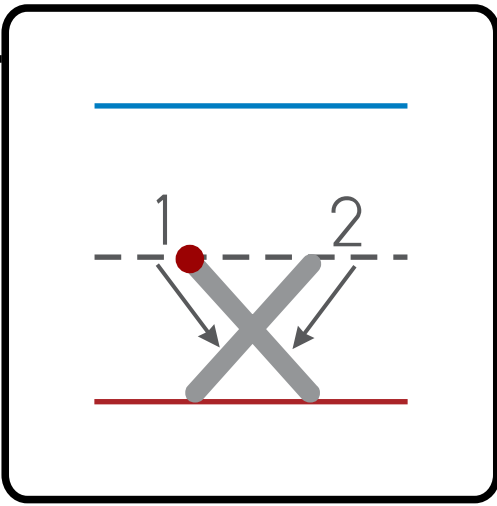

Name: _____

x-ray

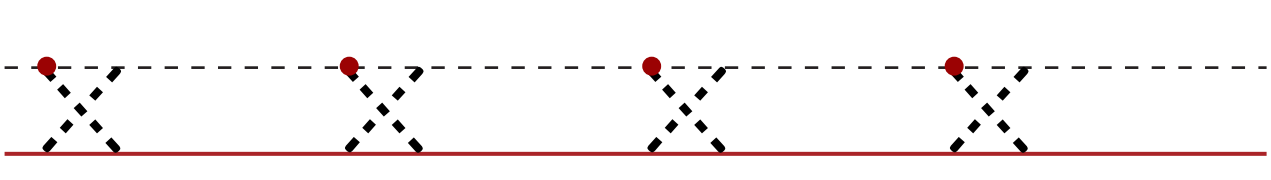
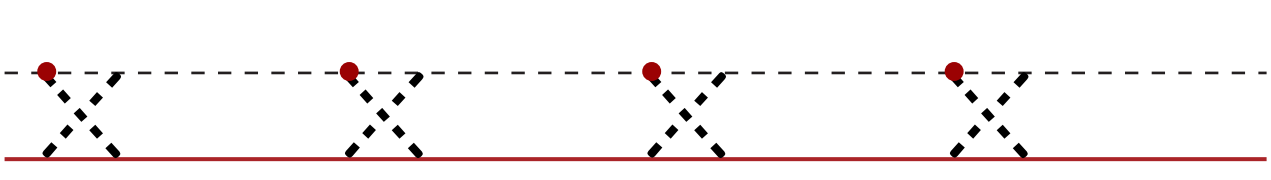
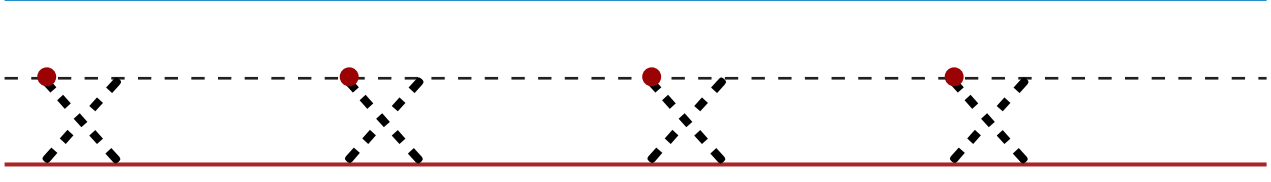
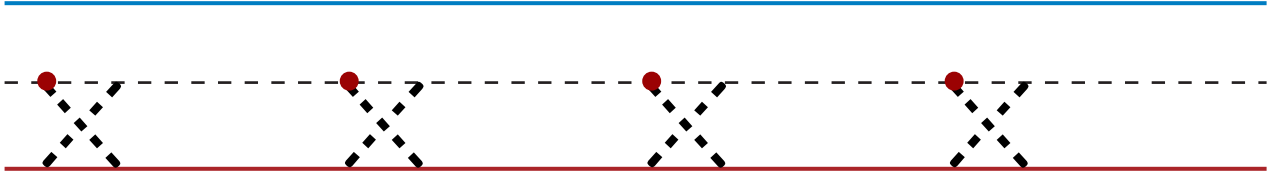
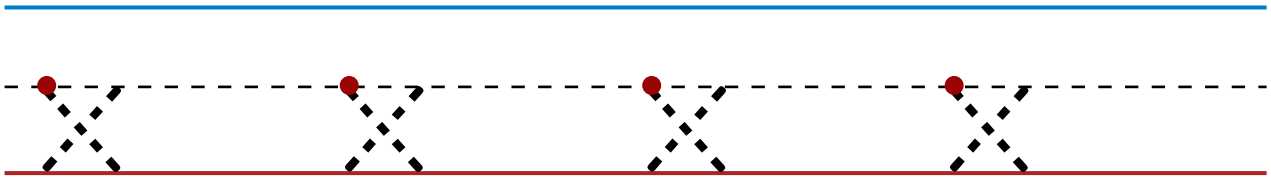

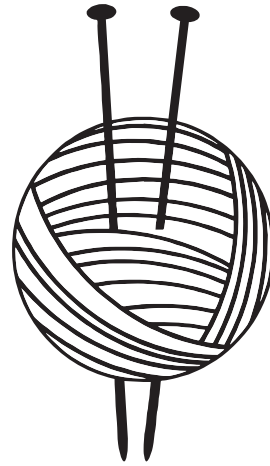
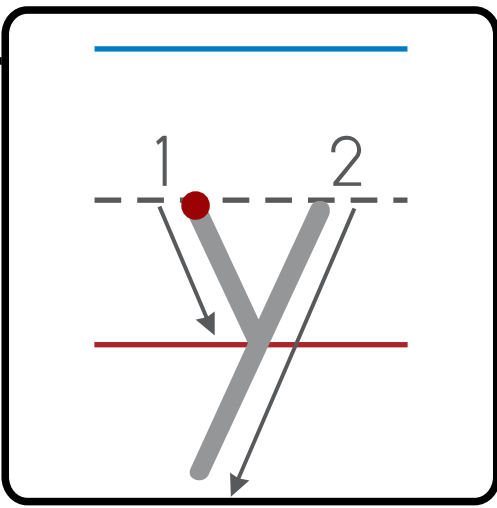

Name: _____

yarn

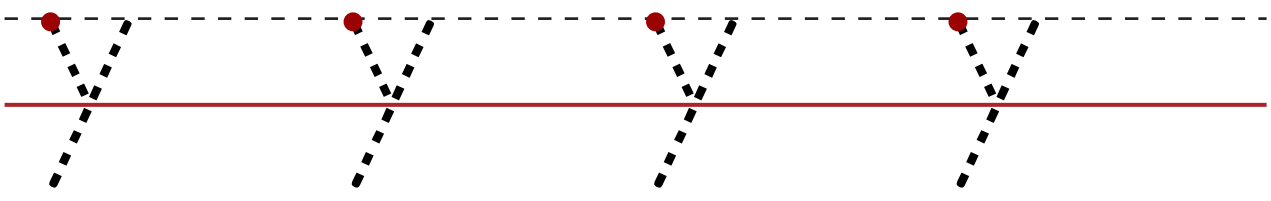
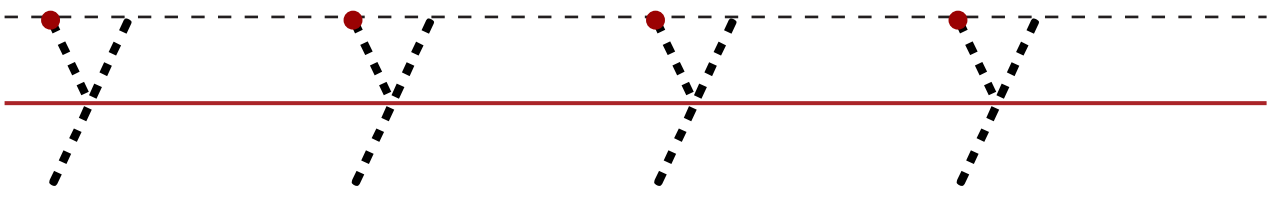
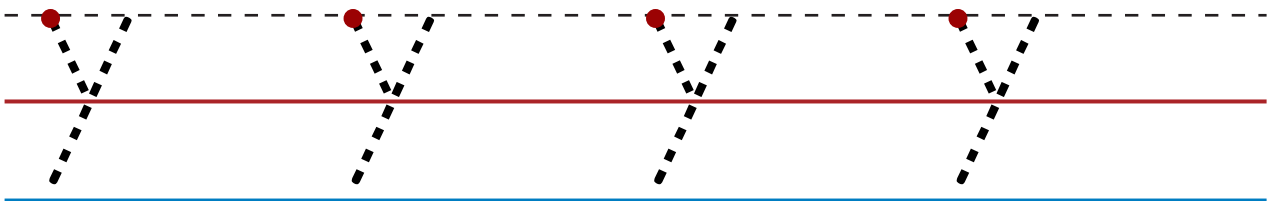
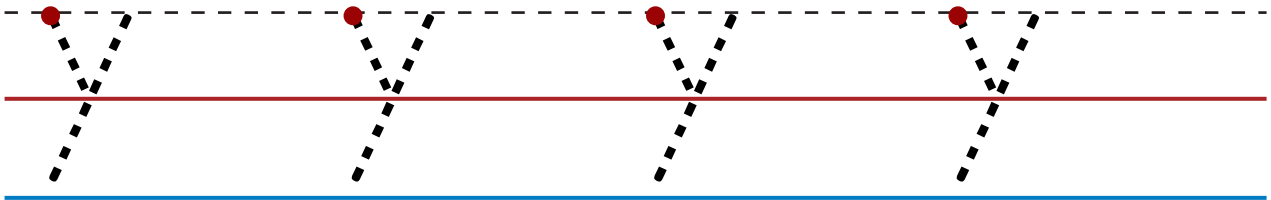
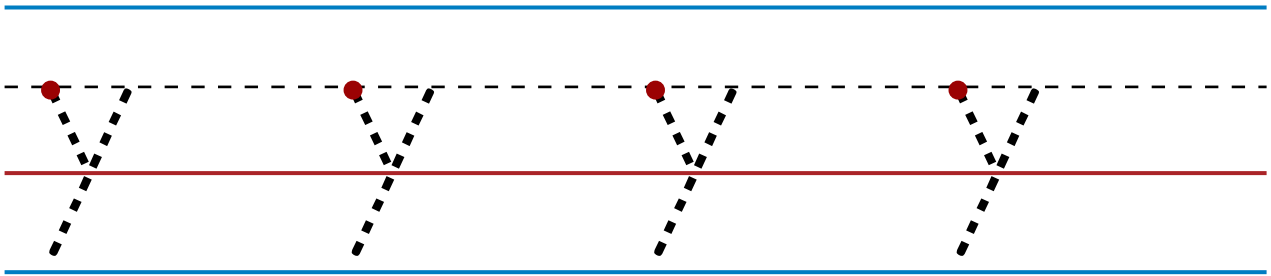

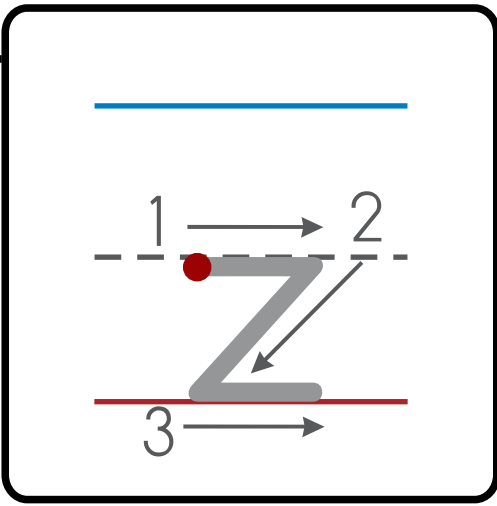

Name: _____

zebra

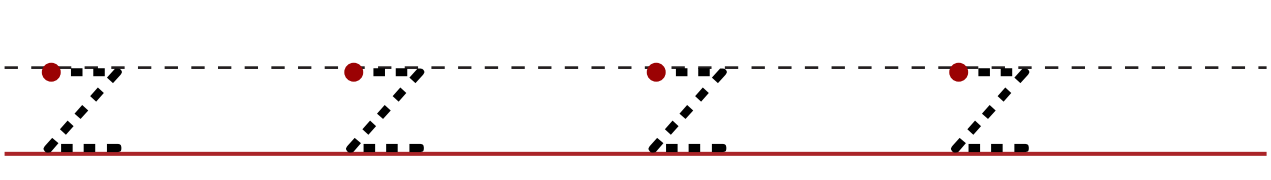
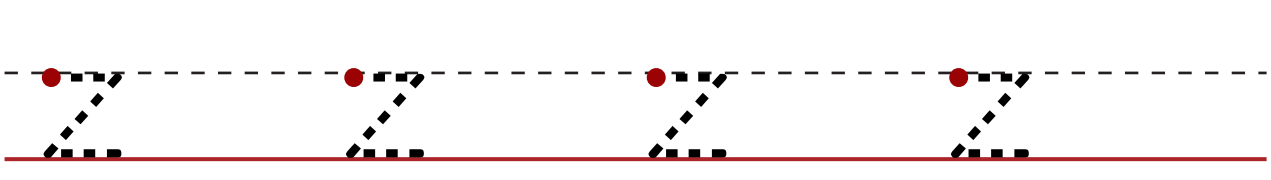
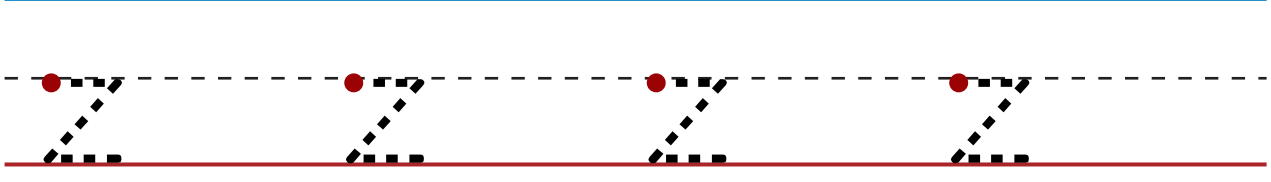
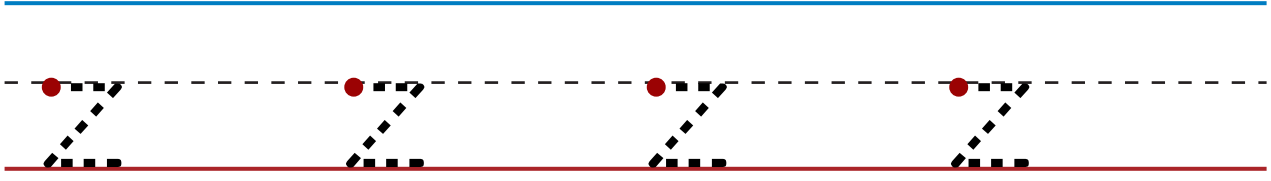
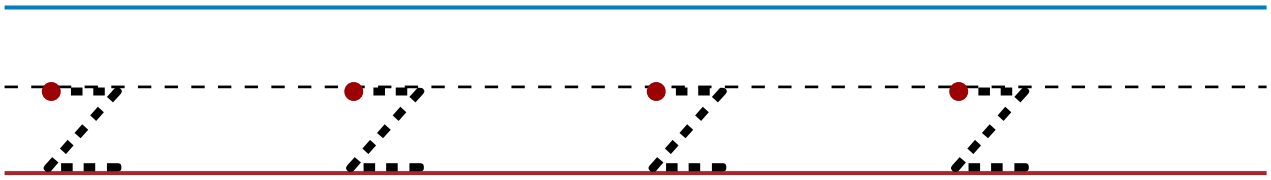

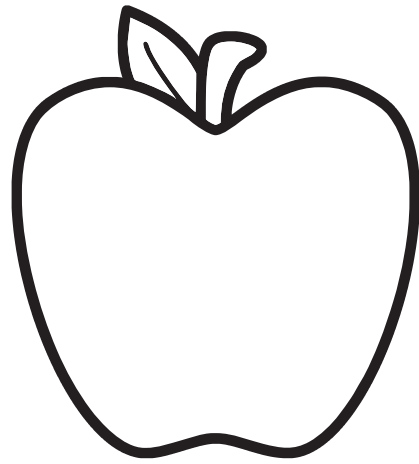
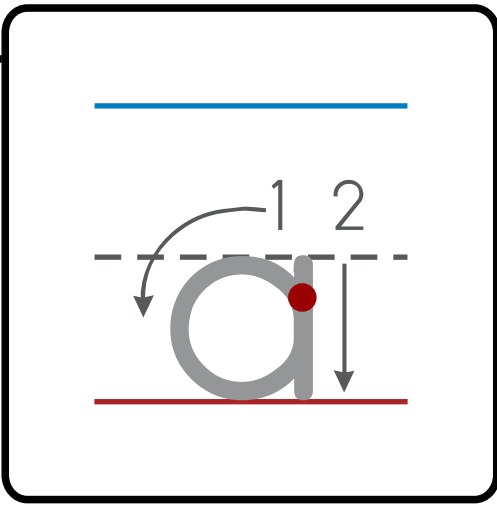

Name: _____

apple

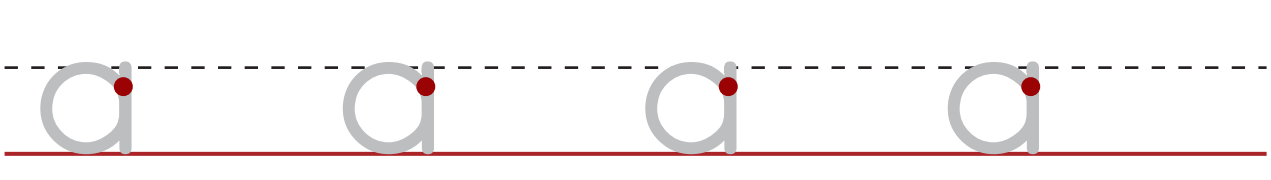
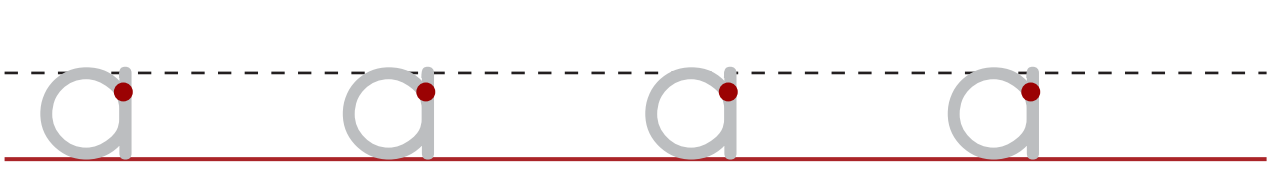
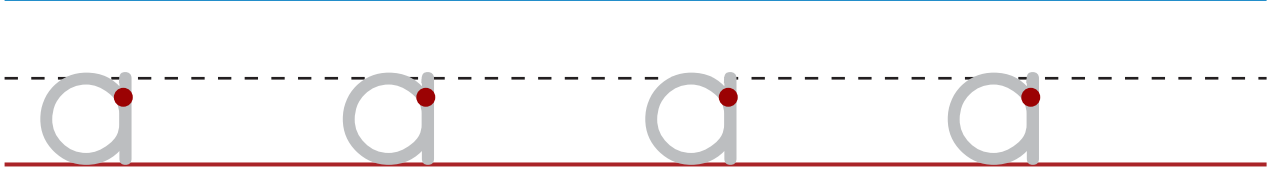
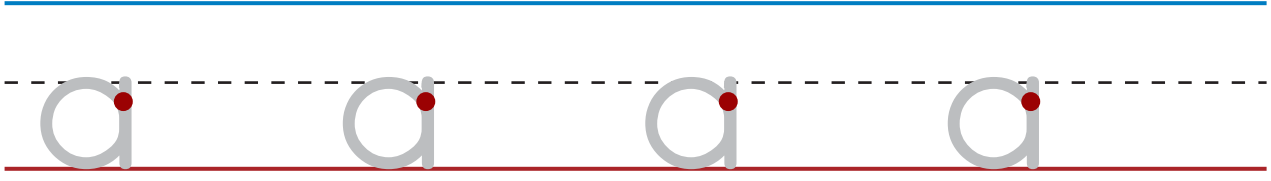
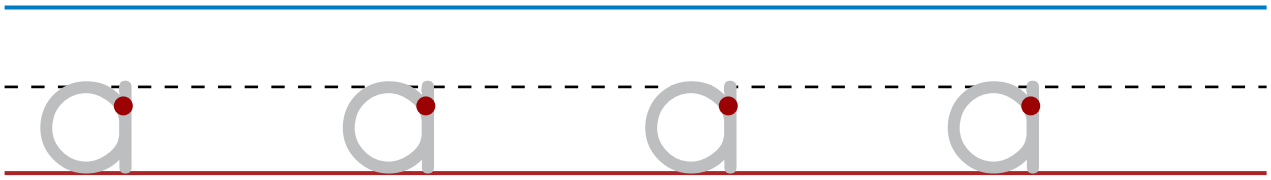

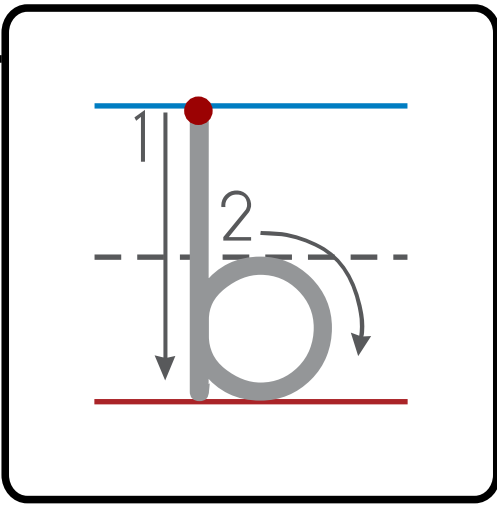

Name: _____

bear

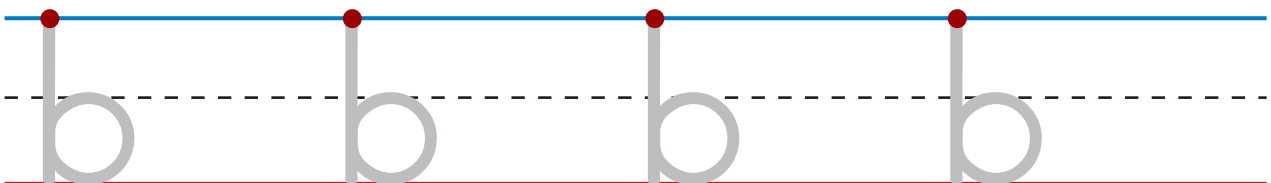
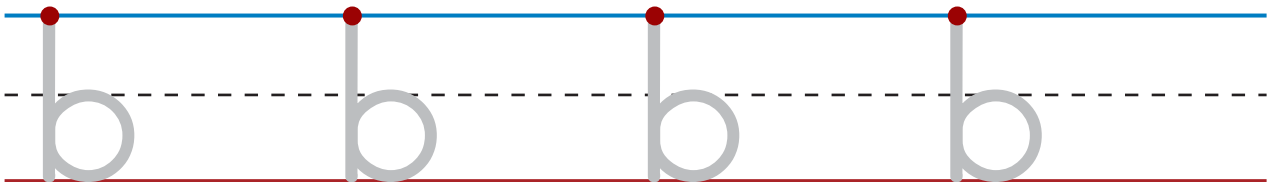
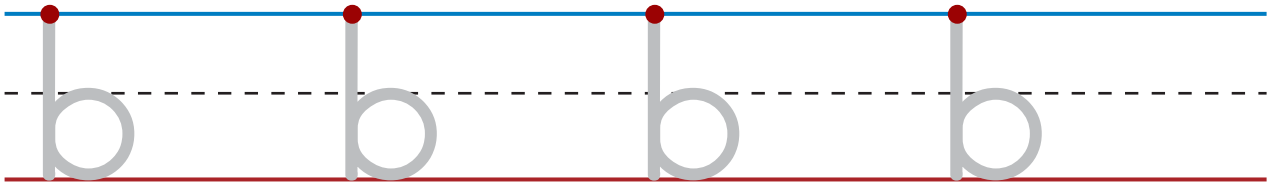
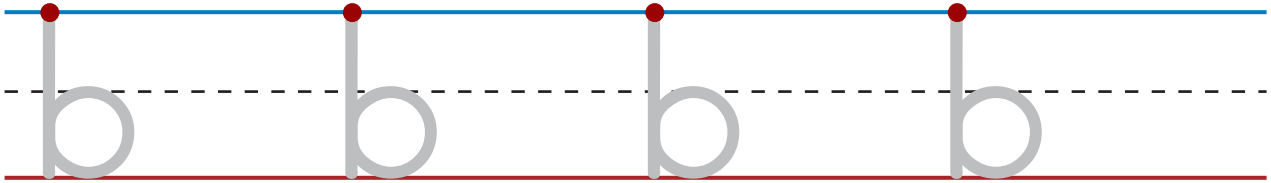
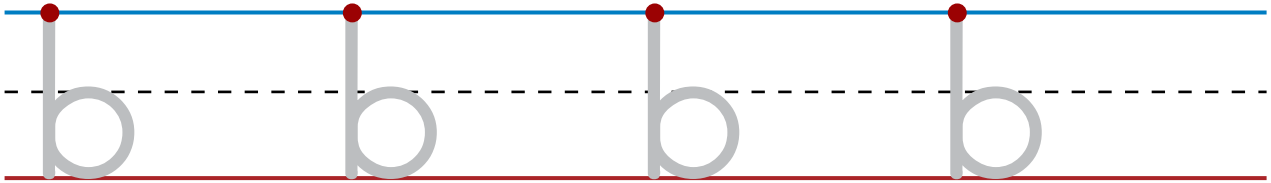

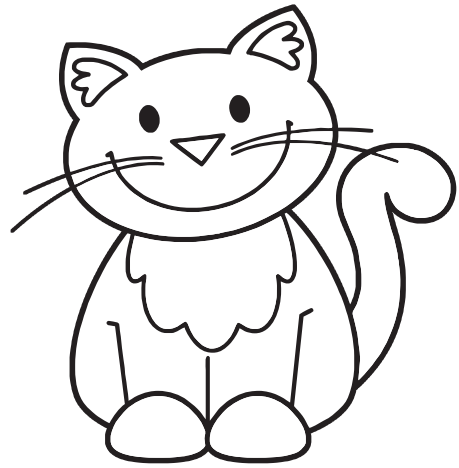
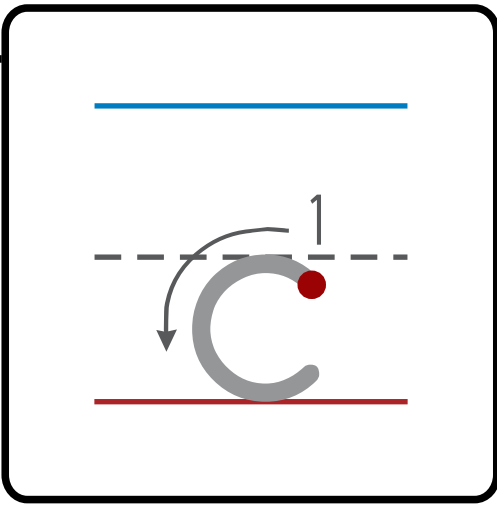

Name: _____

cat

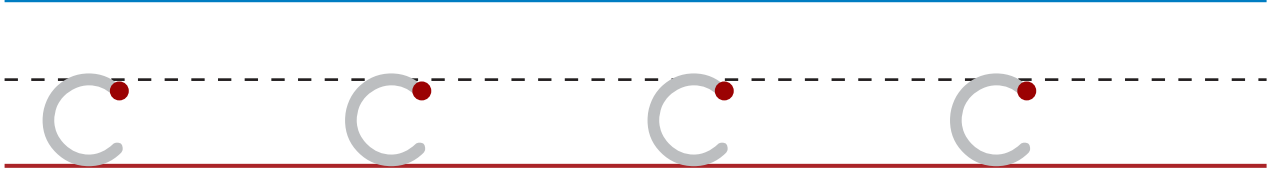
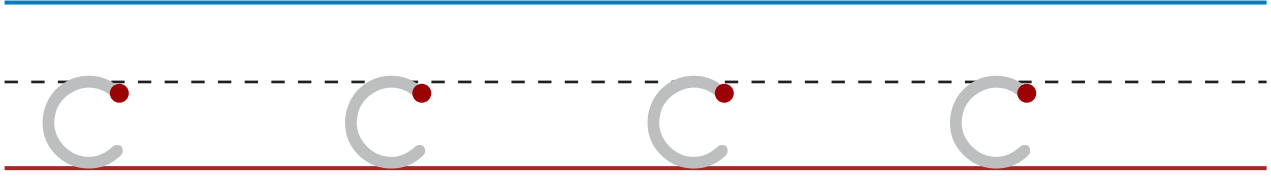
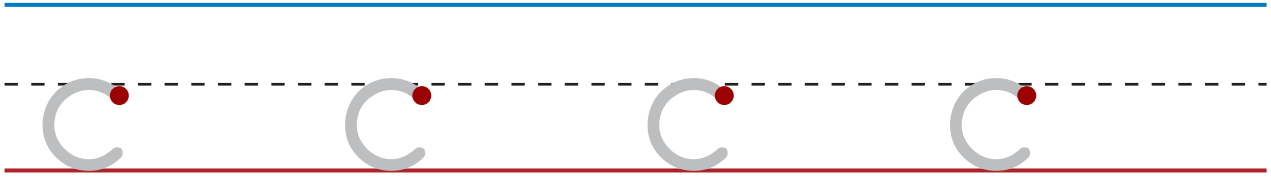
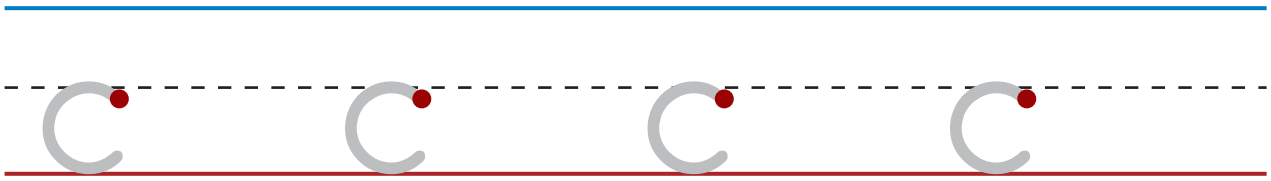
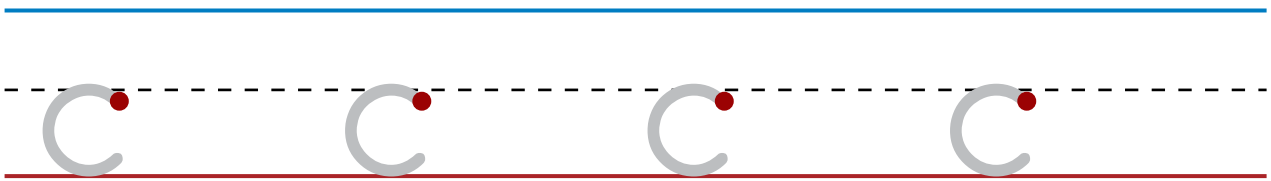

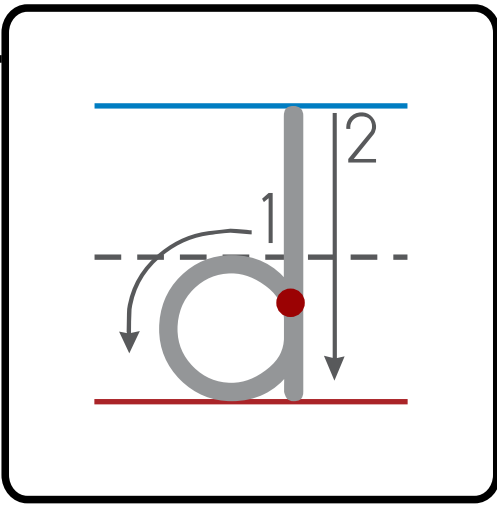

Name: _____

dog

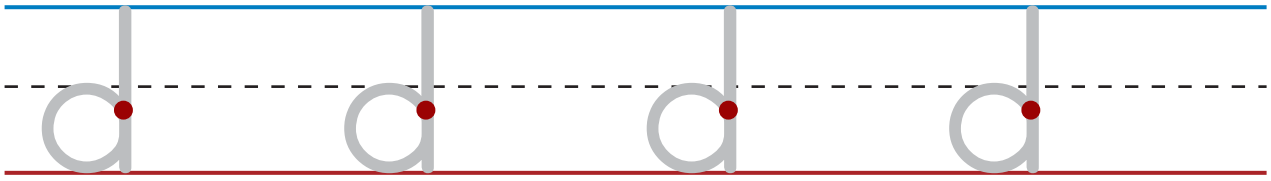
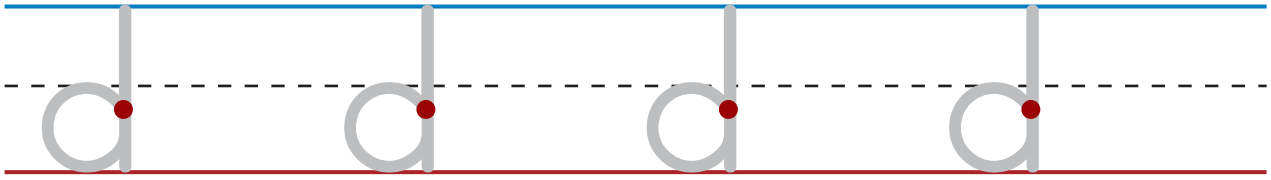
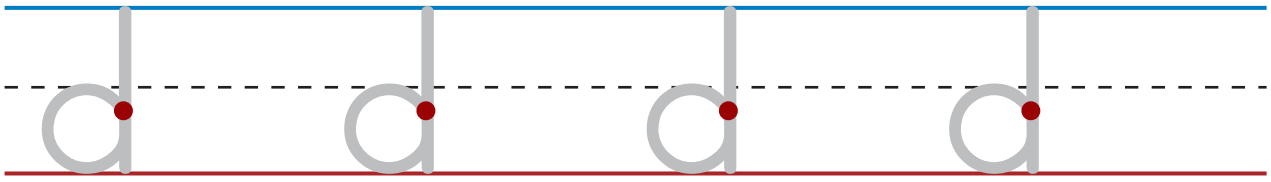
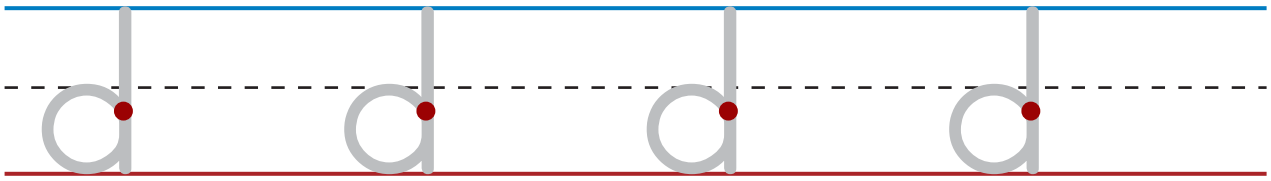
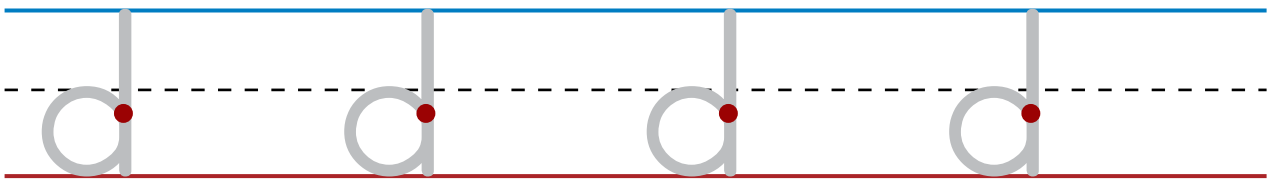

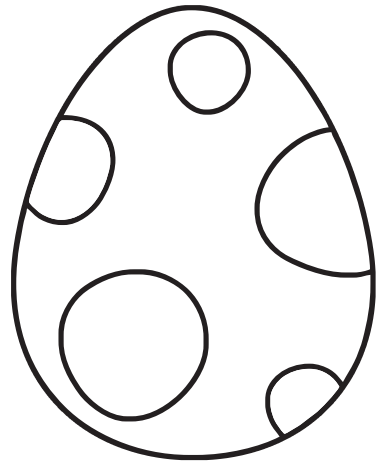
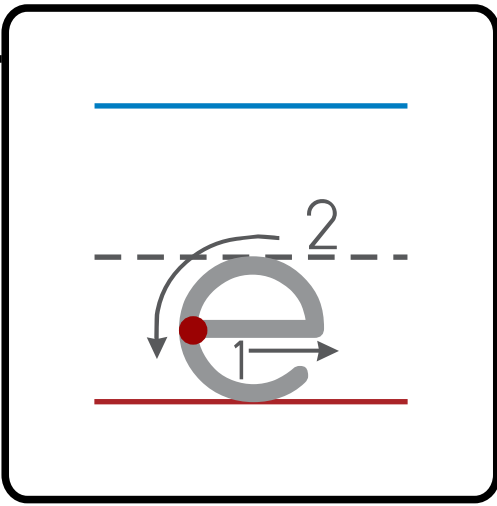

Name: _____

egg

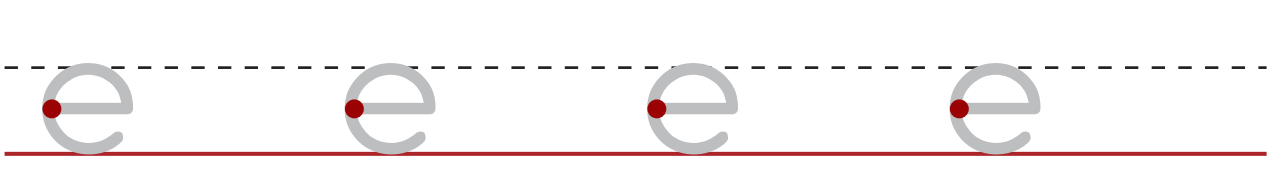
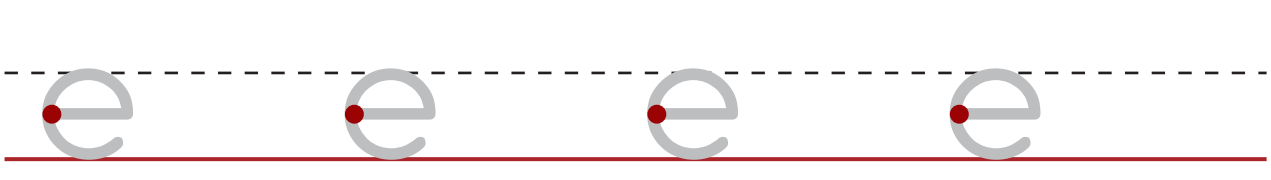
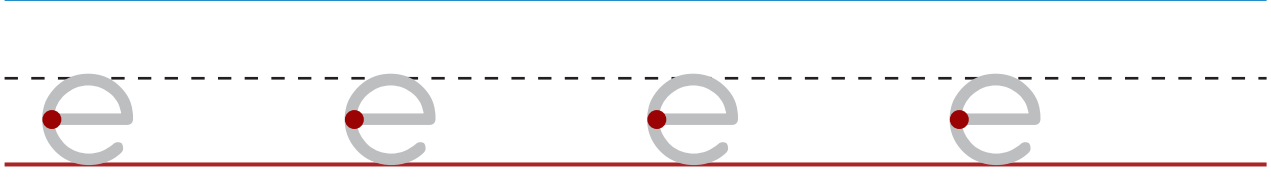
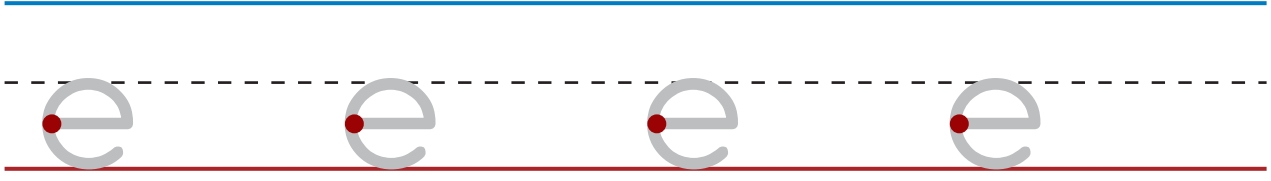
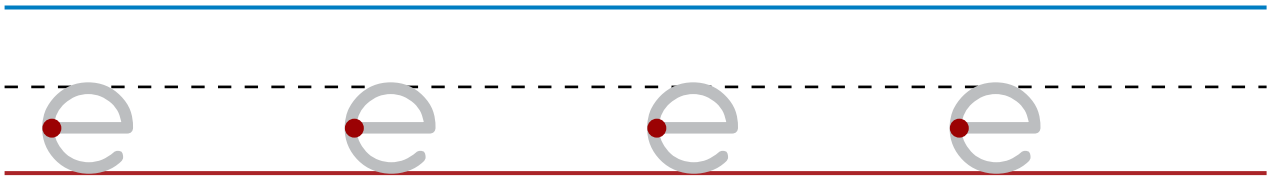

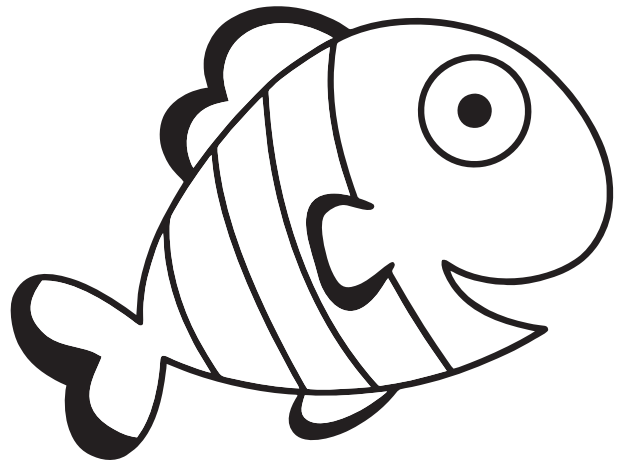
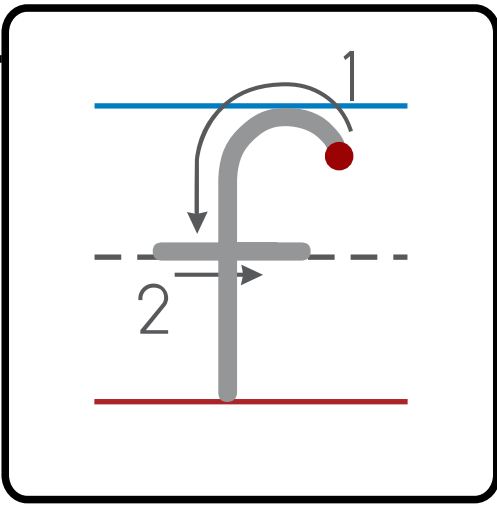

Name: _____

fish

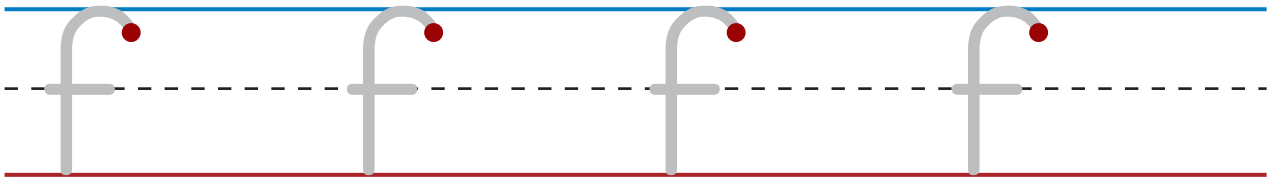
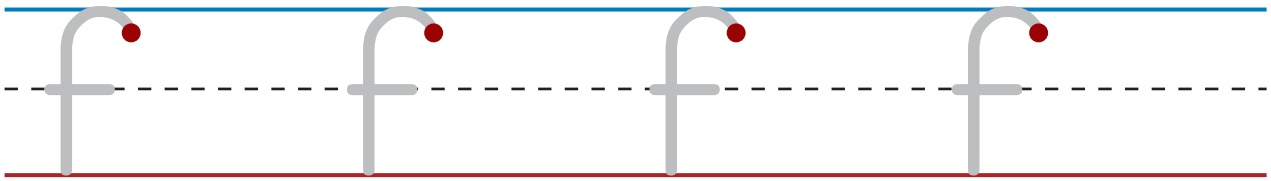
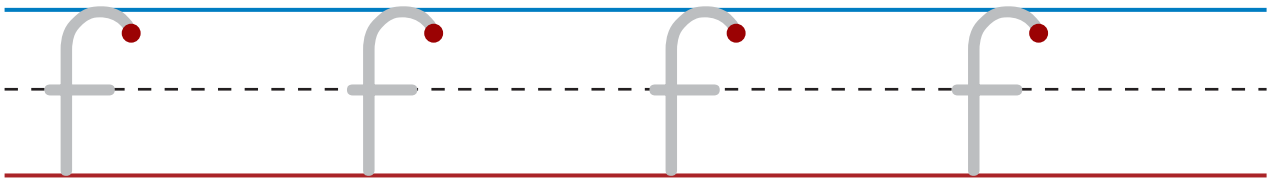
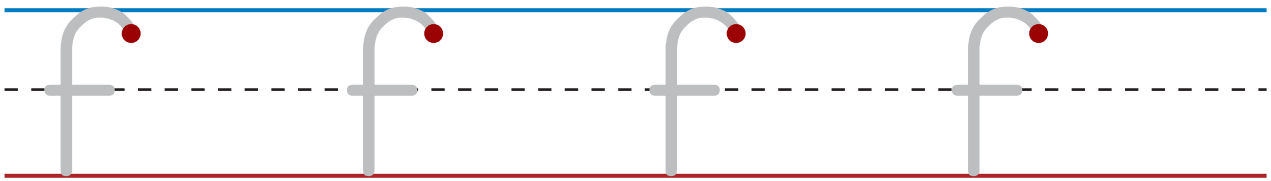
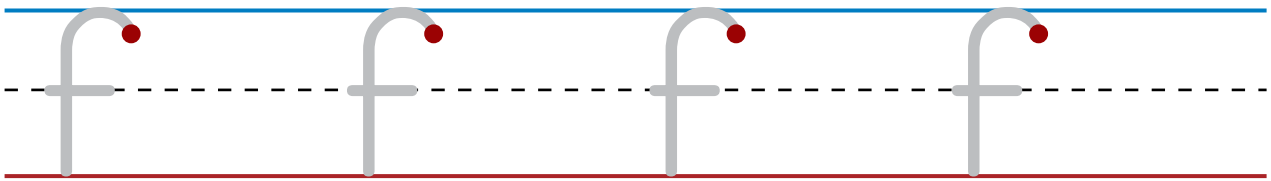

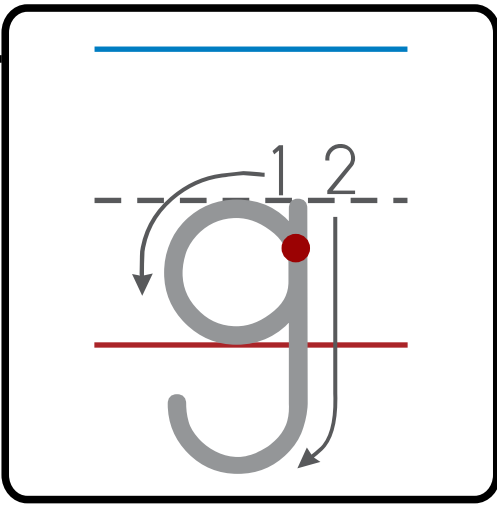

Name: _____

game

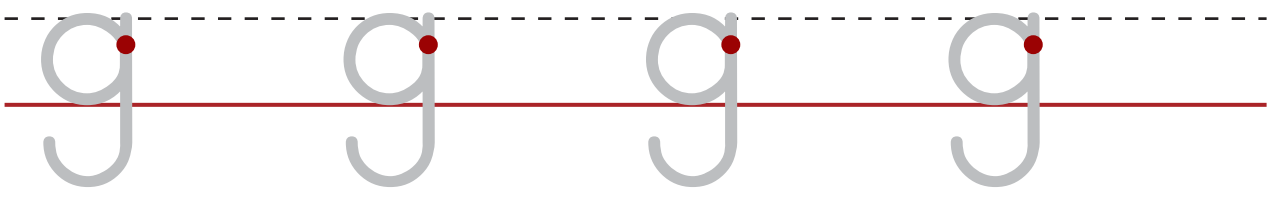
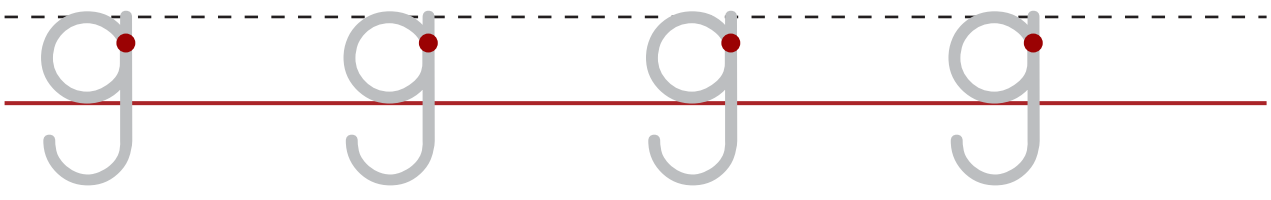
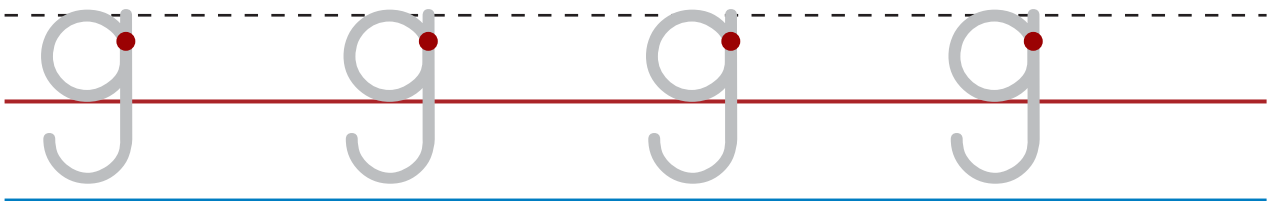
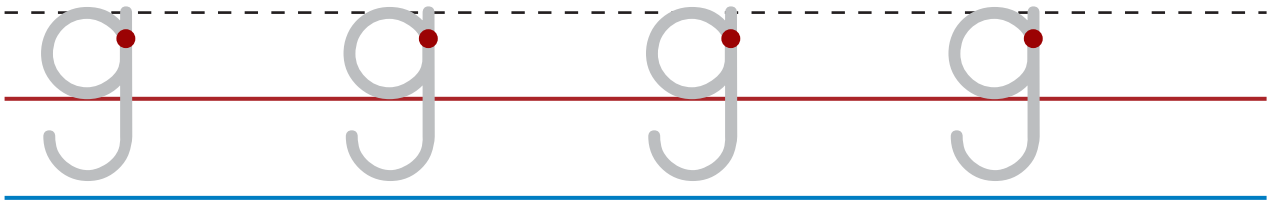
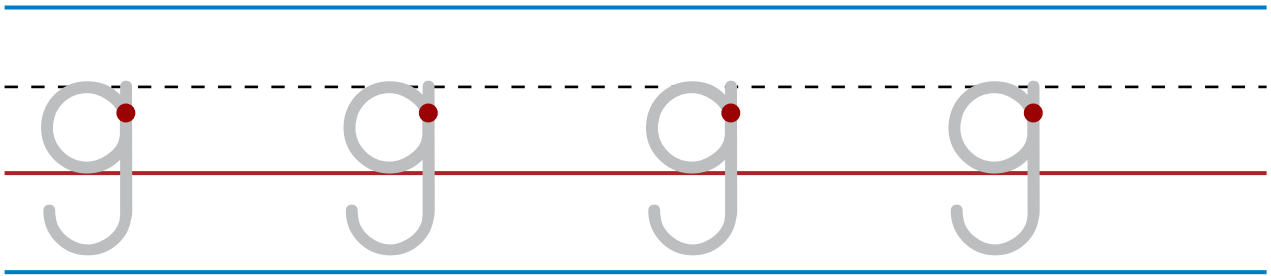

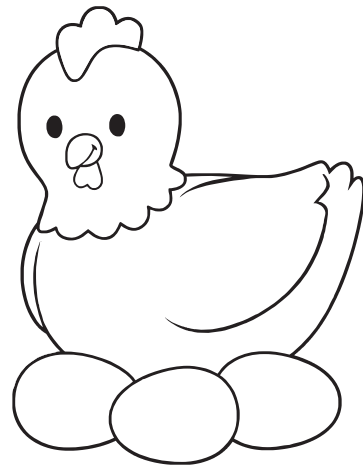
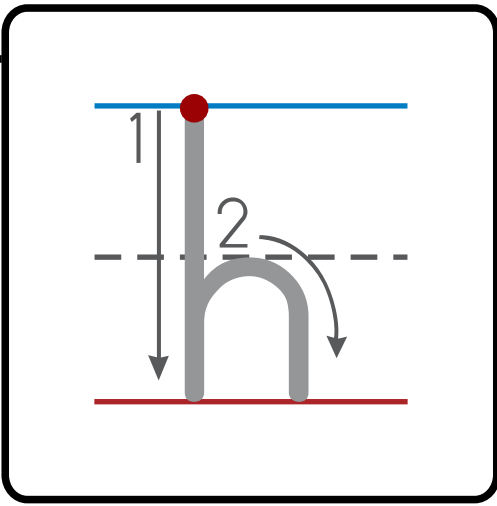

Name: _____

hen

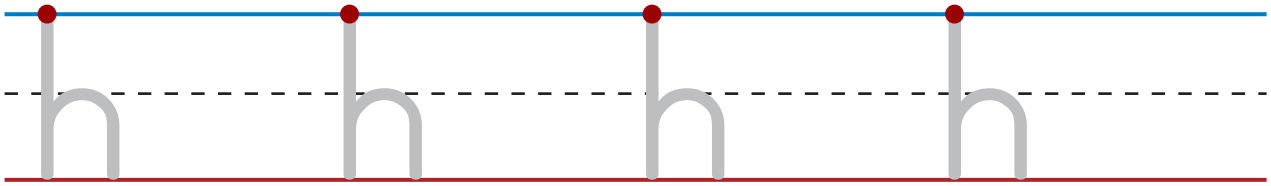
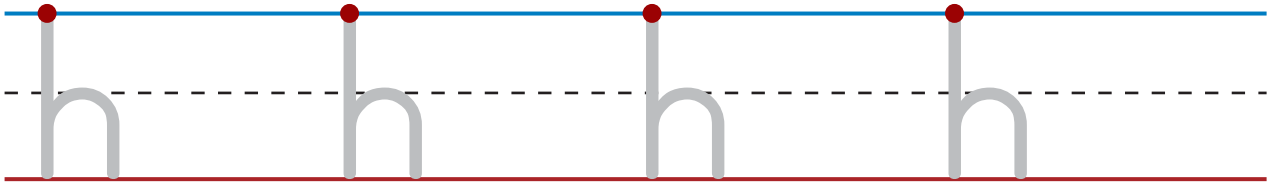
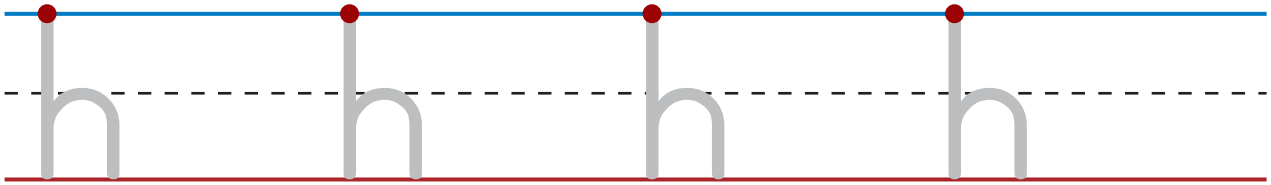
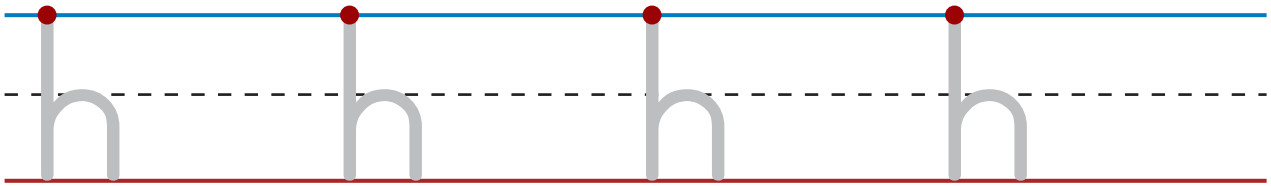
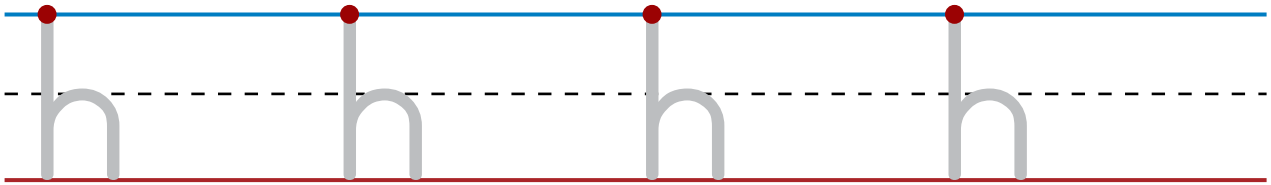

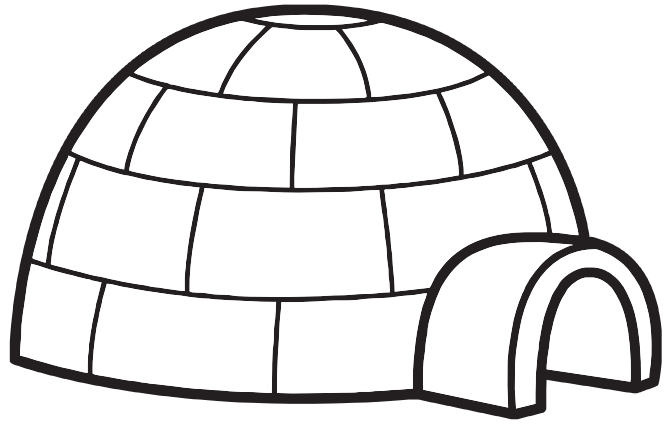
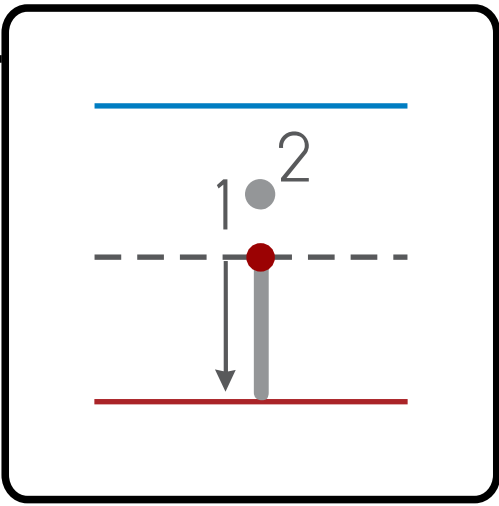

Name: _____

igloo

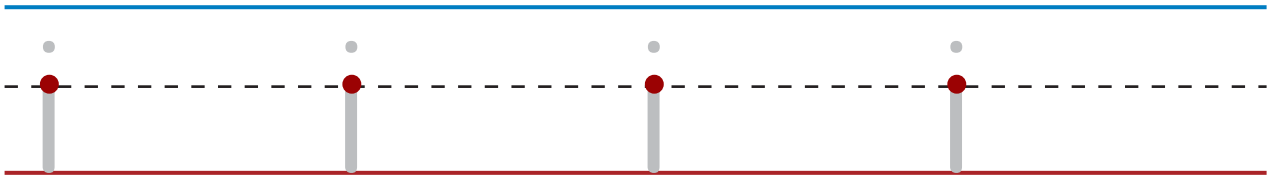
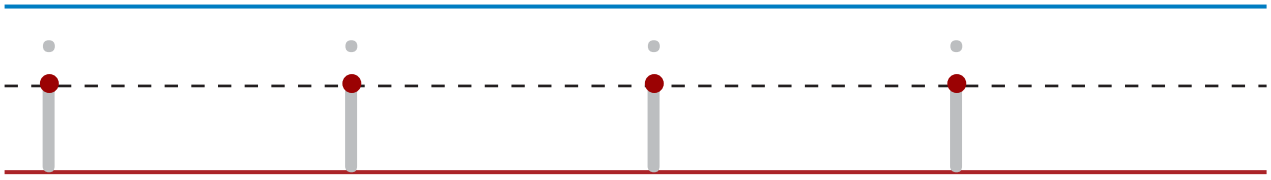
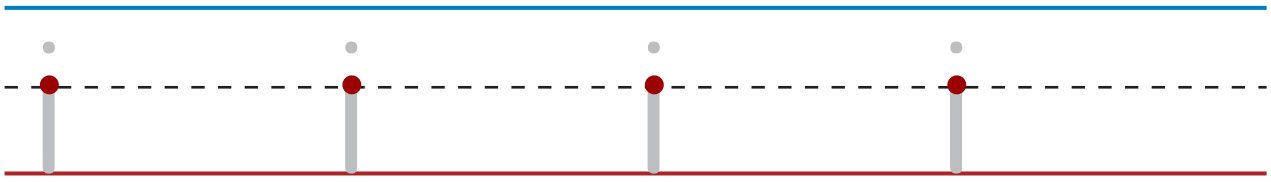
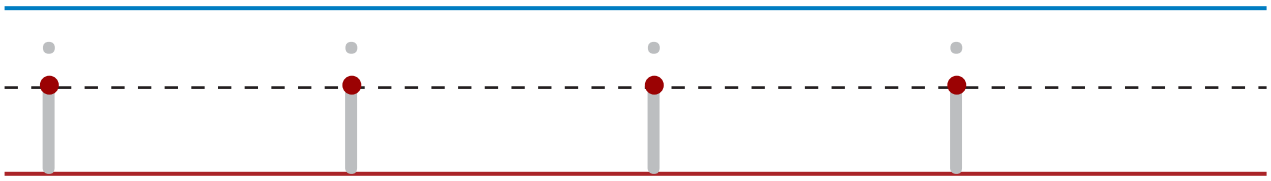
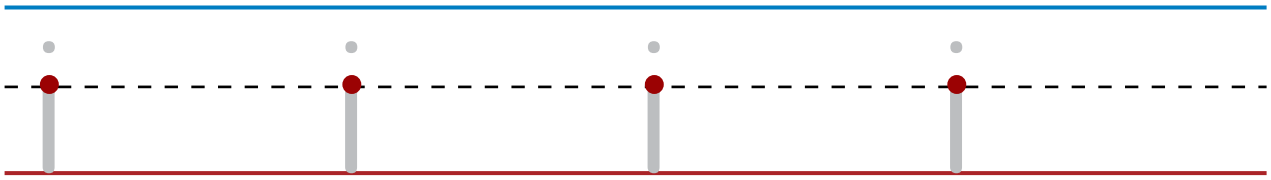

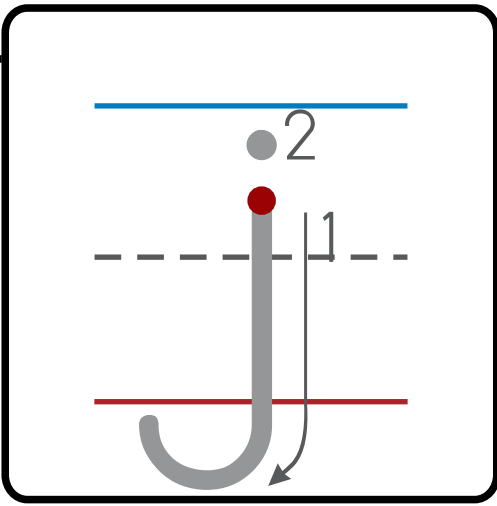

Name: _____

jacket

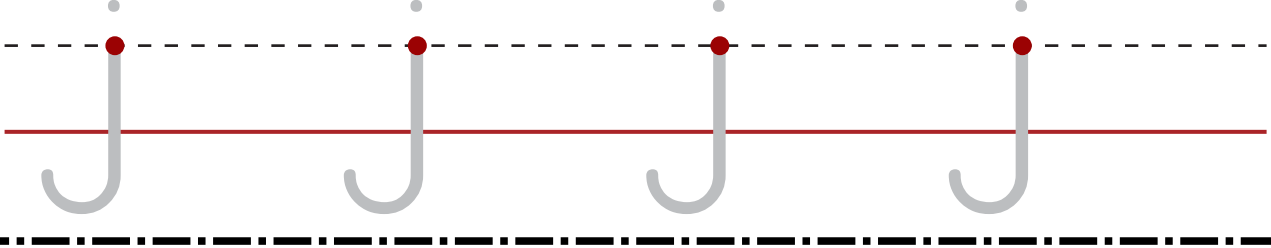
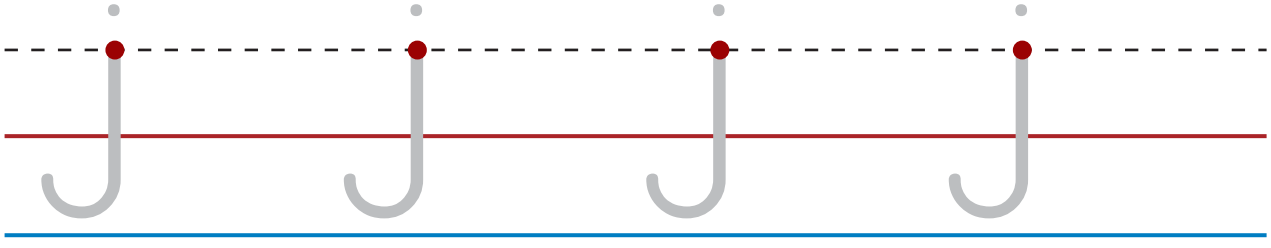
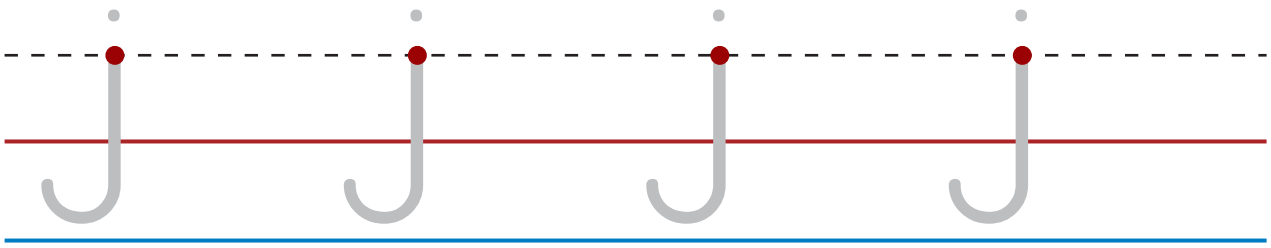
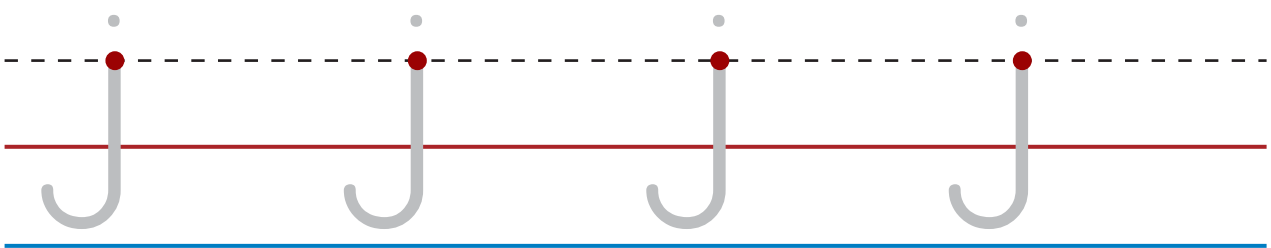
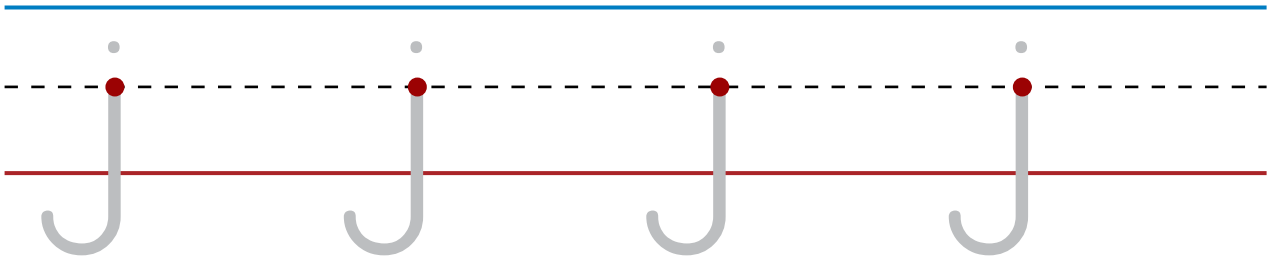

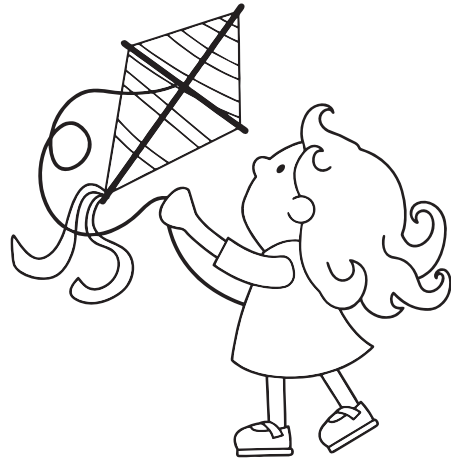
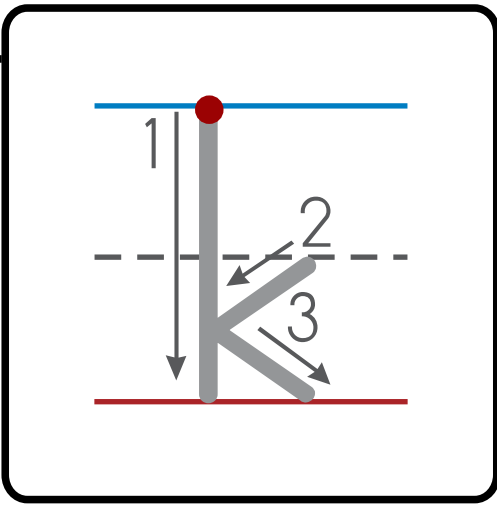

Name: _____

kite

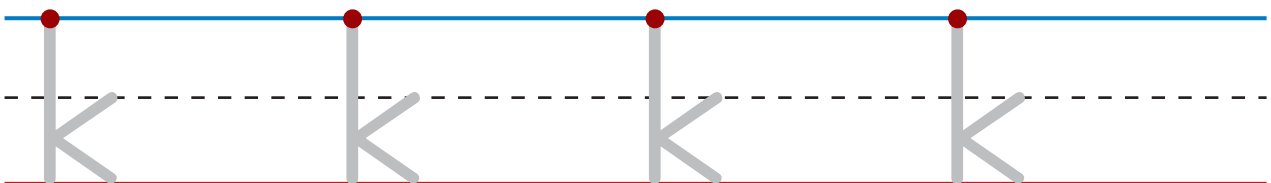
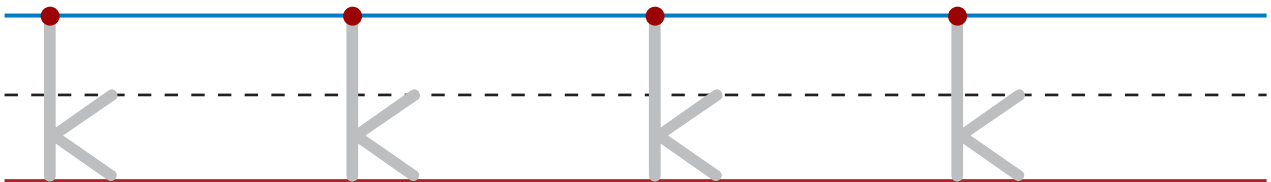
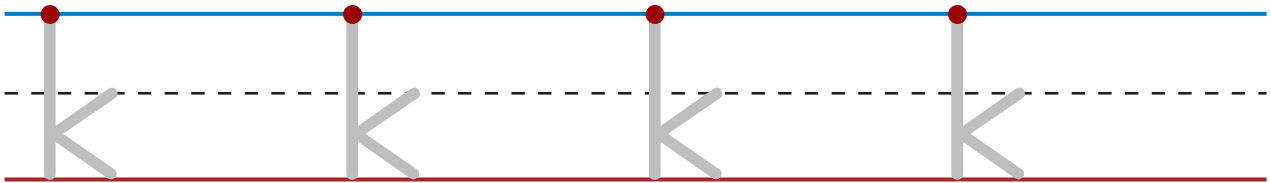
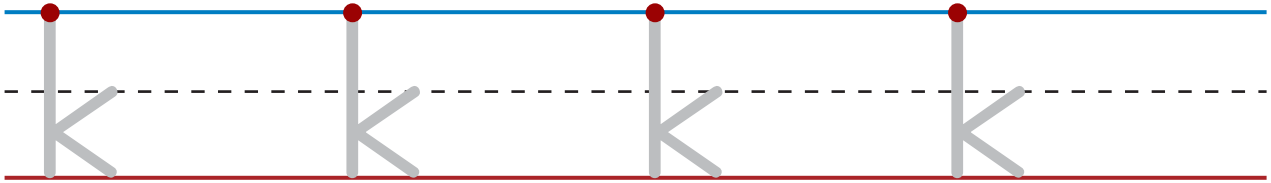
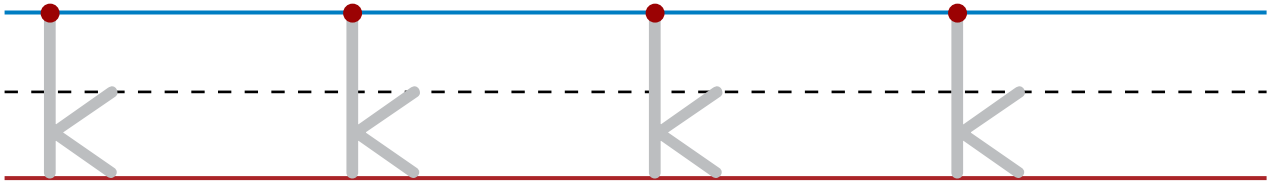

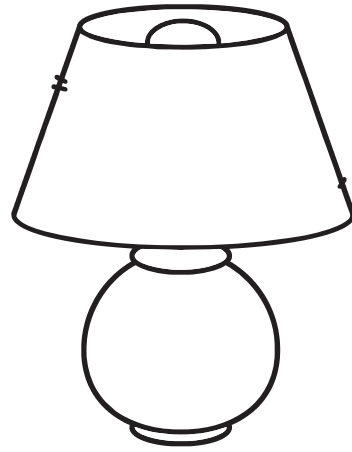
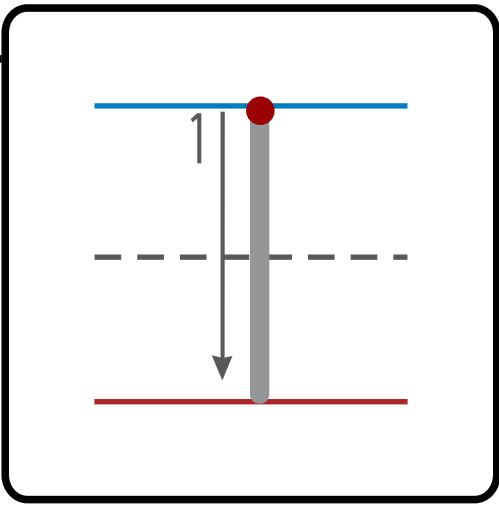

Name: _____

lamp

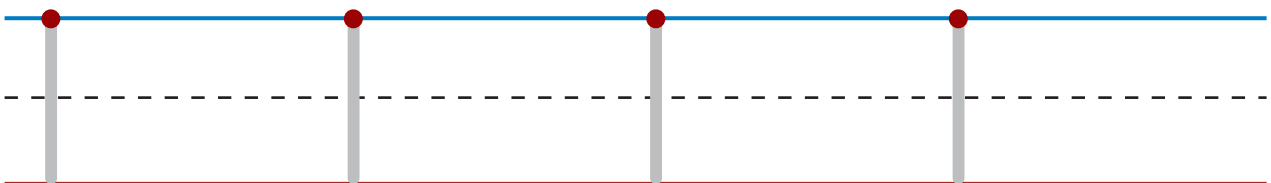
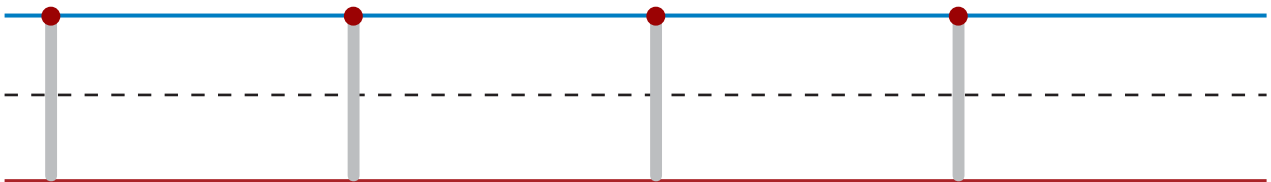
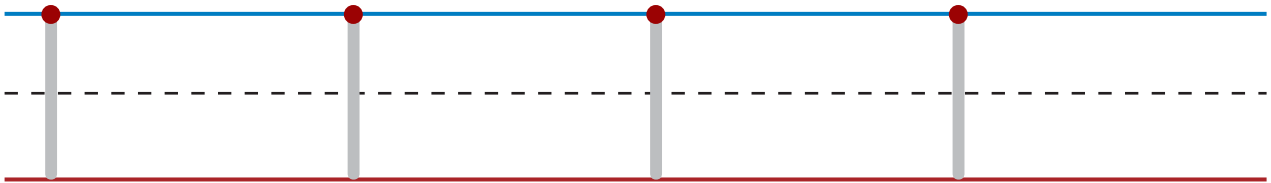
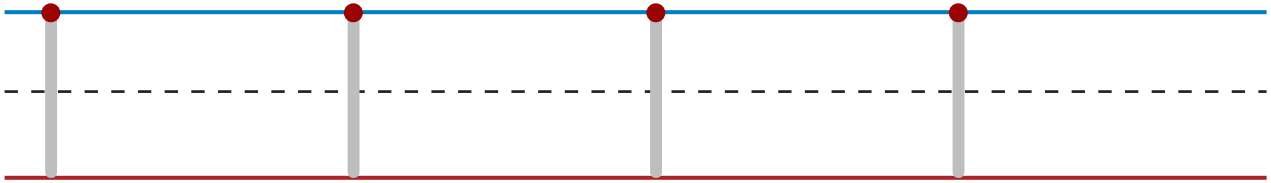
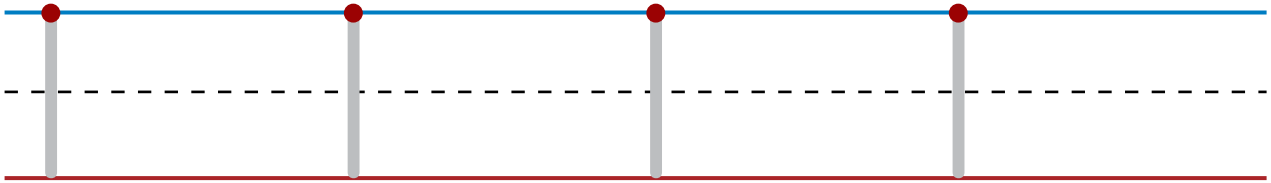

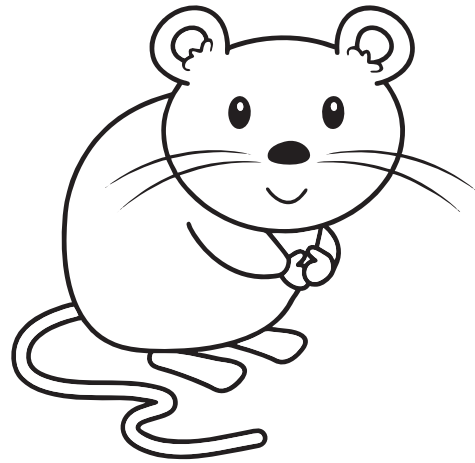
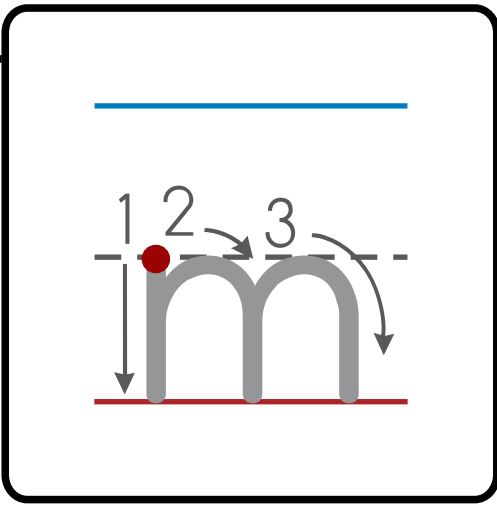

Name: _____

mouse

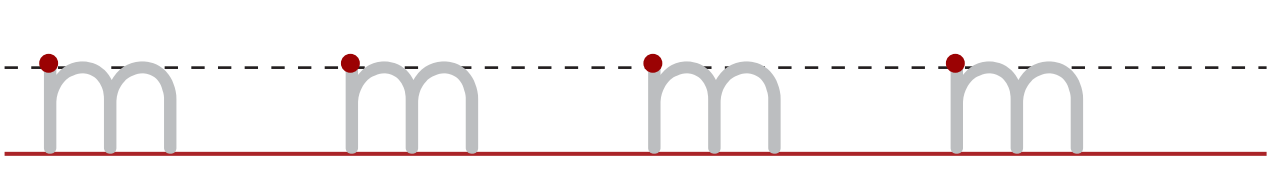
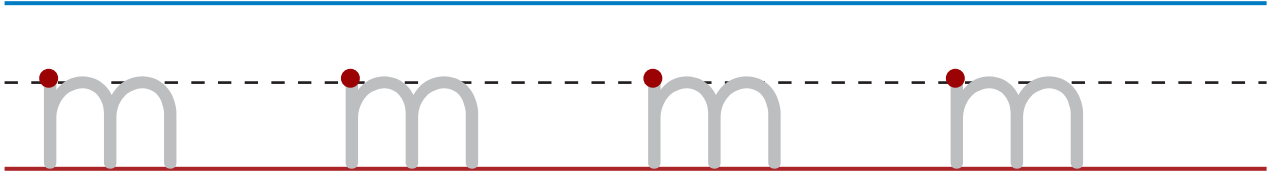
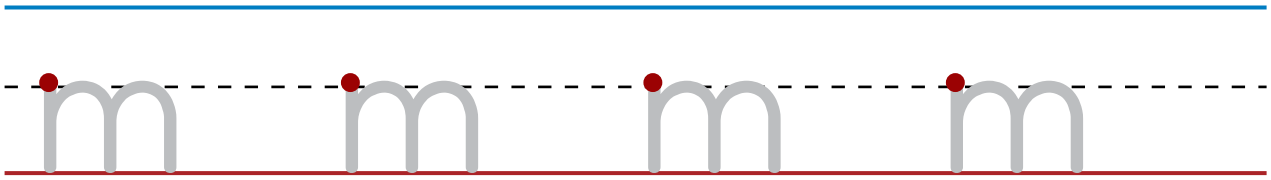

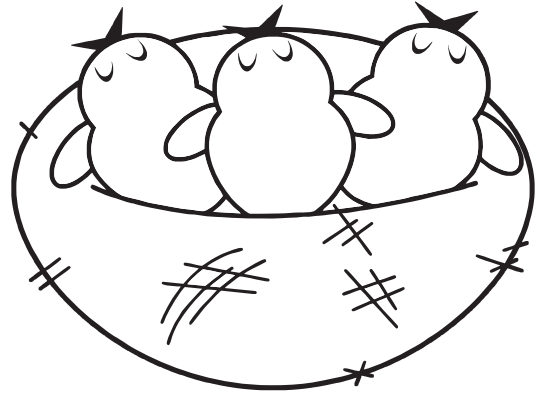
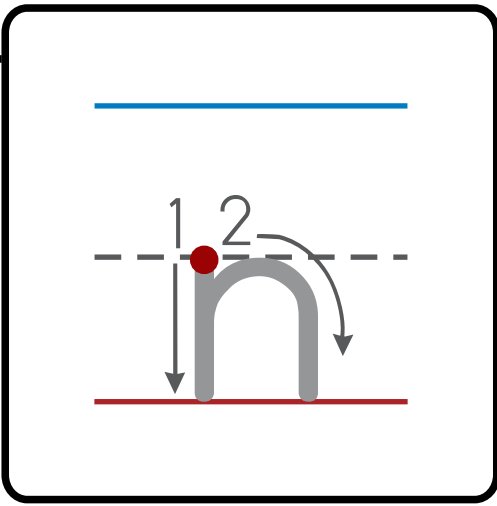

Name: _____

nest

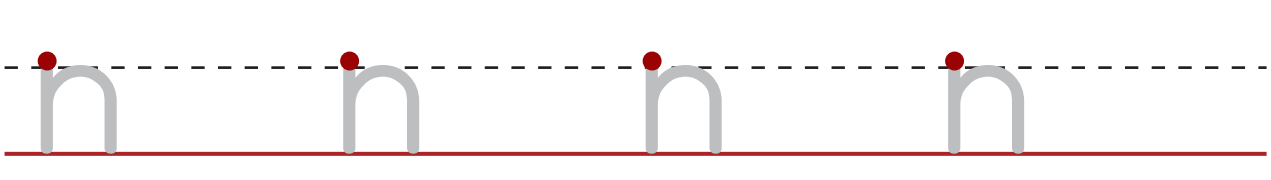
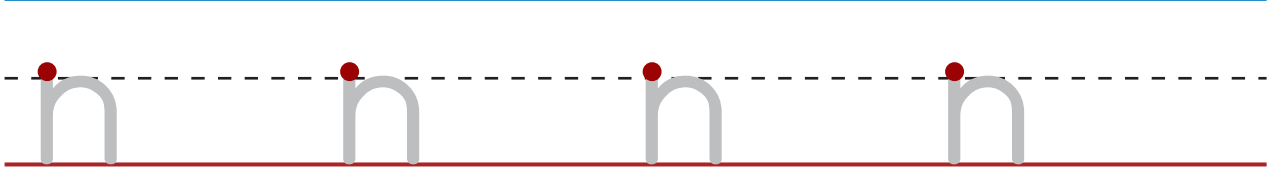
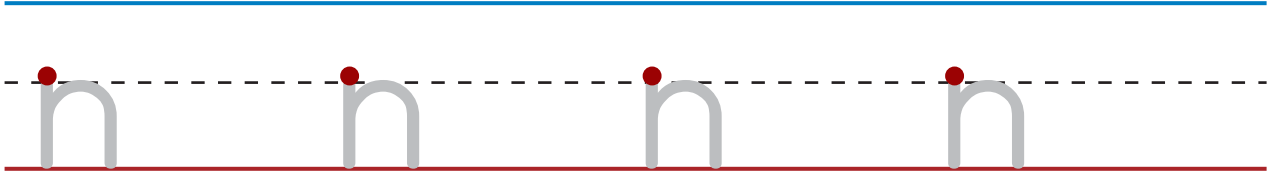
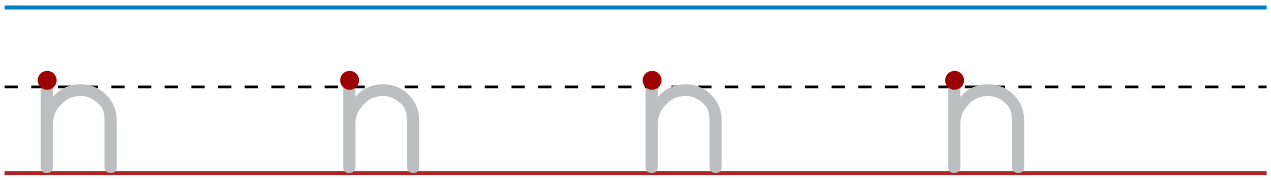

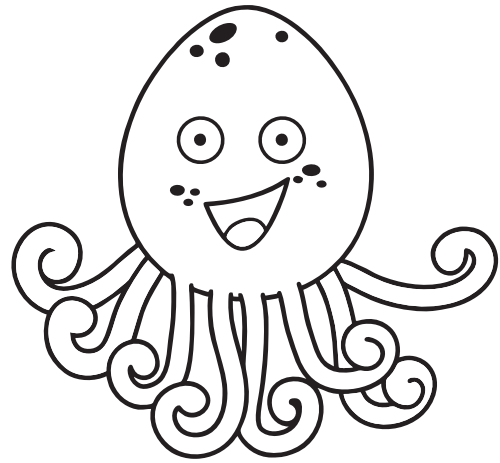
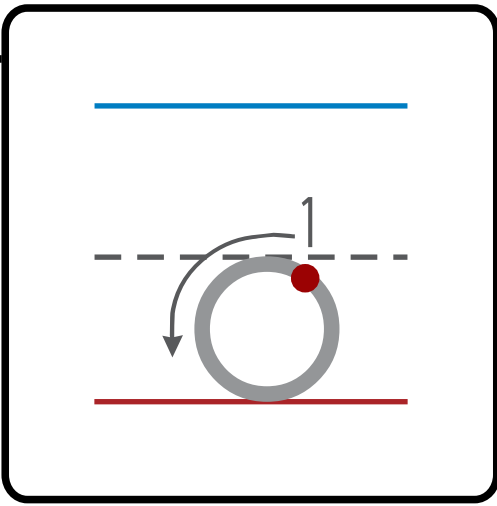

Name: _____

octopus

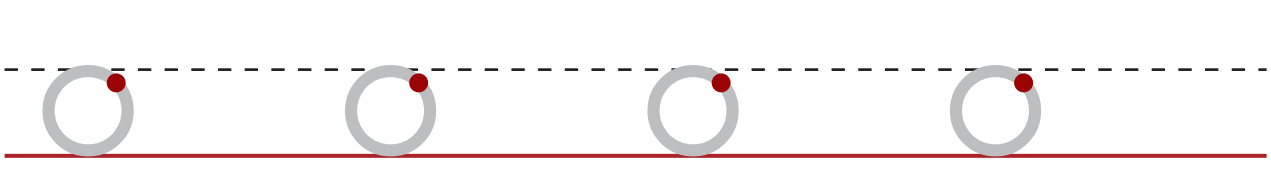
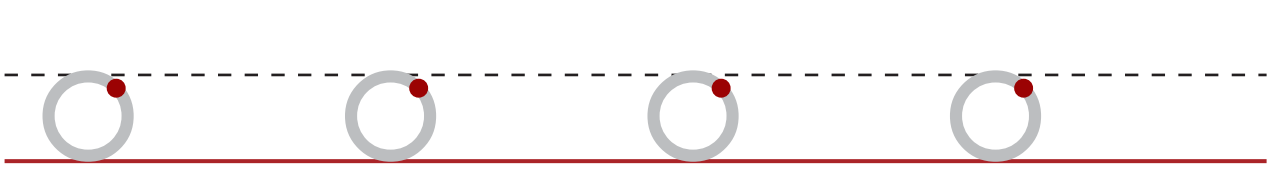
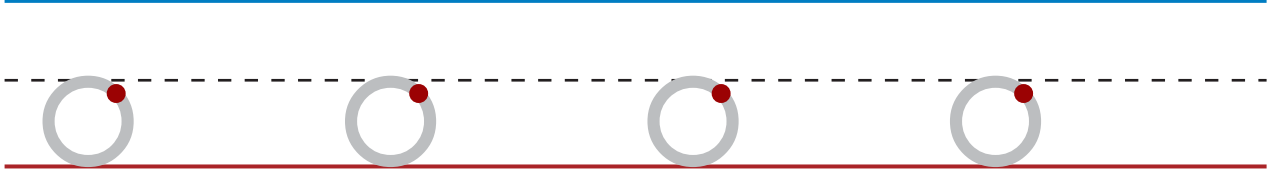
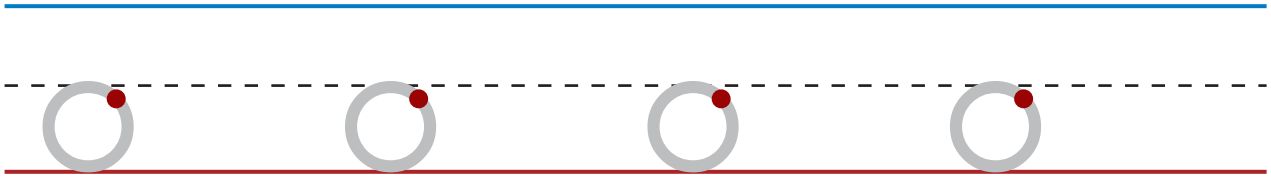
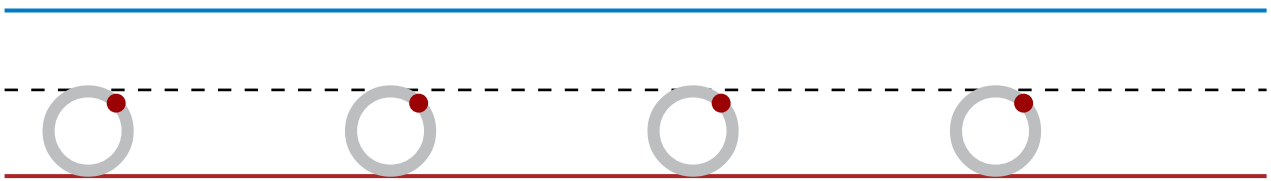

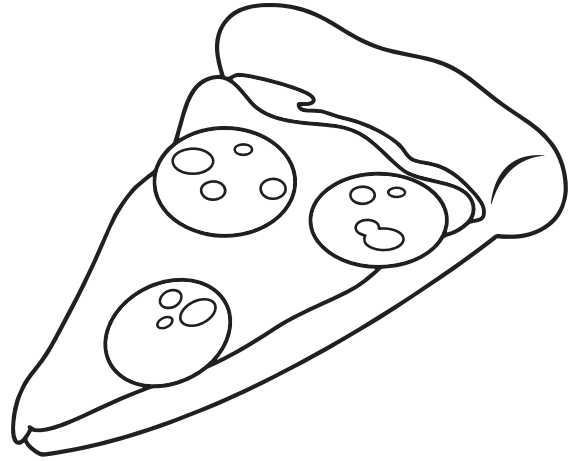
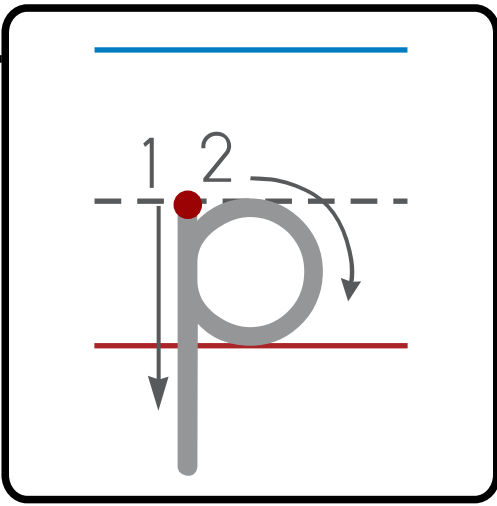

Name: _____

pizza

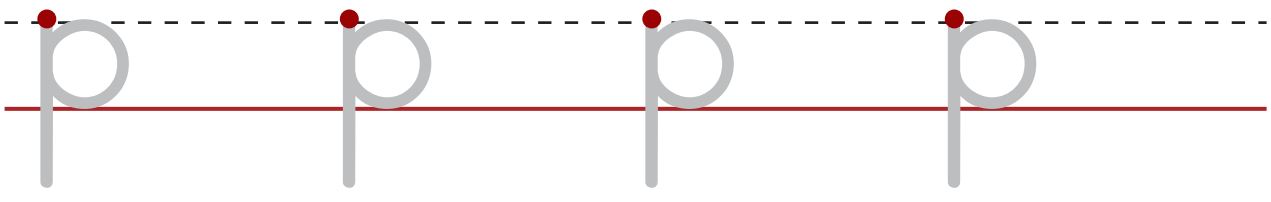
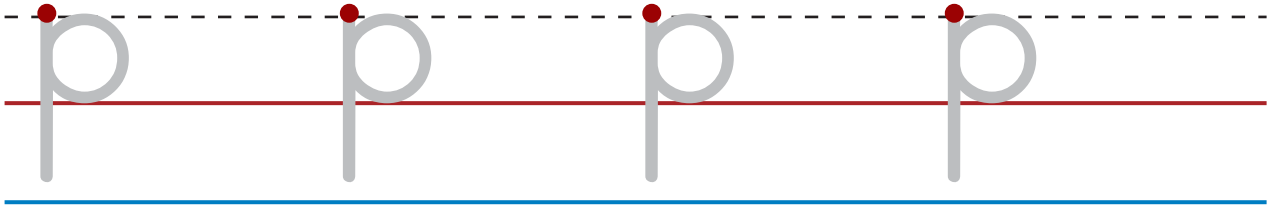
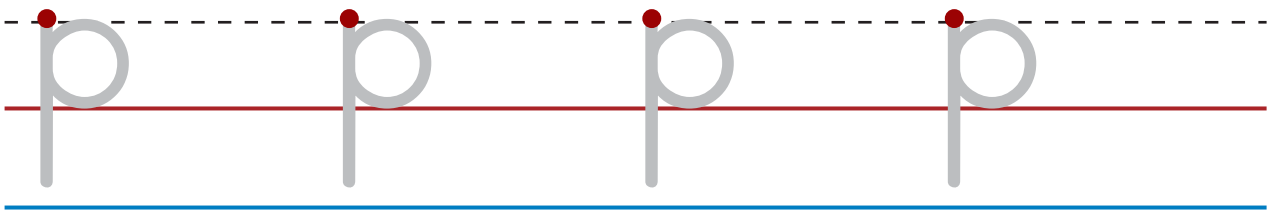
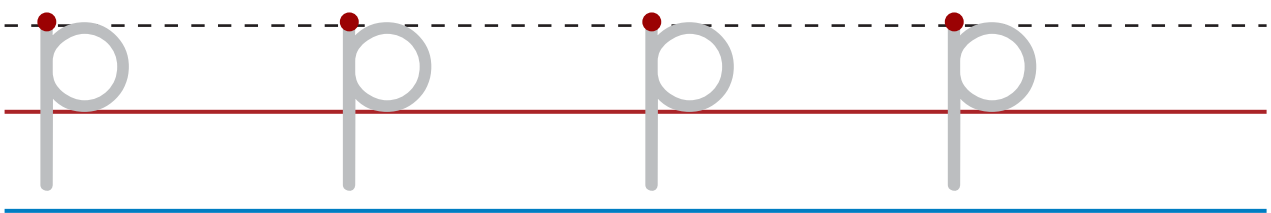
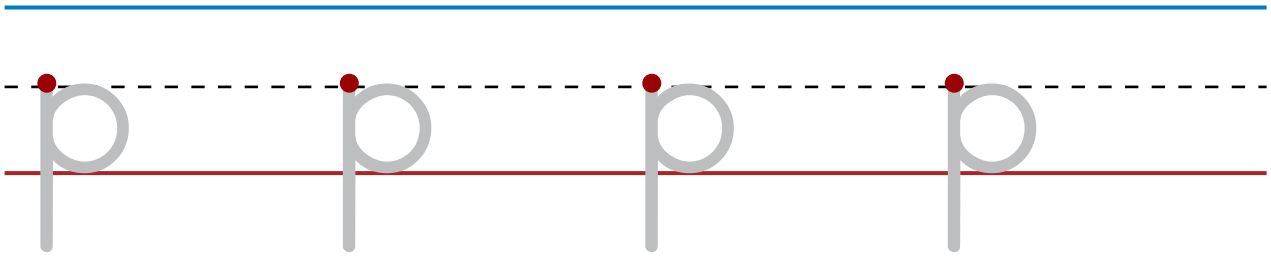

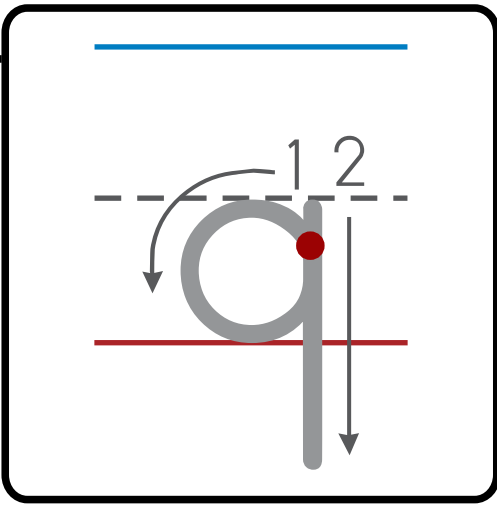

Name: _____

queen

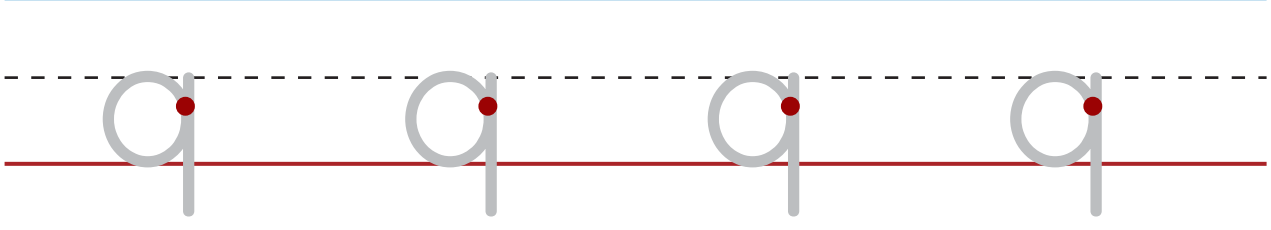
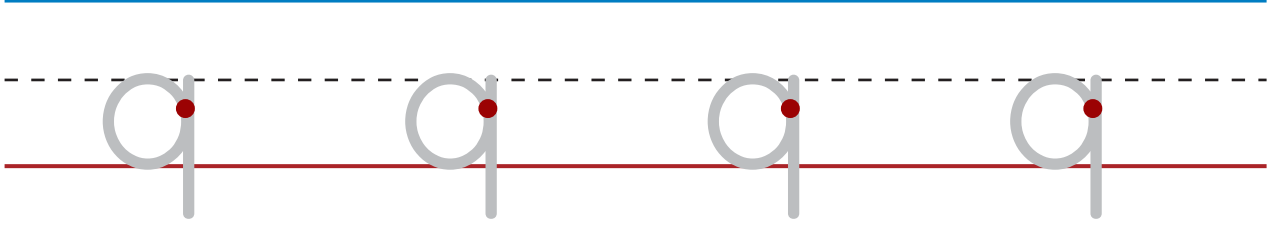
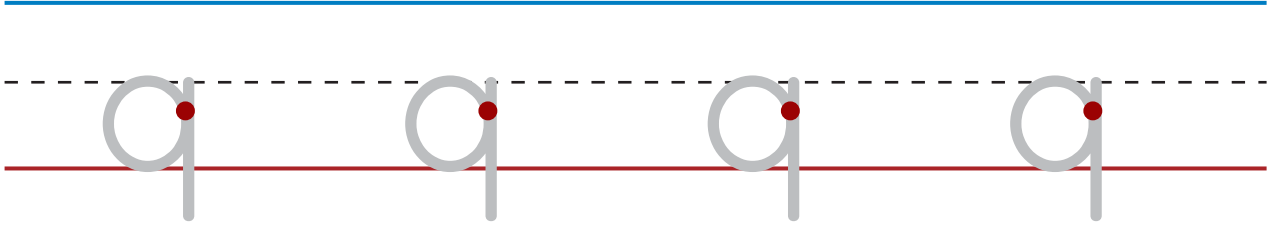
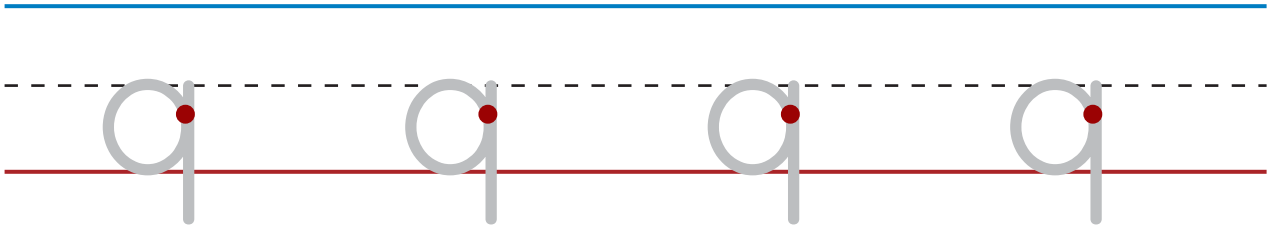
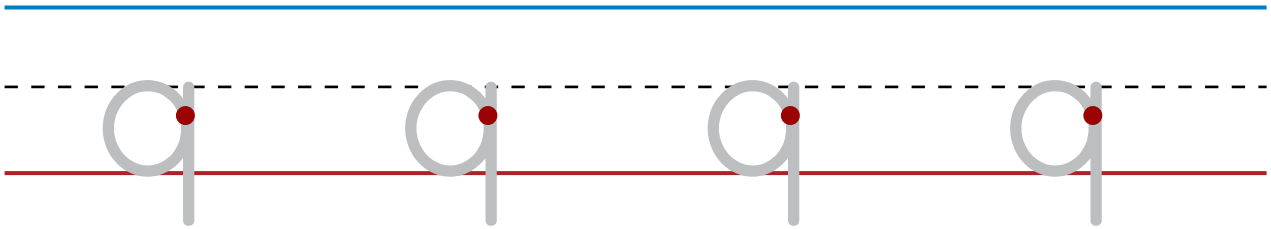

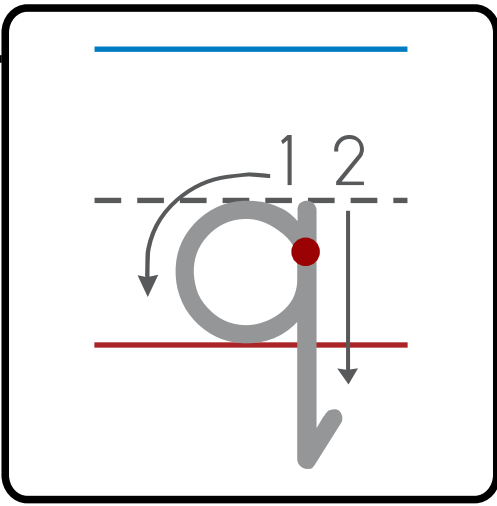

Name: _____

queen

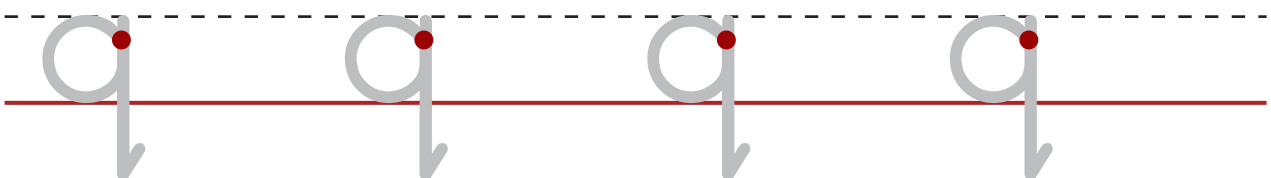
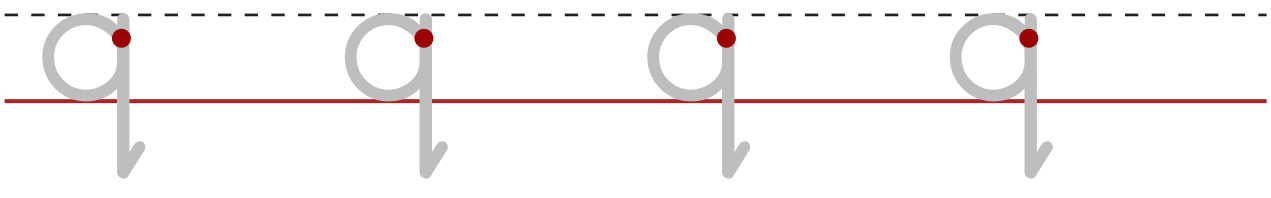
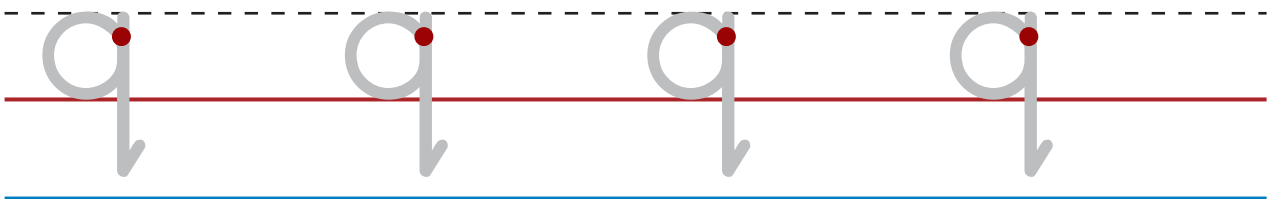
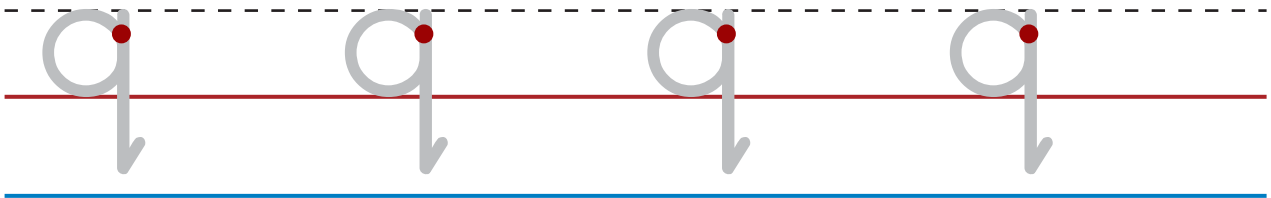
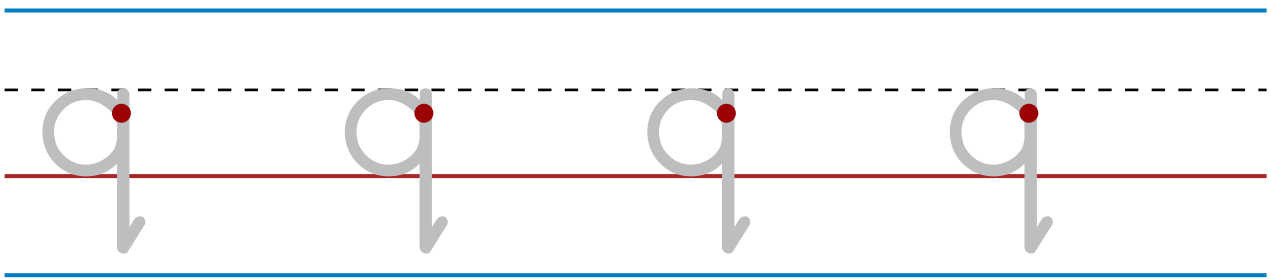

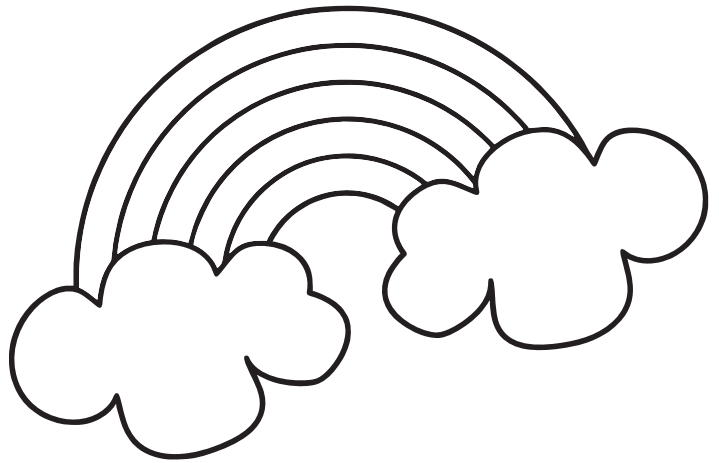
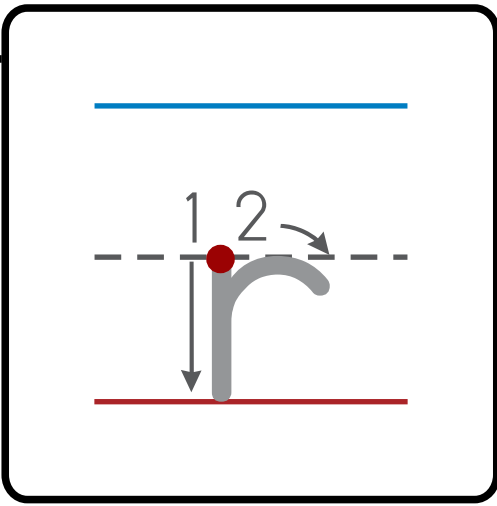

Name: _____

rainbow

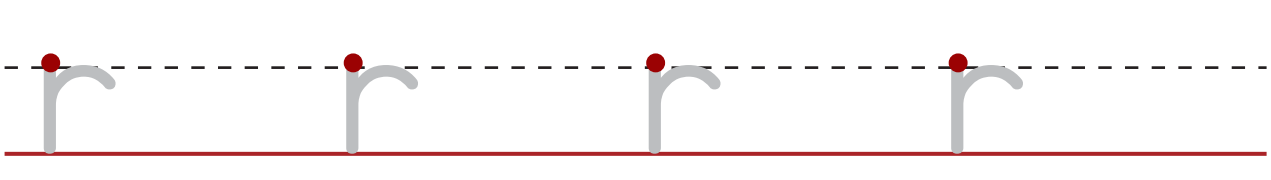
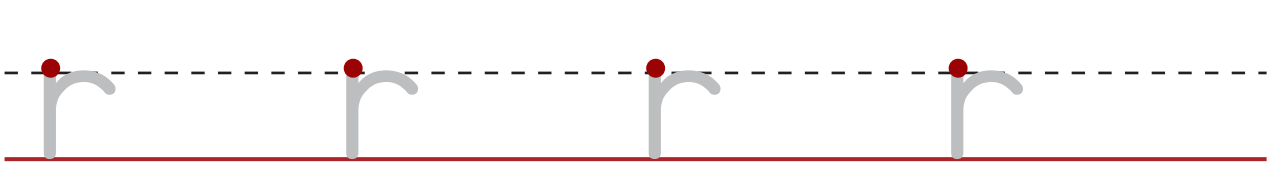
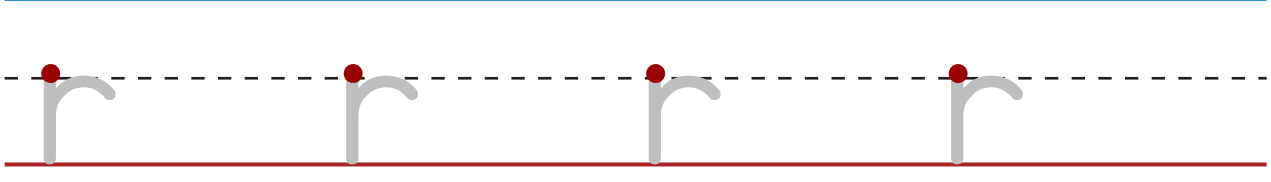
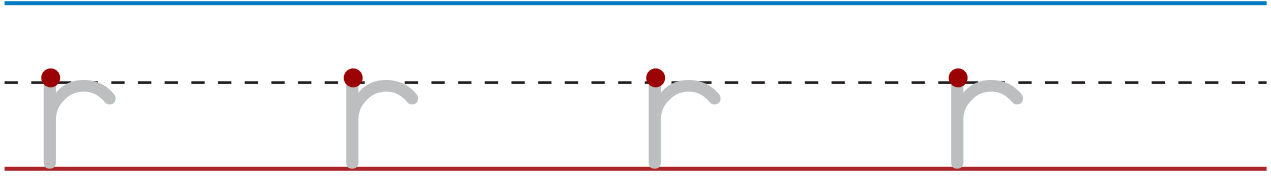
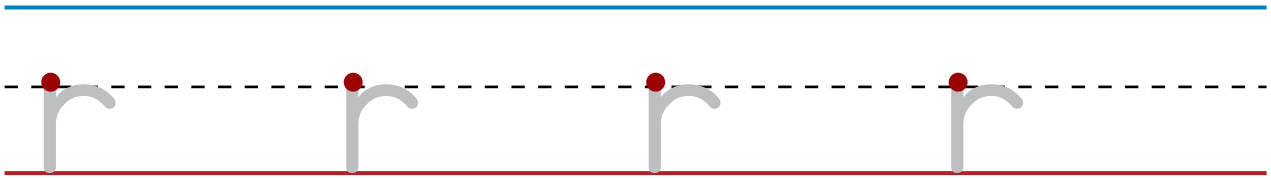

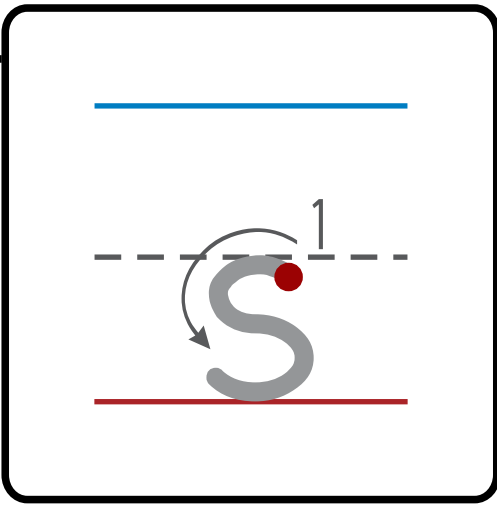

Name: _____

seahorse

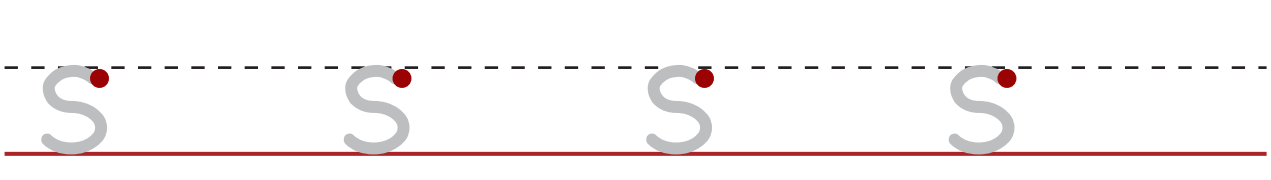
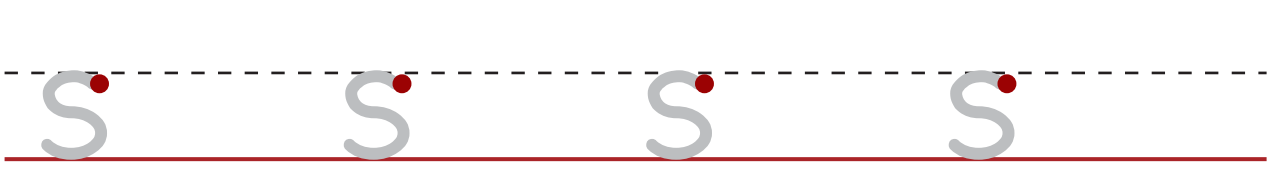
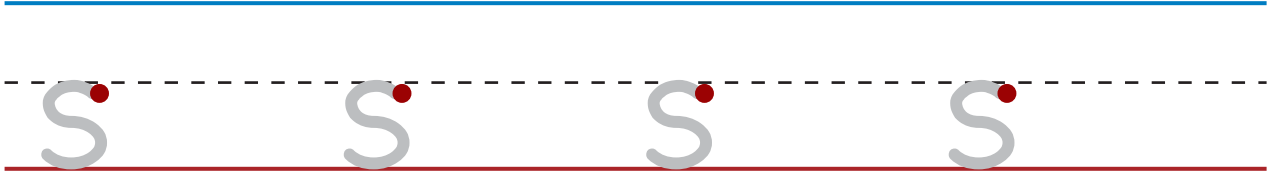
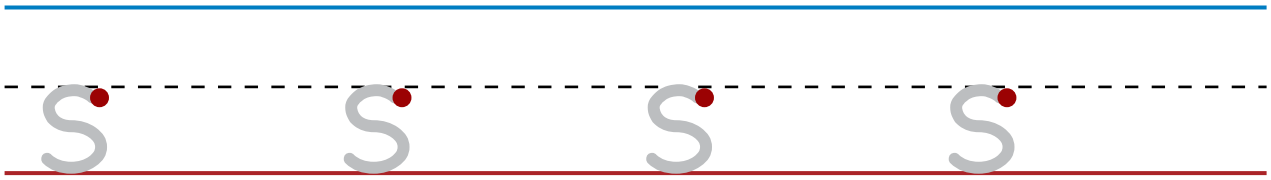

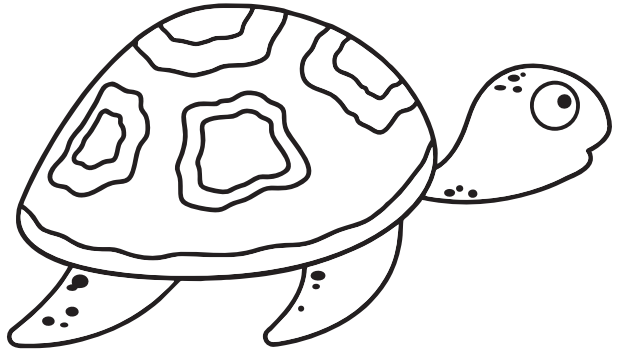
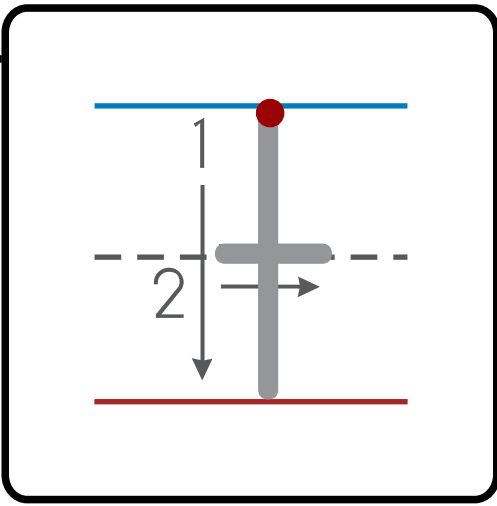

Name: _____

turtle

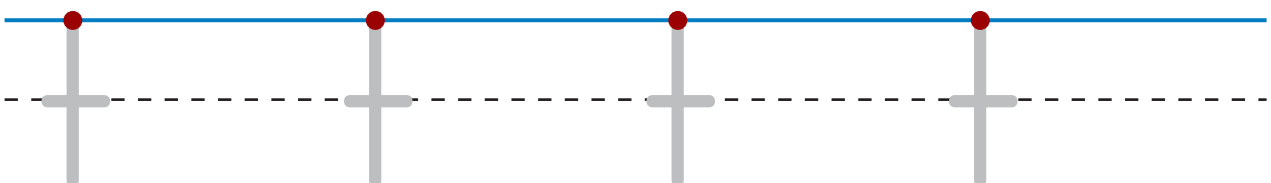
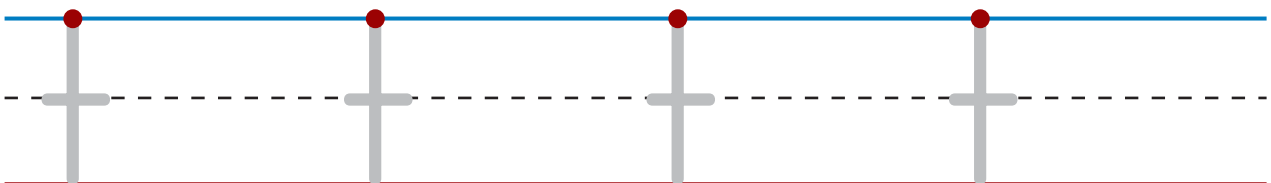
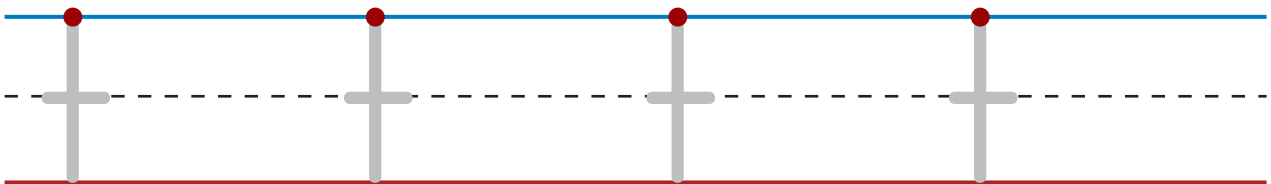
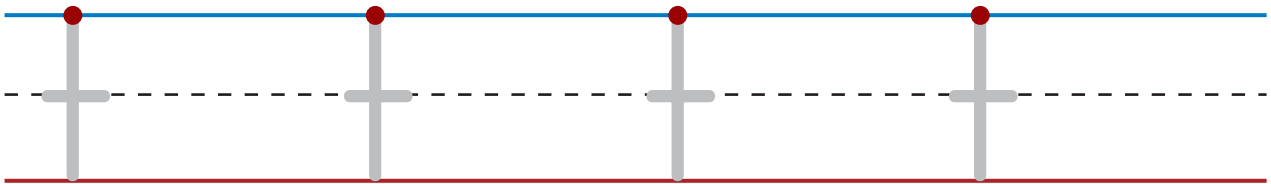
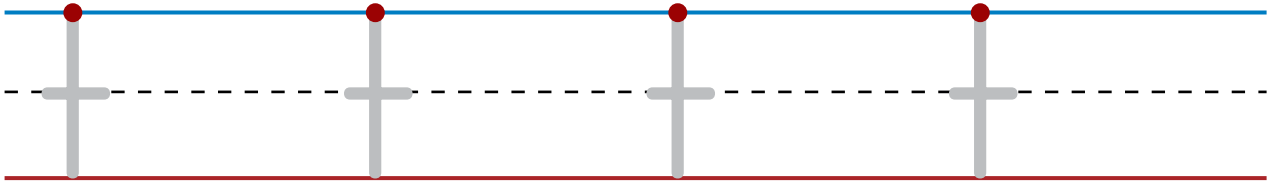

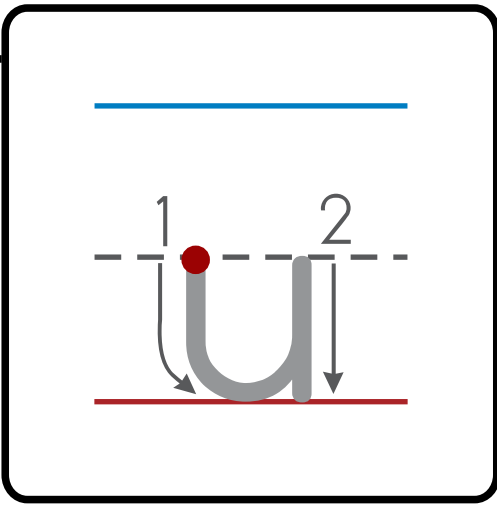

Name: _____

umbrella

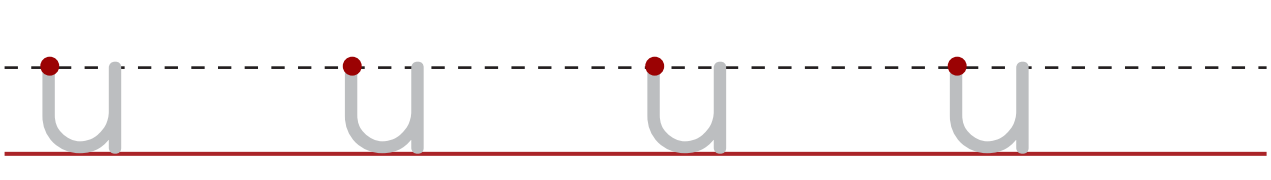
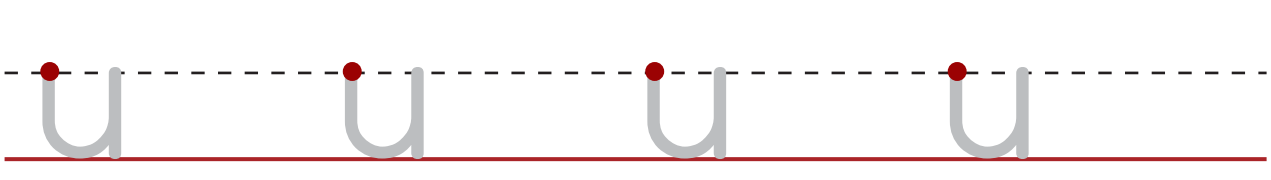
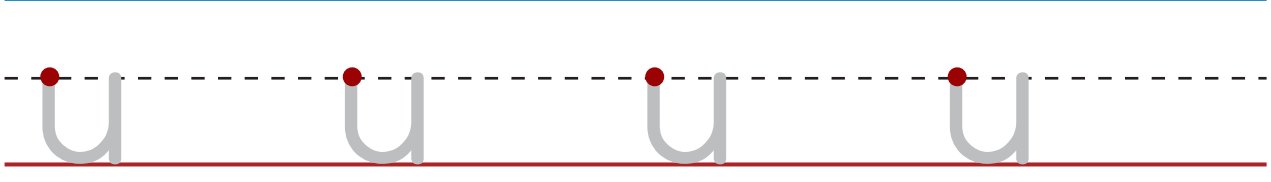
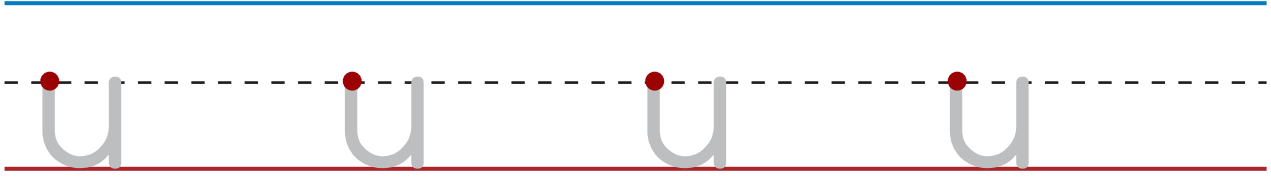
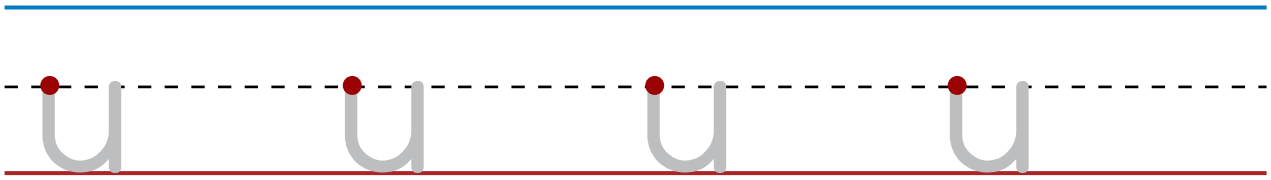

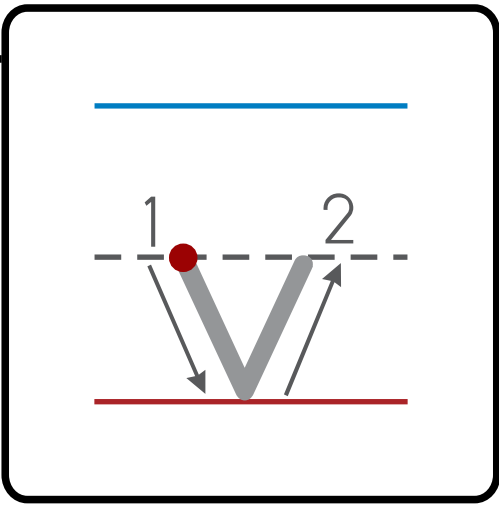

Name: _____

vase

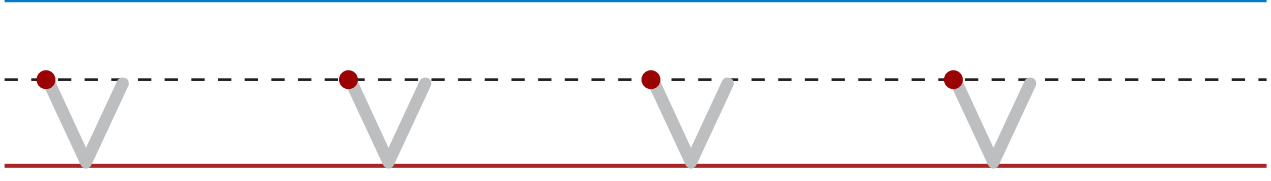
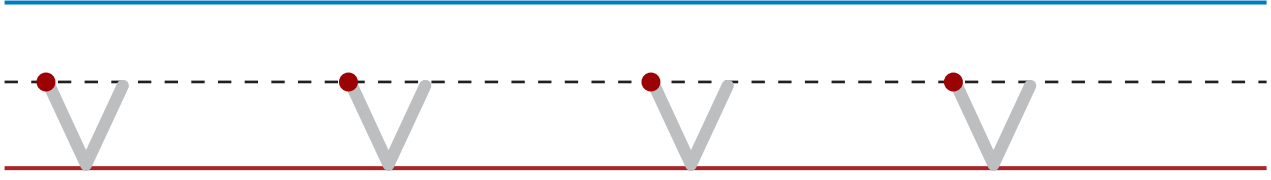
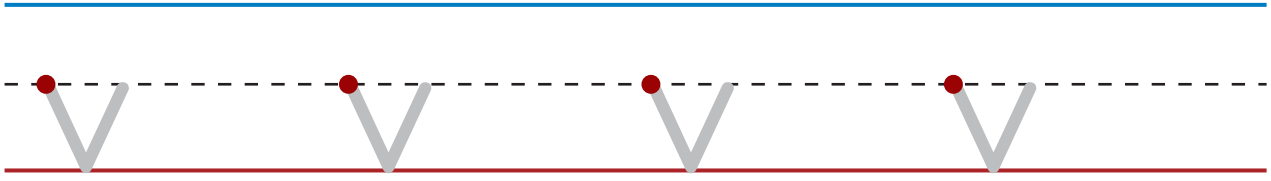
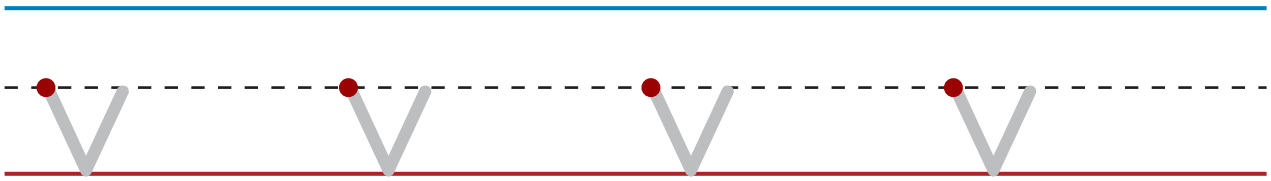
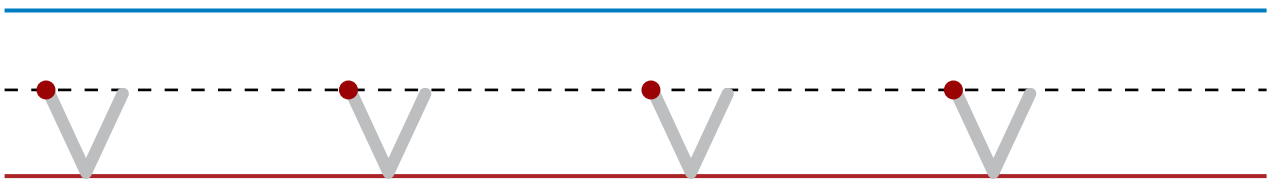

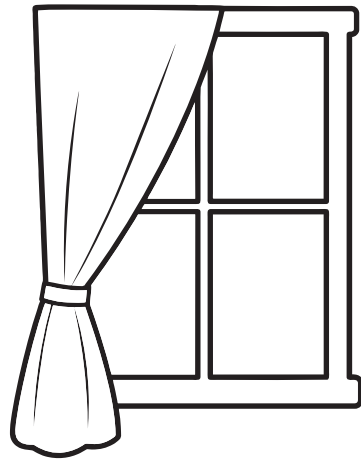
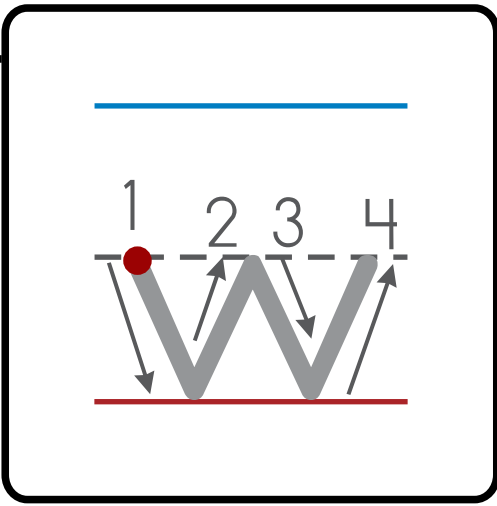

Name: _____

window

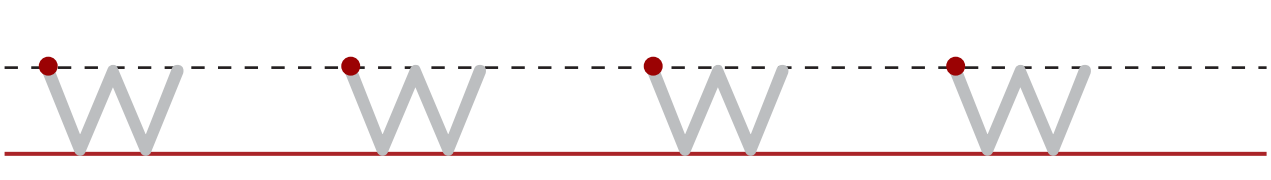
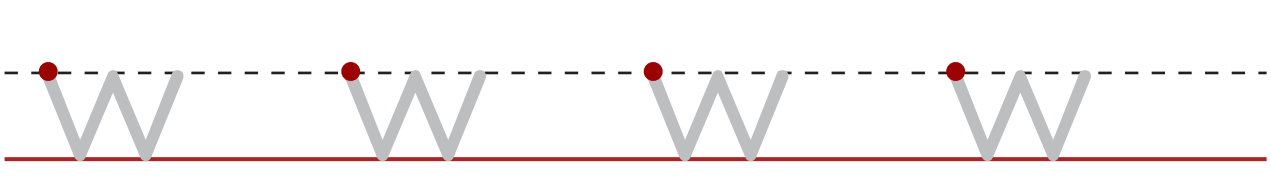
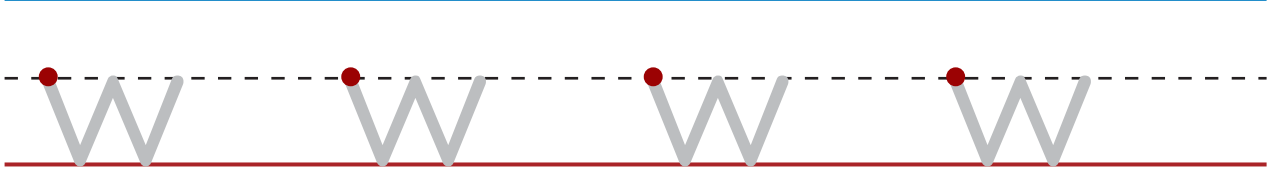
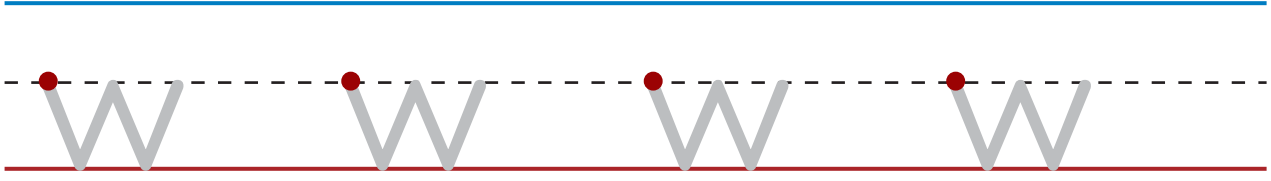
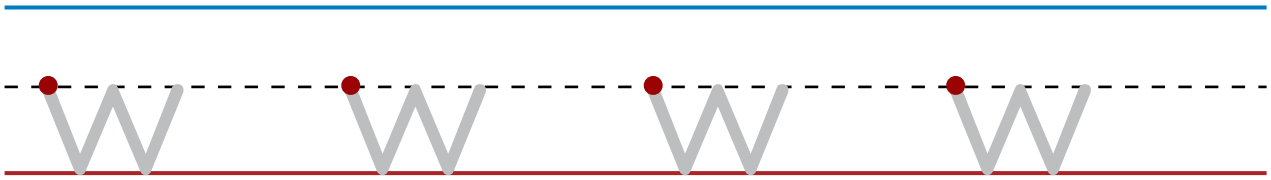

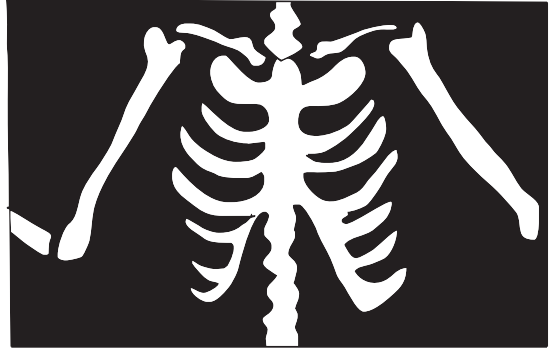
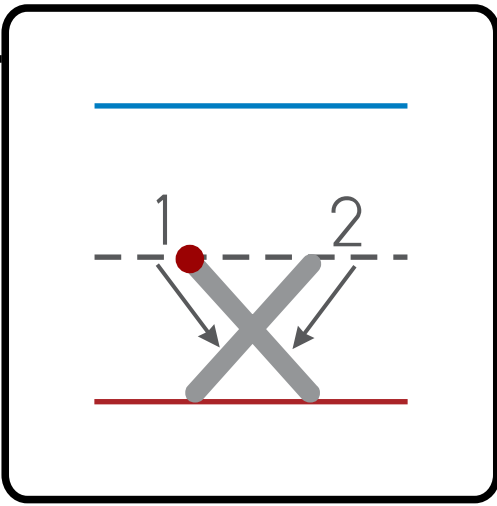

Name: _____

x-ray

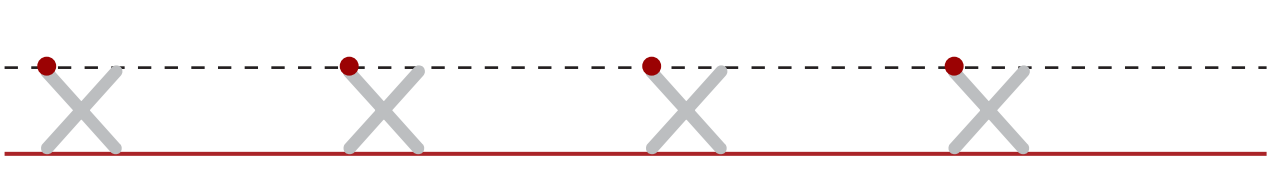
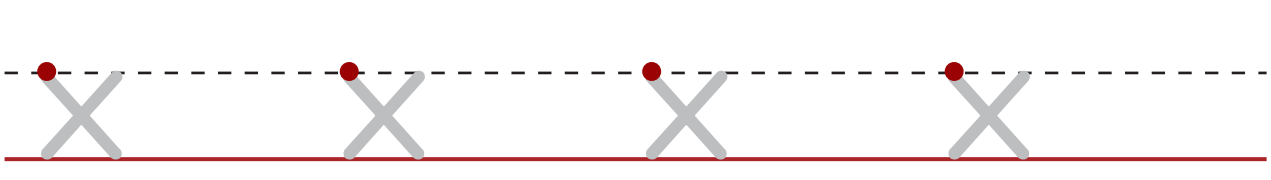
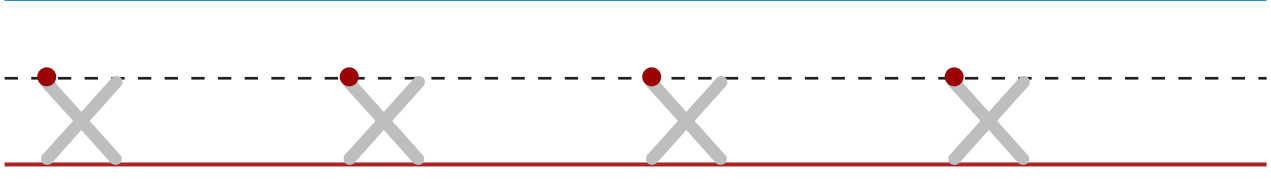
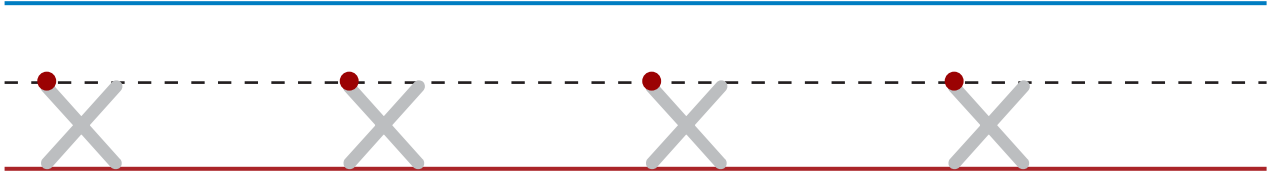
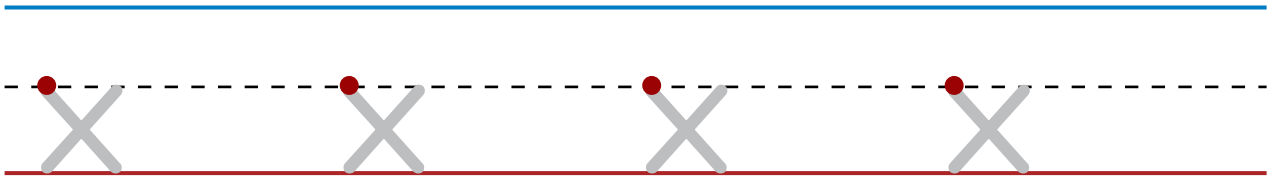

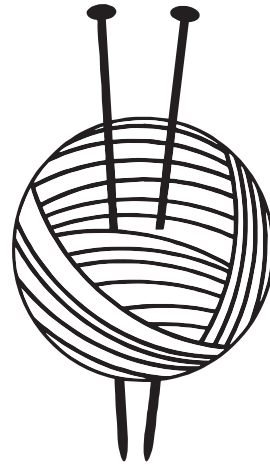
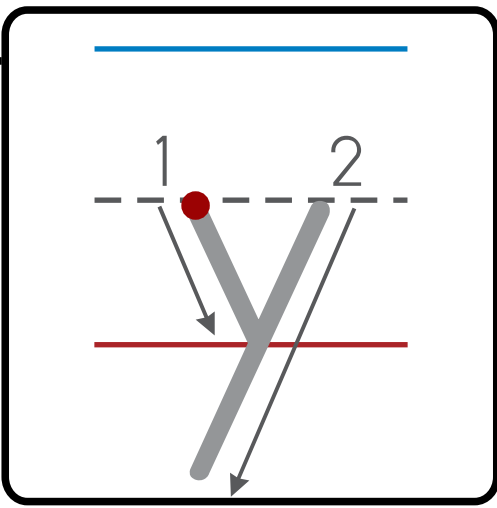

Name: _____

yarn

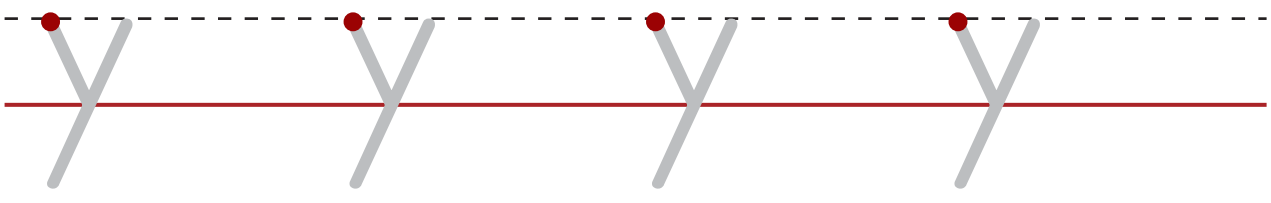
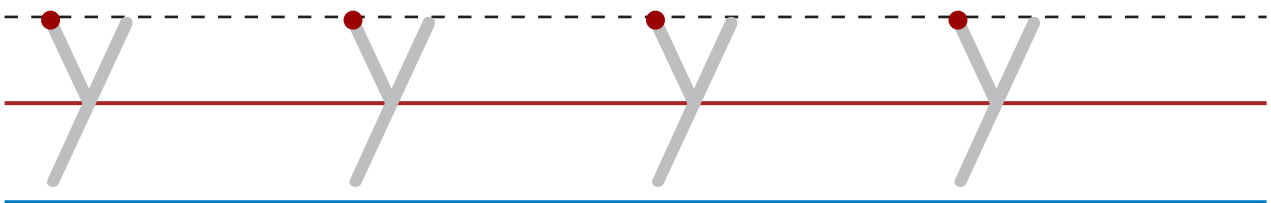
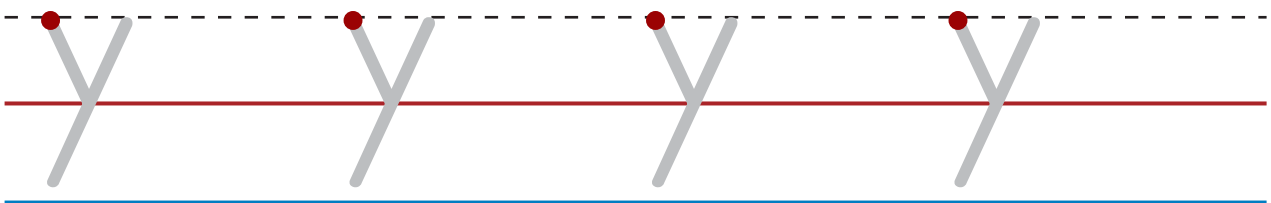
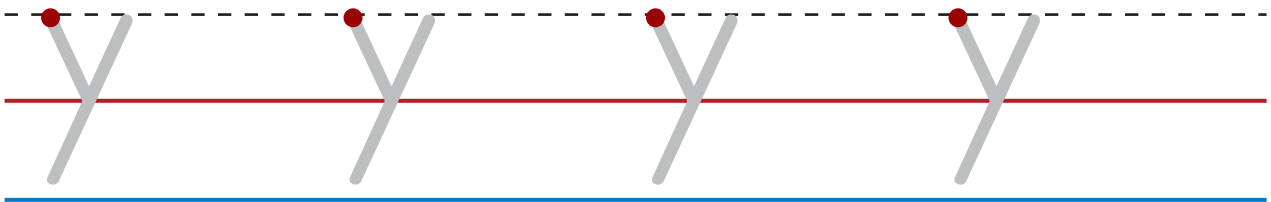
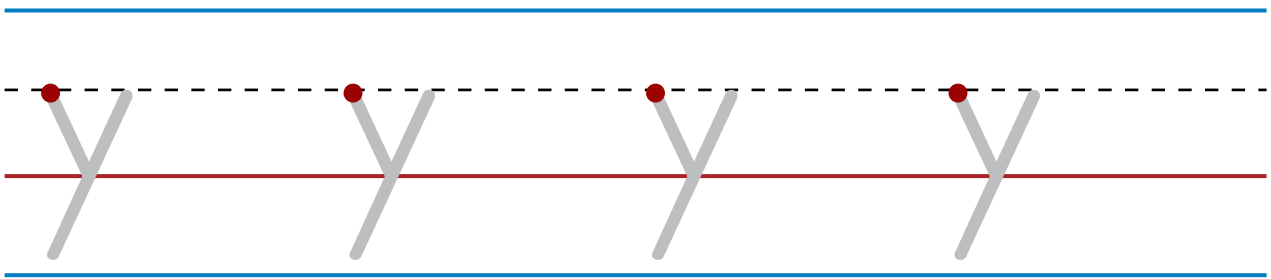

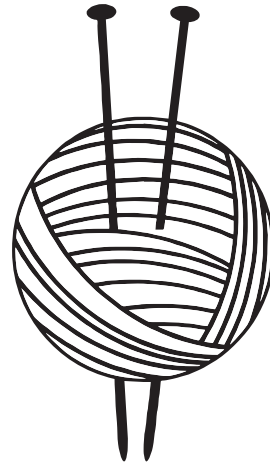
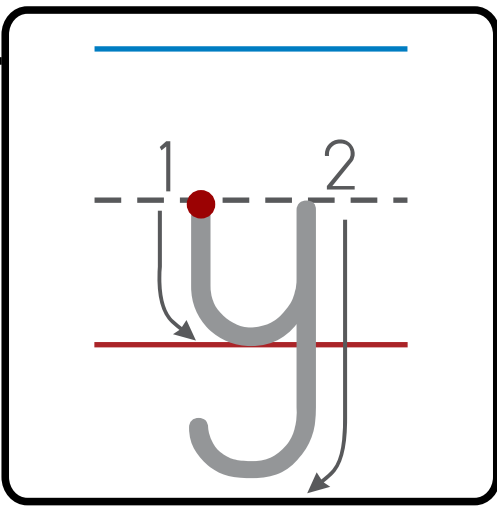

Name: _____

yarn

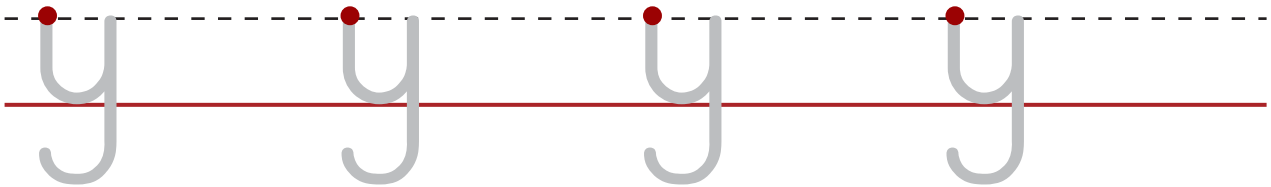
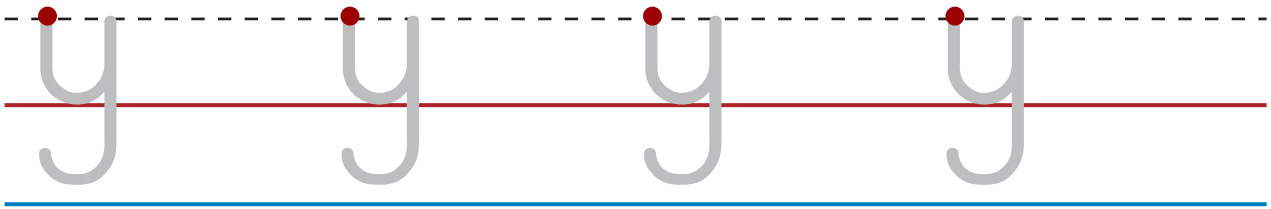
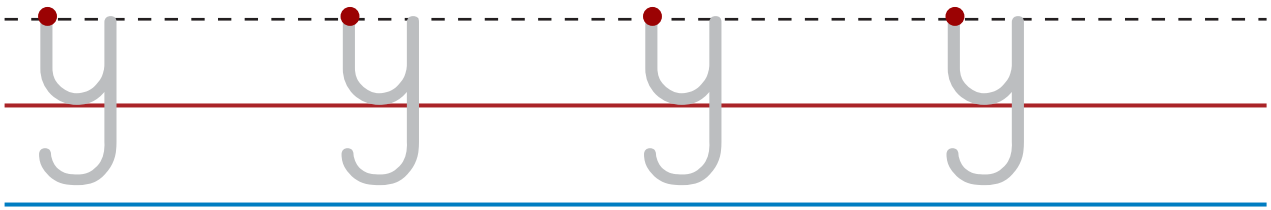
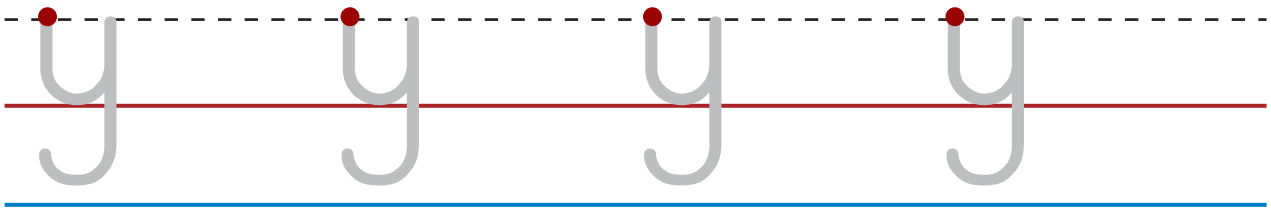
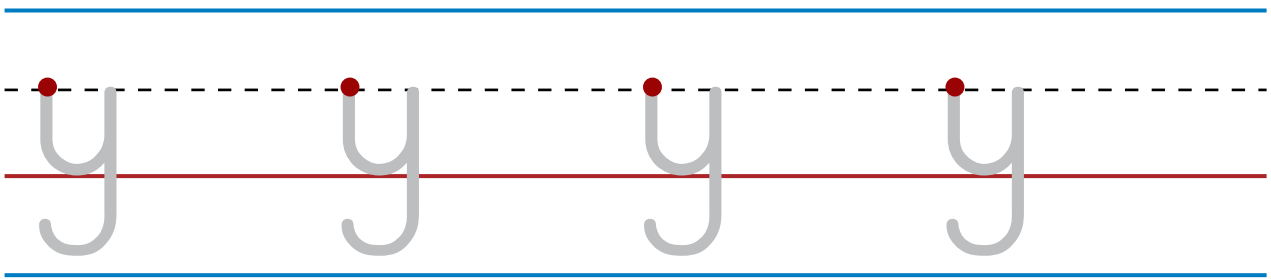

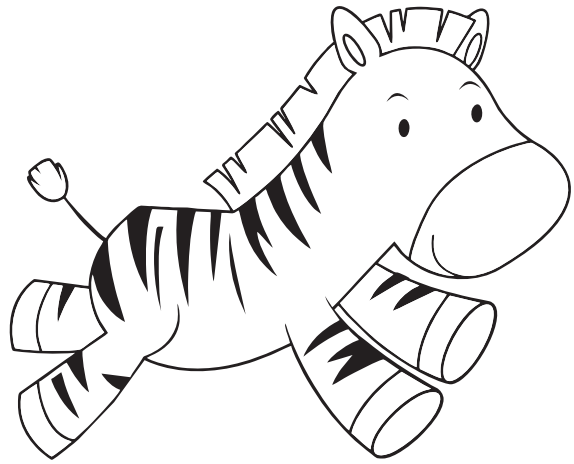
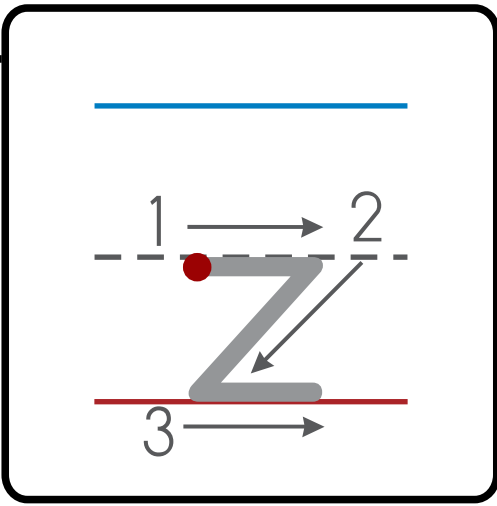

Name: _____

zebra

