

Twister Volume 50

THE GOLD
STANDARD

Field Kindley Memorial High School

1887 - 1987

CONTENTS

*Standard
of
Living*

Student Life-4

*Going
for the
Gold*

Sports-24

*Standard
Choice*

Organizations-16

*Raising
the
Standards*

Academics-60

*Standards
of
Excellence*

People-86

*Gold
Rush*

Community-140

Field Kindley High School in the year 1937. That year, 50 years ago, the very first Twister yearbook was published.

The Gold Standard

The Gold Standard. Standard Equipment. Standard Traditions. A Standard of Living. Each a tool for defining excellence. While the country relied on the gold standard as a guage of economics, Coffeyville had a different gold standard: FKHS. Knowing what they represented to a town rocked by falling oil prices, and declining industrial strength, the NADO worked to hold the spotlight. On the 100th year of Field Kindley High School, the students upheld the tradition of excellence. A standard year with only subtle changes, '86-'87 gave the NADO the GOLDEN opportunity to make the year the best Coffeyville and FKHS had ever had

No Competition Bryant Colbert goes for the gold and a touchdown in the 38 to 13 Homecoming win over Fort Scott. This was Colbert's second touchdown of the night.

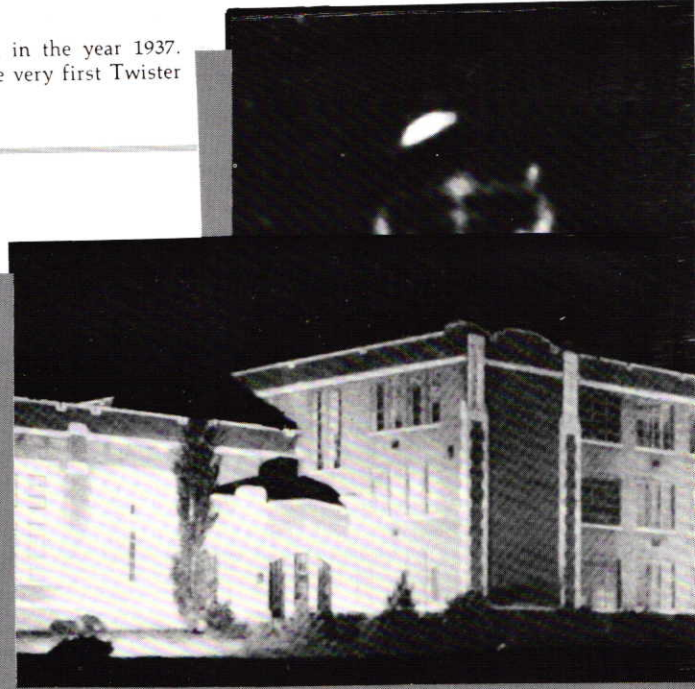





Standard of Living

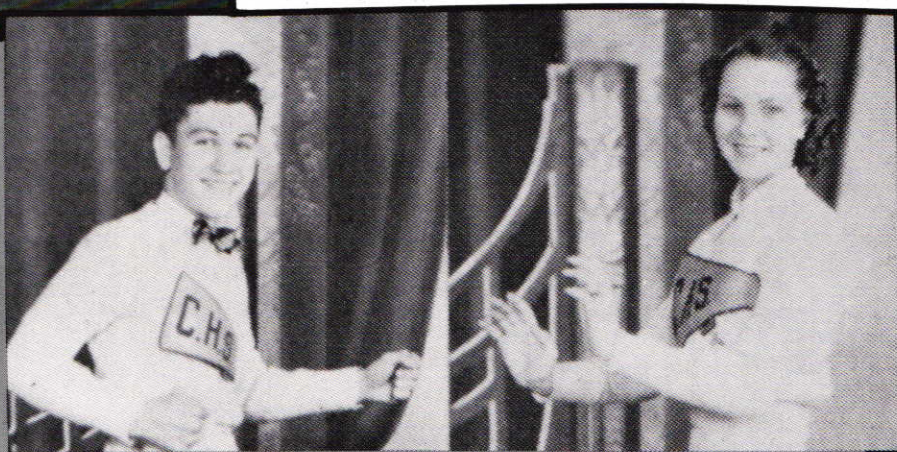

Cheer Coaxers- Leading Songs at the games is but one of the activities of Bill Bowser of the class of 1939 and Geraldine Smith of the class of 1938.

Surviving the flood of '86, crowning senior Keri Bowman as Fall Homecoming queen, adapting a hit Broadway musical, "A Chorus Line", to a high school play, "Places Please", to just spending time with our best friends, the 'Nado turned to their standards for living and made this year sparkle for all of us.

Keri Boman reigned over Fall Homecoming, October 10, 1986, as the Golden Tornado trounced Ft. Scott 38-13. Matt Locke crowned Keri at 6:30 p.m. pre-game coronation ceremonies.

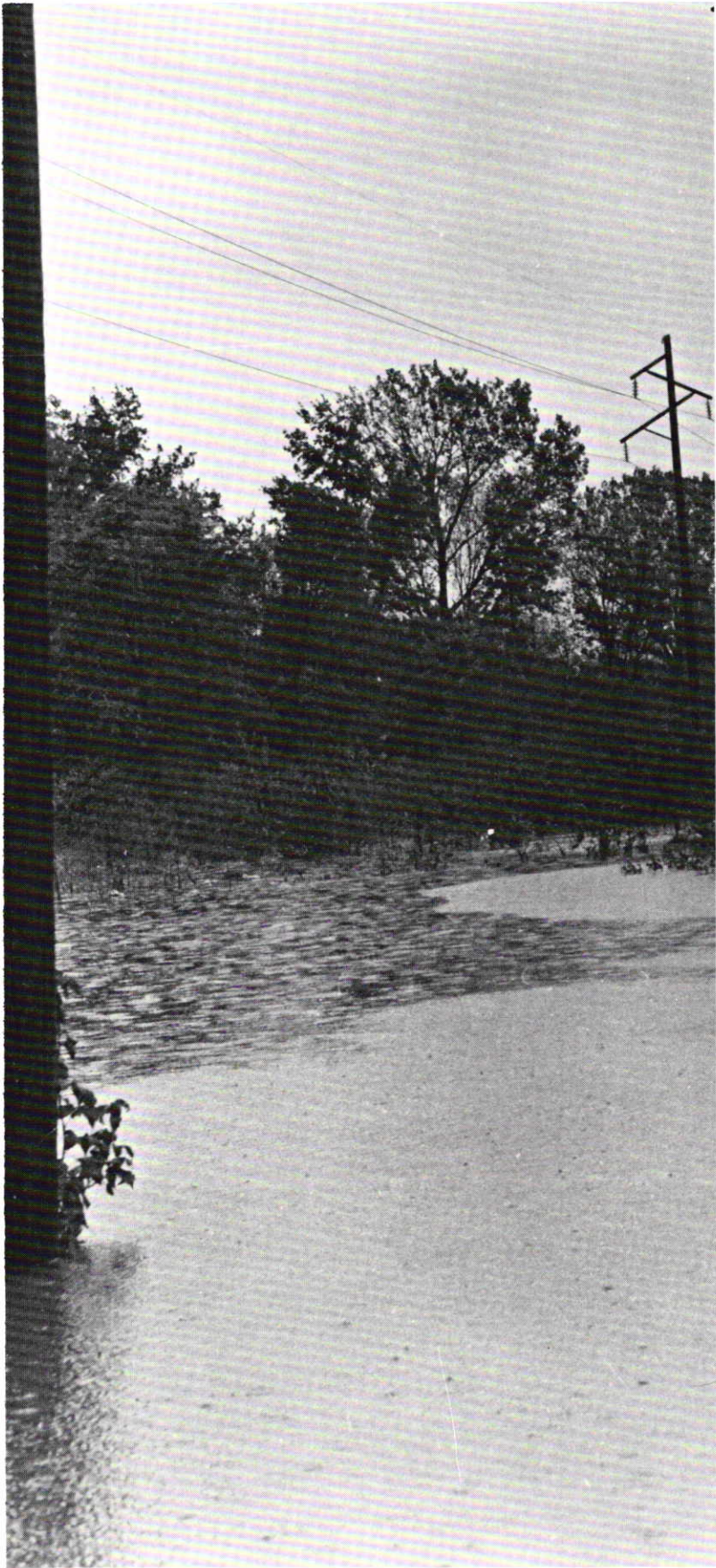

A New Lake? It used to be dry land, but when the Verdigris River overflowed in October it looked more like a lake.



Too Close These road signs surrounded by river water normally stand over seven feet from the ground.

The '86 Flood

Flooded streets. Closed bridges. Sandbagging. All a part of the reality that faced Coffeyville residents between September 26th and October 3rd, 1986. Sitting in class on September 26th at 10:30 a.m. students heard this announcement: Bus students should leave, the dam is being opened and excessive flooding expected.

Coffeyville received over 20 inches of rain in little over a week. The Verdigris River rose higher and then overflowed. There was more flooding the farther east one went in Coffeyville.

Another part of the flood was the way people worked together. Mrs. Bryant, one of Field Kindley's teachers, helped sandbag. "I heard on the radio that they needed help sandbagging," she said. "They wanted the women to hold bags, but I felt more involved shoveling sand. I worked six hours without a break. People who were there before me were still there when I left. I was really impressed by the Salvation Army. They had things set up right there with food and drinks."

That's what the flood was all about. People helping other people.

Road Closed! Just off of Highway 169, this dirt road leading east out of Coffeyville flooded when the Verdigris River overflowed.





Senior Favorites

BEST LOOKING—Neal Carpenter & Lisa Smith

BEST PERSONALITY—Tim Blevins & Tosha Hoy

FRIENDLIEST—Jr. Clairborne & Marlene Sanders

BEST BODY—Mark Pate & Lisa Smith

BEST HAIR—Ted Howerter & Gayla Malone

BEST EYES—David Bell & Angela Bullard

MOST ATHLETIC—Colin Colbert & Marlene Sanders

BEST SENSE OF HUMOR—Brian Smith & Liz Reed

MOST SARCASTIC—Neal Carpenter & Tara Walton

BEST LAUGH—Randy Reardon & Lori Burdick

MOST HYPERACTIVE—Randy Reardon & Liz Reed

MOST SPIRITED—Bruce Pierce & Brenda Corle

BEST COUPLE—Cindy Green & Paul Winston



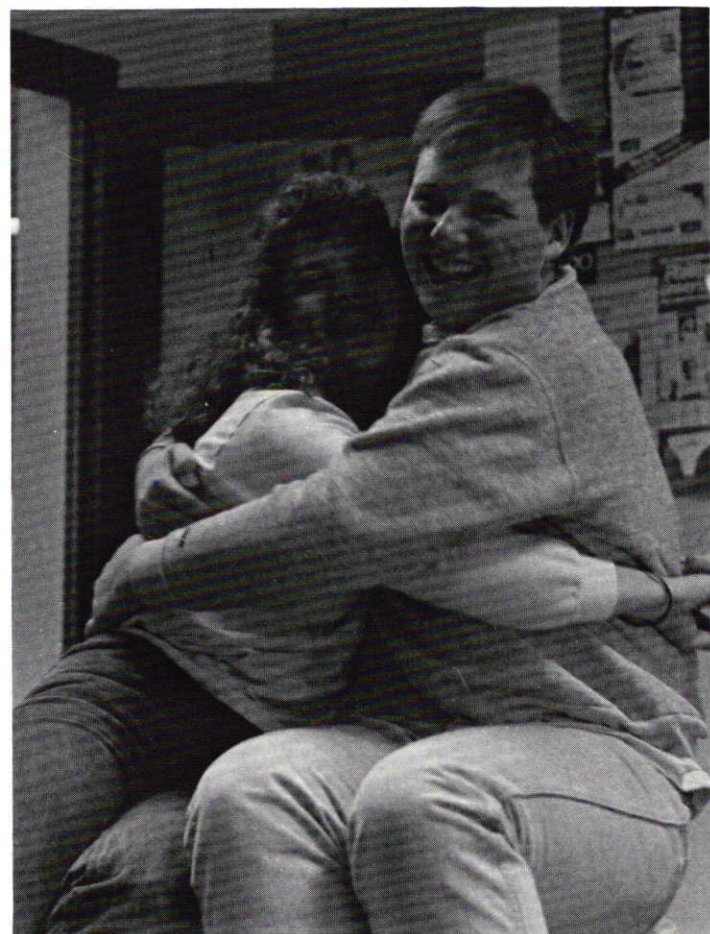
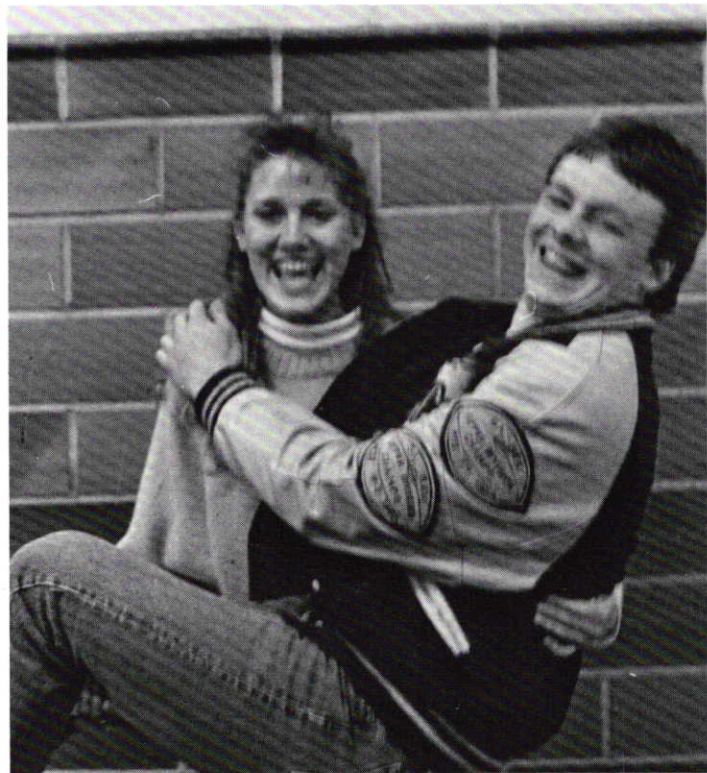

Coming Back Home

As the crowd waited for the Fall Sports Queen to be announced, the candidates lined up with the queens court awaiting the moment one of them would be named the 1986 Fall Sports Homecoming Queen.

The nominees and their escorts were Keri Bowman-Matt Locke, Tosha Hoy-Jason Harden, and Lisa Smith-Mark Hallum. The court consisted of Jr. Shelly Stewart-Jr. Mike Brown, Soph. Britney Ivey-Soph. Gib English.

"I was really happy to be chosen as a finalist, but I had no idea I would be chosen as Queen. It was a special feeling I will never forget," said Keri Bowman. "It was a great feeling. I always remember watching homecoming when I was younger, then all the sudden I was there. The game also ended on a good note. It was a storybook night," said Matt Locke. Lisa and Tosha both agreed that they felt honored and were very happy for Keri.

The night ended well for Nado when they pulled off a big win over Fort Scott 38-13.

All Smiles Queen Keri Bowman, Tosha Hoy, and Shelly Stewart pose for one last picture before the kickoff.





They're All Here While the spirit squad forms the Royal line, the Fall Homecoming candidates wait patiently with their escorts to find out who will be named Queen.



Happy To Be Queen The 1986 Homecoming Queen, Keri Bowman, expresses her happiness with a smile, while being escorted off the field by Matt Locke after the coronation.

It's Looking A Lot Like Christmas! Sophomore Julie Wood parties in a tree, at Candy Cane Lane, during the Christmas season.



Love You Down, was one of the few slow songs played at the Fall Homecoming dance on Oct. 11th. Junior Lance Lee and Sophomore Angela Wishall enjoy each others company as many couples did.





Getting A Little Closer Junior Mike Brown and Senior Jennifer Groh enjoy the party while enjoying each others company.

Who's Under There? Senior Shon Ransom and Junior David White get a big hug from Senior Liz Reed at a party.



Let's Party

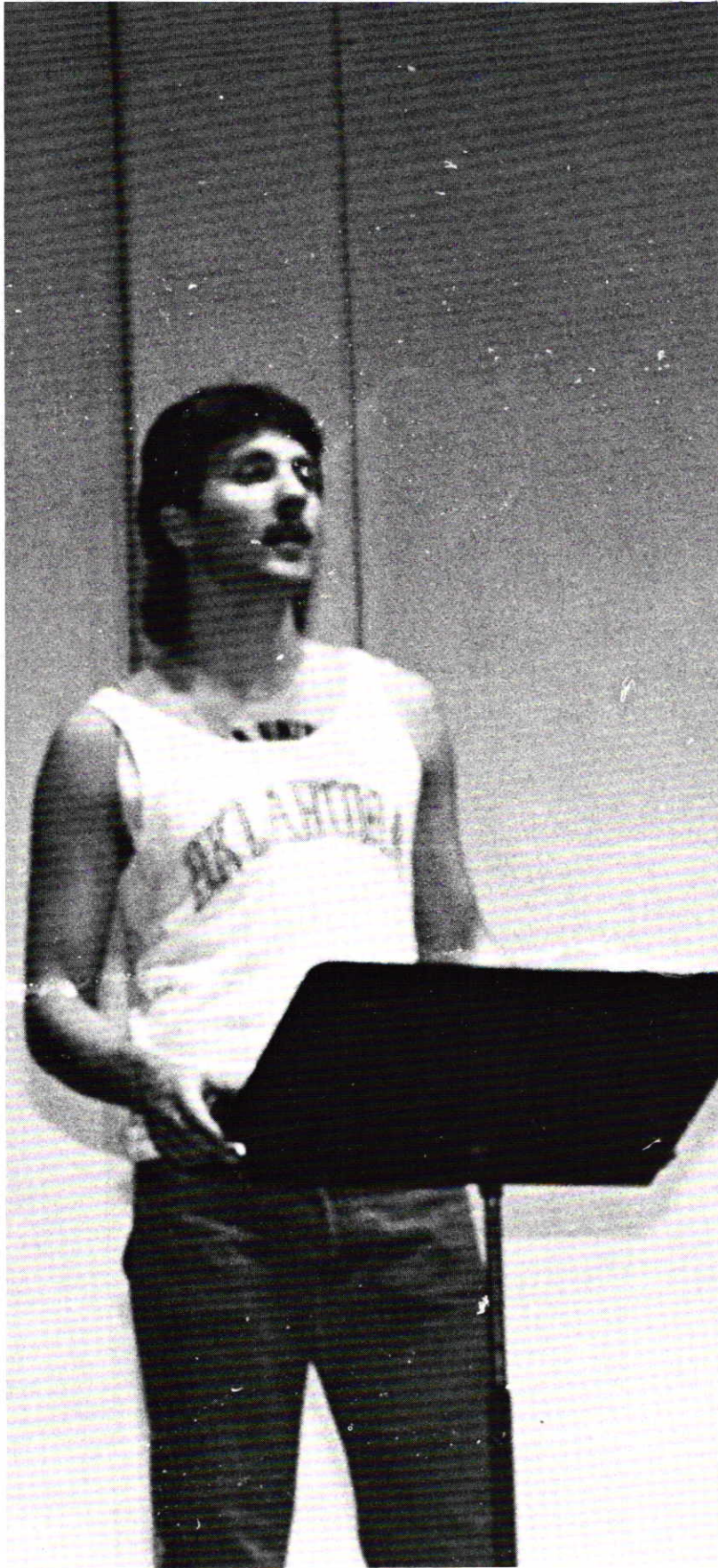

School jock and actor Neal Carpenter had one of the leading roles in the November musical production of "Places Please".

Stars Of The Spotlight

"Take your places, places please. We're about to go on with the show," sang the members of the FKHS Fall Play adaption of "A Chorus Line". The play, titled "Places Please", won raves from the audience and was also blessed with good attendance on both nights it was performed. It was not a play to miss.

The plot centers around a young playwright named Colin (Andy Wilson) and his attempts to cast his play with the "right people" and acted out in front of the school. Even with the help of two understanding teachers (Holly Mitchell and Mike Breen), casting the play quickly becomes easier said than done. Between having the school jock quit and having to coax the rich girl to another job, Colin has more than his share of worries. Sweethearts Adam (Darren Buckner) and Sara (Paulette Watson) win out the lead roles and, at the same time, win over each other's hearts.

Part of the appeal of the show was the headaches and humor that Colin and his teachers had to overcome while casting. But they did cast a winner in the end.

Tryouts are grueling, even when you are an impatient girl with tons of money. Snotty girl Tara Walton tries to win over the casting teachers played by Debbie Benning, Holly Mitchell, and Mike Breen.

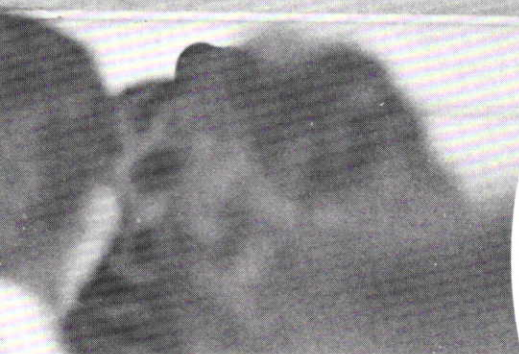
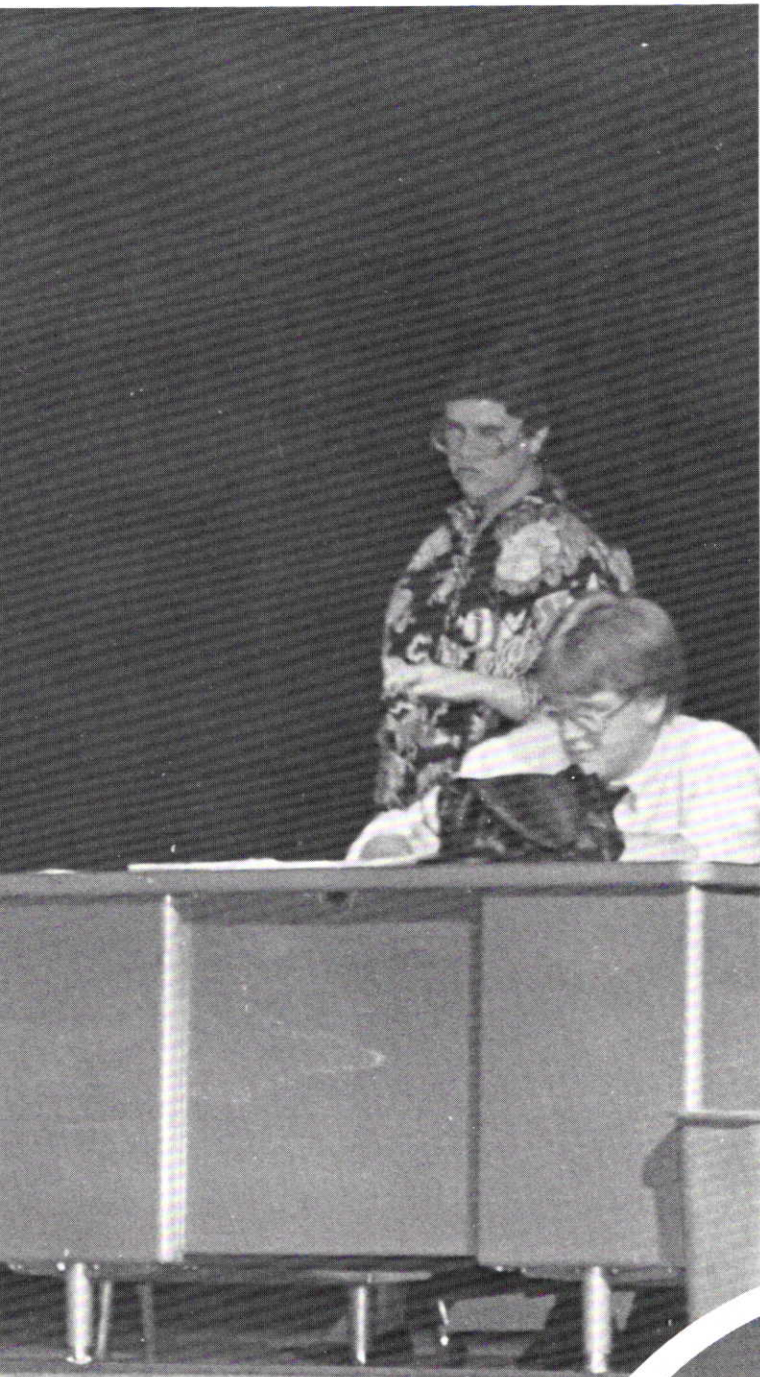

Singing is an important part of any musical production. Sophomore Stephanie Nadolny worked toward perfection during rehearsal.



Records were a big hit in '86 as many new artists topped the charts. Senior Rene McKellips looks for the right sound at Gibson's for Christmas.

At exactly 3:00 December 23, 1986, the bell rang for the last time in '86 at Field Kindley, signifying the beginning of Christmas Break. Break also reminded students that there were only 2 shopping days left before Christmas.

Picking out the forgotten gifts, waiting in busy lines, and making sure your best friend gets what she asked for added to the holiday magic. Students shopped the downtown plaza, Westside Shopping Center, Wal-Mart, and Gibson's to find the perfect gift for that "perfect" person. Some students, however, couldn't find what they needed and travelled to Bartlesville or Tulsa to the malls.

"I went to Bartlesville because there is a variety of stores to choose from", said senior Tabitha Malotte.

"I stayed in Coffeyville because I got around late and time ran out." commented senior Rhonda Burghart.

Whether shopping in Coffeyville, Bartlesville, or Tulsa, the Christmas magic was still there, which added to the fun of Christmas Break.

Christmas Shopping



Decisions. Decisions. Picking out the right gift is a trial and error process as sophomore LaDonna Vaughn found out while shopping for purses at Wal-Mart.



Last minute shopping meant sales, sales, and *more sales*. Senior Michelle Merriman looks over the stockings, while finding a few things along the way during a sale at TG&Y.



Some Kind Of Winter Fantasy

The announcement came at 11:50 a.m. on the third of February. "Winter Homecoming will be on February 13th." A brief pause and then the message was continued. "From the sophomore class, Cindy Wright will be the representative in the Queen's court. Junior representative will be Chris Norfleet and the three Queen candidates remaining will be Tosha Hoy, Marlene Sanders, and Lisa Smith. Come watch the festivities and the game afterwards. Thank you." Little did many know how that announcement would be the beginning of some kind of fantasy.

Eventually the thirteenth rolled around and so did the anticipation of Winter Homecoming. Many people came to see the basketball game against Parsons but the crowning was the main highlight. Candidate Tosha Hoy looked nervous as she stood on the sidelines with escort, senior Darren Buckner as Lisa Smith talked to her long-time boyfriend and escort Mark Hallum. Marlene Sanders, still on crutches from an injury, needed the help of escort Bryant Colbert to walk around. The moment came and the three candidates glided to center stage. "And the 1986-87 Field Kindley Winter Sports Queen is . . . Marlene Sanders!!"

An extra spirit week was added before this year's Winter Homecoming. Seniors Tom Robertson, Jim Ulibarri, and Brian Smith got into the act when they participated in Dress-Up Day.





and I now give you this crown ..." Senior Marlene Sanders was crowned by her escort Bryant Colbert, as sophomore Chris Norfleet and escort Steve Berkstresser looks on.

Homecoming candidate Tosha Hoy looked like a queen as she and escort Darren Buckner made their entrance (above), while other queen candidate Lisa Smith glowed after the ceremonies.

Dressed from head to toe in solid, striped, and paisley suspenders, Seniors T.C. Carter, Chad McMurray, and Boyd Hamlin look at the latest in sports.

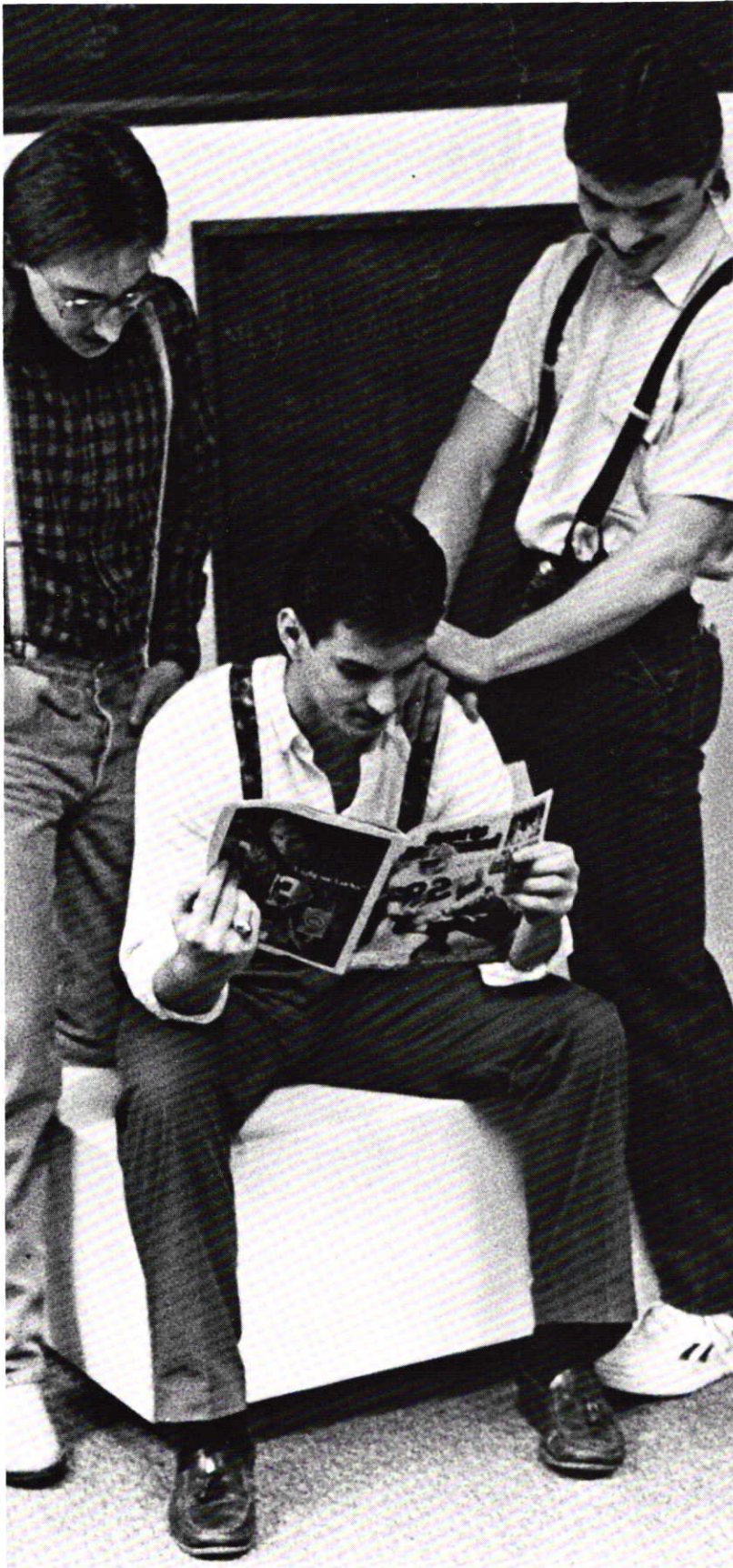

Just monkeying around at a game of tug-a-war, Seniors Darren Buckner, Janie Hartwig are dressed in the latest denim fashions of overalls and jean jackets.





Taking a break Senior Tara Walton stops for a moment to freshen up, fix her pin, and rearrange her over sized sweater before going to class.

Is it really worth \$40? For some, the price was too high, but others willingly paid. A day at the mall meant splurging, fun times, and sometimes disappointment.

Over the fall and into the spring, the following are some of the fashions that might be seen in the halls of FKHS: overalls, suspenders, over-sized and crew neck sweaters, 10 button shirts, trench coats and flat tops.

What's Hot

cowboy boots
beaded shirts
anything in silver
501's
lace collars
Mickey Mouse
colored knee-hi's
jean jackets

What's Not

suede boots
ruffles
neon colors
tight jeans
dumbo collars
Gumby
leg warmers
wind breakers

While some students chose to save their \$40 and wear hand-me-downs, for others it was well worth the price.

Well Worth The Price



Quarterback Colin Colbert receives a license plate and an congratulatory hand shake from the Shriners.

Juniors Sarah Diel and Erin Akard were the only two girls who made it to the State Tennis Championship this year.



The state champion debate team leads the list of 1986-1987 outstanding achievements. The Field Kindley squad placed first with a 10-4 record on January 23-24 in the 5A State Tournament in Salina.

An outstanding southeast Kansas football player, Colin Colbert was chosen to participate in this year's Shrine Bowl. All proceeds from this game are donated to Shrine Hospitals around the nation. A special assembly honored Colin on Tuesday, January 27.

The Nado football team set the standard for next year being the 5A Regional Champions.

Other state sports participants included ten from the boys swim team, eight wrestlers, five from the girls cross-country team, and two girl tennis players.

Field Kindley students took standard opportunities at school and turned them into something more- golden achievements!



Standard Opportunities, Golden Achievements

Five of the cross-country girls made it to State. They are: Tosha Hoy, Shelly Stewart, Donya McFerrin, Marlene Sanders and Heidi Warburton.



The State qualifiers were left to right: N. Owens, J. Branton, T.C. Carter, D. Buckner, T. Howerter, C. Hillman, P. Hernandez, D. Vacca, B. Smith, M. Wilkinson.



Five senior wrestlers went to State. Qualifiers are: Row 1: C. Naden, Jr. Clairborne, K. Craner, C. Fink Row 2: L. Hill, C. McMurray, M. Hallum, M. Pate.



The Debating Squad: G. Victory, Coach D. Harbaugh, C. Green, P. Winston, S. Diel, S. Hunt, E. Casebeer, and A. Wilson.

Winning the opportunity to participate in the State football play-offs was an outstanding achievement.

S P O



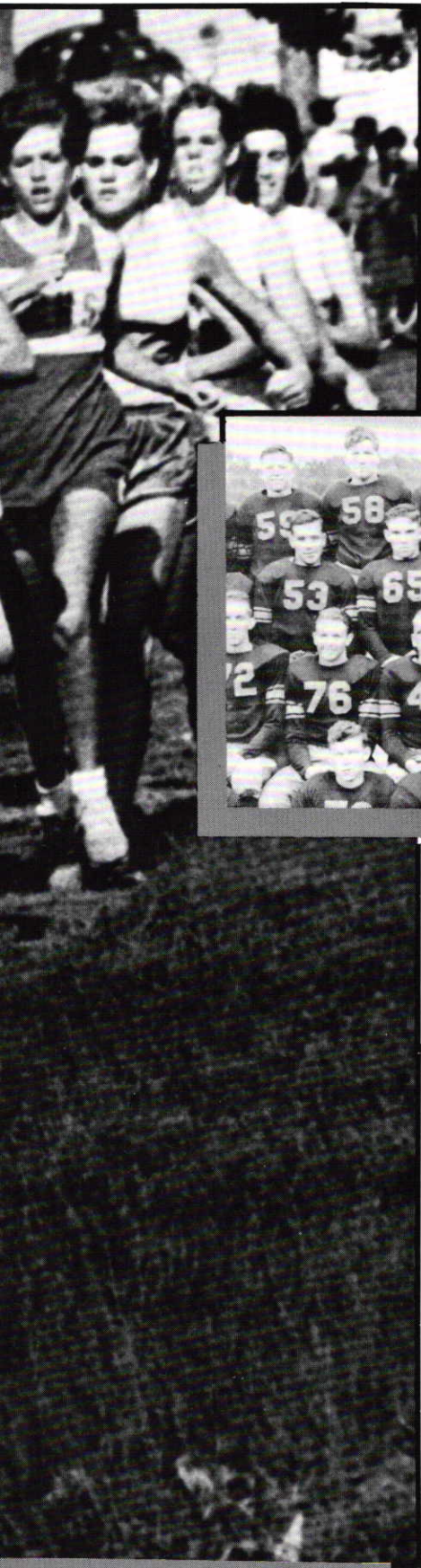

Going for the Gold



The 1937 Golden Tornado Gridiron Squad had a 6 and 4 season seating them 4th in the conference that year. Quarterbacks were Charles Martin and James Logan.

Athletes worldwide pushed for Olympic gold, but for FKHS jocks, gold took on a different meaning. Their gold was the name emblazoned on a football jersey, a stripe on a basketball shirt, or the trim on a cheerleaders' skirts. Not Olympic gold, but FKHS gold meant the same: a standard for success.

Sports means competition and determination no matter what sport you are participating in. Here, senior Tosha Hoy shows her determination in a cross country meet.

Number 36 Doug Hitchcock breaks through the line for a sizable gain against Springfield.



Senior Colin Colbert, Quarterback for the NADO this year goes for a touchdown during the Parsons game Oct. 24.

Jr. Joe Fernandez strips the ball from an opponent as Sr. Mark Pate zeros in for the recovery.

Sr. Mark Pate will not allow a Parsons runner any more yardage.





Got The "Power"!

A powerful season with a golden opportunity to go to state.

Football Scoreboard

	us	them
Chanute	31	6
Rogers, Ark.	21	15
Winfield	21	7
Pittsburg	17	22
Fort Scott	38	13
Springfield	35	28
Parsons	50	21
Altamont	28	13
Independence	21	14

NADO'S 1986 football team really had the power! They had the power to make it through the season with eight wins and the confidence to overcome one loss. This power took them to state and set a standard of excellence for the team and the school.

NADO'S players didn't have it easy reaching this goal. There are long, hard practices everyday after school, "You have to practice to be good", says Senior Tim Blevins. The coaches really put in a lot of time to make the team all it can be. After the defeat to Pittsburg on Oct. 3 the team showed determination and confidence to come back and down Fort Scott 38-13 on Oct. 10. That team and that confidence turned the 1986 football season into a golden opportunity to go all the way.



Members of the 1986 NADO football team were: First Row: Chris Riley, Stan Stewart, Colin Colbert, Todd Childress, Bryant Colbert, Matt Locke, Doug Hitchcock, Tim Blevins, Jr. Clairborne, Kevin Clapp, John Villines; Second Row: James Franklin, Don Sykes, Scott Jarmon, Mike Brown, Kevin Bromley, Rich Riley, Mark Pate, Dennis Dewey, Terry Collins, Shane Elliott, Parris Jennings; Third Row: Wes Smith, Lyman Jennings, Jason Harden, Rodney Gaut, Joe Fernandez, Bobby Vargas, David Siegel, Mike Braschler, James Jones, Tony Jones; Fourth Row: Jim Bloomcamp, Timer Sjolander, Mike Ward, Lance Hill, David Diver, Vince Davis, Clint Chowning, Todd Hills, Monty Carriker, Bill Troxel, Chris Hendrix; Fifth Row: Scott Woods, Theayre Austin, Brian Richardson, Tom Compton, Nelson Hare, Gib English, Jason Grooms, Shannon Mason, Darin Hamlin, Brad Palmer, Derrik Burnett (manager); Sixth Row: Jimmy Horner, Dwayne Dent, Dwight Dent, Curtis Bolden, Chris Burnett, Andre Newton, Corey Shields, Todd Browning; Seventh Row: Jeff Prince, Robbie Blakemore, Todd Cook, Mike Caufield, Dan Kinney.

Senior Doug Hitchcock # 36 buries an opponent enabling senior Colin Colbert # 7 to hurdle for a touchdown against Springfield Hillcrest. The October 17th game was won by FKHS 35-28.

Senior Bryant Colbert # 22 refuses to go down while being tackled by a Pittsburg player. The Pittsburg-Field Kindley game was held October 3rd, in which Pittsburg won by a 5 point margin, 22-17.

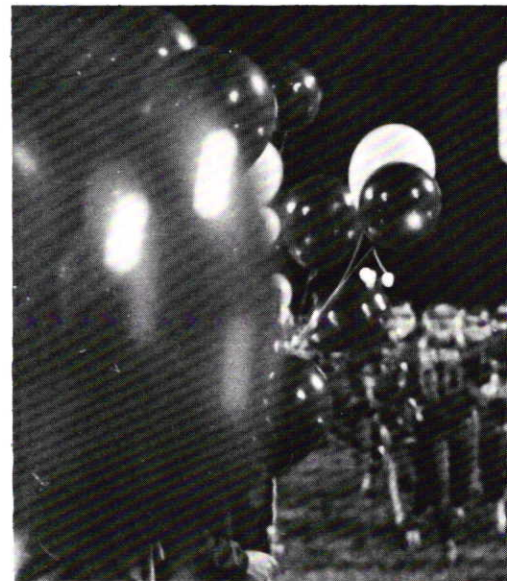

Senior Dennis Dewey refreshes himself with a squirt of water during a brief timeout at the Field Kindley-Parsons game October 24th, which 'Nado won 50-21.





With 1 minute and 45 seconds before the game with Fort Scott, the 'Nado team is greeted on the field by their many fans. 'Nado won the game 38-13.

Concentrating on his next move, sophomore Thayer Austin (far left) intercepts a pass by a Chanute player while fellow player junior Wes Smith (# 75) watches. The 'Nado-Chanute game was the first game of the season, Sept. 12, in which 'Nado won 31-6.



'Nado Life . . .

State playoffs raised school spirit and pride from October 31 — November 14.

The thought of the 'NADO football team possibly going all the way to 5A State Championships began when 'NADO found out that they had made state playoffs after the 'NADO-Grizzly game. For the next two weeks, life on the 'NADO home front was never the same!

The hallways began listening to the excitement and talk of the "BIG" game yet to be played. Slogans, such as "All the way to State!", began appearing on the walls to show the pre-game enthusiasm and spirit. Even Coach Brown got in the swing of things by shaving his hair as he promised if the team made the playoffs.

At the pep assembly held only 4 hours and 50 minutes before game time, 'NADO's school spirit and pride rose to the rafters of the auditorium to be something that would never be forgotten.

This was the first time that 'NADO had participated in 5A Playoffs since 1977. Although Pittsburg won with a score of 16-6, the 'NADO squad finished the season with an 8-2 record (both losses going to Pittsburg) and a No. 2 ranking in Class 5A Associated Press rankings in Kansas.

To add to the glory, the Senior football players received buddy notes from Mrs. Rolands first grade class at Whittier. The buddy notes were to wish them good luck when playing against Pittsburg.

The football squad gave FKHS a great deal of excitement and memories that will never be forgotten.

What do I do now? At the Regional meet in Coffeyville, Senior Marlene Sanders runs a good race to help the girls team go to state.

Ready to Run. Shelly Stewart, Tosha Hoy, Heidi Warburton, Donya McFerrin, and Marlene Sanders show their excitement before competing at the State meet in Manhattan.



No Sweat . . .

A dream come true, as girls' team qualifies for STATE cross-country

A dream come true as the 1986 girls' Cross-Country team finished off a very good year by qualifying for the state meet in Manhattan, November 8. "The girls wanted to go to state because this is the last year we'd be running together as a team," says Senior Tosha Hoy.

Working hard with the boys' Cross-Country team, Coach

Lynn Smith remarked "With so many underclassmen runners, the boys should spend more time developing into better runners." Sophomore Scott Wells knows that, "I did my best this year and had a lot of fun."

Despite tough competition the girls' team claimed third at Regionals to qualify for state. Both Junior Shelly Stewart and Senior Tosha Hoy agreed that "When we made it to state was the best moment of the year."

Just like a dream, the 1986 girls' Cross-Country team met their goal for the year, a trip to Manhattan.



Goofing Off. Shelly Stewart, Marlene Sanders, and Tosha Hoy show that team spirit and friendship go hand in hand.



Keeping Up The Pace. While competing at the SEK meet in Coffeyville, Sean Roland and Paul Parker show that practice does have its rewards.

Finally Done! Junior Shelly Stewart crosses the finish line exhausted from running 2 miles at the SEK meet in Coffeyville.

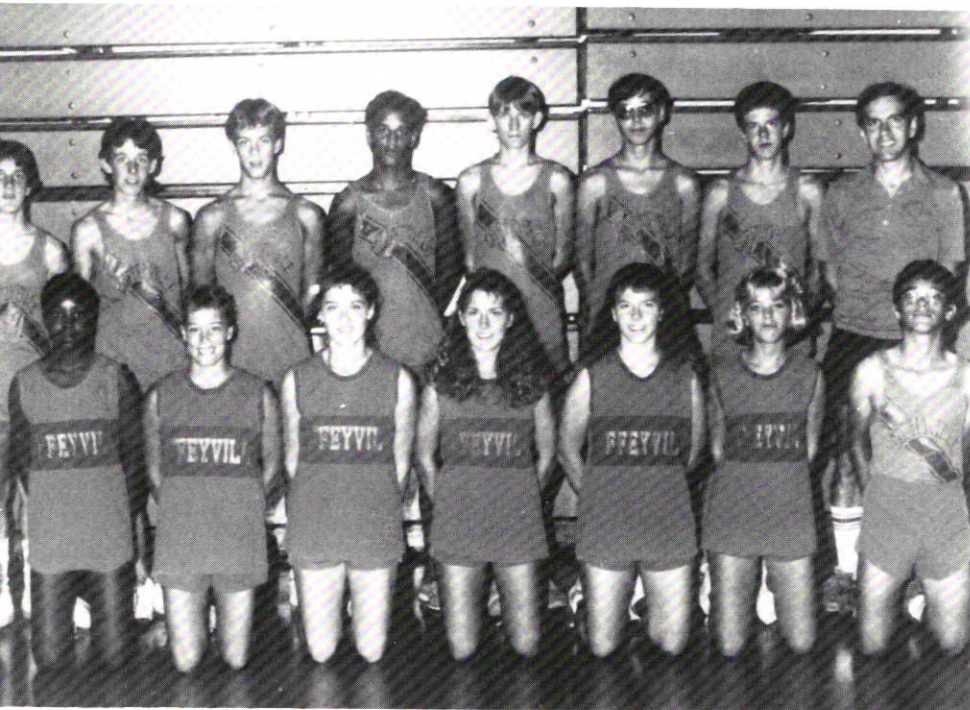

Back row, left to right: Scott Wells, Chad Wheeler, Paul Parker, Sean Roland, Willie Wright, Jeff Hamby, Doug Mirandi, Coach Lynn Smith. Front row: Mike Wright, Marlene Sanders, Donya McFerrin, Shelly Stewart, Tosha Hoy, Janie Hartwig, Heidi Warburton, and Jeff Ulibarri.

Ups And Downs

Senior Lisa Smith prepares to hit the ball, while the Nado volleyballers watch intently from the sidelines.

Junior Stacy Bishop sets the ball, up for a spike, as Senior Paulette Watson, Junior Lisa Smith, and Debbie Pippin prepares to help.



Members from left to right: Jennifer Beals, Stephanie Martindale, Beth Craven, Lori Burdick, Tina Hastings, Heidi Hamrick. Row two: Angela Austin, Shell Haffener, Melissa Gilman, Marcey Wright, Debbi Pippin, Lisa Smith, Stacey Bishop, Theresa Senecal, Rose Uy. Third row: Coach Dale Naden, Cindy Wright, Amy McCurry, Angie VanderLinden, Kim Johnson, Shelly Victory, Paulette Watson, Tracey McGuire, manager Yvonne Burnett.

Volleyball Scoreboard



Juniors Tracy McGuire and Mindi Allen take a break to discuss their mistakes.

	Won	Lost
LCHS/Cherryvale	3	2
Caney/Indy	2	3
Parsons/Iola	2	2
Joplin Tourn.	2	4
Fort Scott	2	1
Invitational	7	3
Iola/Parsons	2	3
Pittsburg	3	0
Chanute/LCHS	2	3



Playing Hard. Senior Paulette Watson shows her determination to win in a match.

Changing of the Guard. As some of the Nado file out for a refresher, new replacements come in.

"What I really like about volleyball is no matter if we win or lose, we play as a team," said senior Paulette Watson. No matter how you look at it, the Field Kindley volleyball team certainly excelled this year, all the while playing as a team.

Coach Dale Naden for the most part was very pleased with the team's performance this year. "I think some players had excellent seasons and I think in some games we weren't as mentally prepared as we could have been, but we did have an excellent year.

A major part of the team's success was the team's unity and the infamous practices after school. "We worked really hard and the practices were tough," said senior Shelly Victory. Junior Stacey Bishop agrees, "I really worked this year; we all did. Especially at practices."

The volleyball team is losing several seniors this year through graduation, and whether or not next year's team will be as good as this year's time will have to tell. But one fact is known for everyone, the team this year set their goals, achieved and surpassed them, and gave us a winner.

The Thrill Of Skill

Pride is what the tennis team was beaming with this year. The team this year certainly had something to brag about: they had an excellent year. "The team feels more together this year," said junior Julie Huffman and senior Keri Bowman. It was a matter of setting new goals and standards that made it.

While tennis is not the most participated-in sport here, that fact does not mean it isn't both

hard work and exercise. "Tennis involves a lot of hard work and I'm really proud of the girls," said Coach Gerald Watson. "Tennis is great exercise and it's relaxing to play with a friend," states Keri Bowman.

Tennis is just like any sport here at Field Kindley: it involves hard work, practice and the determination to succeed.

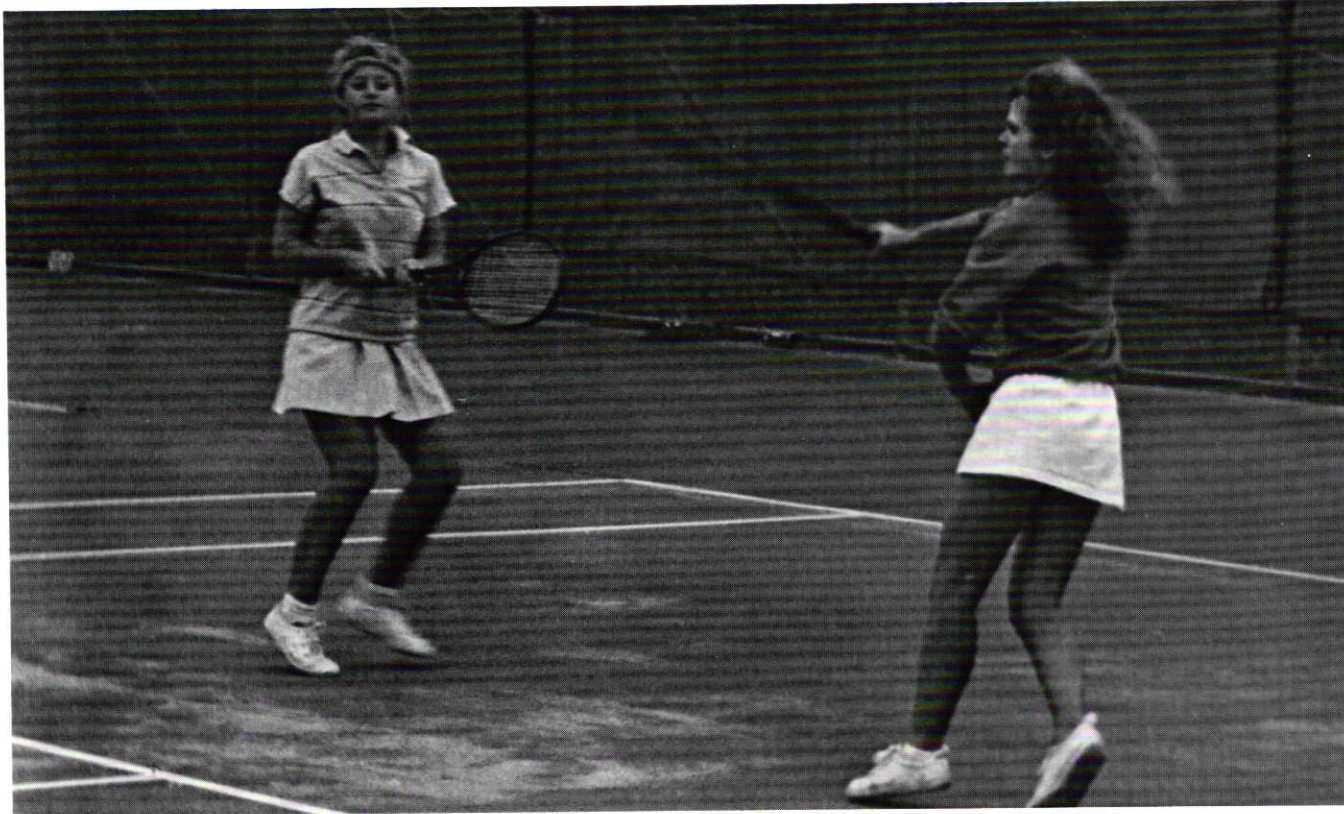

Team Work. Seniors Tara Walton and Keri Bowman show that working together is vital in double play.

"I really liked tennis; it isn't a contact sport. Although sometimes you could get hit in the head with a racket."
Sophomore Cara Locke



The Winning Shot? Freshman Lori Gillen prepares to send a volley which she hopes will win her the match.



Tennis Scoreboard



Parsons Invitational	2nd place
Independence/Columbus	won 1, lost 1
Ft. Scott/Parsons	won 1, lost 1
Chanute Invitational	3rd place
Pittsburg/Chanute	won both
SEKI at Independence	3rd place
Regionals	3rd place

Reaching High. Senior Tara Walton strains to hit an overhead volley.

Concentrating on her swing. Junior Erin Akard practices her backhand.



Members from left to right, front row: Ann McWhorter, Erin Akard, Cara Locke and Keri Bowman. Second row: Jenny Pursley, Julie Huffman, Jo Wheeler, Tara Walton.

Row two cont. Debbie Benning, and Tracy Buckner. Third row: Jennifer Carey, Gretchen Heasty, Sarah Diel, Angela Neale, Angela Elliot and Lori Gillen.

Swimmers Make A...

Tankers who went to state, from left to right, first row: Brian Smith, Mike Wilkinson, Pablo Hernandez. Second Row: Dan Vacca, Darren Buckner, Ted Howerter, Jeff Branton, Third row: Neil Owens, Craig Hillman, T.C. Carter.



Taking a breath, Senior Neil Owens swims on to take fifth place in the 100 breast stroke at the All Kansas Invitational swim meet.

Get ready, dive! Junior Mike Wilkinson gets ready to make his spectacular dive at one of the FKHS swim meets.

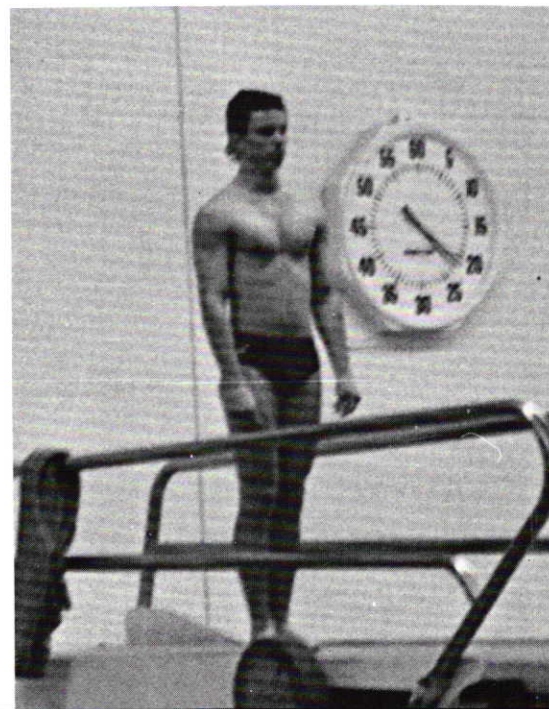

Starting the 400 free style relay, freshman Brent Smith, left, and Senior Darren Buckner, right, take their positions on the starting blocks at the Coffeyville-El Dorado meet.



... Big Splash!!

Making a big splash is certainly what the 1986-87 Field Kindley swim team did by bringing home the third place trophy at state for the second year in a row.

The members of the FKHS swim team were made up of special kinds of athletes that push themselves to the limits. The swimmers dedicate themselves to swimming several thousands of yards a day. Not only do the swimmers show this dedication by swimming from three to five in the afternoon, but also from six to seven-thirty in the morning.

This hard work and dedication really paid off for the swimmers. Eight swimmers and two divers qualified for the State competition in Lawrence on February 20-21.

In addition to the state swim meet, the NADO swim team had a record of 39-8 and brought home their own trophy from the FKHS Invitational for the first time.

To the victories, however, there is one loss to the team after this year. The FKHS swim team will be losing the seven veteran seniors that will be graduating this year. Next year Coach Whalen will be working with an all new team.



Sitting left to right: Heath Owen, Jeff Hamby, Jim Monk, Brent Smith, Paul Parker, Scott Wells; 2nd row left to right: Manager Tara Walton, Craig Hillman, Pablo Hernandez, Jeff Branton, T.C. Carter, Terry Martindale, Mike Wilkinson; Back row left to right: Coach Pat Whalen, Darren Buckner, Ted Howerter, Neil Owens, Brian Smith, Dan Vacca, Manager Heather Gillis.

Scoreboard

Wichita South	won
FKHS Invitational	1st place
Oolagah	won
Topeka High	1st place
Wichita North	won
Emporia, Topeka	1st place
Bartlesville	lost
Jenks	4th place
Springfield-Glendale	2nd place
El Dorado, Junction City	1st place
All Kansas Invitational	
Manhattan	4th place
State Swim Meet-Lawrence	3rd place

"Face to you Mr. Bombers" says Sr. Neal Carpenter as he makes two more points for Nado against Mountain Home.

Block that shot! Sophomore Alan Marlow shows his expertise in blocking a Parsons attempt to make a basket.

Keying in for two Sr. Bryant Colbert dives for the basket, as Sr. Darren Schroeder waits impatiently to see if he makes another point for Nado against the Bulldogs.

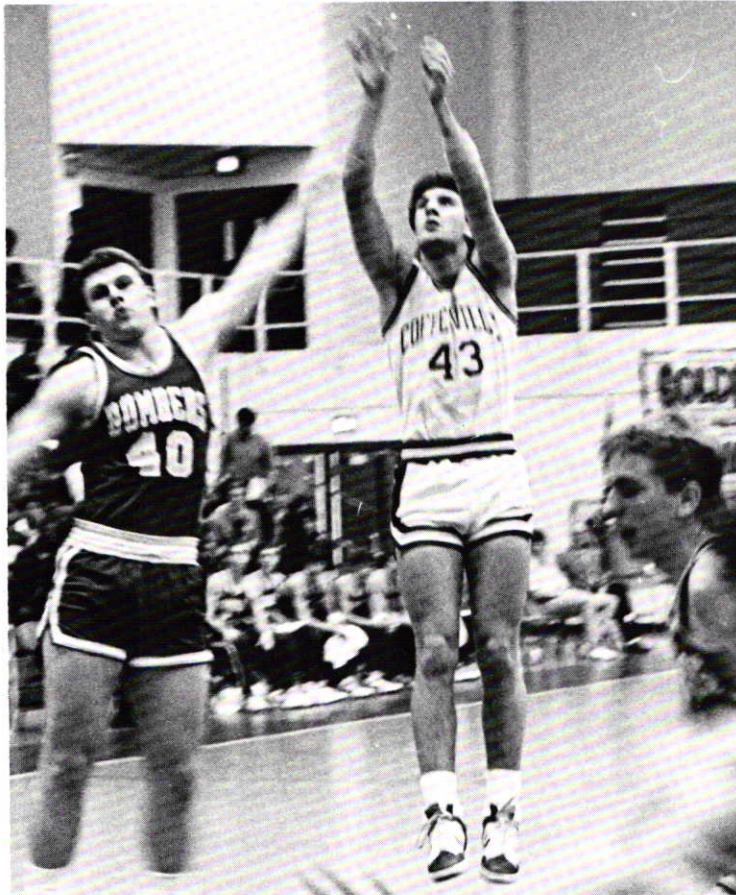

It's In The

B-a-s-k-e-t

It's in the basket! This statement told the story of the FKHS Boys Basketball Team this season, and they won their first game against Pittsburg 54-53. They were so good they achieved an overall record of 12-7.

In a recent survey the question was asked: What team do you fear playing? Senior Colin Colbert says, "There is no team I fear playing. If everyone works to reach

their full ability we can beat anyone." Senior Neal Carpenter says, "We might not win, but we fear nobody and will play anybody."

The question was also asked: What do you like about being on the team? Senior Dan Hamrick says, "We all get along and we have fun together." The team has pulled together and made the season a good one. Coach Sherman

Jones says, "I'm pleased with the way the team has played. They have played some tough teams and in these games they have played to their full ability. The team has played much better than I expected." Assistant Coach Charlie Bloomcamp says, "The team has played as well as they possibly can."

This ends another good season for the NADO.



Time for two Senior Darren Schroeder takes a free throw during the game with Victory Christian, while the other players wait with anticipation to see if he makes it or not.

Dribble ' Drabble Taking the ball down court Sophomore Aaron Haynes drives in the game against Mountain Home.

Scoreboard

	us	them
Pittsburg	54	53
Tulsa Metro	53	72
Winfield	43	39
Fort Scott	72	63
Tulsa Victory	72	59
Parsons	41	62
Mountain Home	52	62
Independence	70	55
Springfield		
Glendale	44	55
Chanute	59	54
Fort Scott	53	47
Independence	59	54
Chanute	56	50
Pittsburg	48	54
Independence	58	66
Parsons	53	90
Columbus	91	63
Altamont	56	55
Iola	60	58

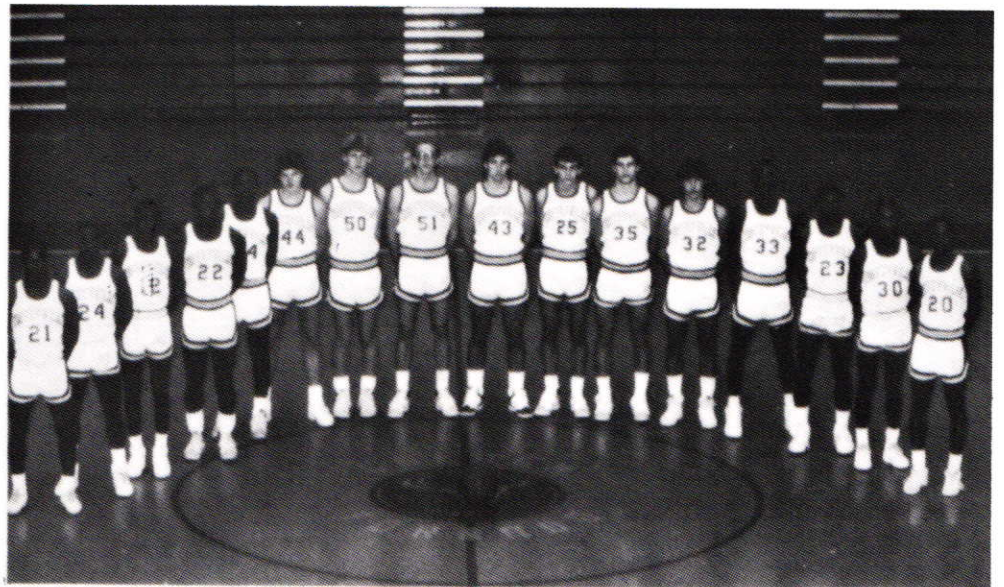
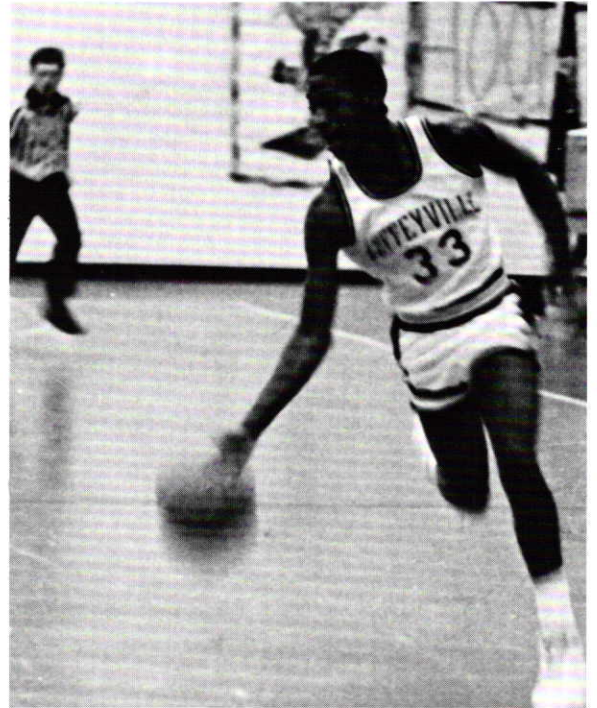

Left to right: Colin Colbert, Shon Ransom, Tony French, Bryant Colbert, Theayer Austin, Alan Marlow, Jayson Miller, Dan Hamrick, Neal Carpenter, Jim Cox, Darren Schroeder, Mike Ward, Aaron Haynes, Tyrone Burnett, Corey Shields, Marlon Turner.

They're the best! Nados all tournament cheerleaders at the Interstate Classics were from top to bottom: Regina Martin, Shelly Ortalani, Jennifer Erickson, and Kim Pool.

It's My Ball! Fighting offenders, Nados Neal Carpenter holds on to the ball while looking for an open teammate.



All Tournament Team. Being the best squad at the Interstate Classics were the Wichita East cheerleaders.

Going For It! Nados Aaron Haynes aimed high while Shon Ransom and Neal Carpenter watched during an exciting game at the Interstate Classics.

Interstate Classic Action

ALL TOURNAMENT TEAM
 Marcus Ziegler Wichita South
 Orlandus Walker Wichita South
 Ron Johnson Bartlesville
 Paul Rogers Bartlesville
 Cornell Bell Wichita East
 Alton Brown Wichita East
 Brian Hansen Bishop Miege
 Guy Earle Independence
 Steve Morris Mountain Home
 Craig Boswell Springfield- Glendale

MOST INSPIRATIONAL PLAYER
 Marcus Ziegler Wichita South

FREE THROW TOURNAMENT
GIRLS
 1st Sherri Peyton, Coffeyville
BOYS
 1st Craig Boswell, Glendale
SLAM DUNK
 High School Division
 1st Guy Earle, Independence
 Open Division
 1st D.L. Riley, Coffeyville

For three days in January the best basketball teams in the four state area come to Coffeyville to compete in the Interstate Classics. 1987 was the 14th year that Field Kindley hosted the Interstate Classic.

"The Interstate Classics are a chance to bring in teams that we (Coffeyville) wouldn't get to see from the four states, says Nados coach Jones, "Its become one of the toughest tournaments in the state."

Nado lost their first game in the Classic, but rebounded the next night to beat Indepen-

dence by 15. "When we played the top seeded team, Springfield, it was a close ballgame until the end, when we lost by 11," remarks Coach Jones. "We've always played bigger schools during the Classics and played pretty well."

With some of the best teams and some of the best players coming to compete in the Classics, January 22-24 provided Nado players with tough competition and Field Kindley students with unbeatable entertainment. The real thing. The Classics.

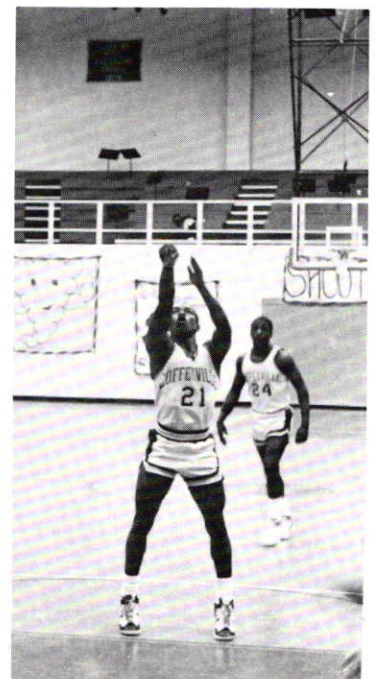

Looking for a basket Nado's Colin Colbert and Shon Ransom watch the ball, hoping for a basket during the Interstate Classics.

Standing tall Nado's cheerleaders helped start crowd enthusiasm during the Interstate Classics.

Hard Work Pays Off For Girls Basketball . . .

One Explosive Team

The season started out well for the Lady Nado. They burst into the season by beating Pittsburg 32-38 for their first game. They continuing winning until their game with Parsons where they lost 32-38. The season wasn't the best it could have been, but it wasn't the worst either. It all turned out well, though. The girls only lost eight of their nineteen games.

The girls work for

what they get and they deserve it. They have practice everyday after school in which they work on a lot of shooting and even do some running. The coaches give a lot of criticism on what can be done better or what was done wrong, but since they still offer supportive remarks when the time is right. By doing this, it helps the girls maintain a winning position.

The girls also serve as a second family to each

other. A team must get along and work together in order to accomplish anything. They all work together and try to help each other through the rough parts. "All the girls are like sisters to me in some ways.", comments Senior Shelly Victory. Knowing that the team is winning and working hard together serves as a major component for one explosive team.

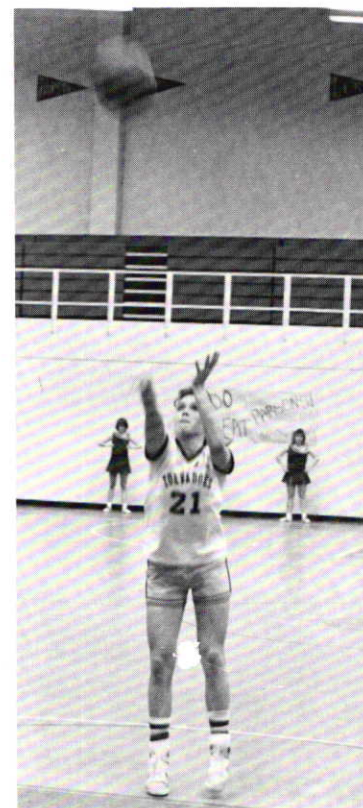

Concentration. Junior Shelly Stewart concentrates on the basket as she attempts a free throw during the Parsons game. The Lady Nado lost 32-38.



Left to Right: Mgr. Brenna Sanders, Angie Austin, Edna Davis, Angie Vanderlinden, Marlene Sanders, Shelly Stewart, Alicia Jackson, Michelle Wassom, Shelly Victory, Latisha Johnson, Julie Huffamn, Doris Harris, Angie Tiptom, Lisa Wilkerson, Renish Trussell, Mgr. Brooke Hollyfield, Head Coach- Jim Littleford, Assistant Coach- Mark Chance.

The Lady Nado had to overcome some tough defense to win their games this season. Ramona Matthews shoots from the outside as Latisha Johnson prepares herself for the rebound against Pittsburg.





SEK leading scorer Ramona Matthews attempts to get her teammates to run the offense.

Scoreboard

	us	them
Pittsburg	63	38
Tulsa Metro	40	30
Winfield	58	51
Fort Scott	51	34
Tulsa Victory	64	43
Parsons	32	38
Pittsburg Colgan	49	16
Cherryvale	57	38
Altamont	49	51
Chanute	23	54
Fort Scott	51	34
Independence	34	64
Chanute	39	54
Pittsburg	51	36
Independence	40	54
Parsons	43	46
Columbus	58	56
Altamont	50	59
Iola	48	60

Help! In a pressure sensitive moment Senior Captain Shelly Victory intently looks for a teammate to inbound the ball to.

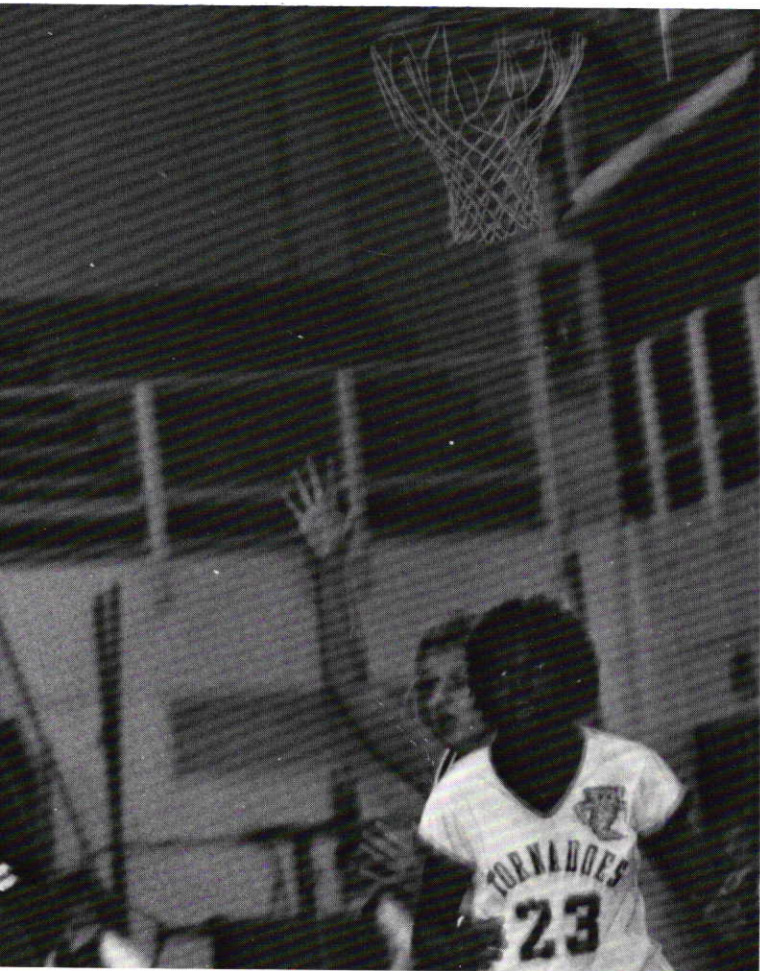

O R G A N I





Standard Choice

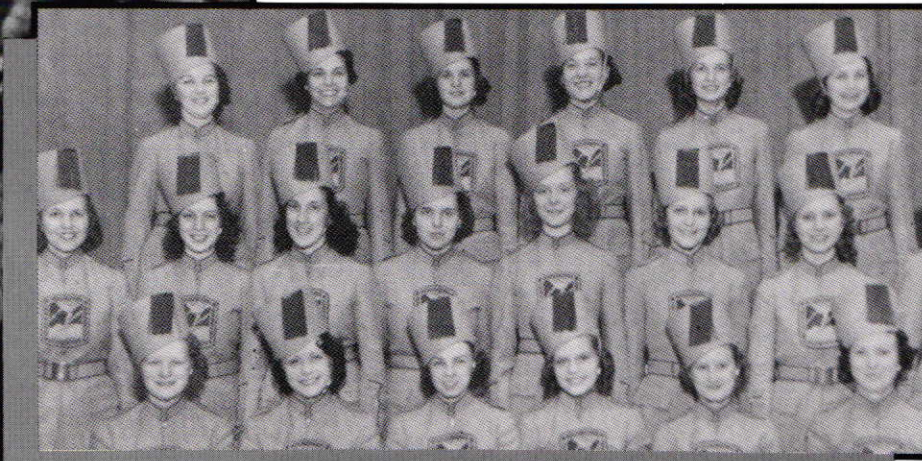

The 1936 Tornado Tillies girls' pep club was organized in 1926 as a group to promote pep and leadership in our student body. The Tillies were truly the "persistent promoters of pep" in the high school.

Decisions, decisions. It's a choice between debating for NFL or performing at halftime, facing FKHS students this year. Clubs mean more than standard meetings, they mean painting a school banner for competition or contributing extra hours after school. Still, the students here chose to dedicate time to the above-standard organizations.

Pep and spirit. Every school has it, but ours was golden. Cheerleaders including senior Kim Pool, Jennifer Erickson, sophomores Jenni Seger and Jodi Hiner, and senior Joni Little were showing it.

Spirit

"N-A-D-O!" Nado Varsity cheerleaders shout their spirit and enthusiasm while performing a Nado cheer to the "pepped up" crowd, Dec. 9, during a pep assembly.

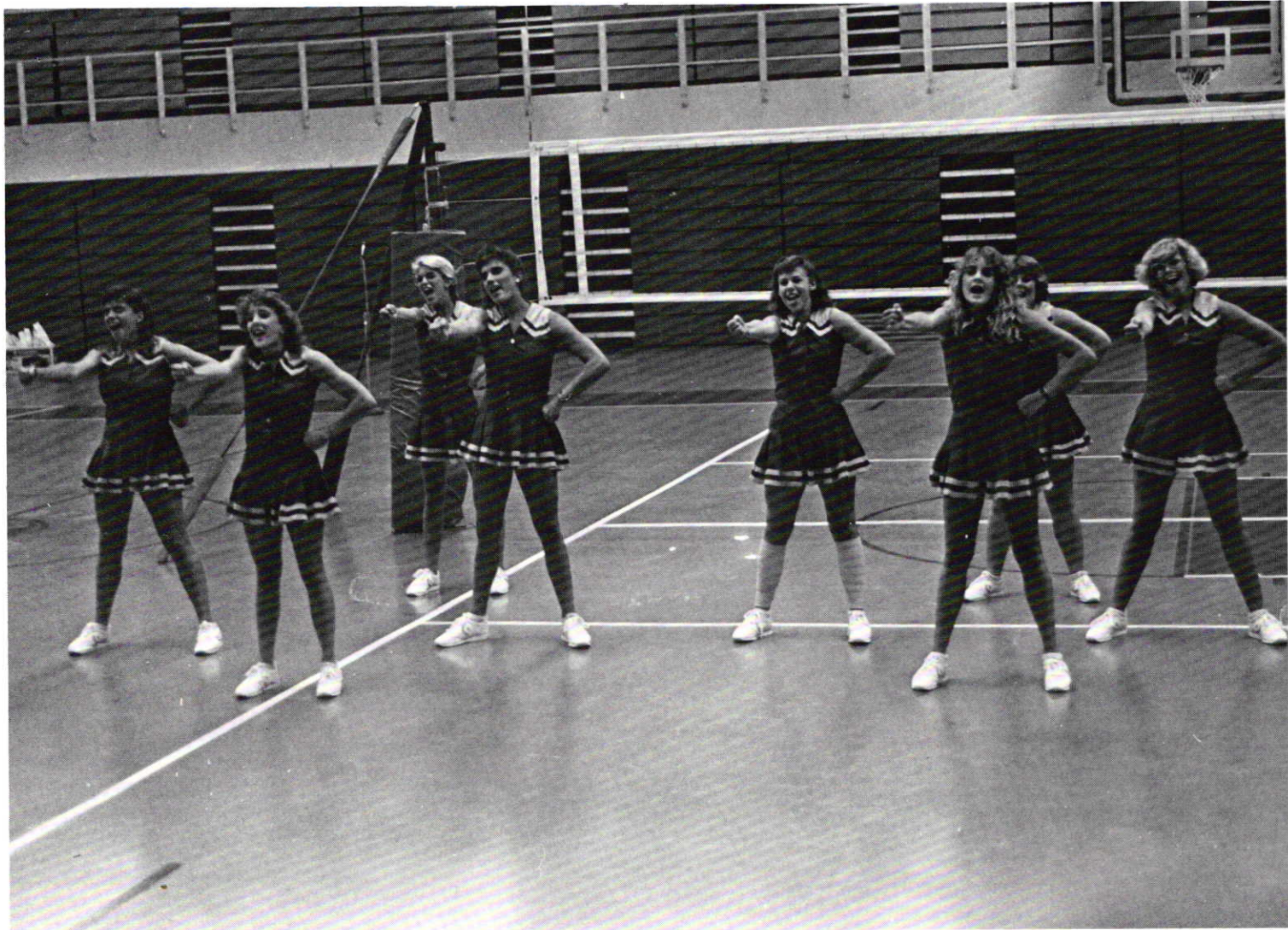

First Row: Regina Martin, Amy Naden, Shelly Ortoloni, Kristi Chaffin, Jennifer Erickson, Kim Pool, Joni Little, Lora Reardon. Second Row: Christie Logan, Brandy Vogt, Christie Alwood, Jodi Hiner, Jenni Seger, Tonya Glenn, Melissa Luker, Kelly Tate, Michelle Blanding. Third Row: Lisa White, Pennie Durham, Dianne Huneycutt, Stephanie White, Stephanie Nadolny, Stacey Coltharp, Susie Garrison, Vanessa Bardwell, Robin Blanding, Laura Winston, Tricia Wright, Marsha Crouch, Edna Davis, Latisha Johnson.

"I like the Spirit Squad because we get to do neat things for the players. One bad thing is that it keeps you real busy and it's hard to keep up", says Cheerleader Christie Logan. Spirit Squad is busy with practice and activities during the year. They hold pep rallies before games, decorate the halls, and they held their 4th annual fashion show this year. During the summer the Spirit Squad went to DCA camp. "It was a lot of very hard work, practicing routines all day and far into the night", says Pon Pon Stacey Coltharp. Coffeyville came back with a 3rd place trophy. As you can see, Spirit Squad is not all fun and games, but the girls do their best and enjoy what they do.

Squad

Cheerleading takes a lot of practice, so they practice everyday sixth hour. Here they demonstrate something they practice a lot, forming a pyramid.



Nado to State! State got closer and Nado kept winning. Here cheerleaders express how happy they are.

Sophomores Christie Logan and Brandy Vogt cheer on the crowd at the first pep rally held this year.

Cheerleaders charge Nado up for the Rogers game on Sept. 19. Their efforts were rewarded when Nado beat Rogers 21-15.



Dare To Be More

To many people, more means many different things or ideas. That seemed to be the case with two organizations at FKHS: Student Council and National Honor Society.

Student Council was composed of 23 members representing the student body as a whole. The members were selected by their class at the end of the previous year.

Student Council's main responsibility to the student body is to try and get students involved and raise their spirits. Leadership is also a responsibility. Stuco must set an example and take charge. Student Council president, senior Lori Burdick commented, "Don't worry what other people think of you for being the first to stand and yell."

National Honor Society was

made up of juniors and seniors in the top 15% of their class. Other than grade point average being the key factor in selection, character was another.

Both organizations were important to contributing to the success of the year. By taking challenges, being different, involved, and giving their all, Stuco and NHS 'dared to be more' in 86-87!



"Lori's almost got it!", screams Miss Dodson as she informs the crowd of seniors Lori Burdick and Debbie Pippin's status in the cotton ball pass at the Stuco-sponsored Almost Anything Goes October 29. The event enabled students to miss 5th and 6th hour.

Enjoying the fun of it all, seniors Lisa Smith and Debbie Pippin flash winning smiles at the camera while getting ready for group pictures.

As part of the initiation procedures, NHS member David Coughenour had to wear pig ears, tail, nose, and had to oink the Alma Mater on the lawn after school on December 17, 1986.



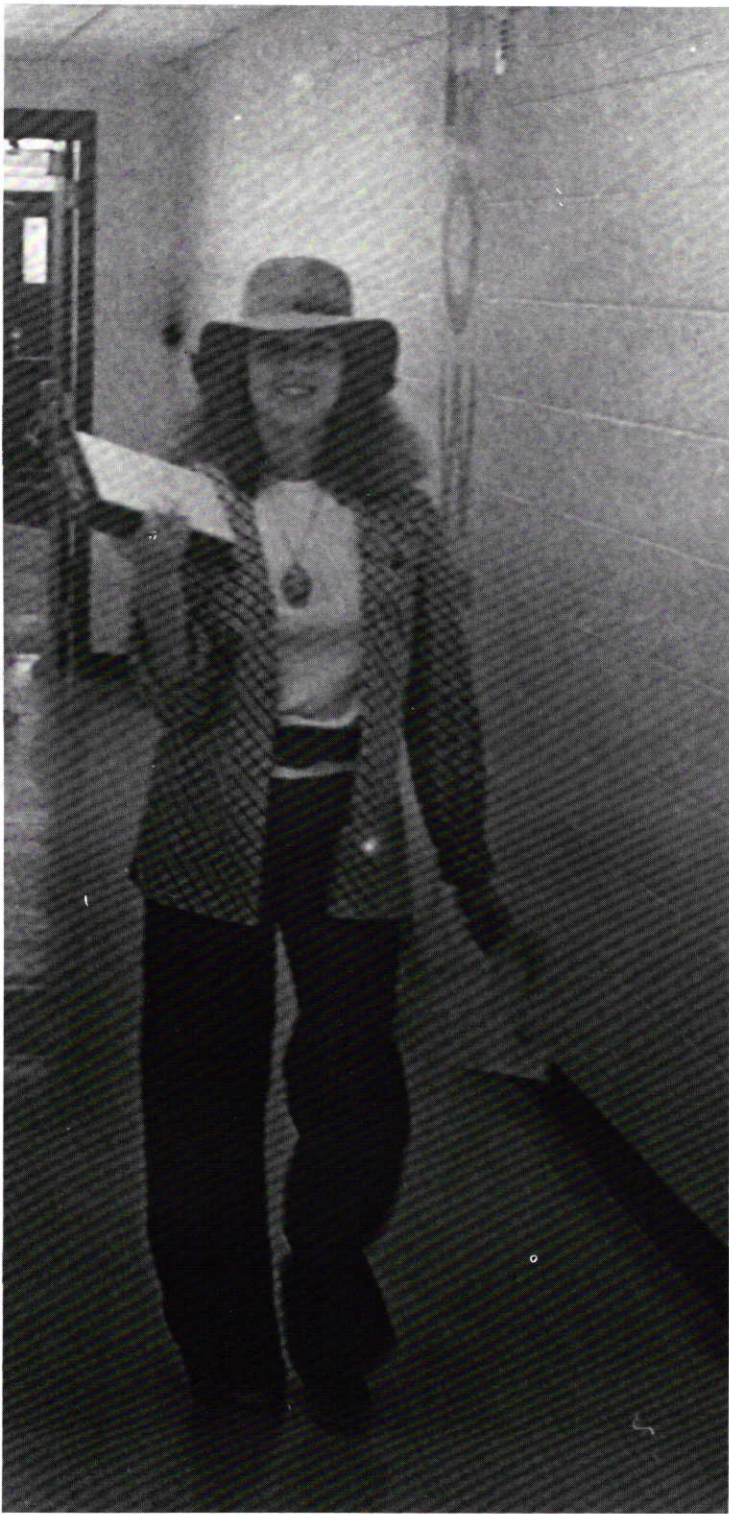

Junior Shelly Stewart smiles for her "hippie" ways during Hippie Day, November 4th. Spirit Week was sponsored by Student Council November 3rd-7th.

Posing after a Stuco meeting, that's held every Monday and Tuesday at noon, is Miss Kengle and Senior Lori Burdick-Student Council President.

Stuco: Dwight Dent, Jr. Clairborne, Lori Burdick, Lisa Smith, Melissa Powell, Chris Fink, Darren Buckner, Debbie Pippin, Shelly Stewart, David White, Cardian Page, Alisha Wilson, Brian Foote, Shelly Victory, Derrick Freeman, Hershel Shoats, Vanessa Bardwell, Brandy Vogt, Tonya Arnold, Gina Kent.

NHS: Shelly Victory-Secretary, Janie Hartwig-Vice President, Kristi Bohr-Treasurer, Stephanie White-President, Darren Buckner, Chris Fink, Neal Carpenter, Patrick Henry-Advisor, Mike Breen, Lisa Conger, Pennie Durham, Susan Blair, Gayla Malone, Keri Bowman, Tim Blevins, Tena Collins, Cheryl Lendall, Daniel Vacca, Lorie Brinkman, LeeAnn Hyatt, Jr. Clairborne, Steve Hunt, Troy Donahay, Kristi Chaffin, Brian Foote, Joni Little, Jennifer Erickson, Kim Pool, Shelly Stewart, Tasha Hoy, Cindy Green, Paul Winston, Mindy Allen, Jenni Seger, Tamara Thompson, Paulette Watson, Michelle Schoonover, Lisa Maritt, Amy Naden, Jeff Branton, Craig Hillman, Lisa Herrenbruck, Rhonda Erne, Tina Hastings, Michelle Blanding, Melissa Johnson, Stacey Bishop, Sarah Diel, Beth Craven.

Foreign Chatter

Spanish instructor Mrs. George prepares for her next Spanish class by punching holes in assignments the students use to compile Spanish notebooks.

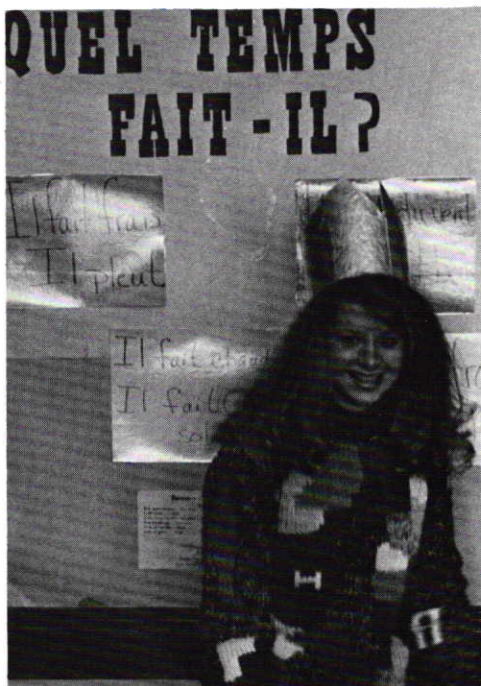

Tara Walton, Senior, wonders what is the weather like? French 1 class memorizes French phrases about changes in the weather.

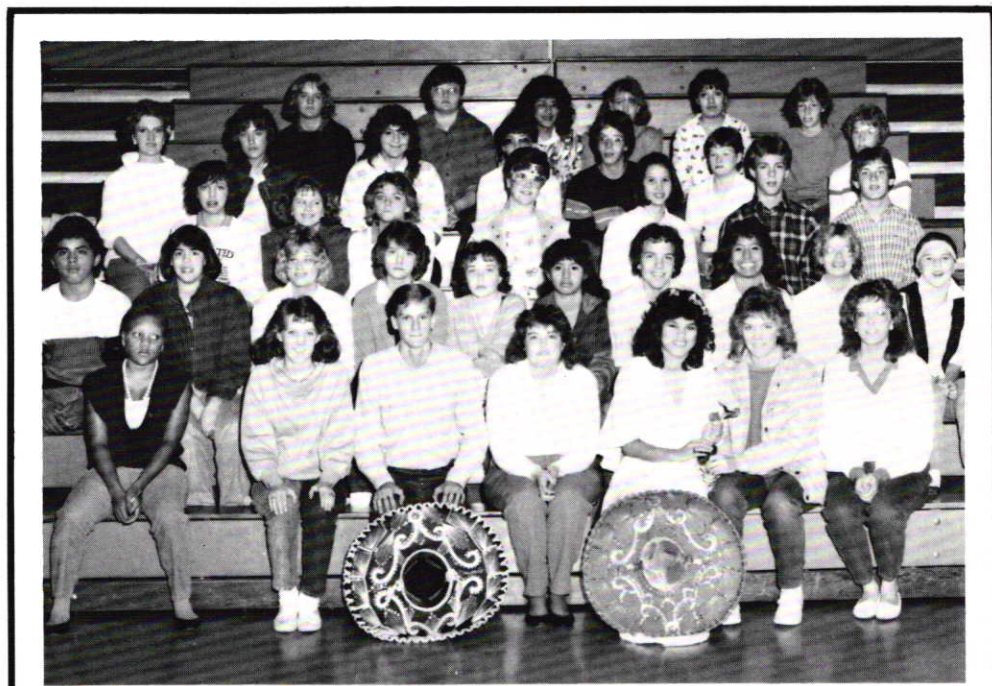

Spanish Club, top row from left to right: Larissa Beverstock, Beth Ables, Alma Azuara, Michelle Manley, Erica Gonzalez, second row: Mrs. George, Rhonda Bonham, Casandra Resse, Jon Pevehouse, Chad Liddell, Heath Owen, Teresa Collins, Melissa Hurley, third row: Kristi Hodgson, Jean Nordine, Samantha Cunningham, Holly Mitchell, Rosalynda Uy, Paul Parker, Scott Wells, fourth row: Eddie Cox, JoAnn Byrne, Becky Beverstock, Lori Bohr, Missy Jontra, Annette Jaimez, Nate Morrow, Ann Jaimez, Missy Jackson, Kristi Hodgson, front row: Antionette DeJear, Stephanie Nadolny, Daniel Vacca-Pres., Michelle Merriman, Beth Craven, Tracy McGuire, Melissa Johnson.

The Bean King and Queen 1987. Tara Walton, senior, and Brett Thomas, junior, are the Bean royalty based on a French tradition used to celebrate Epiphany. A bean was discovered in Tara's piece of cake to win this honor.

Juniors Beth Craven and Tracey McGuire seem to be enjoying each others company while attending a Spanish Club meeting on December 4.



Hola! or Bonjour! either one may appear as a greeting or just a group of letters. It all depends on whether you've had a class of foreign language.

Spanish and French classes are brief escapes into two unique and distinct countries' traditions and cultures. FKHS offers different levels for further education in these two wonderful and useful languages. Peri Van Tassel said, you should "take a foreign language to become more aware of the world outside Coffeyville." For further education Spanish and French offers level I to level III. Levels I and II teach the basic grammar, pronunciation, and culture of each language. Mrs. George says you should take more than one year of foreign language "because studies have shown it takes two years to begin real communication."

Many activities were conducted through out the year, such as the Spanish Club going to Parsons for the "Ballet Folcklorico de Mexico", the French Club going to a play at Tulsa, "Le Bourgoise de Gentilhomme."

So be E.T., Extra Terrific, learn a foreign language and double your world!

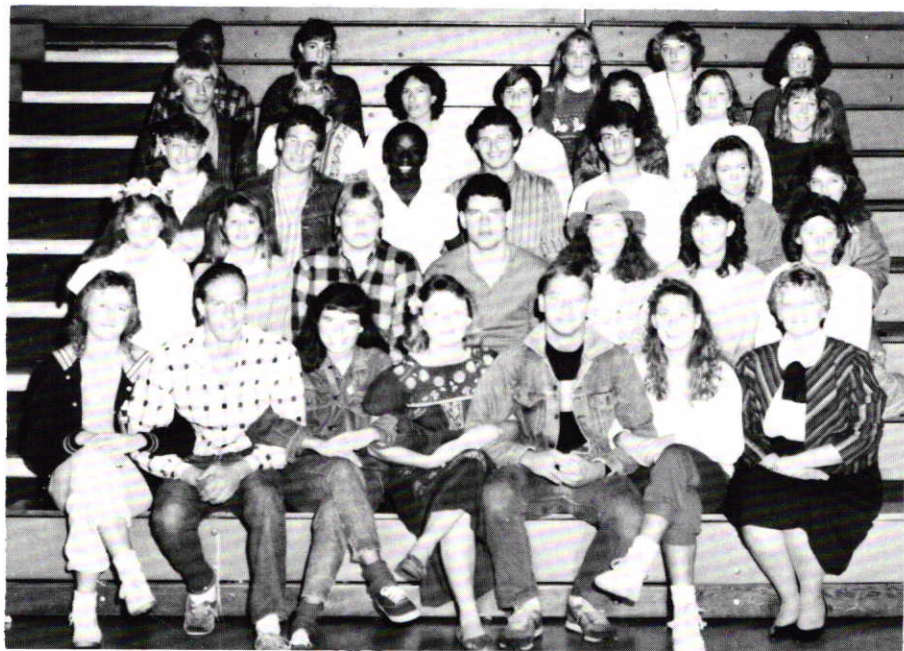

French Club, top row from left to right: Mike Page, Inga Richardson, Teresa Thompson, Melanie Robinson, Michelle Schoonover, second row: Rouglas Folk, Cheryl Lendall, Melissa Traham, Amanda White, Janie Hartwig, Tamara Thompson, Hether Gillis, third row: Kristi Chaffin, Chris Fink, Jr. Clairborne, Dennis Dewey, Bret Thomas, Lisa Maritt, Teresa Wright, fourth row: Julie Huffman, Tara Walton, Pete Barndollar, Todd Childress, Shelly Stewart, Michelle Reynolds, Tina Bixby, front row: Melissa Powell, Ted Howrter- President, Joni Little-Secretary, Jennifer Erickson-Treasurer, Darren Buckner - Vice-Pres., Tosha Hoy, Peri Van Tassel, Sponser.

A Matter Of Getting Involved

Stereotyped. Sometimes that's how the members of the Future Farmers of America and the Future Homemakers of America feel. Some students of FKHS believe all the members of these clubs do is go "stand out in a field of manure," or arrange bake sales. Stereotypes are often wrong; the myths about these clubs are no exception.

Both clubs do many things; both receive little credit. The FFA is a branch group of Vocational Agriculture, a class which is taken by many high school students. They sponsored the NA-DOG dance held after the annual Independence-Coffeyville football game. They also brought Universal Wrestling to our gym on February 22, while the FHA sold Tom Wat boxes as a fundraising project.

Participation and morale is a major part of both clubs. Leadership is really a dominant factor; the FFA officers attended a leadership contest in November and played a big role during FFA Week in late February. The FHA members learn through doing, and attended the FHA District Convention in Independence in the fall.

FFA club officers, left to right: David Kiser, Rhonda Erne, Randy Reardon, Donna Oakley, Dan Hamrick. Not pictured is Jon Mayo.

Most of the negative attitudes, however, don't come from the members themselves but from the uninformed student body instead. People associate them baking or milking cows and nothing else. The members know better. They know the benefits of the leadership and the self-confidence the clubs have taught them. The negative attitude isn't justified, but exists here still the same. Yet the two clubs are breaking down the barriers and proving to the student body just how great and hardworking they really are.



"It's a good chance to develop leadership skills and it helps you grow in public speaking skills, but going to the fairs is the fun part."

Senior Donna Oakley



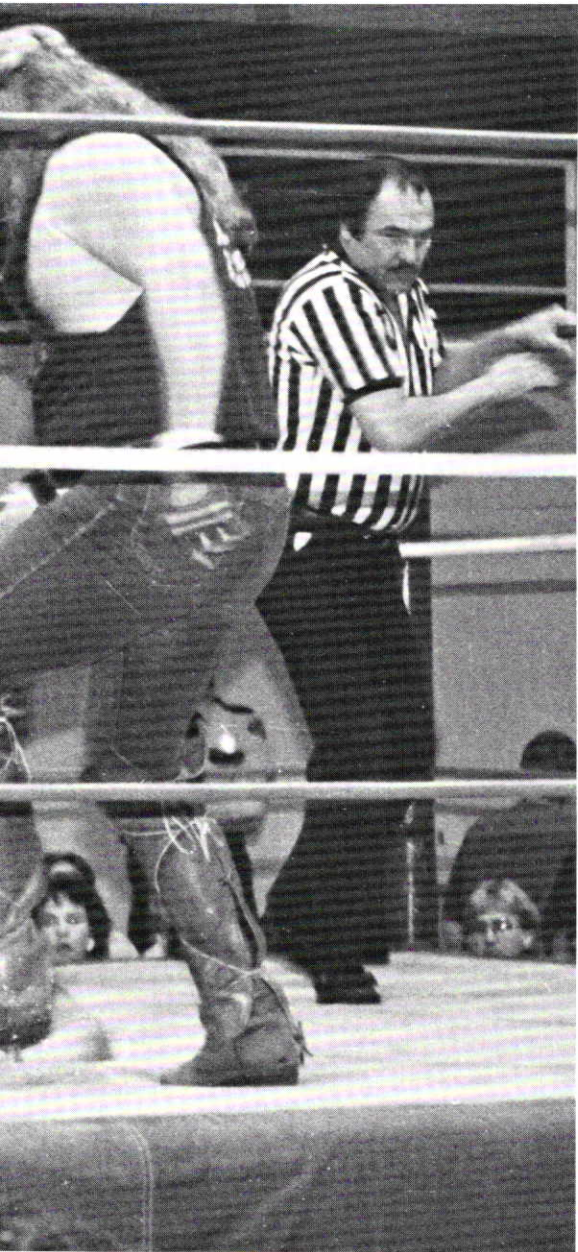

The FFA sponsored Universal Wrestling from Tulsa on February 22. One of its competitors was Steve Cox, who got a boot from Wild Bill Irwin.

As a money-making campaign, the members of the FHA club sold Tom Wat merchandise boxes in the fall of '86.

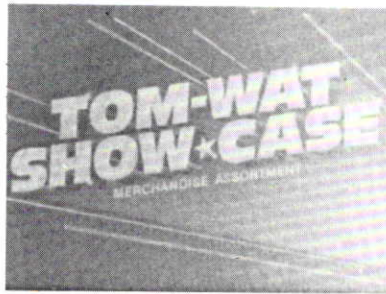

FHA members, row 1: Sheri Peyton, Michelle Triebel, Debbie Shores, Norma Morgan, Tina Powell. Row 2: Jenny Moses, Terri Lipe, Tracey Moses, Cindy Crouch, LaShell Haffener, Marsha Crouch, Kristi Blakesley, Misti George. Advisor: Mrs. Lumley



FFA members, row 1: Eddie Wilson, Lori Burdick, Pennie Durham, Salesa Smith, David Kiser, Donna Oakley, Dan Hamrick, Rhonda Erne, Steve Freeman. Row 2: Tom Morgan, Curtis Knight, Cindy Felts, Derek Burnett, Jody Lynn, James Jones, Kip Young. Row 3: Dwayne Messner, Aaron Miesner, Cody Collier, David Lantz, Todd Van Buren, Robbie Blakemore, Tina Prescott, Linda Benning, Patty Barhart, Nancy Wagner, Dana Quintaro, Shawn Marlow, Grady Bush, Scott Woolfolk, Kristi Maxson. Row 4: Jim Bloomcamp, Janet Bloomcamp, Brian Woolfolk, Tony Stotts, Nelson Morris. Row 5: Keith Brashear, Jim Long, Vyril Smith, Larry Benning. Row 6: Travis Morris, Shane Triebel, Jason Coffey. Not pictured: Marty Benning, Casey Brown, Jerry Dawkins, Mike Gilliland, Franklin Page, Mike Smith, Tom White, Lisa White, Jon Mayo, Randy Reardon, Howard Walker, Randy Pope, Angela Lockaby, David Rowland, Tony Vowell, Raymond Coffey, Mike Swiggart.

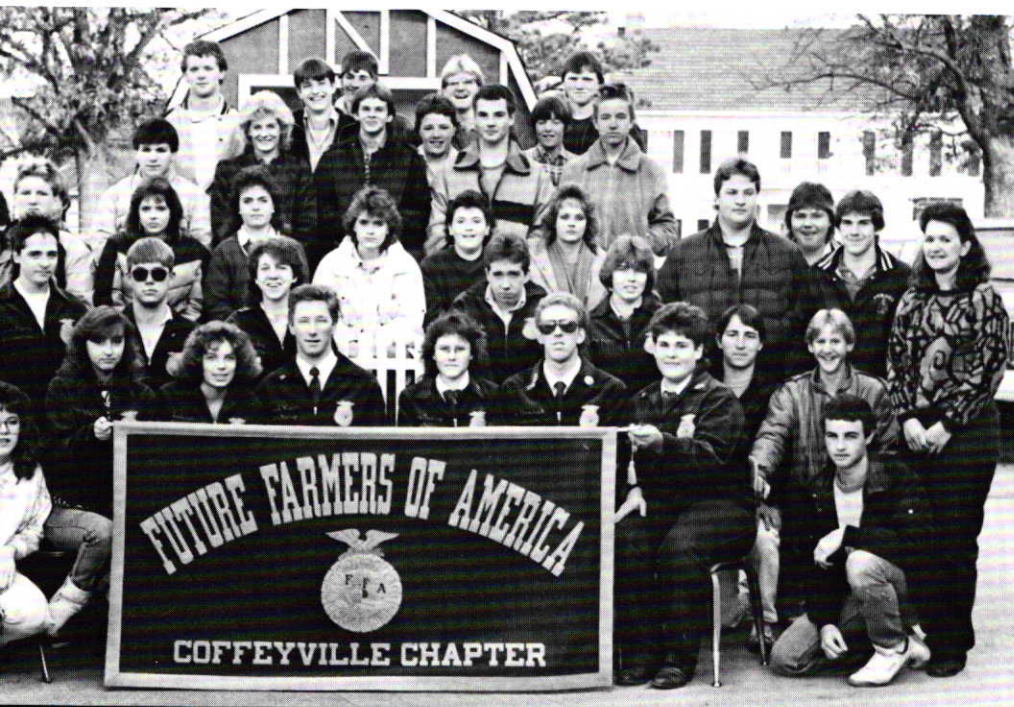

Be A Part Of It

Opportunities ... Both ACTS and Kayettes offered Field Kindley students a chance to be a part of something that would enable them to make new friends and have many different experiences.

ACTS (Active Citizens Together in Service) is a club for Christian young people to join. According to sophomore Karen McDaniel, "The ACTS club has organized Monday night Bible studies and also has started prayer breakfasts once a month before school. We have fun times with other high school Christian clubs."

Kayettes (Kansas Activi-

ties for Youth) is a girls only club whose main goal is to help the community and charitable organizations. Kayettes has participated in many activities. Soph. Angela Wishall says, "At the beginning of the year we walked in the Crop Walk. Recently we participated in 'Almost Anything Goes' and now we are working on Thanksgiving cards for people in nursing homes." Soph. Darcey Ross comments, "A person would like to join Kayettes because it's a good place to meet people, be a part of the community and have a good time."

"The ACTS club is a great opportunity to be a witness to your peers while meeting friends."

Karen McDaniel



ACTS top section from left to right: Tammy Eden, Ren McKellips, Cara Locke, Michelle Wassom, Melissa Gilman, Stacy Wilkerson, Ken Mitchell, Holly Gartner, Jennifer Logan, middle section: Toni Eden, Melissa Hendrick, Amy Stuckey, Gina Dixon, Kendra Grigg, Darin Hamlin, Steve Gillmore, Tisha Thompson, Lisa Ediger, Cheryl Lerdal, Teresa Blackburn, Rhonda Burghart, Teresa Ruark, Jason Clark, Boy



Head of the Class Mr. Murdock talks to his ACTS group while Stacey Coltharp, Rick Wilson and Karen McDaniel listen attentively.

Looking Ahead Listening to the speaker, Cara Locke, Tonya Arnold, Rick Bailey and Nate Bowles, ACTS members, think about what's being said.



Talking It Over Darcey Ross, Donna Bierbrodt, Lynette Henders and Amy McCurry have a discussion about Kayettes.





Hamlin, Laura Winston, Becky Nordine, Lena Slaton, Stephanie Nadolny, Holly Mitchell, Paulette Watson, Brad Palmer, Brooke Hollyfield, Mr. Murdock, bottom row: Tina Hastings, Marcy Medsker, Lori Pommeroy, Brenda Burdick, Stacey Coltharp, Alison Briscoe, Marsha Finney, Michelle Merriman, Jenny Barnhart, Rick Wilson, Amy Richardson, Michelle Bland, Karen McDaniel, Ann Layton, Tonya Bossman.



Kayettes top row, from left to right: Vanessa Bardwell, Jennifer Gossard, Jenni Seger, Amy McCurry, Angela Wishall, Brenda Willard, Ann Jaimez, second row: Donna Bierbrodt, Erin Voelzke, Brenda Corle, Julie Dewey, LeeAnn Hyatt, Keri Glenn, Teresa Wishall, third row: Lisa Herrenbruck, Mindy Allen, Sarah Diel, Darcy Ross, Lynette Henders, Jennifer Beals; Paula Hill, front row: Erin Akard, Melissa Sanders, Stephanie White, Missy Powell, and Annette Jaimez.



Smile! Vicki Dodson, sponsor of Kayettes, pays close attention to what's going on.

The Main Speaker ACTS member, Boyd Hamlin leads the discussion at an ACTS meeting.

Thumbs Up! Senior Kevin Clapp gives his approval to the project.

Hard At Work. Junior Shawn Morris repairs a car at the VoTech in his Auto Body class.



VICA top row left to right: Austin Shute, Mike Murray, Charlie Hernandez, second row: Jim Cudi, Jim Stillwell-advisor, Jim Hartzell, Ron Edwards, third row: Bill Koch, Floyd Sumner, John Workman, Catherine Castorena, Alfred Castorena, fourth row: Norman Traxson, Mike Swigart, John Reeves, Paul Snow, Pat Castorena, front row: Roy Wade, Jerry Davis, Allen Melton, Bobby Vanderford, Darnel Seaton, James Franklin.



Art Club members, back row from left to right: Ms. Demello, Terry Harrah, Brenda Davison, Jeff Hader, David Gilham, middle row: Chris Applebaugh-President, Hershel Shoats, Pete Barndollar, Jamie Roush, front row: Kevin Gregory-Secretary, and Chad Creed-Vice President.



Great Concentration. Showing his talent, Senior Hershel Shoats paints a wall mural during his spare time in Miss Kengle's room.

Learning by watching. Paying close attention to what is going on, Senior Peris Jennings watches carefully.

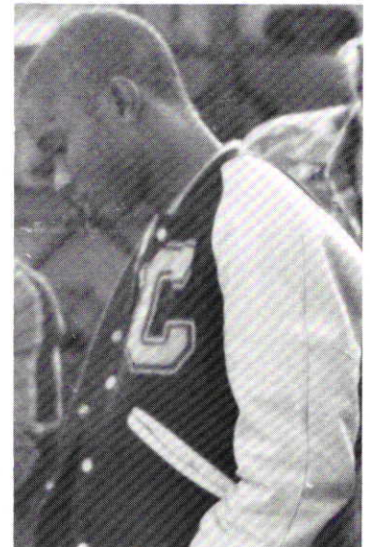

Students Gain Work Experience, Putting Them

A Step Ahead



Just Making Sure. Art student Mike Holler is checking up on recent artwork done by the class to get different ideas for his project.

Art club and VICA students; challenged to use their talents.

Work experience is an ever important tool, useful now and in the future to all students. Art Club and VICA both offer an opportunity to gain that work experience in a wide range of artistic and industrial fields.

VICA (Vocational Industrial Clubs of America) is a club that gives students a chance to improve their industrial skills and compete at local, state and national

contests. Senior Mike Swigart, a first year VICA member, joined the club to improve his skills in auto body and said, "At contests you meet a lot of interesting people in your field. I think that VICA is a good club."

Using their imagination and past experiences, Art Club students have used their talents to benefit themselves and the communi-

ty.

"Art Club tries to advance the students' knowledge of art so that it would benefit them at art school and in a career," says junior Brenda Davison.

By painting at the Downtown Mall in Coffeyville and at the children's ward of the hospital, the students have helped others and gained work experience.

A useful tool in any occupation, the work experience that Art Club and VICA students have gained will help put them a step ahead.

A C A D

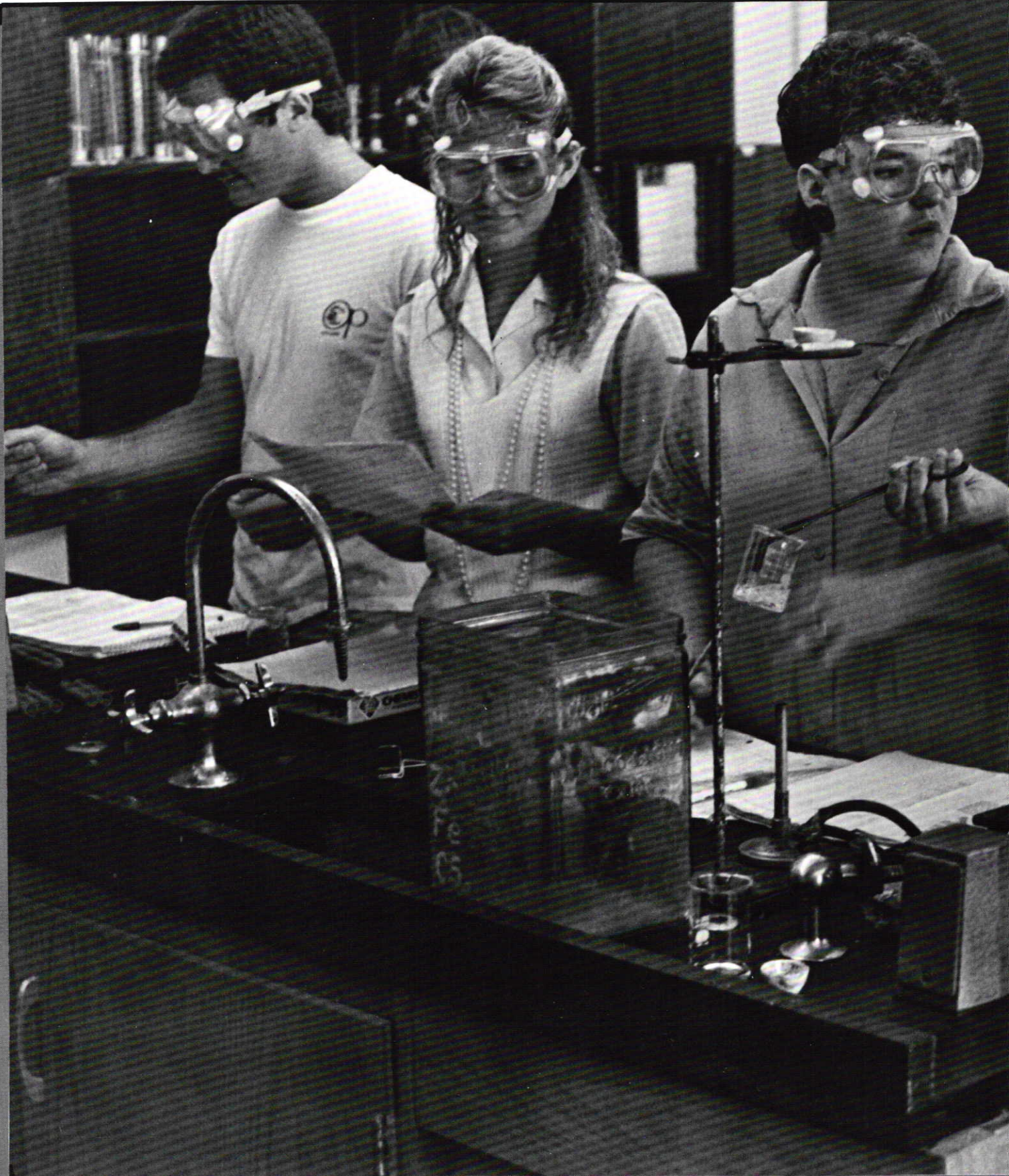

Raising the Standards

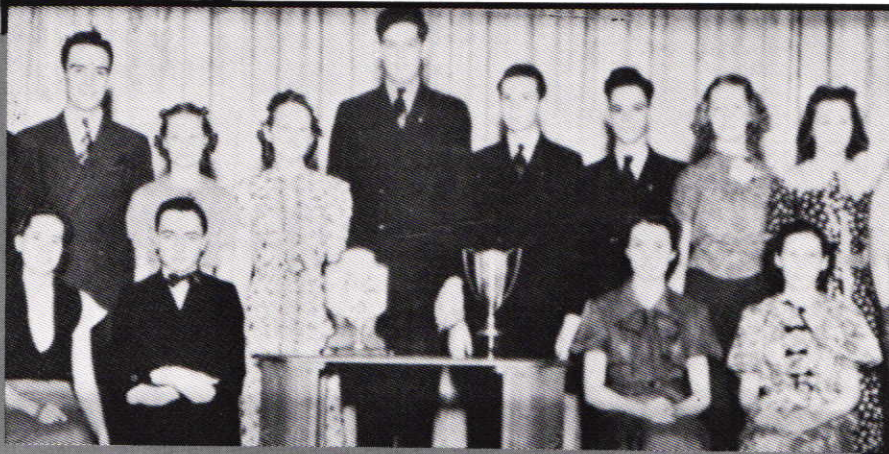

The 1937 Tornado Talkers — The Debate team coached by Clark Hendrix were second only to Newton, the state champions.

As educational reports recommended longer hours should go into the school day, FKHS countered by lenthening the school day. Students took harder classes, thereby taking home more homework each night. Graduation requirements increased to 21 credits, meaning greater amounts of study . . . and headaches. These standards were met and surpassed, pushing FKHS students to the top of the academic ladder.

Increased Science — Graduation requirements increased for the underclassmen, but academics is still fun as shown by junior Todd Gritmaker and sophomores Tereasa Wishall, Julie Bever, and Jody Lynn.

The Basics

As simple as one, two, three
English was taken by everyone



Won't they ever learn?, Senior English Instructor Sue Staudt grades papers during her planning period.

A Slice of History - Seniors Brian Smith and Grady Victory are playing medieval characters as a project in Mrs. Richard's fifth hour English class.

They were the basics, as simple as one, two, three years of English to reach graduation. Three units of English must be completed and passed to get a diploma. Being a sophomore meant taking a semester of both oral and written communication.





How many times do I have to tell you?, Sophomore English Instructor Mike Lee cheerfully teaches one of his classes.

In the junior and senior year, American and English literature are emphasized. Although most English classes went over the fundamentals of grammar, reading, and writing skills, teachers tried not to make English too monotonous.

In Janet Bryant's junior English class they presented sketches or sculptures to the class on the Salem Witch trials and *The Scarlet Letter*. Whatever your grade or level, everyone took one, two, three years of English to graduate.

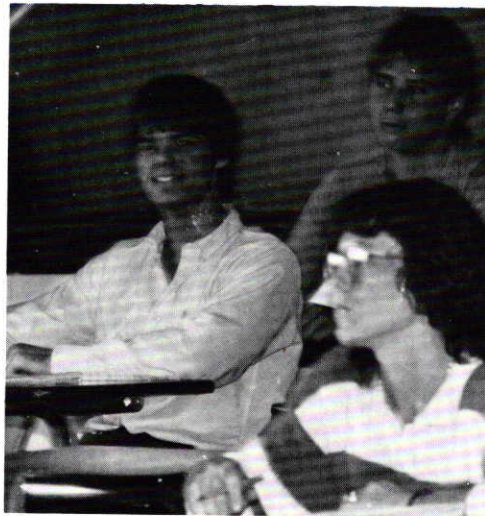

I Wouldn't If I Were You! Jr. Clairborne, Senior, portrays the Vietnam era in Mrs. Richards English class.

A little more than grammar, Seniors Jim Bay, Tom Roberson, and Donna Oakley carefully listen to Mrs. Staudt's instructions while writing compositions in Senior English.



They look so studious! Students in Mrs. Bryant's Junior English class look for information to compile their research papers.

Ready, Set, Think!

gee-whiz business classes
help prepare for the future

You want a career in business ... you think. You want to get some training before you graduate from high school. But the question you ask is, "Where do I get the education?" The answer, ladies and gents, lies in the business classes.

Frequently, people see an opportunity when they take courses that 'narrow' down the choices for the future. That isn't necessarily so. "The students in my classes are interested in how an office runs, but they're not sure this is what they want," said business instructor Larry Murdock. With



Even typing instructors need help from time to time. Here business typing instructor Larry Murdock has one of his typewriters looked over.

Neanderthal typing! Cavemen seniors Shane Elliott and Tim Blevins literally let their heads do their work. Meanwhile, junior Scott Carpenter masters the keyboard the usual way.

Accounting instructor Diana Eikenberry has to help explain problems to her students all the time. Senior Lee Ann Hyatt listens as junior Susan Norfleet realizes she made a mistake.

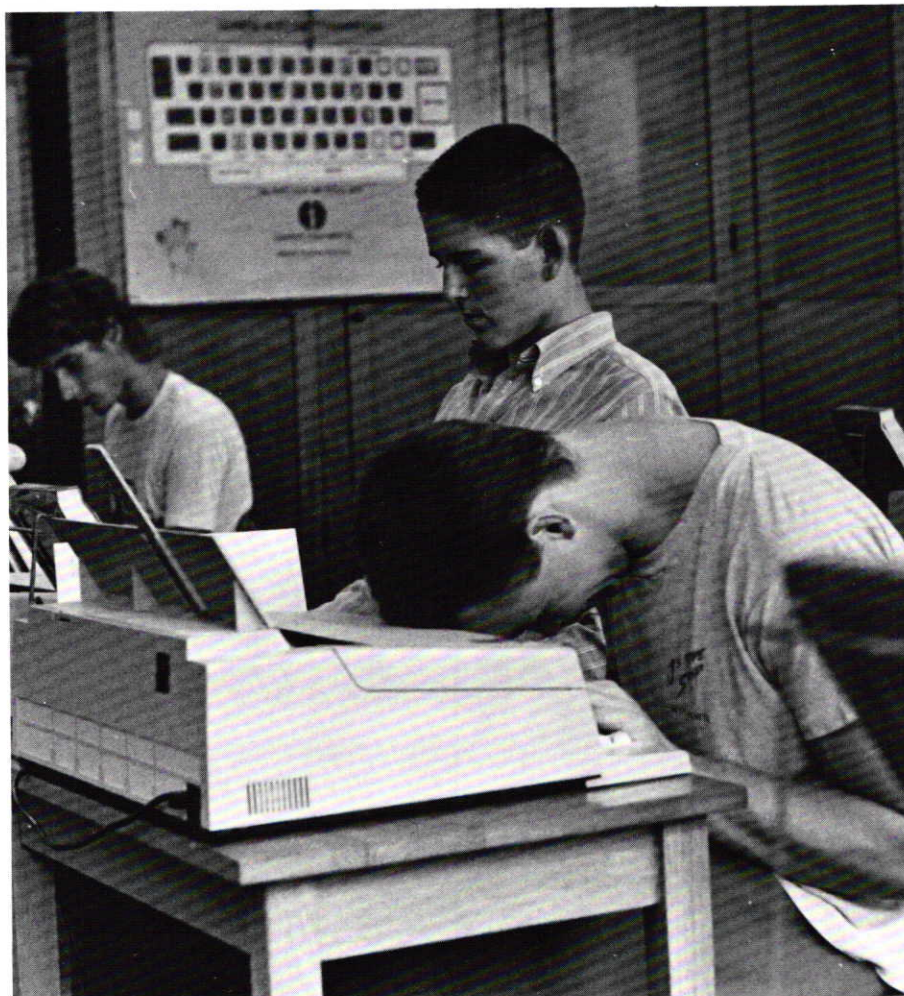

typing, and computers just two of the classes that's offered, students can easily learn the skills they will need in the rapidly-becoming technological workplace of tomorrow.



Business classes teach a wide variety of things, including shorthand and how the office area truly works. Shelly Stewart takes over as secretary.

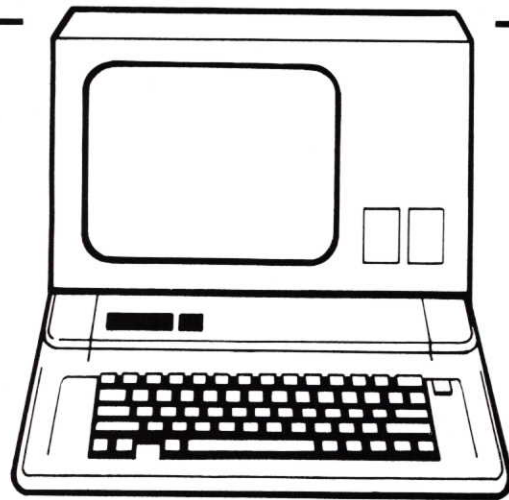

"The half-radius is what?" Drafting students learn the basics in Mr. Bloomcamp's class. Draftsmen Tyrone Burnett, Dustin Garrett, and Jason Harden finish their layouts.

Making sure that everything's perfect, Mike Brown finishes his work one last time in Miss Rupp's typing class.

While many of us don't like working with numbers, accounting instructor Diana Eikenberry and her students work with them on a daily basis. Her classes, like the others, can give students a head start in competition in jobs and a future down the road.

Between typing and shorthand, which stress basic secretarial skills; accounting, which teaches the day-to-day financial activities of business; and computers, which is becoming the office machine of the century; the students of business are earning their diplomas as well as working towards the future.

Original Designs

These days school is more than books, lectures, and tests; our school offers practical skills designed to meet students' everyday needs. Home Economics and Industrial Arts offer everything from wok cookery to blueprinting.

Basic and advanced cooking, fashion, housing, interior design, and child development are all elective courses in the Home-Ec department. Vicki Javernick, owner of "Jean Junction" visited the Fashions in Clothing class

taught by Marie Bumgartner on Sept. 5. Tips on wardrobe planning and color, along with the new fall fashions, were displayed. Javernick said, "By adding a new piece of clothing or adding a new accessory, you can update an entire wardrobe."

One of the favorite activities of the foods classes was "Free Friday". On these days the students could bring the ingredients for whatever they wanted to eat, cook it during classtime, and eat it.

Beginning to advanced drafting

are Industrial Arts electives; starting with drawing lines, up to engineering drawings, it teaches the language of industry. "The main objective of the class is for neatness and accuracy," said instructor Charles Bloomcamp, "the skills used in drafting can be used in other classes."

So it's easy to see, school is more than books and lectures, but teaches skills everyone uses every day.



Sizing Up Jr. Lisa Herrenbrook models a dress that she made in her 4th hour Home Ec. class while Ms. Bumgartner checks the hem.

Deep in thought Junior Doris Harris concentrates on a Latch-hook rug in her fourth hour Home Ec. class.





What's Cookin, Senior Brian Fahler, and Junior Adrian Collins are busy cooking doughnuts in their fourth hour Home Ec. class.

Concentrating deeply, Junior Mike Brown works on a drafting project in Mr. Bloomcamp's Drafting I class.

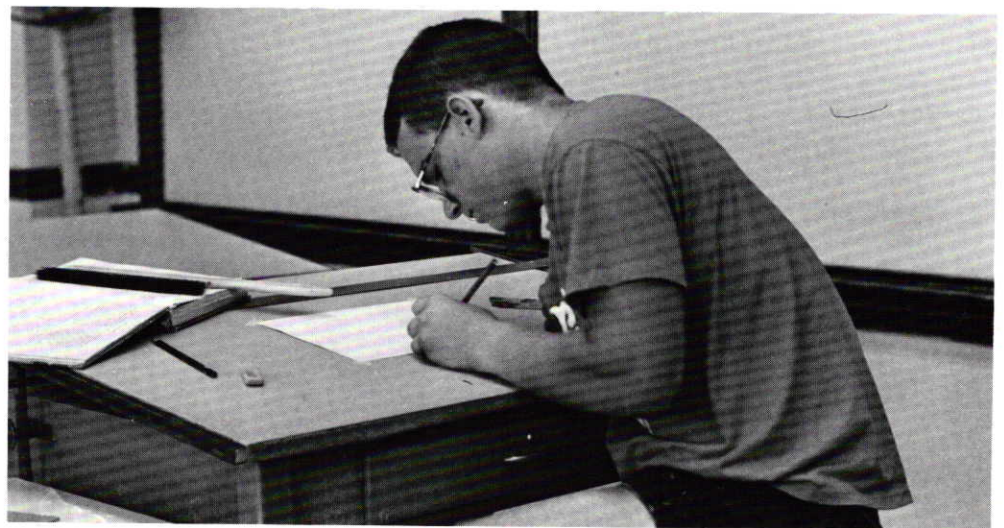

Close is not good enough, Junior Craig Hillman skillfully completes a drafting project.

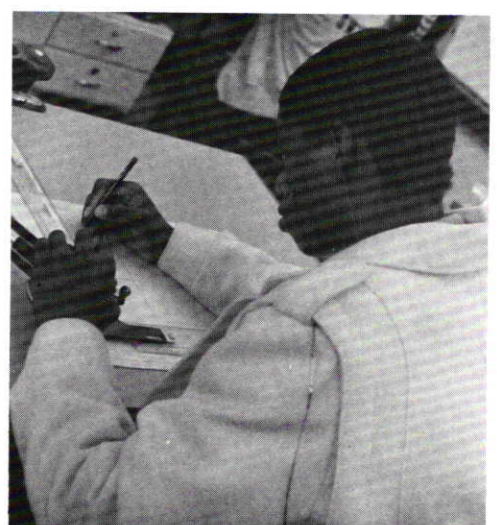

Remember, accuracy is very important, Junior Tyronne Burnett works slowly and carefully so that his drawing will be perfect.

Here's Your Sought-After Invitation To Triumph Or Tragedy

"Uh, Mr. Jones, if a equals c and b equals c , then what does a plus b equal?" A puzzled look clouds the teacher's face as he glances back at the chalkboard.

"That's what I explained before I erased the board," he replies.

"Oh, . . . well,"

First fact of math classes: Pay Attention. With several varieties of math available, it is very easy to get lost quickly. Nobody ever confused their math homework with a snooze.

Many students were blessed with Algebra II this year, with its various rules and theorems. Some less daring took Algebra I; neither are easy classes. When students

answered a school survey on favorite things, math classes were among the least popular.

Still, for those that truly enjoy racking their brains night after night, Calculus I or II is available. Mr. Cauthon would love having more people in those classes. Or perhaps Physics, on second floor with Mr. Bobek, would suit you better.

Fact: There Are Many Classes

And, to review: Math classes, how difficult they may be, can be a triumph — if you're willing to study a lot — or a tragedy — if you don't try to understand. It just depends on how well you remember the facts.

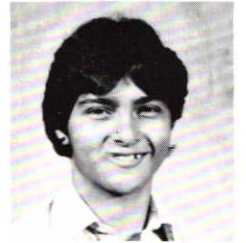

"The hardest thing about Calculus I is . . . that while your brain pops like Jiffy-Pop popcorn in a microwave, Mr. Cauthon tells you it's 'easy stuff'"
Senior Grady Victory

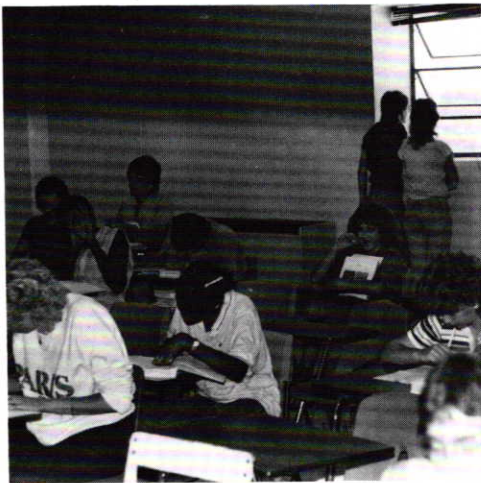

This is hard work! Some students taking time out to rest their minds. Then it is back to work in Mr. Chance's Math class.



While Mr. Jones helps sophomore Heather Gillis, sophomores Cara Locke and Cami Misch are hard at work.

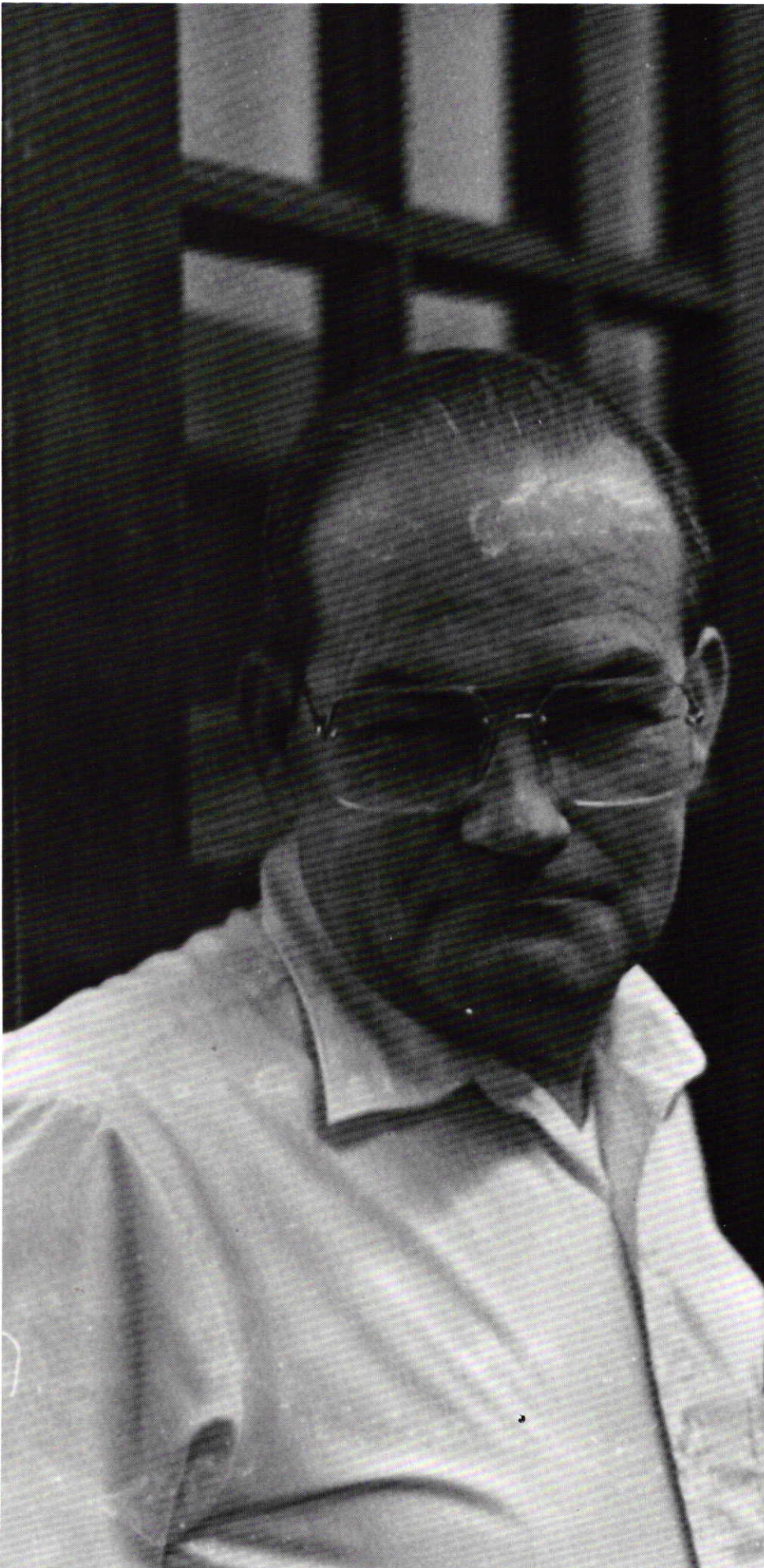

Mr. Cauthon, the brainiac Calculus and Math Instructor gives one of his famous looks his students have learned to fear.

"And this would cancel out when this was divided ..." Algebra teacher Sherman Janes explains the basic laws of the division of numbers with square roots.

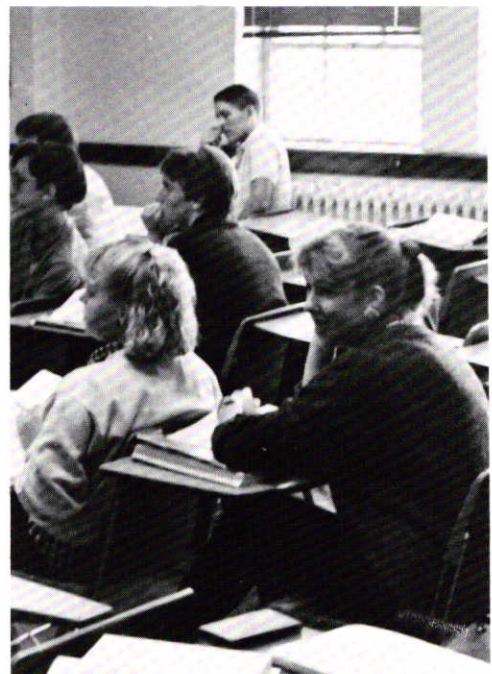
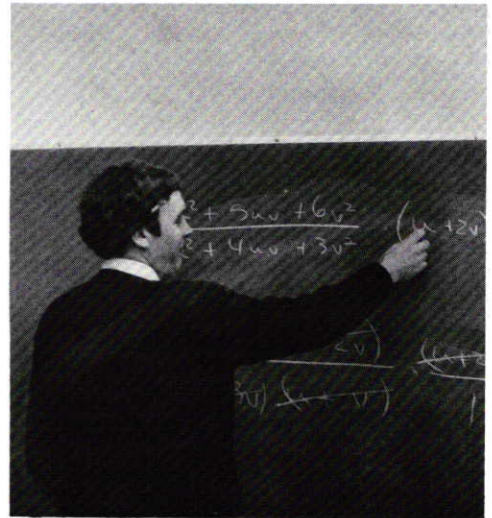

As the rest of the class pays attention earnestly, sophomore Heather Gillis realizes, that she, like many before her, doesn't understand one thing Mr. Jones is talking about.

Sophomore Chad Schenk and his Chemistry I lab partner Stacey Wilkerson test their skills on a lab experiment in Mr. Bobek's 4th hour class.

Mr. Staudt is explaining the lesson to sophomore Susie Garrison, with sophomore Stephanie Nadolny hard at work in the background.



Junior Bobby Vargas is holding a test tube and doesn't know what to do next.

Joe Staudt takes a moment from regular class routine to show his true feelings about his day.

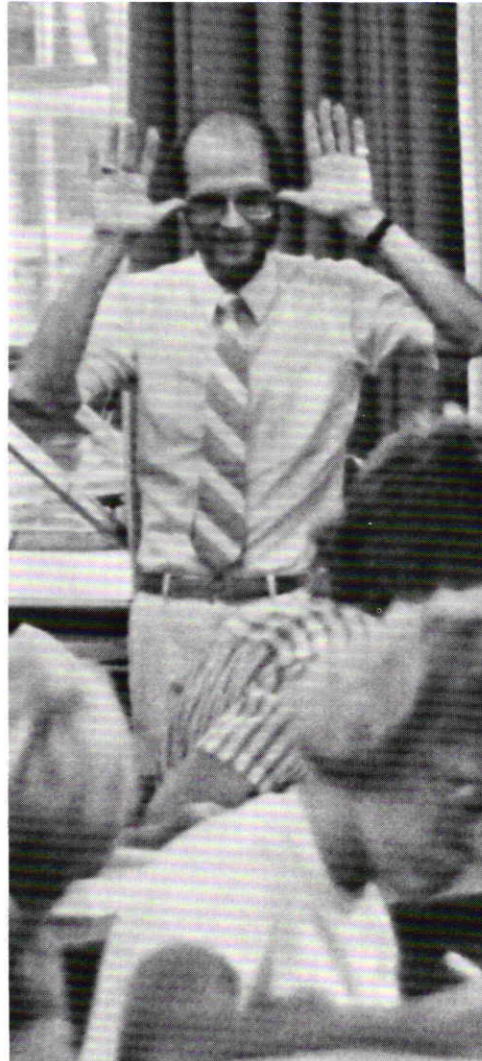

INCREASED STANDARDS & HOMEWORK

Backs straining, arms breaking, students lugged large textbooks out to cars and busses. Taking science meant weekday homework and weekend studying for NADOS.

Carrying heavy books for one year proved hard enough, but the classes of '88 and '89 will carry their books even longer. The graduation requirements are

now two credits for science. Sophomore Vanessa Bardwell says this, "I don't like the new standard for science, because I see no real reason for it unless you're planning to have science in your future career."

Often students opted to take more than the required two years because of its importance. Junior Tammy Storey said, "I like Biol-

ogy. It is interesting and most of the time it's fun. I'm glad that I have the chance to take the class."

Students found that the taking of the extra year of science meant that they would still have the pain of carrying the heavy books along with other daily homework. So cheer up and let's keep those test tubes rolling!



Junior Lance Hill and his lab partner, sophomore Laura Winston conduct an experiment in Chemistry I.

What is it? Junior Todd Gritzmaker is conducting a Chemistry experiment with his lab partner junior Troy Donahey.



Bursting With Laughter Ms. Kengle reads the many rules and regulations to her fourth hour American History class.

Left With Little Time Sophomore Tom Compton hurries to finish his assignment in a few minutes before the bell rings.

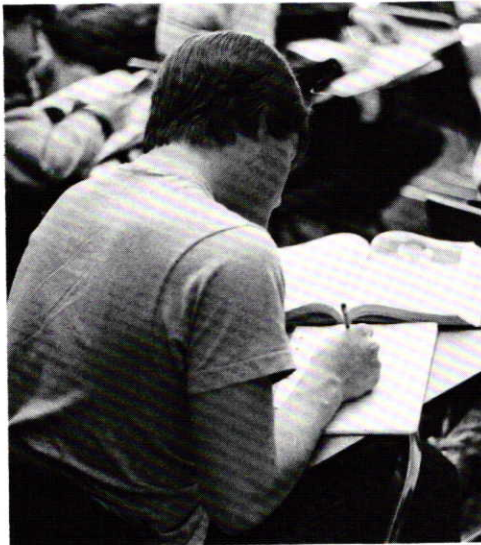

Keeping the Beat Eric Robinett, a lecturer from Coffeyville Community College, performs some African music for the Humanities class. Every Monday a different speaker comes to broaden the students cultural knowledge.





It's Not As Boring As It Looks Ms. Kengle's fourth hour American History class listens intently on their first day of the semester. Just ask Erin.



"I really enjoy my students- and I learn from them!"

Listen To Who's Talking Gathered around Mr. Owen's desk, Senior Bryan Fahler and Junior Shawn Bromley listen to another one of "O's" jokes.



Social Science leads students in

New Directions



Listening Carefully. Students enjoy Eric Robinett's lecture about the different music in Africa and how it affects African social life.

Taking students in new directions, Social Science offers a variety of opportunities that cannot be found anywhere else. From World History to American History it offers students the chance to learn about various countries and cultures. "For their own benefit, I hope the students learn to appreciate the countries that are studied," says Ms. Regan when asked about the goals she has in her World History classes. "The world is getting smaller, When traveling, for business or pleasure, it is good to have a background of the country."

Mr. Owens feels that Social Science is important because, "It is a study of society. Things that are

studied from the past will support our future.

In order to make their Social Science classes more interesting, teachers have brought in outside speakers and politicians. They also held political elections.

"I think that the Social Sciences are important because they give all of us an opportunity to study human behavior and achievements. The more information of this nature that you know and understand," comments Mr. Henry, "the more universal and humane will be your opinions and perspectives." And with those kind of directions you can go anywhere.

Students Join

They're

Flag Corp

Flags- Donna Oakley-captain, Becky Bordine-co-captain, Brenda Willard, Angela Wishall, Jenny Barnhart, Cheryl Lendall, and Cindy Crouch.



Jazz Band

Jazz Band- Becky Bordine, Cheryl Morris, Amanda White, Bruce Pierce, Angie Sjolander, Melissa Hedrick, Brenda Willard, Dickey Henry, Wynette Irving, Carrie Hulse, Susan Garrison, Mike King, Mike Breen, Brian Smith, Teresa Wishall. Not pictured-Tom Roberson.



Flutes

Flutes- Melissa Hedrick, Cheryl Lendall, Donya McFerrin, Ann Layton, Holly Gartner, Lisa Ediger, Jenny Barnhart, Karen Waggoner, Melinda Rider, Gina Rutherford, Janet Bloomcamp, Lartricia McHenry, Brenda Willard, Toni Eden, Angie Sjolander, and Wynette Irving.



Clarinets

Clarinets- Kenny Mitchell, Terri Isnard, Kristie Field, Amy Richardson, Angela Wishall, Jennifer Beals, Kimberly Johnson, Mary Liebert, Carrie Hulse, Troy Donahey, Alicia Jackson, Alison Bristow, Michelle Reynolds, Donna Oakley.



Trumpets

Trumpets- Robin Grewell, Cindy Crouch, Jason Clark, Kelly Cranor, Jr. Clairborne, Terry Martindale, Mike Wilkinson, Carol Runyon, David Coughenour, Mike Breen, Brian Foote, Jeff Lewman.



Band For Love Of Music, Football, And Basketball

Playing Our Songs . . .



Some people listen to the radio, go to rock concerts, or just watch MTV, but for many students, musical enjoyment came from participation in band. Choices include concert, marching, pep, jazz plus flag corps.

Not being able to cheer or sit with friends at football games, marching band members keep the football players going with their peppy music.

On September 27th at 5:00 a.m., the marching band traveled to Lawrence, KS. to attend KU Band Day along with 89 other bands. "It was a fun hot day," remarked Mr. Webster. November 1st the band made its journey to Independence, KS. where they attended the Neewollah Parade and Field Show, there the Marching band received a 2 rating on both their parade and field performance. Flag

Corps performed solo and received a 2 rating also. During the Field performance, marching band received a standing ovation. "It was the best performance ever!", said senior Becky Bordine. On a rainy Saturday, Nov. 8, marching traveled to Missouri Southern State College in Joplin, MO., performing the pre-game show at the Missouri So. vs. Kearny State football game. To show their Christmas spirit marching band marched the Christmas parade on December 6th, here in Coffeyville. Following the parade was the annual Bowl Game.

MTV, concerts and radio fulfilled many people's musical enjoyment. For some FKHS students musical enjoyment came from participating in their own band.

This is the band performing their Field performance at Neewollah, to the song, "This is Love." The band received a 2 rating.

Low Brass



Low Brass/Low Woodwinds- Dickey Henry, Cheryl Morris, Stephanie Martindale, Sheri Miesner, Becky Bordine, Mike King, Brian Smith, Todd Gritsmaker, Patty Wadkens, Craig Creed, Amanda White, Bruce Pierce, Dianne Huneycutt, Cami Misch, JoAnn Byrne, Kwin Bromley, Teresa Wishall, Brett Thomas.

Percussion



Percussion- Don Sykes, Melissa Powell, Karen McDaniel, Tina Bixby, Jill Mashburn, Brock Hanna, Derrick Freeman, Jason Miller, LaDonna Vaughan, Arthur Hodge.

Meanwhile, Back On The Intellectual Ramparts

resolved: that the debate squad
bring home the trophies

Novice debater Darcey Ross reads her negative arguments as fellow debater Mike Taylor looks for evidence for his next speech in a practice debate round.

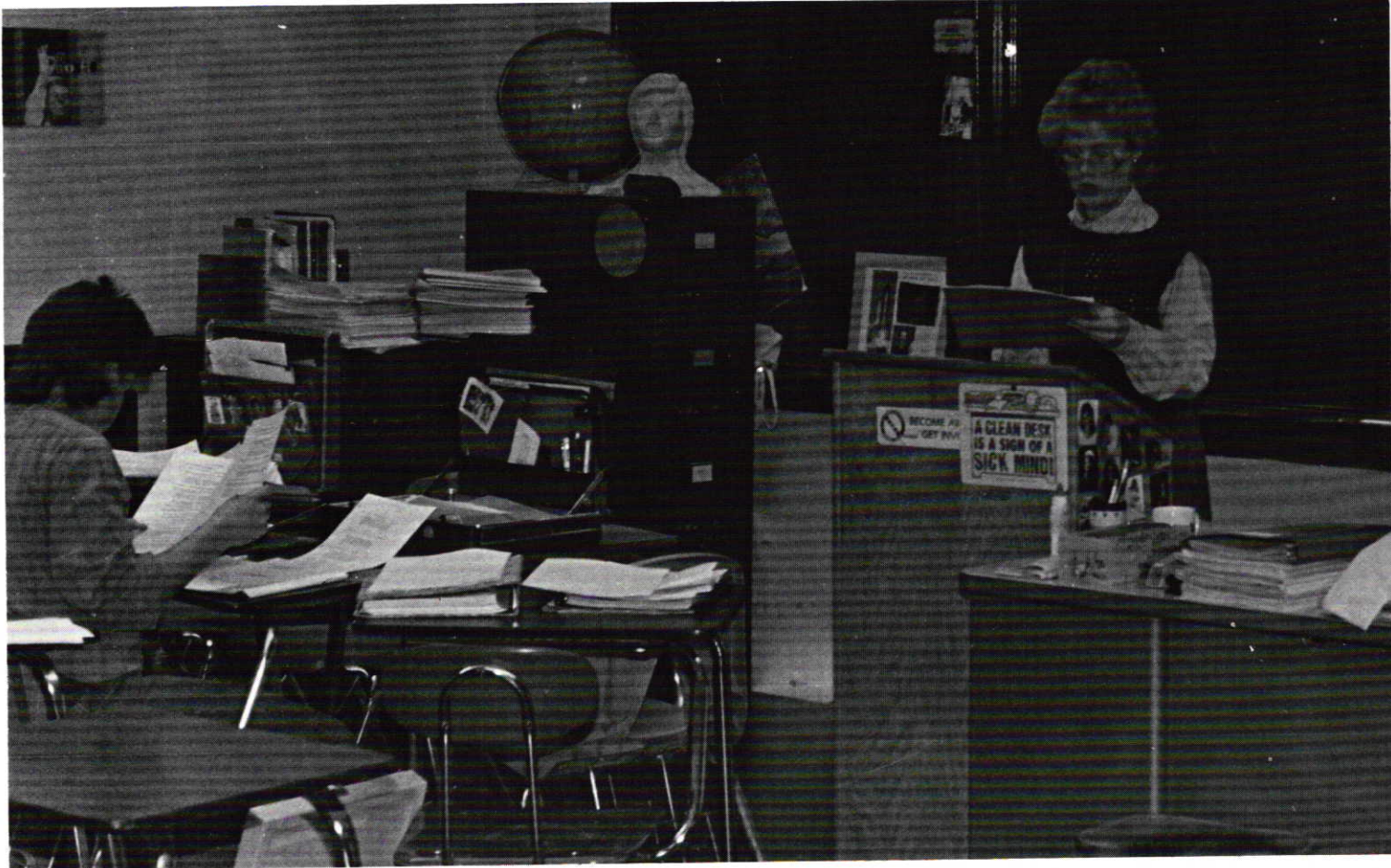

Awards were plentiful this year and some of the trophies pictured above were proof of research well done.

Sophomore debater Bob Murry explains his point of view in a speech on the effects of pesticides in agriculture.

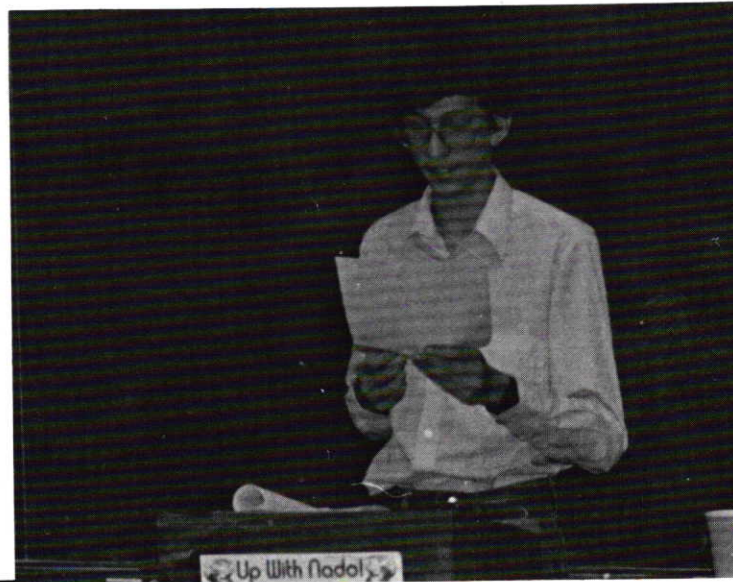

'87 STATE CHAMPS

"Our debaters are state debate champs?!?" Not only does it sound nice, it's also a fact now forever to be set in stone. Since 1964, no FKHS debate squad had ever won at state. Not until now, that is.

"I knew they had the talent and I knew how much they wanted to win, but I felt it still depended on Lady Luck," said novice Brenda Davison. Still, luck was with the squad as six members made it through regionals as runner-up and then went on to take the state trophy.

The championship was just the topper to a simply fantastic season. More awards than ever before were won this year by Darrel Harbaugh's 36 debate squad members. With the help of eight experienced seniors, this year was without a doubt the best in recent years.

Part of the team's success this year was great unity. The same unity that bound the experienced seniors with the novice freshmen. "Even though I was a novice, I still learned a great deal from them," said sophomore Julie Bever.

In the past, debaters had learned that spirit was not associated with them. However, the "we-just-get-put-down-for-it" attitude was gone this year and debating the U.S. Agricultural Policy became a lot easier, despite the put downs. After all, "brain people" aren't supposed to be a part of a team . . . or are they?

But, in the end, one thing became clear: determination, unity, and a little luck along the way were the building blocks of debate . . . and the roadway to a season to remember.

Parents Night in December gave parents of debaters the chance to watch their kids debate; it also gave debate coach Darrel Harbaugh an opportunity to coach a future debater, his son.

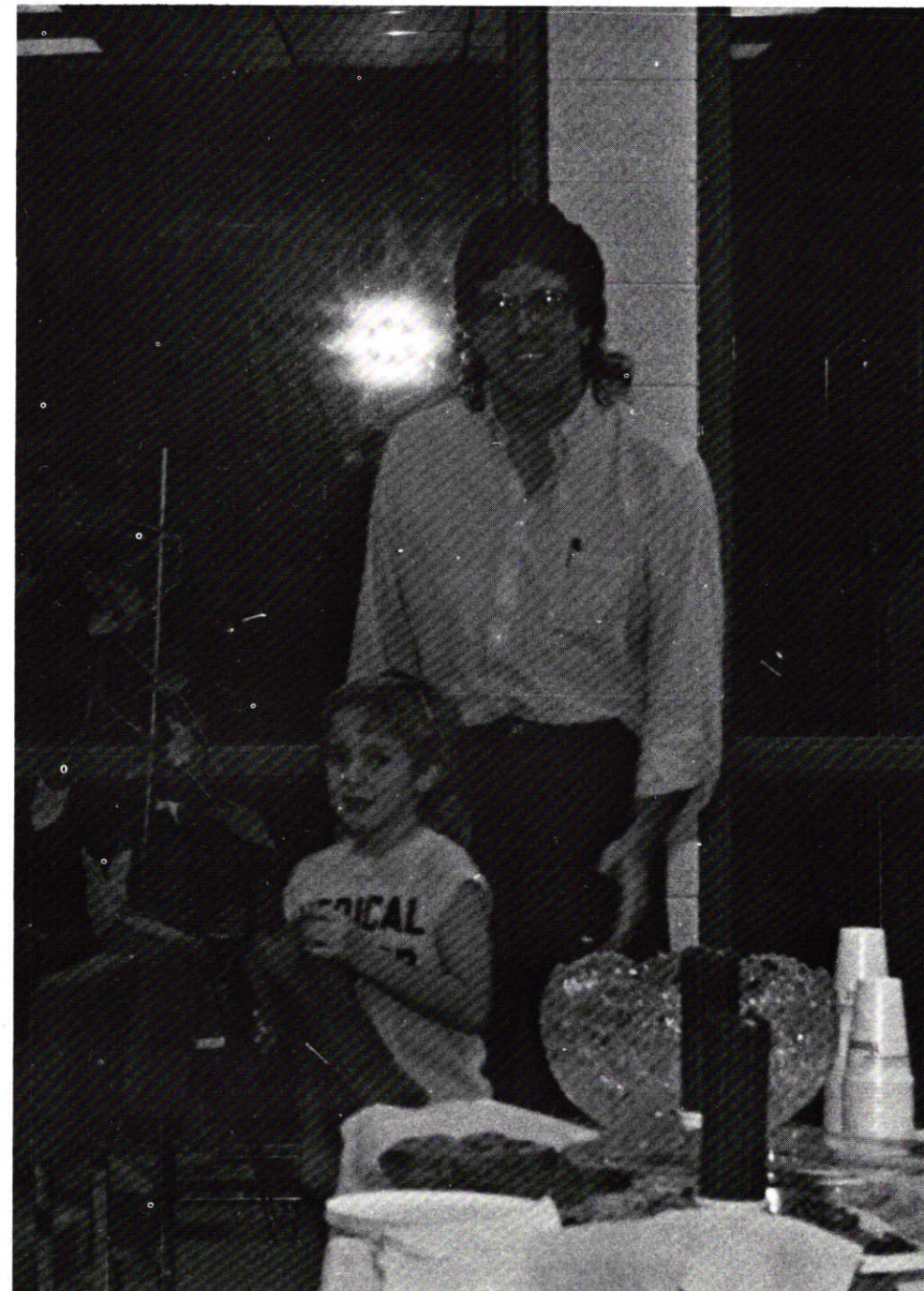

Debate squad, left to right, row one: Paulette Watson, Erin Akard, Cindy Green, Paul Winston, Erik Casebeer, Andy Wilson. Second row: Darcey Ross, Richard Cowan, Grady Victory, Tom Lowrance. Third row: Julie Bever, Vanessa Bardwell, Jennifer

Gossard, Bob Murry, Scott Wells, David Gilham. Fourth row: Brenda Davison, Melanie Robison, Rose Uy, Sarah Diel, Stacey Bishop, Amy McCurry. Fifth Row: Pete Sanford, Sean Roland, Becky Nordin.

It's Not All Books These Days

Vo-tech and Art classes offer 'hands-on' experience & fun

Working with his hands, junior Ron Sjolander investigates the inner workings of the air compressor hose in Auto Mechanics class at the vocational school.



Investigating from the ground up. Auto Mechanics students learn while banging around on the insides of a transmission.

Creativity is the key in Art, as demonstrated by seniors Janet Bloomcamp and Terri Isnard. The Advanced Art classes redecorated the room as a class project.

Auto Body attracts all types. Senior Kevin Clapp and some of his friends take a break from their work — using their mouths instead of their hands for a moment or two.





Naturally talented, senior art student Hershel Shoats shows off some of the talent he has. "The Hershel Collection" was on display in the library in November and at various times in the art room. Hershel hopes to go to art school after graduation, hopefully the Kansas City Art Institute.

Michelangelo earned his great reputation because of the masterpieces he created with his hands. Students crossing Roosevelt Street to the Vo-Tech had classes that differed from those at FKHS because, in these classes, students put down the pencils, pens, and books, and picked up saws, hammers, paintbrushes, and tools, and created their favorite projects with their hands.

Juniors and seniors receive high school credit for Vo-Tech classes if they are taken with regular classes. To receive a vocational certificate a two year program must be completed using three hours of each day.



Ms. DeMello oversees the work of her students as they repaint many of the fixtures and furniture, including her desk.

With intense imagination, art students Todd Childress, Colin Colbert, and Dennis Dewey work on their projects in fourth hour.

Many of the students were involved with Vo-Ag, taught by Kristi Maxson and Dwayne Messner, and Art. Art instructor Ms. DeMello felt lucky to have her added advanced classes this year. Mr. Lowell Beaty and Mr. Jim Tucker, Auto Mechanics teachers, learning meant having students overhauling engines and carburetors. It was the hands that did the work.

School isn't just all books any more. Part of it involves the hands as well as the mind.

The Great Escape

A way to break the typical daily routine.



Push It! Gym teacher Paul Crandel times his students while they run laps in gym class.

Jogging down a white sandy beach, hiking in the mountains, or playing tennis at a resort: the perfect vacation. Although physical education courses did not provide as much relaxation as a vacation, they did allow a break from the day. The class also gave students the opportunity to receive one of the one and a half credit requirements for P.E. necessary to graduate.

Emphasis was placed on individual development in swimming, rhythm and gymnastics, physical conditioning, and regular gym class. Some of the activities are: water safety skills, weight lifting, running, and volleyball.

Gym classes offered a break from academic monotony. The way students looked at it, they needed the relaxation they found in gym class.



I got it! Sophomores Eddie Wilson and Chad Marrow play water basketball with practiced perfection.

Ready Aim . . . Senior Paris Jennings prepares to shoot a basket with expert form.

Jump! Sophomores Marlan Turner, Jim Uleberry, Norma Morgan, Angela Wishall, Marsha Watts, and Junior Scott Wood play an exciting game of volleyball.

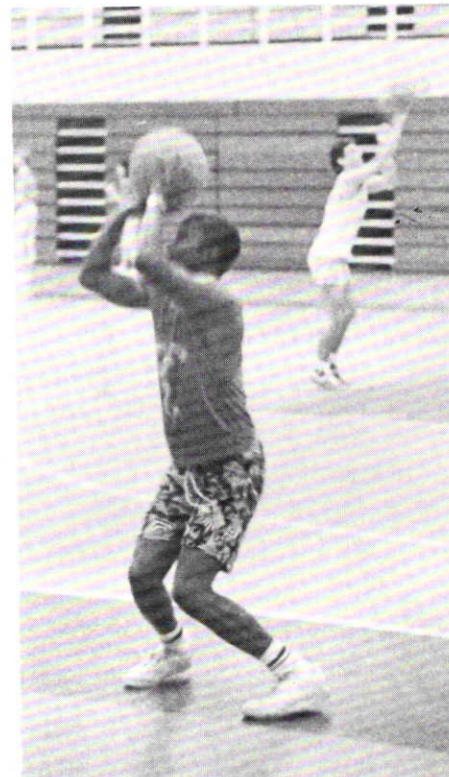

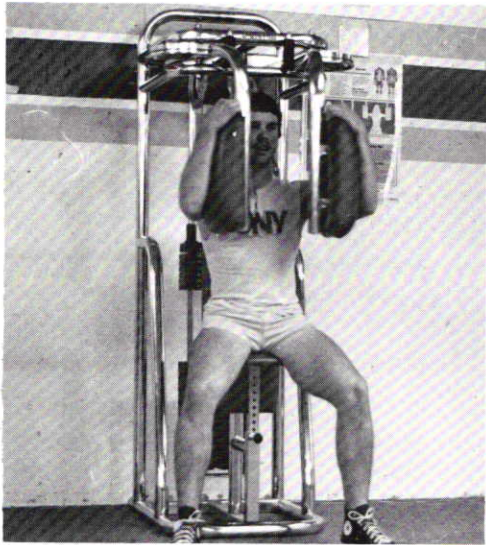

Heads up! Sophomores Tony Eden, Steve Garner, Tim Shultz, Shila Farrar, and Mr. Whalen wait for the next softball to fly by them.

No strain, No gain! Junior Mike Braschler works up a sweat pumping iron in the weight room.

"And the champion Jimmy Ulibarri runs to the finish line and sets a new record." Craig Hillman and Darren Schroeder are there to mark the event.





Standard Equipment



Record Group of 39 Seniors are recognized by National Honor Society in 1937.

People: the same types at every high-school, but here there was something extra. It sparkled at football and basketball games, and gleamed in the halls during Spirit Week. It was the 'Midas Touch' of the people at Field Kindley that made them shine.

Not just another pretty face. Each individual here at Field Kindley has their own inimitable image, but on picture day, junior Chad Hayden was not "just another pretty face."

A

Shining Example

Senior year arrived full of fun, good times, and lots of planning ahead yet to be accomplished. For many, it meant keeping grades up, senior pictures, announcements, graduation, and deciding on which college to attend. But most of all, enjoying friends company became a priority.

"My senior year means that I have finally made it because of all my friends and because it is fun."
— Lorie Brinkman.

"I'm finally at the top. It was

spending a lot of money on pictures, announcements, cap and gown, etc. Other than that, nothing. I feel the same as I did when I was a Freshman." — Darren Schroeder.

"Senior year to me means that it is time to grow up quick and prepare myself for the real world." — Jeff Hader.

"To me, senior year means I have reached the end of a long road and can recall all the good times I've had with my friends."

— Jim Ulibarri.

From sports, dramatics, academics, or just everyday life, the Class of '87 knew they had performed well. The Senior Class had definitely set "a shining example" for the classes yet to pass through the halls of FKHS.

After thirteen years of school, Senior Tom Robertson can not control his enthusiasm about graduation.

Being a true citizen, Senior Neil Owens seems proud to answer questions about 'Piggsville' whenever given the chance.

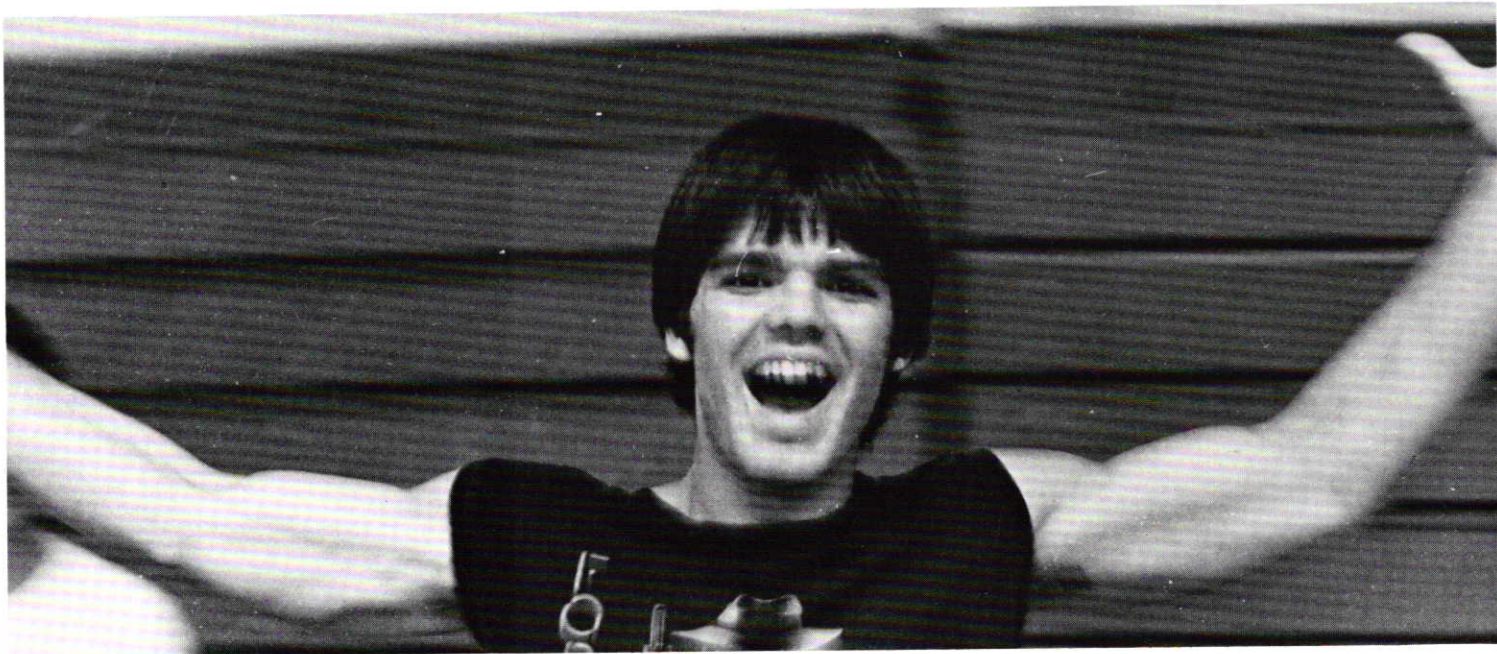

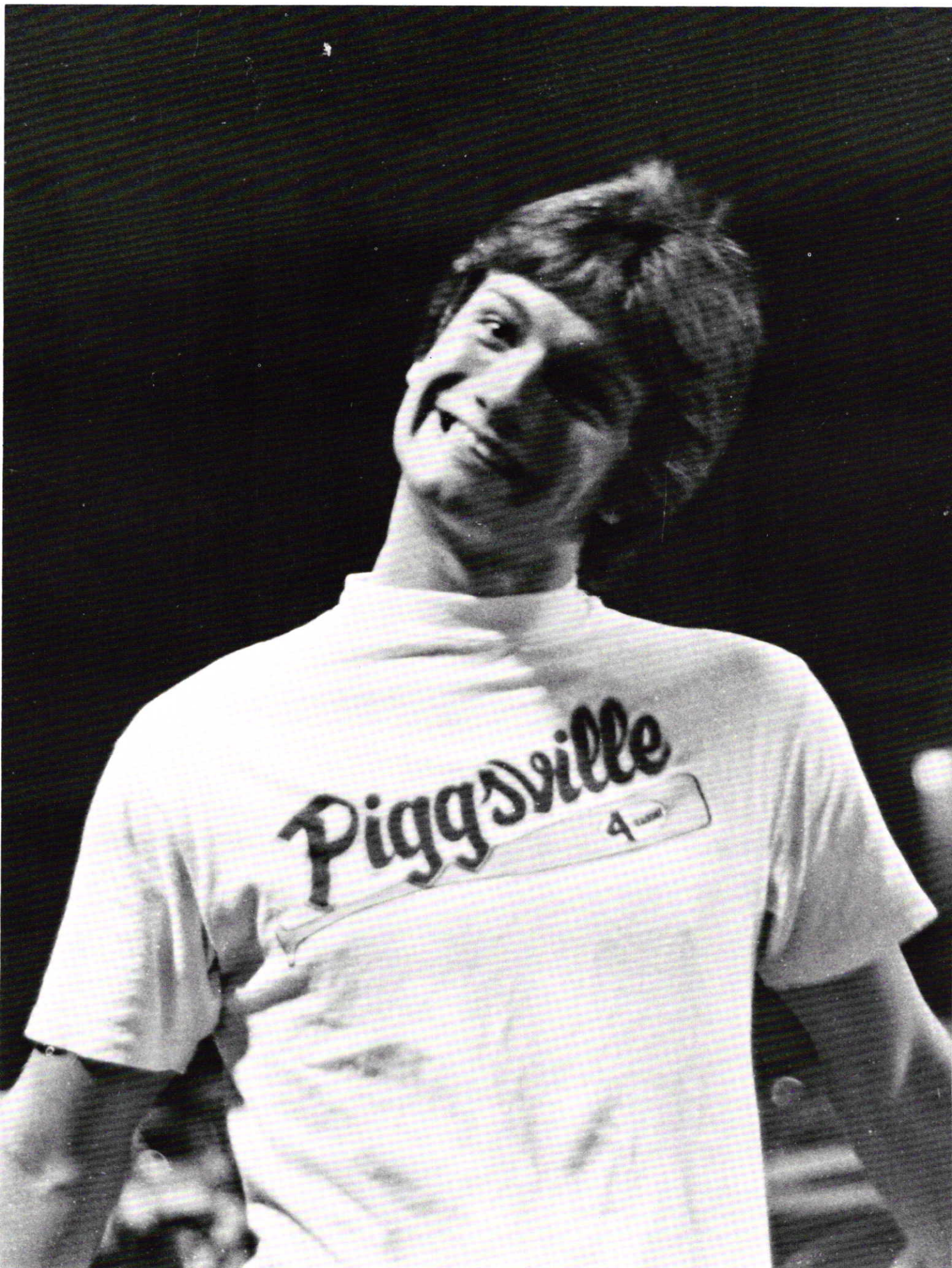

LILE ALEXANDER - Who's Who 4; VICA 4 ... TOLLIE ARNOLD - Track Manager 3; Spirit Squad 1; Stuco 1,2; Who's Who 3,4; Kayettes 2,3; Choir/Chorale 1,2 ... RICHARD BAILEY - Art Club 3; YBTP 4.

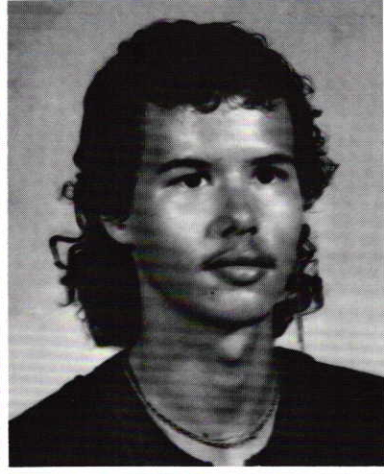
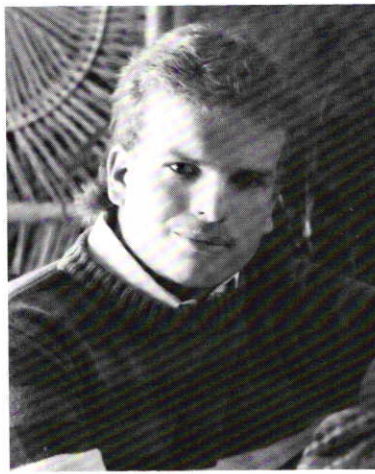

PETE BARNDOLLAR - Who's Who 4; Band 1; French Club 4; Art Club 1,2,3,4; Tornado Times 3,4 ... JENNY BARNHART - National Honor Society 3; Who's Who 4; Band 1,2,3,4; Spanish Club 1; Kayettes 2; Acts 3,4; Yearbook 3 ... DAVID BELL.

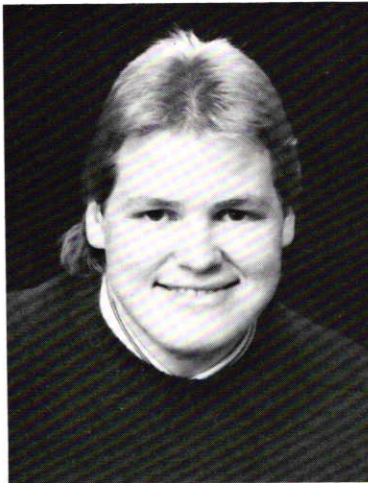

S E N I O R S

Looking To The Future

As graduation approaches, Seniors begin to think about their future. There are endless possibilities and countless questions that enter the minds of Seniors as they think about going out and making a life for themselves.

In a survey, these answers completed the statement: "In the future, I look forward to . . ." — "Living on my own and making my own decisions"—Lori Bryant, — "Creating my own enterprise, and rise to new heights as a small business owner—T.C. Carter.

Money and freedom sound really appealing to most Seniors thinking about the future, but Seniors found that choices become plans and their dreams realities.



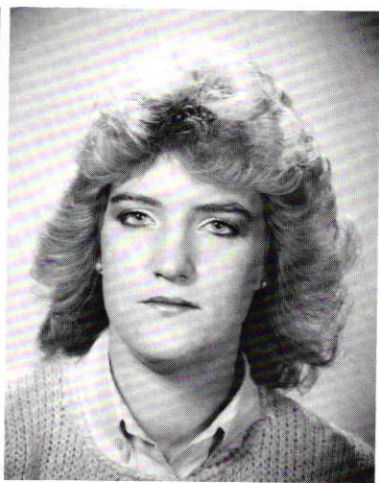
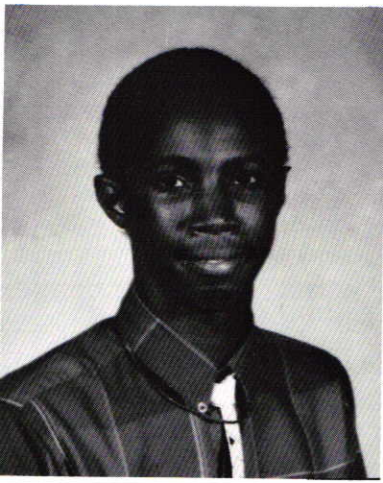

GREG BELL - Debate 1
 ... DEBBIE BENNING - Girls
 Tennis 1,2,3,4; Who's Who 3;
 Spanish Club 2; Kayettes 1;
 Choir 1,2; Chorale 3,4
 ... KENI KAY BENNING -
 Band 1,2,3; FFA 2,3; FHA 4.

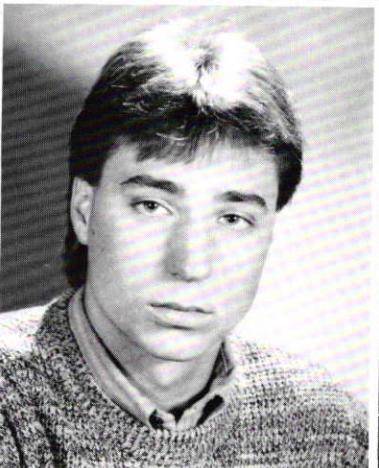
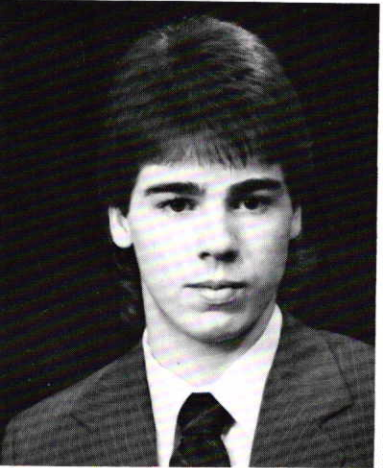

STEVE BERKSTRESSER -
 Who's Who 3,4; Art Club 3;
 Breakfast Club 1,2,3,4 ... STEVE
 BLAICH - Track 1,2,3,4;
 Breakfast Club 2,3; Athletic
 Club 4 ... SUSAN BLAIR -
 National Honor Society 3,4;
 Who's Who 3,4; French Club
 1,2,3.

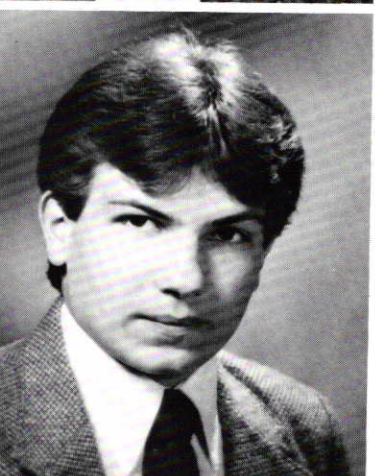
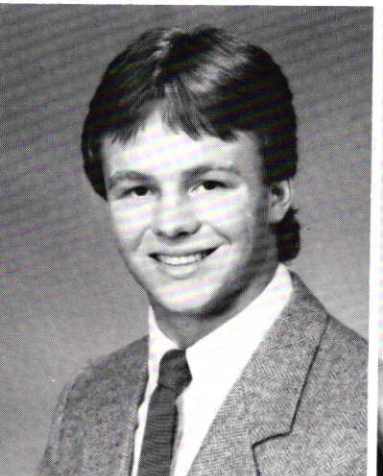

TIM BLEVINS - Football 1,2,3,4;
 Baseball 1,2,3,4; National Honor
 Society 3,4; Athletic Club 4
 ... JANET BLOOMCAMP -
 Spirit Squad 1,2; Band 1,2,3,4;
 French Club 4; Rodeo Club 2,3
 ... JIMMY BLOOMCAMP -
 Football Student Trainer 1,2,3,4;
 Boy's Basketball Student Trainer
 1,2,3,4.

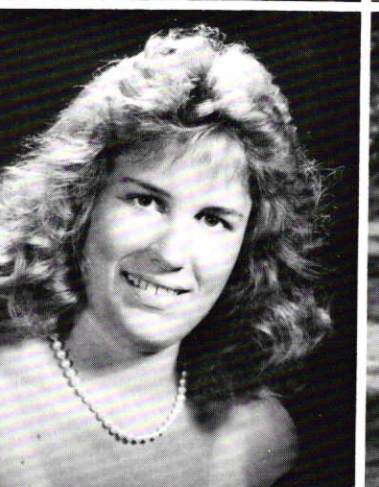

KRISTIE BOHR - National
 Honor Society 3,4; Who's Who
 3,4; French Club 1,2,3; Choir 1
 ... BECKY BORDINE - Band
 1,2,3,4; Who's Who 4; Spanish
 Club 1,2,3; Twister Staff 3,4;
 Jazz Band 3,4 ... STEVE
 BOSSMAN - Choir 1,2; Chorale
 3,4.

Times You'll Never Forget



Walking through the Commons area, you spot the person you like just as you trip over a empty Pepsi can ...or was it your own feet? As you felt the whole school watching, you could have died, but now you look back and laugh. Through the years SENIORS found themselves caught in a number of mishaps that they had yet to live down. In a recent survey SENIORS responded with the following answers when finishing the statement, "I nearly died when ..." — "I fractured my ankle on the 3rd day of Basketball practice." Darren Schroeder. — "I put a popcorn kernal in Darren Buckner's ear and it got stuck." Tara Walton. — "I fell in front of everybody during the Almost Anything Goes." Lisa Maritt. — "The school cracked down with D.R.'s." Dennis Dewey. SENIORS looked back on these past events and got a good laugh.

S E N I O R S

LESLI BOWLES - Volleyball 1,2;
Girls Basketball 1,2; Stuco 4;
National Honor Society 3;
Kayettes 2 ... KERI BOWMAN
- Girls Tennis 1,2,3,4; Track 1;
Stuco 4; National Honor Society
3; Kayettes 2 ... MIKE BREEN -
National Honor Society 3;
Who's Who 4; Band 1,2,3,4; Acts
4; Pep Band 2,3,4; Jazz Band
2,3,4.



LORIE BRINKMAN - National
Honor Society 3,4; Who's Who
3,4; Spanish Club 1,2; Kayettes
2,3,4 ... KWIN BROMLEY -
Football 1,2,3,4; Track 1,2,3,4;
Band 1,2,3,4; Key Club 2
... ALLEN BROWN - FFA 1.

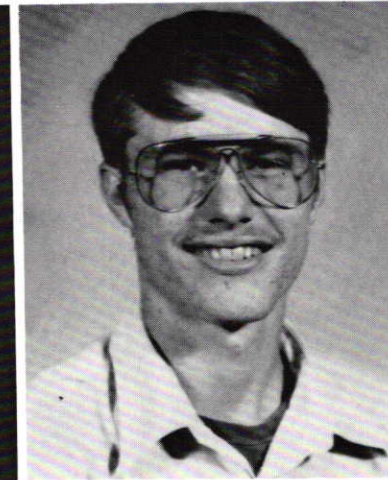
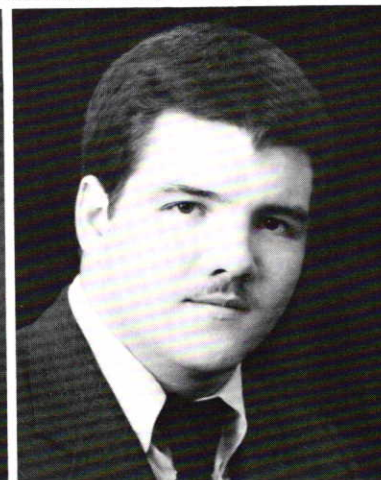

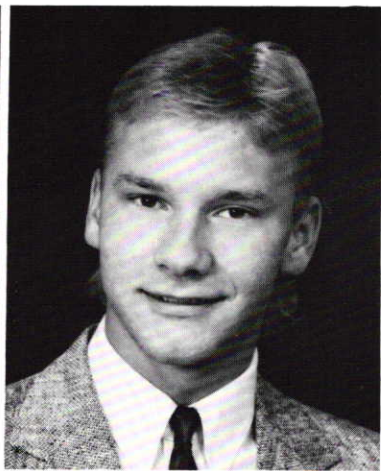

LORI BRYANT - Girls Basketball 1,2; Track 1; Who's Who 4; Band 1; FHA 1; Athletic Club 4 . . . DARREN BUCKNER - Boys Swimming 1,2,3,4; Boys Tennis 1,2,3,4; Stuco 1,2,3,4; National Honor Society 3,4; Who's Who 4; Band 1; French Club 3,4; Breakfast Club 2,3,4; Key Club 2; Athletic Club 4 . . . ANGELA BULLARD - Volleyball 1; Spirit Squad 1; Stuco 1,2; Kayettes 2.

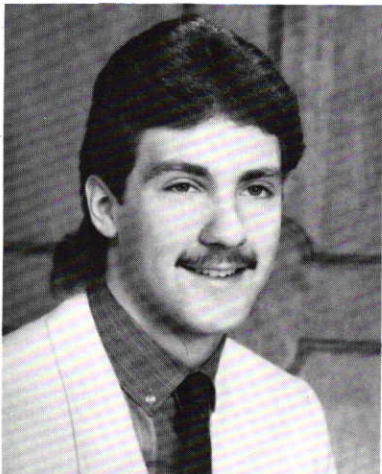

LORI BURDICK - Volleyball 1,2,3,4; Girls Basketball 1,2; Track 1,2; Stuco 1,2,3,4; Who's Who 3,4; 4-H 1,2; Athletic Club 4 . . . RHONDA BURGHART - Volleyball 1,2,3; Kayettes 2; Acts 3,4 . . . NEAL CARPENTER - Football 2; Boys Basketball 1,2,3,4; National Honor Society 3,4; Who's Who 4; Theater 2,4.

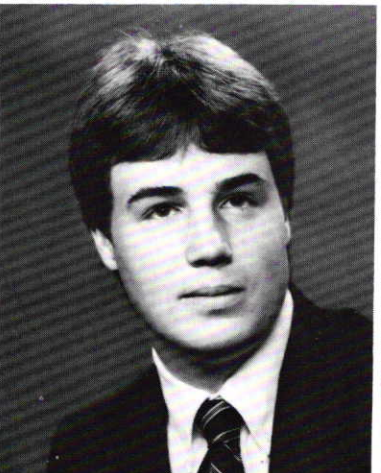
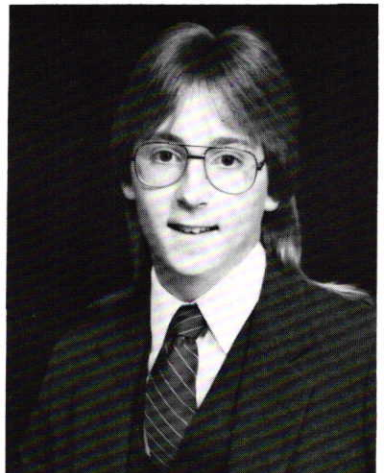

T.C. CARTER - Cross Country 2; Boys Swimming 2,3,4; Golf 1,2; Girls Swimming Manager 3; Band 1,2,3,4; Forensics/Debate/Demolay 1,2,3,4 . . . ERIK CASEBEER - Who's Who 4; Spanish Club 1,2,3,4; Debate/Forensics 2,3,4 . . . LAURA CASTRO.

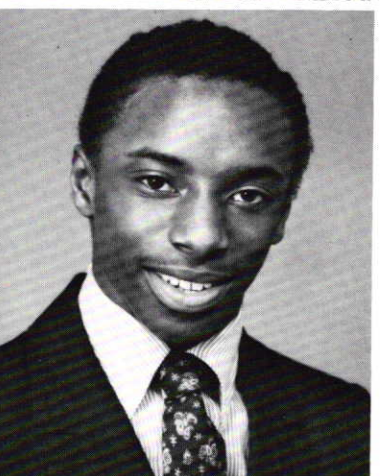
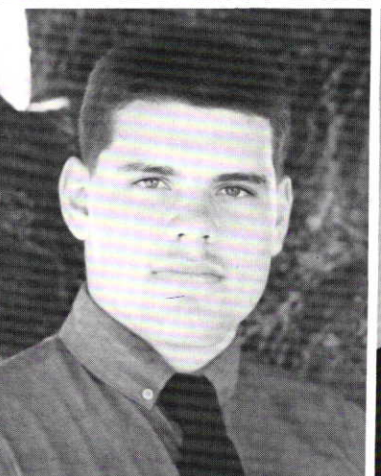

KRISTI CHAFFIN - Spirit Squad 1,2,3,4; Who's Who 3,4; French Club 2,3,4; Kayettes 4; Athletic Club 4; Key Club 2,3 . . . TODD CHILDRESS - Football 1,2,3,4; Wrestling 1,2; Track 1,2,3,4; Key Club 2,3,4; Breakfast Club 2,3,4 . . . JR. CLAIRBORNE - Football 1,2,3,4; Wrestling 1,2,3,4; Track 1,2; Stuco 1,2,3,4; National Honor Society 4; Who's Who 4; Band 1,2,3,4.

KEVIN CLAPP - Football 4;
 Wrestling 1; Athletic Club 4
 ... RAYMOND COFFEY -
 Track 2; FFA 1,4 ... COLIN
 COLBERT - Football 1,2,3,4;
 Boys Basketball 1,2,3,4; Track 1.

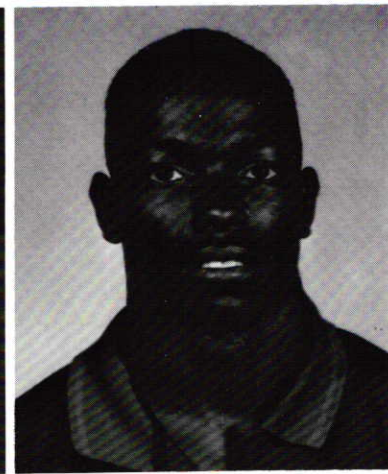
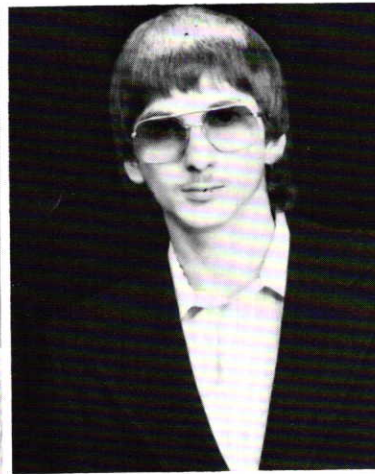
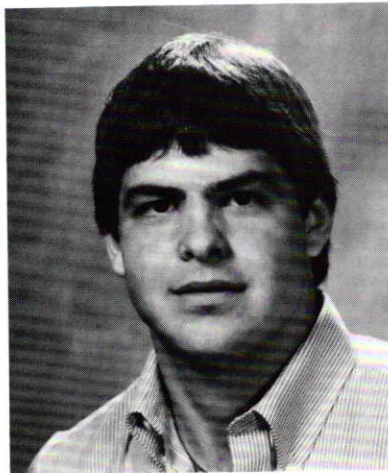

LISA CONGER - Volleyball 1;
 Spirit Squad 2,3; National
 Honor Society 3,4; Band 1,2;
 Spanish Club 1; Kayettes 3
 ... BRENDA CORLE - Track 1;
 Band 1,2; Kayettes 1,4; Athletic
 Club 4 ... MATT COX.

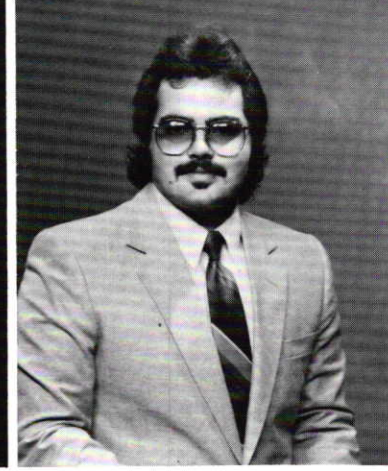

CHADD CREED - Spanish
 Club 1; Art Club 3,4; VICA 4;
 Choir/chorale 1,2,3,4 ... RICKY
 DAVIS ... DARREN
 DEENIHAN.

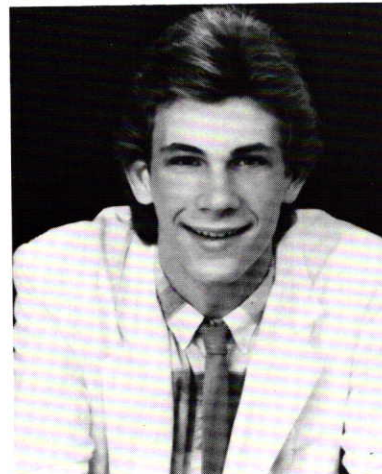

DENNIS DEWEY ... GORDON
 DICKSON - FFA 1,2 ... CARL
 DOWNING - Football 1; Track
 1,2,4

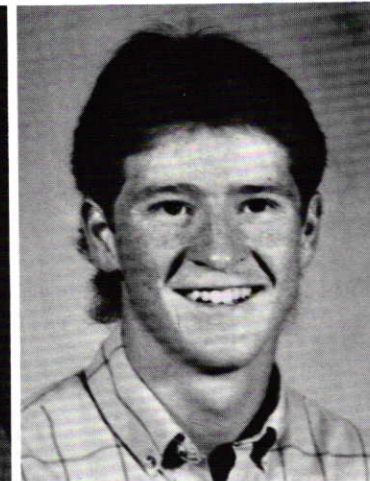
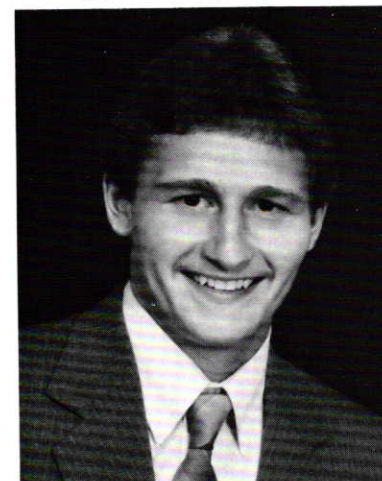

My Greatest Responsibility . . .

A hollow feeling in the stomach and a quiver in the voice: it could have been a case of nerves, but it was merely the effect of a first job interview. As students went through their SENIOR year, finding a job became a top priority, along with many other responsibilities. In a recent survey, SENIORS answered this question, "My greatest responsibility as a SENIOR is?" Their answers included: — "Having to face reality." Matt Locke. — "To take my stand for Jesus, and holding it." Boyd Hamlin. — "Finishing this year with a minor case of senioritis." Debbie Pippin. The class of '87 found many different responsibilities facing them, but the biggest one remained, just surviving their SENIOR year.



S E N I O R S



PENNIE DURHAM - Spirit Squad 1,2,4; National Honor Society 3,4; Who's Who 3,4; FFA 1,2,3,4; Rodeo Club 1,2,3,4 . . . TAMMY EDEN - Band 1,2,3,4; Spanish Club 1; Kayettes 2; Acts 3,4 . . . LISA EDIGER - National Honor Society 3,4; Who's Who 4; Band 1,2,3,4; Acts 3,4.

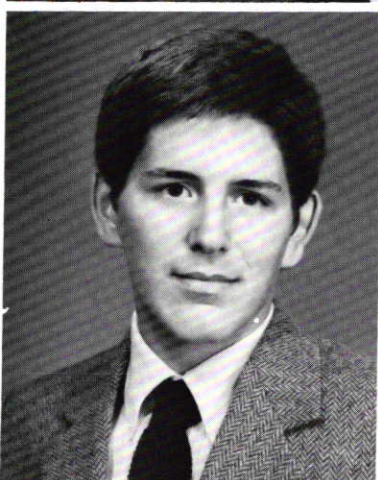

LORI EHART - Spanish Club 1; Kayettes 2,3,4 . . . SHANE ELLIOTT - Football 1,4; Golf 1,2,3,4; Who's Who 2,3; Band 1; Breakfast Club 1,2 . . . JENNIFER ERICKSON - Track 1; Spirit Squad 1,2,3,4; Who's Who 4; French Club 3,4; Band 1,2,3; Kayettes 2; Athletic Club 4.

RHONDA ERNE - National Honor Society 3, 4; Who's Who 3,4; FFA 1,2,3,4; Acts 3,4; 4-H 1,2,3,4 ... MARCI EVANS-LOMBE - Volleyball 1,2; Track 1; Band 1,2; Kayettes 3,4 ... BRYAN FAHLER - Baseball 3,4.

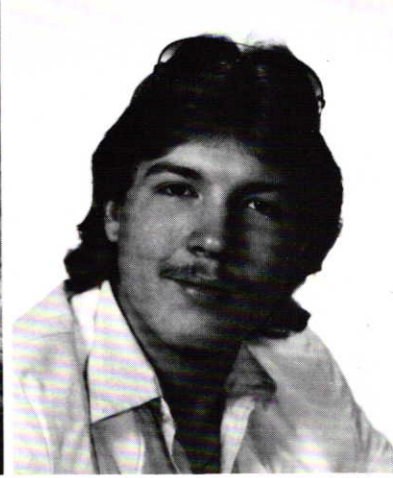

JESSICA FERGUSON - FHA 2,3; Pep Club 1 ... CHRIS FINK - Football 1; Golf 3,4; Wrestling 1,2,3,4; Track 1; National Honor Society 4; Who's Who 4; French Club 3,4; Breakfast Club 2,3,4; Key Club 2,3; Owen's Pep Club 4 ... MARSHA FINNEY - Who's Who 3; Kayettes 2,3; Acts 4; Choir 1,2,3, 4.

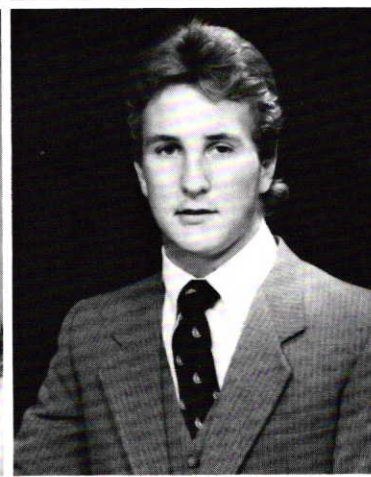
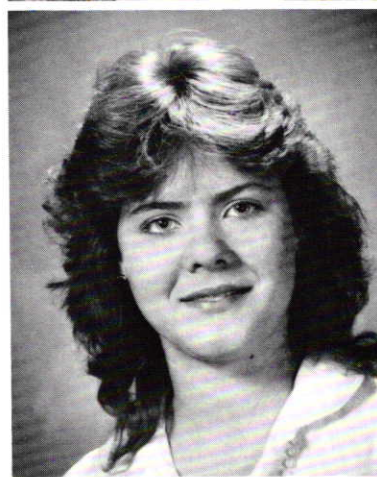

SANDRA FOSS - Band 1,2; Kayettes 1,3,4; Chorale 3 ... GINA FOUTS - Kayettes 2,3,4 ... JAMES FRANKLIN - Football 1,2,3,4; Baseball 3.

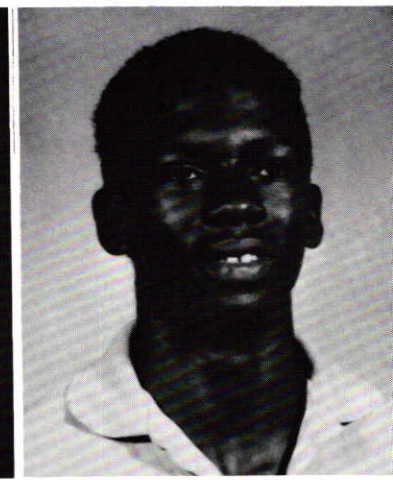

DUSTIN GARRETT - Football 1; Track 1; VICA 4; Choir 1 ... DENISE GATO - FFA 2; Rodeo Club 2,3 ... MARY GILFILLAN - FHA 3; Rodeo Club 2.

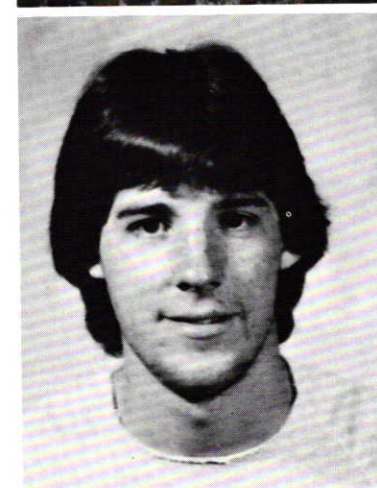



Pick A College Any College

As the year progressed, Seniors began thinking past graduation toward college. Seniors have many questions about college such as: Should I go? and Where should I go?

In a survey, Seniors selected the college of their choice. The top five colleges chosen were:

- Coffeyville Community Junior College
- Pittsburg State University
- Kansas University
- Kansas State University
- Wichita State University

There are many reasons students pick the college that they do. Usually because of reputation, size, etc. Whatever the reason, Seniors decided that picking a college close to home was important.

S E N I O R S

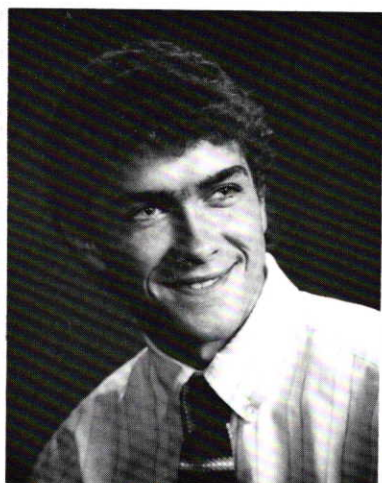
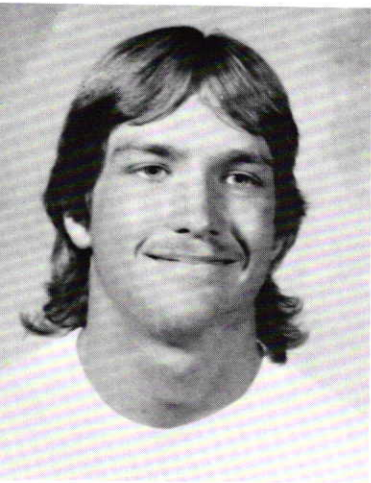

JEFF GILLMAN - Band 1; FFA 1,2 . . . STEPHEN GILLMORE - Football 1; Cross Country 2,3; Track 1,2,3,4; Acts 4; Choir 1,2; Chorale 3,4 . . . KIM GORDON - Track 1; Spirit Squad 1,2; Band 1; Kayettes 2.

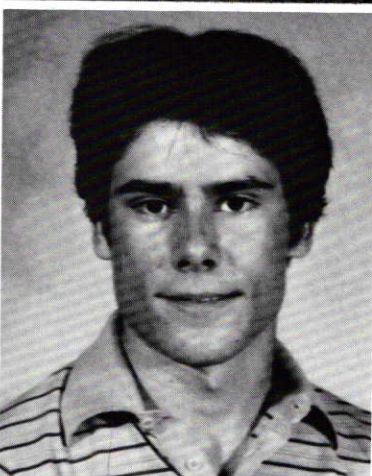
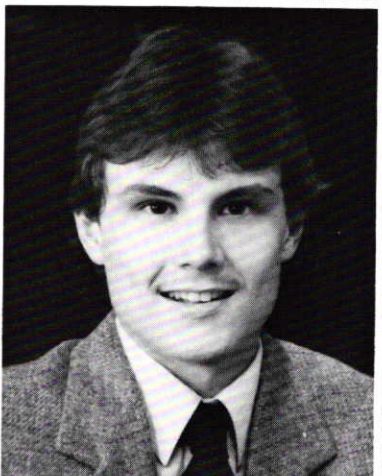

CINTHIA GREEN - Track 1; Spirit Squad 2; National Honor Society 3,4; Who's Who 3,4; French Club 2; Debate/Forensics 1,2,3,4 . . . SCOTT GRIFFIN - Breakfast Club 1,2,3,4 . . . DANNY GRIGG.

"I'll Never Forget When . . ."

Although embarrassing moments made time stand still for the Class of '87, time seemed to fly when Seniors had fun. Good times with friends outweighed the bad. Seniors answered the question, "I will never forget when . . ."

-Kim, Kristi, Becky, Tosha, Rhonda, and I sang 'Kill, Kill, Kill Your Turkey'." — Lori Pomrenke.

-"Steve Blaich wore my mother's nightgown." — Shelly Ortolani.

-Chad McMurray was on his hands and knees barking at Debbie Pippin's Dog." — David Kiser.

-"I made a mini-bomb on Halloween and blew it up on Lisa Moraine's porch." — Lisa Polk.

-"When Michelle sent a birthday card to a guy and signed my name to it." — Jenny Barnhart.

Good times outnumbered embarrassing moments, while memories with friends topped the charts.



S E N I O R S

JENNIFER GROH - Volleyball 4; Girls Basketball 1,2; Track 1,2; FFA 1,2,3; Athletic Club 4
 . . . MICHELLE GUTBERLET - Spirit Squad 1; Kayettes 4; Rodeo Club 2,3 . . . JEFF HADER - Who's Who 4; Spanish Club 1,2; Art Club 3,4.

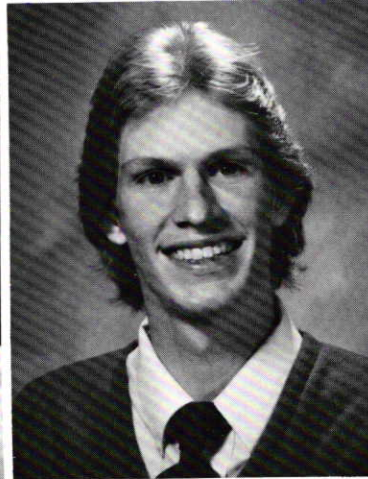

ROBERT HALL - Boys Basketball 4 . . . MARK HALLUM - Football 1,2; Golf 1,2,3,4; Wrestling 1,2, 3,4; Key Club 2; Breakfast Club 1,2,3,4
 . . . BOYD HAMLIN - Boys Basketball 1; Track 1; Acts 3,4; Choir 1,2; Chorale 3,4.

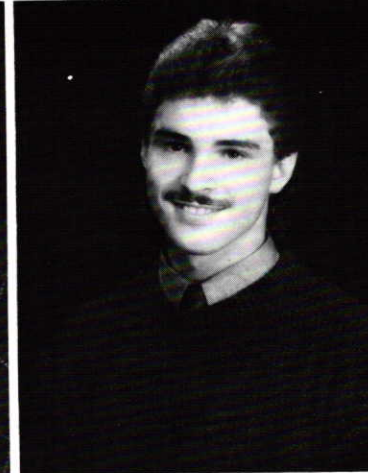
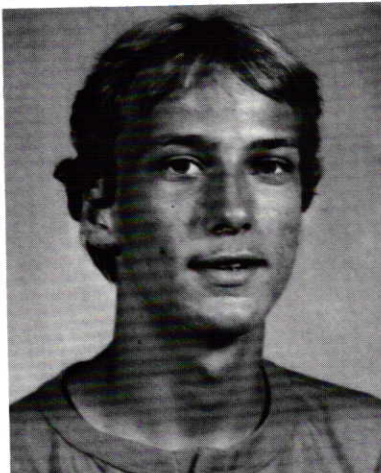

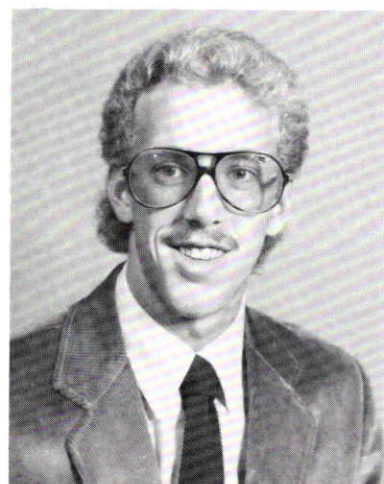

DAN HAMRICK - Football 1;
Boys Basketball 1,2,3,4; Golf
1,2,3,4; FFA 3,4 ... MARK
HARRIS - Who's Who 4; Band
1,2; Spanish Club 1
... SHARON HARRIS - FHA 3;
YBTP 3; JTPA 4.

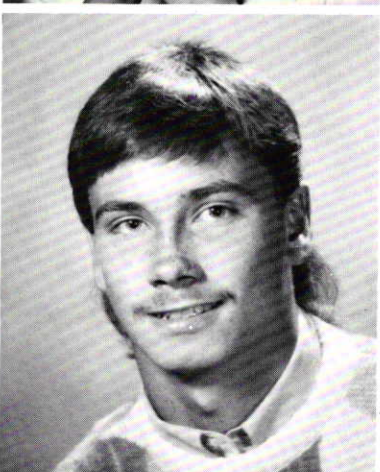
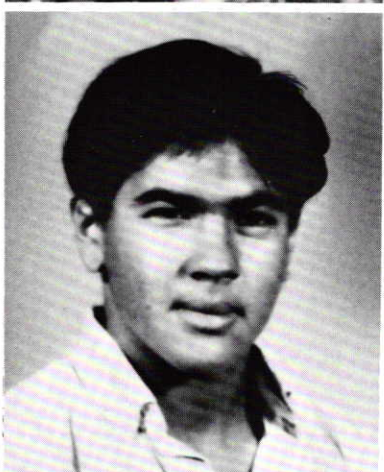

JANIE HARTWIG - Cross
Country 2,3,4; Volleyball 1;
Girls Basketball 1,2; Track
1,2,3,4; Forensics 1,2,3,4;
National Honor Society 3,4;
French Club 3,4; National
Forensics League 1,2,3,4; Debate
1,2,3 ... PABLO HERNANDEZ
- Boys Swimming 3,4; Track 3,4
... DOUG HITCHCOCK -
Football 1,2,3,4; Wrestling 1;
Track 1,2,3,4; Who's Who 4;
French Club 3,4; Athletic Club
4.

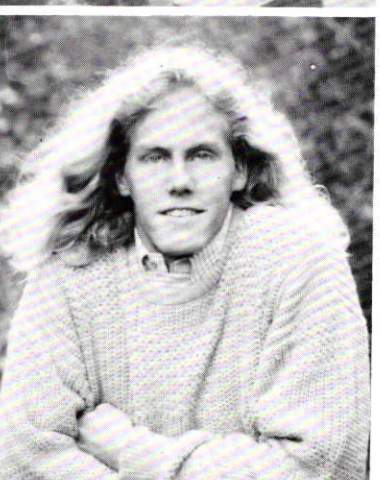

ANNETTE HOFF - Who's Who
4; Spanish Club 1,2 ... DAVID
HOGGATT ... TED
HOWARTER - Cross Country 1;
Boys Swimming 2,3,4; Boys
Tennis 1; French Club 3,4.

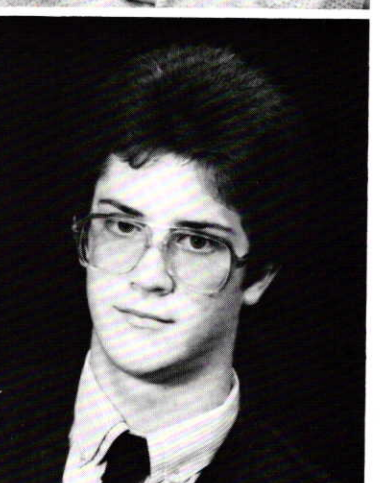
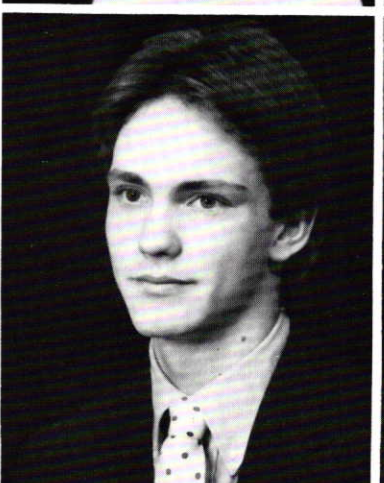
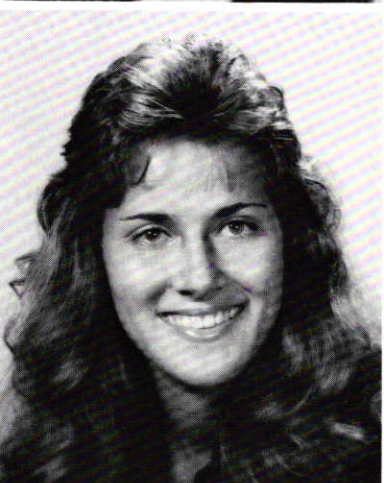

TOSHA HOY - Cross Country
1,2,3,4; Girls Basketball 1,2;
Track 1,2,3,4; National Honor
Society 3,4; Who's Who 4; Key
Club 2,3; French Club 4;
Athletic Club 4
... STEVE HUNT - Football 1;
Cross Country 2; Track 1,2,3,4;
National Honor Society 3,4;
Band 1; Forensics 2,3,4; NFL
1,2,3,4; Debate 1,2,3,4
... ROGER HURST - Football 1;
Cross Country 2,3; Track 1;
Who's Who 3.

RICHARD HUTCHINSON
 ...LEEANN HYATT - National
 Honor Society 3,4; Who's Who
 4; Spanish Club 1; Kayettes
 2,3,4; Acts 3 ... TERRI ISNARD
 - Band 1,2,3,4; Spanish Club 1;
 Art Club 2,3,4.

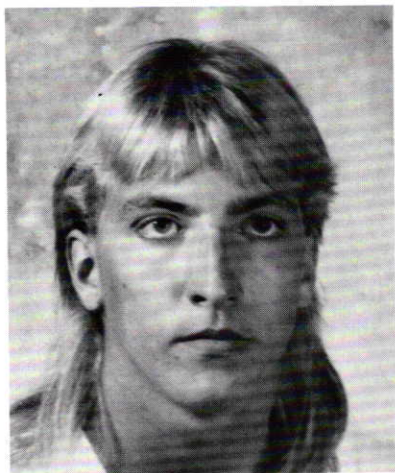

ALICIA JACKSON - Girls
 Basketball 1,3; Spirit Squad 1;
 Band 1,2,3,4; Kayettes; Chorale
 3,4; Track Manager 2 ... ROSS
 JAMISON ... PARRIS
 JENNINGS - Football 1,2,3,4;
 Boys Basketball 1,2; Track
 1,2,3,4.

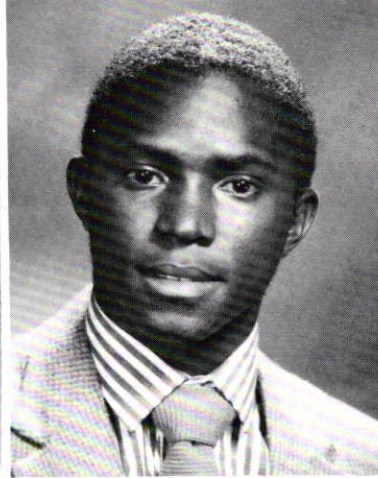
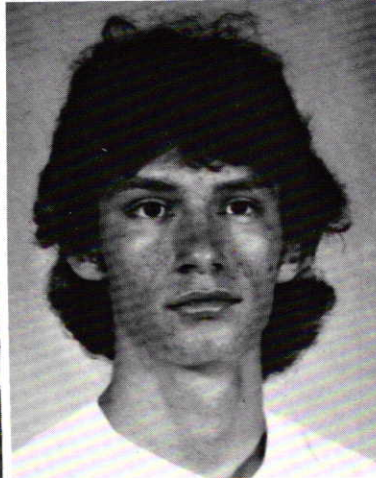

S E N I O R S



Get Crazy

When the books seemed thicker and time began to drag, Seniors' thoughts slowly drifted to the upcoming weekend. When the bell rang at 3:00 p.m. on Friday, Seniors left in different directions in order to start the weekend. In a survey, Seniors gave their idea of a great weekend, including: -"One that lasts a long time."- Matt Locke. -"Any weekend when there's a party so everybody can be together."-Jennifer Groh. -"Sleep."-Dustin Garrett. -"Being with your friends and that special person in your life." -Tonya Merrill. -"Going to Grand Lake and tubing all weekend."-Chris Riley.

On Monday morning, the alarm rang too loudly and too soon. For FKHS Seniors, the only thing that kept them going was the thought of the next weekend being only four days away.

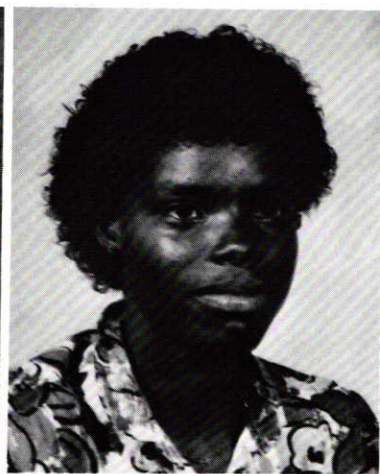

KIM JOHNSON . . . LATISHA JOHNSON - Volleyball 1,2,3; Girls Basketball 1,2,3,4; Track 1,2,3,4; Spirit Squad 2,4; Kayettes 2,3; Choir 4 . . . VIRGINIA JONES - FHA 2,3.

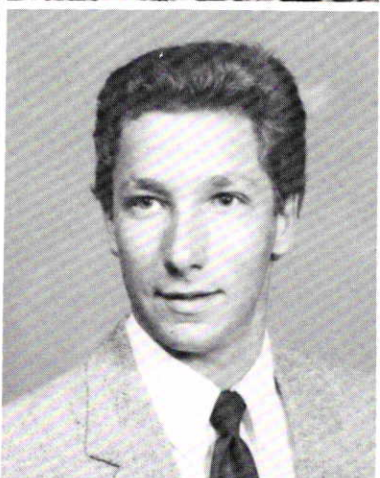
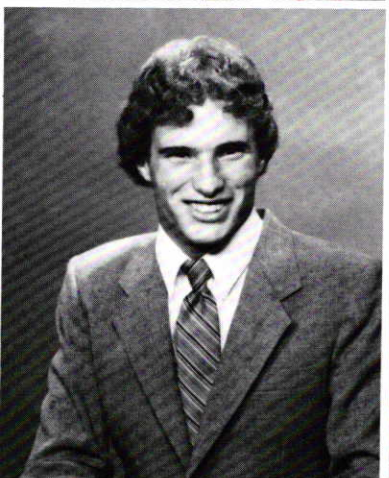

MIKE KASTLER - Wrestling 1 . . . DAVID KISER - Track 3; Band 1,2; FFA 1,2,3,4; Breakfast Club 1,2,3,4 . . . CURTIS KNIGHT - FFA 1,2,3,4.

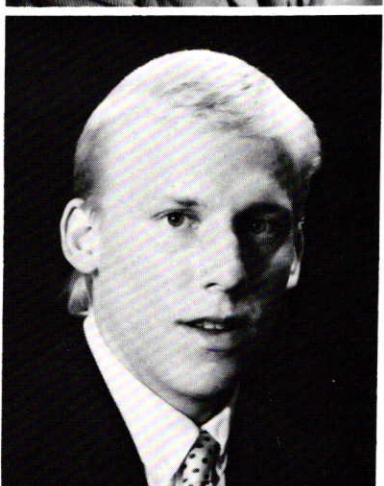
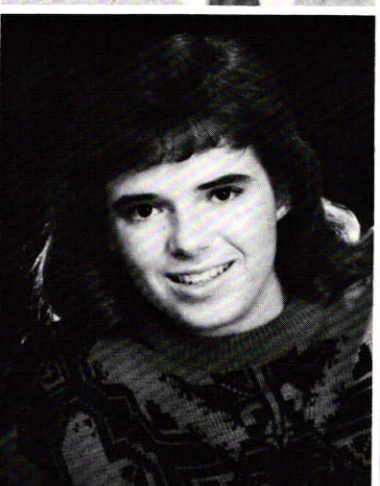

CHERYL LENDALL - National Honor Society 3,4; Who's Who 3; Band 1,3,4; French Club 1,2,3,4; Acts 4; Flag Corp 4 . . . JONI LITTLE - Track 1; Spirit Squad 1,2,3,4; Drama 1,2; Athletic Supporter Club 4; National Honor Society 3,4; Who's Who 2,3,4; French Club 3,4; Kayettes 2,3; Key Club 3 . . . MATT LOCKE - Football 1,2,3,4; Golf 1,2,3,4; Who's Who 3,4; Breakfast Club 1,2,3,4.

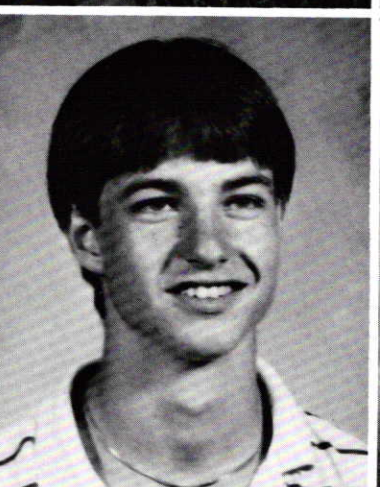

JENNIFER LOGAN - Track 2,3,4; Who's Who 4; Kayettes 2; Acts 3,4; Tornado Times 3,4; Yearbook 1 . . . JIM LONG - Who's Who 1,2,3,4; Band 1,2,3; French Club 1,2,4; Parking Lot Gang 1,2,3,4 . . . TOM LOWRANCE - Spanish Club 3; Debate 1,2,3,4; Forensics 2.

GAYLA MALONE - National Honor Society 4; Band 1,2,4; Kayettes 2,3; Drum Corps 3; Yearbook 4 . . . TABITHA MALOTTE - Spanish Club 1; Yearbook 4 . . . MATT MANLEY - French Club 2; Art Club 3,4; Parking Lot Club 2,3,4.

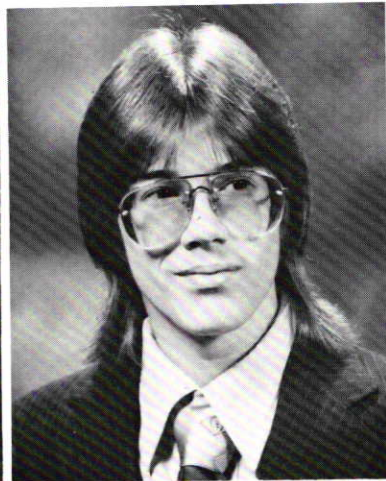
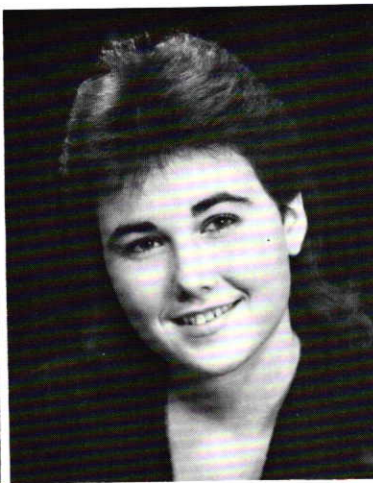

SUSAN MAPLES - Kayettes 4; Rodeo Club 2,3 . . . LISA MARITT - National Honor Society 3,4; Who's Who 4; Band 1,2; French Club 4; Kayettes 2; Tornado Times 3,4 . . . KATHY MARTIN.



REGINA MARTIN - Track 1,2,3,4; Spirit Squad 2,3,4 . . . RAMONA MATTHEWS - Girls Basketball 2,3,4; Who's Who 3; FHA 3; Choir 2 . . . JON MAYO - FFA 1,2,3,4; Breakfast Club 2,3,4.



CORI MCGARVEY . . . RENE MCKELLIPS - Spirit Squad 1; French Club 1; Kayettes 2,3; Acts 3,4 . . . CHAD MCMURRAY - Wrestling 3,4; Boys Tennis 1; FFA 1; FHA 4; Breakfast Club 4; Athletic Club 4.

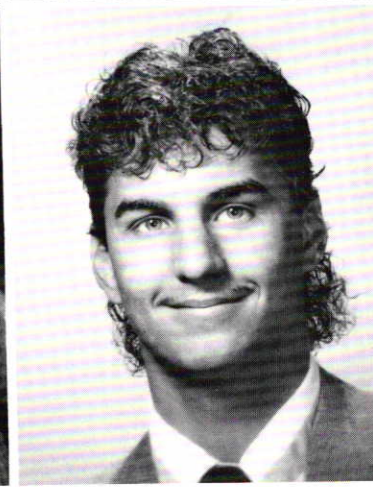

That's What Friends Are For...

Friends. Just what does being a friend mean? Webster's Dictionary defined a friend as "A person whom one knows well and is fond of." Other definitions included "Someone who wishes you well," or "someone you associate with." But when SENIORS were asked the question, "What do you consider a friend?" their answers differed greatly from Webster's Definitions.

In a recent survey these qualities were selected. "Someone who will always listen when you need to talk."-Donna Oakley. "Someone who accepts you the way you are."-Marlene Sanders. "Someone who will never tell your secrets no matter what."-Kim Johnson. "Someone who knows all about you and still likes you."-Shane Elliott. "Someone who listens, understands, learns, and loves."-Hershel Shoats.

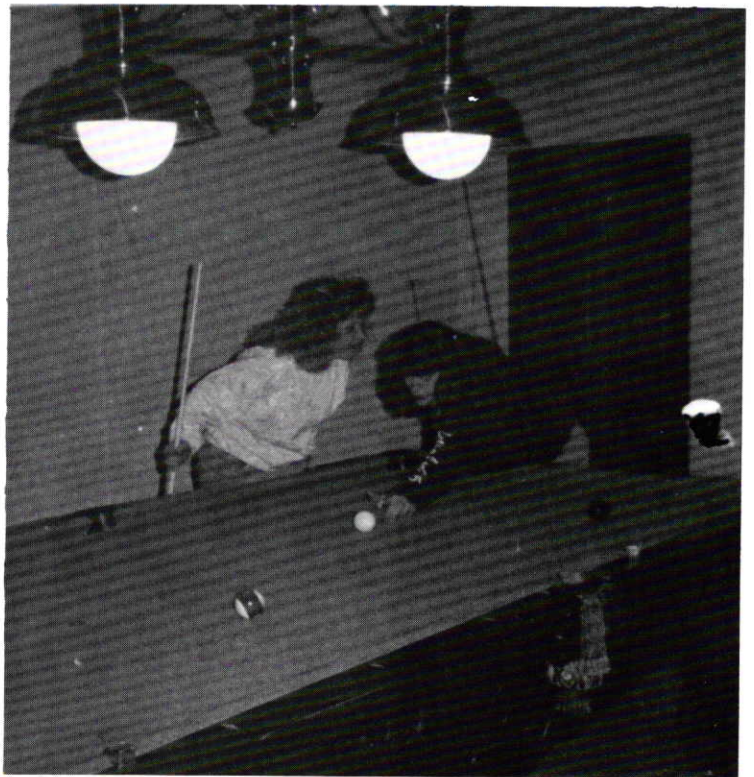

S E N I O R S



MARCY MEDSKER - Who's Who 4; Band 1,2; Kayettes 2; Acts 3,4; Tornado Times 3,4 ... TONYA MERRELL - Track 1,2,3,4; Spirit Squad 1,2,3; Who's Who 4; Band 1,2; Kayettes 2 ... MICHELLE MERRIMAN - Who's Who 3,4; Spanish Club 1,2,4; Kayettes 2; Acts 3,4; Yearbook 1,3,4; Forensics 3,4; National Forensics League 3,4.



LISA MORaine - FHA 2; Kayettes 3,4; Choir 1,2; Chorale 3,4 ... AMY NADEN - Spirit Squad 2,3,4; National Honor Society 3,4; Who's Who 4; Band 1,2; Athletic Club 4 ... DONNA OAKLEY - National Honor Society 3; Who's Who 4; Band 1,2,3,4; FFA 1,2,3,4; 4-H 1,2,3,4.

SHELLY ORTOLANI -
 Volleyball 1,2; Track 1,2,3,4;
 Spirit Squad 1,2,3,4; Who's Who
 4; Athletic Club 4 ... NEIL
 OWENS - Cross Country 1,2;
 Boys Swimming 1,2,3,4; Track
 1,2,4; Band 1,2 ... CHAD
 PAGE - Football 1; Boys
 Swimming 2,3,4; Track 1,2;
 VICA 3,4; Demolay 1,2,3,4.

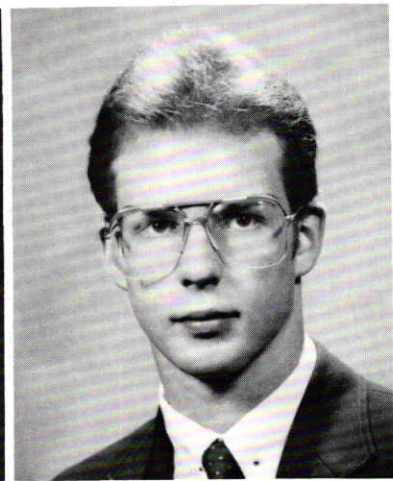
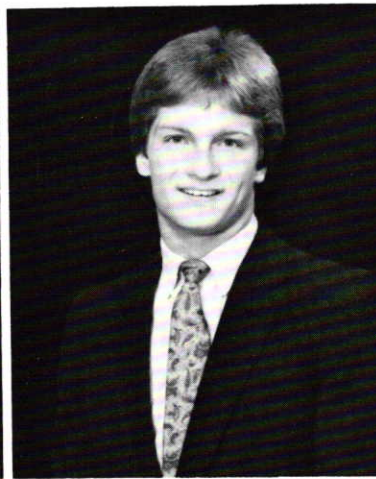

MARK PATE - Football 1,2,3,4;
 Wrestling 1; Track 2,3,4
 ... BRUCE PEIRCE - Who's
 Who 3,4; Band 1,2,3,4; Pep Band
 1,2,3,4; Jazz Band 2,3,4
 ... BRENDA PENDLETON -
 Band 1,2; Spanish Club 1,2,3;
 Kayettes 2,3.

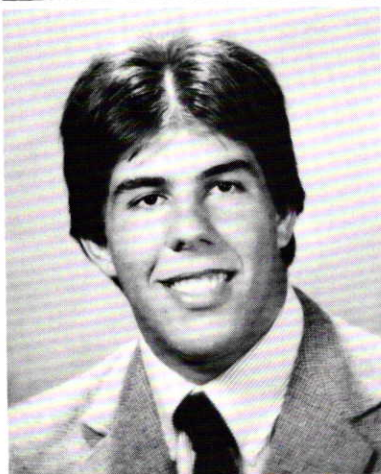

DEBBIE PIPPIN - Volleyball
 1,2,3,4; Spirit Squad 2; Stuco 3,4;
 Who's Who 4 ... BECKY
 POLK - Breakfast Club 3
 ... LISA POLK - Spirit Squad
 2,3; Who's Who 4; Kayettes 2,3.



LORI POMRENKE - Who's
 Who 4; Band 1,2,3; Kayettes 2;
 Acts 3,4; Tornado Times 3,4
 ... KIM POOL - Spirit Squad
 1,2,3,4; Who's Who 3,4; Athletic
 Club 4 ... JAMES POTTER -
 Art Club 3.

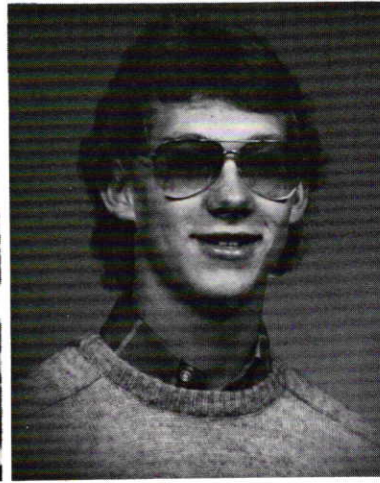

The Best Of Times



As the tension & fear faded away, SENIORS found themselves looking toward new experiences. For most, the completion of high school meant college careers or marriage. But memories of the past three years in high school kept alive in yearbooks, trophies, dance pictures, and varsity letters, still remained.

In a recent survey asking "What was your favorite year in H.S.?" SENIORS said: — "Senior!, because after this, I'm free?" Terri Isnard. — "Senior, because I've waited twelve years for it, why not make it the best?" Kim Pool. — "Not in H.S., kindergarten, it was a party." Randy Reardon. Whatever the reason, be it friends, Florida, or freedom, the SENIOR class concluded that 1987 would reign as their crowning year of high school.

S E N I O R S

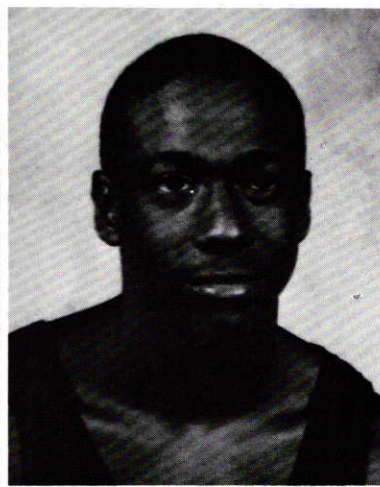

MELISSA POWELL - Stuco 4; Band 1,2,3,4; Spanish Club 1; French Club 3,4; Kayettes 2,3,4; Spirit Club 4 ... LISA PUGH - Band 12; Breakfast Club 2,3,4 ... SHON RANSOM - Boys Basketball 1,2,3,4; Track 1.

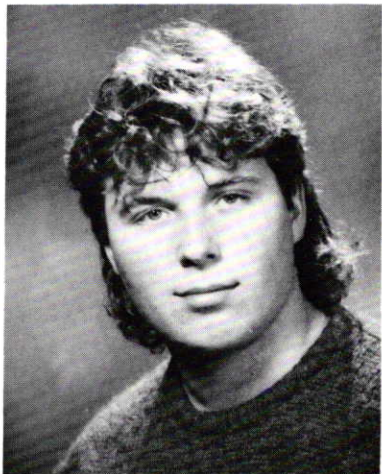
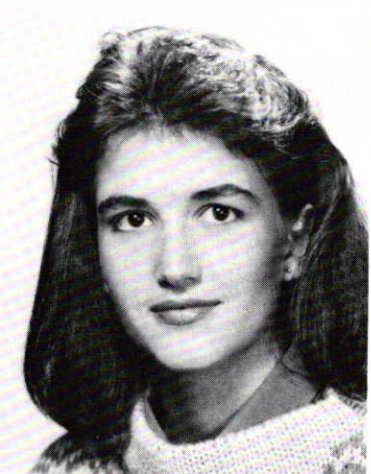

LORA REARDON - Track 1; Spirit Squad 1,2,3,4; Kayettes 2; Athletic Club 4 ... RANDY REARDON - FFA 1,2,3,4; Breakfast Club 1,2,3,4 ... DEBORAH REED - Girls Basketball 1; Track 1; Kayettes 3; Spirit Club 4.

LIZ REED - Girls Basketball 1,2;
 Choir 1,3,4; Chorale 3 ... JOHN
 REEVES - FFA 1,2,3; VICA 3,4;
 Rodeo Club 1,2,3 ... DEE REIS-
 TER - Spanish Club 1; FFA 1,2,3,4;
 Art Club 1; Rodeo Club 1,2,3.

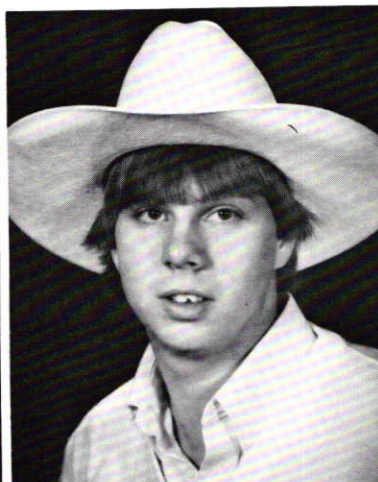

CHRIS RILEY - Football 1,2,3,4;
 Baseball 1,2,3,4; Key Club 2 ...
 RICHARD RILEY - Football
 2,3,4; Wrestling 1; Baseball 3,4
 ... TOM ROBERSON.

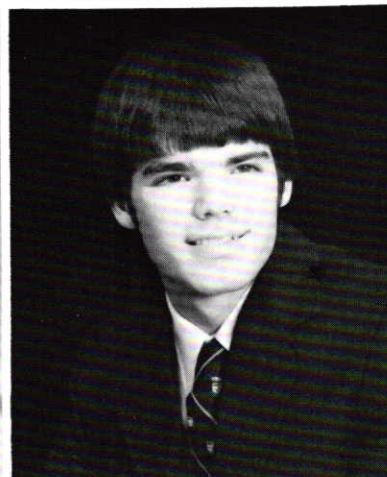

S E N I O R S

Take This Advice

For years Seniors listened to their parents, teachers, and peers give them advice. Suddenly, as the year progressed, Seniors relayed their advice to the underclassmen. In a survey held Seniors were asked: "What is the advice you would give to underclassmen?"

— "Make the most of the moments because those memories will last forever"-Stephanie White

— "Make this the best of times"-Tim Blevins

Senior year is an exciting time in a persons life. It is a chance to advise the underclassmen on what they should do and what they can look forward to their Senior year.

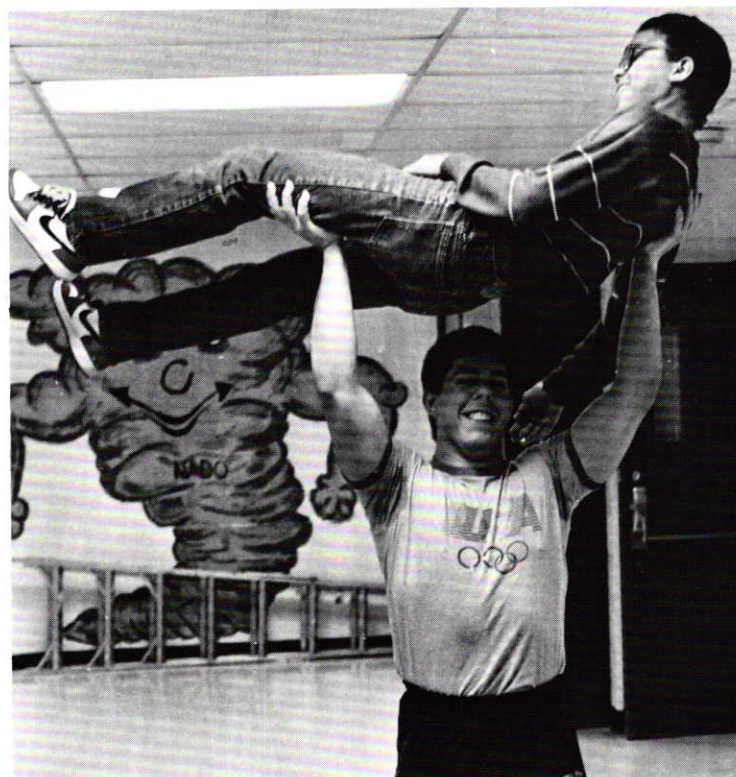

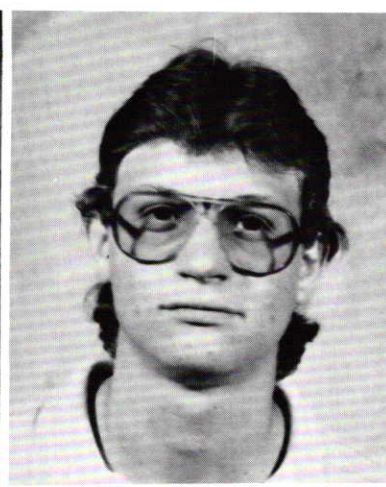
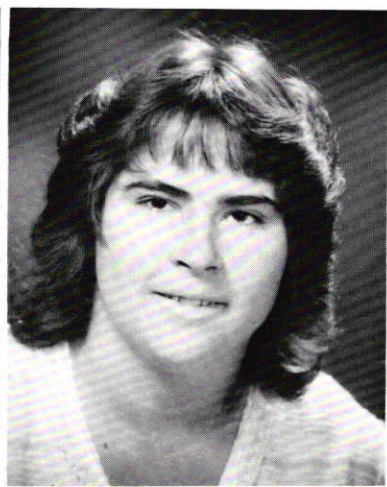
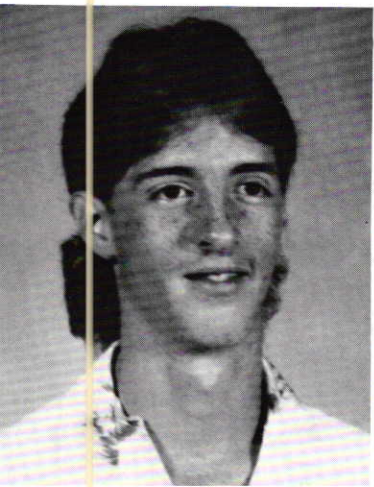

DAVID ROWLAND - FFA
1,2,3,4 ... LISA RUARK - Who's
Who 4; Rodeo Club 2; YBTP 4
... MARK SAMORA -
Wrestling 1,3.

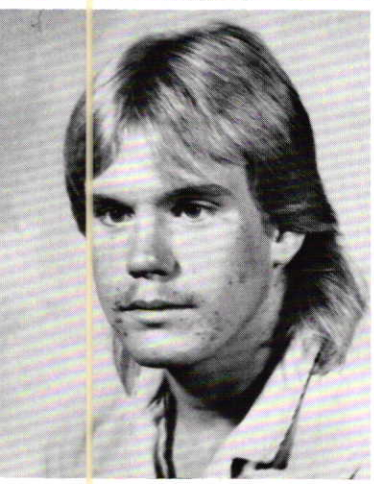

JIMMY SAMSON - FFA 2
... MARLENE SANDERS -
Cross Country 1,2,3,4; Girls
Basketball 1,2,3,4; Track 1,2,3,4;
Kayettes 2; Athletic Club 4
... MELISSA SANDERS - Spirit
Squad 2,3; Kayettes 2,3,4; Stuco
3; Who's Who 4.

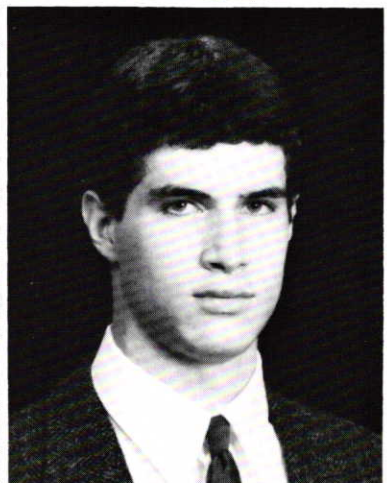

MICHELLE SCHOONOVER -
Track 1; Spirit Squad 1,2,3;
National Honor Society 3,4;
Who's Who 3,4; French Club 4;
Kayettes 2; Key Club 3
... DARREN SCHROEDER -
Boy's Basketball 1,2,3,4; Track
1,2,3,4; Who's Who 4; Art Club
3 ... DARNEL SEATON -
VICA 3; Breakfast Club 1,2,3,4.

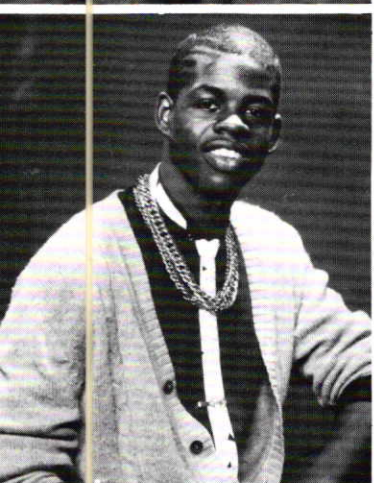

HERSHEL SHOATS - Football
1,3; Who's Who 4; Art Club 3,4
... JOYCE SHOATS ... BETTY
SMITH.

Music



Memories of a special dance, music that reminded you of going to the beach or that 'one party'; these were a large part of the students' lives at FKHS. Just a few words could remind you of that special person. When asked to pick a favorite song or band, seniors often disagreed, but had few problems deciding on their own favorites.

In a recent survey, seniors answered this question: "What is your favorite song and band?" — "You Give Love A Bad Name" by Bon Jovi - Roger Hurst. — "Polka" by Virgil and Bill — Mark Pate. — "Shake Me" by Cinderella — Lora Reardon. — "Amanda" by Boston — Tollie Arnold. Music styles changed as fast as Billboard could keep track of them, but seniors held onto their favorites and kept music an important part of their lives.

S E N I O R S

BRIAN SMITH- Boy's Swimming 2,3,4.; Golf 1; National Honor Society 3; Who's Who 4; Band 1,2,3,4
 ... LISA SMITH- Volleyball 1,2,3,4; Girl's Basketball 1,2; Track 1; Spirit Squad 1; Stuco 1,2,4; Kayettes 2; Athletic Club 4
 ... STEPHEN SMITHSON- Spanish Club 1; Choir 3; Chorale 4.

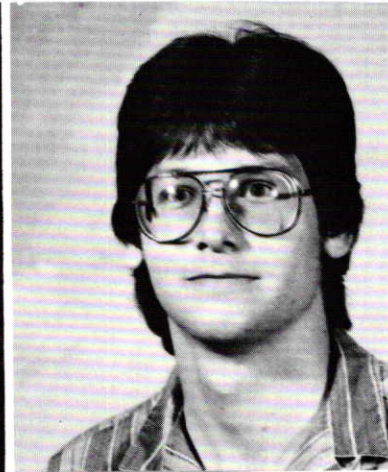
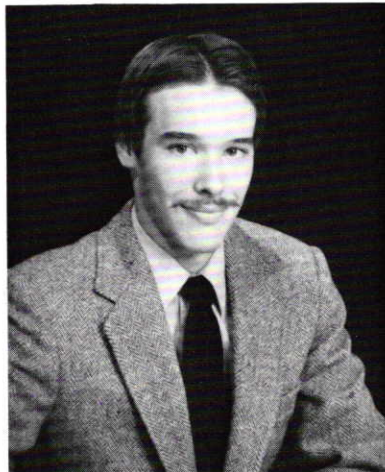

JASON SMOOT ... SONNY SPRAGUE- FFA 1; Rodeo Club 2,3 ... STAN STEWART- Football 1,2,3,4; Baseball 3,4; Breakfast Club 1,2,3,4.

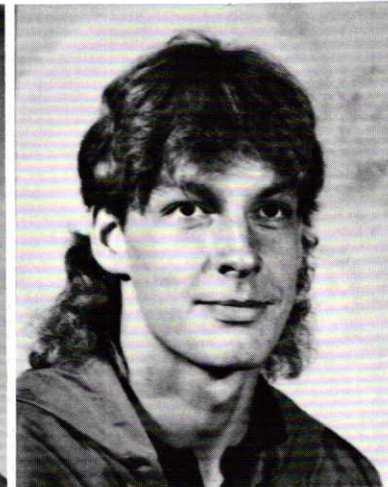
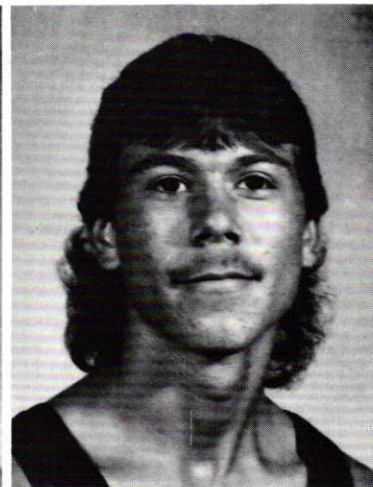
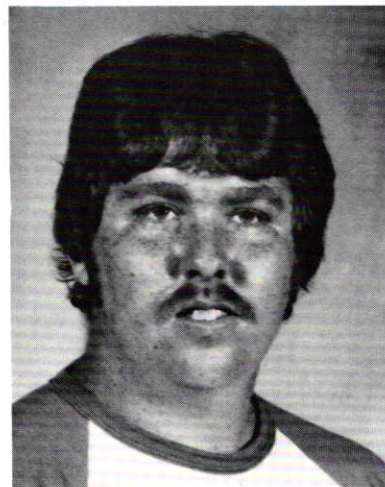

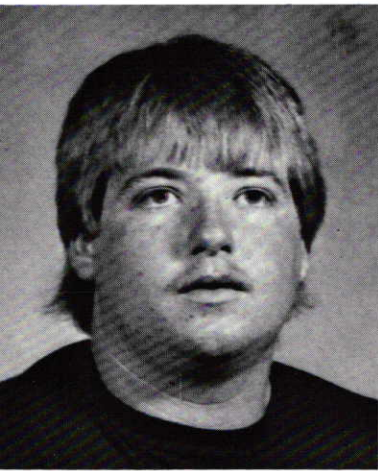

MIKE SWIGART - Football 3;
 FFA 3; VICA 3 ... JILL
 TAYLOR ... STACY
 TEDSTROM - Who's Who 3,4;
 Spanish Club 1; French Club 2;
 Rodeo Club 1.



TAMARA THOMPSON -
 Swimming 2; Girl's Basketball 1;
 Track 1; Girl's Swimming 3,4;
 National Honor Society 3,4;
 Who's Who 3,4; Band 1,2,3,4;
 French Club 3,4 ... LISA
 TICKLE - FHA 1; Choir 1,2,3,4
 ... JOHN TONEY - Golf
 1,2,3,4; Who's Who 4; French
 Club 4; Athletic Club 4.

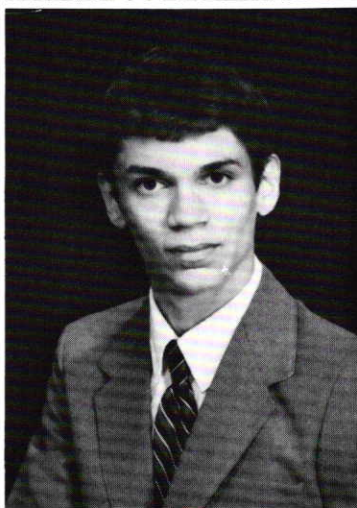

ROBBIN TOSH - FFA 1,2; FHA
 2,3 ... MELISSA TRAHAN -
 French Club 3,4 ... JIM
 ULIBARRI - Who's Who 4;
 Spanish Club 1,2,3; Debate 1.

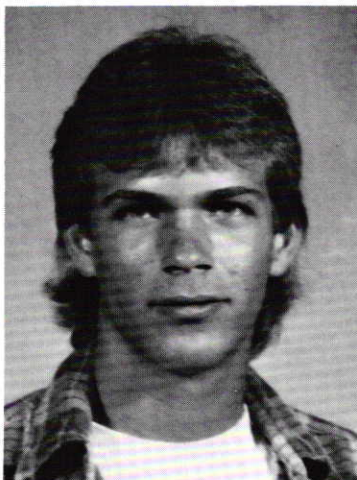
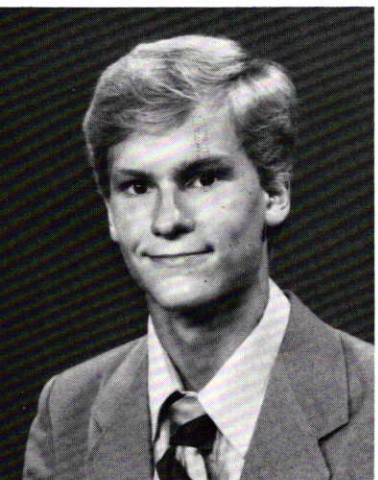

DANIEL VACCA - Boy's
 Swimming 2,3,4; National
 Honor Society 3,4; Who's Who
 4; Spanish Club 1,2,3,4 ...
 SHELLY VICTORY - Volleyball
 1,2,3,4; Girl's Basketball 1,2,3,4;
 Stuco 4; National Honor Society
 4; Who's Who 3; Band 1
 ... JOHN VILLINES - Football
 1,2,3,4; Boy's Basketball 1; Track
 1,2,3.

ERIN VOELSKI - Spirit Squad
1,2,3; Kayettes 2,3,4; Choir 1
... TONY VOWELL - FFA
1,2,3,4; VICA 4 ... KAREN
WAGGONER - Stuco 3;
Spanish Club 2; Kayettes 2;
Breakfast Club 3.

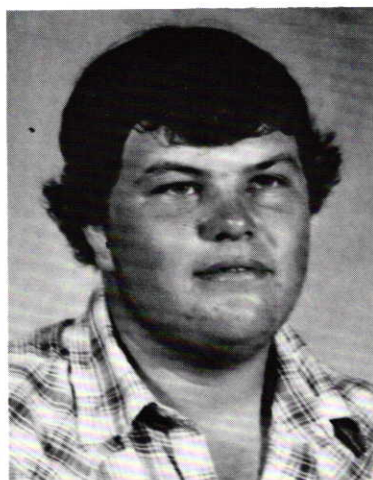

MELANIE WALTON - FFA 2;
Art Club 1; YBTP 4 ... TARA
WALTON - Girl's Tennis
1,2,3,4; Swimming 1,2; Track 1,2;
French Club 4; Breakfast Club 3;
Kayettes 2; Athletic Club 4
... PAULETTE WATSON -
Volleyball 1,2,3,4; Track 4;
National Honor Society 3,4;
Band 1,2; French Club 1,3;
Kayettes 1; Acts 4; Choir 1,2;
Chorale 3,4; Forensics 2,3,4.



TERESA WHEELER - Spirit
Squad 1; Kayettes 2; Chorale 1
... AMANDA WHITE - Band
1,2,3,4; French Club 1,2,3,4; Pep
Band 2,3,4; Jazz Band 4 ... LISA
WHITE - Spirit Squad 3,4;
National Honor Society 3; Band
1,2; FFA 1,2,3,4; Athletic Club 4.



STEPHANIE WHITE - Girl's
Basketball 1; Spirit Squad
1,2,3,4; Pom Pon 4; Stuco 1;
National Honor Society 4;
Who's Who 3; Kayettes 2,3,4;
Theatre 1,3,4 ... ANDREW
WILSON - Who's Who 3;
Debate 1,2,3,4; Forensics 1,2,3,4;
NFL 1,2,3,4 ... BRIAN WILSON
- Track 4; Stuco 1; Debate 1.

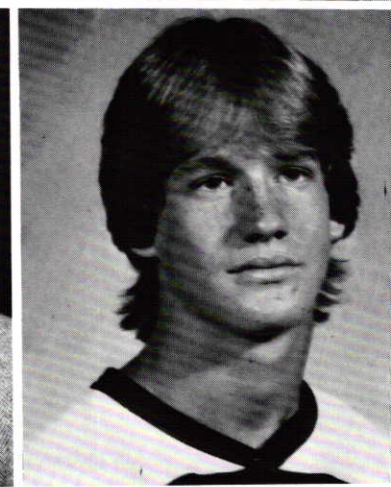
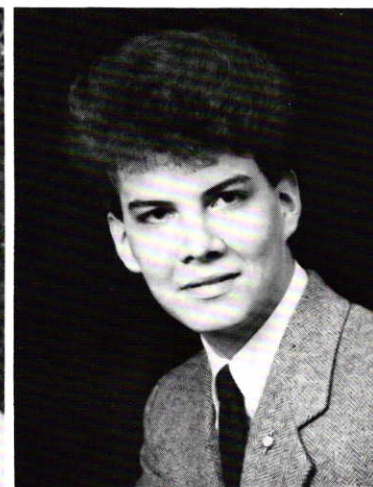

Save The Best For Last!

Driving down the highway, seniors knew they were close to their destination: Graduation. Graduation was close, and the endless months of planning all seemed to be coming together. The Class of '87 found many new activities knocking at their door. Seniors answered the question, "Being a senior means . . ." -"Preparing for the real world yet still holding on to the past."-Lisa Maritt. -"End of school and beginning of life."-Mark Samora. -"Everything"-Steve Hunt. -"Going crazy!"-Gordon Dickson. -"Making Mr. Josten rich by buying all this senior stuff."-Mark Hallum.

High school had come to an end very quickly, and with success. It came down to one thing, The Class of '87 had become seniors and the good times were definitely on their way!

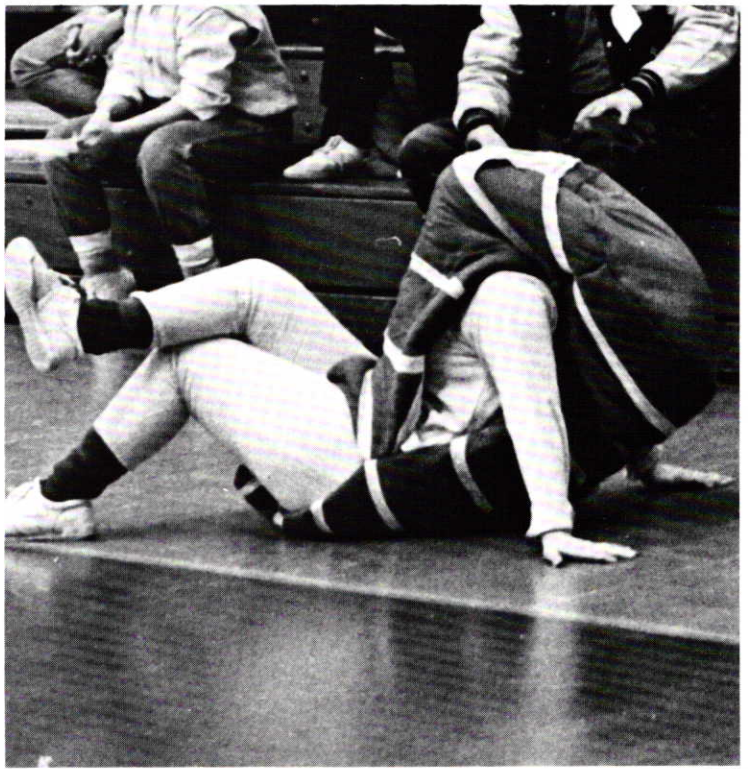

S E N I O R S

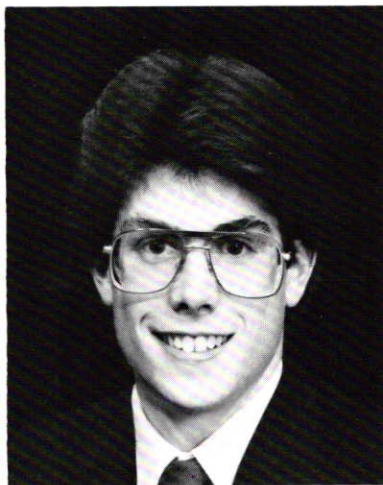

PAUL WINSTON - Boy's Swimming 2; Golf 1; National Honor Society 3,4; Who's Who 4; Band 1; Debate 1,2,3,4; NFL 1,2,3,4 . . . PATTY WOLF - Kayettes 3 . . . MARCY WRIGHT - Volleyball 4; Track 1; Spirit Squad 1,2,3; Athletic Club 4; National Honor Society 3,4; French Club 4; Kayettes 2; Key Club 3; Drama 1.

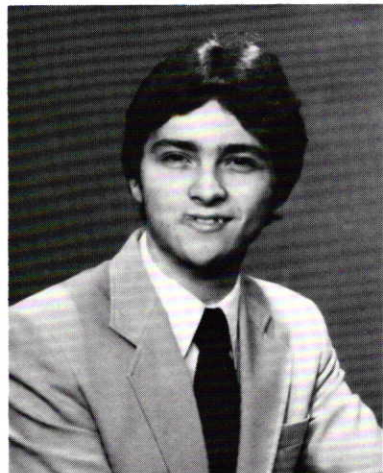

GRADY VICTORY - Who's Who 3; Debate/Forensics/NFL 1,2,3,4; Fifth Place State Championship Speech Tournament 3 . . . ROY WADE . . . TERESA WRIGHT.

Dreams

High School days are those filled with fun, school work, and an unlimited amount of security. But, who knows what will happen to the Class of '87 after graduation? If each senior had a wish for the Class, the Class would be successful, happy, and most of all, friends.

'My wish for the Class of '87 is: "Be remembered with respect."—Lisa Maritt. "Stay in touch."—Janet Bloomcamp. "Make our dreams come true."—Kathy Martin. "Lots of luck."—Shelly Victory. "Have fun."—Colin Colbert. "Everyone remember the days of F.K.H.S."—Pennie Durham.

With friends and high hopes behind them, the Class of '87 is sure to succeed and fulfill their dreams. To the closest and classiest class there is, GOOD LUCK!



SENIORS

I Know I'm Cute Sr. Randy Reardon is acting like his normal self. Randy is the last of 6 Reardon children to graduate from Field Kendley High School.

Not Pictured:

Cindy Adamson -
Kayettes 2,3,4

Mary Bowers -

John McClenning -

Jim Bay - Art Club 2

Bryant Colbert -
Football 1,2,3,4; Boys
Basketball 1,2,3,4;
Track 1,2,4

Bret Moorehead -
Football 1,2; Boys
Basketball 1,2,3; Boys
Baseball 1,2,3,4

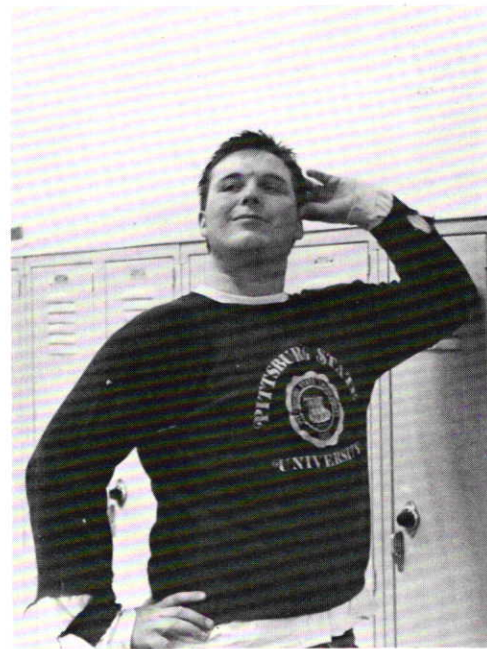

Definitely Senioritis! Sr. Dennis Dewey, overcome with emotion about graduating and leaving FKHS, grabs Lady Liberty in a moment of passion.



88

Reaching
for the
Gold

Athletes pushed for it and jewelers sold it, but the juniors found it another way. Reaching for the gold meant going for the impossible and achieving it. The Class of '88 established themselves as real "gold-achievers."

Keeping up with FKHS tradition, the Class of '88 filled over 30 positions in NHS, Twister Staff with twelve, and Tornado Times with six. Juniors participated in school activities more than ever.

Displaying their talent on the

field, more than 17 juniors helped the varsity football squad achieve the 5A State Playoffs in the fall.

"My goal for this year is to make it through the school year without losing my mind.", said Junior Brenda Davison.

"This year I plan to set an example for the sophomores for next year.", said Junior Beth Ables.

It made athletes determined and jewelers rich. With two years of high school behind them, the Class of '88 reached for their "gold".

A Close Knit Group, Juniors Jason Harden, Mike Brown and Craig Hillman show what being friends is all about.

Full of pep, Junior Sherry Stewart shows her spirit with a smile.

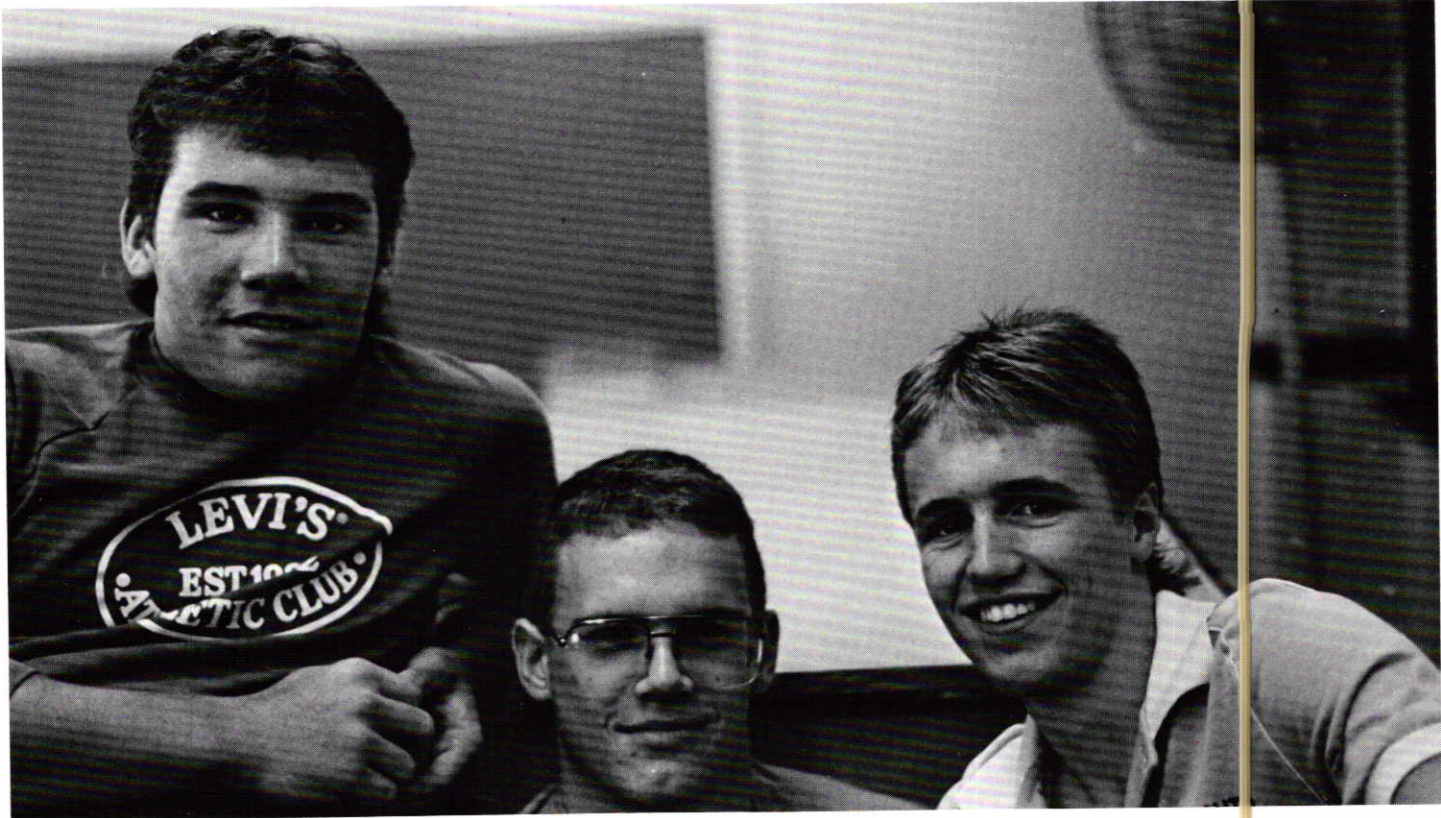



J U N I O R S

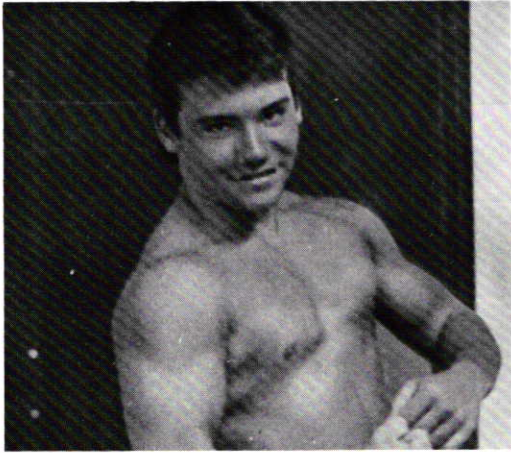

"Look at this body," junior Jason Harden shows off his muscles in the locker room.



"Who me? I wouldn't do something like that!", says junior Brian Foote.

Beth Ables
Cindy Adamson
Erin Akard
Tommy Alderman
Melissa Alexander

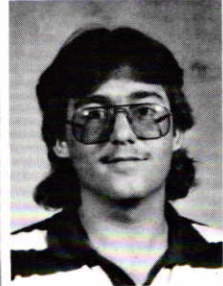
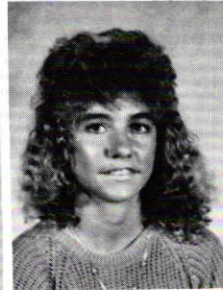
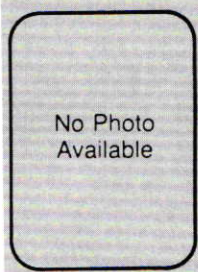

Mindy Allen
Christie Alwood
Michelle Antinore
Chris Applebaugh
Stacy Artherton



Steve Bates
Kelli Beemer
Becky Beverstock
Stacy Bishop
Tina Bixby



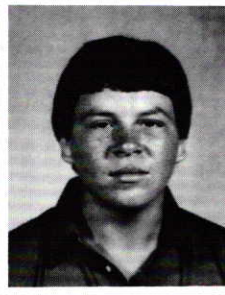
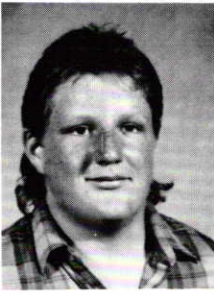

Teresa Blackburn
 Robbie Blakemore
 Michelle Blanding
 Lori Bohr
 Tim Boomershine

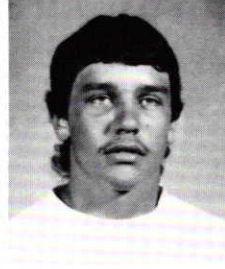
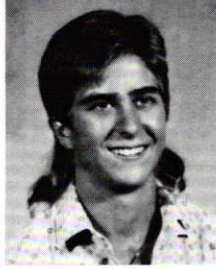
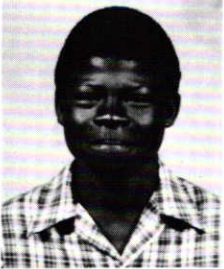

James Bowers
 John Bowers
 Tim Bradshaw
 Jeff Branton
 Mike Braschler

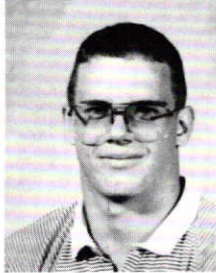
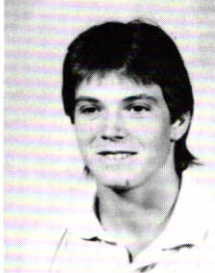
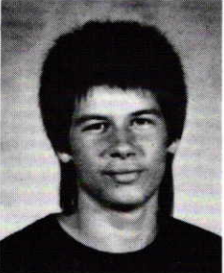

Tom Brinkman
 Alison Bristow
 Shawn Bromley
 Mike Brown
 Brenda Burdick

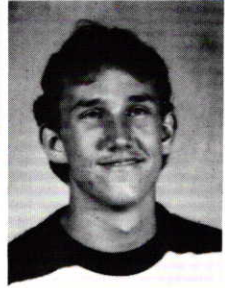
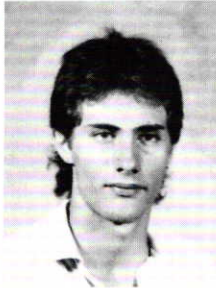
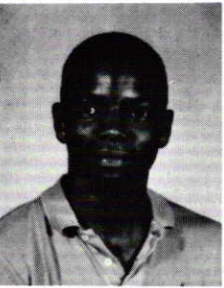

Tyrone Burnett
 Yvonne Burnett
 Grady Bush
 David Carpenter
 Darin Carr

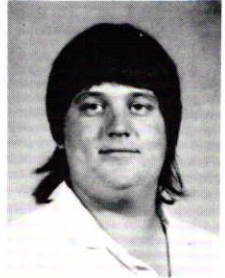
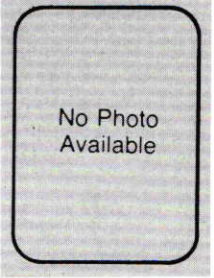
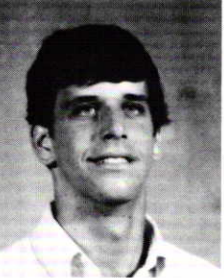

Mike Caulfield
 David Chandler
 Rachel Chandler
 Shontell Cherry
 Ronnie Coffey

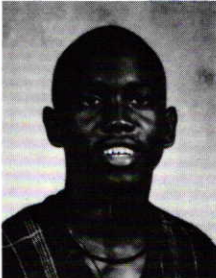
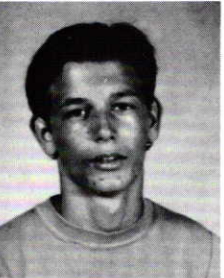

James Coffield
 Adrian Collins
 Tena Collins
 Terry Collins
 Tina Collins

J U N I O R S

Stacy Coltharp
Elizabeth Conklin
Dustin Cook
Todd Cook
David Coughenour

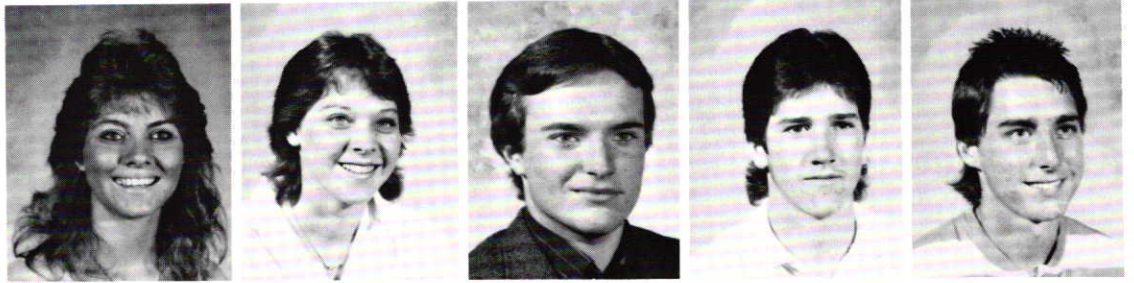

Richard Cowan
Beth Craven
Cindy Crouch
Marsha Crouch
Tommy Culbertson



Cuong Dao
Jerry Davis
Vincent Davis
Brenda Davison
Michael Detar

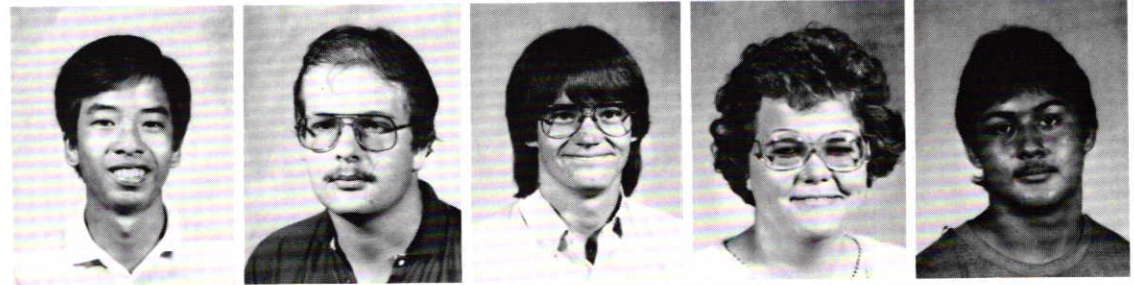

Julie Dewey
Tim Diaz
Sarah Diel
David Diver
Gina Dixon

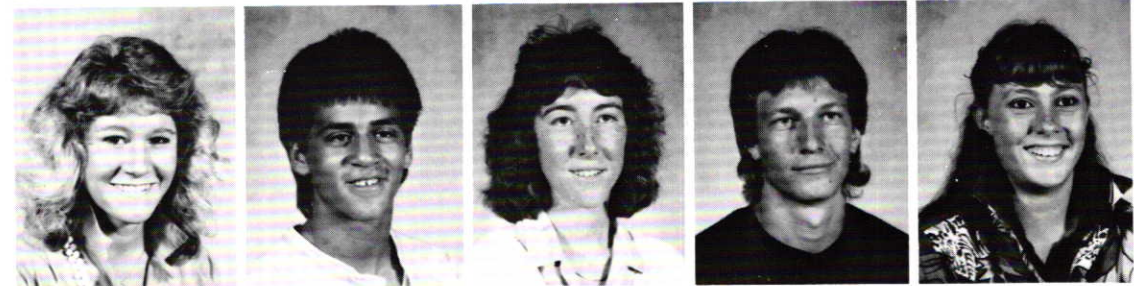

Troy Donahey
Michelle Durden
Jeff Evans
Joe Fernandez
Shauna Filson

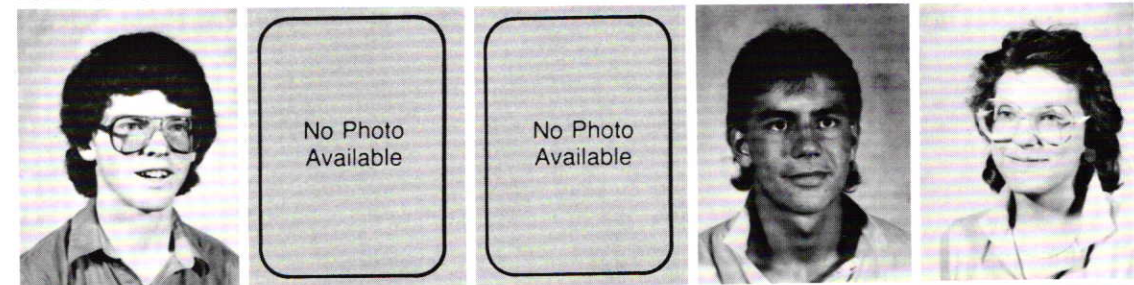

Doug Folk
Brian Foote
Cecil Frazier
Derrick Freeman
James French



O R S

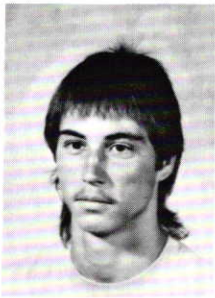
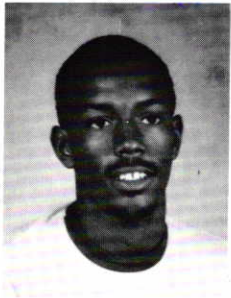

Dion Gaston
Rodney Gaut
Melissa George
David Gilham
Melissa Gillman

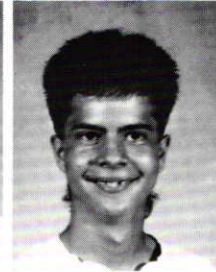

Tonya Glenn
Erica Gonzales
Mark Gordon
Kevin Gregory
Robin Grewell

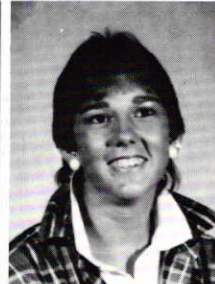
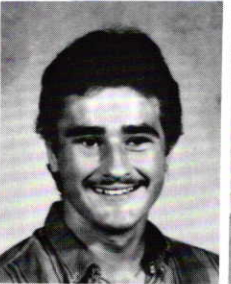

Todd Gritzmaker
Susie Guinn
LaShell Haffener
Billy Halligan
Heidi Hamrick



Double Feature: Twins' Life Can Be Twice As Easy And Doubly As Hard In Relationships, Friends, And Dates.

It has been said that being a twin is like a double-edged sword. While most people dream and fantasize about having a twin, FKHS has two sets, Cindy and Marsha Crouch, and Chris and Susan Norfleet, in the junior class.

Twins not only share birthdays, they sometimes share personal belongings, dates, friends, and thoughts. But, twins often feel the need to be different from their counterpart, and break away from the close-knit foundation they built when kids.

"Being a twin doesn't really affect Marsha and me. Actually, we act like a regular sister-sister team.", said twin Cindy Crouch.

"Double" play. Identical twins Chris and Susan Norfleet reminisce about their childhood days at Big Hill Park.

J U N I O R S

Angela Hanigan
Jason Harden
Angela Hardy
Dianna Harkins
Terri Harrah



Doris Harris
Ernestine Hastings
Mark Hatfield
Chad Hayden
Lisa Herrenbruck



Lance Hill
Craig Hillman
Todd Hills
Jodi Hiner
Kevin Hoggatt

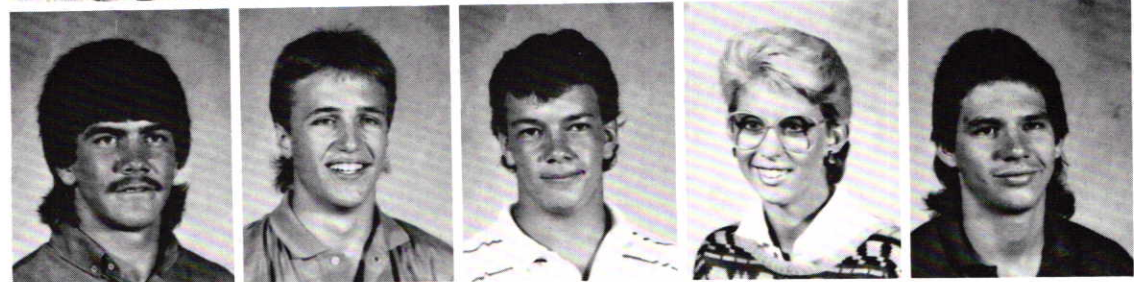

Boy Scouts Opportunity For Individual Growth, Healthy Competition And An Active Social Life.

Many times, people who have special or rewarding talents go unnoticed. Tommy Culbertson is one of these people.

For the past five years, most of Tommy's achievements have come through

Boy Scouts. Right now, he is working on the Star rank, and is a Senior Patrol leader in his troop.

"Boy Scouts has helped me learn more about myself and other people.", says Tommy.

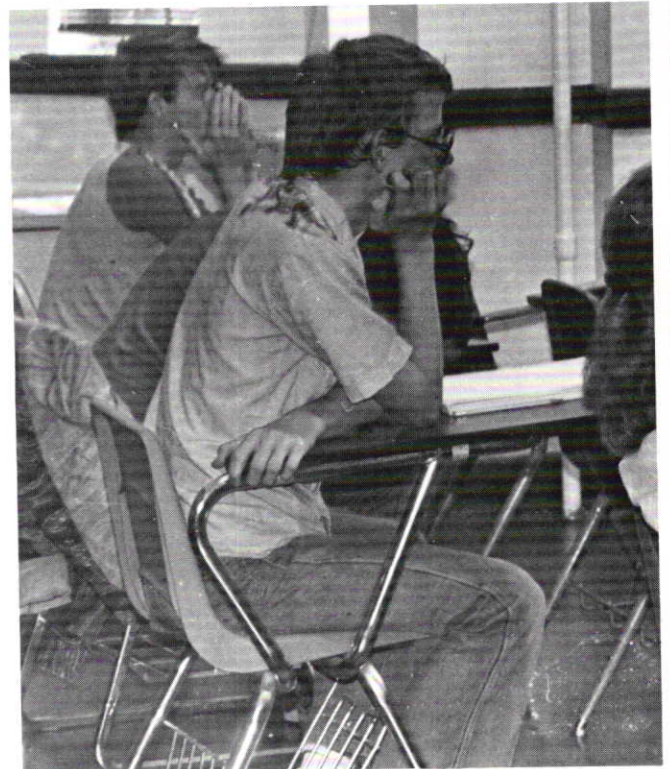

O R S



Brooke Hollyfield
Cindi Horner
Julie Huffman
Dianne Huneycutt
David Hunt



Amy Hyman
Scott Jarman
Lyman Jennings
Kelli Johnson
Melissa Johnson

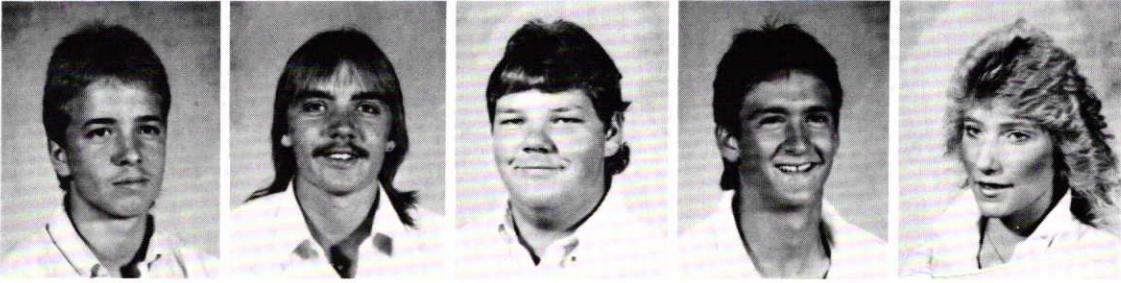

David Jones
Rusty Kent
Mike King
Dan Kinney
Kim Knight

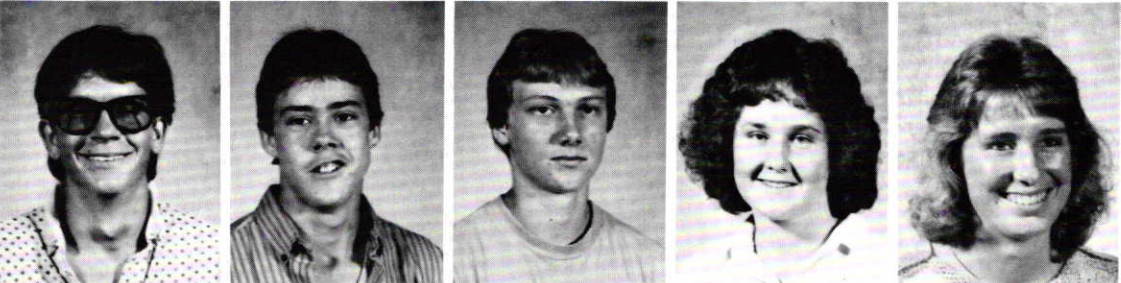

Lance Lee
Wes Lewis
Jeff Lewman
Angela Lockaby
Melissa Luker

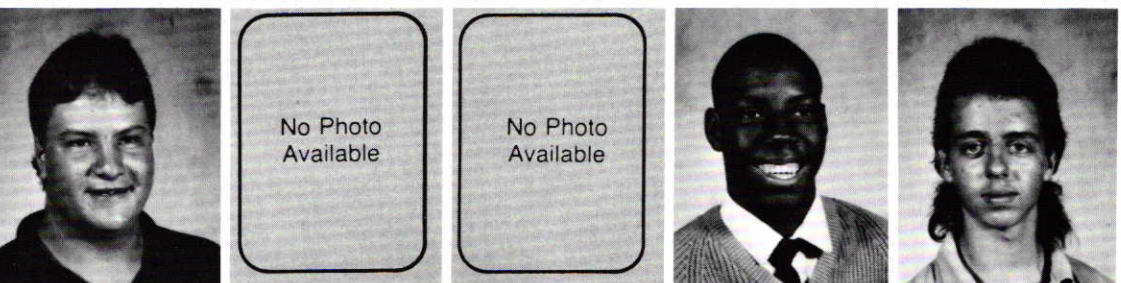

No Photo Available

No Photo Available

Shawn Marlow
Gwen Marshall
Kim Marshall
Phillip Marshall
Terry Martindale



Donya McFerrin
Tracy McGuire
Patricia Medlock
Sharon Miesner
Kim Mitchell

J U N I O R S

Shelly Moore
Tom Morgan
Brad Morris
Cheryl Morris
Shawn Morris

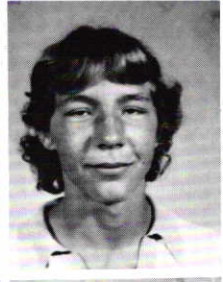
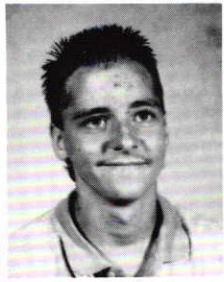

Tracie Moses
Glen Nave
Englund Neale
Angela Neale
Wes Nolen

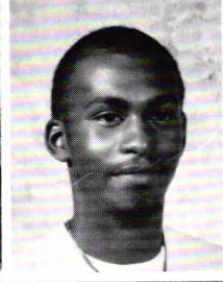
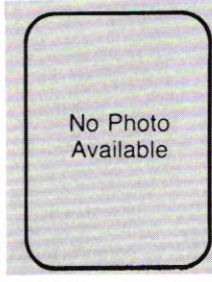

Chris Norfleet
Susan Norfleet
Shelia Oneslager
Brad Overton
Cardian Page



Toby Pierce
Randy Pope
Jeff Prince
Michelle Reynolds
Tom Richie

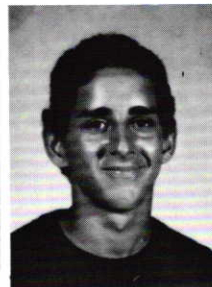
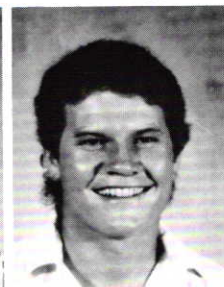

Cordell Ricks
Melinda Rider
Susan Rinkensbaugh
Val Roeder
Sean Roland

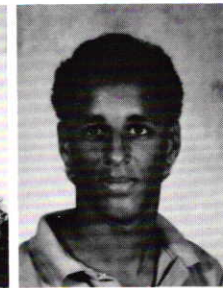
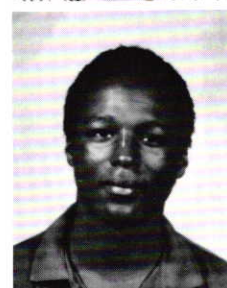

Jamie Rousch
Rhonda Rowe
Teresa Ruark
Gina Rutherford
Kenny Rutledges

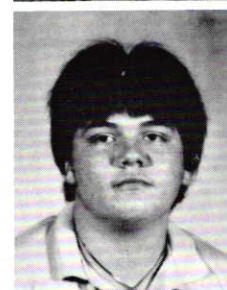

O R S

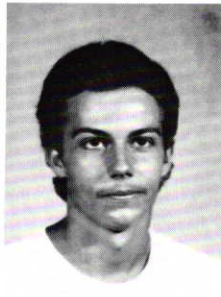
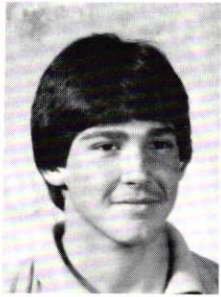

No Photo Available



Brenna Sanders
Jon Sanders
Mike Sauer
Haile Scott
Tracy Scourten

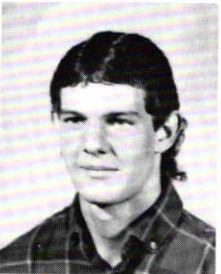

No Photo Available

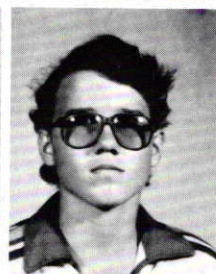

Jenny Seger
David Seigel
Theresa Senecal
Pierre Shade
Lannie Sizemore

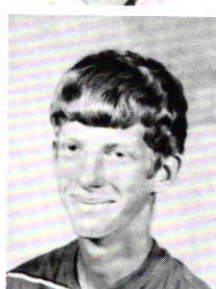
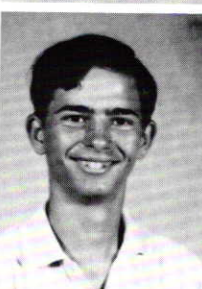
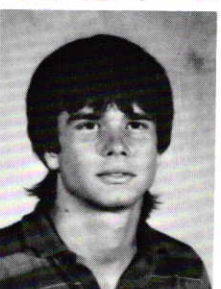

Ronald Sjolander
Valorie Smith
Wes Smith
Robert Sprague
Curtis Stair

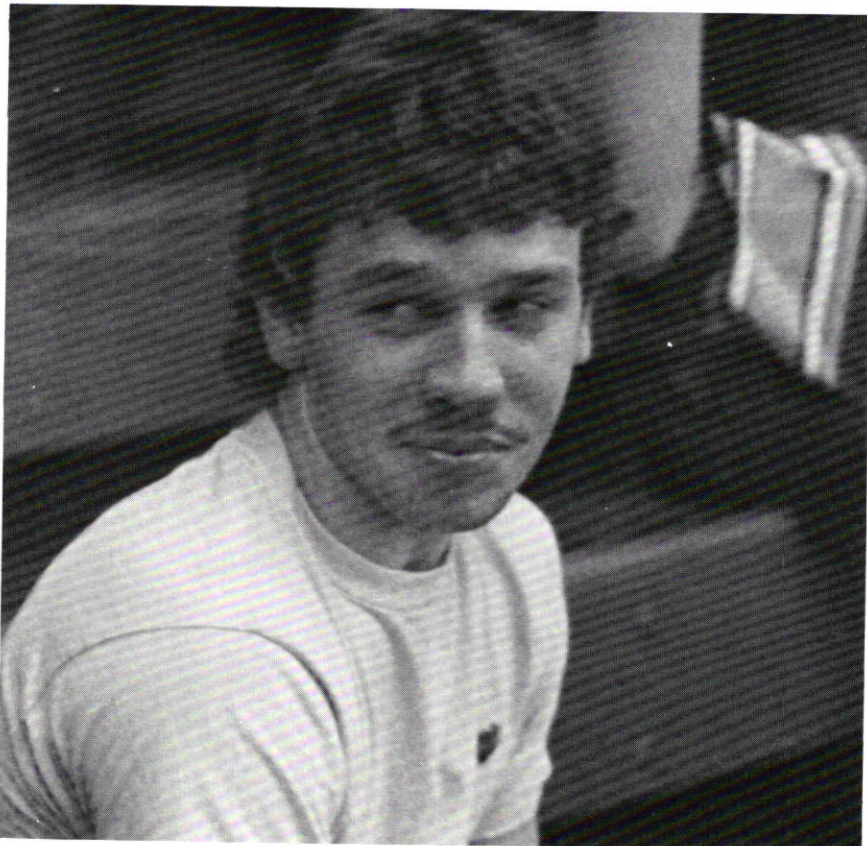

The Class Of '88 One Down And One To Go Means Caught In The Middle Again!

Juniors, as well as the seniors and sophomores, don't have it easy. But unlike the other classes, the junior class is at a midway point. They know most of the people here and know what to expect. They aren't that excited because their last year will be *next year*.

Some have conflicting views on the matter. Junior Stacy Coltharp said she liked her junior year "because I only have one more year to go.", while fellow junior Beth Ables said she was glad to be a junior because "I'm not a sophomore anymore."

Sure the class of '88 has its highs, but they have one down and one to go.

Doing Almost Anything, junior Mike Braschler watches the competition of "Almost Anything Goes" October 29th. The Athletic Club won among the 10 teams participating.

J U N I O R S

Mike Starnes
 Jeff Stewart
 Shelly Stewart
 Tammy Storey
 John Stroud

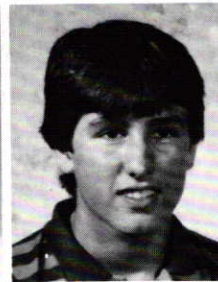
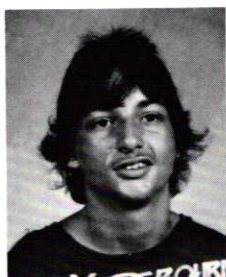

Don Sykes
 Kelli Tate
 Joe Taylor
 Brett Thomas
 Alice Thomason

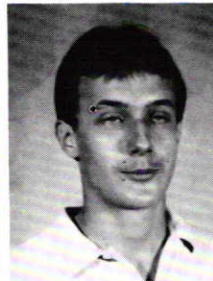
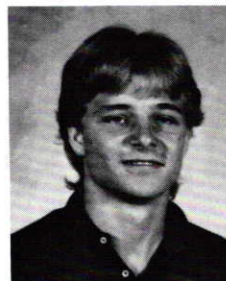

Mary Thompson
 Jessie Thurman
 Allen Tickle
 James Tickle
 Trent Tippen

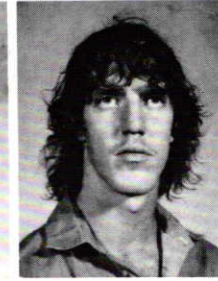
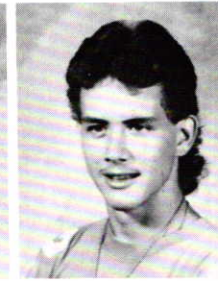
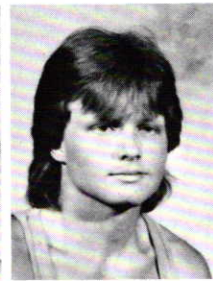
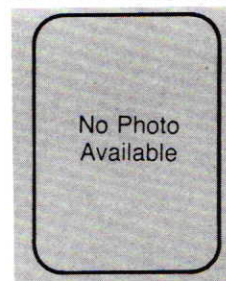

Julie Toliver
 Randy Trotter
 Susan Turner
 Jeff Ulibarri
 Kelli Underwood

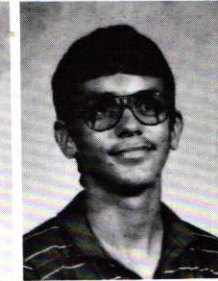
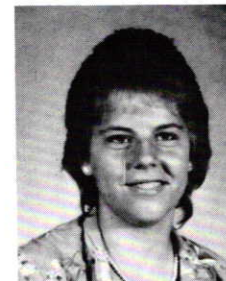

Todd VanBuren
 Bobby Vanderford
 Bobby Vargas
 Lushawn Vaughn
 Shawn Victory

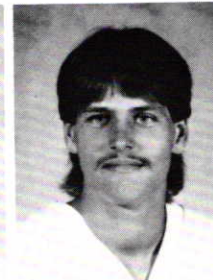
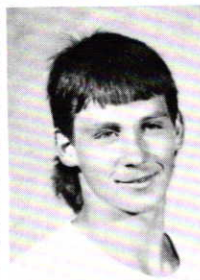
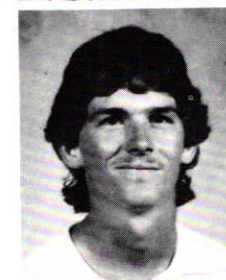

Steve Waddle
 Howard Walker
 M. Brannen Wallace
 Mike Ward
 Mike Ward

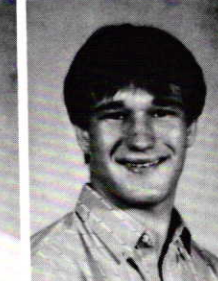
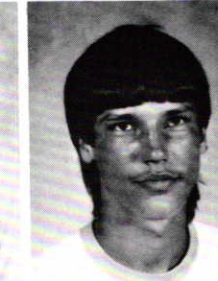
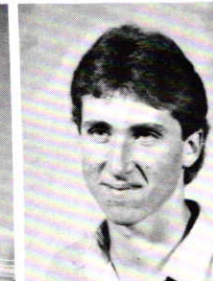
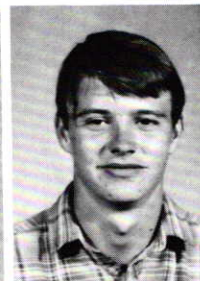



Students And Cars

From Basic Transportation To A Status Vehicle, It Seems Almost Everyone Could Get The Car.

Cars were meant for the road and teenagers were meant for cruising. Field Kindley teenagers were no different, with Eighth Street being the main drag more than ever.

"All this car is used for is transportation," said junior Craig Hillman.

Most of the student respondents to a poll agreed with this trend, with just over half stating they needed their car "to cruise in". Many others stated they needed their car to get to school and work in, while approximately 80% thought the gas and maintenance was the biggest hassle.

No Photo Available

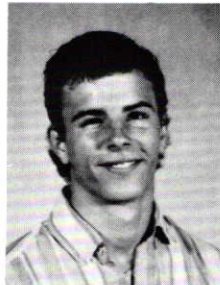
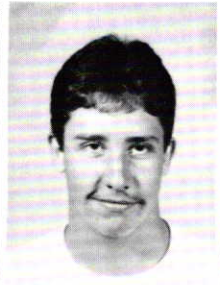
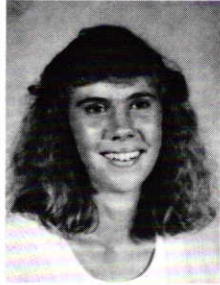

Tammy Warren
Michelle Wassom
Julie Weeks
David White
James Wilkinson

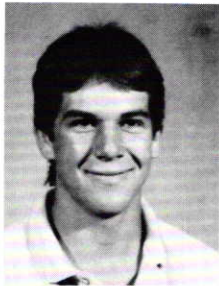
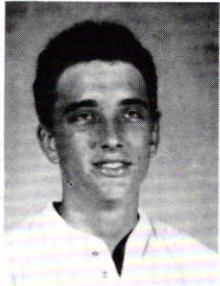

Alisha Wilson
Scott Wood
Scott Woolfolk
Martha Yeubanks

Measuring Up to Standards

Just one more step, the final step before getting off the bus. Now a walk toward those huge doors. The big school and long hallways added up to lost sophomores on the first day of school. Hardly able to get their lockers open and find classes struck fear in the hearts of the young sophomores. They asked themselves, "How can we measure up?". Sophomore Sherri Nett said, "You have a lot more pressure on you to succeed. It all starts and you have to get good grades now if you want to

succeed later."

Along with grades, Class of '89 had to take on new responsibilities. They had to think more for themselves and make sure that they measured up to standards.

Class of '89 have a reputation to live up to at Field Kindley. They are the youngest group in the school, and they get picked on the most. They had to keep spirits up, and make it through their sophomore year, which seemed almost impossible.

As the year went on, sophomores found they really could measure up.

Long halls seemed shorter and surroundings more familiar. Being involved in the school and fulfilling responsibilities became part of life at FKHS. They became part of the student body, and lost their title of lost, confused sophomores.

Sophomores of Spirit, Lena Slayton and Cami Misch, watch the football game against LCHS on October 31st. Field Kindley went on to win the game.

Sophomores Julie Wood, Charlotte Woodard, and Tonya Arnold enjoy themselves at the Homecoming Dance held October 10th at the Food Center, admission was \$2.00 and Neal Carpenter was D.J.





Chet Aitkens
John Allen
Mike Allen
Tammy Antinore
Andre Arbaza
Tonya Arnold
Angela Austin



Theayre Austin
Vanessa Bardwell
Jenni Beals
Dalenia Beckwith
John Bell
Victor Bell
Linda Benning



Julie Bever
Donna Bierbrodt
Kristi Blakslee
Robin Blanding
Curtis Bolden
Nancy Boomershine
Tanya Bossman



Nate Boulds
Warren Brashear
Terria Briggans
Kent Brown
Todd Browning
Tyce Bruns
Chris Burnett

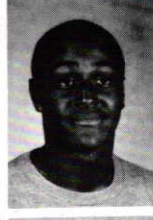

Derek Burnett
Milan Burnett
Franklin Byrd
Jo Ann Byrne
Dana Camren
Monte Carriker
Ward Carroll

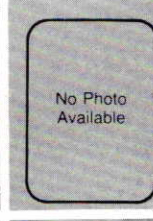

Clint Chowning
Jason Clark
Larry Coffey
Tom Compton
Brian Conger
Eddie Cox
Jim Cox

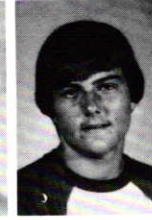

Kelly Cranor
Craig Creed
Edna Davis
Gary Davis
Antionette De Jear
Tim Deacon
Dwayne Dent



Dwight Dent
John Downing
Donnie Driskel
Nikki Dunlap
Wesley Easter
Toni Eden
Gib English





"I Really Like H.S.
It's A Matter Of
Making New Friends.
In Some Classes All
Three Grades And
Even Freshmen Are
There."
Sophomore Melanie
Robinson

Viewpoint . . .

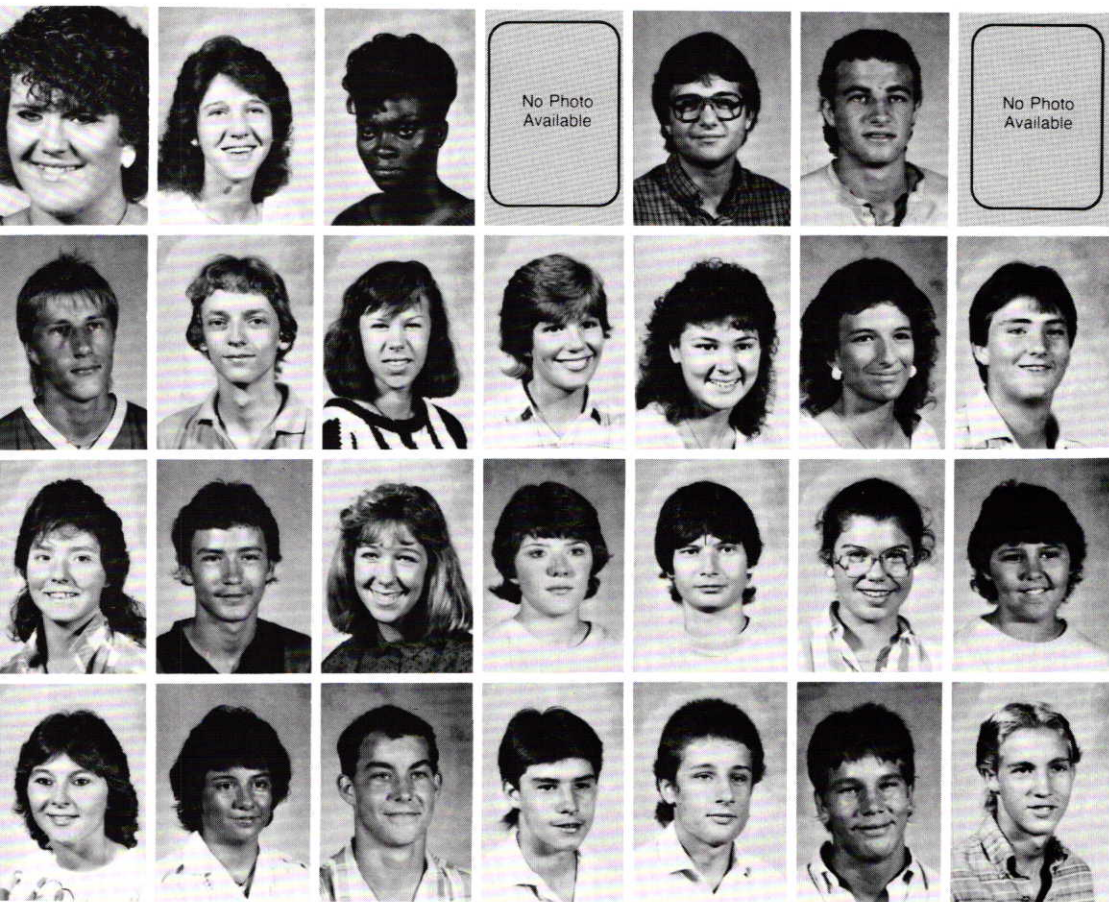

Shyla Farrar
Cindy Felts
Kristie Fields
Lisa Foster
Edwin Fowler
Steve Freeman
Sheryl Frost

Mitch Galindo
Steve Garner
Susie Garrison
Holly Gartner
Kristi Gavrilyns
Misti George
Shawn Gilfillan

Marsha Gilliland
Michael Gilliland
Heather Gillis
Kerie Glenn
Scott Gordon
Jennifer Gossard
Michelle Green

Shanya Gregory
Kendra Grigg
Jason Grooms
Darin Hamlin
Brock Hanna
Nelson Hare
Steve Harkins

Robert Hatkn
 Matt Hayden
 Cara Haynes
 Joe Hayward
 Marilyn Hayward
 Kim Heacork
 Melissa Hedrick



Brian Hefley
 Lisa Helt
 Lynette Henderson
 Chris Hendryx
 Richard Henry
 Paula Hill
 Russell Hills



Arthur Hodge
 Cathy Hodges
 James Honor
 Vincent Howard
 Carrie Hulsey
 Wynette Irving
 Brittany Ivey

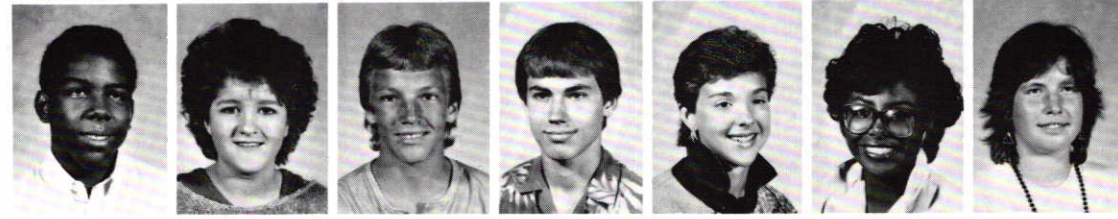

Ann Jaimez
 Annette Jaimez
 Angela Jarett
 George Johnson
 Maitinel Johnson
 Sam Johnson
 Shaney Johnson



Surviving The Big Mac Attack "Food And More"

"Veal birds are the best. I love them," says sophomore Vanessa Bardwell. Many of this year's sophomores feel the same way about their favorite foods.

Far and away, pizza is the 'fave food' king, or so says 40% of the sophomores. Other Italian dishes came in second and meat dishes were a third.

Over 72% of the students felt they have bad eating habits and 37.3% skip breakfast on a regular basis.

Snacks are here to stay. While many couldn't decide how often they snacked or what their favorite snacking food was, one fact is golden: over 70% of FKHS sophomores are admitted chocoholics.

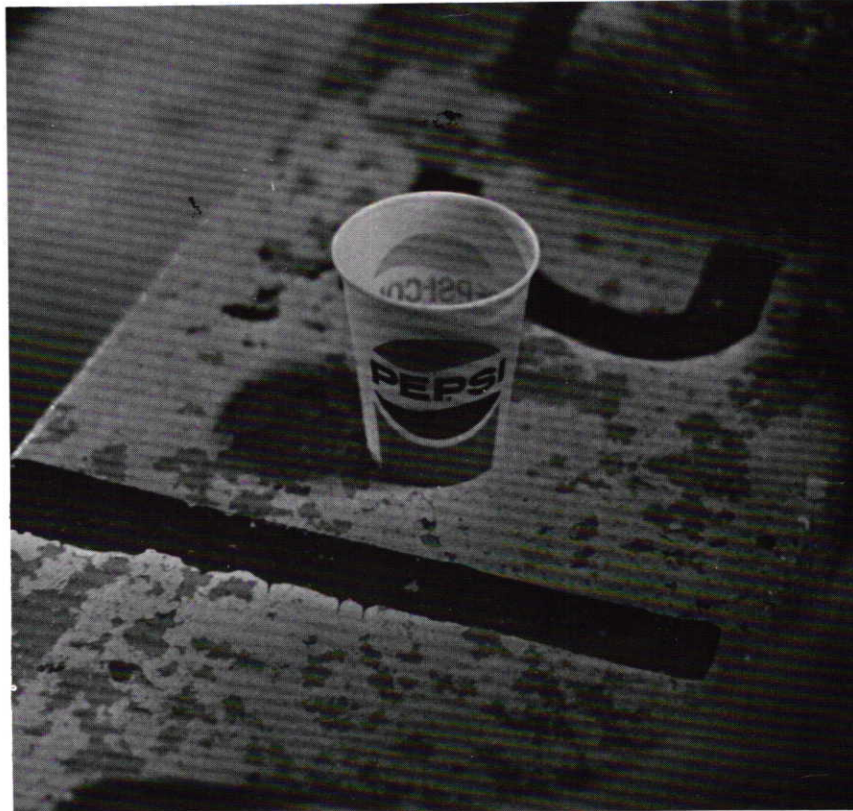

M O R E S

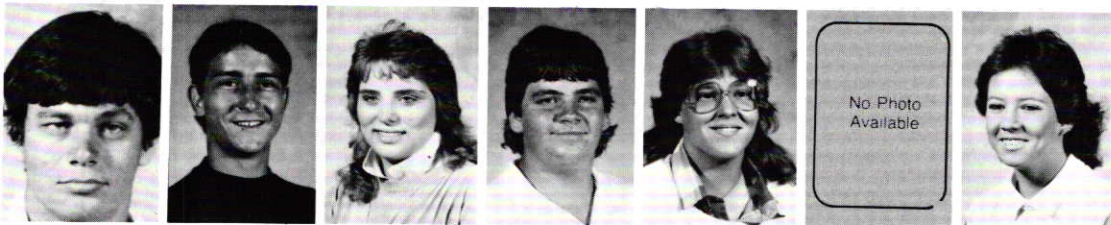

Anthony Jones
James Jones
Georgina Kent
Tom Kill
Rita King
Eddie Cox
Anna Lamb

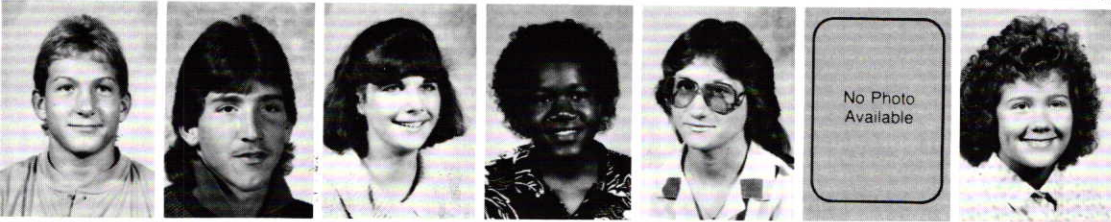

Bryan Lantz
David Lantz
Anne Layton
Rosslyn Ledman
Marilyn Lendall
Travis Letterman
Mary Liebert



Michael Lind
Terri Lipe
Kellie Llewellyn
Cara Locke
Cristie Logan
Chuck Lukens
Jody Lynn



Mike Lynn
Alan Madow
Craig Marshall
Stephanie Martindale
Jill Mashburn
Shannon Mason
Tina McBeath



Amy McCurry
Karen McDaniel
Kasey McGarvey
Patricia McGill
Patricia McHenry
Jayson Miller
Cami Misch

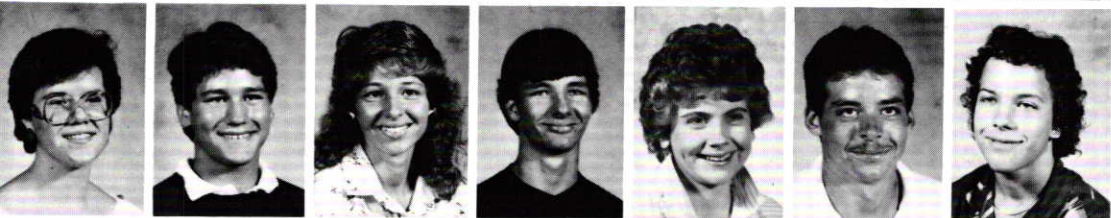

Holly Mitchell
Kendall Mitchell
Norma Morgan
Travis Morris
Janice Morrison
Chad Morrow
Paul Morrow



Jennifer Moses
Robert Murry
Stephanie Nadolny
Sherri Nett
Andre Neuldon
Kelley Nichols
Rebecca Nordin



Lisa O'Connell
Angela Oerman
Lyndia Owen
Melissa Page
Brad Palmer
Paul Parker
Ronnie Pearson

S O P H O

Brian Pierce
 Sherri Peyton
 Kyle Phelan
 Alan Phillips
 Alyson Phipps
 Tina Powell
 Lana Price

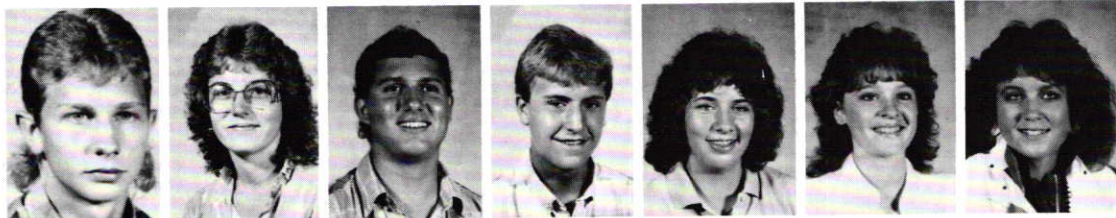

Darren Ray
 Ronnie Raymond
 Andrew Reese
 Troy Reister
 Amy Richardson
 Brian Richardson
 Latisha Roberson

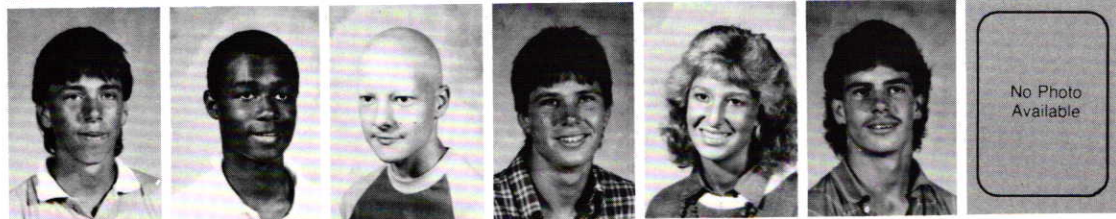

Melanie Robinson
 Darcey Ross
 Carol Runyon
 Bernice Sales
 Stephanie Salway
 Pete Sanford
 Chad Schenck



Tim Schulz
 Marshon Scott
 Shoshana Scott
 Shonya Seaton
 Corey Shields
 Debbie Shores
 Angela Sjolander



Lena Slaton
 Michelle Slaton
 Steve Spelecher
 Dorothy Sprague
 Glen Starr
 Russ Strimple
 Chad Stroud



Amy Stuckey
 Winifred Sutton
 Alfred Therrien
 Misty Thompson
 Tisha Thompson
 Shawn Timmerman
 Angela Tipton



Rochelle Tomlin
 John Tosh
 Michelle Triebel
 Shane Triebel
 Darren Trotter
 Gary Trotter
 Bill Troxel



Renisha Trussell
 Marlin Turner
 Toby Turner
 Charles Upton
 Rosalynda Uy
 Melody VanBuren
 Tommy Vanderford

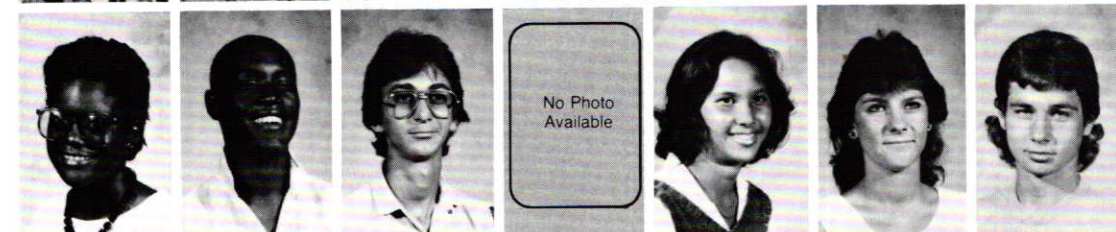

M O R E S



Angie Vanderlinden
LaDonna Vaughn
Ollie Vaughn
Brandy Vogt
Julie Volk
Patty Wadkins
Judy Wallis



Tara Walton
Jason Warren
Thomas Watson
Marsha Watts
Christina Weber
Scott Wells
Chad Wheeler



Stacey Wilkerson
Lisa Wilkerson
Brenda Willard
Charles Williamson
Eddie Wilson
Patrick Wilson
Laura Winston



Angela Wishall
Teresa Wishall
Julie Wood
Charolette Wollard
Annette Wright
Lucinda Wright
Patricia Wright

SOPHOMORES



Willy Wright



Kip Young

Sophomore Paul Parker looks a little nervous as he gets ready for a cross country meet.

Golden Rules

Uniqueness. For most educators a prized novelty, but for the Field Kindley faculty a second nature. Obviously questions, answers, tests, and lectures seem quite common ground covered in most classrooms, but what really made the faculty special appeared as originality and individuality. The faculty had been caught doing some imaginative and interesting activities which caught the eye and caused the students to want to stay in class and learn. But this was also a way for faculty

to keep from seeing school as just a job. Teachers learn how to go for years in an environment with frustration. Their sense of humor shows each teacher's personality while at the same time, helps them cope with the 'lows' of the learning process. Doing special projects like Sheri Richards English classes dressing up as a character in a novel added up to a less monotonous day.

Each year new students and fads conquer the halls. In the classroom, the creativity of the faculty shined through their ever-

present, stereotyped paper grading and lesson planning. For the faculty at FKHS the extras became standard equipment — just another golden rule.

Mr. Webster band Director tries out the new Jupiter 6, a Synthesizer just purchased this year. It cost \$2,000 and is used mainly for special effects in Jazz band.

Mrs. Elaine DeMello shares her insights on a piece of fine art with a group of art students 5th hour at the Vo-Tech.





F a c

KAY ADAMS-Main Office
 ELIZABETH ANDERSON-English,
 Times Sponsor, volleyball
 RICHARD ANDREWS-Assistant
 Principal
 CHARLES BLOOMCAMP-Drafting,
 Boys Basketball

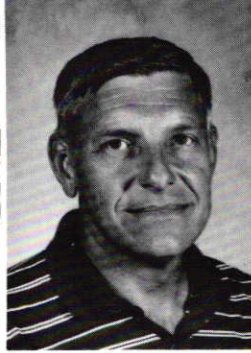
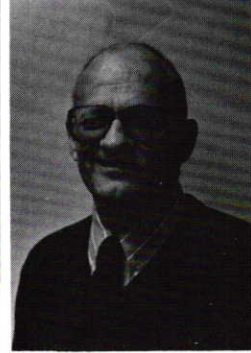

FRANK BOBEK-Chemistry I, II,
 Physics
 KENT BROWN-Athletic Director,
 Football
 JANET BRYANT-English
 MARIA BUMGARDNER-Home
 Economics

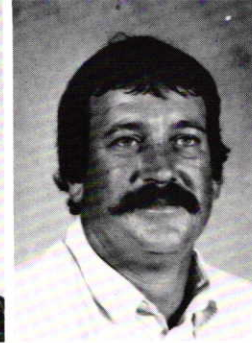
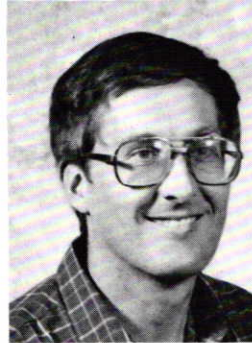

DALE CAUTHON-Math, Computers
 MARK CHANCE-Math, Girls
 Basketball, Football, Track
 LEON COLE-Science
 PAUL CRANDELL-Physical Education,
 Girls Track

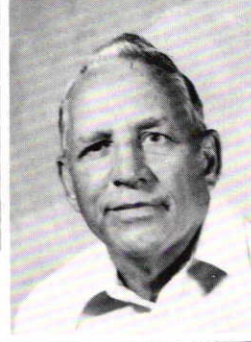
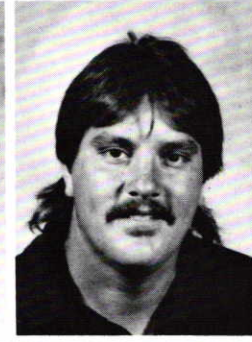
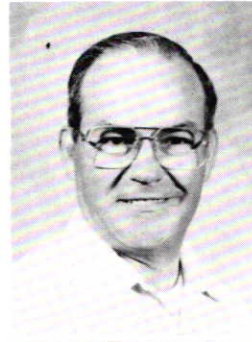

ELAINE DEMELLO-Art, Art Club
 CAROL DIXON-Attendance Office
 VICKI DODSON-English, Theatre,
 Kayettes
 DIANA EIKENBERRY-Business



VIRGINIA FANSLER-Special
 Education
 LAVAE FERGUSON-Guidance Office
 CHERYL GEORGE-Spanish
 RICHARD GRIFFIN-Math



u l t y

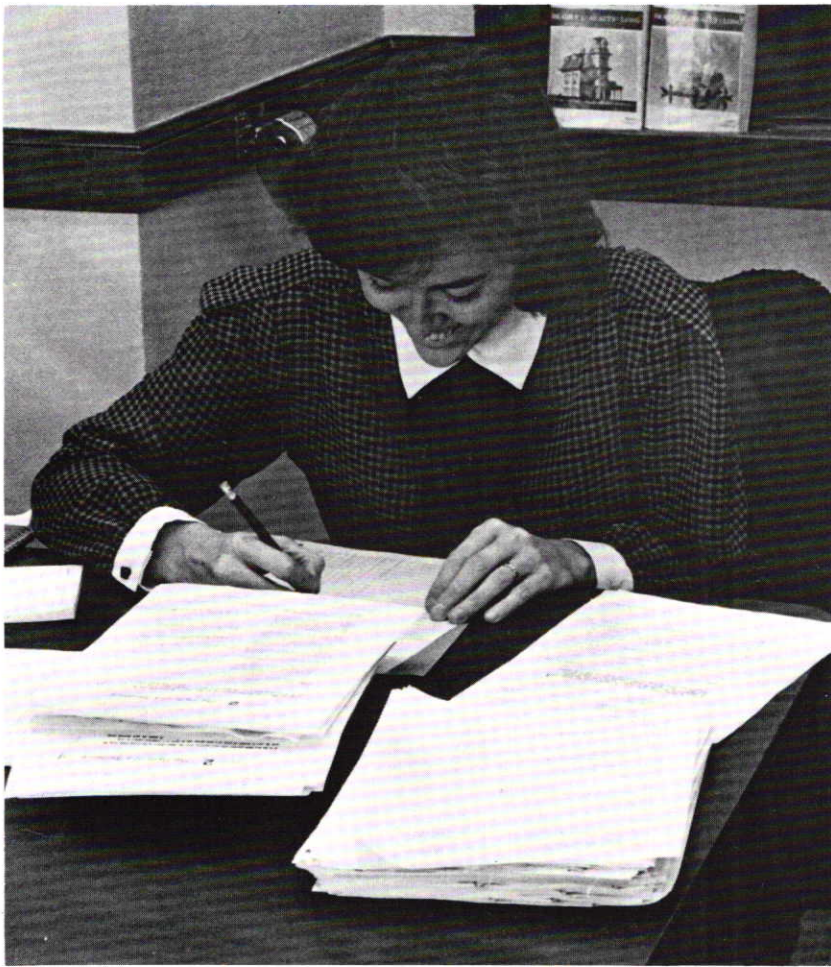

To keep the school in top condition are the janitors Maurice Brown, Jim McIntosh, Danny Garner, Lewis Bell, Herman McDaniels, and Kenny Lowry.

One of the many things that face a teacher is the never ending task of taking attendance.

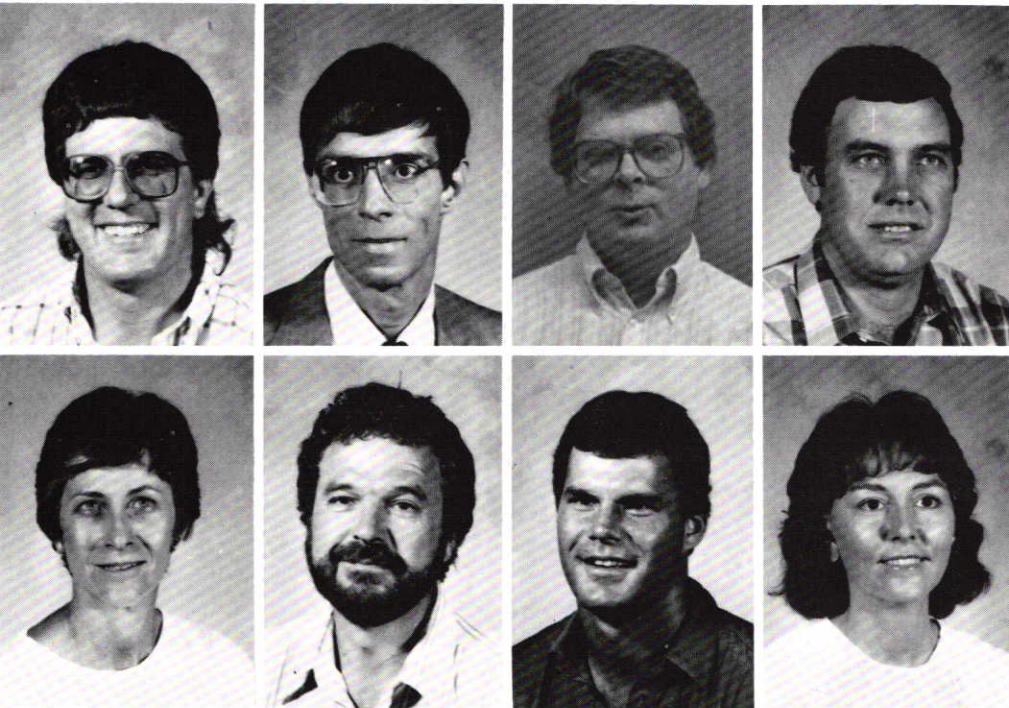

DARRELL HARBAUGH-Debate,
Forensics, English
SAM HEDGES-Social Science
Student teacher
PATRICK HENRY-Social Science,
NHS
SHERMAN JONES-Math, Basketball

MARY KENGLE-Social Science,
STUCO
STEVE KIMBALL-Chorus, Choral
MIKE LEE-English, Golf, Assistant
Football Coach
LYN LOGELIN-English, Twister
Sponsor

F a c u l t y

DOROTHY LUMLEY-Home Ec., FHA
 SALLY LUNBLAD-Counselor
 RUBY MEADOR-Special Ed. Teacher
 Aid
 SHANNON MEHL-Special Ed.



LARRY MURDOCK-Typing,
 Computers
 EUGENE NEELY-Social Sciences
 JIM OWEN-Social Sciences
 SELMA PEYTON-Special Ed. Teacher
 Aid



SHARION RALLS-Main Office
 MARY REGAN-Social Sciences
 NANCY REINECKER-Librarian
 ELIZABETH REYNOLDS-Special Ed.



SHARI RICHARDS-English
 JERI RICHARDSON-Youth and
 Business Training Program
 NED RICHARDSON-Principal
 CYNTHIA RUPP-Business



JOYCE SEGER-Activity Office
 DARRELL SOMMERS-Counselor
 JOE STAUDT-Science
 SUE STAUDT-English

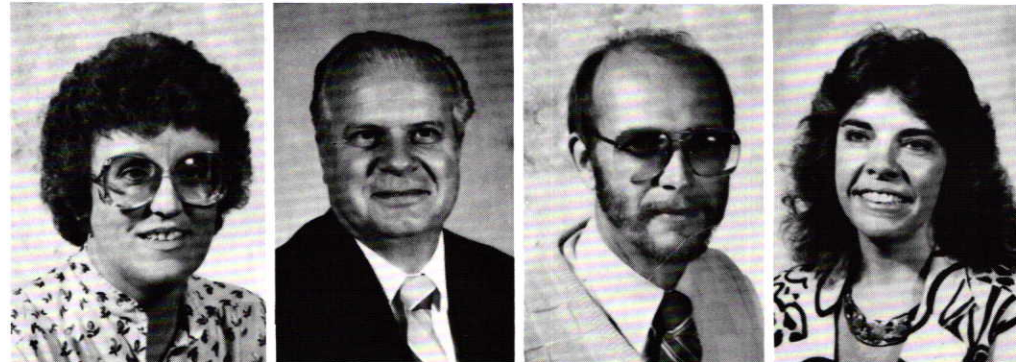



Wow

Mr. Chance Was In A Movie?

Yes, it's true, Mr. Chance was in a movie at the age of 11. "Ace Eli and Roger of the Skies" was released in 1971 by MGM and starred Cliff Robertson. When asked how he was chosen he said, "I was visiting my grandparents and they grabbed me." He had to stand on a hill and cry when an airplane broke his kite. Maybe he didn't have a starring role, but I'm sure he looked cute in those short pants he had to wear.



PERI VANTASSEL-French, French Club
CLAUDIA VOLELSKE-Special
Education
JIM WATTS-Social Sciences
MARC WEBSTER-Band, Jazz Band,
Pep Band

DAWN WHALEN-Student alternative
Classroom
PARICK WHALEN-PE, Girls & Boys
swimming, Rhythm & Gym

DEANNE ZIEGLER-PE





Gold Rush



Field Kindley's Greater Drum and Bugle Corps of 1937. Flashy attire and spectacular routines helped Coffeyville High School's show organization to become nationally renowned.

Standards in a Field Kindley students' life: rushing to buy gas for the ever-cruising cars, surviving a Big Mac attack, buying school supplies at Wal-Mart. From Levi's 501 Blues to pizza, Coffeyville had it all. Everybody had a little gold.

The downtown plaza has seen its share of excitement from the Dalton Raid in 1892 to its reenactment in 1986. It's hosted 100 years of Coffeyville shoppers.

Buckner
FURNITURE INC.

1611 W. 8th

251-1550

Coffeyville, K.S.

**Edgewood
Market**

Coffeyville

251-5630

2001 Woodland Ave.

CONGRATULATIONS CLASS OF 1987

Read's
Quality and Service since 1872

Fashion Family Apparel
Carrying on a Tradition of Quality Merchandise
Value and Service Since 1872

COFFEYVILLE

TULSA, OKLA

NE NATIONAL ELECTRIC INC.

pyrochem

PROTECTING TODAY'S ENVIRONMENT



FOR TOMORROW'S FUTURE

NOP
NATIONAL OIL PROCESSING INC.

CP
COFFEYVILLE TRUCK CENTER

DRYER - WHITE SHOE STORE

118-120 W. 8th Street
Phone: 251-2210

Boles JEWELRY

123 W 9th
Coffeyville

218 W 9th
Independence

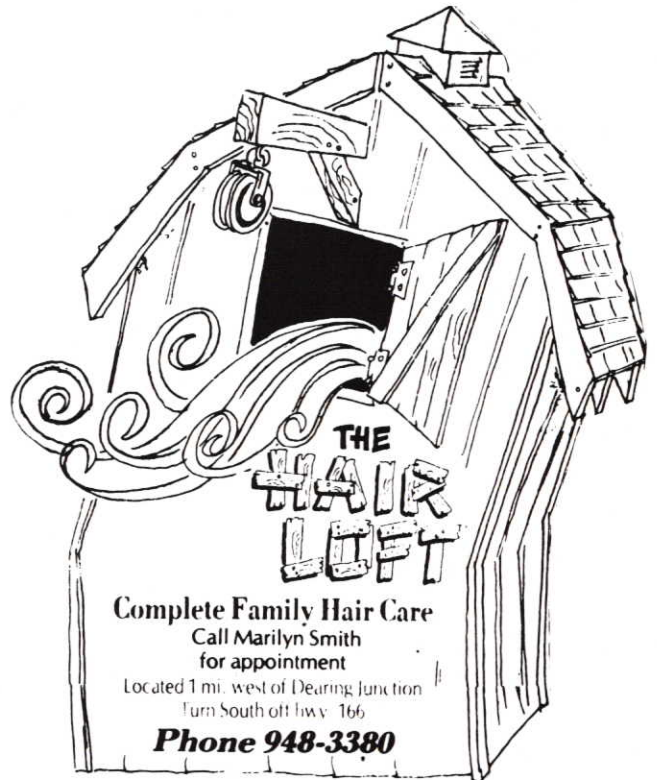

ELMORE'S FOOD CENTER

8TH & BUCKEYE
COFFEYVILLE, KS.



COAST TO COAST STORES
... total hardware

WAYNE GAUT
Store Owner

906 HALL

251-7880

COFFEYVILLE, KANSAS 67337

ALTERS ANIMAL CLINIC

1616 W 1st

Coffeyville, KS

BELT & COMPANY

Certified Public Accountants

813 Union
Coffeyville, Kansas
251-2150

FAMOUS BRAND CLOTHING

5th & Walnut
Coffeyville, KS 67337
316-251-9681

"More Than Just A T-Shirt Shop"
Custom Apparel Printing, Group
Discounts
Shop For All Your Clothing Needs
Where
Quality Does Not Mean High Prices.



HOSENEY'S

Dressed Beef

4 mi. North of
Coffeyville on Overlook

316-251-4770

Owners,
Patti & Jack Miller



GRAVES

Funeral Homes, Inc.

1117 W. 8th 251-4900 Coffeyville



DAVID W. BARNES



Brown

Furniture and Appliance Co.

251-5740

129 W. 9th

CONGRATULATIONS

to

Field Kindley High School

and its

100th Graduating Class

and

50th Twister Publication

Tradition is a valued experience



Where Winning is a Tradition



First Federal Savings and Loan Association

201 W. 8th, Coffeyville, Kansas / 316-251-2800

Two Convenient Locations

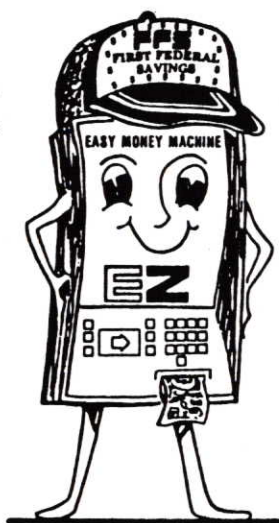

Fun and Easy

FAST
IR
ST
FRRIENDLY
FED
ERAL
SERVICE
SA
VING
S

soon to be a part of the
**FRANKLIN SAVINGS
FAMILY**



Franklin

SAVINGS ASSOCIATION

Founded 1889 Member FSLIC

Easy Money Machines:
11th & Hall, Coffeyville Plaza Shopping Center
8th & Maple, First Federal downtown lobby

selcho



1013 W. 8TH

COFFEYVILLE, KANSAS



Ameri-Sign Systems Inc.

P.O. Box 365
Coffeyville, KS 67337

(316) 251-4120

STONER'S

Hairdressing College
219 W 9th
Coffeyville
(316) 251-0400

Financial Aid Available
for Eligible Students

Approved Pivot Point Training

COFFEYVILLE CABLE TV

216 W 8th

251-6610

Featuring:

The Disney Channel
Home Theater Network

HBO
Cinemax

SONGS TAE KWON DO & YUDO



Monday-Wednesday-Friday
Hours: 6:00-8:30
251-8989

Chris McVey 119 W 7th
2nd Degree Black Belt Coffeyville, KS

KWIK STOP, INC.

890 Elm
Coffeyville, Kansas 67337



GOOD LUCK SENIORS 1987 MCBRIDE TV

211 W 8TH 316 251-7350
COFFEYVILLE

COFFEYVILLE MUSIC



"Our twenty-eighth year"

WARBURTON VALVE

Since 1956

(316) 251-9425

The Warburton Valve Company Inc

PO Box 583/1811 W 4th Coffeyville, KS 67337

CONGRATULA- TIONS CLASS OF 1987

Winston
REALTY

INSURANCE
Agency, Inc.

210 WEST NINTH STREET
COFFEYVILLE, KANSAS
67337

• Your Independent Agent •



*Opening
New Doors*

*The Choice of
A New Generation*



*Coffeyville, KS
251-2890*

BANK IV
COFFEYVILLE

BANK IV Coffeyville
8th & Walnut
Coffeyville, KS 67337
(316) 251-0200
Member FDIC

DJ'S TIRE
2006 WALNUT
COFFEYVILLE
(316) 251-4620

COFFEYVILLE REGIONAL MEDICAL CENTER



1400 West Fourth
Coffeyville, Kansas 67337
(316) 251-1200



THE COMMITMENT CONTINUES

For the past 37 years, Coffeyville Regional Medical Center has been dedicated to fulfilling the medical needs of area residents with a full service hospital. --Now their services are being expanded to help KEEP you well.

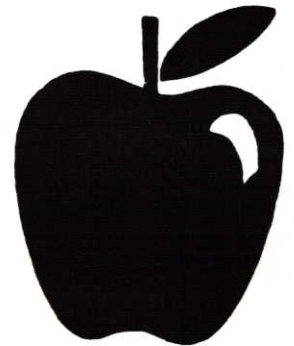

FITNESS CENTER

The large basement area under the new tower has been opened to community walkers and joggers so that weather need not interfere with exercise. Future plans include expansion of the fitness opportunities available in the center.

Aerobic exercise classes are available to the public at regular intervals.



EDUCATIONAL OPPORTUNITIES

Numerous community education programs are available to the public through Coffeyville Regional Medical Center's Education Department. These include programs on diabetes, Heart Care, Nutrition, Pre-Surgery Education, Child Safety, Cancer, Mammography, and CPR -- to name just a few.



FREEDOM FROM SMOKING CLASSES

A stop smoking class is available to smokers on a regular basis. Together with encouragement and education, participants learn how not to smoke, the psychological and physiological effects of smoking on the body and how to turn off the urge to smoke.



Butterfield's Family Restaurant

At Best Western Fountain Plaza
104 W 11th

Coffeyville, Kansas 67337

Best Wishes Class of '87

FOURTH STREET LAUNDRY & LINEN

1617 W 4th
251-3660

COFFEYVILLE STATE BANK

9th Willow
316/251-1313

Member FDIC

Best Wishes from . . .



*FARMLAND INDUSTRIES,
INC.*

Gene's TV Sales & Service
WE SERVICE WHAT WE SALE
705 E. 8th - 251-3900

RADIO SHACK
TELEVISIONS
CAR RADIOS
TAPE UNITS
SATELLITES
STEREOS

Parkersburg

PARMAC, INC.



Parmac, Inc.
12th & Oak
251-5000
Box 1149
Coffeyville

CONGRATULATIONS

to the

Class of '87

from ...

The Class

of 1936



SONIC

802 W 11TH

COFFEYVILLE

251-4460

HOURS:

9:30-11:00 Sun-Thurs
9:30-12:00 Fri & Sat

Roger A. Bruns

Ronald D. Wulf

**Ford-Wulf-Bruns
Funeral Service**

COFFEYVILLE, KANSAS

251-3100

Colonial Chapel
9th & Spruce

Edgewood Chapel
2400 Woodlawn



Brett Thomas ???

HEADLINES

UNISEX STYLE SALON

BEVERLY HOFFINE

310½ E. 8TH

COFFEYVILLE

251-0090



FUNK MANUFACTURING

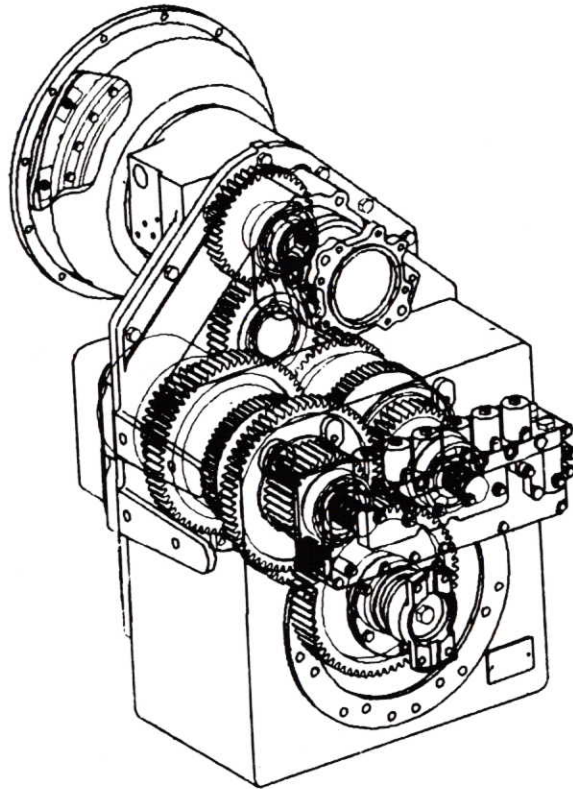

Manufacturers of Power Transmission Equipment

**EXTENDS BEST WISHES TO THE 1987
GRADUATING CLASS OF
FIELD KINDLEY HIGH SCHOOL**

CLARK GRAVES INS., INC.

Don Simmons, Agent

Coffeyville Office: 251-3550

Altamont Office: 251-5622

PIA Member

Professional Insurance Agents



*We specialize in Commercial & Farm Policies
We write all lines: Home, & Auto & Life
Complete Lines of Insurance.*

BOOSTER PAGE

*Linda's Beauty Barn
Ed & Dana Bordine
Bill & Charlotte Bowman
JoAnn & Leon Braschler
Mr. & Mrs. Don Brown
M.L. Breen
Roger & Charayne Bruns
Bob & Esther Buckner
Sue Carpenter
Terry & Virginia Chaffin
Tom & Diana Deenihan
Elite Appliance
Bob & Mary Lou Erickson
Bob Esch Pattern Shop
Joe & Carolyn Fernandez
Mr. & Mrs. Larry Fink
Keith & Barbara Fouts
Wayne & Norma Gaut
Calvin & Joanna Hallum
Gene, Yalala, Tina and Heather Hastings
Larry & Judy Hiner
Dr. & Mrs. B.E. Howenter*

*Mr. & Mrs. Tony Hoy
Gary & Donna Johnson
Dan Kinney
Mr. & Mrs. Thomas Kill
Phil & Mary Anne Logan
Neil & Mary Malone
Linda Malotte
JoLynn Hamrick McFerrin-Dan Hamrick
Mr. & Mrs. David Neale
Mr. & Mrs. Ed Neale
Jim & Delores Perkins-Doug Hitchcock
Larry & Carol Phillips
John & Chris Pierce
Jean & Buck Reardon
Jerry, Cheryl, and Melinda Rider
Jim & Catherine Riley
Ellis & Carolyn Roberson
Larry & Kathy Seigel
Buck & Barbara Walton
Jerry & Diane Watson
Gene & Mary Lou Weeks
Gene & Linda Wright*

Mr. & Mrs. Linford Wright

All ad pages designed
by Angela Neale

Business

United Automotive
401 West 8th
Open 7 days a week
(316) 251-1450

His & Hers Styling
Downtown Mall
114 W. 9th
(316) 251-4341

Town and Country Shop
"A Woman's Place is in our Store"
118 W 9th
Coffeyville, Kansas 67337
(316) 251-1070

East Central Gas & Pipe
3804 W. 8th
Coffeyville, KS 67337
(316) 251-7510

Adventure Land Video
811 West 11th
Coffeyville, KS 67337

OFFICE DIAL
(316) 251-4280



PRESSURE CAST
PRODUCTS INC.

300 E. 4TH / BOX ⁵⁶³ / COFFEYVILLE, KANSAS 67337

DON MCFERRIN
PRESIDENT

Tony's Bakery
1223 W. 8th
Coffeyville, KS 67337
(316) 251-7106

Chiropractic Arts Center
Dr. Clarke Bumgarner
Dr. David Bumgarner
509 Maple
Coffeyville, KS 67337

316-251-3004

The Coffeyville Antique Mall

TUES. - SAT. 10:00-5:00

122-124 W. 9TH

COFFEYVILLE, KS 67337

Newby Veterinary Clinic
Rt. 1 Box 84A
Coffeyville, KS 67337

Edgewood Flower Shop
and Greenhouse

1412 W. 8th
Coffeyville, KS 67337

251-5310

Columbia Drug
131 West 8th
Coffeyville, KS 67337
(316) 251-1150

Hours 8-6

Mon-Sat

Dairy Sweet
2204 Walnut
Coffeyville, KS 67337
(316) 251-4370

Weinberg's Western Wear
912 Walnut
Coffeyville, KS 67337

PAM'S PLACE

Dearing, Kansas
"Full Service Salon"
Men-Women-Children

948-6319

Super cuts for
Guys & Gals

Class Act
Full Service Salon

(316) 251-2088

1814 W 5th

FOY REFRIGERATION CO., INC.

820 West 8th
Coffeyville, Kansas 67337

Office: 251-4690
Home: 251-1666

KQQF- P.O. BOX 566

DOUBLE Q
92 ----- KQQF

Coffeyville, KS

251-3800

Angleton Speedy Mart
1110 E 5th

Mon-Fri
6-12

Sat & Sun
7-10

A BIG Thank you to all the
businesses who supported the
Yearbook staff.

Patrons

General Index

Jennings, Lyman-11-27, 44, 121
 Jennings, Parris-12-27, 59, 84, 100
 Johnson, Kelli-11-121
 Johnson, Kim-12-32-33, 74-75, 101
 Johnson, Latisha-12-42, 48, 101
 Johnson, George-10-130
 Johnson, Martinie-10-130
 Johnson, Melissa-11-51-52, 121, 164
 Johnson, Sam-10-130
 Johnson, Shaney-10-130
 Johnson, Stacey-12
 Jones, Anthony-10-131
 Jones, David-11-121
 Jones, Sherman-T-69, 137
 Jones, Virginia-12-101
 Jones, James-10-27, 55, 131
 JOURNALISM-78-79
 JUNIOR OPENER-114-115
 JUNIORS-116-125

K

Keep, key, kickoff,
 kid, kiss, knot,
 know, knowledge, kola

Kastler, Mike-12-101
 KAYETTES-56-57
 Kengle, Mary-T-72, 137
 Kent, Gina-10-51, 131
 Kent, Rusty-11-121
 KGGF-156
 Kill, Tom-10-31
 Kimball, Steve-T-76-77, 137
 King, Mike-11-74-75, 121
 King, Rita-10-131
 Kinney, Dan-11-1, 27, 79, 121
 Kiser, David-12-54-55, 101
 Knight, Curtis-12-55, 101
 Knight-Kim-11-121
 Kox, Eddie-10-131
 Kwik Stop-148

L

Labor, lace, lady,
 language, late, laugh,
 learn, lie, listen

Lamb, Anna-10-131
 Lantz, Bryan-10-131
 Lantz, David-10-55, 131
 Layton, Anne-10-57, 74-75, 131
 Ledman, Rosslynn-10-131
 Lee, Lance-11-63, 121
 Lee, Mike-T-62, 137
 Lendall, Cheryl-12-51, 53, 57, 74-75, 101
 Lendall, Marilyn-10-131
 Letterman, Travis-10-131
 Lewis, Wesley-11-121
 Lweman, Jeff-11-74-75, 121
 Liebert, Mary-10-74-75, 131
 Lind, Michael-10-131
 Lipe, Terri-10-131
 Little, Joni-12-46-49, 51, 58, 95, 101
 Llewellyn, Kellie-10-131
 Lockaby, Angela-11-55, 76, 121
 Locke, Cara-10-34-35, 56-57, 67-68, 131
 Locke, Matt-12-10-11, 27, 101
 Logan, Christie-10-41, 48-49, 131
 Logan, Jennifer-12-57, 79, 101
 Logelin, Lynn-T-78-79, 137, 164
 Long, Jim-12-55, 101
 Lowrance, Tom-12-81, 101
 Lukens, Chuck-10-131
 Luker, Melissa-11-48, 121
 Lumley, Dorothy-T-138
 Lunblad, Sally-C-138
 Lynn, Jody-10-55, 60-61, 131
 Lynn, Mike-10-131

M

Mad, magazine, mail,
 majority, make-up, male,
 mall, man, margin

Malone, Gayla-12-8, 51, 79, 102, 145, 164
 Malotte, Tabitha-12-79, 102
 Manley, Matt-12-76-77, 102
 Maples, Susan-12-102
 Maritt, Lisa-12-51, 53, 79, 102
 Marlow, Alan-10-131, 139
 Marlow, Shawn-11-55, 121
 Martin, Kathy-12-102
 Martin, Regina-12-40, 48-49, 102
 Marshall, Craig-10-131
 Marshall, Gwendlyn-11-121
 Marshall, Kim-11-121
 Marshall, Phillip-11-121
 Martindale, Stephanie-10-32, 74-75, 131
 Martindale, Terry-11-74-75, 79, 121, 37
 Mashburn, Jill-10-74-75, 131
 Mason, Shannon-10-27, 44, 131
 MATH-68-69
 Matthews, Ramona-12-43, 102
 Mayo, Jon-12-54-55, 102
 McBeath, Tina-10-131
McBrides Appliance-148
 McClenning, John-12
 McCurry, Amy-10-32, 56, 81, 131
 McDaniel, Karen-10-56-57, 74-75, 131
 McFerrin, Donya-11-23, 30-31, 63, 74-75,
 121
 McGarvery, Cori-12-102
 McGarvey, Kasey-10-131
 McGill, Patricia-10-131
 McGuire, Tracey-11-32, 52-53, 121
 McHenry, Cartricia-10-74-75, 131
 McKellips, Rene-12-16, 57, 95, 102
 McMurray, Chad-12-21, 23, 44-45, 102
 Meador, Ruby-T-138
 Medlock, Patricia-11-121
 Medsker, Marcy-12-57, 79, 103
 Mehl, Shannon-T-138
 Merrell, Tonya-12-12, 103
 Merriman, Michelle-12-17, 52, 57, 78-79,
 103, 164
 Meisner, Sharon-11-63, 74-75, 121
 Miller, Jayson-10-74-77, 131, 39
 Misch, Cami-10-68, 74-75, 127, 131
 Mitchell, Holly-10-14-15, 52, 57, 131
 Mitchell, Kenny-10-57, 74-75, 131
 Mitchell, Kim-11-76-77, 121
 Moore, Shelly-11-122
 Moorehead, Brett-12
 Moraine, Lisa-12-103
 Morgan, Norma-10-55, 84, 131
 Morgan, Tom-11-55, 122
 Morris, Brad-11, 122
 Morris, Cheryl-11-74-75, 122
 Morris, Shawn-11-58, 122
 Morris, Travis-10-55, 131
 Morrison, Janice-10-76-77, 131
 Morrow, Chad-10-131
 Morrow, Paul-10-131
 Moses, Jennifer-10-55, 131
 Moses, Tracie-11-122
 Murdock, Larry-T-57, 64, 138
 Murry, Robert-10-80-81, 131

N

Nag, name, nappy,
 neat, nerd, nervous,
 nice, night, number

Naden, Amy-12-48-49, 51, 103
 Nadolny, Stephanie-10-15, 48, 52, 57, 105,
 131
National Electric-146

National Oil Processing-146
 Nave, Glen-11-122
 Neal, Englund-11-122
 Neale, Angela-11-1, 35, 78, 122
 Neely, Eugene-T-95, 138
 Nett, Sherri-10-79, 131, 164
 Newton, Andre-10-27, 106, 131
 NHS-50-51
 Nichols, Kelley-10-131
 Nolen, Wes-11-79, 122
 Nordin, Rebecca-10-57, 81, 131
 Norfleet, Chris-11-18-19, 119, 122
 Norfleet, Susan-11-65, 119, 122
Nu-Way-150

O

Obey, offense, o.k.,
 omit, once, open,
 oral, organize, out

Oakley, Donna-12-54-55, 63, 74-75, 103
 O'Connell, Lisa-10-131
 Oerman, Angela-10-131
 Oneslager, Sheila-11-122
 Ortolani, Shelly-12-40, 48-49, 104
 Overton, Brad-11-122
 Owen, Jim-T-138
 Owen, Lyndia-10-131
 Owens, Neil-12-23, 89, 104, 36-37

P

Page, party, pen,
 pencil, person, picture,
 please, principal, project

Page, Cardian-11-51, 53, 122
 Page, Chad-12-104
 Page, Melissa-10-131
 Palmer, Brad-10-27, 57, 131
Parent Patrons-157
 Parker, Paul-10-31, 52, 131, 37
Pharmac Inc.-153
PARTIES-12-13
 Pate, Mark-12-23, 26-27, 104, 106
 Payton, Selma-T-138
 P.E.-184-185
 Pearson, Ronnie-10-131
 Peirce, Brian-10-132
 Peirce, Bruce-12-9, 74-75, 104, 164
 Pendleton, Brenda-12-104
PEOPLE DIVISIONAL-86-87
Pepsi-Cola-149
 Peyton, Sherri-10-55, 132
 Phelan, Kyle-10-132
 Phillips, Alan-10-131
 Phipps, Alyson-10-132
Photography by Keenans-151
 Pierce, Toby-11-122
 Pippin, Debbie-12-32-33, 50-51, 103-104
 Polk, Becky-12-104
 Polk, Lisa-12-104
 Pomrenke, Lori-12-15, 57, 79, 104
 Pool, Kim-12-40, 46-49, 51, 104
 Pope, Randy-11-55, 122
 Potter, James-12-104
 Powell, Melissa-12-51, 53, 57, 74-75, 105
 Powell, Tina-10-132
 Price, Lana-10-68, 132
 Prince, Jeff-11-27, 122
 Pugh, Lisa-12-105
Pyrochem-146

R

Radio, read, red,
 remark, remark, remember,
 repay, riddle, ring

General Index

Ralls, Sharion-T-138
 Ransom, Shon-12-13, 41, 105, 39
 Ray, Darren-10-132
 Raymond, Ronnie-10-132
Read's Department Store-143
 Reardon, Lora-12-48-49, 105
 Reardon, Randy-12-54-55, 105, 112, 9
 Reed, Deborah-12-105
 Reed, Liz-12-9, 12-13, 76-77, 95, 100, 106,
 111
 Reese, Brian-10-132
 Reeves, John-12-58, 106
 Regan, Mary-T-73, 138
 Reinecker, Nancy-L-138
 Reister, Dee-12-106
 Reister, Troy-10-132
 Reynolds, Elizabeth-T-138
 Reynolds, Michelle-11-53, 74-75, 122
 Richards, Shari-T-138
 Richardson, Amy-10-57, 74-75, 132
 Richardson, Brian-10-27, 132
 Richardson, Jeri-T-138
 Richardson, Ned T.-P-138
 Richey, Tom-11-122
 Ricks, Cordell-11-122
 Rider, Mindy-11-74-75, 78-79, 122, 164
 Riley, Chris-12-27, 92, 106
 Riley, Richy-12-27, 106
 Rinkenbaugh, Susan-11-122
 Roberson, LaTisha-10-132
 Roberson, Tom-12-63, 74-75, 88, 106, 18
 Robison, Melanie-10-53, 81, 132
 Roeder, Valerie-11-122
 Roland, Sean-11-31, U1, 122
 Ross, Darcey-10-56-57, 80-81, 132
 Roush, Jamie-11-58, 122
 Rowe, Rhonda-11-122
 Rowland, David-12-107
 Ruark, Lisa-12 107
 Ruark, Teresa-11-57, 76-77, 122
 Runyon, Carol-10-74-75, 132
 Rupp, Cynthia-T-138
 Rutherford, Gina-11-74-75, 122
 Rutledge, Kenny-11-122

S

Sac, sad, schmuck,
 seat, secretary, sensible,
 shoe, sigh, silence

Sales, Bernice-10-132
 Salway, Stephanie-10-132
 Samora, Jimmy-12-107
 Sanders, Brenna-11-123
 Sanders, Jon-11-44, 123
 Sanders, Marlene-12-18-19, 24-25, 30-31, 42-
 43, 107
 Sanders, Melissa-12-57, 107, 156
 Sanford, Pete-10-132
 Sauer, Mike-11-123
 Schenck, Chad-10-70, 132
 Schoonover, Michelle-12-51, 53, 107
 Schroeder, Darren-12-79, 85, 105, 107, 39,
 164
 Schulz, Tim-10-132
SCIENCE-70-71
 Scott, Haile-11-132
 Scott, Marshon-10-132
 Scott, Shoshana-10-76-77, 132
 Scourten, Tracy-11-123
 Seaton, Darnel-12-58, 107
 Seaton, Shonya-10-132
 Seger, Jennifer-11-41, 46-49, 51, 57, 123
 Seger, Joyce-AD-138
 Seigel, David-11-27, 123
Selcho Rentals-147
 Senecal, Theresa-11-32, 123
SENIOR FAVORITES-8-9
SENIOR OPENER-88-89
SENIORS-90-113
 Shade, Pierre-11-123

Shields, Corey-10-27, 132, 39
 Shoats, Hershel-12-51, 58-59, 76-77, 83, 107
 Shoats, Joyce-12-95, 107
 Shores, Debbie-10-55, 132
Sidney's Hairdressing College-148
 Sizemore, Lannie-11-123
 Sjolander, Angela-10-74-75, 132
 Sjolander, Timber-11-27, 44, 82, 123
 Slaton, Lena-10-57, 127, 132
 Slaton, Michelle-10-132
 Smith, Betty-12-107
 Smith, Brian-12-9, 23, 62, 74-75, 108, 37, 18
 Smith, Kim-12
 Smith, Lisa-12-9, 10-11, 32-33, 50-51, 108, 19
 Smith, Valorie-11-123
 Smith, Wesley-11-27, 29, 123
 Smithson, Stephen-12-76, 108
 Smoot, Jason-12-108
SOCIAL SCIENCE-72-73
 Sommers, Darrel-C-138
Sonic-154
Song's Tae Kwon Do-148
SOPHOMORE OPENER-126-127
SOPHOMORES-128-133
SPANISH-52-53
SPIRIT SQUAD-48-49
 Splechter, Steve-10-132
SPORTS DIVISIONAL-24-25
 Sprague, Dorothy-10-65, 132
 Sprague, Robert-11-123
 Sprague, Sonny-12-108
 Stair, Curtis-11-123
 Starnes, Mike-11-124
 Stair, Glenn-10-132
STATE WINNERS-22-23
 Staudt, Joe-T-138
 Staudt, Sue-T-62
 Stevenson, Sherry-12
 Stewart, Jeff-11-44, 124
 Stewart, Shelly-11-10-11, 23, 30-31, 42, 51,
 53, 65, 115, 124
 Stewart, Stan-12-27, 108
 Storey, Tammy-11-78-79, 124, 164
 Strimple, Russ-10-132
 Stroud, Chad-10-132
 Stroud, John-11-124
 Stuckey, Amy-10-57, 132
STUCO-50-51
STUDENT LIFE-4-5
 Sutton, Winifred-10-132
 Swigart, Mike-12-55, 58, 109
 Sykes, Donnie-11-27, 74-75, 124

T

Test, tease, time,
 track, table, top,
 thought, theory, tent

Tate, Kelli-11-48, 124
 Taylor, Jill-12-109
 Taylor, Joe-11-63, 124
 Tedstrom, Stacy-12-109
THEATER-80-01
THEME-2-3, 172
 Therrien, Alfred-10-132
 Thomas, Brett-11-53, 63, 74-76, 124
 Thomason, Alice-11-124
 Thompson, Mary-11-124
 Thompson, Misty-10-132
 Thompson, Tamara-12-51, 53, 109
 Thompson, Tisha-10-57, 132
 Thurman, Jessie-11-124
 Tickle, Allen-11-76-77, 124
 Tickle, Lisa-12-76-77, 109
 Timmerman, Shawn-10-132
 Tippen, Trent-11-124
 Tipton, Angela-10-42, 76-77, 132
TITLE-1
 Toliver, Julie-11-124
 Tomlin, Rochelle-10-132
 Toney, John-12-109

Trotter, Randall-11-124
 Tosh, John-10-132
 Tosh, Robbin-12-109
 Trahan, Melissa-12-53, 65, 109
 Triebel, Michelle-10-55, 132
 Triebel, Shane-10-55, 132
 Trotter, Darren-10-132
 Trotter, Gary-10-132
 Troxel, Bill-10-27, 132
 Trussell, Future-10-42-76-77, 132
 Turner, Marlin-10-84, 132, 39
 Turner, Toby-10-132
 Turner, Susan-11-124

U

Under, unity, ultra,
 urgent, upset, up,
 usage, utility, used

Ulibarri, Jeff-11-31, 84, 124
 Ulibarri, Jim-12-85, 109, 18
 Underwood, Kelli-11-124
 Upton, Charles-10-132
 Uy, Rosalynda-10-32, 52, 81, 132

V

Vacant, valley, valid,
 value, vanity, veal,
 vogue, verbal, verse

Vacca, Danny-12-23, 51-52, 109, 37
 VanBuren, Melody-10-132
 VanBuren, Todd-11-55, 124
 Vanderford, Bobby-11-44, 58, 124
 Vanderford, Tommy-10-132
 Vanderlinden, Angie-10-32, 42, 133
 VanTassel, Peri-T-53, 139
 Vargas, Bobby-11-27, 70, 124
 Vaughan, LaShawn-11-124
 Vaughn, LaDonna-10-16-17, 74-75, 133
 Vaughn, Ollie-10-133
VICA-58-59
 Victory, Grady-12-22-23, 62, 68, 81
 Victory, Shawn-11-124
 Victory, Shelly-12-32, 42-43, 51, 109
 Villins, John-12-27, 109
VOCAL MUSIC-76-77
 Voelzke, Erin-12-57, 73, 95, 110
 Volelske, Claudia-T-139
VOLLEYBALL-32-33
 Vogt, Brandy-10-41, 48-49, 51, 133
 Volk, Julie-10-79, 133
VO-TECH-82-83
 Vowell, Tony-12-55, 110

W

Writing, wrong, whiz
 worry, world, woe,
 women, wink, wild

Waddle, Stephen-11-124
 Wade, Roy-12-58
 Wadkins, Patty-10-74-75, 133
 Waggoner, Karen-12-74-75, 110
 Walker, Howard-11-55, 76-77, 124
 Wallace, M. Brannen-11-124
 Wallis, Judy-10-32, 133
 Walton, Melanie-12-110
 Walton, Tara-12-14-15, 21, 34-35, 52-53, 95,
 100, 110, 145, 37
 Walton, Tara-10-133
Warburton Valve-149
 Ward, Mike-11-124
 Ward, Mike-11-27, 124, 39
 Warren, Jason-10-133

Warren, Tamara-11-125
 Wassom, Michelle-11-42, 57, 125
 Watson, Paulette-12-32-33, 51, 57, 76-77, 81, 110, 164
 Watson, Thomas-10-133
 Watts, Jim-T-139
 Watts, Marsha-10-84, 133
 Weber, Christina-10-133
 Webster, Marc-T-72, 135, 139
 Weeks, Julie-11-125
 Wells, Scott-10-31, 52, 69, 133, 37
 Whalen, Dawn-T-139
 Whalen, Patrick-T-84, 139, 37
 Wheeler, Chad-10-31, 133
 Wheeler, Teresa-12-110
Winston Insurance-149
 White, Amanda-12-53, 74-75, 79, 110
 White, David-11-13, 51, 125
 White, Lisa-12-48, 55, 110
 White, Stephanie-12-48, 51, 57, 110
 Wilkerson, Stacy-10-57, 60-61, 133
 Wilkinson, Lisa-10-133
 Wilkinson, Mike-11-23, 74-75, 125, 36-37
 Willard, Brenda-10-57, 74-75, 133
 Williamson, Charles-10-133
 Wilson, Alisha-11-44, 51, 125
 Wilson, Andrew-12-22-23, 81, 95, 110
 Wilson, Brian-12-110
 Wilson, Eddie-10-55, 84, 133
 Wilson, Patrick-10-56-57, 133
 Winston, Laura-10-48, 57, 71, 133
 Winston, Paul-12-8, 22-23, 51, 81, 111
WINTER HOMECOMING-18-19
 Wishall, Angela-10-57, 74-75, 84, 133
 Wishall, Teresa-10-60-61, 74-75, 133
 Wolf, Patty-12-111
 Wood, Julie-10-12, 133
 Wood, Scott-11-27, 84, 125
 Woolfolk, Scott-11-55, 125
 Wollard, Charlette-10-133
WRESTLING-44-45
 Wright, Annette-10-76-77, 133
 Wright, Cindy-10-32, 133
 Wright, Marcy-12-32, 95, 111
 Wright, Teresa-12-53, 79, 111
 Wright, Tricia-10-48, 133
 Wright, Willy-10-31, 133

Y

Youth, yen, yet, yesterday, yes, yard, yogurt, yuppie, yea

Yeubanks, Martha-11-125
 Young, Kip-10-55, 133

Z

Zany, zinc, zero, zest, zoom, zither, zoo, zoology, zodiac

Zeigler, Deane-T-139

COLOPHON

Living up to the standard became the task for the 18 staffers and the editors in chief, Becky Bordine, and Tosha Hoy, of the 1987 Field Kindley staff, as they pushed to get "The Gold Standard" finished in time for a spring delivery.

Book sales ran for two weeks during January with the book selling for \$20 to students and \$10 to teachers. Staff members ordered 500 books.

Mrs. Lyn Logelin, adviser for the first year, worked with two editors to adapt and design spreads for use in the entire book. The staff developed the cover.

The cover custom stamped on deep purple #449 with applied gold foil #527. The contents were printed on front endsheet and "The Gold Club" on the back endsheet. 80 pound gloss was the paper stock used.

The body was set in 11/12 Palintino and captions were in

8/9 Palantino. Caption headlines were in 12 point Palantino, while other headlines varied from 36 point Palantino to a Pendry script. 12 point Palantino was used for folio tabs and page numbers.

Pictures that were not taken by the yearbook photographers were provided by the Coffeyville Journal, Tony Hoy and Bonnie Smith. The Coffeyville Journal provided football pictures for pages 26-29. Some homecoming pictures on pages 10-11 were provided by Tony Hoy. The staff would like to thank those people for their pictures.

After being produced at Field Kindley Memorial High School by the yearbook staff, the 1987 book was printed in Topeka, Kansas by the Jostens Printing and Publishing Division. Production was coordinated by Mr. Roger K. McCune, customer consultant from Jostens.



Second semester yearbook staff from left to right, first row: Brenda Davison, Tosha Hoy, Gayla Malone, Tammy Storey, Joe Fernandez, Mindy Rider and Michell Merriman. Second row: Melissa Johnson, Sherri Nett, Bruce Peirce, Craig Hillman, Darren Schroeder, Paulette Watson and Mrs. Lynn Logelin.

Autographs

Autographs

Autographs

SENIOR • C

"Then one day she came to Field Kindley High School, and met these people who were really cool." Debators/Forensicators, Paulette, Shelly and the "Risk" gang, thanks for being friends. Paul-I LOVE YOU!

Good luck to all the class of '87. I'm gonna miss everyone. Even if some of the friendships fade away, the memories will always stay. Thanks for the memories: Mama, Lisa (both), Jr., Davey, Mel. LUV Pennie

High School has been great! I want to thank everyone who helped me to grow and find out what things are really like in the world (you know who you are!) I love you all!
Lisa Conger

It's been a great year! I'd like to thank all my friends, teachers, and family for making this year the best. Janie—Thanks for everything and especially for just being you. Good Luck to the class of '87. — Tamara Thompson

I'd like to take this opportunity to thank the ACTS club for voting me president. I had a great year and all my friends made it better, & thanks Boyd, Anne, Cara, Tammy, Toni, & Amy. But most of all I thank God. —Rene

Aw right Bet —Chad McMurray

PJ, Lisa, & Leslie: Thanks to you guys! My senior year has been quite a learning experience." I hope things go well for all of you, no matter where you go! I love you all—oooh!

Jeff, (Skeeter)

I know we've had some rough times this year. I'm sorry about what's happened. You mean everything to me. You're the Greatest and I love you. -Your best Friend, Bryan Fahler

Rae thanks for always being there. Sometimes I couldn't of made it without you. Thanks to everyone who made my Senior year special, Especially Mom and Dad. Good Luck Class of '87. -Tammy Eden

My senior year was the best! I want to thank all my teachers, Jen, Shelly, Kris, and Erin for all the good times. Good Luck to the class of '87. Thanks Mom and Dad, I love you guys! —Tosha Hoy

Thanks Brian, Mom and Dad for all the love and help. I never could have made it without you. Jimmy Lee, hang in there, we're almost out. It's great havin' you as a brother! —Janet Bloomcamp

Thanks to the cheerleaders for making my most special memories. Also, thanks to Tosh, Kris, Sar, Kim, & Shel for all the great times, and for listening and understanding, and to Mom and Dad for loving me. I love you all. —Jennifer Erickson

To All Juniors: Being a senior is not so great. You may experience some ugly hate! It means the end of the track. It's too late, now, you can't turn back. Being a senior isn't the end of time. It simply means a new ladder to climb. The last year to some will make them sad. Not for me—I'm very glad! —Matt Locke

CLASS • OF • 1987



I love you Neal. -Amy

WOOPEE Marietta you were great, but were glad we're not the class of '88. Good luck to all the seniors.

I'd like to take this opportunity to thank God for being so good. To my parents for their love and not making me work for anything. To my brothers and sisters for prayers and encouragement. -Ramona Matthews

To my family and Kevin- Thanks for sticking by me. And guess what, I made it, and I'm proud of myself. I want to say to my friends, keep in touch and party!
Love, Mel-Mel

My senior year has been great, and I owe it all mainly to my mom for all her support, my teachers, friends, and the "crew." Pennie, you're the best friend ever! Thanks! And Wrestlers, the word for today is: Word! —Jr. Clairborne

To Moody and Radio Melbourne: Thanks for being my best friends/ 'lawyers.' I hope we'll keep in touch after we've gone our separate ways. "Caroline . . . is gone but the jokes the same." To FKHS: Ireland Awaits!

Were the best we'll ever be, but we'll live our lives and treasure the memory of how we grew through failures and atonements while all along we knew it would only last a moment. -Janie Hartwig

I thank God for all my accomplishments. Thanks also to Marcy, Chris, Andy, and to Boyd for being my big brother. Tina, I'll miss you next year so keep in touch. Good luck to the class of 1987. -Jennifer Logan PTL

My years at FKHS were very special. Thanks to my friends, teachers, & parents. Thanks to the cheerleaders for their friendship and support. Brian, thanks to making my senior year the best. I love you all! —Joni Little

To the class of '87, it's been fun! To Clammy, Corkel, Airhead, and everyone else. You're the best. And to Mom, thanks for everything. I love you all. —Lisa

A special thanks to Mom and Dad for their love and support and to Tom for his love and understanding. To the teachers and friends "Thank you." Good Luck, seniors '87. —Tollie Arnold

Pat, I love you! You're the center of my life. Mom and Dad, I love you too. Thanks for always being there. Jen and Tosh, my best friends always. Good Luck class of '87. —Kristi Chaffin

My senior year has been a blast! Toshi, Tonya, Brenda, Keri, & Bert, your friendship has meant so much to me. I'll never forget you guys! Good Luck to the class of '87. — Erin Voelzke

Quiet Hallways signal the end of another school year and a century of students.

The Gold Standard

For some, the gold standard meant a economic yardstick, but the people of Coffeyville used another: FKHS. Increasing graduation requirements, winning first place trophies in debate, building a sports dynasty, and just making a common event seem golden, quickly became standards. After a fun-filled spring break, mind-bending finals and finally graduation, the 677 students of FKHS proved it . . .



The 1937 carnival celebrities.



*Nothing Else
Is Like Real Gold*



The Gold Standard — nothing symbolized it better than Field Kindley High School.

