

FIELD MANUAL and DRILL MANUAL FOR THE NAVY JUNIOR RESERVE OFFICERS TRAINING CORPS (NJROTC)



CADET FIELD/DRILL MANUAL

(10th Edition)

NAVEDTRA 37116-J

JUNE 2014

NSN 0509LP1141718



0 5 0 9 L P 1 1 4 1 7 1 8

INTENTIONALLY LEFT BLANK

NAVAL JUNIOR RESERVE OFFICERS TRAINING CORPS

CADET FIELD MANUAL

TABLE OF CONTENTS

Preface iv

Acknowledgments v

Core Values of NJROTC vi

CHAPTER 1: NJROTC UNIFORM REGULATIONS 1-1

 1-1 The Uniform 1-1

 1-2 General 1-1

 1-3 The Wearing Of The Uniform 1-2

 1-4 Personal Appearance and Grooming 1-2

 a. Men 1-2

 b. Women 1-4

 1-5 Uniform Composition 1-6

 a. Male Uniforms 1-6

 b. Female Uniforms 1-8

 a. Uniform Appearance, Cleanliness and Maintenance 1-8

 b. Uniform Composition 1-11

 1. Males 1-11

 a. Navy Service 1-11

 a. Service Dress Blue 1-13

 a. Working Khaki 1-15

 2. Females 1-17

 a. Navy Service 1-17

 a. Service Dress Blue 1-19

 a. Working Khaki 1-21

 1-6 Male Necktie, Black. 1-23

 1-7 NJROTC Uniform Insignia and Devices 1-24

 1-8 Awards and Decorations 1-27

CHAPTER 2: NJROTC RATES/RANKS AND U.S. NAVY RATES/RANKS 2-1

 2-1 NJROTC Rates, Ranks, and Assignments 2-1

 2-2 Navy Rates and Ranks 2-4

CHAPTER 3: MILITARY CUSTOMS, COURTESIES, ETIQUETTE AND CEREMONIES 3-1

 3-1 General 3-1

 3-2 The American Flag and Flag Etiquette 3-1

 3-3 Flag Courtesies 3-3

 3-5 Ceremonies 3-5

 3-6 Reviews 3-6

 3-7 Street Parades 3-11

CHAPTER 4: PERSONNEL INSPECTION 4-1

 4-1 General 4-1

 4-2 Forming for Inspection 4-1

 4-3 Inspecting Officer's Tour 4-2

 4-4 Inspection Guidelines 4-3

CHAPTER 5: REQUIREMENTS FOR THE NJROTC PHYSICAL FITNESS RIBBON 5-1

 5-1 Introduction 5-1

APPENDIX 1: MILITARY CHAIN OF COMMAND 6-1

APPENDIX 2: ORDERS TO THE SENTRY 7-1

APPENDIX 3: MARINE CORPS RATES AND RANKS 8-1

PREFACE

The purpose of the "NJROTC CADET FIELD AND DRILL MANUAL" is to combine all the information on military drill ceremonies and uniform regulations into one distinguishable text. You may come to think of this Field Manual as the "guide" for the military aspects of your association with the NJROTC Program. This manual is based on current Naval Service Training Command (NSTC) Instructions. In the event there is a difference, the most current NSTC 1533.9 publication will apply.

The reasons why military drill specifically is important for you to learn during your time in the NJROTC are very basic. If you keep them in mind during your drill and parade activities, these reasons will become a part of you whether you are the leader or the follower. Here are the purposes of military drill:

1. To enable a leader to move his/her unit from one place to another in a standard and orderly manner.
2. To teach discipline by instilling habits of precision and automatic response to orders.
3. To increase the confidence of cadets through the exercise of command, and by giving proper commands, and by the control of drilling cadets.
4. To give cadets an opportunity to handle drill rifles.

The uniform regulations chapter of this manual is important. From this chapter you will learn the importance of attention to detail.

While enrolled in the NJROTC program, you will be instructed and drilled in all applicable safety precautions and procedures. Your naval science instructor will maintain situational awareness, and ensure that safe practices are complied with at all times during your training in NJROTC activities. An immediate "**Training Time Out**" (TTO), shall be called whenever you or your naval science instructor experiences apprehension concerning training safety. The TTO is explained in the military drill chapter on page DM-1.

Note: When used in this publication, the terms "HE," "HIM," "HIS," and "MEN" represent both the masculine and feminine gender unless otherwise stated.

ACKNOWLEDGMENTS

We wish to express appreciation to several individuals who contributed to the successful completion of this manual. Thanks are due to the members of the NJROTC Curriculum Advisory Committee, a select group of naval science instructors who represent the 11 NJROTC geographical areas in the United States. Considerable time, attention to detail, and enthusiastic support came from these individuals. Likewise, a number of other naval science instructors in the program provided additional assistance, contributions, and many suggestions with respect to this effort.

THE CORE VALUES OF THE NAVY JUNIOR RESERVE OFFICERS TRAINING CORPS

As a member of the NJROTC, we are dedicated to the Core Values of HONOR, COURAGE and COMMITMENT to build the foundation of trust and leadership upon which our NJROTC unit is based. These are the principles which will give us strength and guide us in our daily activities; we will be faithful to these Core Values as our abiding duty and privilege.

* * * * *

I AM ACCOUNTABLE FOR MY PERSONAL BEHAVIOR. I WILL BE MINDFUL OF THE PRIVILEGE I HAVE TO SERVE MY FELLOW NJROTC CADETS AND CLASSMATES.

HONOR; "I will bear true faith and allegiance...." Accordingly we will: Conduct ourselves in the highest ethical manner in all relationships with peers, superiors and subordinates; Be honest and truthful in our dealings with each other, and with those outside of NJROTC; Be willing to make honest recommendations and to accept those of junior personnel; Encourage new ideas and deliver the bad news, even when it is unpopular; Abide by an uncompromising code of integrity, taking responsibility for our actions and keeping our word; Fulfill or exceed our legal and ethical responsibilities in our public and personal lives twenty-four hours a day. Illegal or improper behavior or even the appearance of such behavior will not be tolerated. We are accountable for our school, classroom, and personal behavior.

COURAGE IS THE VALUE THAT GIVES ME THE MORAL AND MENTAL STRENGTH TO DO WHAT IS RIGHT, WITH CONFIDENCE AND RESOLUTION, EVEN IN THE FACE OF TEMPTATION OR PERSONAL ADVERSITY.

COURAGE; "I will support and defend...." Accordingly, we will: Have the courage to meet the demands of our NJROTC unit when it is demanding, or otherwise difficult; Make decisions in the best interests of the NJROTC unit and the school, without regard to personal consequences; Meet these challenges while adhering to a high standard of personal conduct and decency; Be loyal to our NJROTC unit and our fellow cadets and classmates ensuring the resources entrusted to us are used in an honest, careful, and efficient way.

THE DAY-TO-DAY DUTY OF EVERY MAN AND WOMAN IN THE NJROTC PROGRAM IS TO JOIN TOGETHER AS A TEAM TO IMPROVE THE QUALITY OF OUR UNIT, OUR FELLOW CADETS AND CLASSMATES, AND OURSELVES.

COMMITMENT; "I will obey the orders...." Accordingly, we will: Demand respect up and down the chain of command, care for the safety, professional, personal and spiritual well-being of our fellow cadets and classmates; Show respect toward all individuals without regard to race, religion, or gender; Treat each person with human dignity; Be committed to positive change and constant improvement; Exhibit the highest degree of moral character, technical excellence, quality and competence in what we have been entrusted to do.

These are the CORE VALUES of the Navy and the Naval Junior Reserve Officers Training Corps.

CHAPTER 1: NJROTC UNIFORM REGULATIONS

1-1 THE UNIFORM

- a. The Navy Junior Reserve Officers Training Corps is one of the uniformed JROTC programs. The uniform is an important element in the morale, pride, discipline and effectiveness of the NJROTC program in your school. It is important for NJROTC cadets to maintain a high standard of dress and personal appearance. The key elements are neatness, cleanliness, safety and military image. The purpose of this section in the Cadet Field Manual is to acquaint you with the wearing of the Navy Junior Reserve Officer Training Corps uniform.
- b. The military uniform is a symbol of the nation's defense forces. It projects an image of devotion to duty in the service of one's country. The word "uniform" comes from a combination of two Latin words, unus and forma, which means "one form." Thus the word "uniform" suggests a distinctive mode of dress. In ancient times military dress acquired a certain degree of sameness, but in a much different design from the modern military uniforms. They were, nevertheless, military uniforms in the sense that all the soldiers looked alike. To this extent we assign the origin of the military uniform to an early date in western civilization.
- c. The uniform worn by the Navy Junior ROTC cadets is the same, with certain exceptions, as that worn by active duty Navy personnel. Cadets do not wear commissioned officer rank insignia or sleeve braid. Uniform articles must not be worn with other civilian clothing nor should they be loaned to other classmates who are not members of the Navy Junior ROTC program. You are obligated to wear the uniform properly and proudly, and in doing so, you uphold the dignity of the Navy, your NJROTC unit, fellow cadets, and yourself.

1-2 GENERAL

- a. **Smartness.** Wearing the Navy uniform should be a matter of personal pride to all NJROTC Cadets. Your dress and conduct shall be such as to reflect credit upon your NJROTC unit, your school, your community, the Navy and your country. Caps shall be worn squarely on the head, with the bottom edge horizontal. Shoes shall be kept well-shined and in good repair. No articles, such as pencils, pens, watch chains, jewelry, combs, or similar items shall be worn exposed when in uniform.
- b. **Care of the Uniform.** The maximum service life of the various uniform articles can only be attained by proper care and maintenance. No matter how well-fitting your uniform is when new, it will not continue to look its best or keep its shape unless it is carefully pressed and worn properly. By carrying large or heavy objects in the pockets, you can rapidly destroy the shape of the best uniform made. You should always hang the uniforms on a hanger when not in use. Many items must be dry cleaned instead of washed. Be careful not to damage clothing through improper care. Uniforms shall be kept clean, neat and in good repair. Insignia and devices shall be bright and free from tarnish and corrosion.
- c. **Uniform of the Day.** The uniform of the day is the uniform your naval science instructor (NSI) will direct you to wear on any given day. The uniform color, Navy blue, is actually black in appearance. The Service Dress Blue uniform (officers and chiefs) and the Navy Service Uniform (enlisted) is the uniform you may be directed to wear year-round in most climates. Sweaters (V-neck) and jackets may be authorized in cooler climates. In the warmer climates, you may be directed to wear the Service uniform year-round.

The only uniforms authorized for cadet wear are those described in this manual and available through the current issue of the NJROTC Supply Manual (NSM) NAVEDTRA 37123B. The most updated uniform listing is in JUMS.

1-3 THE WEARING OF THE UNIFORM

- a. The NJROTC uniform will be worn by all cadets at least one full school day each week and on other occasions as prescribed by your naval science instructor (drills, ceremonies, and parades). Certain modifications to NJROTC uniforms may be authorized for drill teams and performing units. Such items include leggings, ascots, berets, and guard helmets. **However, modifications to cadet uniforms must be approved by the area manager in advance.** When appropriate, the wearing of reflective gear such as armbands, vests and sashes are authorized. The wearing of uniform articles of sister services with the NJROTC uniform are not authorized.
- b. The combination cap (optional for officers and chiefs) or the garrison cap (enlisted) is a required part of your NJROTC uniform. When outdoors, you shall be covered at all times except when ordered to uncover, or during religious services which are not associated with a military ceremony. While the cap is not normally worn indoors, it is required while on official duty when wearing a guard belt and/or leggings.
- c. Cadets are to be in a complete uniform and in compliance with the uniform standards described in this manual anytime they are in uniform. The wearing of partial or incomplete uniforms so that the uniform can be "preserved" for inspection is not permitted. **Cadets will meet uniform standards whether they are standing an NJROTC inspection or attending other school classes in uniform.**
- d. Uniforms for special occasions such as a field day shall be prescribed by the naval science instructor. All cadets participating at field meets will either be in the complete NJROTC uniform prescribed for the meet, or a complete athletic uniform.
- e. Uniformed cadets may not participate during or in connection with political activities, private employment, or commercial interests, that imply official sponsorship of the activity or interest, or at any other occasion when the wearing of the uniform would discredit the NJROTC program or the Navy.
- f. You may be required to wear a name tag at the discretion of your NSI. When worn, it shall be positioned on the right side of the uniform aligned and positioned opposite to the ribbons on the left side. The bottom of the name tag will be aligned with the bottom row of ribbons. Refer to the illustrations in this chapter beginning on page 1-11.

1-4 PERSONAL APPEARANCE AND GROOMING

MEN

Hair: Neat, clean, trimmed and present a well-groomed appearance. Above the ears and around the neck: must be tapered upwards 3/4-inch and outwards not greater than 3/4-inch. Must not touch the collar. No longer than 4 inches and the bulk shall not exceed 2 inches. (In no case shall the bulk or length of your hair interfere with the proper wearing of your cap. Bulk is defined as the distance that the mass of the hair protrudes from the scalp as indicated by the - - - - - line in the drawing on the next page). One narrow part in the hair is authorized. This may be cut, clipped, or shaved.

Plaited or braided hair is unauthorized. Hair may not show under the front brim of any uniform cap. Below are examples of male haircuts which conform to NJROTC regulations.



Note: Ethnic hairstyles are permitted provided they are groomed to fit within the guidelines stated above. Bizarre hairstyles and faddish or outrageous multicolor hair are unauthorized.

GROOMING STANDARDS FOR MEN

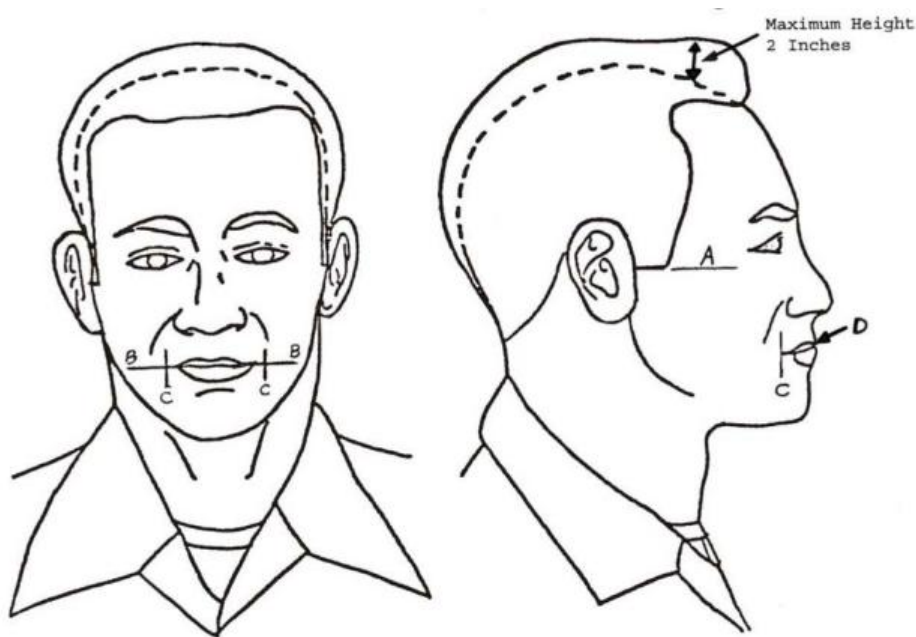

Sideburns: Neatly trimmed and tailored as described above. Shall not extend below a point level with the middle of the ear, as indicated by line "A", and shall be of even width (not flared). Shall end with a clean shaven horizontal line.

Mustaches: Neat and closely trimmed. No portion shall extend below the upper lip line as indicated by line "D". Shall not be below the horizontal line extending across the corners of the mouth as indicated by line "B". Shall not be more than 1/4-inch beyond a vertical line drawn upward from the corners of the mouth as indicated by line "C". No other facial hair is permitted.

- Fingernails: Will not extend past the fingertips.
- Earrings/Studs: Not authorized in the ear, nose, eyebrows, tongue, lips, or other areas of the face or body visible to the naval science instructor.
- Necklaces: Authorized, but shall not be visible
- Rings: One per hand is authorized.
- Wristwatch/Bracelet: One of each is authorized, but no ankle bracelets.
- Sunglasses: A conservative pair is permitted when authorized by the naval science instructor. Sunglasses are never authorized in military formations. Retainer straps are not authorized.

WOMEN

Hair: Clean, neatly shaped, and presents a well-groomed appearance. Lopsided and extremely asymmetrical haircuts and hair styles are not authorized. Braids, if worn, must be neatly and inconspicuously secured at all points to the head, and may not dangle free at any point. May touch, but cannot fall below the horizontal line level with the lower edge of the back of the collar as indicated by line "A" in the drawing below. Must not show under the front brim of any cap. The bulk of the hair shall not exceed approximately 2 inches, nor interfere with the proper wearing of your cap.

GROOMING STANDARDS FOR WOMEN

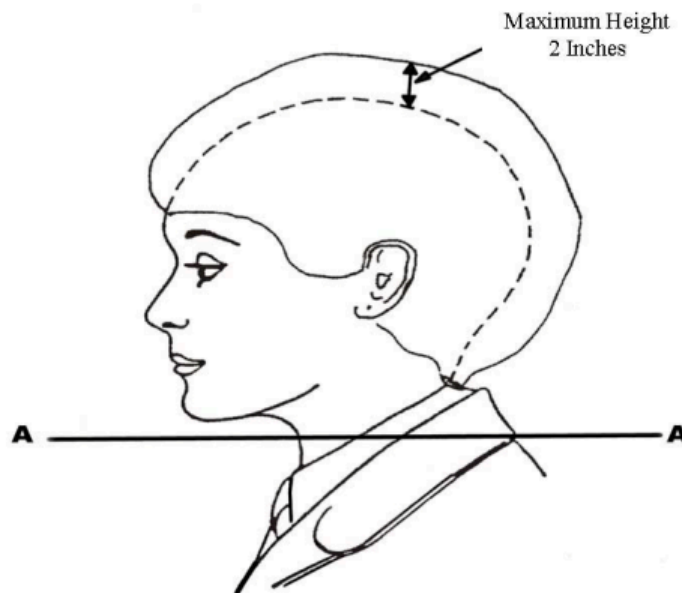

Note: Ethnic hairstyles are permitted provided they are groomed to fit within the guidelines stated above. Bizarre hairstyles and faddish or outrageous multicolor hair are unauthorized. Below are examples of female hair styles which conform to NJROTC regulations.



Hair Ornaments: Barrettes must be similar to hair color. Conspicuous rubber bands, combs and pins are not authorized.

Cosmetics: Applied in good taste and colors blend with natural skin tone. Exaggerated or faddish cosmetics are inappropriate. Lipstick should be conservative.

Fingernails: Shall not be excessive in length. Nail polish color shall complement the skin tone.

Earrings/Studs: One per ear, centered on the earlobe. Must be a small gold or silver ball (post or screw on). Studs are not authorized in the nose, eyebrows, tongue, lips, or other areas of the face or body visible to the naval science instructor.

Necklaces: Authorized, but shall not be visible.

Rings: One per hand is authorized, plus the engagement ring or the wedding ring.

Wristwatch/Bracelet: One of each is authorized, but no ankle bracelets.

Sunglasses: A conservative pair is permitted when authorized by the naval science instructor. Sunglasses are never authorized in military formations. Retainer straps are not authorized.

NOTE: Personal appearance such as the wearing of lip rings, tongue and nose studs, belly rings and other types of bizarre body jewelry, for both males and females when out of uniform, will be determined by the local school or NJROTC student dress codes.

1-5 UNIFORM COMPOSITION

a. **Male Uniforms.** Listed here are the uniforms and items you will wear with the uniform. These uniforms shall be worn when prescribed by your NSI.

1. a. Officers and chiefs are authorized to wear the Service Dress Blue uniforms.
- b. All other personnel are authorized to wear the Navy Service uniform.
- c. All personnel of the color guard are authorized to wear the Service Dress Blue uniform only when performing.
2. The Working Khaki uniform is normally prescribed by the NSI to be worn when your uniform might get unduly soiled on field trips, sea cruises, or summer Leadership Academies and mini-boot camps. When traveling on a field trip to a warm weather base, the khaki uniform is approved for wear throughout the entire trip, but must be worn properly at all times. Ribbons, medals, and cords are not authorized for wear with the khaki uniform.

Note: **The Working Khaki uniform is not authorized as a "Uniform Day" uniform.**

3. The combination cap with white cover is authorized for wear by officers and chiefs only, and can be worn with Service Dress Blue uniforms. The white combination cap may be worn by the color guard when performing. The chin strap (gold for officers, black for chiefs) is adjusted to fit snugly against the cap. Chin strap buttons will be gold. Wear the black chin strap with the grommet to your left. The cap should be worn squarely on the head with the bottom edge parallel to and 1 and 1/2-inches above the eyebrows.

4. The blue garrison cap will be worn by enlisted personnel with the Service Dress Blue uniforms.

Wear the cap squarely on the head with the fore and aft crease centered vertically between the eyebrows and the lowest point approximately 1 inch above the eyebrows. When indoors, the garrison cap is stowed by placing it under the belt on the right or left side of the uniform.



5. The khaki garrison cap or ball cap will be worn with the Working Khaki uniform by all personnel.
6. A one-piece, black, hand-tied necktie will be worn when required. The tie will be knotted with either a four-in-hand, half windsor or windsor knot. Wear the top of the knot parallel to and slightly above the top of the shirt collar closure, hiding the shirt button. The bottom of the tie hangs within 1 inch of the top of the belt buckle. The tie does not cover the belt buckle.
7. An optional tie tack/clasp can be worn with the uniform tie. This tack/clasp must be plain gold (the NJROTC bar may be used for this purpose), and aligned between the 3rd and 4th button from the neck.
8. Shoes shall be Navy-style plain black leather, low quarter, lace style shoe with no stitching, decoration or seam across the toe. Shoes shall be laced inside out through all eyelets, and shall be well-shined. Poromeric (e.g. corfam) shoes are optional but might not be authorized to be worn when standing some inspections.
9. Uniform socks shall be black plain knit or rib knit socks.
10. Plain white crew neck or V-neck tee shirts shall be worn with all uniforms at the direction of the SNSI.
11. Black gloves are authorized for outdoor wear as an optional item; however, they must be purchased by the wearer. Reimbursement is not authorized.
12. Peacoats or all-weather coats may be prescribed for wear in certain areas of the country. Gold buttons are worn on all peacoats. The NJROTC patch is not worn on the peacoat.
13. Watchcaps are authorized for wear with working uniforms as an optional item.
14. The black relaxed fit jacket may be worn with all uniforms except the Service Dress Blue uniform. Rank insignia is not worn on the relaxed fit jacket. The NJROTC patch is worn on the left shoulder with the top edge one inch below the shoulder seam. The female overblouse shall not be visible below the bottom edge of the relaxed fit jacket. When worn, all jackets and coats must be zipped at least 3/4 of the way up.
15. Ball caps are authorized with the Working Khaki uniforms as an optional item, as shown here. They can be of unit design, but in good taste. School colors are authorized.



b. **Female Uniforms.** The female cadet uniforms and items are only slightly different from the male uniforms.

1. Maternity uniforms are authorized for wear, however they cannot be purchased with government funds. These items must be paid for by the cadet.

2. A black necktab with an adjustable neckband will be worn when required. The necktab's outer edges should be parallel to the outer edges of the collar. An equal amount of the necktab should show on each side of the collar.

3. Hosiery shall be made of nylon, and similar in color to the tone of your skin. When slacks are worn, black plain knit or rib knit socks will be worn in lieu of hosiery.

4. Shoes shall be Navy-style plain black laced leather oxfords. Shoes shall be laced inside out through all eyelets, and shall be well-shined. Plain black dress pumps are authorized for wear as an optional item with dress uniforms for female cadets enrolled only in naval science two and above. The plain black dress pumps shall be made of smooth calf leather, with closed heels and toes. Heels shall be no higher than 2 and 5/8-inches nor less than 5/8-inch measured from the forward edge, and no wider than 1 and 3/4-inches at the base. The sole shall be no thicker than 1/4-inch. Wedge heels are not authorized. Poromeric (e.g. corfam) shoes are optional but might not be authorized to be worn when standing some inspections.

5. Skirts shall be hemmed to within 1 and 1/2-inches above or below the crease in the back of the knee.

6. The pleat in the back of the skirt shall be hemmed for a 6-inch opening.

7. Plain white crew neck or V-neck tee shirts shall be worn with all uniforms at the direction of the SNSI.

8. The handbag, if carried, must be a plain black, leather or synthetic purse.



c. **Uniform Appearance, Cleanliness and Maintenance**

1. Uniforms shall be kept clean, neat and in good repair.

2. Shirts should be pressed with a properly placed NJROTC patch. No buttons with Irish pennants, nor holes in the collar from misplaced insignia.

3. Trousers and skirts should be pressed, well-fitting, proper length and no lint or stains visible.
4. Shoes should be highly polished in their entirety, not just the toe area.
5. Hats should be clean and well-fitting. Combination covers and chin straps should be tight. Eagles on the hat buttons should be in the upright position.
6. Insignia and devices shall be clean and bright and free from tarnish and corrosion. Metal polish such as Brasso will remove the plating and should not be used for cleaning purposes.
7. Brass buckles and belt tips should be shined with quartermaster removed. Polish residue in the slide area should be removed.
8. Gold buttons, which become tarnished, can be cleaned with vinegar, followed by a thorough washing in clean water.
9. The manufacturer's cleaning instructions should be followed for the cleaning and laundering of all uniforms:
 - a. Service Dress Blue - Coat, trousers, skirt, and slacks are dry cleaned only. White shirt is laundered.
 - b. Khaki - Shirt, trousers, and slacks are laundered and ironed.
 - c. Combination cap cover is laundered.
 - d. Black relaxed fit jacket is dry cleaned only.
 - e. Care must be exercised when using bleach in the laundering of white articles. Chlorine bleach on white polyester fabric turns it yellow.
 - f. Military creases on shirts for Navy Service, Service Dress, or Working Khaki uniforms are an individual option.

d. Uniform Composition.

1. Males:

(a) NAVY SERVICE

Basic Uniform Items:

- Awards.....Ribbons/Medals/Cords
- Belt, brass tip...Black
- BuckleBrass
- Cap, garrison....Blue
- Coat.....None
- Necktie.....None
- Shirt, s/sleeve...Khaki
- Shoes.....Black
- Socks.....Black
- Trousers.....Blue
- Undershirt.....White
(V or crew-neck)

Outerwear:

- All-weather coat
- V- Neck Sweater
- Black relaxed fit jacket

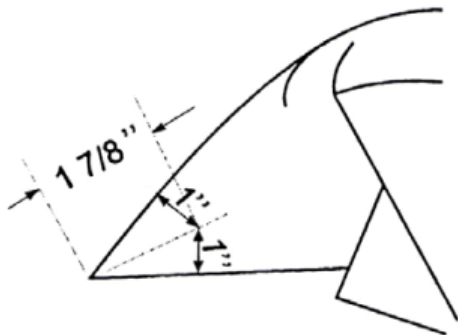

MALE'S SHORT SLEEVE SERVICE SHIRT (Khaki)

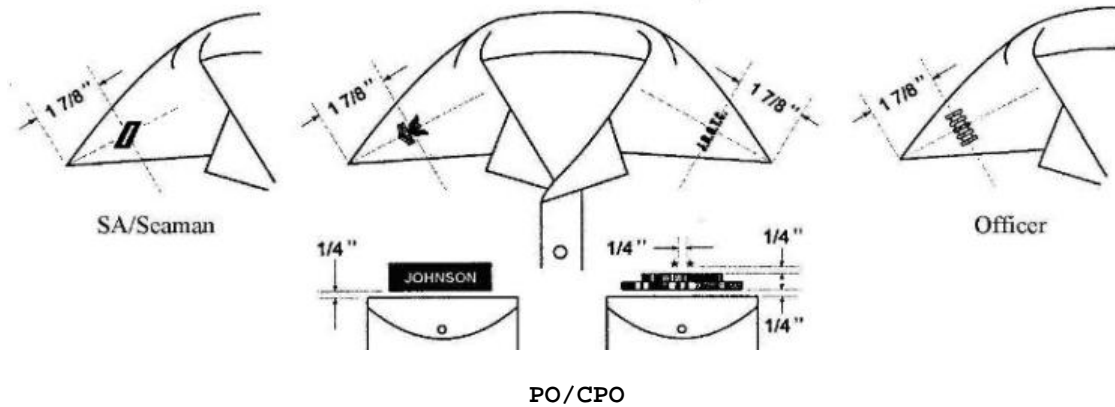

The vertical axis of the rank/rate insignia and the vertical axis of the JROTC bar insignia is positioned along an imaginary line bisecting the angle of the collar point. The center of each insignia is 1 and 7/8ths of an inch from the collar point. The diagram on the previous page shows the center of the insignia is positioned at the point where 1-inch lines perpendicular to the front and lower edges of the collar touch the imaginary line.

Service stars are worn 1/4-inch above the top row of ribbons. One star is centered, and multiple stars, not joined as a single device, are 1/4-inch apart from each other, on the ribbons. Multiple stars joined as a single device shall be centered on the ribbons.

Ribbons and name tag are worn parallel to the top of the shirt pocket, 1/4-inch above and centered on the pocket button hole.

MALE'S BLUE GARRISON CAP

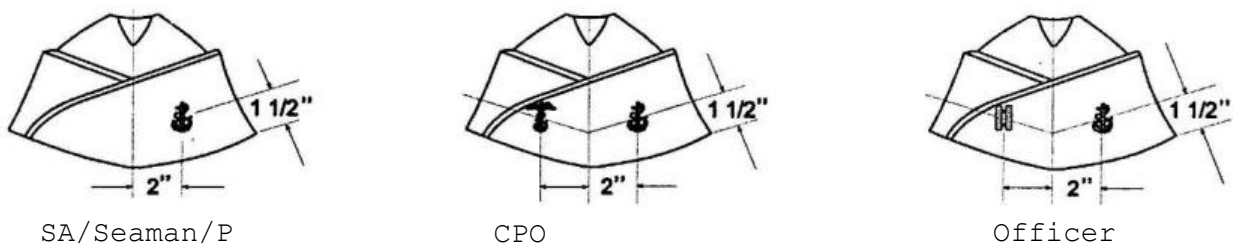

The blue garrison cap is worn with the Service uniform.

The small fouled anchor is worn on the garrison cap. The anchor is worn on the wearer's left side of the cap. The center of the anchor is bisected by a vertical line 2 inches from the fore crease of the garrison cap, and a horizontal line 1 and 1/2-inches from the bottom edge of the cap.

Only officers and chiefs wear the rank/rate insignia on the garrison cap. It is worn on the wearer's right side. The center of the rank/rate insignia is bisected by a vertical line 2 inches from the fore crease of the garrison cap, and a horizontal line 1 and 1/2-inches from the bottom edge of the cap.

(b) **SERVICE DRESS BLUE**

Basic Uniform Items:

Awards.....Ribbons/Medals/Cords
Belt, brass tip...Black
Buckle.....Brass
Cap, combination..White
Coat.....Blue
Necktie.....Black
Shirt, 1/sleeve...White
Shoes.....Black
Socks.....Black
Trousers.....Blue
Undershirt.....White
(V or crew-neck)

Outerwear:

Peacoat
All-weather coat

Optional Items:

Cap, garrison.....Blue



MALE'S SERVICE DRESS BLUE COAT (Officers/CPOs)

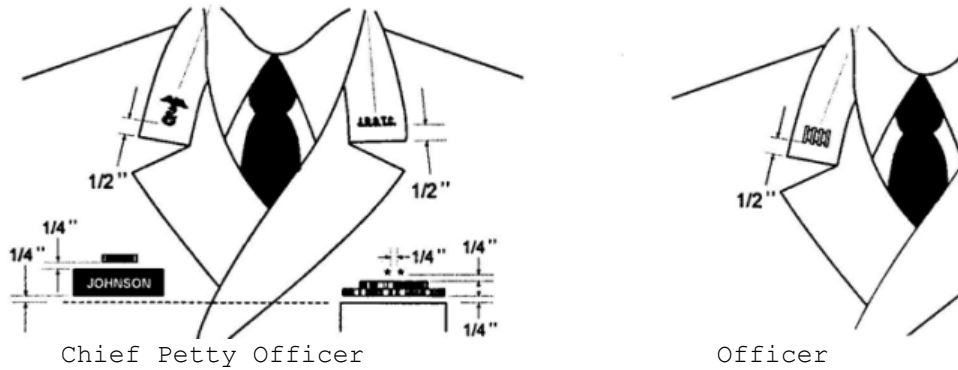

The JROTC bar and rank/rate insignias for the male's Service Dress Blue coat are positioned on the collar 1/2-inch above the notch in the lapel. The vertical axis of each insignia is parallel to, and centered between, the outer edges of the coat collar. The JROTC bar insignia is worn on the wearer's left side; the rank/rate insignia is worn on the wearer's right side.

Name tag and ribbons are parallel to the deck, 1/4-inch above and centered on the coat pocket.

Service stars are worn 1/4-inch above the top row of ribbons. One star is centered, and multiple stars, not joined as a single device, are 1/4-inch apart from each other, centered on the ribbons. Multiple stars joined as a single device shall be centered on the ribbons.

MALE'S COMBINATION CAP
(Officers/CPOs)



The large fouled anchor is worn on the combination cap. Cadet chief petty officers wear a black chin strap on the cap; cadet officers wear a gold chin strap.

MALE'S GARRISON CAP
(Officers/CPOs)
(Optional)



The small fouled anchor and rank/rate insignias are worn on the garrison cap for officers and chiefs. The anchor is worn on the wearer's left side of the cap; the rank/rate insignia is worn on the wearer's right side. The center of the anchor insignia and the center of the rank/rate insignia is bisected by a vertical line 2 inches from the fore crease of the garrison cap, and a horizontal line 1 and 1/2-inches from the bottom edge of the cap.

(c) WORKING KHAKI

Basic Uniform Items:

Awards.....None
Belt, brass tip...Khaki
Buckle.....Brass
Cap, garrison.....Khaki
Coat.....None
Necktie.....None
Shirt.....Khaki
Shoes.....Black
Socks.....Black
Trousers.....Khaki
Undershirt.....White
(V or crew-neck)

Outerwear:

All-weather coat Utility jacket
V- Neck Sweater
Black relaxed fit jacket

Optional Items:

Cap, ball.....Black
(or school colors)



Note: Ribbons, medals and aiguillettes are not authorized on the Working Khaki uniform.

MALE'S WORKING KHAKI SHIRT

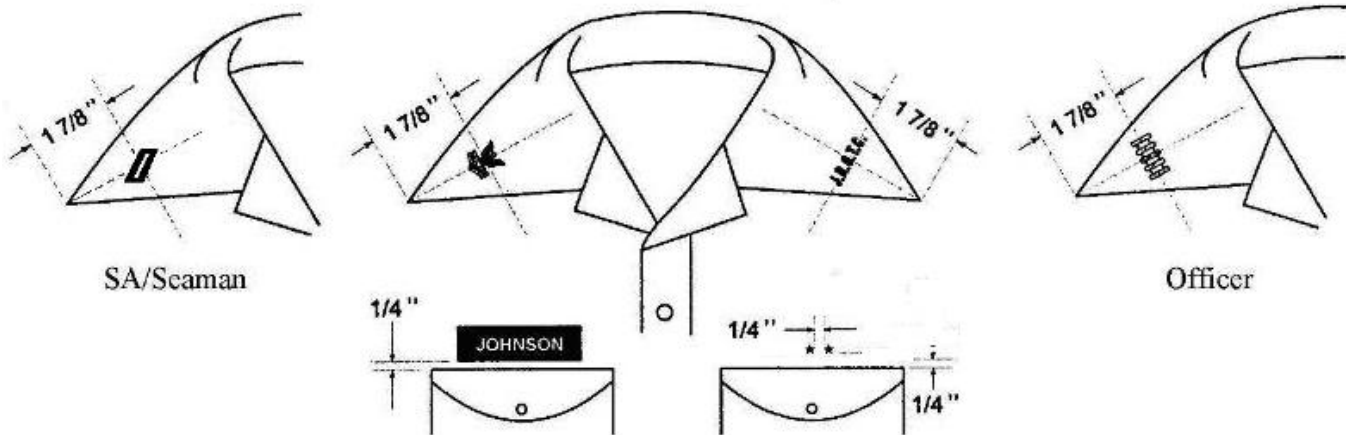

The vertical axis of the rank/rate insignia and the vertical axis of the JROTC bar insignia is positioned along an imaginary line which bisects the angle of the collar point. The center of the rank/rate insignia and the center of the JROTC bar insignia is positioned 1 and 7/8ths of an inch from the collar point.

Service stars are worn 1/4-inch above the left pocket. One star is centered, and multiple stars, not joined as a single device, are 1/4-inch apart from each other, centered on the pocket. Multiple stars joined as a single device shall be centered on the pocket.

The name tag is worn parallel to the top of the shirt right pocket, 1/4-inch above and centered on the pocket button hole.

Awards are not authorized on the Working Khaki uniform.

MALE'S KHAKI GARRISON CAP

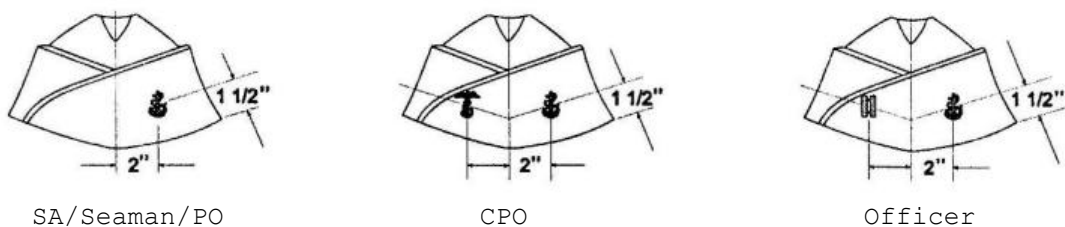

All male cadets wear the Khaki garrison cap with the Working Khaki uniform.

The small fouled anchor is worn on the garrison cap. The anchor is worn on the wearer's left side of the cap. The center of the anchor is bisected by a vertical line 2 inches from the fore crease of the garrison cap, and a horizontal line 1 and 1/2-inches from the bottom edge of the cap.

Only officers and chiefs wear the rank/rate insignia on the garrison cap. It is worn on the wearer's right side. The center of the rank/rate insignia is bisected by a vertical line 2 inches from the fore crease of the garrison cap, and a horizontal line 1 and 1/2-inches from the bottom edge of the cap.

2. Females:

(a) **NAVY SERVICE**

Basic Uniform Items:

Awards.....Ribbons/Medals/Cords
Cap, garrison.....Blue
Coat.....None
Hosiery, tone.....Flesh
Necktab.....None
Shirt, s/sleeve...Khaki
Shoes, oxford.....Black
Slacks,.....Blue
Socks.....Black

Outerwear:

All-weather coat
V - Neck Sweater
Black relaxed fit jacket

Optional Items:

Handbag.....Black
Shoes, pumps.....Black
Skirt, belted.....Blue
Undershirt.....White
(V or crew-neck)

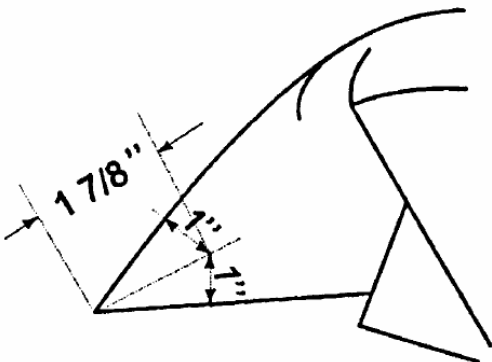

FEMALE'S SHORT SLEEVE SERVICE SHIRT (Khaki)

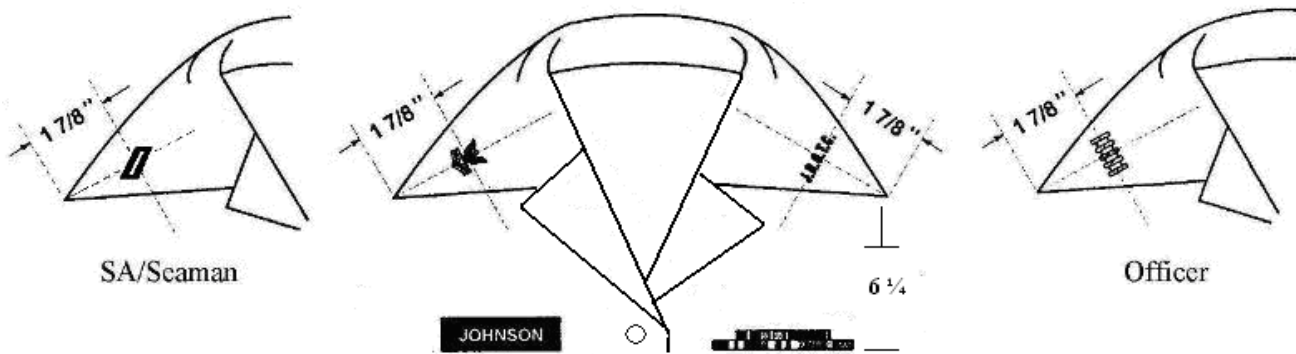

The vertical axis of the rank/rate insignia and the vertical axis of the JROTC bar insignia is positioned along an imaginary line bisecting the angle of the collar point. The center of each insignia is 1 and 7/8ths of an inch from the collar point. The diagram on the previous page shows the center of the insignia is positioned at the point where 1-inch lines perpendicular to the front and lower edges of the collar touch the imaginary line.

Service stars are worn 1/4-inch above the top row of ribbons. One star is centered, and multiple stars, not joined as a single device, are 1/4-inch apart from each other, centered on the ribbons. Multiple stars joined as a single device shall be centered on the ribbons.

Placement of the bottom of the ribbons shall be six and one quarter inches down from the intersection of the front seam and shoulder seam and centered over the front seam. Nametags shall be placed in the same manner on the right side of the overblouse.

FEMALE'S BLUE GARRISON CAP

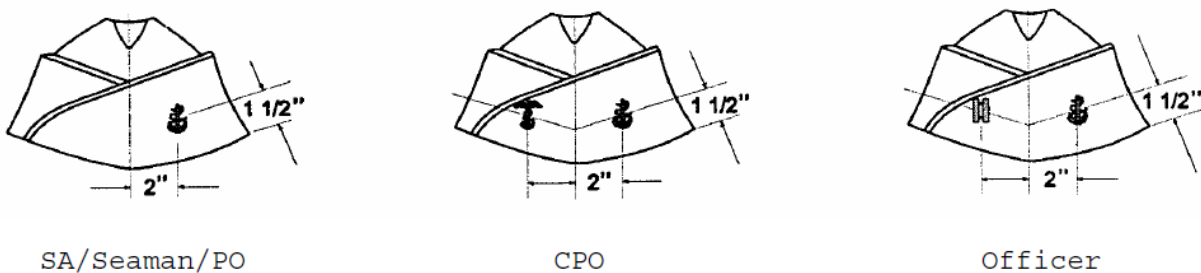

The blue garrison cap is worn with the Service uniform.

The small fouled anchor is worn on the garrison cap. The anchor is worn on the wearer's left side of the cap. The center of the anchor is bisected by a vertical line 2 inches from the fore crease of the garrison cap, and a horizontal line 1 and 1/2-inches from the bottom edge of the cap.

Only officers and chiefs wear the rank/rate insignia on the garrison cap. It is worn on the wearer's right side. The center of the rank/rate insignia is bisected by a vertical line 2 inches from the fore crease of the garrison cap, and a horizontal line 1 and 1/2-inches from the bottom edge of the cap.

(b) **SERVICE DRESS BLUE**

Basic Uniform Items:

Awards.....Ribbons/Medals/Cords
Belt, brass tip...Black
Buckle.....Brass
Cap, combination..White
Coat.....Blue
Hosiery, tone....Flesh
Necktab.....Black
Shirt, s/sleeve...White
Shoes, oxford....Black
Skirt, belted....Blue
Skirt, unbelted...Blue
Slacks, belted....Blue
Slacks, unbelted..Blue
Socks.....Black

Outerwear:

Peacoat
All-weather coat

Optional Items:

Cap, garrison.....Blue
Handbag.....Black
Shoes, pumps.....Black
Undershirt.....White
(V or crew-neck)



Note: Collar insignias on this coat should be positioned 1/2-inch above the notch in the lapel as described for the male SDB coat on page 1-14. The fabric on the SDB coat, slacks and skirt must match.

FEMALE'S SERVICE DRESS BLUE COAT
(Officers/CPOs)

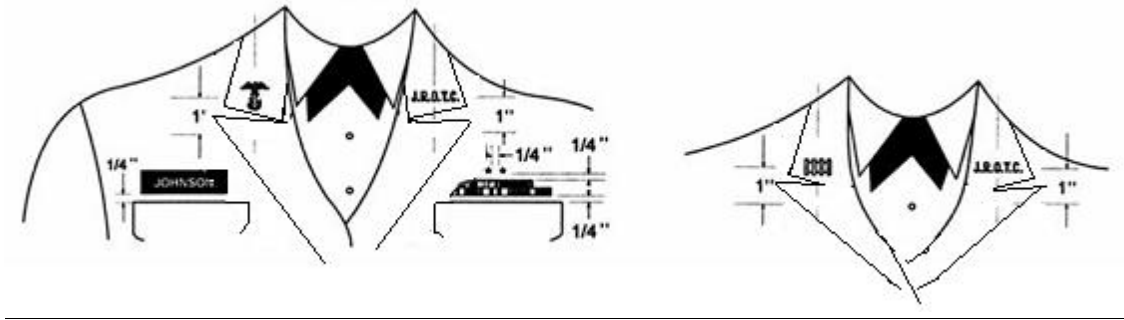

Chief Petty Officer

Officer

The JROTC bar and rank/rate insignias for the female's Service Dress Blue coat are positioned on the rounded end of the coat collar as shown above. The vertical axis of each insignia is parallel to, and centered between, the outer rounded edges of the collar. The insignias are fixed in an upright position with the center of the insignias 1 inch from the semicircular bottom edge of the collar. The JROTC bar insignia is worn on the wearer's left side; the rank/rate insignia is worn on the wearer's right side.

Name tag and ribbons are parallel to the top of the coat pocket, 1/4-inch above and centered on the coat pocket.

Service stars are worn 1/4-inch above the top row of ribbons. One star is centered, and multiple stars, not joined as a single device, are 1/4-inch apart from each other, centered on the ribbons. Multiple stars joined as a single device shall be centered on the ribbons.

FEMALE'S COMBINATION CAP
(Officers/CPOs)

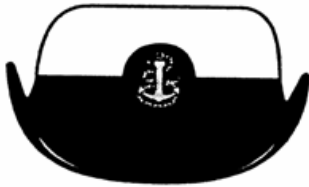

Chief Petty Officer



Officer

The large fouled anchor is worn on the combination cap. Cadet chief petty officers wear a black chin strap on the cap; cadet officers wear a gold chin strap.

FEMALE'S GARRISON CAP
(Officers/CPOs)
(Optional)

The small fouled anchor and rank/rate insignias are worn on the garrison cap for officers and chiefs. The anchor is worn on the wearer's left side of the cap; the rank/rate insignia is worn on the wearer's right side. The center of the anchor insignia and the center of the rank/rate insignia is bisected by a vertical line 2 inches from the fore crease of the garrison cap, and a horizontal line 1 and 1/2-inches from the bottom edge of the cap.

(c) **WORKING KHAKI**

Basic Uniform Items:

Awards.....None
Belt, brass tip...Khaki
Buckle.....Brass
Cap, garrison....Khaki
Coat.....None
Hosiery, tone....Flesh
Necktab.....None
Shirt.....Khaki
Shoes, oxford....Black
Slacks.....Khaki
Socks.....Black

Outerwear:

All-weather coat
Utility jacket
V- Neck Sweater
Black relaxed fit jacket

Optional Items:

Handbag.....Black
Undershirt.....White
(V or crew-neck)
Cap, ball.....Black
(or school colors)



Note: Ribbons, medals and aiguillettes are not authorized on the Working Khaki uniform.

FEMALE'S WORKING KHAKI SHIRT

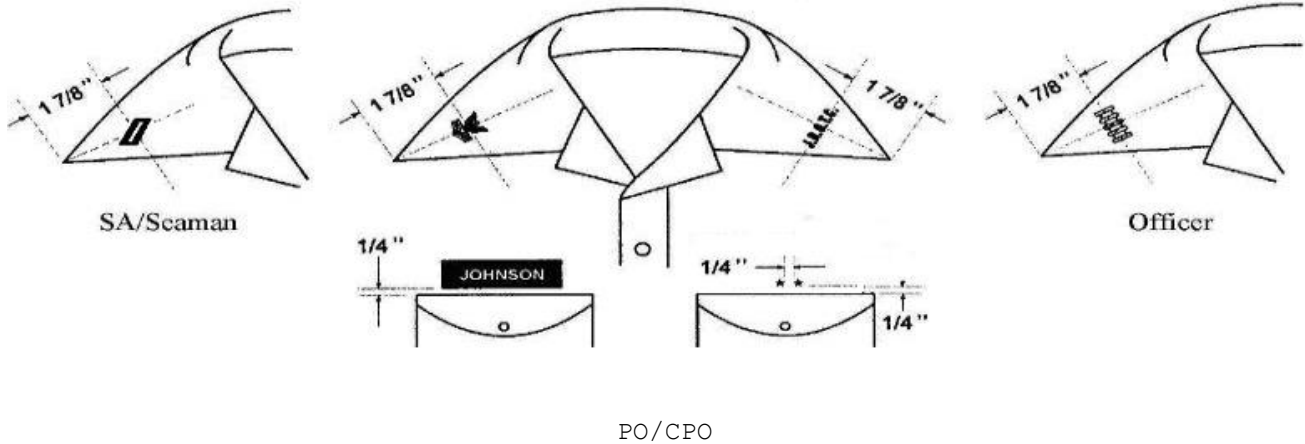

The vertical axis of the rank/rate insignia and the vertical axis of the JROTC bar insignia is positioned along an imaginary line which bisects the angle of the collar point. The center of the rank/rate insignia and the center of the JROTC bar insignia is positioned 1 and 7/8ths of an inch from the collar point.

Service stars are worn 1/4-inch above the left pocket. One star is centered, and multiple stars, not joined as a single device, are 1/4-inch apart from each other, centered on the pocket. Multiple stars joined as a single device shall be centered on the pocket.

The name tag is worn parallel to the top of the shirt right pocket, 1/4-inch above and centered on the pocket button hole.

Awards are not authorized on the Working Khaki uniform.

FEMALE'S KHAKI GARRISON CAP

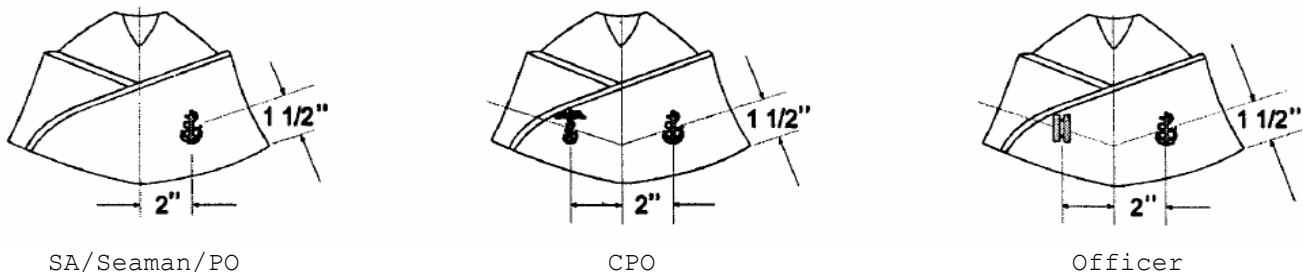

All female cadets wear the Khaki garrison cap with the Working Khaki uniform.

The small fouled anchor is worn on the garrison cap. The anchor is worn on the wearer's left side of the cap. The center of the anchor is bisected by a vertical line 2 inches from the fore crease of the garrison cap, and a horizontal line 1 and 1/2-inches from the bottom edge of the cap.

Only officers and chiefs wear the rank/rate insignia on the garrison cap. It is worn on the wearer's right side. The center of the rank/rate insignia is bisected by a vertical line 2 inches from the fore crease of the garrison cap, and a horizontal line 1 and 1/2-inches from the bottom edge of the cap.

1-6 MALE NECKTIE, BLACK.

- a. **Description:** Made of authorized fabric measuring no more than 3 1/4-wide. Must be hand-tied.
- b. **Correct Wear:** Wear tie knotted with a half windsor, a windsor, or a four-in-hand knot. Wear the top of the knot parallel to and slightly above the top of the shirt collar closure, hiding the top button. The bottom of the tie hangs within one inch of the top of the belt buckle. The tie does not cover the belt buckle.
- c. **Directions:** The following diagrams on how to tie your tie with a half windsor knot are shown while looking in a mirror.

- (1) Place the wide end of your tie on the right side of your chest so it extends about 12 inches below the narrow end of the tie.

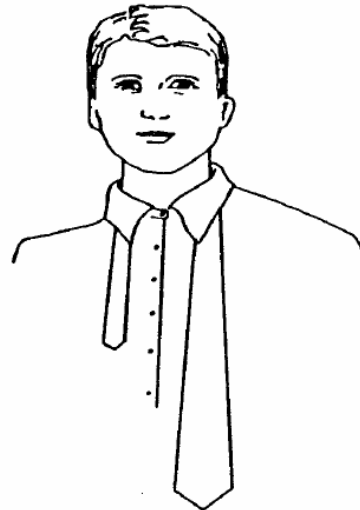

- (2) Cross the wide end of the tie over the narrow end and then back under.

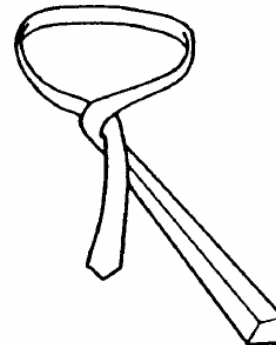

- (3) Bring the wide end of the tie up and over the neck loop, then turn the wide end down under and through the neck loop.

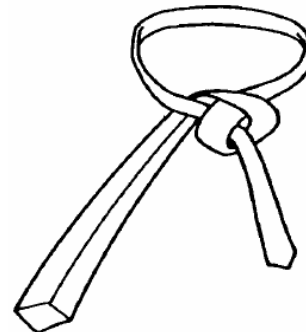

- (4) Take the wide end of the tie and pass it in front of the narrow end from left to right.

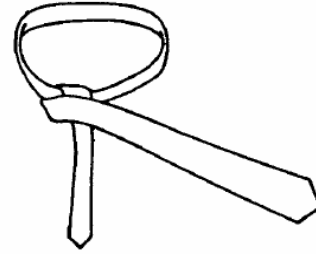

- (5) Pass the wide end of the tie up under and through the neck loop.

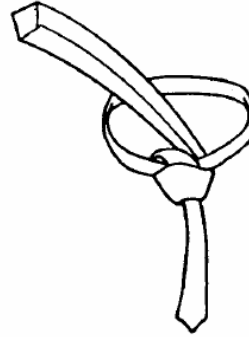

- (6) Bring the wide end of the tie down through the front of the knot.

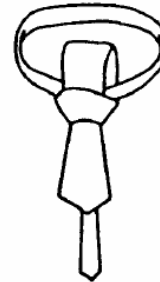

- (7) Finish the tie by forming a dimple at the base of the knot, then tighten.



- (8) Slide up snug to the collar and center tie.

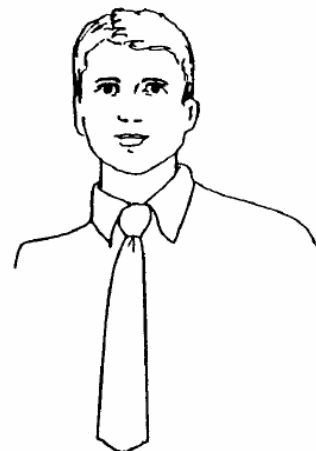

1-7 NJROTC UNIFORM INSIGNIA AND DEVICES

1. The NJROTC patch depicts a ship, an anchor and an eagle.

- (a) The NJROTC patch is worn on the left sleeve of the short-sleeve khaki shirt, the service dress blue coat, and the black relaxed fit jacket. It will be centered midway between the front and the rear of the shirt sleeve or coat sleeve, with the top edge one inch below the shoulder seam.



- (b) The NJROTC patch is not worn on the peacoat, the all-weather coat, or the long sleeve white shirt if worn with the Service Dress Blue uniform.

2. Service Designations (Stars). Course/year groups within the NJROTC Program.

Note: For those NJROTC units under the 4X4 block schedule, course is synonymous with year for those NJROTC units under the A/B block schedule or the conventional schedule.

- (a) This insignia is used to designate number of courses/years satisfactorily completed in the program. The device is a five-pointed gold star (metal device) which is $\frac{3}{8}$ ths of an inch diagonally across in size.
- (b) These stars shall be centered $\frac{1}{4}$ th of an inch above the left breast pocket or the ribbons, two points down. If more than one is awarded they are spaced $\frac{1}{4}$ th of an inch apart. They shall be worn above the ribbons on dress uniforms, and may be worn above the pocket on Working Khaki uniforms.

3. Collar Devices. All cadets will wear the "JROTC" device on the left shirt collar or the service dress blue coat collar as shown in the uniform illustrations on pages 1-11 thru 1-22. Rank and rate devices will be worn on the right collar of the shirt and coat collar as shown in the uniform illustrations. The "JROTC" device or the rank and rate devices are not authorized for wear on the collars of the utility jacket, the black relaxed fit jacket, the all-weather coat, or the peacoat.

4. Hat/Cap Devices.

- (a) Combination Cap. The fouled anchor will be worn on the headband of the cap. The black and gold chin straps will be worn attached to the outside of the headband with gold cap buttons. Wear the black chin

strap with the grommet to your left. The grommet looks like a small button that attaches to the top strap allowing the strap to slide and change size. The gold chin strap does not have a grommet.



(b) Garrison Cap (Blue and Khaki). A fouled anchor will be worn by all cadets on the left side of the garrison cap. Cadet officers and chiefs will wear their rank/rate insignia on the right side of the garrison cap. Refer to the uniform illustrations beginning on page 1-11 for correct positioning.

5. **Aiguillettes**. Aiguillettes may be awarded as earned for various academic and military achievements, and may be worn only on the Service Dress Blue and Service uniforms. Aiguillettes awarded by the naval science instructor for such things as color guard, drill team, academic team and the like, will be worn only on the left shoulder. Only the Leadership Academy aiguillette will be worn on the right shoulder. NO MORE THAN ONE AIGUILLETTE MAY BE WORN ON EACH SHOULDER. Aiguillettes will be attached to the appropriate shoulder by either a gold coat button on the Service Dress Blue uniform, or a miniature anchor (garrison cap) on the Service uniforms. The button or anchor shall be placed so that the entire aiguillette hangs on the shoulder parallel to the seam of the coat or shirt. Aiguillettes are not authorized for wear on the peacoat, all-weather coat, coat, utility jacket, relaxed fit jacket, and Working Khaki uniforms.



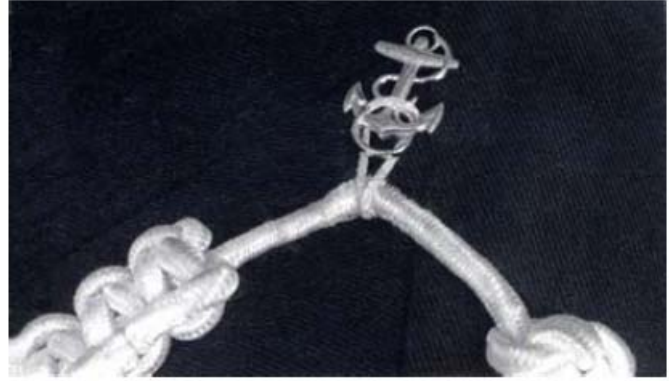
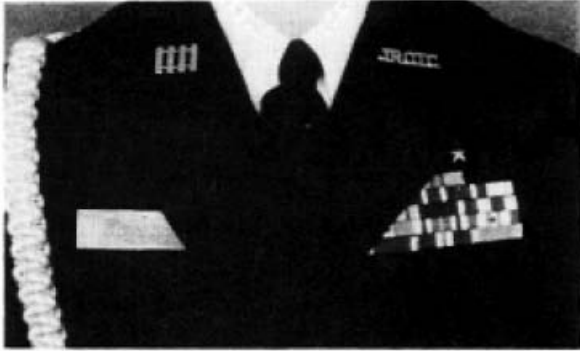

1-8 AWARDS AND DECORATIONS

- a. **Wearing of Ribbon Awards.** The NJROTC ribbons are worn only on the Service Dress Blue and the Navy Service uniforms. When more than three ribbons are earned, wear them in horizontal rows of three each. If ribbons are not in multiple of threes, the top row contains the lesser number, and the center of this row sits over the center of the row below. Wear ribbons without spaces between ribbons or rows of ribbons. The NJROTC ribbons will be worn with the lower edge of the bottom row centered 1/4 of an inch above the left breast pocket of the shirt or coat. An adjustment may be necessary to make the ribbons parallel to the deck on the Service Dress Blue coat. To prevent the lapels on the SDB coat from covering ribbons, they may be aligned so the ribbon border to the wearer's left is aligned with the left side of the pocket. Rows of ribbons where more than 50 percent of the ribbon is covered by the SDB coat lapel, may contain two ribbons each and be aligned with the left border. Note: Ribbons are not authorized on the Working Khaki uniforms.



- b. **Precedence or Order of Seniority.** NJROTC ribbons will be worn in the order of precedence as outlined on the next several pages. The most senior ribbon will be worn in the top row, and inboard when more than one ribbon is worn on a row. All earned NJROTC ribbons must be worn at the same time, however only one of each ribbon design may be worn with devices/subsequent awards attached to that one ribbon. Other awards and ribbons presented to you by organizations other than the NJROTC Program such as: other military Junior ROTC programs, Retired Officers Association, American Veterans, Order of

Daedalians, American Legion, marksmanship, and the like, will be worn after (junior to) the NJROTC ribbons in the order determined by your SNSI.

c. **NJROTC Medals**. Medals earned are worn only on uniforms where other awards and decorations are authorized. They will be positioned 1/4 of an inch below the ribbons on the wear's left breast pocket. Medals will be centered immediately below the bottom row of ribbons, arranging in seniority order inboard to outboard, in the following order of precedence: (1) NJROTC academic competition, (2) NJROTC marksmanship competition, and (3) all others as prescribed by the SNSI. No more than 3 medals may be worn in each row side-by-side, or 5 medals when overlapping, in addition to its corresponding ribbon, if any. When wearing large medals, they will be placed immediately below the last row of medals so only the medallion of each medal is visible.

d. **NJROTC Ribbon Awards**. (ORDER OF PRECEDENCE)

1. **Meritorious Achievement**



Awarded, WHEN EARNED, to any NJROTC cadet who distinguishes him/herself only by outstanding meritorious achievement or performance of a meritorious act. Excludes such things as length of participation in the NJROTC unit, or sustained superior performance in a leadership position. Awarded on a case-by-case basis by the area manager.

2. **Distinguished Unit**

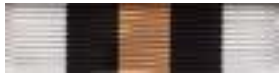

Awarded YEARLY to cadets in good standing who were unit members during the academic year in which the school earned the Distinguished Unit status. Awarded to only those units that Demonstrated the very highest levels of performance.

3. **Distinguished Cadet**



Awarded YEARLY to one cadet in each year group with the highest combined average for overall scholastic standing and aptitude in NJROTC unit activities (includes academics, homework, physical fitness, community service, drill, etc.)

4. **Honor Cadet**



Awarded YEARLY to one cadet in each year group with the highest overall academic achievement (GPA) in school, including the naval science courses.

5. **Cadet Achievement**



Awarded, WHEN EARNED, to any cadet who distinguishes him/herself by outstanding achievement or sustained superior performance. The cadet must exhibit exceptional military aptitude and dedication to the program as well as overall excellence in all facets of NJROTC. Awarded on a case-by-case basis by the area manager.

6. **Unit Achievement**



Awarded YEARLY to cadets in good standing who were unit members during the academic year in which the school earned the Unit Achievement status as determined by the Area Manager. Awarded only to those units that demonstrated exceptional performance,

but did not qualify for Distinguished Unit status.

7. **Military Aptitude Award**



Awarded YEARLY to those outstanding cadets who demonstrate an exceptional military aptitude and dedication to the NJROTC program.

8. **Naval Science 4 Outstanding Cadet(s)**



Awarded YEARLY to outstanding cadets in Naval Science 4 based on citizenship, academic performance, personal appearance and conduct.

9. **Naval Science 3 Outstanding Cadet(s)**



Awarded YEARLY to outstanding cadets in Naval Science 3. Same criteria as above.

10. **Naval Science 2 Outstanding Cadet(s)**



Awarded YEARLY to outstanding cadets in Naval Science 2. Same criteria as above.

11. **Naval Science 1 Outstanding Cadet(s)**



Awarded YEARLY to outstanding cadets in Naval Science 1. Same criteria as above.

12. **Exemplary Conduct**



Awarded YEARLY to each cadet who demonstrates exemplary conduct for the school year.

13. **Academic Achievement Award**

Awarded, WHEN EARNED, to each cadet who has met any of the following academic award criteria:

Honor Roll Award

Awarded to any cadet who attains school honor roll status. The award is denoted by wearing a Service Star above the J-Bar on the collar of the uniform. The star will be worn 1/4" above and centered on the "O" of the JROTC device. Two Service Stars may be worn to indicate the Cadet is on the Principal's Honor Roll, should the school distinguish between "Honor Roll" and Principal's Honor Roll" status. (Normally Principal's Honor Roll is awarded to a student who has achieved a 4.0 (un-weighted) or straight "A" grade average for a marking period.) The award is only worn during such time as the cadet is on the current Honor Roll. Once a new Honor Roll is published if the cadet is no longer listed, the award shall be removed.

35"b. Academic Team



Academic Team

Awarded ONCE ANNUALLY upon completion of the minimum requirement, to any cadet who is a member in good standing of the Academic Team and has participated in three or more academic competitions. The first award is the ribbon with a gold torch. Subsequent awards are as follows:

2nd Award - Bronze Star

3rd Award - Silver Star

4th Award - Gold Star

Subsequent award stars for the academic team are worn outboard of the gold torch.

35"c. Academic Team Captain



Academic Team Captain

The cadet chosen for this honor wears the Academic Award ribbon on the right side of the uniform with a gold anchor centered on the ribbon. Note: No other devices will accompany the gold anchor when the Academic Award is worn on the right side.

Note: When becoming captain of more than one team, the ribbon with the highest order of precedence is worn inboard, to the wearer's left, as shown in the example.

Note: When wearing the ribbon of a team captain on the right side of the uniform, a similar ribbon without the team captain gold anchor cannot be worn in its normal position on the left side of the uniform.

14. Exemplary Personal Appearance



Awarded, WHEN EARNED, to each cadet who displays exemplary personal appearance and has worn his/her uniform on all occasions required.

15. **Physical Fitness**



Awarded, TWICE A YEAR, to any cadet who meets or exceeds the basic physical fitness exercise requirements as outlined in Chapter 5 of this manual and the Cadet Reference Manual (CRM).

16. **Participation**



Awarded, WHEN EARNED, to any cadet who has participated in three events other than routine unit activities.

17. **Unit Service**



Awarded, WHEN EARNED, to any cadet who has demonstrated exemplary service and dedication to the unit as determined by the SNSI.

18. **Community Service**



Awarded, WHEN EARNED, to any cadet in good standing who distinguishes him/herself by dedicated and outstanding service to the community.

19. **Drill Team**



Awarded, WHEN EARNED, to each member of a drill team in good standing who has entered competition, or performed at three or more official functions.

20. **Color Guard**



Awarded, WHEN EARNED, to each member of a each member of a color guard in good standing who has entered competition, or performed at three or more official functions.

21. **Pistol/Rifle Team**



Awarded, WHEN EARNED, to any cadet in good standing who has entered any competition.

22. **Orienteering**



Awarded, WHEN EARNED, to any cadet in good standing who has entered any organized orienteering competition, or who meets the orienteering qualification standards.

23. **Recruiting**



Awarded, WHEN EARNED, to a cadet who is instrumental in the enrollment of two students in the NJROTC program. Subsequent awards are given for each additional two students enrolled.

24. **Basic Leadership Training**



Awarded to any cadet upon satisfactory completion of Basic Leadership Training, Leadership Academy or similar training as approved by the area manager.

25. **Sea Cruise**

Awarded to any cadet upon completion of an at-sea cruise (vessel must cast off lines and be underway).



Note: The awarding of ribbons for those schools on a 4x4 block schedule which complete a naval science course in just one semester, the words "yearly" or "twice a year" can be interpreted to mean once or twice during the one-semester course.

- e. **Ribbon Devices.** The following are devices which will be worn on the ribbons you have been awarded. Some of them are devices that go with the ribbon. Others are awarded in place of another ribbon award. (They represent subsequent awards for the same reason as the first award).

Device

Ribbon with which device is worn

a. **Lamp**



To be worn on the Honor Cadet ribbon by each cadet who has also achieved an "A" in naval science as follows:

- Bronze Lamp - NS-1
- Silver Lamp - NS-2
- Gold Lamp - NS-3 and NS-4

Cadets achieving school honor roll status for one or more semesters wear a bronze, silver or gold lamp on the Academic Award ribbon as described on page 1-30.

b. **Torch**



The Gold Torch is worn on the Aptitude Award ribbon if the cadet is on both the academic team and the school honor roll.

Members of the NJROTC academic team wear the gold torch on the Academic Award ribbon as described on page 1-30.

When as cadet who has already earned the former "NSTC Unit Award" ribbon is awarded the Cadet Achievement ribbon (precedent #5) by the area manager, a gold torch is attached to the Cadet Achievement ribbon indicating both ribbons were earned. Wearing two ribbons of the same design is not authorized.

c. **Anchor**



The gold anchor is worn on the following ribbons: Drill Team, Color Guard, Academic Award, Pistol/Rifle Team, Physical Fitness, and Orienteering, by the cadet who is the present leader or team commander of the group. This ribbon with anchor is worn on right side of the team commander's chest. In addition, the cadet who is selected as

the commanding officer of the NJROTC unit will attach a gold anchor to the Unit Service ribbon and wear the ribbon on the right side of his/her uniform. Note: No other devices will accompany the gold anchor when the award is worn on the right side, except with the Academic Award as previously described on page 1-30.

Ribbon, anchor and any subsequent awards earned previously are to be worn on the left side of the chest in regular order of precedence by the cadet who was a previous unit commanding officer, team leader or commander of a group.

d. Subsequent Awards

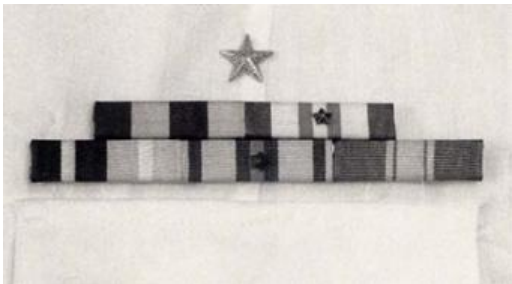

Only one of any ribbon design may be worn. Subsequent awards may be worn on ribbons 1 through 6, 11, 13, and 15 through 24. No more than eight awards (including the original ribbon award) are authorized. Subsequent awards for ribbon 12 (academic award) have been described previously on page 1-30. Subsequent awards for ribbon 14 (physical fitness) are described on page 5-1.

Stars issued for subsequent awards are issued only ONCE EACH SEMESTER. Stars are worn one ray up, two rays down. They are awarded as follows:

- | | |
|-------------------|-----------------------|
| (a) Second Award | 1 BRONZE STAR |
| (b) Third Award | 2 BRONZE STARS |
| (c) Fourth Award | 1 SILVER STAR |
| (d) Fifth Award | 2 SILVER STARS |
| (e) Sixth Award | 1 GOLD STAR |
| (f) Seventh Award | 2 GOLD STARS |
| (g) Eighth Award | 3 GOLD STARS |

Note: Those schools which are on a 4X4 block schedule are authorized to give subsequent star awards twice a semester.

- e. **Mounting Ribbons.** All ribbons you earn after the first one are to be mounted on ribbon bars. Mounting bars are made to hold different numbers of ribbons. They present a neater appearance and help you align your ribbons on your shirt or coat. Arrange ribbons in order of precedence in rows from top down, inboard to outboard within rows as shown in the example on the next page.

Uniform Buttons		2 - Honor Cadet	
	6 - Aptitude	9 - Naval Sci 2	9 - Naval Sci 1
	12 - Academic	18 - Drill Team	24 - Sea Cruise

Note: See page 1-32 for the beginning of ribbon order of precedence, and page 1-35 for a chart of all 24 NJROTC ribbons.

Note: There are four of the NJROTC ribbons that can be worn incorrectly (upside down) with the colors reversed in order from the wearer's right to left. These are: number 3 (Distinguished Cadet), number 14 (Physical Fitness), number 16 (Unit Service) and number 19 (Color Guard). In all four cases, the ribbon should be mounted on the ribbon bar with the blue portion of the ribbon to the wearer's right (toward the uniform buttons) as shown below.

Rule of Thumb: **Dark color (blue) inboard.**
(when worn on the left side of the uniform)

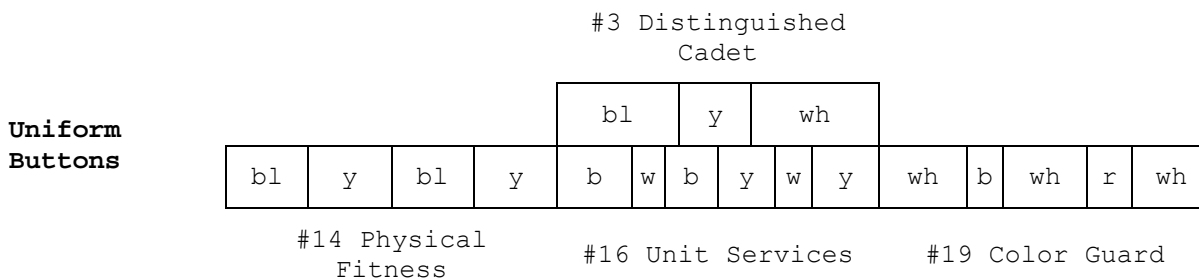

Note: When ribbon #14 or #19 is moved to the wearer's right side, as in the case of a team captain, the ribbon is not turned upside down to have the dark color inboard. The ribbon is worn as shown on the left side.

Navy Junior ROTC Ribbons



1. MERITORIOUS
ACHIEVEMENT



2. DISTINGUISHED
UNIT



3. DISTINGUISHED
CADET



4. HONOR CADET



5. CADET ACHIEVEMENT



6. UNIT ACHIEVEMENT



7. APTITUDE



8. NS IV OUTSTANDING
CADET



9. NS III OUTSTANDING
CADET



10. NS II OUTSTANDING
CADET



11. NS I OUTSTANDING
CADET



12. EXEMPLARY CONDUCT



13. ACADEMIC AWARD



14. EXEMPLARY PERSONAL
APPEARANCE



15. PHYSICAL FITNESS



16. PARTICIPATION



17. UNIT SERVICE



18. COMMUNITY SERVICE



19. DRILL TEAM



20. COLOR GUARD



21. RIFLE TEAM



22. ORIENTEERING



23. RECRUITING



24. BASIC LEADERSHIP
TRAINING



25. SEA CRUISE



LAMP-BRONZE



LAMP-SILVER



LAMP-GOLD



TORCH-GOLD



ANCHOR-GOLD



STAR-BRONZE



STAR-SILVER



STAR-GOLD

STUDY GUIDE QUESTIONS

CHAPTER 1: NJROTC UNIFORM REGULATIONS

1. What four elements are important when wearing the uniform?
2. Where does the word "uniform" come from? What does it mean?
3. NJROTC cadets and active duty Navy personnel wear the uniform the same with certain exceptions, what are they?
4. How should caps be worn?
5. How should the uniform be kept?
6. What is the uniform of the day?
7. What is the requirement for wearing the NJROTC uniform be worn?
8. When may one uncover outdoors?
9. When must cadets comply with uniform requirements?
10. Who prescribes what uniform shall be worn for special occasions? For example:
11. Can cadets, in uniform, participate in political activities?

A. Men

12. The bulk of the men's hair may not exceed how many inches?
13. Sideburns may not extend below _____?
14. How should mustaches be kept?
15. What are the grooming standards for men regarding earrings and studs?
16. Are sunglasses authorized in military formations?

B. Women

17. May the female hair extend to the collar?
18. How should cosmetics be worn on females?
19. What kind of nail polish is authorized?
20. What kinds of earrings/studs are authorized?
21. When can enlisted cadets wear the Service Dress Blue Uniform
22. Under what circumstances will a cadet be authorized to wear the Khaki uniform?
23. How are the uniform shoes required to be laced?
24. With what uniforms may a ball cap be worn?
25. What are the rules regarding hosiery for female cadets?
26. On Service and Working Khaki uniforms shirts, where are the collar devices

worn?

27. Who is authorized to wear rank/rate insignias on the garrison cap?
28. On which side is the fouled anchor worn on the garrison cap?
29. On all uniforms where is the nametag worn?
30. What is the maximum number of service stars that can be worn on the NJROTC uniform?
31. Where are the service stars worn on Navy service and service dress blue uniform?
32. What color is the chinstrap on the combination cover for Cadet Chief Petty Officers?
33. What types of knots are authorized for the male tie?
34. Which aiguillette is only authorized to be worn on the right shoulder?
35. On which uniforms are aiguillettes not authorized?
36. Where are medals worn on the NJROTC uniform?
37. What is the highest award that can be earned by a NJROTC cadet? Who is authorized to award it?
38. What is the maximum number of awards of any ribbon that can be earned by a NJROTC cadet? How is this distinguished on the ribbon?
39. Which ribbon(s) are authorized to be worn on the wearer's right side?
40. What are the four ribbons which can be worn "incorrectly" (i.e. upside down)? What is the general rule of thumb for the wearing of ribbons?

CRITICAL THINKING QUESTION

1. Official clothing for naval men was pretty much a hit-or-miss affair until 1747, when King George II of England ordered "uniforms" to be worn by all navy personnel. He did this as a means of boosting sailor's morale and improving their appearance. The first uniforms for the U.S. Navy, authorized on September 5, 1776, specified outfits for officers. These included a blue coat, blue breeches and a red waistcoat with narrow lace. Enlisted uniforms were first authorized in September 1817. The winter uniform included a black hat, blue jacket, blue trousers and a red vest, all with yellow buttons. Rating badges for enlisted men were first worn in 1885. It appears that as the United States Navy was being established, a standard designed naval uniform was not an issue. Do you think the standardization of a naval uniform, placement of rank and various insignia is important? What criteria would you use to assess a standard design for the naval uniform? Is there any sort of inconvenience that might arise from not being able to distinguish the commissioned officers from the enlisted personnel?

EXTENSION ACTIVITY

1. The vintage clothing field, with its emphasis on the clothes of women and children, tends to reflect youthful and feminine lives. But when finding men's clothes, we think about adult male lives, and then we shouldn't forget an overwhelming force in those lives - the military. A lot of the world's

clothing is military, and uniforms directly affect the history of clothing.

The question whether uniforms themselves belong to the world of military collectables or vintage clothing is important. Uniform study has to be part of costume study, and it's radically different from other costume fields in two ways; the wealth of documentation available, and the emphasis on the original wearer.

Research various military museums regarding vintage military uniforms and how the uniform designs and uniform materials have affected the design, function and practicality of clothing that we wear today on a daily basis.

2. Why spend your time flipping through the large Cadet Field Manual? Using the Cadet Field Manual, Chapter 1 NJROTC Uniform Regulations as a guide, design and make a small (5 inch x 6 inch) NJROTC Uniform Guide flip chart. This would be a quick reference guide complete with an index, illustrations, detailed instructions and a measuring template for placement of all NJROTC insignia on the uniforms.

INTERDISCIPLINARY CONNECTION

Global Studies: Research the foreign origins of military uniforms and the historical background that formed the basis of the U.S. Navy enlisted and officer uniforms. Create a poster of the early British Royal Navy uniforms and the early U.S. Navy uniforms, including the initial rank and rank insignia.

ACADEMIC CONTENT STANDARDS

Language Arts 1: Uses the general skills and strategies of the writing process. **Benchmarks:** Evaluates own and others' writings; Uses strategies to address writing to different audiences; uses strategies to adapt writing for different purposes; Writes expository compositions; Writes fictional, biographical, autobiographical, and observational narrative compositions; Writes persuasive compositions that address problems/solutions or causes/effects; Writes reflective compositions; Writes in response to literature.

Language Arts Standard 7: Demonstrates competence in the general skills and strategies for reading a variety of informational texts. **Benchmarks:** Applies reading skills and strategies to a variety of informational texts; Knows the defining characteristics of a variety of informational texts; Determines the effectiveness of techniques used to convey viewpoint; Uses discussions with peers as a way of understanding information.

Technology Standard 3: Understands the relationships among science, technology, society, and the individual. **Benchmark:** Knows that alternatives, risks, costs, and benefits must be considered when deciding on proposals to introduce new technologies or to curtail existing ones.

Historical Understanding Standard 2: Understands the historical perspective. **Benchmarks;** Understands that specific individuals and the values those individuals held had an impact on history; Analyzes the influence specific ideas and beliefs had on a period of history; Analyzes the effects that specific "chance events" had on history; Analyzes the effects specific decisions had on history.

VOCABULARY WORDS

Uniform

From a combination of two Latin words, *unus* and *forma*, which means "one form."

Uniform of the Day

The uniform of the day is the uniform your Senior Naval Science Instructor (SNSI) will direct you to wear on any given day.

Legging

A canvas cloth covering for the leg.

Ascot

A broad neck scarf that is looped under the chin.

Beret

A visor-less usually woolen cap, with a tight headband and a soft full flat top.

Garrison Cap

A visor-less folding cap worn as part of a military uniform.

SDBs'

Service Dress Blues

Service Designation Stars

This insignia is used to designate the number of courses/years satisfactorily completed in the NJROTC program.

Precedence

Priority of importance

CHAPTER 2: NJROTC RATES/RANKS AND U.S. NAVY RATES/RANKS

2-0 OBJECTIVES:

2-0.1 Explain and recognize the various NJROTC rates and ranks and be able to understand the different assignments associated with each billet.

2-0.2 Describe and recognize the rates and ranks of active duty Navy personnel.

2-1 NJROTC RATES, RANKS, AND ASSIGNMENTS

2-1.A. GENERAL

1. Cadet rates, ranks, promotions and position assignments are earned based on individual performance and demonstrated potential. Many factors are evaluated by the naval science instructors before awarding rates, ranks, promotions and advancement, and before cadet billet assignments are made. Cadets must **continually** demonstrate:

- a. High moral standards and good conduct
- b. Proper appearance in school and in unit uniform
- c. Acceptable academic achievement
- d. Acceptable performance in carrying out assigned NJROTC responsibilities
- e. Acceptable level of participation in NJROTC activities and programs

2. Students entering NJROTC for the first time are usually assigned the grade of Cadet Seaman Recruit, or in some schools the grade of Seaman Apprentice. Advancements beyond the initial grade in the enlisted rates are often based on performance, time in the unit, position assignment and by completing certain military knowledge advancement tests. Achievement of officer status requires an individual who has demonstrated superior quality leadership, integrity, personal appearance, conduct and patriotism. NJROTC cadet rates and ranks, from the lowest to the highest, are as follows:

3. All rate and rank promotions are determined by the naval science instructor. Unacceptable performance could result in a demotion.

2.1.B CADET ENLISTED RATES

NJROTC units will differ in rate assignments, advancement systems and may require practical tests to qualify for advancement in rate.

NJROTC RATE/RANK

COLLAR INSIGNIA

CADET SEAMAN RECRUIT (C/SR)

- There is no collar device for this rate.
- Assigned to new cadets in the process None of learning the NJROTC program.

CADET SEAMAN APPRENTICE (C/SA)

- The collar device is two silver diagonal stripes.
- When qualified, recruits can advance to SA in the first year.



CADET SEAMAN (C/SN)

- The collar device is three silver diagonal stripes.
- When qualified, cadets can advance to SN in the first year.

Note: There are no specific assignments for seaman recruits, seaman apprentice or seaman; these cadets are in training for future leadership roles.



CADET PETTY OFFICER THIRD CLASS (C/PO3)

- The collar device is a perched eagle over one chevron.
- Outstanding cadets may achieve this rate the first year.
- Assignments include squad leaders, assistant squad leaders in platoons, drill teams and drum and bugle corps.



CADET PETTY OFFICER SECOND CLASS (C/PO2)

- The collar device is a perched eagle over two chevrons.
- Advancement to this rate is usually in the second year.
- Assignments include squad leaders, in platoons, drill teams, and drum and bugle corps and color escorts in color guards.



CADET PETTY OFFICER FIRST CLASS (C/PO1)

- The collar device is a perched eagle over three chevrons.
- Cadets can achieve this rate usually in their second or third year.
- Assignments include platoon guides, color bearers, drill team guides, and supply assistants.



CADET CHIEF PETTY OFFICER (C/CPO)

- The collar device is an eagle perched on a fouled anchor.
- Cadets can generally achieve CPO in their second or third year.
- Assignments include company chief, platoon chief, color bearer, drill team chief, or rifle team chief.



CADET SENIOR CHIEF PETTY OFFICER (C/SCPO)

- The collar device is an eagle and one star perched on a fouled anchor.
- Generally a third year cadet.
- The SNSI may assign a Senior Chief Petty Officer billet to the company chief petty officer.



CADET MASTER CHIEF PETTY OFFICER (C/MCPO)

- The collar device is an eagle and two stars perched on a fouled anchor.
- Generally a third or fourth year cadet.
- The SNSI may assign a Master Chief Petty Officer billet to the battalion chief petty officer.



2.1.C CADET OFFICER RANKS

Cadet officers are generally third or fourth year cadets that have shown aptitude for high leadership positions. Officers are selected from the enlisted rates to fill specific positions as noted below.

NJROTC RATE/RANK

COLLAR INSIGNIA

CADET ENSIGN

- The collar device is a single gold bar.
- Generally a third or fourth year cadet.
- The first junior officer assignment which may include junior officer on company staffs, public affairs, assistant supply, platoon commander, or assistant drill team commander.



CADET LIEUTENANT (Junior Grade)

- The collar device is two attached gold bars.
- Assigned to officers ready for additional responsibilities.
- Assignments can include operations, rifle team commanders, battalion supply, and administrative officer.



CADET LIEUTENANT

- The collar device is three attached gold bars.
- Assigned to some of the most senior officers such as executive officer of companies or operations officer in battalions and regiments.



CADET LIEUTENANT COMMANDER

- The collar device is four attached gold bars.
- Assigned to cadet officers in the top leadership roles of the NJROTC.
- The highest rank of company strength.
- Assignments include company commander in smaller units and executive officer in battalions and regiments.



CADET COMMANDER

- The collar device is five attached gold bars.
- The highest rank that can be attained by a cadet in NJROTC.
- Assignments include battalion commander and regimental commander.





















2-2 NAVY RATES AND RANKS

2-2.A. GENERAL

- The Navy's rate and rank structure for men and women on active duty is in some ways similar to the rate and rank structure used by the cadets in the NJROTC program. Enlisted personnel have rates and commissioned officers have ranks. An officer's rank refers to his or her official title, e.g. ensign, lieutenant commander, captain, etc., but it also indicates the amount of pay received monthly. Enlisted personnel have similar titles and pay grades. The lowest three enlisted pay grades are in the general apprenticeship area before advancement to petty officer pay grades. When officers move up the next rank and pay grade, they have earned a promotion. When enlisted personnel move up to the next higher rate in their specialty, they have advanced in rate. The uniform sleeve and collar insignia for naval rates and ranks are shown below from the lowest to the highest:

2-2.B. SLEEVE AND COLLAR INSIGNIA FOR NAVAL RANKS AND RATES

ENLISTED RATES		SLEEVE INSIGNIA	COLLAR INSIGNIA
Pay Grade:	E-1		
Title:	Seaman Recruit	None	None
Abbreviation:	SR		
Pay Grade:	E-2		
Title:	Seaman Apprentice		
Abbreviation:	SA		
Pay Grade:	E-3		
Title:	Seaman		
Abbreviation:	SN		
Pay Grade:	E-4		
Title:	Petty Officer Third Class		
Abbreviation:	PO3		
Pay Grade:	E-5		
Title:	Petty Officer Second Class		
Abbreviation:	PO2		
Pay Grade:	E-6		
Title:	Petty Officer First Class		
Abbreviation:	PO1		

CHIEF PETTY OFFICER RATES		SLEEVE INSIGNIA	COLLAR INSIGNIA
Pay Grade:	E-7		
Title:	Chief Petty Officer		
Abbreviation:	CPO		
Pay Grade:	E-8		
Title:	Senior Chief Petty Officer		
Abbreviation:	SCPO		
Pay Grade:	E-9		
Title:	Master Chief Petty Officer		
Abbreviation:	MCPO		
Pay Grade:	E-9		
Title:	Master Chief Petty Officer of the Navy		
Abbreviation:	MCPON		

WARRANT OFFICER RANKS	COLLAR INSIGNIA SHOULDER / SLEEVE INSIGNIA	COLLAR INSIGNIA COLORS
-----------------------	--	---------------------------

W-1 No Longer in use

Pay Grade:
Title:
Abbreviation:

W-2
Chief Warrant
Officer
CW02

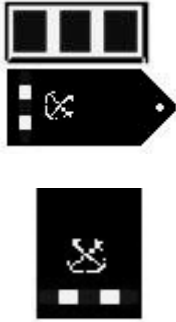

Blue and Gold

Pay Grade:
Title:
Abbreviation:

W-3
Chief Warrant
Officer
CW03

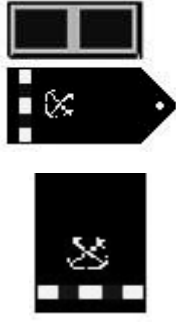

Blue and Silver

Pay Grade:
Title:
Abbreviation:

W-4
Chief Warrant
Officer
CW04

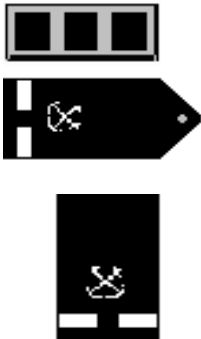

Blue and Silver

Pay Grade:
Title:
Abbreviation:

W-5
Chief Warrant
Officer
CW05

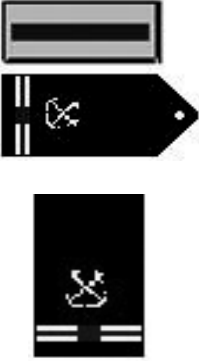

Blue and Silver

OFFICER RANKS		COLLAR INSIGNIA SHOULDER INSIGNIA SLEEVE INSIGNIA	COLLAR INSIGNIA COLORS
---------------	--	---	---------------------------

Pay Grade:
Title:
Abbreviation:

O-1
Ensign
ENS



Gold

Pay Grade:
Title:
Abbreviation:

O-2
Lieutenant Junior
Grade
LTJG



Silver

Pay Grade:
Title:
Abbreviation:

O-3
Lieutenant
LT



Silver

Pay Grade:
Title:
Abbreviation:

O-4
Lieutenant Commander
LCDR



Gold

Pay Grade:
Title:
Abbreviation:

O-5
Commander
CDR



Silver

Pay Grade:	O-6		Silver
Title:	Captain		
Abbreviation:	CAPT		

Pay Grade:	O-7		Silver
Title:	Rear Admiral Lower Half		
Abbreviation:	RADM (L)		

Pay Grade:	O-8		Silver
Title:	Rear Admiral Upper Half		
Abbreviation:	RADM (U)		

Pay Grade:	O-9		Silver
Title:	Vice Admiral		
Abbreviation:	VADM		

Pay Grade:	O-10		Silver
Title:	Admiral		
Abbreviation:	ADM		

STUDY GUIDE QUESTIONS

CHAPTER 2: NJROTC RATES/RANKS AND U.S. NAVY RATES/RANKS

1. Define rate.
2. Define rank.
3. What rate has a collar device consisting of two silver diagonal stripes?
4. What is the difference between advancement and promotion?
5. An eagle and two stars perched on a fouled anchor is the collar device for whom?
6. What is the highest authorized rank within a unit of company strength?
7. What is the highest rank that can be attained by a cadet in NJROTC?
8. The collar device that has four attached bars is for whom?
9. A collar device consisting of a single gold bar represents what rank?
10. How many stars does an Admiral have on his collar insignia?
11. What is the pay grade of a Captain?
12. What is the pay grade for a Chief Petty Officer?
13. What is the pay grade for a Warrant Officer?
14. What is required for achievement to officer status within the NJROTC?
15. What collar insignia does a Cadet Seaman Recruit wear?
16. What specific assignments are given to a Cadet Seaman Recruit, Cadet Seaman Apprentice and Cadet Seaman?
17. What assignments would a Cadet Petty Officer Third Class include?
18. The Cadet Petty Officer First Class collar device insignia looks like what and when can cadets usually achieve this rate?
19. What position can the SNSI assign a Cadet Master Chief Petty Officer?
20. What is the rank of the most junior cadet officer?
21. When are cadet officers chosen?
22. What does a Cadet Lieutenant Commander collar device look like and what specific position does at Cadet Lieutenant Commander fill?
23. List the Naval officers' pay grades, from most junior to most senior.
24. List the pay grades and rates of enlisted personnel from junior to senior.
25. Where do Warrant Officers and Chief Warrant Officers fit in the chain of command?

Critical Thinking

1. In the earliest times, rank was not an issue. Do you think the badge of rank is important? Is there any sort of inconvenience that might arise from not being able to distinguish the commissioned officers from the junior enlisted?
2. As a precious metal, gold is worth more than silver, but in the military, silver outranks gold. The current day Navy rank badges are two different colors. One example being that of the rank of Ensign is a single gold bar, but the rank of a Lieutenant (Junior Grade) is a single silver bar. Another example is that the Petty Officer rank badges are silver, but the Chief Petty Officer rank badges are gold. Explain how you feel that the color scheme of the rank badges is incorrect and how would you change the color of the rank system?

Extension Activity

With the new Navy rank and pay grade of Chief Warrant Officer - 5 having been established, write a point paper explaining why the enlisted rank system should be now have a new enlisted rank and pay grade of E-10 for the Master Chief Petty Officers.

Interdisciplinary Connection

Global Studies: Research the foreign origins of military ranks and the historical background that formed the basis of the U.S. Navy enlisted and officer ranks. Create a poster of the early U.S. Navy rank structure including the initial pay grades and rank insignia.

Academic Content Standards for the extension activity and interdisciplinary connections.

1. Analyze the values held by specific people who influenced history and the role of their values played in influencing history.
2. Analyzes how specific historical events would be interpreted differently based on newly uncovered records and/or information.
3. Knows how to evaluate the credibility and authenticity of historical sources.
4. Evaluates the validity and credibility of different historical interpretations.

Academic Content Standards

Language Arts 1: Uses the general skills and strategies of the writing process. Benchmarks: Evaluates own and others' writings; Uses strategies to address writing to different audiences; uses strategies to adapt writing for different purposes; Writes expository compositions; Writes fictional, biographical, autobiographical, and observational narrative compositions; Writes persuasive compositions that address problems/solutions or causes/effects; Writes reflective compositions; Writes in response to literature.

Language Arts Standard 7: Demonstrates competence in the general skills and strategies for reading a variety of informational texts. Benchmarks: Applies reading skills and strategies to a variety of informational texts; Knows the defining characteristics of a variety of informational texts; Determines the effectiveness of techniques used to convey viewpoint; Uses discussions with peers as a way of understanding information.

Technology Standard 3: Understands the relationships among science, technology, society, and the individual. Benchmark: Knows that alternatives, risks, costs, and benefits must be considered when deciding on proposals to introduce new technologies or to curtail existing ones.

Historical Understanding Standard 2: Understands the historical perspective. Benchmarks; Understands that specific individuals and the values those individuals held had an impact on history; Analyzes the influence specific ideas and beliefs had on a period of history; Analyzes the effects that specific "chance events" had on history; Analyzes the effects specific decisions had on history.

Vocabulary Words

Rate

Level of proficiency within an enlisted rating, similar to a pay grade.

Ratings

General grouping of enlisted personnel by job specialty.

Rank

Relative position of authority among officers and petty officers.

Officer's Rank

An officer's rank refers to his or her official title, e.g. Ensign, Lieutenant Commander, Captain, etc.

Promotion (in rank)

When an officer moves up to the next rank and pay grade, they have earned a promotion.

Advancement (in rate)

When enlisted personnel move up to the next higher rate in their rating specialty, they have advanced in rate.

Pay Grade

Level of military pay, from E-1 (Seaman Recruit) to E-9 (Master Chief Petty Officer), from W-1 (Warrant Officer) to W-5 (Chief Warrant Officer) and from O-1 (Ensign) to O-10 (Admiral).

CPO, SCPO, MCPO

Chief Petty Officer, Senior Chief Petty Officer and Master Chief Petty Officer. With the exception of the Master Chief Petty Officer of the Navy, this is the highest rank attainable by enlisted personnel while still in the enlisted category.

Warrant Officers

Warrant officers are senior specialists who supervise the operation of equipment and weapons. They bridge the gap between commissioned officers and enlisted personnel. They are like the journeymen or master tradesmen in civilian life.

CHAPTER 3: MILITARY CUSTOMS, COURTESIES, ETIQUETTE AND CEREMONIES

3-0 OBJECTIVES:

- 3-0.1 Explain the types of military customs and courtesies to include their purposes and when courtesies are rendered.
- 3-0.2 Describe the flag of the United States as a standard of honor.
- 3-0.3 Explain the procedures in pledging allegiance to the flag.
- 3-0.4 Describe the sequence of events in military ceremonies, reviews and parades.

3-1 GENERAL

- a. Military customs and courtesies are the traditional way by which nations and individuals pay respect to distinguished persons and foreign governments. Customs and courtesies are also used to show reverence for people and places of historical distinction, significance and sanctity. The type of courtesy rendered depends upon who or what is being recognized. Courtesies are salutes to ships, to high ranking individuals and to nations. Courtesies are not rendered to nations or officials not recognized by the United States, or officials who request that they not be rendered.
- b. Ceremonies are formal, traditional acts of respect and/or reverence performed on public occasions. Like customs and courtesies, military ceremonies are an integral part of military life. Ceremonial occasions range from morning and evening colors to the courtesies and ceremonies observed by ships when passing Washington's tomb, Mount Vernon, Virginia, or the USS ARIZONA Memorial, Pearl Harbor, Hawaii. There are numerous kinds and types of ceremonies, far too many to cover in this chapter.

3-2 THE AMERICAN FLAG AND FLAG ETIQUETTE

- a. The flag of the United States of America is a living thing that calls to our spirit, reminding us of the greatness of our America. We cherish and uphold it because it is the standard of honor under which we live.
- b. We view the flag with devotion, for it represents our national heritage of noble deeds, splendid accomplishments, and untold sacrifices which combined to establish the moral character of our national foundation. Our flag is a symbol that makes our past one with the present and makes the present a prophecy for tomorrow.
- c. Our flag signifies a people dedicated to liberty, justice and freedom for all.
- d. Our flag is our companion around the world. It summons confidence on sight. There is a magic in its folds that continually renews the hope that this nation, under God, will long be an example everywhere for all who love freedom with honor.
- e. We give homage to the flag because it stands for the courageous, earnest, and unselfish experiences of our people who have given us strength as a nation and



pride as citizens.

- f. We respect our flag because we have respect for our countrymen, and because our love for country finds its center in our flag.
- g. The customs and traditions which surround the display and use of our flag are guides to the means by which we as proud and grateful citizens may demonstrate the ultimate respect for the flag of our nation.
- h. It is the universal custom to display the flag only from sunrise to sunset on buildings and on stationary flagstaves in the open. However, when a patriotic effect is desired, the flag may be displayed twenty-four hours a day if properly illuminated during the hours of darkness.
- i. The flag should not be displayed on days when the weather is inclement, except when an all weather flag is displayed.
- j. The flag should be displayed daily on or near the main administration building of every public institution, and during school days in every schoolhouse.
- k. The flag should be displayed on all days, especially on all national and state holidays such as New Year's Day, Inauguration Day, President's Day, Washington's Birthday, Easter Sunday, Armed Forces Day, Memorial Day (half-staff until noon), Flag Day, Independence Day, Labor Day, Columbus Day, Navy Day, Veteran's Day, Thanksgiving Day, Christmas Day, Birthdays of States (date of admission), and such other important days as may be proclaimed by the President of the United States.
- l. The flag should be displayed daily in or near every polling place on election days.
- m. When the flag is in such condition that it is no longer a fitting emblem for display, it should be destroyed in a dignified way, preferably by burning.
- n. The flag and the national anthem are symbols of all the people, their land, and their institutions. When we salute these symbols, we are saluting the nation. Military personnel follow specific procedures in showing their respect to the flag and the national anthem. Flags and national anthems of friendly foreign nations are shown the same respect as our own. In honoring and saluting our flag we demonstrate respect for our nation, our fellow citizens and the proud heritage we share.



3-3 FLAG COURTESIES

a. The following courtesies are rendered during the ceremony of hoisting or lowering the flag, during outdoor or indoor ceremonies, or when the flag is passing in a parade or in review:

1. When Outdoors in Uniform. When in uniform outdoors and the national anthem or "To the Colors" is played, stand at attention, face the flag (if the flag is not visible, face the music) and render the military salute. The salute begins on the first note of the music and is held until the last note.
2. When Outdoors in Civilian Clothes. When in civilian clothes and the national anthem or "To the Colors" is played, stand at attention, and face the flag (if the flag is not visible, face the music). A male removes his hat and holds it in his right hand and places his right hand over his heart. A female does the same, except the hat, if worn, is not removed.
3. To An Escorted Flag Outdoors. When attending any outdoor event in uniform and the U.S. flag is escorted past you, stand at attention, face the front and render the appropriate salute. Render the salute six paces before the flag is even with you and hold it until the flag has passed six paces beyond you. Miniature flags, such as those displayed at downtown parades are not saluted.
4. On a Stationary Flagstaff. When in uniform, do not salute flags on stationary flagstaffs except during reveille and retreat.
5. During Indoor Ceremonies. When ceremonies occur indoors and the national anthem or "To the Colors" is played, face the flag and take the position of attention and place your hand over your heart. If the flag is not visible, take the position of attention and face the music or the front. When in uniform indoors, do not salute unless you are covered or under arms. No action is required while ceremonies are occurring outdoors and you are indoors. Also, there is no requirement for a person to stand or salute for ceremonies broadcast over radio or television.
6. Private Vehicle Passengers. On a military base at the first note of the national anthem, all vehicles must come to a complete stop. Occupants sit quietly until the last note of the music is played before resuming travel.
7. At Half Staff. The flag is flown at half staff to honor and pay respect to deceased persons of national importance. The term at "half-staff" means the position of the flag when it is one-half the distance between the top and the bottom of the staff.



3-4 PLEDGE OF ALLEGIANCE

- a. In military formations and ceremonies, the Pledge of Allegiance shall not be recited. At protocol functions, social, and sporting events which include civilian participants, personnel in uniform should:
 - (a) when outdoors, stand at attention, face the flag, remain silent and render the hand salute;
 - (b) when indoors, stand at attention, and face the flag, but do not salute.Reciting the Pledge of Allegiance is optional for military personnel when indoors. All persons present in civilian clothes when outdoors should remove their hats, face the flag, stand at attention with their right hand over their heart, and recite the following:

**"I pledge allegiance to the flag
of the United States of America,
and to the republic for which it stands,
one nation under God, indivisible,
with liberty and justice for all."**

* * * * *

I: You and me, an individual, a person

PLEDGE ALLEGIANCE TO THE FLAG: Take a vow, an oath, a promise
Duty owed to your country, observance of obligation.
A symbol of liberty, freedom, that which we as free men and women do so jealously cherish.

OF THE UNITED STATES: Joined together, combined, produced by two or more persons, a union our forefathers put together in 1776, to make us a united people free of a tyrant or an oppressor.

OF AMERICA: A land blessed with brotherhood from sea to shining sea. A land full of natural resources, a land where anyone can do what he/she wants as long as it does not violate the rights of another.

AND TO THE REPUBLIC: A state in which the supreme power rests in the body of citizens entitled to vote, and is exercised by elected representatives.

FOR WHICH IT STANDS: A flag known throughout the world as a symbol of freedom. A nation in which people can worship as they please, speak and not be afraid of being censored for what they say, or to express an opinion in writing and not be afraid of being arrested for writing what they feel.

ONE NATION: A body of people associated with a particular territory, who are conscious of their unity. One body of people speaking the same language, and yet opening doors to those foreign to us and saying welcome.

UNDER GOD: Meaning we have been so blessed.

INDIVISIBLE: Incapable of being divided. Even with our own internal problems our people, when sensing someone trying to take away our freedom, will answer the call to put down an adversary. We will unite.

WITH LIBERTY: Freedom from outside control. Freedom from captivity, freedom from dictatorship, with the right to choose our own

government.

AND JUSTICE: The quality of being just, equitable, fair treatment for all, regardless of social background or economic standing. The right to be heard, to see our accusers, to question why.

FOR ALL: Not just a chosen few, but for everyone in the land.

* * * * *

3-5 CEREMONIES

- a. **Elements of Ceremonies**. Ceremonies are formal events and for the most part require an understanding of such aspects as the organization, purpose, composition and administration of the various parts of ceremonies.
- b. **Flag Ceremonies**. Flag ceremonies occur during parades, reveille, retreat, and prior to special events. Reveille is the signal for the START of the official duty day. Retreat signals the END of the official duty day and also serves as a ceremony for paying respect to the flag. Most flag ceremonies will be conducted with the national anthem. A bugle call, "To the Colors," can be used and is given the same respect as the national anthem. "To the Colors" can be used when a band is not available or during bad weather. During these ceremonies, all military and civilian personnel render the proper courtesies.
- c. **Types of Ceremonies**
 - 1. Reviews
 - 2. Decorations
 - 3. Parades
 - a) Ceremonial
 - b) Street
 - 4. Funerals and Special ceremonies
- d. **Commander of Troops**
 - 1. The commander of the troops in a ceremony is the senior officer taking part in it. He is responsible for the organization, uniform and equipment of the units participating in the ceremony along with any other necessary administrative information.
- e. **Unit Commanders**
 - 1. During ceremonies, unit commanders give commands, units execute drill movements, and units employ formations described in this manual for the squad, platoon, and company. Formations for ceremonies may be modified by commanding officers when the nature of the grounds or exceptional circumstances require such changes.
- f. **The Place of Formation** for participating in a ceremony is as directed by the commander of the unit.

3-6 REVIEWS

a. Composition of a Review.

1. A review consists of four parts:
 - (a) Formation of the unit.
 - (b) Presentations and honors.
 - (c) Inspection (trooping the line).
 - (d) March in review.

b. Preparations of the Review Area.

1. The line on which the cadets are to form and along which they are to march is marked out by the host organization for the review. The post for the reviewing officer, opposite the center of the line of troops, is marked on each flank with a flag. The illustration (Field Marking In Preparation For A Review) shows the minimum markings for a review area. Additional flat markers may be used to designate the subordinate unit commander's posts, unit guide posts and turning points for approaching the line of troops.

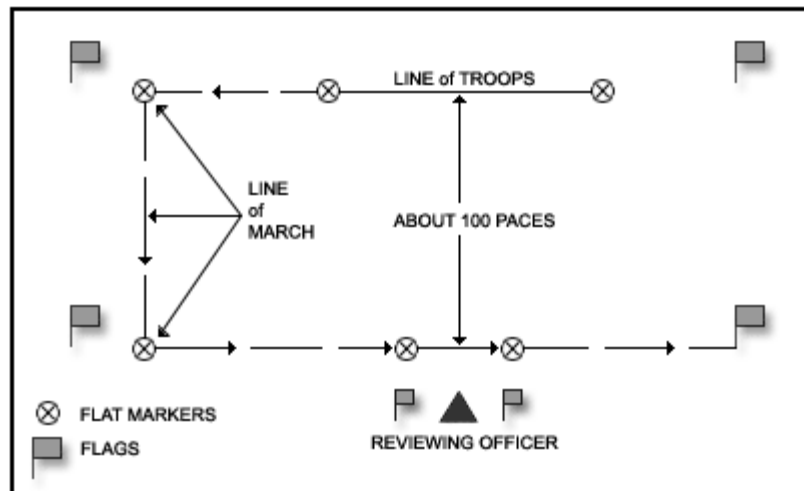

FIELD MARKING IN PREPARATION FOR A REVIEW

c. Cadet Formation.

1. Cadets form in line for a review. Depending on the size and number of units involved in a ceremony and the conditions of the area of the review, the units of cadets can form either as a company in a column of platoons or with the company in mass (all platoons gathered together). The cadets may be armed with rifles or not as the commander of the unit directs.

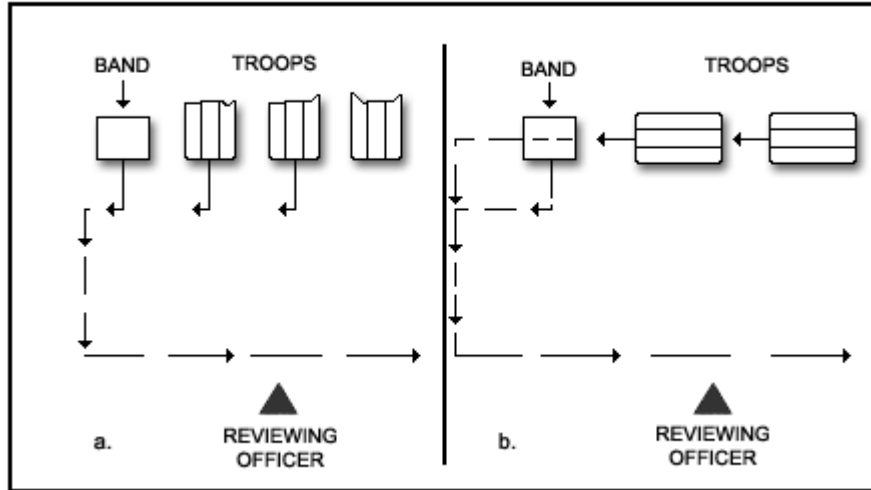

TROOP FORMATIONS

1. If Marine and Navy units are participating jointly in an NROTC unit's review, the Marine units are placed ahead of the Navy units. If all three services are participating, the order of march is Army, Marine Corps and Navy from the head of the column to the end. If the five services are participating, the order is Army, Marine Corps, Navy, Air Force and Coast Guard.
2. The order of march in a review consisting of active, reserve and NROTC units can be determined by referring to SECNAVINST 5060.22.
3. Cadets take their prescribed positions on the line of troops prior to the Adjutant's (second in command) call for the review. Then, under the supervision of the Adjutant, at the command dress **RIGHT DRESS**, the cadets are dressed to the right and the guides posted.
4. After all the cadet units are dressed, the Adjutant then presents the units to the commander of the troops. To present the cadets to the commander of the troops, the Adjutant gives the command **PRESENT, ARMS**. When all the units are at present arms, the Adjutant faces the commander of the troops and reports **"Sir, the parade is formed."** The commander of the troops returns the salute and directs the adjutant to **TAKE YOUR POST, SIR**. The Adjutant then marches around the commander of the troops to his/her post in the staff, halts and comes to carry sword. When the Adjutant is in position, the commander of the troops then commands **ORDER, ARMS**.

d. Presentation and Honors.

1. As the reviewing officer approaches his/her post, the commander of the troops calls the cadet units to attention.
2. When the reviewing officer is in position, the commander of the troops directs his/her command to present arms. When all units have presented arms, he/she faces the reviewing officer and salutes. His/her staff salutes with him/her. Look at the illustration below for the positions of the units, the spacing and positions of the officers.

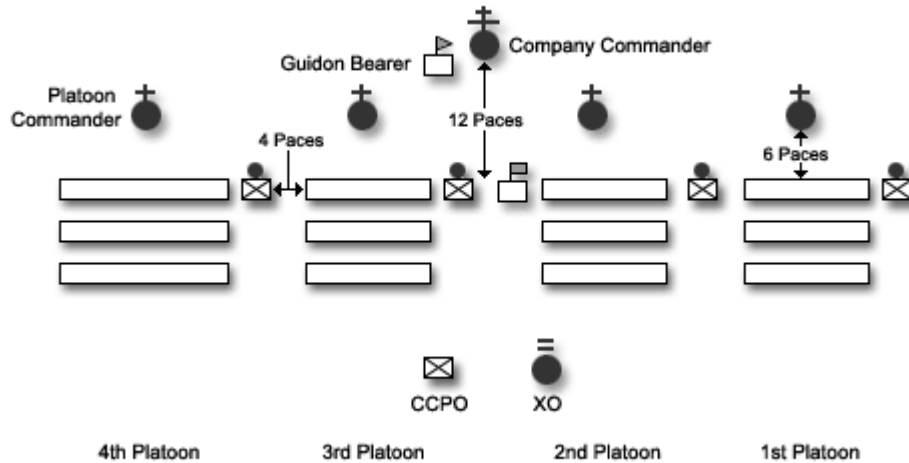

COMPANY IN LINE

3. If the reviewing officer's rank entitles him/her honors, they are rendered to the reviewing officer by the band. When the honors are completed, the commander of the troops terminates his/her salute and brings the cadets to order arms.
4. When the rank of the reviewing officer entitles him/her to the honor, each organizational color salutes with its command.
5. The reviewing officer, his/her staff and all military spectators in uniform and covered, salute at the first note of the music. They hold their salutes until the music and/or gun salute is completed.

e. Inspection

1. After the honors, the reviewing officer makes whatever general inspection of the units he/she may desire. A detailed inspection is not generally a part of the ceremony or review. Should a detailed inspection be the case, it is conducted in the same manner as described in chapter 12 of this manual.
2. The band plays while the reviewing officer makes his/her inspection of the cadet units.
3. After resuming his/her post after the inspection, the commander of the troops faces the units and orders the units to attention. After the units are at attention, presentations of decorations (which will be covered later) may be conducted, and then the units are marched in review. If there is no presentation of decorations, the units march in review.

f. March in Review

1. After the reviewing officer has taken his/her position in the reviewing area and the cadets are at attention, the commander of the troops commands **PASS IN REVIEW**. The commander and his/her staff proceed to the head of the column, and order the company along the route of the review.
2. The commander of the troops and his/her staff salute and execute eyes right when six paces from the nearest member of the reviewing party. They hold

their salutes and eyes position until six paces beyond the reviewing party. The platoon commanders of following companies (units) command **EYES, RIGHT** to their units in the same manner and place.

3. After saluting the reviewing officer while marching in review, the commander of the troops and staff turn out of column and take a position on line with and to the right of the reviewing officer. The commander and staff return sword and render hand salutes as the national colors pass.
4. When the last unit has passed in review, the commander of the troops faces the reviewing officer and renders a hand salute. When the salute is returned, he/she and the staff draw swords and follow the units off the parade grounds.

g. **Presentation of Decorations.**

1. Reviews for the purpose of the presentation of decorations are held, when practicable, when there are:
 - (a) presentation of NJROTC awards and decorations
 - (b) presentations of United States decorations
 - (c) decorations of organizational colors
 - (d) presentations of foreign decorations
2. Formations and procedures for these reviews are the same as discussed previously until the reviewing officer completes his/her inspection. At this time, the following procedures are to be executed.
3. Procedure for the positioning of persons to be decorated is as follows:
 - (a) After the reviewing officer has inspected the cadets and resumed his/her post, the commander of the troops, from his/her post, does an about face and commands **PERSONS TO BE DECORATED AND ALL COLORS, CENTER, MARCH**. On **MARCH**, persons to be decorated and all colors move by the most direct route to form single ranks in the center of the command, starting 15 paces in front of the line of company (unit) commanders. They form according to the rank of the decoration to be conferred, the highest decoration on their right. Those to receive the same decorations take positions according to seniority within each group.
 - (b) Colors to be decorated form a single rank five paces in front of the center of the line of persons to be decorated. The color to receive the highest decoration is on the right.

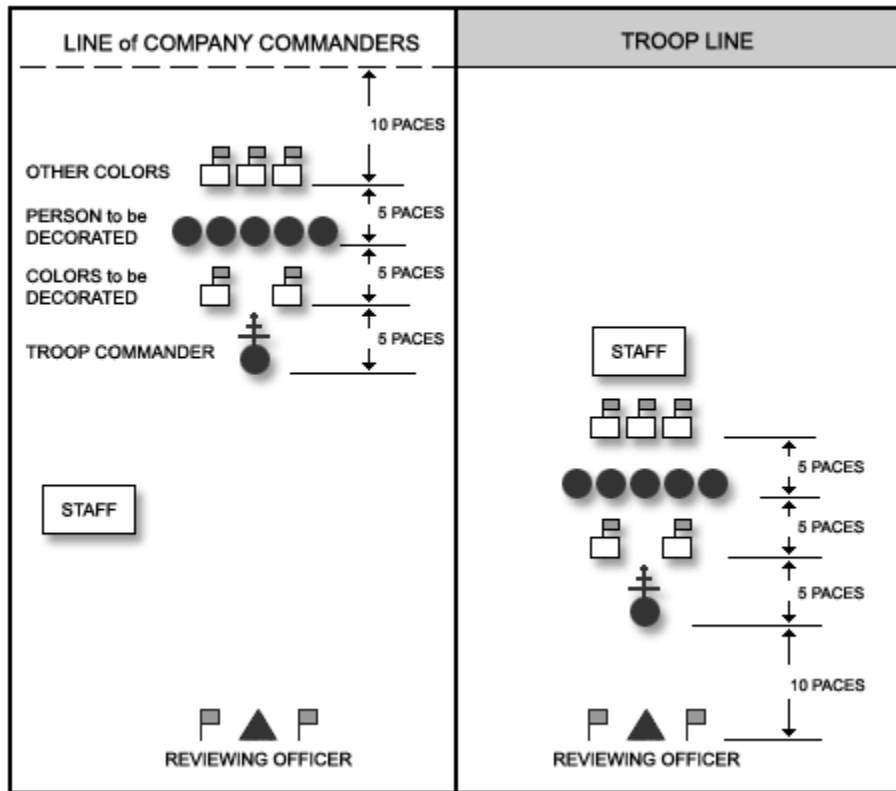

PRESENTATION OF DECORATIONS

- (c) All other colors with color guards form a single rank five paces behind the center of the line of persons to be decorated. Each color is in the same relative position as its parent unit within the formation for review. Note the illustration.
4. The presentation of the persons and/or colors to be decorated is made by the commander of the troops.
 5. The presentation of the awards/decorations commences with the reading of the orders and citations of the awards to be presented by a designated staff officer. In ceremonies involving many awards that are the same, the commanding officer may direct that only one be read. For awards to individuals, the reviewing officer attaches the decoration on the uniform over the left breast pocket, presents the citation and shakes the hand of each decorated person. Immediately after shaking hands, the person decorated salutes the reviewing officer. The salute is returned, and the reviewing officer proceeds to the next person being decorated. After shaking hands with the last person, the reviewing officer resumes his/her post.
 6. The persons decorated/awarded, at the command of the senior, form line at normal interval on the left of the local commander. The colors return to their posts by the most direct route. When the colors have taken their posts, the reviewing officer directs the commander of the troops to march the command in review.

3-7 STREET PARADES

- a. **General**. In addition to the pass-in-review type events in which cadets will occasionally be involved, they will often be called upon to participate in street parades, etc. Street parades are considerably less formal with respect to the reports and procedures for conducting the parade than the military ceremonies since most street parades are run by civilian organizations.
- b. **Grand Marshal**. Street parades are organized and directed by a person designated as Grand Marshal. He appoints his aides and issues orders as to how the parade is to be conducted, where the individual units will form, and their positions in the line of march.
- c. **Formations for Parades**. All participating units will form in the same manner as for a review. Normally, the units will form on side streets and march into position as directed by the Grand Marshal.
- d. **Review of the Parade**. The Grand Marshal may lead the parade the entire distance or may review the parade from a location along the parade route.
- e. **Importance of Participation**. Cadets should look upon participation in a parade, especially in the civilian community, as an important part of their training. Cadets should make every effort to prepare themselves and their uniforms in such a way as to bring credit on their school and unit. This is the opportunity to "strut your stuff" and make your parents and school proud of your efforts.

STUDY GUIDE QUESTIONS

CHAPTER 3: MILITARY CUSTOMS, COURTESIES, ETIQUETTE AND CEREMONIES

1. What message does the U.S. Flag give the American people and the world?
2. How does heraldry influence the way the American flag is placed and handled?
3. What procedure must be followed in raising and lowering the flag on a day when it is to be flown at half-staff?
4. What is meant by the following terms used in relation to the flag of the United States?
 - a. National flag
 - b. National ensign
 - c. Union Jack
5. What do personnel in full uniform do during the Pledge of Allegiance and the National Anthem?
6. What do the colors of the American flag represent?
7. Why are ceremonies, customs and courtesies important to military organizations?
8. What are the four types of ceremonies?
9. What is the composition of a review?
10. What is a custom?
11. What is a tradition?
12. What is courtesy?
13. How is a street parade different from a military review?
14. Who organizes and directs street parades?
15. How does one properly retire the national flag when it is no longer suitable for display?
16. From memory, write "The Pledge of Allegiance".
17. In a joint/combined review of the 5 uniformed services, what is the order of march?
18. Describe the process for reviewing awards to individuals. Include actions taken by both the presenter and the receiver.
19. Define the term "half staff".

CRITICAL THINKING QUESTIONS

1. Do you recite the Pledge of Allegiance in your school? Do you feel you are forced to participate? How do you feel about saying it?
2. Do you think that most students think about what they are saying when they recite the Pledge of Allegiance? If not, do you think they would feel differently about it if they thought more about the meaning?

ACADEMIC CONTENT STANDARDS

Civics Standard 9 - Understands the importance of Americans sharing and supporting certain values, beliefs, and principles of American constitutional democracy. Benchmark: Understands how certain values are fundamental to public life.

Civics Standard 11 - Understands the role of diversity in American life and the importance of shared values, political beliefs, and civic beliefs in an increasingly diverse American society. Benchmarks: Knows a variety of forms of diversity in American society; Knows major conflicts in American society that have arisen from diversity; Knows ways in which conflicts about diversity can be resolved in a peaceful manner that respects individual rights and promotes the common good; Knows why it is important to the individual and society that Americans understand and act on their shared political values and principles.

VOCABULARY WORDS

BADGE

An emblem or other device displayed on a flag, generally on the fly.

BANNER

A rectangular flag used by a king, prince, duke, or other noble. The coat of arms of the owner covers the banner's entire surface. The term is also loosely applied to a national flag (e.g. the "Star-Spangled Banner") and is today synonymous with flag.

CANTON

The four corners of a flag are named cantons, especially the upper quarter of the hoist, that is, the upper left hand corner of the flag; the canton is sometimes also called the union.

COLORS

The national and regimental or armorial flags carried by dismounted organizations (such as a color guard). Hence, the national color for Army and Marine Corps regiments is the U.S. flag. The term also applies to the national ensign flown aboard a naval vessel.

ENSIGN

A special flag based on a country's national flag and used exclusively on naval ships or merchant ships. The civil ensign is the merchant marine's flag. The U.S. flag serves as a national flag, naval ensign, and civil ensign. Great Britain, on the other hand, has a white ensign for naval ships, a red ensign for merchant ships, and a blue ensign for merchant ships commanded by an officer in the Naval Reserve.

FIELD

The ground of each division of a flag

FLY

The half or edge of a flag farthest away from the staff or flagpole. This term also sometimes refers to the horizontal length of a flag.

GARRISON FLAG

A large U.S. flag flown at forts. During the War of 1812, garrison flags were 20 feet by 40 feet. The Star-Spangled Banner measures 30 feet by 42 feet.

HALYARD

The rope by which a flag is raised on a flagpole.

HOIST

(N.) the half or edge of a flag nearest the staff or flagpole. This term also sometimes refers to the vertical width of a flag. (Vb.) to raise a flag.

HOIST ROPE

The rope on which a flag is flown on a flagpole.

JACK

A flag flown at the bow of warships when anchored. Great Britain's jack - the British Union Jack - combines the Crosses of St. George, St. Andrew, and St. Patrick on a blue field. The U.S. Union Jack carries 50 white stars on a blue field (the canton of the Naval Ensign). According to U.S. Navy regulations, the U.S. Union Jack should be the same size as the canton of the Naval Ensign flown at the ships stern.

MULLET

A five pointed star, representative of a knight's spur.

STAFF

A small pole from which a flag is flown.

STANDARD

A flag which is colored according to the owner's livery and displays the owner's badge or badges instead of his arms. The terms "national standard" is used to describe the national and regimental flags carried by mounted or motorized organizations.

STORM FLAG

The U.S. flag which is flown at military installations during inclement weather. It is smaller than the U.S. flag that is usually flown at the installation.

UNION

A flag or device of a flag symbolizing the union of countries or states. Also, the canton of (1) the U.S. flag, (2) British ensigns, and (3) British Commonwealth flags that are based on the British ensigns.

CHAPTER 4: PERSONNEL INSPECTION

4-0 OBJECTIVES

- 4-0.1 Describe the techniques for conducting a personnel inspection.
- 4-0.2 Explain the Inspecting Officer's duties (tour) when he/she inspects a platoon.
- 4-0.3 Explain the general Inspection Guidelines (items) that inspecting officers look for when inspecting a cadet in a platoon.

4-1 GENERAL

- a. Personnel inspections often require a lot of preparation, and they reveal a lot of things about the individual cadets to the NSI and to school officials.
- b. One of the positive things personnel inspections can promote as far as the individual cadets are concerned, is that it gives those hard-working cadets the opportunity to demonstrate the self-discipline, attention to detail, and pride they have in their unit and the things they have learned. The best part is that the naval science instructors get a chance to see what the cadets have learned.
- c. The naval science instructors and school officials can learn the condition of many aspects of the training, morale and leadership that exists in their unit by the appearance of the cadets. Parents can also see the value of the NJROTC program and take great pride in their sons and daughters for all their efforts.

4-2 FORMING FOR INSPECTION

- a. The company/platoon is the basic unit for inspection. The company falls in for inspection by platoons. A unit composed of a battalion may be inspected "en masse" for special occasions. Before the inspection, the cadets will have been informed of the time to fall in and will be in ranks and mustered by that time. The following procedures are those normally followed:
 - 1. **PREPARE FOR INSPECTION**. This is the command given by the company commander at the appointed time for the inspection. At this time, the following actions take place.
 - (a) The platoon commander of the first (base) platoon faces his platoon and gives the command **OPEN RANKS, MARCH**. The cadets in the first rank take two steps forward, the second rank takes one step forward and the third rank remains stationary. The cadets automatically come to dress right, while at the same time raising their left arm to get the proper interval.
 - (b) The first platoon commander aligns each rank by sighting down the rank and directing individuals to move if not in line. After verifying the alignment, the platoon commander marches to a position three paces beyond the front rank, faces left and commands **READY FRONT; COVER**. The platoon leader then takes one pace forward and faces front. It is in this position that the platoon commander receives the inspecting officer.

- (c) Each of the other platoon commanders aligns his platoon in sequence on the first platoon. When all platoon commanders have taken their posts, the company commander reports the company ready for inspection. When acknowledged, he gives the command, **AT EASE** or other command ordered.

4-3 INSPECTING OFFICER'S TOUR

- a. The inspecting officer proceeds to the first platoon and takes a position one pace in front of and facing the platoon and the platoon commander.
1. As the inspecting officer approaches the platoon, the platoon commander turns his head and gives the command **ATTENTION**.
 2. Upon the arrival of the inspecting officer, the platoon commander salutes and reports "First platoon (Drill Team, etc.) is standing by for your inspection, Sir." If the platoon commander is armed he will go to return sword after saluting and being inspected.
 3. The inspecting officer then proceeds to the first person in the first rank (the guide). The inspecting officer, at his discretion, may direct the platoon commander to put the ranks not being inspected at ease. If this is the case, the platoon commander will bring those ranks to attention when it is their turn to be inspected.
 4. The platoon commander will move to a position ahead of the inspecting officer as he inspects. If armed with a sword, the platoon commander will execute **RETURN SWORD** prior to joining the inspecting officer. The inspecting officer proceeds from cadet to cadet by stepping off to the right as in marching, halting, and executing a left face. (The platoon commander must follow this same procedure in order not to be in the way of the inspecting officer).
 5. After inspecting the front of the first rank, the inspecting officer inspects the rear of that rank and so forth for each rank.
 6. At the conclusion of the inspection, the platoon commander proceeds to a position three paces in front of and one pace to the side of the first rank, faces left (draws sword if so armed), commands **ATTENTION**, takes one step forward, then faces right.
 7. The inspecting officer proceeds to a position one pace in front of the platoon commander and makes any remarks he deems necessary. The inspecting officer and the platoon commander exchange salutes, and the inspecting officer proceeds to the next platoon.
 8. Upon completion of the inspection of each platoon, its commander faces left and orders **CLOSE RANKS, MARCH**. At the command **MARCH**, the platoon commander moves by the most direct route and takes his post six paces in front of the center of his platoon. The command **AT EASE** or **PARADE REST** will be given from this position.

4-4 INSPECTION GUIDELINES

- a. No two inspecting officers inspect in the same way. Some look at the overall appearance of the individuals, while others may act as though they want to see their face in the reflection from your "spit shined" shoes.
- b. An important aspect that an inspecting officer must try to keep in mind is not only what looks good but also what is correct according to the uniform regulations.
- c. In general, the inspecting officer should start with the overall "look" of the cadets and then check specific items. The first impression is very important. Some of these items include:
 1. Does everything look like it is in the right place and worn correctly?
 2. Does the cadet display good posture?
 3. Is the cap clean, neat, positioned correctly and in good repair?
 4. Are all insignia and devices positioned correctly?
 5. Is the cadet's face and hair clean and groomed properly?
 6. Are the trousers/skirts, shirts, etc. clean, pressed, fit properly and in good repair?
 7. Are the shoes shined and in good repair?
 8. Are the ribbons and/or awards correct (having been earned), worn in the proper order of precedence and properly positioned on the uniform?
 9. Are the Service Designations (stars) positioned properly?
 10. Is the aiguillette worn on the correct shoulder?
 11. Is the cadet wearing unauthorized jewelry?
 12. Has the cadet tied the necktie correctly?

SAMPLE INSPECTION SCORE SHEET

Cadet's Name: _____

Score: _____

**Points
Deducted**

Item

Cap: (Cleanliness/neatness/brim/chinstrap/buttons/cover/insignia)	_____
Hair: (Length/neatness/taper/cleanliness/style)	_____
Shave: (Neck/face/mustache)	_____
Jewelry: (Amount/type/appropriateness)	_____
Shirt/Jacket: (Fitness/cleanliness/press)	_____
NJROTC Patch: (Position/condition/sewing)	_____
Collar Devices: (Condition/position)	_____
Tie: (Position/condition)	_____
Name Tag: (Position/condition)	_____
Ribbons: (Order/position/condition)	_____
Fingernails: (Cleanliness/trim/color)	_____
Gigline: (Trousers in line/belt buckle/shirt in line)	_____
Belt/Buckle: (Fit/condition)	_____
Trousers/Skirt/Slacks: (Length/cleanliness/fit/press)	_____
Shoes: (Condition/shine/heels/welts)	_____
Socks/Hose: (Color/condition)	_____
Posture/Bearing:	_____
Other Deductions: (_____)	_____
Total points deducted from 100 possible:	_____

Note:

Although the above score sheet can be used for all cadets, some units may prefer to make separate male and female score sheets with additional items of inspection.

STUDY GUIDE QUESTIONS

CHAPTER 4: PERSONNEL INSPECTION

1. What is one of the positive results personnel inspections can promote?
2. What can the naval science instructors and school officials learn from inspecting a unit?
3. What is considered to be the basic unit for inspection?
4. What is the command given by the company commander to the platoon commanders at the appointed time for inspection?
5. What does the first squad do when the platoon commander of a three squad platoon gives the command "Open Ranks, MARCH"?
6. What does the third squad do when the platoon commander of a three squad platoon gives the command "Open Ranks, MARCH".
7. After verifying alignment, the platoon commander marches to a position _____ pace(s) beyond the front rank, faces left and commands "Ready FRONT, COVER".
8. The inspecting officer proceeds to the first platoon and takes a position _____ pace(s) in front of and facing the platoon and the platoon commander.
9. Upon arrival of the inspecting officer, the platoon commander salutes and reports _____
10. While the inspecting officer inspects each squad, the platoon commander will move to a position _____ of the inspecting officer as he inspects.
11. At the conclusion of the inspection, the platoon commander proceeds to a position _____ pace(s) in front of and _____ pace(s) to the side of the first rank.
12. Upon completion of the inspection of each platoon by the inspecting officer, its platoon commander faces left and orders _____.
13. What can the platoon commander order the platoon to do after it has closed ranks?
14. What position does the platoon commander take after the inspecting officer departs the platoon and the platoon has closed its ranks?
15. The inspecting officer should start the inspection of each cadet with an overall "look" and then check specific items. What are the most correct items to be inspected by the inspecting officer?
16. What in general are the items that the inspecting officer inspects during inspection?
17. When inspecting a cap, what items are normally checked by the inspecting officer?
18. When inspecting cadet hair, what are the items normally checked by the inspecting officer?

CRITICAL THINKING QUESTIONS

1. Why are ceremonies, customs, and courtesies important to military organizations?
2. How did the tradition of personnel inspections start?

EXTENSION ACTIVITY

Research various military JROTC organizations regarding personnel inspection, honors and ceremonies and how those organizations personnel inspections differ from the NJROTC personnel inspection requirements.

INTERDISCIPLINARY CONNECTION

Research the British Royal Navy's origins of their military personnel inspections and the historical background that formed the basis for the United States Navy's personnel inspections and traditions.

ACADEMIC CONTENT STANDARDS

Language Arts Standard 7: Demonstrates competence in the general skills and strategies for reading a variety of informational texts. **Benchmarks:** Applies reading skills and strategies to a variety of informational texts; Knows the defining characteristics of a variety of informational texts; Determines the effectiveness of techniques used to convey viewpoint; Uses discussions with peers as a way of understanding information.

Historical Understanding Standard 2: Understands the historical perspective. **Benchmarks:** Understands that specific individuals and the values those individuals held had an impact on history; Analyzes the influence specific ideas and beliefs had on a period of history; Analyzes the effects that specific "chance events" had on history; Analyzes the effects specific decisions had on history.

VOCABULARY WORDS

Inspection

A checking or testing of an individual against established standards.

Self-discipline

Correction or regulation of oneself for the sake of improvement.

"En masse"

As a whole.

CHAPTER 5: REQUIREMENTS FOR THE NJROTC PHYSICAL FITNESS RIBBON

5-0 OBJECTIVES

5-0.1 Explain the requirements for the NJROTC Physical Fitness Ribbon.

5-1 INTRODUCTION

- a. The PFT ribbon will be awarded on different levels, with only the most recent PFT cycle counting toward lamps worn on the ribbon. In order to earn a ribbon, a cadet must achieve an overall point score at a level of "satisfactory" or better using the NJROTC Physical Readiness Point Table, and achieve the minimum requirement of "satisfactory" in every event. The award levels are as follows:
 - (1) Ribbon. Achieve an overall point score of "**satisfactory**" and achieve the minimum requirements to be satisfactory in each event.
 - (2) Ribbon with **bronze lamp**. Achieve an overall point score of "**good**" and achieve the minimum requirements to be satisfactory in each event.
 - (3) Ribbon with **silver lamp**. Achieve an overall point score of "**excellent**" and achieve the minimum requirements to be satisfactory in each event.
 - (4) Ribbon with **gold lamp**. Achieve an overall point score of "**outstanding**" and achieve the minimum requirements to be satisfactory in each event.
- b. Additional successful PFT achievement will make a cadet eligible for stars on his/her ribbon according to the criteria listed on page 1-33.
- c. Cadets who earn the PFT ribbon are encouraged to maintain or improve the level of physical fitness with each consecutive physical fitness test. If a lamp is worn on the ribbon, it will reflect the level of achievement from the most recent semi-annual PFT offered by the unit. For example, if a cadet has previously earned the silver lamp with a score of "excellent," but scores only at the "good" level at the next PFT, the silver lamp on the ribbon will be replaced with a bronze lamp. Likewise, if a cadet fails to achieve a physical fitness score recognized by a bronze lamp, or does not participate in the unit's scheduled semi-annual PFT or an approved make-up PFT (for valid medical reasons), the wearing of a bronze lamp device is no longer authorized. In this case, the cadet can wear only the PFT ribbon and any stars earned to date, if applicable.
- d. The commander of a physical fitness team will wear the gold anchor on the Physical Fitness Ribbon as described in chapter 1.

APPENDIX 1: MILITARY CHAIN OF COMMAND

6-0 OBJECTIVES:

6-0.1 Explain the chain of command as it relates to an effective and functioning cadet organization.

6-1 GENERAL

- a. Recognition of the military chain of command is long established in the Navy. The chain extends from the president to the most junior seaman recruit. Each individual must understand that this system is not only mandated by regulations, but is a form of naval courtesy. This means respecting and being prompt in orders from seniors, and being fair and compassionate toward juniors while still exacting obedience from them.
- b. The Navy's NJROTC program is organized like a pyramid, with one person on top and many people (cadet seaman recruits) on the bottom. For NJROTC purposes, from the highest to the lowest, it runs like this:

<u>Title Name</u>	
<u>Title</u>	<u>Name</u>
1. Commander-in-Chief (President of U.S.)	
2. Secretary of Defense	
3. Secretary of the Navy	
4. Chief of Naval Operations	
5. Commander, Naval Education and Training Command	
6. Commander, Naval Service Training Command	
7. NJROTC Area Manager	

- c. Other positions that fall under the NJROTC chain of command, some of which may not necessarily be in the following order, include the Senior Naval Science Instructor, Naval Science Instructor, Cadet Commanding Officer, Cadet Executive Officer, Cadet Operations Officer, Administrative Officer, Communications Officer, Public Affairs Officer, Supply Officer, Team Commanding Officers, Ordnance Officer, Company Chief Petty Officer, Platoon Commanders, Mustering Chief Petty Officer, Platoon Guide Bearers, Squad Leaders, and Naval Cadets.
- d. You may start out at the bottom of the pyramid in your NJROTC unit, but your naval science instructors and senior cadets will spend a lot of time training you into the kind of person who can move up to positions of leadership. Remember that everyone in the NJROTC unit began at the bottom of the chain of command; your seniors were once seaman recruits also.
- e. The uniform and the insignia worn by an NJROTC cadet shows at a glance his or her rate or rank and thus his or her level of authority in the unit. You must quickly learn to identify the officers, chiefs and petty officers in the NJROTC unit chain of command.

(THIS PAGE INTENTIONALLY LEFT BLANK)

APPENDIX 2: ORDERS TO THE SENTRY

(OPNAVINST 3120.32C - 4/94)

1. TAKE CHARGE OF THIS POST AND ALL GOVERNMENT PROPERTY IN VIEW.
2. WALK MY POST IN A MILITARY MANNER, KEEPING ALWAYS ON THE ALERT, AND OBSERVING EVERYTHING THAT TAKES PLACE WITHIN SIGHT OR HEARING.
3. REPORT ALL VIOLATIONS OF ORDERS I AM INSTRUCTED TO ENFORCE.
4. REPEAT ALL CALLS FROM POSTS MORE DISTANT FROM THE GUARDHOUSE OR THE QUARTER-DECK THAN MY OWN.
5. QUIT MY POST ONLY WHEN PROPERLY RELIEVED.
6. RECEIVE, OBEY, AND PASS ON TO THE SENTRY WHO RELIEVES ME, ALL ORDERS FROM THE COMMANDING OFFICER, COMMAND DUTY OFFICER, OFFICER OF THE DAY, OFFICER OF THE DECK, AND OFFICERS AND PETTY OFFICERS OF THE WATCH ONLY.
7. TALK TO NO ONE EXCEPT IN THE LINE OF DUTY.
8. GIVE THE ALARM IN CASE OF FIRE OR DISORDER.
9. CALL THE CORPORAL OF THE GUARD OR OFFICER OF THE DECK IN ANY CASE NOT COVERED BY INSTRUCTIONS.
10. SALUTE ALL OFFICERS AND ALL COLORS AND STANDARDS NOT CASSED.
11. BE ESPECIALLY WATCHFUL AT NIGHT, AND DURING THE TIME FOR CHALLENGING, CHALLENGE ALL PERSONS ON OR NEAR MY POST, AND ALLOW NO ONE TO PASS WITHOUT PROPER AUTHORITY.

Note: All NJROTC cadets will sound off in a loud, clear voice when asked for a particular order as shown in the following example:









Commanding officer: "Cadet, what is the 5th Order To The Sentry?"

Cadet: "Sir/Ma'am, the 5th Order To The Sentry is: Quit my post only when properly relieved."

(THIS PAGE INTENTIONALLY LEFT BLANK)

APPENDIX 3: MARINE CORPS RATES AND RANKS

SLEEVE INSIGNIA FOR MARINE CORPS RANKS AND RATES

ENLISTED RANKS		SLEEVE INSIGNIA
Pay Grade:	E-1	
Title:	Private	None
Abbreviation:		
Pay Grade:	E-2	
Title:	Private First Class	
Abbreviation:	PFC	
Pay Grade:	E-3	
Title:	Lance Corporal	
Abbreviation:	LCPL	
Pay Grade:	E-4	
Title:	Corporal	
Abbreviation:	CPL	
Pay Grade:	E-5	
Title:	Sergeant	
Abbreviation:	SGT	
Pay Grade:	E-6	
Title:	Staff Sergeant	
Abbreviation:	SSGT	
Pay Grade:	E-7	
Title:	Gunnery Sergeant	
Abbreviation:	GYSGT	
Pay Grade:	E-8	
Title:	Master Sergeant (MSGT) / First Sergeant	
Abbreviation:		
Pay Grade:	E-9	
Title:	Sergeant Major (SGTMAJ) / Master Gunnery Sergeant (MGYSGT)	
Abbreviation:		
Pay Grade:	E-9	
Title:	Sergeant Major of the Marine Corps	
Abbreviation:	SGTMAJMC	

WARRANT OFFICER RANKS	INSIGNIA	INSIGNIA COLORS
-----------------------	----------	-----------------

Pay Grade: W-1
 Title: Warrant Officer 1
 Abbreviation: W0



Red and Gold

Pay Grade: W-2
 Title: Chief Warrant Officer 2
 Abbreviation: CW02



Red and Gold

Pay Grade: W-3
 Title: Chief Warrant Officer 3
 Abbreviation: CW03



Red and Silver

Pay Grade: W-4
 Title: Chief Warrant Officer 4
 Abbreviation: CW04







Red and Silver

Pay Grade: W-5
 Title: Chief Warrant Officer 5
 Abbreviation: CW05



Red and Silver

OFFICER RATES		INSIGNIA	INSIGNIA COLORS
Pay Grade: Title: Abbreviation:	O-1 Second Lieutenant 2nd LT		Gold
Pay Grade: Title: Abbreviation:	O-2 First Lieutenant 1st LT		Silver
Pay Grade: Title: Abbreviation:	O-3 Captain CAPT		Silver
Pay Grade: Title: Abbreviation:	O-4 Major MAJ		Gold
Pay Grade: Title: Abbreviation:	O-5 Lieutenant Colonel LT COL		Silver
Pay Grade: Title: Abbreviation:	O-6 Colonel COL		Silver

OFFICER RATES	INSIGNIA	INSIGNIA COLORS
---------------	----------	-----------------

Pay Grade: O-7
 Title: Brigadier General
 Abbreviation: BRIG GEN



Silver

Pay Grade: O-8
 Title: Major General
 Abbreviation: MAJ GEN



Silver

Pay Grade: O-9
 Title: Lieutenant General
 Abbreviation: LT GEN



Silver

Pay Grade: O-10
 Title: General
 Abbreviation: GEN



Silver

NJROTC Drill Manual

INTENTIONALLY LEFT BLANK

CHAPTER 1

INTRODUCTION TO DRILL

1000. GENERAL

1. The Naval Junior Reserve Officers Training Corps Drill Manual is designed to provide uniformity and standardization for all NJROTC organizations. This manual prescribes procedures for all close order drill and military ceremonial evolutions.

2. The NJROTC Drill Committee conducted a review of all drill concerning NJROTC in order to standardize the way drill is conducted for cadets. As a result, this manual was developed to mirror MCO P5600.20, Marine Corps Drill and Ceremonies Manual (MCDCM), but was tailored to meet the needs of NJROTC at the company and battalion level. **Effective immediately, this manual is the primary source document for all NJROTC drill issues at the company and battalion level.** In rare cases involving regimental units and only as directed by this manual, refer to the MCDCM. Instructors will only deviate from prescribed procedures when expressly authorized for specific provisions of this manual.

3. Online Access

a. MCO P5600.20. Units may access the MCDCM at <http://www.usmc.mil>.

b. NJROTC Drill Manual. Units may access this drill manual at <http://www.NJROTC.org>. This website not only contains an electronic version of this manual but also sample LOIs for the various ceremonies described in this manual.

4. Changes to this manual. Your recommendations/comments to improve this manual are welcome. Please forward any recommendations to NETC (Attention: Curriculum Committee). **Use the NJROTC Program Academic Materials Form which is located at www.njrotc.org/main.** Please forward all changes to michael.s.Henderson@navy.mil

5. Training Time Out. During military drill exercises, a Training Time Out (TTO) should be called if cadets and instructors are concerned for their personal safety, or safety of others. When a TTO has been called, the military drill exercise must stop, the discrepancy corrected, and then if possible, continue the training. The TTO is an appropriate means for a cadet to obtain relief if he or she is experiencing pain, heat stress, or other serious discomfort during military drill.

1001. PURPOSE OF DRILL

1. Commanders use drill to:

a. Move units from one place to another in a standard, orderly manner.

b. Provide simple formations from which combat formations may be readily assumed.

c. Teach discipline by instilling habits of precision and automatic response to orders.

d. Increase the confidence of cadets through the exercise of command, by the giving of proper commands, and by the control of drilling troops.

e. Give cadets an opportunity to handle individual weapons.

2. Purpose of Formations

a. To build unit cohesion and esprit de corps by recognizing cadets during awards and promotion ceremonies.

b. To maintain continuous accountability and control of personnel.

c. To provide frequent opportunities to observe the appearance and readiness of the uniforms, arms, and equipment of the individual Cadet.

d. To keep the individual Cadet informed by providing the means to pass the word.

e. To develop command presence in unit leaders.

f. To instill and maintain high standards of military bearing and appearance in units and in the individual Cadet.

g. To add color and dignity to the daily routine by reinforcing the traditions of excellence associated with close order drill.

3. Scope. This manual prescribes drill for general use. Diagrams shown must be adapted to the strength of the unit and available space. Unless otherwise stated, whenever the masculine gender is used, both male and female gender is implied.

1002. DEFINITIONS. The following definitions are standard terms used throughout this manual.

1. Alignment. The dressing of several elements on a straight line.

2. Assembly Area. A designated location for forming units of platoon size or larger in preparation for a parade, review or ceremony.

3. Arms. A term used to normally designate the service rifle but can refer to any weapon. When in formation and a mix of weapons is carried the term arms will be used to designate all types of weapons.

4. Base. The element on which a movement is regulated.

5. Cadence. A rhythmic rate of march at a uniform step.

6. Center. The middle element of a formation with an odd number of elements (See figure 1-1a) or the left center element of a formation with an even number of elements. (See figure 1-1b.)

7. Ceremony. A formal military formation designated to observe a specific occasion.

8. Column. A formation in which elements are placed one behind the other. A section or platoon is in column when members of each squad are one behind the other with the squads abreast of each other.

9. Commander of Troops (COT). The COT is the senior Cadet taking part in the ceremony.

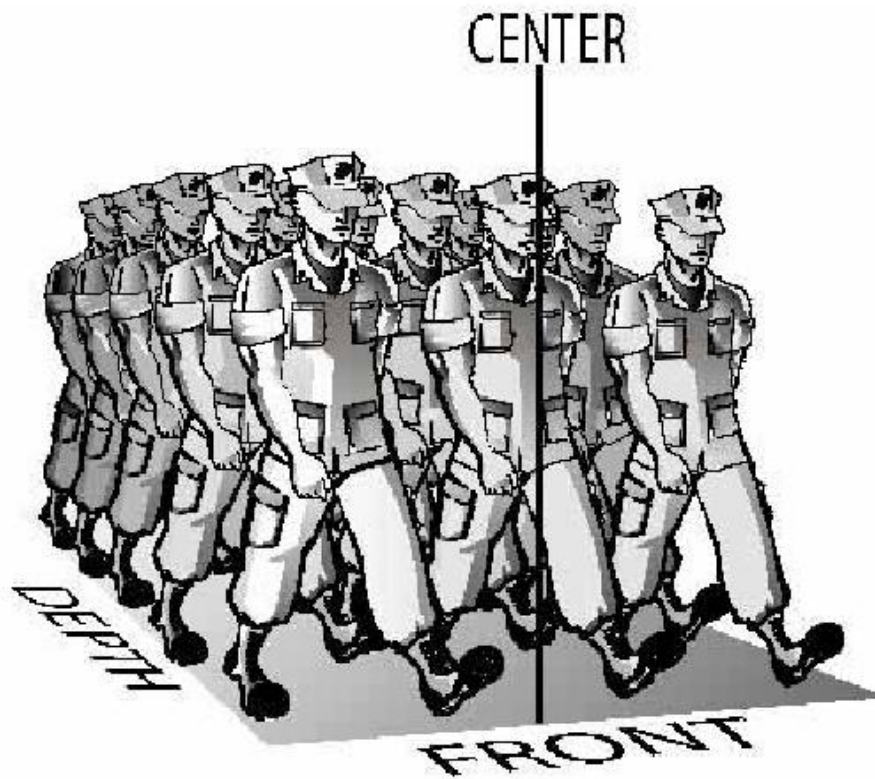

Figure 1-1a.--Center (Odd Number of Elements), Depth, and Front.

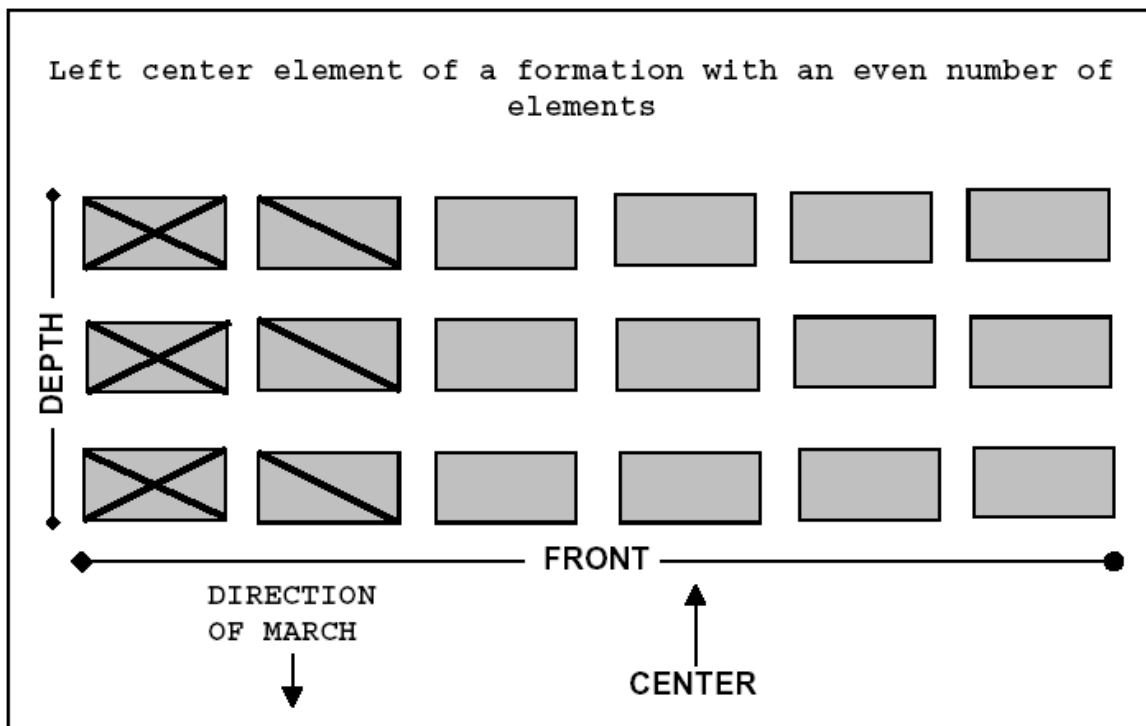

Figure 1-1b. --Center, Even Number of Elements.

10. Depth. The space from head to rear of an element or a formation. (See figure 1-1a.) The depth of an individual is considered to be 12 inches.

11. Distance. The space between elements in the direction of depth. Between individuals, the space between your chest and the person to your front. Between cadets in formation, the space from the front of the rear unit to the rear of the unit in front. Platoon commanders, guides, and others whose positions in a formation are 40 inches from a rank are, themselves, considered a rank. Otherwise, commanders and those with them are not considered in measuring distance between units. The color guard is not considered in measuring distance between subdivisions of the unit with which it is posted. In Cadet formations, the distance between ranks is 40 inches. (See figure 1-2.)

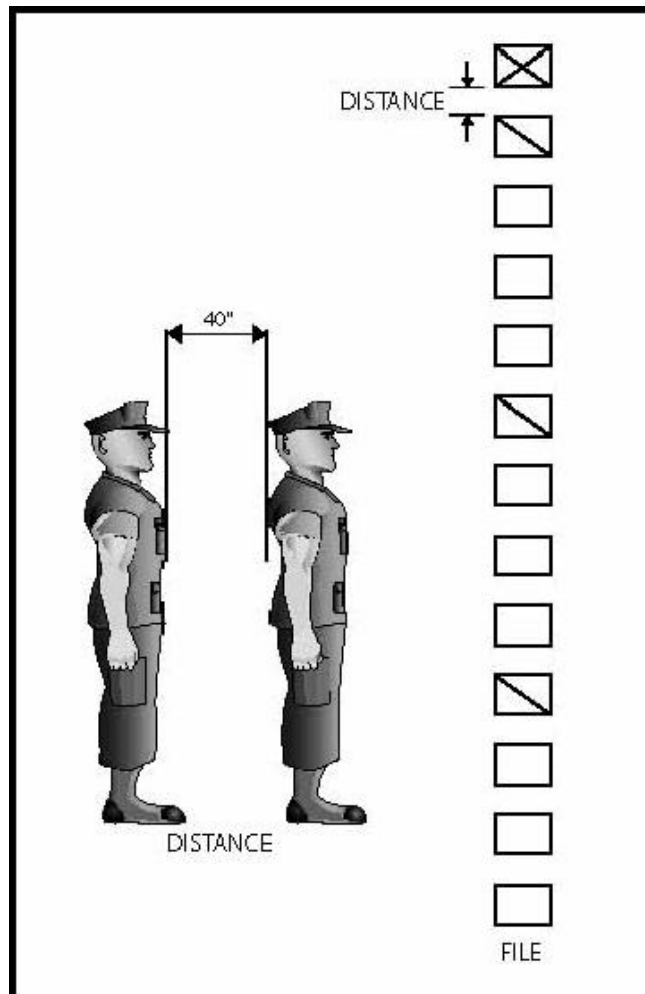

Figure 1-2.--Distance and File.

12. Double Time. Cadence at 180 steps (36 inches in length) per minute.
13. Element. An individual, squad, section, platoon, company, or other unit that is part of a larger unit.
14. Extended Mass Formation. The formation of a company or larger unit in which major elements are in column at close or normal interval and abreast at a specified interval greater than normal interval.
15. File. A single column of cadets one behind the other.
16. Flank. The right or left extremity of a unit, either in line or in column. The element on the extreme right or left of the line. A direction at a right angle to the direction an element or a formation is facing.
17. Formation. Arrangement of elements of a unit in line, in column, or in any other prescribed manner.

18. Front. The space occupied by an element or a formation, measured from one flank to the other. (See figure 1-1a.) The front of an individual is considered to be 22 inches.

19. Guide. The individual (base) upon whom a formation, or other elements thereof, regulates its march. To guide: to regulate interval, direction, or alignment; to regulate cadence on a base file (right, left, or center).

20. Head. The leading element of a column.

21. Interval. The lateral space between elements on the same line. (See figure 1-3.) Interval is measured between individuals from shoulder to shoulder. It is measured between elements other than individuals and between formations from flank to flank. Unit commanders and those with them are not considered in measuring interval between elements of the unit. Normal interval between individuals is one arm's length. Close interval is the horizontal distance when the left hand is placed on the left hip.

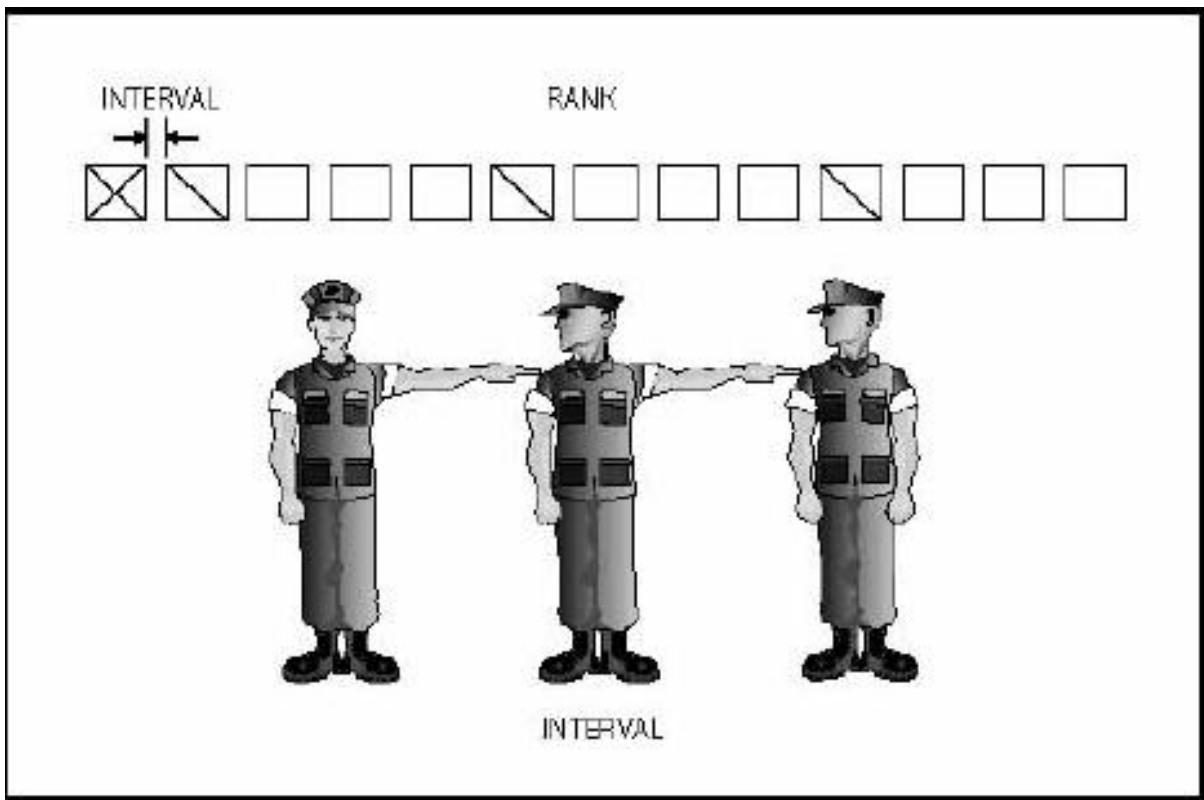

Figure 1-3.--Interval and Rank.

22. Left (Right). Extreme left (right) element or edge of a body of cadets.

23. Line. A formation in which the elements are side by side or abreast of each other. A section or platoon is in line when its squads are in line and one behind the other.

24. Line of March. The line on which individuals or units are to march on.

25. Line of Troops. The line on which cadets are to form when in formation.

26. Loosened Sling. Indicates a sling adjusted for the movement sling arms.

27. Mass Formation. The formation of a company or larger unit in which the major elements are in column at close interval and abreast at close interval.

28. Muffling. The procedure of draping colors for mourning with a mourning streamer or black bunting. It also refers to the process of muffling the musical instruments of a band for specific types of ceremonies.

29. Pace. The length of a full step in quick time, 30 inches.
30. Parade. A parade is a ceremony that involves the movement of marching units.
31. Parade Sling. A sling that has all excess slack removed and is taut. The keeper is adjusted and locked in a position next to the sling tip. The sling lies on the left side of the rifle.
32. Piece. An individual firearm such as a rifle.
33. Point of Rest. The point toward which all elements of a unit establish their dress or alignment.
34. Quick Time. Cadence at 112 to 120 steps (12, 15, or 30 inches in length) per minute. It is the normal cadence for drills and ceremonies.
35. Rank. A line of cadets placed side by side.
36. Review. A review is a type of ceremony that omits certain elements found in a parade, but includes an inspection (trooping the line) not found in a parade.
37. Rigged. This term refers to the condition when uniforms and equipment are properly fitted out in the manner for which they were intended for use. Swords are considered rigged when attached to the sword sling. A Cadet is rigged when wearing the prescribed uniform or equipment.
38. Slow Time. Cadence at 60 steps per minute. Used for funerals only.
39. Snap. In commands or signals, the quality that inspires immediate response. In drill the immediate and smart execution of a movement.
40. Step. The distance from heel to heel between the feet of a marching individual. The half step and back step are 15 inches. The right and left steps are 12 inches. The steps in quick and double time are 30 and 36 inches, respectively.
41. Unit Leader. Is the individual who is drilling the unit. This can be any individual who is conducting drill or can be those assigned a specific billet such as squad leader, mustering petty officer, platoon commander, etc.
42. Strong Grip. The strong grip is when the thumb is wrapped around the front of the staff with the fingers wrapped to the rear. (See figure 1-4.)
43. "V" Grip. The "V" grip is with the staff placed in the "V" formed by the thumb and forefinger with the fingers extended and joined. (See figure 1-5.)



Figure 1-4. Strong Grip.



Figure 1-5. "V" Grip.

1003. INSTRUCTING DRILL

1. Training cadets in drill is an important duty. From the beginning of their assignment as leaders, cadets should take pride in being considered efficient in teaching drill. If they know the drill regulations and how to instruct, they will gain the respect and confidence of those they command.

2. In addition, good leaders must:

a. Follow regulations strictly, as an example to the cadets under instruction.

b. Have energy, patience, and spirit.

c. Have military neatness and bearing.

d. Observe cadets closely, immediately correcting any mistakes noted.

3. When instructing drill movements the system described by the acronym P.C.W.C. will be used to ensure all required information is provided. P.C.W.C. stands for:

(P) Purpose of the movement.

(C) Number of Counts involved in its execution.

(W) When the movement may be executed.

(C) Commands to cause the movement to be executed.

4. When instructing drill movements for unit movement the system described by the acronym P.F.W.C will be used to ensure all required information is provided. P.F.W.C. stands for:

(P) Purpose of the movement.

(F) Formation from which the movement is executed.

(W) When the movement may be executed.

(C) Commands to cause the movement to be executed.

5. When the leader corrects a movement, the individual or unit should immediately be required to repeat the movement properly.

6. Before a drill period, a leader should thoroughly study the movements to be executed.

7. When teaching drill, leaders may place themselves wherever they can best control the cadets, make corrections, and ensure proper performance. **Refer to paragraph 8000.9 and 10 for additional information about the unit leader's position.**

8. The leader briefly explains and demonstrates each new movement prior to its execution by the cadets. The cadets should take proper positions unassisted. Each position or movement must be thoroughly understood before another is attempted.

9. Drill periods should be short but frequent. Snap should be required in every movement.

1004. INSTRUCTION GROUPS

1. The basic instruction group is the squad. Its size facilitates individual instruction.

2. Cadets who learn slowly should be placed in special squads. The best leaders available should drill these squads.

1005. COMMANDS AND THE COMMAND VOICE

1. There are four types of commands: preparatory commands, commands of execution, combined commands, and supplementary commands. All commands in this manual are shown in quotation marks and **bold print**, e.g., "**Present, ARMS.**"

a. The preparatory command indicates a movement is to be made and may also indicate the direction of the movement. In this manual, preparatory commands are shown beginning with a capital letter followed by lower case letters. The comma indicates a pause between the preparatory command and the command of execution. Examples would be "**Forward,**" "**Left,**" "**Platoon,**" "**About,**" etc.

b. The command of execution causes the desired movement to be executed. In this manual, commands of execution are shown in **CAPITAL LETTERS**. Examples would be "**MARCH,**" "**FACE,**" "**ATTENTION,**" etc.

c. With the combined command, the preparatory command and the command of execution are combined. In this manual combined commands are shown in **CAPITAL LETTERS**. Examples would be "**AT EASE,**" "**REST,**" "**FALL IN,**" etc.

d. Supplementary commands are commands that cause the component units to act individually. An example would be the commands squad leaders would give to their individual squads following the platoon commander's preparatory command, "**Column of Files From the Right,**" and before the command of execution "**MARCH.**" In this manual supplementary commands may be shown as preparatory commands, commands of execution or combined commands, depending on the movement.

2. When giving commands, commanders face their cadets.

a. For company formations or larger, when commanding marching cadets from the head of a column or massed formations, commanders march backward while giving commands.

b. When commanding a unit that is part of a larger unit, commanders turn their heads to give commands, but do not face about except when the unit is halted and the smaller units are in line. In this case, the leader faces about to give all commands except to repeat preparatory commands, for which turning the head is sufficient.

3. Commanders of platoons and larger units, when drilling as a part of a still larger unit, repeat all preparatory commands or give the proper new command or warning. There are three exceptions to this.

a. The first is that no repetition is necessary for combined commands such as "**FALL IN,**" "**FALL OUT,**" "**REST,**" or "**AT EASE.**"

b. The second is that no repetition of command is necessary when a unit is in mass formation.

c. The third exception is that no repetition of command is necessary during parades and ceremonies where the commander of troops, adjutant, etc., may be clearly heard by all hands; or the commander of troops and adjutant give combined commands and subordinate unit commanders cause their units to execute the command independently (e.g., when the regimental commander gives the combined command to "**PORT ARMS**" subordinate battalion commanders would give the command of "**Port, ARMS,**" so that their battalion would execute the command as an independent unit of the regiment).

4. If at a halt, the commands for movements, which involve marching at quick time in a direction other than to the direct front, such as "**Column Right, MARCH,**" are not prefaced by the preparatory command, "**Forward.**"

5. The only commands that use unit designations, such as "**Battalion**" or "**Company,**" as preparatory commands are "**ATTENTION**" and "**HALT.**" Such commands shall have no further designation added (e.g., "First Battalion, **ATTENTION**" or "**Company C, HALT**"). Commands shall be given only as stated herein.

6. A command must be given loud enough to be heard by all members of a unit.

a. Good posture, proper breathing, and the correct use of throat and mouth muscles help develop a commander's voice.

b. Projecting the voice enables one to be heard at maximum range without undue strain. To project a command, commanders must focus their voices on the most distant individuals. Good exercises for voice projection are:

(1) Yawning to get the feel of the open mouth and throat.

(2) Counting and saying the vowel sounds "oh" and "ah" in a full, firm voice.

(3) Giving commands at a uniform cadence, prolonging each syllable.

(4) When practicing, stand erect, breathe properly, keep the mouth open wide, and relax the throat.

c. The diaphragm is the most important muscle in breathing. It is the large horizontal muscle that separates the chest from the abdomen. It automatically controls normal breathing, but must be developed to give commands properly. Deep breathing exercises are one good method of developing the diaphragm. Another is to take a deep breath, hold it, open the mouth, relax the throat muscles, and snap out a series of fast "hats" or "huts." Expelling short puffs of air from the lungs should make these sounds. If properly done, you can feel the stomach muscles tighten as the sounds are made.

d. The throat, mouth, and nose act as amplifiers. They give fullness to and help project the voice. In giving commands, the throat should be relaxed. The lower jaw and lips should be loose. The mouth should be open wide and the vowel sounds (a, e, i, o, u) should be prolonged. Consonants (letters other than vowels) and word endings should be curt and sharply cut off.

e. The position of attention is the proper position for giving commands. A leader who demonstrates exceptional bearing will be imitated by other cadets, and those cadets will be inspired to respond to commands with snap and precision. All cadets commanding armed troops will be armed. When giving commands, drilling troops, or making reports, the rifle will be carried at right shoulder arms, the sword will be carried at the carry sword position, and the pistol will be carried in the holster. Facing movements by commanders of armed troops may be executed while at right shoulder arms (See figure 1-6b).



a. Position of Attention

b. Right Shoulder Arms

c. Carry Sword

Fig. 1-6 Correct Position for Giving Commands.

f. Distinct commands inspire cadets. Muffled or unclear commands confuse them. All commands can be given correctly without loss of effect or cadence. To give distinct commands, you must emphasize enunciation; make full use of the tongue, lips, and lower jaw; practice giving commands slowly, carefully, and in cadence; and then increase the rate of delivery until the proper rhythm (112 to 120 beats per minute) is reached and each syllable is distinct. Raising the hand to the mouth to aid in projecting commands is not proper.

g. Inflection is the rise and fall in pitch, the tone changes of the voice.

(1) Preparatory commands should be delivered with a rise and inflection in the voice (e.g., "BaaaTALion," "PlaaaTOON," "FoorWARD," "TO the REAR," etc.). In particular those preparatory commands that cause supplemental movements should be heavily accentuated on the last syllable (e.g., the command "**Present, ARMS,**" the preparatory command Preee(pause) ZENT" causes those armed with swords to execute the first count of the movement and the national color to go to the carry.). Another example is "**Officers, Center, MARCH.**" On the preparatory command of "OfficERS," those armed with swords go to the carry, on the preparatory command of "CennnTER," the officer's step and/or face).

(2) A command of execution is given in a sharper and higher pitch than the tone of the preparatory command's last syllable. A good command of execution has no inflection, but it must have snap. It should be delivered with sharp emphasis, ending like the crack of a whip. If properly given, troops will react to it with snap and precision.

(3) Combined commands such as "**FALL IN**" are delivered without inflection. They are given in the uniform high pitch and loudness of a command of execution.

1006. GENERAL RULES FOR DRILL

1. Certain drill movements may be made toward either flank. This manual explains such movements in one direction only. To move to the other direction, it is necessary to substitute the word "left" for "right" as shown in parentheses.

2. The command, "**AS YOU WERE,**" cancels a movement or order started but not completed. At this command, troops should resume their former positions.

3. While marching, alignment is maintained toward the right, except:

a. Upon the command "**GUIDE LEFT**" or "**GUIDE CENTER,**" alignment is maintained toward the left or center until the command "**GUIDE RIGHT**" is given.

b. Regardless of the direction in which alignment is established, at the command of execution for a drill movement involving marching, the direction of alignment is toward direction of the movement (e.g., if the command of **Column Left, MARCH**" is given, the unit aligns to the left until the column movement is completed.). Upon completion of the drill movement, alignment will be in the direction established prior to commencing the movement.

c. In a column of platoons, the guide of the leading platoon controls direction and distance, and maintains the cadence counted by the commander. Guides of the following platoons control distances and follow the direction and cadence set by the leading guide.

4. Slight changes in direction are made by:

a. Adding "**Half**" to the preparatory command for turning or column movements; for example, "**Column Half Right (Left), MARCH,**" changes direction 45 degrees.

b. At the command "**INCLINE TO THE RIGHT (LEFT),**" guides change their direction of march slightly to the right (left).

5. Platoons in a company and individuals in a squad are numbered from right to left in line, and from front to rear in column. Squads in a platoon are numbered from front to rear in line and from left to right in column.

6. Posts of officers, noncommissioned officers, guidon bearers, and special units are shown in figures or explained later in this manual.

a. Changes of post are made by the most direct route, unless specifically prescribed. The movement is made as soon as possible after the command of execution. Persons who have duties in connection with the movement take their new posts after those duties have been performed. Individuals moving from one post to another or aligning units must maintain military bearing. All necessary facings and changes of direction must be made as if drilling.

b. After the initial formation, guidon bearers and special units maintain their positions with respect to the flank or end of the organization with which they were originally posted.

c. Refer to paragraph 1004.6e of this manual for proper positions.

7. Whenever drill movements are executed while cadets are marching, the command of execution is given as the left foot strikes the deck if the movement is to the left, and as the right foot strikes the deck if the movement is to the right. The one exception is when executing left shoulder arms from port arms; the command of execution will be given on the right foot. See table 1-1 for the suggested foot to give commands on while marching.

8. The cadence of commands should be that of quick time, even though no marching is involved. The pause between preparatory commands and commands of execution should be adapted to the size and formation of the unit.

a. The best pause to allow for a squad or platoon while marching is one count or step between the two commands. See table 1-1 for the suggested foot to give commands on while marching.

(1) To develop the proper cadence for commands at a halt, count ONE, TWO, THREE, FOUR in quick time. Then give commands, such as **"Right, FACE,"** without interrupting the cadence:

ONE	TWO	THREE	FOUR
"Right,	(Pause)	FACE"	

(2) Marching commands, such as **"By the Right Flank, MARCH,"** must be started so the preparatory command will end as the foot in the desired direction of movement strikes the deck. There is then a full count before the command of execution, which is given on the same foot. See table 1-1 for the suggested foot to give commands on while marching.

b. For a company or larger unit, the intervals must be longer. This is necessary for leaders of component units to repeat preparatory commands, give warning, or supplementary commands. The following example shows the proper cadence for the command **"Right, FACE"** to a company:

ONE	TWO	THREE	FOUR
(Company Commander)	(Platoon Commander)		(Company Commander)
"Right,	{ "Right" }		FACE"

1007. DRILL BY THE NUMBERS

1. Drill movements may be divided into individual motions for instruction. When drill is executed by the numbers, the first motion is made on the command of execution. Subsequent motions are made in proper order on the commands TWO, THREE, FOUR, the number of counts depending upon the number of motions in the movement. To use this method, the command **"BY THE NUMBERS"** precedes the preparatory command. All movements are then executed by the numbers until the command **"WITHOUT NUMBERS"** is given.

RIGHT	LEFT	RIGHT	LEFT	RIGHT	LEFT	WHEN GIVEN
		"Squad,	(Step)	HALT"		From column or flank
	"Pla	toon,	(Step)	HALT"		From column or flank
	"Com	pany	(Step)	HALT"		From column or flank
	"Right	Turn,	(Step)	MARCH"		While marching in company mass the color guard or staff
"Left	Turn,	(Step)	MARCH"			As above
"Counter	March,	(Step)	MARCH"			For color guards.
"Mark	Time,	(Step)	MARCH"	MARCH"		May be given as either foot strikes the deck from line, column or oblique
"Half	Step,	(Step)	MARCH"	MARCH"		May be given as either foot strikes the deck from line, column or oblique
"For	Ward,	(Step)	MARCH"			From mark time or half step in column or flank
"By The	Right	Flank,	(Step)	MARCH"		From column or flank
RIGHT	LEFT	RIGHT	LEFT	RIGHT	LEFT	WHEN GIVEN
	"By The	Left	Flank,	(Step)	MARCH"	From column or flank
	"Column	Right,	(Step)	MARCH"		From column
"Column	Left	(Step)	MARCH"			From column
"Column	Half	Right,	(Step)	MARCH"		From column
	"Column	Half	Left,	(Step)	MARCH"	From column
	"To The	Rear,	(Step)	MARCH"		From column or flank
	"Right	oblique	(Step)	MARCH"		From column
	O					
"For	ward,	(Step)	MARCH"			From right oblique
"Pla	toon,	(Step)	HALT"			From right oblique
	"In	Place,	(Step)	HALT"		To halt in the right oblique while marching at quick time, mark time or half step.
"Re	sume,	(Step)	MARCH"			To resume marching in the left/right oblique from in place halt, mark time or half step
Left O	blique	(Step)	MARCH"			From Column
	"For	ward,	(Step)	MARCH"		From left oblique
	"Pla	toon,	(Step)	HALT"		From left oblique
	"In	Place,	(Step)	HALT"		To halt in the left oblique while marching at quick time, mark time or half step.
"Close,	(Step)	MARCH"				To close the interval in column marching
"Ex	tend,	(Step)	MARCH"			To extend the interval in column marching

COMMANDS FOR THE MANUAL OF ARMS WHILE MARCHING

"Port,	(Step)	ARMS"				From the left shoulder
"Left	Shoul,	der,	(Step)	ARMS"		From port arms
	"Left	Shoul	der,	(Step)	ARMS"	From right shoulder
"Right	Shoul,	der,	(Step)	ARMS"		From left shoulder or port
	"Port,	(Step)	ARMS"			From right shoulder

Table 1-1.--Suggested Foot to Give Marching Commands On.

1008. MASS COMMANDS AND INDIVIDUAL COMMANDS FROM RANKS

1. Mass Commands. The use of mass commands in drill develops confidence and team spirit. It also teaches cadets to give and execute commands properly.

a. The initial command is **"At Your Command."** The leader then gives a preparatory command that describes the movement, for example, **"At Your Command, Face the Platoon to the Right, COMMAND."** After this, all members of the platoon command, **"Right, FACE"** together and execute it. Another mass command example is **"At Your Command, Call the Platoon to Attention, COMMAND."** The cadets command, **"Platoon, ATTENTION."**

b. Marching movements may be conducted in a similar manner as follows: **"ALL MOVEMENTS UNTIL FURTHER NOTICE WILL BE AT YOUR COMMAND."**

(1) LEADER: **"Call the Platoon to Attention, COMMAND."** TROOPS: **"Platoon, ATTENTION."**

(2) LEADER: **"Forward, COMMAND."** TROOPS: **"Forward, MARCH."**

(3) LEADER: **"By the Right Flank, COMMAND."** TROOPS: **"By the Right Flank, MARCH."**

c. Only simple movements with short preparatory commands are used for mass commands. Preparatory commands that require supplemental commands by subordinate leaders are not used.

d. In order to return to normal drill methods, the instructor orders **"At My Command."**

2. Individual Commands From Ranks. As an aid in training cadets to give commands properly, cadets in ranks may be designated to give individual commands. This should be done only after a unit has learned to execute commands and give mass commands. The leader designates the cadet who is to give the command by name or place in ranks. He may be designated while the unit is marching or halted. The leader describes the movement to be made, as in mass commands, but does not add **"COMMAND."** The designated cadet remains in position and gives the appropriate command, executing the command with the unit.

3. Counting Cadence. Counting cadence by cadets in ranks teaches them group coordination and rhythm. The command is **"Count Cadence, COUNT,"** or **"Delayed Cadence, COUNT."** The command of execution being given as the left foot strikes the deck. Everyone then counts cadence for 8 steps, starting when the left foot next strikes the deck. They should be required to do so in a firm, vigorous manner.

"Count Cadence, COUNT"								
Step	LEFT	RIGHT	LEFT	RIGHT	LEFT	RIGHT	LEFT	RIGHT
Count	One	Two	Three	Four	One	Two	Three	Four

"Delayed Cadence, COUNT"										
Step	LEFT	RIGHT	LEFT	RIGHT	LEFT	RIGHT	LEFT	RIGHT	LEFT	RIGHT
Count	One		Two		Three		Four		One	
	Two		Three		Four		One	Two	Three	Four
	One	Two	Three	Four						

1009. ADVANCED DRILL PROCEDURES

1. Cadence Drill (Speed Drill). Cadence drill is an advanced form of drill. It is used only with cadets who have learned basic drill as prescribed in this manual. It provides variety for well-trained cadets and "liven up" a drill period. In cadence drill, the commander, abbreviates preparatory commands and deletes the pause between the preparatory command and the command of execution. Each time a commander uses this form of drill, he must explain that the unit is departing from prescribed drill. Cadence drill is suitable for platoon and smaller units. Examples of cadence drill are:

Step	LEFT	RIGHT	LEFT	RIGHT
Command (s)	"Left	"Right	Flank	MARCH"
	"Rear	MARCH"	MARCH"	

2. Trick Drill. As with cadence drill, this form of drill is used only with cadets who have thoroughly learned all prescribed drill and cadence drill. Additionally, it may be used as a motivating device for well-trained cadets. It is extremely complex and requires extensive training and rehearsals. Trick drills are not described in this manual. They are limited only by the imagination of the leader.

1010. TABLE OF SYMBOLS USED IN THIS MANUAL

1. Table 1-2 shows the symbols used in this manual.















	Reviewing Officer	 DIRECTION OF MARCH DIRECTION FACING		MPO	
	Battalion Commander				Platoon Guide
	Commander of Troops (COT)				Squad Leader
	Adjutant				Cadet
	Company Commander				
	Company XO				
	Platoon Commander				

Table 1-2.--Drill Symbols

CHAPTER 2

POSITIONS

2000. **ATTENTION.** The position of attention is the basic military position from which most other drill movements are executed (see figure 2-1). There are no counts, however, there are several steps in describing the position:

1. Smartly bring your left heel against the right. Turn your feet out equally to form an angle of 45 degrees. Keep your heels on the same line and touching.
2. Your legs should be straight, but not stiff at the knees. Do not "lock" your knees. Keep your hips and shoulders level and your chest lifted.
3. Your arms should be straight; thumbs along your trouser seams, palms facing inward toward your legs, and fingers joined in their natural curl.
4. Keep your head and body erect. Look straight ahead. Keep your mouth closed and your chin pulled in slightly.
5. Stand still and do not talk.
6. The movement may be executed when halted, at any position of rest, or while marching at route step or at ease. The commands are "**FALL IN**" and "**ATTENTION.**" On the command "**FALL IN**," you would assume your position in ranks at the position of attention. The command "**ATTENTION**" is always preceded by a preparatory command designated by the size of the unit, such as "**Squad, Platoon,**" or "**Company.**" For example, when drilling a squad the command to bring them to attention would be "**Squad, ATTENTION.**" Thereafter, they move only as ordered until given "**AT EASE,**" "**REST,**" "**FALL OUT,**" or they are dismissed.

a. When given at parade rest, come to attention. When given at ease or rest, assume the position of parade rest on the preparatory command "**Squad.**" When "**ATTENTION**" is given go to that position.

7. When at a position of rest or while marching at route step or at ease and the command "**ATTENTION**" is given, the following applies:

a. When given while marching at route step or at ease, get in step as soon as possible and continue to march at attention.



Figure 2-1.--Position of Attention.

2001. **REST.** There are four positions of rest for halted cadets. They are parade rest, at ease, rest, and fall out. The purpose of rest is to give troops a rest from the position of attention. Parade rest, at ease, and rest, are one-count movements. Fall out is not a precision movement and has no counts. All

are executed from the position of attention. The commands are "**Parade, REST;**" "**AT EASE;**" "**REST;**" and "**FALL OUT.**"

1. Parade Rest. On the preparatory command "**Parade,**" shift the weight of your body to the right leg without noticeable movement. On the command of execution "**REST,**" and for the count of one, move the left foot twelve inches (measured from the inside of each heel) smartly to the left. The heels remain on line and the body weight rests equally on both legs. At the same time the left foot is moved, clasp the hands behind the back. The left hand is placed at the small of the back and the right hand is placed inside the left. The thumb of the right hand lightly grasps the thumb of the left. All fingers are extended and joined with the palms to the rear. The elbows will be in line with the body. Silence and immobility are required (See figure 2-2.). The only command you may receive while at parade rest is "**ATTENTION.**"

2. At Ease. The command is "**AT EASE.**" It is executed in one count. At the command, keep your right foot in place. You may move about, but must not talk. You may also be given this command when not in ranks. In this case, it means cease talking, but continue whatever you were doing before the command. When in ranks, the only command you may receive while at ease is "**ATTENTION.**"

3. Rest. The command is "**REST.**" It is executed in one count. At the command, you may move and talk; however, you must keep your right foot in place. The only command you may receive while at rest is "**ATTENTION.**"

4. Fall Out. The command is "**FALL OUT.**" At the command, leave your position in ranks, but remain nearby or proceed to a pre-designated area. When "**FALL IN**" is given, return to your place in ranks at the position of attention.



Front View



Side View



Back View

Figure 2-2.—Parade Rest.

2002. EYES RIGHT (LEFT). The purpose of eyes right (left) is to demonstrate military courtesy to reviewing officers and dignitaries during parades and ceremonies. It is executed in one count when halted at attention or marching at quick time in platoon formation. The command is "Eyes, RIGHT (LEFT)." The command to turn the head back to the position of attention is "Ready, FRONT."

1. At the halt, when the command of execution "RIGHT (LEFT)" is given, turn your head smartly 45 degrees to the right (left keeping your shoulders square to the front. Do not turn your eyes to the right. Eyes remain as in the position of attention.

2. At the halt, on the command of execution "FRONT" turn your head smartly back to the front. During reviews at which the reviewing officer troops the line, ready front will not be given after eyes right. At such ceremonies, turn your head smartly toward the reviewing officer on the command of execution "RIGHT." As he/she passes to the left, follow the reviewing officer with your head until you are looking directly to the original front.

3. When marching, give the command, "Eyes, RIGHT" so that the command of execution is given as the right foot strikes the deck and the command "Eyes, LEFT" so that the command of execution is given as the left foot strikes the deck. When marching with two (2) or more squads, the base squad does not turn their heads. Give the command "Ready, FRONT" from eyes right so that the command of execution is given as the left foot strikes the deck and "Ready, FRONT" from eyes left so that the command of execution is given as the right foot strikes the deck. For example:

<u>LEFT</u>	<u>RIGHT</u>	<u>LEFT</u>	<u>RIGHT</u>
"Ready	"Eyes,	(Step)	"RIGHT"
	(Step)	FRONT"	(From "Eyes, RIGHT")
"Eyes,	(Step)	LEFT"	
	"Ready,	(Step)	FRONT" (From "Eyes, LEFT")

2003. FACING MOVEMENTS. The purpose of facing movements is to face a unit to the right, left or about. Facing movements are executed in two counts when halted at attention. The commands are "Right, FACE;" "Left, FACE;" and "About, FACE." Facing movements are executed in the cadence of quick time. While facing, your arms should not swing out from your sides, but should remain at the position of attention.

1. "Right, FACE" is a two-count movement (See figure 2-3.).

a. On count one, at the command "FACE," raise your left heel and right toe slightly. Turn to the right on your right heel and left toe. Keep your left leg straight but not stiff (see figure. 2-3b).

b. On count two, place the left foot smartly beside the right and stand at attention (see figure 2-3c).

2. "Left, FACE" is executed in the same manner described in 2003.1 above, substituting the words "left" for "right" and "right" for "left."



a. Start.



b. Count One.



c. Count Two.

Figure 2-3.--Right Face.

3. **"About, FACE"** is a two-count movement (See figure 2-4.).

a. At the command **"About,"** shift your weight to your left leg without noticeable movement (See figure 2-4a.).

b. On count one at the command **"FACE,"** place your right toe half your foot's length behind and slightly to the left of your heel. Do not change the position of your left foot. Rest your weight evenly on the left heel and the ball of the right foot (see figure 2-4b).

c. On count two, turn smartly to the right until facing rear. The turn is made on the left heel and ball of the right foot. The knees remain straight, but not locked during the movement (see figure 2-4c).



a. Start.



b. Count One.



c. Count Two.

Figure 2-4.--About Face.

2004. HAND SALUTES

1. The purpose of the hand salute is to demonstrate mutual respect and courtesy between members of military organizations and to show respect to national colors. It is executed in one count when halted at attention, marching at quick time, or seated in a vehicle. The command is **"Hand, SALUTE."** To return to the position of attention the command is **"Ready, TWO."** (See figure 2-5).

a. When the command **"SALUTE"** is given, raise your right hand smartly in the most direct manner until the tip of your forefinger touches the lower part of the headdress above and slightly right of your right eye. Your fingers should be extended and joined with the thumb along the forefinger. You should be able to see your entire palm when looking straight ahead. Your upper arm should be parallel with the deck with the elbow in line with the body and your forearm at a

45-degree angle. Your wrist, hand and forearm should be straight, a continuation of the line made by your arm. At the same time, if not in ranks, turn your head and eyes toward the person or colors you are saluting.

b. At the command **"TWO,"** return to attention. Move your hand smartly in the most direct manner back to its normal position by your side.

c. To ensure simultaneous execution of the second movement of the hand salute when troops are in formation, the preparatory command **"Ready,"** will be used prior to the command of execution **"TWO."**

2. You may salute without command from attention, while walking, or while seated in a vehicle. When walking, it is not necessary to halt to salute. Keep walking, but at attention. The salute is rendered when the person or colors to be saluted is at a 6-pace distance, or at the nearest point of approach if it is apparent that the person or color is not going to approach within 6 paces. The salute will not be rendered if the person (color) to be saluted does not approach within 30 paces. Hold the first position of the salute until the person (color) saluted has passed or the salute is returned, then execute the second movement of the hand salute (See figures 2-6 and 2-7 for examples of when to/not to salute).

3. When the command **"Present, ARMS"** is given, if not armed, you execute the hand salute on the command **"ARMS."** Stay at that position until the command **"Order, ARMS"** is given.



Figure 2-5.—Examples of Hand Salute.

1. Salute officers only when COVERED and IN UNIFORM as shown below.



Figure 2-7.--When not to Salute.

1. Examples of when NOT to salute officers are shown below.

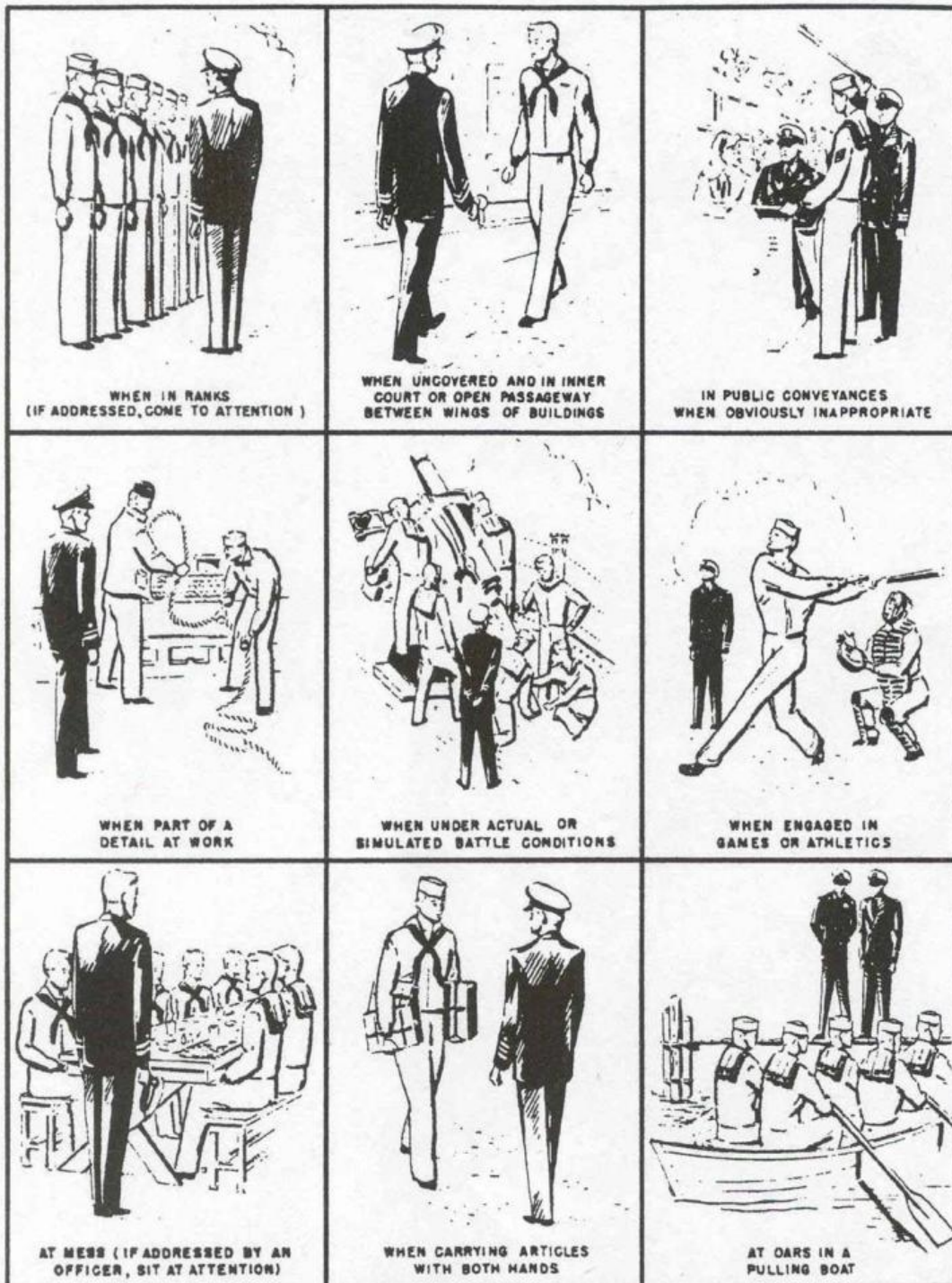

2005. UNCOVER. This is a non-precision movement, although explained in detail to clarify the actions of this movement. The Guidon bearer remains covered during this movement. The command is, "UNCOVER, TWO." When "UNCOVER" is given:

1. Combination Cover. Place your right hand on the visor of your cover, with your fingers together on top and thumb underneath the visor. On the command of execution, "TWO," remove the cover smartly and stow it under your upper left armpit, with the visor in front and the top of the cover touching your arm, cutting your right hand away smartly to your side (returning to the position of attention).

2. Garrison Cover. Place your right hand on the top center of your garrison cap, with your fingers together on the port side and your thumb on the starboard side. On the command of execution, "TWO," remove the cover, cutting your right hand away smartly to your side, returning to the position of attention. The cover will be in the right hand with its open end facing up. The fore end of the cover now points toward your rear, and the aft end points to your front.

2006. COVER

1. Combination Cover. The command is, "COVER, TWO." When "COVER" is given, place your right hand on the visor of the cover (under your left arm), grasping it with the fingers on top and the thumb underneath, and place it on your head, guiding it with your left hand, which is placed on the rear the expandable frame, grasping the frame with fingers together and thumb. Once the cover has been repositioned on the head, return the left hand to your side, while keeping the right hand on the visor. On the command of execution, "TWO," the right hand is cut away smartly to your side, resuming the position of attention.

2. Garrison Cover. The command is, "COVER, TWO." When "COVER" is given, raise both hands to your head, and place the cover back on your head, using both hands to straighten the cover. Once the cover has been repositioned on the head, return the left hand to your side, while keeping the right hand on the cover's starboard side. On the command of execution, "TWO," the right hand is cut away smartly to your side, resuming the position of attention.

SECTION 2: STEPS AND MARCHING

2200. GENERAL

1. With the exception of right step, all steps and marching movements beginning from a halt start with the left foot.
2. The Commander of Troops (COT) indicates the proper rhythm by counting cadence.
3. To change direction on the march, the command of execution is given as the foot in the desired direction of the turn strikes the deck.

2201. QUICK TIME. The purpose of quick time is to march at 112 to 120 steps per minute, normally taking 30-inch steps. It may be executed when halted at attention, marking time, marching forward at double time, or marching at half step. The commands are "**Forward, MARCH**" or "**Quick Time, MARCH.**"

1. When halted, the command to march forward at quick time is "**Forward, MARCH.**"
2. On "**Forward,**" shift your weight to the right leg without noticeable movement.
3. On "**MARCH,**" step off smartly, left foot first, and march straight ahead with 30-inch steps. Swing your arms easily in their natural arcs, 6 inches straight to the front and 3 inches to the rear. Do not exaggerate movements.

2202. DOUBLE TIME. The purpose of double time is to march at 180 steps per minute taking 36-inch steps. It may be executed when halted at attention, marking time, double timing in place, or marching forward at quick time. The command is "**Double Time, MARCH.**" When given while marching, the command "**MARCH**" may be given as either foot strikes the deck.

1. When Halted

a. At the command "**Double Time,**" shift your weight to your right leg without noticeable movement.

b. On "**MARCH,**" step off on the left foot and begin an easy run, taking 180,36-inch steps per minute. At the same time raise your forearms until parallel with the deck and make fists of your hands.

2. When Marching at Quick Time

a. When the command "**MARCH**" is given, take one more 30-inch step.

b. Step off in double time.

3. To Resume Quick Time, the Command is "**Quick Time, MARCH**"

a. On "**MARCH,**" take one more 36-inch step.

b. Lower your arms and slow to quick time.

4. When Marching in Place

a. Take one more step in mark time (or double time in place).

b. Step off forward in double time.

2203. HALT. The purpose of halt is to stop the movement of a marching unit. It is executed in two counts when marching at quick time, and three counts when marching at double time. It may be executed when marching at quick time, half step, double time, side step, back step, mark time, and double time in place. The command of execution is "**HALT**," which is always preceded by a preparatory command designated by the size of the unit, such as "**Squad, Platoon**," or "**Company**." The command of execution may be given as either foot strikes the deck except for sidestep.

1. While Marching at Quick Time or Half Step

- a. Take one more step after "**HALT**."
- b. Bring the rear heel forward against the other.

2. While Marching at Double Time

- a. Take one more double time step after "**HALT**."
- b. Take another at quick time.
- c. Bring the rear heel forward against the other.

3. While Marching at Right (Left) Step

- a. The command "**HALT**" is given when the heels are together.
- b. Take one more side step after "**HALT**."
- c. Bring the heels together.

4. While Backward Marching

- a. Take one more back step after "**HALT**."
- b. Bring the forward heel back against the other.

5. While Marching at Mark Time

- a. Take one more step in place after the command "**HALT**."
- b. Bring the heels together.

6. While Marching at in Place Double Time

- a. Take one more in place double time step after the command "**HALT**."
- b. Take another step in place at quick time.
- c. Bring the heels together.

2204. MARK TIME. The purpose of mark time is to march in place at quick time cadence. It may be executed when halted at attention, double-timing in place, marching at half step and marching forward at quick time. While marching, the command may be given as either foot strikes the deck. The command is "**Mark Time, MARCH**."

1. When Halted

a. On the command "**Mark Time**," shift your weight to your right leg slightly without noticeable movement.

b. On the command "**MARCH**," beginning with your left foot, then alternating, raise each foot so that the ball of the foot is approximately 2 inches and the heel approximately 4 inches from the deck at a cadence of quick time. At the same time, swing your arms naturally as in marching.

2. When Marching at Quick Time

a. On the command "**MARCH**," take one more 30-inch step as if coming to a halt.

b. Bring your heels together. Begin marking time without loss of cadence with the opposite foot.

3. To Resume the March at Quick Time, The Command is "**Forward, MARCH**"

a. On the command "**MARCH**," take one more step in place.

b. Step off with a 30-inch step.

4. When Marching at Double Time in Place

a. On the command "**MARCH**," take one more step in place at double time.

b. Commence marking time.

2205. DOUBLE TIME IN PLACE. The purpose of double time in place is to march in place at double time cadence. It may be executed when halted at attention, marking time, or marching forward at double time. The command is "**In Place Double Time, MARCH**."

1. When Halted

a. On the command "**In Place Double Time**," shift your weight to your right leg without noticeable movement.

b. On the command "**MARCH**," raise your arms for double time. Starting with the left foot, alternating and in place, raise your feet 6 inches above the deck at 180 steps per minute.

2. When Marching at Double Time

a. After "**MARCH**," take two more double time steps.

b. Bring your feet together and begin double timing in place without loss of cadence.

3. The Command "Double Time, MARCH" Resumes the March at Double Time

a. At "**MARCH**," take two more steps in place.

b. Step off with 180, 36-inch steps per minute.

4. When Marking Time

a. On the command "**MARCH**," take one more step in mark time.

b. Commence marching at double time in place.

2206. HALF STEP. The purpose of half step is to march forward at quick time taking 15-inch steps. It may be executed when halted at attention or marching forward at quick time. While marching it may be given as either foot strikes the deck. The command is "**Half Step, MARCH.**"

1. At the Halt

a. On the command "**Half Step,**" shift your weight to your right leg without noticeable movement.

b. On the command "**MARCH,**" step off forward in quick time cadence with 15-inch steps. The balls of your feet should strike the deck before your heels. At the same time begin swinging your arms 6 inches to the front and 3 inches to the rear.

2. Marching in Quick Time

a. On the command "**MARCH,**" take one more 30-inch step.

b. Begin the 15-inch steps as explained above. (See paragraph 2206.1.)

3. To resume quick time from half step, the command is "**Forward, MARCH.**" It may be given as either foot strikes the deck.

a. On "**MARCH,**" take one more half step.

b. Step off at quick time.

2207. SIDE STEP. The purpose of side step is to move the unit a short distance to the right or left. There are no counts, however there is a cadence of 1-2 at quick time.

1. The command "**Right (Left) Step, MARCH**" is given only when you are at a halt.

2. At the command "**MARCH,**" move your right (left) foot 12 inches to the right (left), then place your left (right) foot smartly beside your right (left). Repeat this movement at quick time. Keep your legs straight, but not stiff. Hold your arms at your sides as in the position of attention.

2208. BACK STEP. The purpose of back step is to march the unit backwards for a short distance.

1. The command "**Backward, MARCH**" is given only when you are at a halt.

2. At the command "**MARCH,**" step off to the rear with your left foot and take 15-inch steps at quick time. At the same time swing your arms 6 inches to the front and 3 inches to the rear, coordinating your arm and leg movements naturally.

2209. TO FACE TO THE RIGHT (LEFT) IN MARCHING

1. This is an important part of the following movements: column right (left), by the right (left) flank, close, take interval, and extend. For instructional purposes, the command is "**By The Right (Left) Flank, MARCH.**"

2. From a Halt, on the Command "**MARCH**"

a. For right flank, turn 90 degrees to the right by pivoting on the ball of the right foot and (using a cross over step) stepping off with the left foot 30 inches in the new direction of march.

b. For left flank, turn 90 degrees to the left by pivoting on the ball of the right foot and stepping off 30 inches with the left foot in the new direction of march.

3. While marching, the command of execution is given as the foot of the desired direction of movement strikes the deck.

a. On "**MARCH**," without losing cadence, take one more step in the original direction.

b. Pivot to the right (left) and step off in the new direction. If commanded and executed properly, the pivot will be on the foot away from the desired direction of movement, and the first step in the new direction will be with the other foot. The pivot and step are done together in one count. When marching to the flank the only other movement that can be given is a flanking movement in the opposite direction that will bring the individual or unit back to the original front.

2210. TO FACE TO THE REAR WHILE MARCHING. The purpose of this movement is to march the unit to the rear for a short distance.

1. The command is "**To the Rear, MARCH**." It may be executed when halted or while marching at either quick time or double time. When marching the command of execution "**MARCH**" is given when the right foot strikes the deck. When marching to the rear, the only movement that can be given is "**To the Rear, MARCH**" in order to bring the individual or unit back to its' original front.

2. To March to the Rear From a Halt

a. The command is "**To the Rear, MARCH**."

b. On "**MARCH**," step forward with the left foot.

c. Turn about to the right on the balls of both feet and immediately step out to the rear with the left foot. This is done without loss of cadence. When turning, the feet should be about 15 inches apart.

3. When at Quick Time

a. On the command "**MARCH**," take one 15-inch step.

b. Turn about to the right on the balls of both feet and immediately step off to the rear with your left foot. This is done without loss of cadence. When turning, the feet should be about 15 inches apart.

4. When at Double Time

a. On "**MARCH**," follow the sequence of steps and actions below.

As this foot strikes the deck

RIGHT
LEFT
RIGHT
LEFT
RIGHT
LEFT
RIGHT
LEFT

Take the following action

"**MARCH**" is given.
36-inch step.
36-inch step. Then in place double time.
Pivot 90 degrees to the right
Heels together.
Pivot 90 degrees to the right.
Heels together.
36-inch step in the new direction.

2211. TO MARCH TO THE FLANK. The purpose of this movement is to march the entire unit to the right (left) for a short distance. It may be executed when halted (for instructional purposes only) or while marching at either quick time or double time. The command is "**By the Right (Left) Flank, MARCH.**" When marching the command of execution is given as the foot in the direction of the movement strikes the deck.

1. From a Halt (For Instructional Purposes Only)

a. For right flank, turn 90 degrees to the right by pivoting on the ball of the right foot and (using a cross over step) stepping off with the left foot 30 inches in the new direction of march.

b. For left flank, turn 90 degrees to the left by pivoting on the ball of the right foot and stepping off 30 inches with the left foot in the new direction of march.

2. While at Quick Time

a. On "**MARCH,**" take one more step.

b. Turn to the right (left) on the ball of the left (right) foot. At the same time, step off 30 inches in the new direction with the right (left) foot.

3. While Double Timing

a. On "**MARCH,**" use the following sequence and actions.

By the Left Flank		By the Right Flank	
Step	Action	Step	Action
LEFT	"MARCH" is given.	RIGHT	"MARCH" is given.
RIGHT	36-inch step.	LEFT	36-inch step in
LEFT	in place double timing.	RIGHT	In place double timing.
RIGHT	Pivot 90 degrees to the left.	LEFT	Pivot 90 degrees to the
LEFT	36-inch step in new direction.	RIGHT	right.
			36-inch step in new
			direction.

2212. TO CHANGE STEP. The purpose of this movement is to change the cadence count without changing the rhythm of the cadence.

1. The command is "**Change Step, MARCH.**" It may be given while marching at quick or double time, marking time, or double timing in place. The command of execution is given as the right foot strikes the deck.

2. While Marching at Quick Time or Double Time

a. On "**MARCH,**" take one more step, 30 or 36 inches, as appropriate.

b. In one count, as your right foot comes forward to the next step, place the toe near the left heel and step out again with the left foot. This changes the cadence count, but not the rhythm.

3. While Marking Time

a. On "**MARCH,**" lift and lower the left foot twice in succession.

b. The second time it touches the deck, raise the right foot and continue marking time.

4. While Double Timing in Place

- a. On "**MARCH**," hop twice on the left foot.
- b. Continue double timing in place.

2213. TO MARCH AT EASE. The purpose of this movement is to give troops a rest from marching at attention or when keeping in step becomes difficult due to rough terrain.

1. The command is "**At Ease, MARCH**." It is given as either foot strikes the deck and only while marching at quick time.
2. After "**MARCH**," you are no longer required to march in cadence, but must keep interval and distance. Do not talk.

2214. TO MARCH AT ROUTE STEP

1. The command is "**Route Step, MARCH**." It is commanded as either foot strikes the deck and only while marching at quick time.
2. After "**MARCH**," you are no longer required to march in cadence, but must keep interval and distance. You may talk, but in a low voice.

2215. TO RESUME MARCHING AT QUICK TIME FROM ROUTE STEP OR AT EASE

1. The command is "**Squad (Platoon, Company, Detail, etc.), ATTENTION**."
2. After commanding "**ATTENTION**," the unit leader will count cadence until all troops are in step. Pick up the step as soon as possible and continue marching at attention.
3. Commands that involve precision in execution will not be given until the command to resume marching at quick time has been given and all members of the formation have picked up the step and cadence.

CHAPTER 3

MANUAL OF ARMS WITH THE NJROTC DRILL RIFLE

3001. GENERAL

1. This Chapter is designed to provide standardized detailed instructions for the manual of arms, **which will be used for all NJROTC drill rifles**.
2. The balance is the center of your rifle (See figure 3-1.). In performing the manual of arms it is often necessary to hold the rifle in your left hand for balance (See figure 3-2.). In so doing, the rifle is held between the thumb and fingers. Include the sling in your grip. Keep your fingers straight and together. Your thumb and fingers form a "U."
3. The position of the rifle known as "diagonally across the body" is as follows:
 - a. The left hand is at the balance, with the thumb and fingers grasping the rifle and sling. To do this, extend and join the fingers so as to form a "U" with the thumb.
 - b. The barrel points up and is at such an angle that it bisects the juncture of the neck and shoulder. The heel of the butt is on line with the right hip (figure 3-2).
 - c. The rifle is held at a height that allows the right forearm to be parallel to the deck when the small of the stock is grasped with the right hand.
 - d. The distance of the rifle from the body depends upon your body's natural position, but it should be about 4 inches from your belt.
4. The cadence for rifle movement is 112 to 120 counts per minute.
5. While marching at double time, the rifle will be held across your body.
6. The manual of arms for the rifle is taught while halted. However, to add interest to drill or lessen fatigue, right (left) shoulder arms and port arms may be commanded when marching at quick time. Refer to table 1-1 of this manual to determine which foot strikes the deck for each movement on the march.

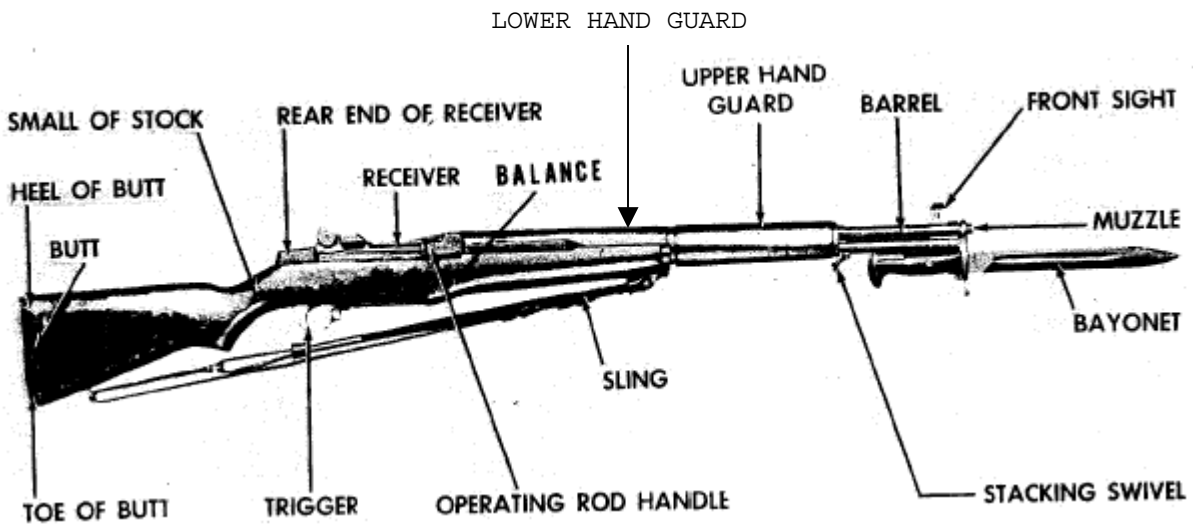

Figure 3-1a.--M1 Rifle Nomenclature.

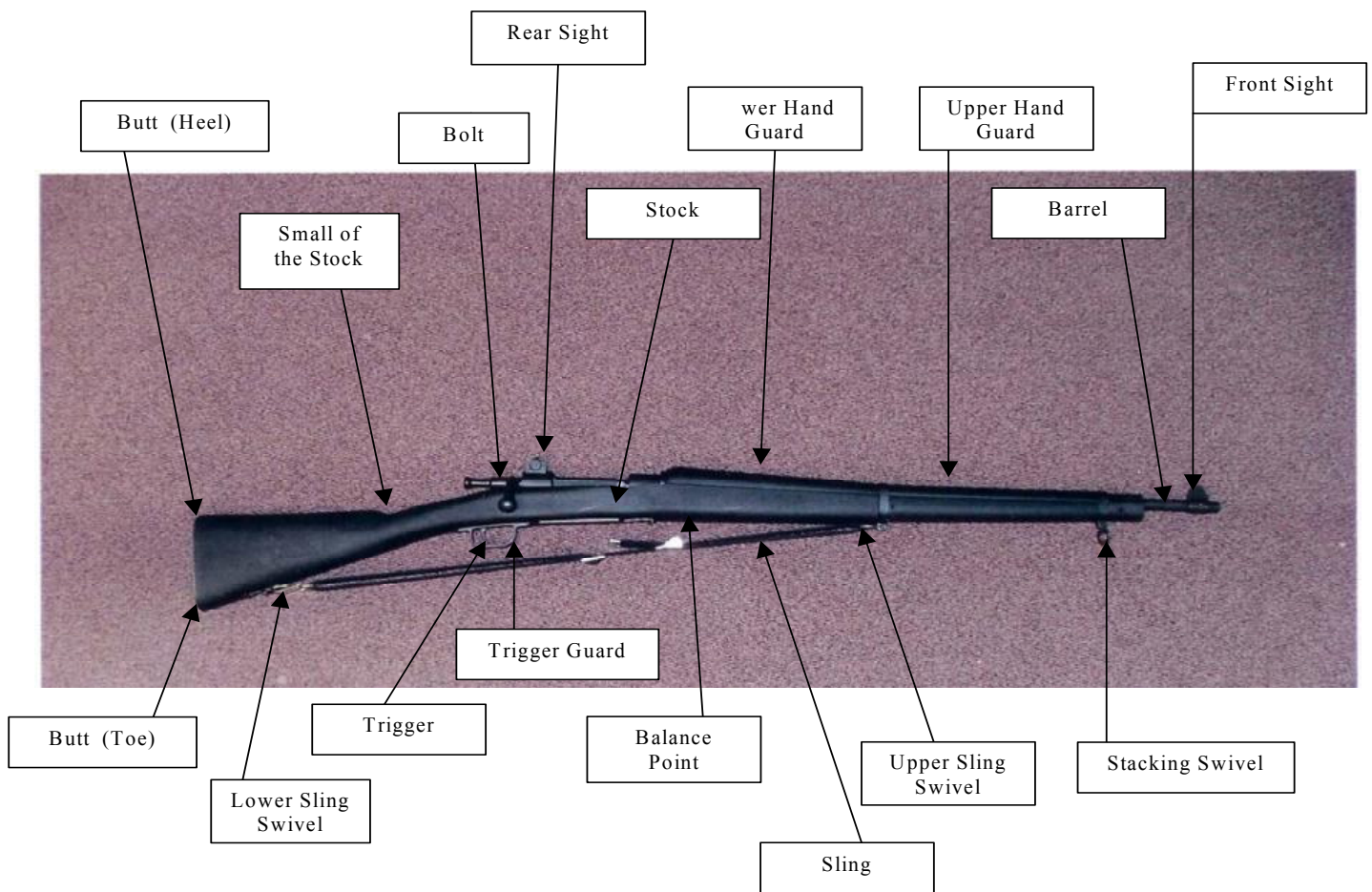

Figure 3-1b.--M1903 Springfield Rifle Nomenclature.



Figure 3-2.--Left Hand at the Rifle Balance.

3002. ORDER ARMS

1. When halted, come to order arms when any of the following commands are given: "**ATTENTION; FALL IN; or Order, ARMS.**" (See figure 3-3).

2. At the command of execution, place the butt on the deck along the outer edge of the right shoe. The toe of the butt is on line with the toe of the shoe. The rifle's upper hand guard rests in a "V" formed by your thumb and forefinger. All fingers are straight and joined. Your right hand and arm are behind the rifle. This may cause a slight bend in your elbow. The tips of your thumb and forefinger are kept on line with the front edge of the hand guard. Your right thumb should also be along the trouser seam. Except for your right hand, the entire body is at attention.



Figure 3-3.—Order Arms.

3003. TRAIL ARMS

1. Trail arms is used for short-distance movements. If an order for a facing or a marching movement is given while at order arms, automatically assume the position of trail arms on the command of execution. Upon completion of the movement, return to order arms (see figure 3-4).

2. The command is "**Trail, ARMS.**" It is given only from order arms. The movement is executed in one count. On the command of execution **ARMS**, the rifle is raised vertically 3-inches off the deck. The wrist is kept straight with the thumb along the seam of the trousers.

3. On the command "**Order, ARMS,**" lower the rifle butt to the ground and resume the position of order arms.



Figure 3-4.—Trail Arms.

3004. REST POSITIONS

1. Rest positions are commanded and executed the same as without arms, with the following exceptions and additions:

2. On the command **PARADE, REST**, move your left foot 12 inches to the left. The rifle butt is kept against your right foot. The grasp of your right hand is moved up to the upper hand guard just below the stacking swivel. The rifle rests in the "V" of the hand with the fingers joined and curled about the guard, the thumb and forefinger touching. The barrel of the rifle is pushed forward until the right arm is straight and the muzzle points forward and up. At the same time your left foot is moved, place the back of your left hand in the small of your back with fingers and thumb together and palm facing to the rear. Parade rest will also be assumed on the preparatory command to "**ATTENTION,**" if not already at parade rest (see figure 3-5).

3. On the command **AT EASE**, your right foot remains in place and the rifle is held as in parade rest with your right arm slightly relaxed. You may not talk.

4. On the command **REST**, your right foot remains in place and the rifle is held as in parade rest with your right arm slightly relaxed. You may talk softly.



Figure 3-5.--Parade Rest.

3005. PORT ARMS

1. The purpose of this movement is to bring the rifle to a two-handed carry position. This is a two-count movement from order arms. It is executed when halted at order arms. The command is "**Port, ARMS.**"

2. On the command "**ARMS,**" and for the count of one, grasp the rifle with your right hand and raise it diagonally across your chest until your right hand is in front of and slightly left of your face. The barrel is positioned so that it bisects the angle where the neck and the left shoulder join. The elbow is held down without strain and nearly touches the hand guard. Your right forearm is at an angle of approximately 45 degrees to the ground. On the same count, grasp the rifle at the balance with your left hand.

3. On the second count, move your right hand from the upper hand guard to the small of the stock. Both elbows should be against your sides with your right wrist and forearm straight and parallel to the ground, upper arm in line with your body. Your rifle should be 4 inches in front of your body. Fingers are joined and wrapped around the rifle, with the thumb wrapped around the opposite side. In the position of port arms, the rifle is held across the body with the butt in front of the right hip (see figure 3-6).



Count one.



Count two.

Figure 3-6.--Port Arms.

3006. Present Arms

1. Present arms is another way of saluting when under arms. The movement can be executed from order arms and port arms. The command is **"Present, ARMS."**

2. To present arms from order arms, is a two-count movement. On the command **"ARMS:"**

a. On the first count, raise the rifle to a position 4 inches in front of the center of your body, sling away from you, barrel straight up. At the same time, grasp the balance with your left hand, thumb on the lower hand guard, left wrist and forearm straight and parallel to the deck. Your fingers are joined, and the sling is included in your grip.

b. On the second count, grasp the small of the stock with your right hand, your fingers extended and joined, pointing straight down the stock, thumb resting in the small of the stock. The right arm is fully extended and straight. Elbows are held against your sides.

3. From port arms. This is a one-count movement. Simply turn your rifle in your hands while at the same time lowering it to the present arms position.

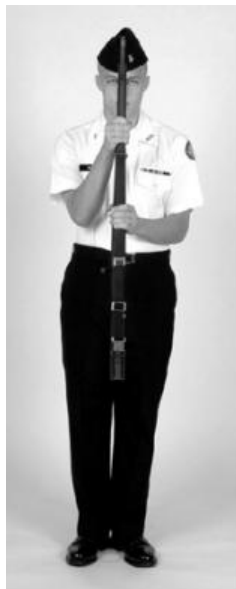

Count One



Count Two Side



Count Two Front

Figure 3-7 Present Arms

3007. ORDER ARMS FROM PRESENT AND PORT ARMS

1. The command is "**Order, ARMS.**" It is a three-count movement from either position and will be executed the same way from each (see figure 3-8 a and b).
2. At the command of execution, and for the count of one, move your right hand smartly from the small of the stock to the upper hand guard. The elbow is held without strain and nearly touches the hand guard.
3. On the second count, release the balance with your left hand and lower the rifle to a point where the butt is 3 inches from the deck, slightly to the right of your right toe, and the muzzle pointing straight up. This is done while changing the grasp with the right hand to the "V" position of trail arms. While lowering the rifle move your left hand, thumb and fingers are extended and joined, to a point near the stacking swivel. This is merely to steady the rifle and position the toe of the rifle where it will need to be when lowered. Keep your palm facing to the rear so it will not resemble a rifle salute. The left wrist and forearm are straight.
4. On the third count, return your left hand smartly back to your left side and lower the butt gently to the deck. You are now at the position of order arms.



Figure 3-8 a.--Order Arms from Present.



Figure 3-8 b.--Order Arms from Port Arms

3008. PORT ARMS FROM LEFT SHOULDER ARMS

1. This is a two-count movement. The command is **"Port, ARMS."**
2. At the command of execution and for the first count, grasp the small of the stock with your right hand. The right arm is held down without strain.
3. For the second count, release the butt with your left hand. At the same time, bring the rifle across your body and grasp the balance with your left hand as in port arms (See figure 3-9).



Figure 3-9.--Port Arms from Left Shoulder Arms.

3009. ORDER ARMS FROM LEFT SHOULDER ARMS

1. This is a five-count movement executed only while halted at the position of attention. The command is "**Order, ARMS.**"
2. On the first and *second* count, come to port arms as described in steps one and two of paragraphs 3008.2 and 3.
3. On counts three, four and five, come to order arms as described in order arms from port arms steps, two, three and four, paragraphs 3007.2 through 3007.4.

3010. LEFT SHOULDER ARMS FROM PORT ARMS

1. This is a two-count movement. The command is "**Left Shoulder, ARMS.**"
2. Come to left shoulder arms as described in steps three and four of left shoulder arms from order arms, paragraph 3017.3 and 3017.4.

3011. INSPECTION ARMS

With the M-1 Garand

This is a FOUR-COUNT movement. The command is "**Inspection, ARMS.**"

- 1 and 2. On counts one and two, come to port arms.
3. On count three, drop your head and look at the cartridge chamber of the rifle.
4. On count four, raise your head smartly to the position of attention (see figure 3-10).

Execute Inspection Arms *with the Daisy Drill Rifle* using the following procedures:

Inspection Arms from Order Arms is a FIVE-COUNT movement. The command is Inspection, ARMS.

- 1 and 2. On the command of execution ARMS, execute Port Arms in two counts.
3. On count three, grasp the bolt handle with the thumb and forefinger of the right hand, rotate the handle upward and draw the bolt back.
4. On count four, lower the head and eyes and visually inspect the magazine.
5. On count five, return the head and eyes to the front as in the Position of Attention, and come to Inspection Arms.

Port, ARMS is the only command given from Inspection Arms. On the command Port, push the bolt forward and rotate the handle down locking the bolt in place, then release the grasp of the right hand and regrasp the small of the stock with the right forefinger on the trigger. On the command ARMS, pull the trigger ***{it will not move}*** and resume Port Arms

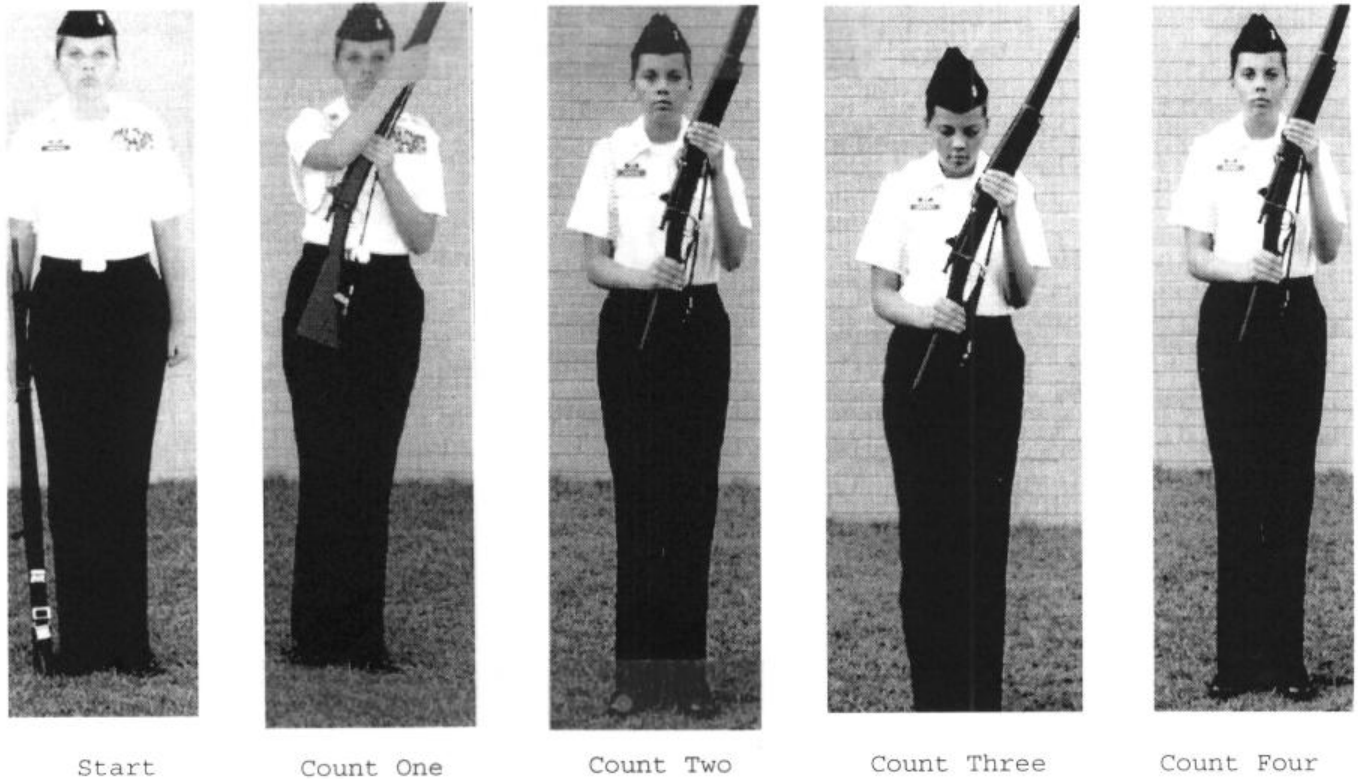

Figure 3-10.--Inspection Arms. M-1 Garand

3012. ATTENTION FROM REST POSITIONS

1. The command is "Squad (Platoon, or Company), ATTENTION."
 - a. On "Squad (Platoon or Company)," come to parade rest.
 - b. On "ATTENTION," come to order arms in one count.
 - c. From Fall Out. The command is "FALL IN." On the command "FALL IN," go back to your place in ranks and come to attention at order arms.

3013. RIGHT SHOULDER ARMS FROM ORDER ARMS

1. The command is "Right Shoulder, ARMS." It is a four-count movement.
2. At the command of execution and for the count of one, lift the rifle across your body. At the same time, take the balance in your left hand.
3. On the second count, release the upper hand guard with your right hand. Grasp the heel of the butt. The thumb and index finger touch on top of the stock. Your remaining fingers are joined and wrap around the rifle butt.
4. On the third count, place the rifle in your right shoulder without changing your grip on the butt. The sights are up; the rifle is tilted at an angle of 45 degrees to the deck, and held so it points directly fore and aft. Your right elbow is against your side and your right forearm level with the deck. While placing the rifle on your shoulder, allow your left hand to slide to the small of the stock. Your left hand guides the rifle to your shoulder. Keep your palm facing to the rear, so it does not resemble a rifle salute.
5. On the fourth count, move your left hand smartly back to your side (see figure 3-11).



Count one.

Count two.

Count three.

Count four.

Figure 3-11.--Right Shoulder Arms from Order Arms.

3014. PORT ARMS FROM RIGHT SHOULDER ARMS

1. This is a two-count movement. The command is **"Port, ARMS."**
2. At the command of execution and for the first count, smartly snatch down on the butt of the rifle with your right hand so that the rifle will spring from your shoulder. At the same time as it leaves your shoulder, smartly twist the butt clockwise one-quarter turn with your wrist so the rifle will fall diagonally in front of your chest, barrel up. Keep your head still. Keep your grip on the butt. Raise your left hand smartly to catch the rifle at the balance four inches in front of your chest, right arm nearly extended with your elbow close to your body.
3. On the second count, move your right hand to the small of the stock and assume the position of port arms.



Right Shoulder Arms

One

Two

Figure 3-12.--Port Arms from Right Shoulder Arms.

3015. ORDER ARMS FROM RIGHT SHOULDER ARMS

1. This movement is executed in four counts. The command is "**Order, ARMS.**"
2. On "**ARMS**": first count, remove the rifle from your shoulder in the same manner as described in paragraph 3014.2.
3. On the second count, smartly grasp the upper hand guard with your right hand, elbow held without strain and nearly touching the hand guard.
4. On counts three and four, come to order arms as described in order arms from port arms steps two and three, paragraph 3007.3 and 3007.4.

3016. RIGHT SHOULDER ARMS FROM PORT ARMS

1. This is a three-count movement. The command is "**Right Shoulder, ARMS.**"
2. At the command of execution and for the first count, release the small of the stock and grip the heel of the butt between the thumb and index finger of your right hand. Your thumb and index finger touch. Your remaining fingers are joined and wrap around the rifle butt.
3. On the second and third counts, complete the movement as described under right shoulder arms from order arms, paragraph 3013.3 and .4 of this manual.

3017. LEFT SHOULDER ARMS FROM ORDER ARMS

1. This is a four-count movement. The command is "**Left Shoulder, ARMS.**"
2. On counts one and two, come to the position of port arms.
3. On the third count, release the balance with your left hand and place the rifle on your left shoulder with your right hand. Your right wrist and forearm are straight and held down without strain. At the same time grasp the heel of the butt. Your thumb and index finger touch on top of the stock. The remaining fingers are joined and wrap around the rifle butt. The rifle is at a 45-degree

angle to the deck, and the sights up. Keep the rifle pointing directly fore and aft. Your left elbow is against your side, your left forearm is straight and parallel to the deck, upper arm in line with your back.

4. Drop your right hand smartly to your side (see figure 3-13).



Figure 3-13.--Left Shoulder Arms from Order Arms

3018. RIFLE SALUTES

1. The purpose of this movement is to render a salute to persons or colors, when not in formation nor posted as a sentry. It is a one-count movement, executed when halted at order arms, trail arms, or when halted or marching at right or left shoulder arms. This movement may be executed from order arms, trail arms or right (left) shoulder arms. The command is "**Rifle SALUTE.**"

a. Order arms. On the command "**SALUTE,**" you move the left arm smartly across your body with your forearm and wrist straight, fingers extended and joined, thumb along the hand with the palm down. The first joint of your forefinger touches the barrel just above the stacking swivel. When not in ranks, your head turns toward the person or colors you are saluting. On the command "**Ready, TWO,**" return your hand smartly to your side.

b. Trail arms. The movements are identical as for order arms except that the butt of the rifle is held 3 inches off the ground at the trail position.

c. Right (left) shoulder arms. Your left (right) arm moves across the body, fingers extended and joined with your palm down. The first joint of your forefinger touches the rear of the receiver and your forearm is held parallel to the deck. Turn your head and eyes toward the person or color you are saluting. Resume your original position upon the command "Ready, TWO."



Order Arms.



Trail Arms.



Right Shoulder Arms



Left Shoulder Arms

Figure 3-14.--Rifle Salutes.

2. Present Arms. Present arms is another way of saluting when under arms. See paragraph 3006 of this manual.

3019. AUTHORIZED MOVEMENTS IN THE MANUAL OF ARMS WITH THE NJROTC RIFLES

1. From Order Arms To:
 - a. Port Arms
 - b. Right Shoulder Arms
 - c. Left Shoulder Arms
 - d. Present Arms
 - e. Inspection Arms
 - f. Trail Arms
 - g. Rifle Salute
 - h. Rest Positions
2. From Port Arms to:
 - a. Right Shoulder Arms

- b. Left Shoulder Arms
 - c. Order Arms
 - d. Present Arms
3. From Right Shoulder Arms to:
- a. Left Shoulder Arms
 - b. Port Arms
 - c. Order Arms
 - d. Inspection Arms
 - e. Rifle Salute
4. From Left Shoulder Arms to:
- a. Right Shoulder Arms
 - b. Port Arms
 - c. Order Arms
 - d. Inspection Arms
 - e. Rifle Salute
5. From Trail Arms to:
- a. Rifle salute
 - b. Order Arms
6. From Inspection Arms to Port Arms (only movement from inspection arms)
7. From Present Arms to Order Arms

CHAPTER 4

MANUAL OF THE SWORD

4000. SWORD HISTORY

1. The sword is the symbol of authority and badge of office. It is worn by officers in the armed services of all nations. In the early days of history, the sword was a highly personal weapon of symbolic importance. It has not been a practical weapon since the days of cavalry, although some Japanese officers carried their family samurai swords in World War II. The tradition of wearing swords was temporarily suspended during World War II in the U. S. Navy, but officially returned as part of the dress uniform in 1954 for commissioned and warrant officers.

2. The etiquette of the sword, more often called the "manual of the sword" is steeped in ancient tradition. For instance, the sword salute is probably of crusader origin. The knights of the Middle Ages pledged their lives and worthy honor on the sign of the cross, which was symbolized by the cross made by the handle and blade of the sword. They would kiss the sword hilt before entering battle and when taking vows and oaths.

3. Most of the ancient history of the sword salute is retained in the present-day salute. The sword held at arm's length was originally the first salute to a superior. Allowing the point of the sword to descend to the ground is the ancient act of submission. Bringing the sword hilt to the mouth or chin is a survival of the custom of kissing the cross of the sword.

4. The sword salute on the march as well as the flourish of a drum major are survivals of the fancy moves made by officers in the military reviews of the seventeenth century.

5. The most serious breach of sword etiquette is to drop a sword when making the sword salute. Keep a firm grip on the hilt. Officers who wear swords should practice unsheathing, saluting and resheathing the sword so those movements can be done smoothly. When marching in a parade, all eyes are on those saluting when passing the reviewing stand.

4001. ARCH OF SWORDS AND CAKE CEREMONIES

1. The arch of swords and the cutting of a cake are commonly conducted at the annual Military Ball. A usual feature at some balls is the Grand March (sometimes called the John Paul Jones or Grand Promenade). This is led by the company commander and his date, followed by his sword-carrying staff and any sword-carrying officer guests and their dates. At one stage of the march (toward its conclusion), the officers will unsheathe their sword and make an arch under which all couples following them in the march will pass. It is a great deal of fun and is a special traditional feature of some Military Balls.

2. The arch of swords ceremony is an old English and American custom, which gives a symbolic pledge of loyalty to the newly married couple. Only the newly married couple is allowed to pass under the arch. NJROTC has practiced this custom during homecoming games, and other events as determined by the Naval Science Instructor.

3. Cadet officers usually form the sword detail, however other cadets may be designated as determined by the Naval Science Instructor. Customarily, six or eight members take part in the ceremony. The Cadet ushers form at the designated arch position, in two equal ranks, at normal interval, facing each other, with sufficient room between ranks (3 to 4 paces) for the honorees to pass. The senior Cadet usher is positioned in the left rank furthest from the arch exit point (see figure 4-1).

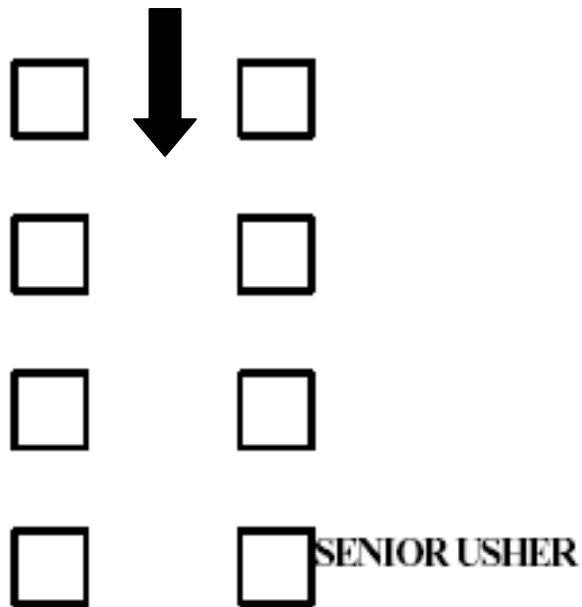

Figure 4-1.--Formation for the Arch of Swords.

4. At the appropriate time, the arch honorees (usually male and female pairs) will stand outside the main arch entrance. The senior Cadet usher will then form the arch of swords by commanding, **"Draw, SWORD."**

a. On the preparatory command, **"Draw,"** execute the first count of the movement as described in paragraph 4003 of this manual.

b. On the command of execution, **"SWORD,"** remove the sword from the scabbard in one continuous motion to an angle of 45 degrees, points touching across the aisle formed by the ushers. At this point, halt and do not complete the final counts of draw sword.

5. The arch honorees then pass under the arch. (Note: In the case of a wedding, the bride and groom, and only the bride and groom pass under the arch. As the newlyweds approach the last two ushers, they slowly lower their swords to halt the couple. The senior usher then congratulates the couple, and then announces the new couple to those assembled. The last two ushers then slowly raise their sword back to the arch position and allow the couple to pass).

6. After the arch honorees have cleared the arch the senior Cadet usher gives the command, **"Return, SWORD."**

a. On the preparatory command, **"Return,"** move the sword to the present position and then to the scabbard as described in paragraph 4012 of this manual.

7. Also at the ball, there is usually a cake to be cut. A particular tradition may have been developed at your own school. One ceremony commonly used is as follows:

The company commander's date will cut the cake with the commander's sword. The first piece of cake is given to the wife of the naval science instructor (or the wife of the principal, school board president, etc.)

8. These are dignified, symbolic ceremonies, performed to especially honor the participants and to recognize the military tradition of the sword and the honorable profession of bearing arms. They are happy events carried out with good humor. All guests at the military ball should quietly stand, surrounding the cake at a respectful distance during the cake cutting ceremony. They ordinarily clap and "bravo" after the cutting and clap after the presentation of the first piece of cake to the honored lady.

9. For detailed information about cake-cutting ceremonies, refer to chapter 5, paragraph 5017 and chapter 23 of the MCDCM. Units can tailor the ball and cake-cutting ceremony guidance in the MCDCM to fit its needs.

4002. NOMENCLATURE AND GENERAL RULES OF THE SWORD

1. The sword is carried in a scabbard, which sheaths the blade. The sheath is straight and hangs by a ring on a hook, which is attached to the left side of the sword belt. It is worn as depicted in the illustration.

2. The sword grip is made of bone, ivory or special hard white plastic. Short and long slings with snap clips complete the attachment of the scabbard to the sword belt. Study the illustration of the parts of the sword and belt as shown in figure 4-2.

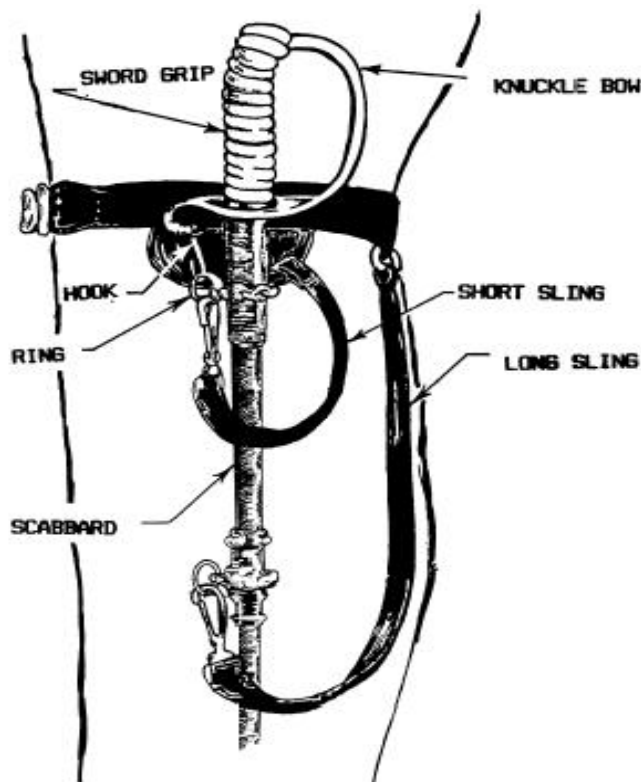

Figure 4-2.--Parts of the Sword.

3. When in formation, officers draw and return swords, without command, when the commander of their unit does. Unless they are members of the commander's staff, other unit officers execute all other movements of the sword manual on the commander's command to the entire unit. After these orders are carried out, the commander gives separate commands to his staff, which he and his staff execute together.

4. The sword will be drawn by unit leaders whenever the unit or drill team is armed with drill rifles, except when at ease, rest, route step, at ease march or inspecting cadets. The unit leader, after being inspected, will return sword prior to accompanying the inspecting party.

5. The sword should always be in its scabbard when its bearer is not in formation.

6. CARRY OF THE SWORD AND SCABBARD UNRIGGED

a. When not in formation and it is impractical to carry the sword and scabbard rigged at the side (slung or in a frog), the sword sheathed in its scabbard may be carried under the left arm.

b. Place the sword and scabbard under the pit of the left arm with the hilt just to the rear of the left shoulder (knuckle bow up). The shoe or lower edge of the scabbard is forward and slants downward to prevent the sword from falling out of the scabbard. The left arm is crooked so that the left hand supports the scabbard forward of the shoulder. The fingers of the left hand are joined and wrapped around the top of the scabbard, and the thumb is wrapped around and supports it from underneath. The upper left arm holds the scabbard against the body.

4003. DRAW SWORD

1. The command is **"Draw, SWORD."**

2. On the preparatory command **"Draw,"** grip the scabbard just below the upper ring mounting with your left hand. Turn the scabbard clockwise about 180 degrees and tilt it forward to form an angle of 45 degrees with the deck. Grasp the sword grip with your right hand and pull it about six inches out of the scabbard. Your right forearm should now be parallel to the deck, your left hand holding the scabbard against your side.

3. On the command of execution **"SWORD:"**

a. Draw the sword smartly out of the scabbard, raising your right arm to its full length directly in front of you at an angle of 45 degrees with the sword in a straight line with your arm and shoulder, the true edge down; at the same time, lower your left hand to your side.

b. Pause for one count.

c. Lower your right arm down toward your right side while at the same time bringing the point of the sword blade toward your right shoulder. Upon completion of this motion, the blade will be in a vertical position with the back of the blade against the shoulder seam of your coat/shirt, the back of the grip to the rear and your arm fully extended, with your thumb and forefinger gripping the lower part of the grip. The blade should touch your shoulder simultaneously with the action of the right hand's placement along the trouser seam. Your thumb is along your trousers seam, and the remaining fingers joined in a natural curl behind the end of the hilt as if holding a pen or pencil. This is the position of carry sword.



Figure 4-3.--Draw Sword To Carry Sword.

4004. PRESENT SWORD FROM CARRY OR ORDER SWORD

1. The command is "**Present, Sword (ARMS).**" It may be given only when halted at order sword or carry sword. It is executed in two counts.
2. On "**Present,**" raise the right hand to the level of and 6 inches in front of the neck. Keep the thumb on the left side of the grip, wrist slightly bent, and inner forearm against the body. The blade should incline forward at a 30-degree angle from vertical.
3. On "**SWORD (ARMS),**" bring the point down smartly, without whipping, to a position three inches above the deck and slightly right of the right foot. Straighten the arm so the knuckle bow is against the trouser seam. The blade is inclined down and to the front with the true edge to the left. The thumb remains on the left side of the grip (see figure 4-3).
4. When at carry or order sword and it becomes necessary to salute without command, execute present sword. After the salute has been returned, go to order sword (then to carry sword if walking).



On Command **"Present"** (Front)



On Command **"Present"** (Side)



Present Sword



Present Sword (Side).

Figure 4-4.--Present Sword.

4005. ORDER SWORD FROM PRESENT SWORD

1. The command is **"Order, SWORD (ARMS)."** It is executed in one count.
2. On "SWORD (ARMS)," turn the true edge down. In this position, the right arm hangs naturally with the thumb along the trouser seam. The blade slants down to the front with the point 3 inches from the deck (see figure 4-5).



Present Sword Order Sword (Front) Order Sword
 Figure 4-5.--Order Sword from Present Sword.

4006. CARRY SWORD FROM ORDER SWORD OR PRESENT SWORD

1. Carry sword is the position to which you will move the sword in the following situations:

- a. Giving commands.
- b. Changing positions in formation at quick time.
- c. Addressing or being addressed by a senior.
- d. The preparatory command for quick time (**FORWARD**) has been given.

e. While marching at quick time. While marching with the sword at the carry, your arms should swing six inches to the front and three inches to the rear. Do not hold the sling or scabbard while marching.

f. When any manual of arms movement has been ordered except parade rest, at ease, rest, present arms, or eyes right/left. When in formation with personnel to your front at normal distance or less (staves excluded), remain at carry sword except at rest or at ease.

2. The command is "**Carry, SWORD**" it may be given only when halted at order sword or present sword. Cadets armed with the sword would also execute carry sword when the unit is given any manual of arms movement (e.g., port, left/right shoulder arms).

3. When at order sword and the command "**Carry SWORD**" is given. On the command of execution "**SWORD,**" bend the wrist without bending the elbow, and bring the false edge of the blade against the shoulder seam, blade vertical back of the grip to the rear, and the arm nearly extended. The right thumb and forefinger embrace the lower part of the grip, with the thumb against the trouser seam, and the remaining fingers joined in a natural curl behind the end of the hilt. In order to maintain control of the blade the right hand should maintain contact with the leg throughout the movement. This action to move the blade upward should resemble an upside down "U" along the leg—not a flick of the wrist. The thumb and forefinger should apply pressure against the grip in order to keep the sword snugly into the small of the shoulder.

4. When at present sword and the command of "**Carry, SWORD**" is given.

a. On the preparatory command of **"Carry,"** turn the true edge down. In this position, the right arm hangs naturally with the thumb along the trouser seam. The blade slants down to the front with the point three inches from the deck.

b. On the command of execution **"SWORD,"** bend the wrist without bending the elbow, and bring the false edge of the blade against the shoulder seam, blade vertical back of the grip to the rear, and the arm fully extended. In order to maintain control of the blade the right hand should maintain contact with the leg throughout the movement. This action to move the blade upward should resemble an upside down "U" along the leg—not a flick of the wrist. The right thumb and forefinger embrace the lower part of the grip, with the thumb against the trouser seam, and the remaining fingers joined in a natural curl behind the end of the hilt. The thumb and forefinger should apply pressure against the grip in order to keep the sword snugly into the small of the shoulder.

4007. EYES RIGHT (LEFT) FROM CARRY OR ORDER SWORD

1. The command is **"Eyes, RIGHT (LEFT)."** It may be given when halted at order sword or when marching at carry sword. It is executed in two counts.

2. Eyes Right (Left) While Halted

a. On **"Eyes,"** raise the right hand to the level of and six inches in front of the neck. Keep the thumb on the left side of the grip, wrist slightly bent, and inner forearm against the body. The blade should incline forward at a 30-degree angle from vertical. This movement is the same as that made on the preparatory command of **"Present."**

b. On **"RIGHT (LEFT),"** bring the point down smartly, without whipping, to a position 3 inches above the deck and slightly right of the right foot. Straighten the arm so the knuckle bow is against the trouser seam. The blade is slanted down and to the front, with the true edge to the left. The thumb remains on the left side of the grip. At the same time, turn the head and eyes 45 degrees to the right (left). If in extreme right (left) file, continue looking straight ahead.

3. Order Sword From Eyes Right (Left) (Executed While Halted with commands and without commands)

a. The command is **"Ready, FRONT."** It is executed in one count.

b. On **"FRONT,"** turn the true edge of the sword down. At the same time, turn the head and eyes smartly to the front.

c. As the reviewing party passes, follow with your head and eyes until you are looking directly to the front and then execute order sword.

4. Eyes Right (Left) While Marching

a. The command is **"Eyes, RIGHT."**

b. The preparatory command **"Eyes"** is given as the right foot strikes the deck.

c. As the left foot strikes the deck raise the right hand to the level of and 6 inches in front of the neck. Keep the thumb on the left side of the grip, wrist slightly bent, and inner forearm against the body. The blade should incline forward at a 30-degree angle from vertical. This movement is the same as that made on the preparatory command of **"Present."** The left arm continues to swing naturally.

d. The command of execution **"RIGHT"** is given as the right foot strikes th

e. As the left foot strikes the deck bring the point down smartly, without whipping, to a position 3 inches above the deck and slightly right of the right foot. Straighten the arm so the knuckle bow is near but not touching the trouser seam. The knuckle bow does not rest against the trouser seam while marching in order to prevent the sword from moving. The blade is slanted down and to the front, with the true edge to the left. The thumb remains on the left side of the grip. At the same time, turn the head and eyes 45 degrees to the right. If in extreme right file, continue looking straight ahead. The right arm does not swing. The left arm continues to swing naturally.

f. To execute eyes left while marching, use the above sequence substituting left for right and right for left.

5. Carry Sword from Eyes Right (Left) (Executed When On The March)

a. The command is "**Ready, FRONT.**" Execution is begun on the preparatory command.

b. The preparatory command "Ready" is given as the left foot strikes the deck.

c. As the right foot strikes the deck turn the true edge of the sword down.

d. The command of execution "**FRONT**" is given as the left foot strikes the deck.

e. As the right foot strikes the deck raise the sword to carry. At the same time, turn the head and eyes to the front.

f. The best way to remember the movements of the sword when executing eyes right and ready front while marching is:

Foot	RIGHT	LEFT	RIGHT	LEFT	LEFT	RIGHT	LEFT	RIGHT
Command	" Eyes,	(UP)	" RIGHT "	(DOWN)	" Ready,	(DOWN)	" FRONT "	(UP)

4008. PARADE REST FROM CARRY OR ORDER SWORD

1. The command is "Parade REST." This command is normally given from order sword, in which case it is executed in one count.

2. If given when at carry sword, go to order sword on the command of "**Parade.**" "**REST,**" move the left foot smartly 12 inches to the left. At the same time, lower the point of the sword to the deck, place the left hand behind you, at the small of the back, fingers extended and joined, thumb along the hand.

3. Order Sword From Parade Rest

a. The command is "**Platoon (Company or Detail), ATTENTION.**" It is executed in one count.

b. On "ATTENTION," bring the left heel smartly against the right and the left hand back to the side. Raise the blade so the point is 3 inches from the deck.

4009. AT EASE FROM CARRY OR ORDER SWORD

1. The command is "AT EASE." It may be given from any position of the sword.
2. On "AT EASE," go to order sword if not already at that position. Then move the left foot 12 inches to the left and lower the point of the sword to the deck. Rest the weight equally on both feet with the legs straight. At the same time, place the left hand behind you. Keep the fingers straight and joined, the palm flat and facing rear. You may relax and, except for your right foot and sword point, move about. Do not talk.

4010. REST FROM ANY POSITION OF THE SWORD. The command is "REST." It is executed in the same manner as at ease, the only difference being that you may talk.

4011. TO RETURN TO ATTENTION

1. The command is "Platoon (Company or Detail), ATTENTION." Execution is begun on the preparatory command.
 - a. On "**Platoon (Company or Detail)**" go to parade rest.
 - b. On "**ATTENTION,**" bring the left heel smartly against the right and the left hand to the side. Raise the blade so the point is 3 inches from the deck.

4012. RETURN SWORD FROM CARRY OR ORDER SWORD

1. The command is "**Return, SWORD.**" Execution is begun on the preparatory command.
 - a. On the preparatory command "**Return,**" raise the right hand and sword to a position six inches in front of the neck, as in the first count of present sword. At the same time, grasp the scabbard with the left hand just above the upper brass mounting ring. Tilt is forward and turn it clockwise 180 degrees. The scabbard should form a 45-degree angle with the deck. Then lower the sword point to a position just above the opening of the scabbard. Look down at the opening. Guide the point into the opening with the left thumb and forefinger until the right wrist and forearm is parallel to the deck. At the same time, raise the head back to attention. The left hand holds the scabbard against the side.
 - b. On the command of execution "**SWORD,**" push smartly down on the grip so it will slide all the way into the scabbard. Then bring the right hand smartly back to the right side. At the same time, rotate the scabbard with the left hand 180 degrees counterclockwise and return the left hand to the position of attention (see figure 4-6



Figure 4-6.--Return Sword.

CHAPTER 5
GUIDON MANUAL

5000. GENERAL

1. The guidon is a company/platoon identification flag. It is carried on an 8-foot staff at ceremonies and at other times prescribed by the SNSI/NSI. (See figure 5-1.)

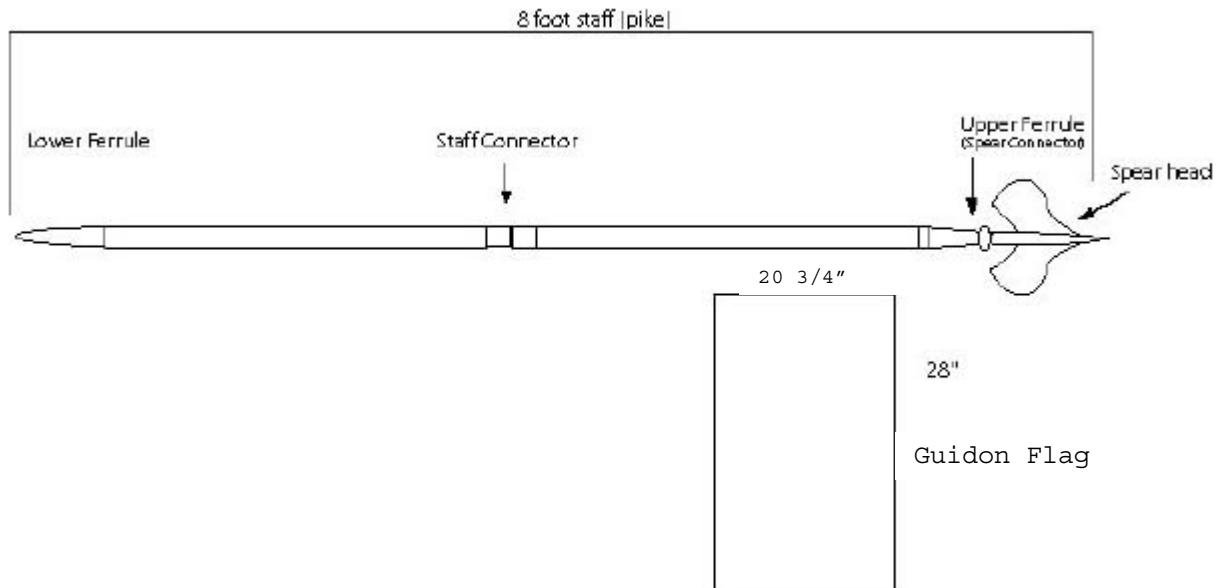

Figure 5-1.--Guidon and Staff.

2. In garrison, the guidon may be displayed at company headquarters between morning and evening colors, except during inclement weather and when carried in formation.
3. In selecting a guidon bearer, the SNSI or NSI should choose an individual who is outstanding in bearing, appearance, and ability.
4. When acting as guidon bearer, the individual is considered under arms and does not have to carry a weapon. If a weapon is carried, it will be slung or holstered.
5. The guidon is brought to present guidon, parade rest, and order guidon with the company.
6. When at route step or at ease march, the guidon may be carried in either hand.
7. When at order guidon, the guidon is brought to carry on the preparatory command for any facing or marching movement.
8. The guidon staff should be marked with two thumbtacks. The first tack marks the position of the guidon bearer's right thumb position at order guidon. The second thumbtack is placed 6 inches below the first tack to mark the guidon bearer's right thumb position at carry guidon.
9. The two grasps of the guidon are identified as the "V" grip and the strong grip. For the "V" grip, the staff is placed in the "V" formed by the thumb and fingers of the right hand, thumb along the trouser seam with the fingers extended and joined. The strong grip is when the thumb is wrapped around the front of the staff with the fingers wrapped to the rear. (See figure 1-4)

a. The "V" grip is used at the order and when executing "Present Guidon" and during "Eyes Right/Left" and "Officers Center." (See figure 1-5)

b. The strong grip is used while on the march and facing movements.

10. All guidon movements are performed at 112-120 beats per minute.

5001. ORDER GUIDON. At order guidon, the ferrule rests on the deck touching the outside edge of the right shoe close to the little toe. The staff is grasped in the "V" grip with the right elbow close to the side so that the forearm helps to support the staff. The upper staff rests in the hollow of the right shoulder. The staff is vertical with the flat side of the spearhead facing front. The rest of the body is at attention. (See figure 5-2.)



Figure 5-2. Order Guidon.

5002. CARRY GUIDON. This is the normal position of the guidon while marching at quick time. It is carried using the strong grip with the ferrule 6 inches above the deck and the flat side of the spearhead facing front. (See figure 5-3.)



Figure 5-3. Carry Guidon.

5003. DOUBLE TIME WITH THE GUIDON. For marching at double time, on the preparatory command, bring the staff across the body with the spearhead to the left. The right hand grasps the same spot as at carry. The right forearm is level with the deck and the elbow against the body. Grip the staff with the left hand in front of the point where the neck and left shoulder join. The flat side of the spearhead should face front. (See figure 5-4.)



Figure 5-4. Guidon Carry at the Double Time

5004. CARRY GUIDON FROM ORDER GUIDON. This three-count movement is executed on the preparatory command for any movement that will require the guidon bearer's feet to be moved. Execution is begun on a preparatory command such as **"Forward," "About,"** etc.

Note: Unit leaders should pause before giving the command of execution to allow the guidon bearer time to execute this movement.

1. On the preparatory command, reach across the body and grasp the staff with the left hand.
2. Change the grasp to the strong grip, while raising the staff with the left hand until the ferrule is 6 inches above the deck. Hold the staff vertical with the right hand.
3. Move the left hand smartly back to the side.

5005. READY GUIDON FROM ORDER OR CARRY GUIDON

1. This movement is used as a signal for helping the cadets in the execution of commands where hearing verbal commands is difficult, such as when in a very large formation or when following closely behind a band. On the preparatory command of marching movements, for example FORWARD, the guidon is raised to ready guidon with the flat edge of the spearhead to the front. Without changing position of the right hand, raise the guidon vertically over your head until your right hand is in line with your right shoulder, your right elbow touching your side. Simultaneously move the left hand across the body and grasp the staff at a point directly in front of the right hip, left forearm against the body. Hold the guidon in this position until the command of execution is given, such as MARCH, then lower the guidon to the carry, smartly returning the left hand to the left side.

2. Ready guidon may be used as a signal for the execution of any command except present arms and eyes right (left) since the guidon is also rendering honors at that time.

3. Ready guidon may also be executed without command during formation of a unit prior to march on for a review of parade. The guide executes it after the unit has been brought to attention (right shoulder arms if so armed) after the adjutant has commanded, **"Sound, ATTENTION."** Ready guidon is used to signal the adjutant that the unit is ready for his next command.



Figure 5-5.--Ready Guidon



Carry



Present



Double Time

Figure 5-6.--Positions of the Guidon

5006. ORDER GUIDON FROM CARRY GUIDON. This two-count movement is executed without command at the completion of any movement that required the guidon bearer to come to carry guidon. If there are a series of movements, executed immediately one after the other, order guidon will not be executed until after the final one. However, during NJROTC drill competition, the guide will execute order guidon after each movement. Order guidon is executed in two counts by 1) allowing the staff to slip through the right hand until the lower ferrule rests on the deck (This movement may create an audible sound as the ferrule touches the deck) and 2) changing the grasp to the "V" grip. The left hand does not assist this movement.

5007. PRESENT GUIDON FROM ORDER OR CARRY GUIDON. From order or carry guidon, this movement is executed on command. During officers center, the movement is executed after halting, from the carry and without command. Since the right hand is 6 inches lower on the staff at carry than at order, the ferrule will extend farther to the rear when at present guidon from order than it will at present guidon from the carry.

1. From order guidon, the command is "**Present, ARMS.**" It is executed in one count.

2. On "**ARMS,**" lower the guidon straight to the front. The right arm is extended until the lower portion of the staff rests in the pit of the right arm and the entire staff is horizontal to the deck. As the staff is lowered rotate the staff to the right so that the sharp edge of the spearhead faces down. Hold the right elbow firmly against the body. (See figure 5-6.)

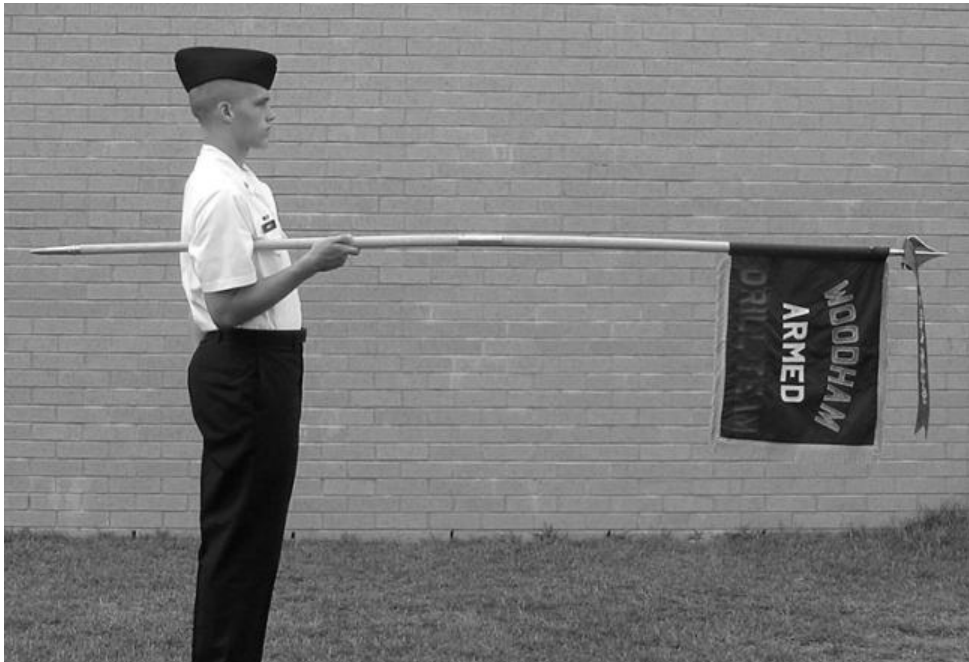

Figure 5-7. Present Guidon.

3. From carry guidon and while on the march, the command is **"Eyes, RIGHT (LEFT)."** It is executed in the following manner:

a. On the command **"Eyes, RIGHT (LEFT),"** if the guidon bearer is marching one pace to the left and one pace to the rear of the unit leader, it is executed in the same manner as from order guidon except that the head and eyes are turned right (left) 45 degrees as the guidon is lowered. (See figure 5-7b.)

b. On the command **"Eyes, LEFT,"** if the guidon bearer is marching in the extreme right file it is executed in the same manner as from order guidon except that the head and eyes are turned left 45 degrees as the guidon is lowered

c. On the command **"Eyes, RIGHT,"** if the guidon bearer is marching in the extreme right file it is executed in the same manner as from order guidon with the head and eyes to the front as the guidon is lowered (See figure 5-7a.)



Figure 5-7 a. Eyes Right with Guidon on the March.



Figure 5-7 b. Eyes Right with the Guidon One Pace to the Left and One Pace to the Rear of the Unit Leader.

5008. ORDER GUIDON AND CARRY GUIDON FROM PRESENT GUIDON

1. To return to order guidon, the command is "**Order, ARMS.**"

2. On the preparatory command "**Order,**" grasp the staff smartly and audibly with the left hand, palm up, at a point just forward of the right hand. (See figure 5-8.) On "**ARMS,**" with the left hand, pull the guidon staff up and back to the vertical position of carry guidon, pivoting it on the right hand as it is lowered back to the right side. Then let the staff slide straight downward through the right hand until the lower ferrule rests on the deck, the left hand steadies the staff as it slides downward. Cut the left hand smartly back to its normal position at the left side. The flat side of the spearhead is back facing to the front.



Figure 5-8.--Movements to Carry Guidon from Present Guidon.

3. To return to carry guidon the command is "**Ready, FRONT.**"

4. On the preparatory command "**Ready,**" grasp the staff smartly and audibly with the left hand, palm up, at a point just forward of the right hand. On "**FRONT,**" with the left hand, pull the guidon staff up and back to the vertical position of carry guidon, pivoting it on the right hand as it is lowered back to the right side. The flat side of the spearhead facing to the front. Cut the left hand back to the left side and turn the head and eyes smartly to the front.

5009. PRESENT GUIDON FROM CARRY GUIDON AT OFFICERS CENTER. This movement is executed without command, upon halting at officers center during a parade. It is executed in one count as explained in paragraph 5007.2. The movement will be executed on the fourth count after the command "**Officers, HALT.**" For details on executing officers halt refer to MCO P5060.20 paragraphs 17006.9 through 17006.14.

5010. CARRY GUIDON FROM PRESENT GUIDON AT OFFICERS CENTER

1. The command is "**Carry, SWORD.**" "**Ready, TWO**" if the officers are not armed with swords.

2. On the preparatory command "**Carry (Ready),**" grasp the staff with the left hand and on the command of execution "**SWARDS (TWO),**" bring the staff back to the carry guidon position as described in paragraph 5002.

5011. GUIDON SALUTE FROM CARRY OR ORDER GUIDON.

1. The command is "**GUIDON (Rifle), SALUTE.**" This movement may be executed on command, when in formation, or individually if the guidon bearer is in route to or from formation. It is executed in two counts.
2. On "**SALUTE,**" move your left hand, palm down, smartly to a position above the right hand with the left arm parallel to the deck. Keep the thumb and fingers straight and together. Touch the staff with the first joint of the forefinger. Turn your head and eyes toward the person being saluted.
3. After your salute is returned, move your left hand smartly back to your side and look to the front. See illustrations on the next page for the Guidon Salutes.



Figure 5-10. Guidon Salute from Carry or Order Guidon.

5012. RESTS WITH THE GUIDON

1. Parade Rest from Order Guidon

a. The command is "**Parade, REST.**" It is executed in one count. It may be given only when halted at attention.

b. On the command of execution "**REST,**" slide the right hand up the staff to shoulder height. The staff remains in place and vertical. Without loss of motion, straighten the right arm so the staff of the guidon tilts forward at 30 degrees. The fingers and thumb of the right hand are wrapped around the staff. The ferrule remains in the same position as at order guidon. The flat side of the spearhead remains facing front. Place the left hand in the small of the back. Keep the fingers straight and touching. The palm is flat and facing the rear. At the same time, move the left foot smartly 12" to the left without bending the knee. (See figure 5-11b.)



a. Front



b. Side

Figure 5-11.--Parade Rest with the Guidon.

2. At Ease or Rest from Order Guidon. On the command "AT EASE" or "REST," the right foot remains in place and the guidon is held as in parade rest with the right arm relaxed slightly.

a. The command is "**AT EASE.**" It is executed in two counts. It may be given only when halted at attention.

b. On the command, and for count one, execute parade rest as described in paragraph 5013.1b.

c. On the second count, you may relax and, except for your right foot and ferrule, move about. Do not talk.

3. Fall Out from Order Guidon. The command is "**FALL OUT.**" It may be given only from order guidon. Upon the command, leave your position in ranks but remain nearby.

4. Order Guidon from Rest Positions

a. From parade rest, at ease, and rest, the command is "**Platoon (Company or Battalion), ATTENTION.**" On the preparatory command, go to parade rest, if not already in that position. At the command "**ATTENTION,**" go smartly to order guidon.

b. From fall out, the command is "**FALL IN.**" Upon the command, go back to your position in formation and stand at attention at order guidon.

NJROTC DRILL MANUAL

SECTION I: GENERAL COLOR GUARD INFORMATION

CHAPTER 6

6000. GENERAL

1. When flown from ships or crafts of the Navy or from a flagstaff at commands ashore, the national flag will be displayed per the provisions of *U.S. Navy Regulations*. The national flag is also called the "national ensign" or "ensign."
2. NJROTC units are equipped with a national flag and an organizational flag. The organizational flag is an official flag that is authorized for display by units of the NJROTC.
3. When mounted on a staff (pike) and carried by an individual on foot, or displayed or cased in a fixed location, the national flag is called the "national colors" and the organizational flag is called the "organizational colors." The term "colors" means either or both the national colors and the organizational colors.
 - a. The use of the plural form of the word color (colors) to designate a single flag, ensign, standard, or pennant comes from the ancient tradition of referring to the multiple colors found on these types of standards. This tradition is carried on today when we refer to the national colors; red, white, and blue. The plural form is also used when referring to the types of movements, ceremonies or musical accompaniment involving the colors, i.e., carry colors, morning colors, "To the Colors" etc.
 - b. When designating personnel or units as part of color details then the appropriate singular or plural form of the word will be used, i.e., color guard, color company, etc.
4. When mounted on a vehicle, the national flag is called the "national standard" and the organizational flag is called the "organizational standard." The term "standard" means the national standard only. The term "standards" means both the national standard and the organizational standard.
5. In garrison or on board ship, the colors of an organization, when not in use, are kept by the commanding officer. Whenever practicable, colors should be kept uncased and displayed in the office of the commanding officer, or other appropriate place. They may be cased, however, by placing them within a protective covering. Colors that are kept cased and not used often should be unfurled and aired frequently.
6. The colors (standards) may be carried in any formation in which two or more companies participate, and in escorts and honor guards when ordered. Separate companies and detachments authorized organizational colors, may carry colors when two or more platoons participate. Unless otherwise directed for special ceremonies, the national colors will always be carried when the organizational colors are carried, but the national colors may be carried alone.
7. In battalion formations, the colors (standards) will be posted with a designated color company and in regimental formations with a designated color battalion. The color company (battalion) is posted in the formation so that the color guard is in the approximate center of the formation (right or forward of center if this is impossible).

8. In most regimental formations, only the colors (standards) of the regiment will be carried. When two or more separate battalions are formed as a regiment, only the colors (standards) of one battalion will be carried for the regiment. When authorized by the commander, however, the organizational colors of subordinate organizations may be carried in ranks (massed color guard) arranged behind the parent organization's color guard.

9. When the organizational colors are draped in mourning, the mourning streamer shall consist of a black crepe streamer 7 feet long and about 12 inches wide. A bowknot, the loops of which are 6 inches long, is tied in the center. This knot attaches the streamer to the upper ferrule, just below the spearhead. If a streamer attachment set is used; the bowknot will be tied on the upper ferrule below the streamer attachment set in a manner so as not to disturb the natural hang of the unit's battle streamers.

10. Uncased colors will be treated with dignity and formality. When moved while outdoors, they will be marched by a color guard. Whenever possible, they will be escorted by a color company (battalion) from the organizational headquarters to the place of the ceremony. If it becomes necessary to case or uncase the colors outdoors, it will be accomplished with proper ceremony as described in paragraph 6019.

11. Whenever the colors are brought forward of the line of troops (e.g., trooping the colors, for retirements, awards, etc.) the command must present arms. If a band is present, then the appropriate music, e.g., "National Anthem," "To the Colors," or "Retreat" is played

12. During training and rehearsals (except full dress rehearsals), colors will be cased.

13. Colors (standards) are never allowed to touch the deck.

14. Color guards do not fix bayonets.

15. The standard weapon used for the color guard is the NJROTC Drill rifle.

16. All NJROTC units, will refer to chapter 3 for the manual of arms.

17. The national and organizational colors are only destroyed when; they have become soiled beyond cleaning, torn beyond repair and to keep them from falling into enemy hands.

18. Flags that may have a historical significance are disposed of per the instructions contained in MCO P10520.3.

19. For further information concerning flags, streamers and guidons refer to MCO P10520.3.

6001. COLOR SALUTES

1. **By the National Colors (Standard).** The national colors (standard) renders no salute, except as specified in *U.S. Navy Regulations*, paragraph 1263.1.

2. By the Organizational Colors. In military ceremonies, the organizational colors salutes while the "National Anthem," "To the Colors," "Retreat," or "Hail to the Chief" is being played, and when rendering honors to the organizational commander, individual of higher rank, or the dead, but in no other case. (See par. 6009.)

3. By the Organizational Standard. The organizational standard renders no salutes as it is mounted on a vehicle.

6002. HOISTING, LOWERING, AND FOLDING THE NATIONAL ENSIGN

1. General

a. The ceremonial hoisting and lowering of the national ensign at 0800 and sunset, respectively, shall be accomplished ashore per the provisions of *U.S. Navy Regulations* and this paragraph.

b. A detail consisting of 3 or more cadets will hoist and lower the ensign.

c. The SNSI/NSI will see that the proper ensign is flown at the appropriate time and under all weather conditions. For different types of ensigns. (See figure 6-1.) Any cadet who observes any hazard to the ensign, such as loosened halyards, fouling, etc., will immediately report them to the SNSI/NSI.

2. Positions of the Ensign. The ensign is flown from the peak or truck of the mast, except when directed to be flown at half-mast. The ensign at half-mast is flown, when possible, with the middle point of its hoist opposite the middle point of the mast. The middle point of a guyed mast is midway between the peak of the mast and the point of attachment of the guys (See figure 6-2). The middle point of a mast with a yardarm is midway between the peak of the mast and the yardarm. Technically an ensign at any position other than at the peak of the mast is half-mast. Local conditions may require other positions. To half-mast the ensign, it is first hoisted to the peak and then lowered to the half-mast position.

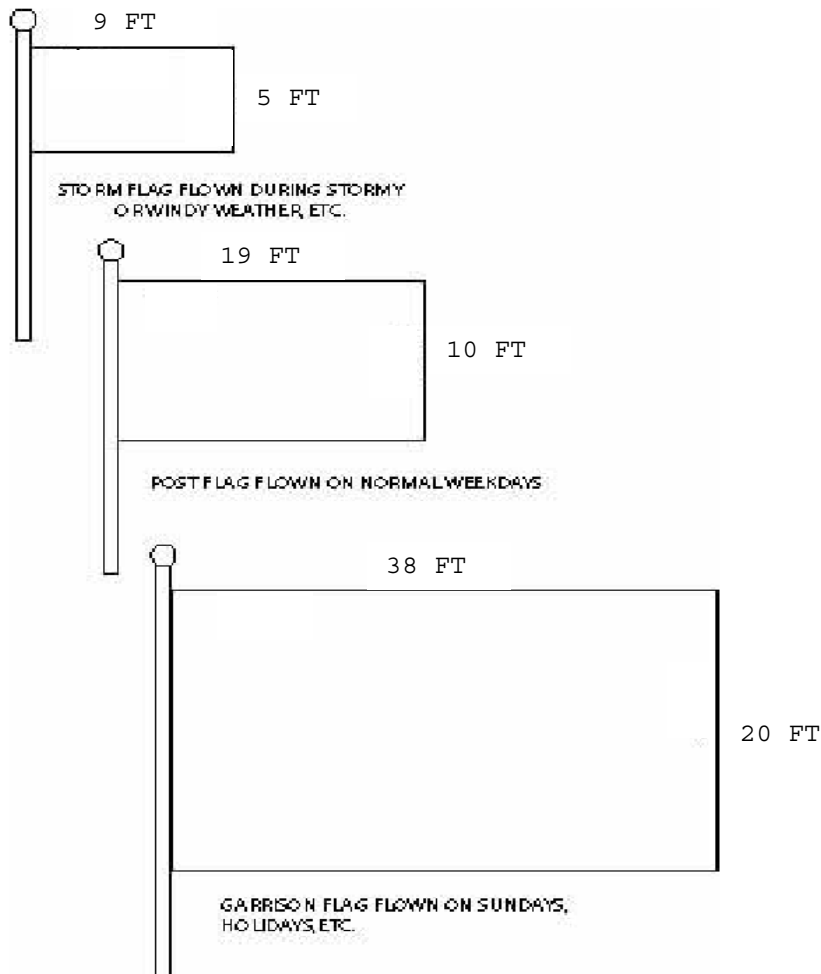

Figure 6-1.--Different Types and Nomenclature of Ensigns.

3. Hoisting the Ensign. The detail of at least 3 members assigned to hoist the ensign is formed in line carrying the folded ensign in the center. The detail is then marched to the flagstaff, halted, and the ensign attached to the halyards. The halyards are manned by the two cadets, who take positions on opposite sides of the staff, facing it, so they will be able to hoist the ensign without fouling it. The flag should be clearly marked so that the blue field is raised first. Additionally, the ensign should be pulled sufficiently, prior to the beginning of colors, to ensure the blue field is hoisted first. This action precludes the embarrassment of hoisting the ensign upside down. The unit leader continues to hold the ensign until it is hoisted clear of his grasp to prevent it from touching the deck. When the ensign is clear, the detail leader executes a hand salute. After the ensign is hoisted, the other members of the detail grasp the halyard in their left hand and execute a hand salute. On the last note of the "National Anthem" or "To the Colors," all members of the detail terminate their hand salutes. If the ensign is to be flown at half-mast, it is then lowered slowly to that position. (See figure 6-2.) The halyards are then secured to the cleat of the mast. The detail is again formed, marched to their point of origin, and dismissed.

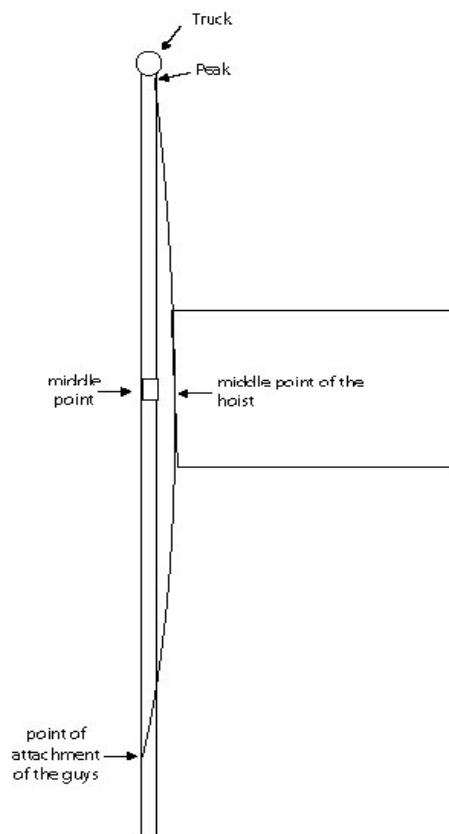

Figure 6-2.--Position of National Ensign at Half-Mast.

4. Lowering the Ensign. The detail is formed, marched to the flagstaff, and the halyards manned in the same manner as for hoisting the ensign. On the first note of the "National Anthem" or "Retreat," the ensign is slowly lowered. If at half-mast, it is first hoisted smartly to the peak on the first note of the music, and then slowly lowered. The unit leader catches it at the last note of the music. The ensign is detached from the halyards and folded as prescribed below. The halyards are secured to the mast; the detail is formed and marched to its point of origin, where the ensign is turned over to the SNSI/NSI.

5. Replacing an Ensign Already Hoisted. There may be times when it is necessary to replace the ensign after morning colors but prior to evening colors. Some

examples are, changing to a storm flag due to inclement weather; the ensign becomes fouled in the halyards; the ensign is raised upside down; etc.

a. If the flagstaff is double rigged, i.e., has two sets of halyards, the new ensign is hoisted to the peak or truck and then the ensign being replaced is slowly lowered, folded and returned to its point of origin.

b. If the flagstaff has only one halyard, two color details are used to replace the ensign. The first color detail slowly lowers the ensign, and then quickly moves from the flagstaff to fold the old ensign. The second color detail, with the replacement ensign, then moves to the flagstaff and hoists the new ensign to the peak or truck. Both details salute as the replacement ensign is hoisted. Both color details then return their point of origin.

6. Folding the Ensign. The ensign is folded in half the long way so the crease parallels the red and white stripes. It is folded in half again so the new crease also parallels the red and white stripes with the blue field on the outside of the fold. The lower corner of the fly end (away from the blue field) is folded up to the top so the single (folded) edge lays perpendicular across the stripes. By repeatedly folding along the inboard edge of the triangle, the ensign is folded into the shape of a cocked hat. (See figure 6-3.)

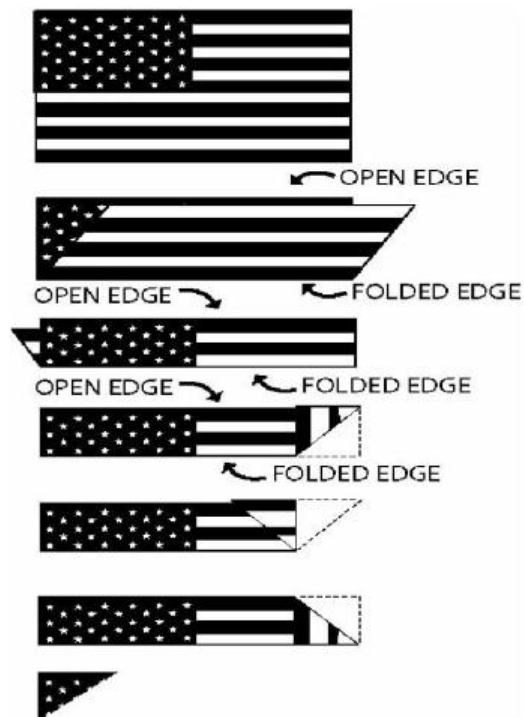

Figure 6-3.--Folding the Ensign.

6003. SALUTES AND HONORS TO THE NATIONAL FLAG

1. General. Salutes to the national flag are rendered per *U.S. Navy Regulations*. (See chapter 12, section 2.)

2. By Individuals. Individuals in the Navy, when in uniform and covered will render the appropriate salute (hand, rifle, etc.) as indicated below. Persons not in uniform will stand at attention, face the flag and place the right hand over the heart. Gentlemen, if covered, remove their headdress with the right hand and hold it at the left shoulder, so that the right hand is over the heart. When in full uniform indoors and uncovered, individuals will stand at attention.

a. During morning colors and evening colors individuals stop and face the flagstaff, or in the direction of the music, when "Attention" is sounded. Salutes are rendered by individuals on the first note of the "National Anthem," "To The

Colors," or "Retreat," and terminated on the last note. Individuals would remain at attention facing the flagstaff/music until "Carry On" is sounded, and then continue about their duties.

b. When being passed by or passing the national colors (standard) uncased.

c. Small flags carried by individuals and flags flying from flagstuffs, either standing alone or affixed to a building, (except during morning and evening colors) are not saluted.

d. A folded flag being carried to morning colors, or from evening colors, by a color detail is considered cased and not saluted.

3. By Persons in Formation

a. During morning colors and evening colors the formation commander stops the formation and causes it to face the flagstaff, or in the direction of the music, when "Attention" is sounded. The formation commander salutes for the formation on the first note of the "National Anthem," "To The Colors," or "Retreat," and terminate the salute on the last note. The formation is kept at attention facing the flagstaff/music until "Carry On" is sounded at which time the formation commander would move the formation to its destination or dismiss the formation.

b. When being passed by or passing the national colors (standard) uncased, persons in formation are brought to attention and order arms if halted, or attention if marching. The formation commander shall render the salute for his unit, facing the colors if the formation is halted. Persons in formation participating in a ceremony shall, on command, follow the procedure prescribed for the ceremony.

c. Small flags carried by individuals and flags flying from flagstuffs, either standing alone or affixed to a building, (except during morning and evening colors) are not saluted.

d. A folded flag being carried to morning colors, or from evening colors, by a color detail is considered cased and not saluted.

4. By Occupants of Vehicles. During morning colors or evening colors or when being passed by or passing an uncased national colors, all vehicles in motion will be brought to a halt. Persons riding in such vehicles shall remain seated at attention until colors are over or the color has passed.

6004. COMPOSITION OF THE COLOR GUARD

1. The size of a color guard may vary. The color bearers are unarmed and the national color bearer commands the color guard. He/she gives the necessary commands for the movements and rendering of honors. The organizational color is always positioned on the left of the national color. When only the national color is carried, the color guard will consist of only one color bearer. (See figure 6-4 a and b.)

Figure 6-4 a. Composition of a typical NJROTC Color Guard

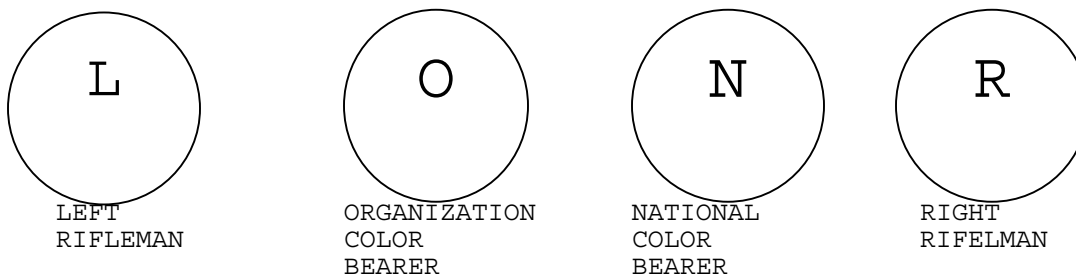
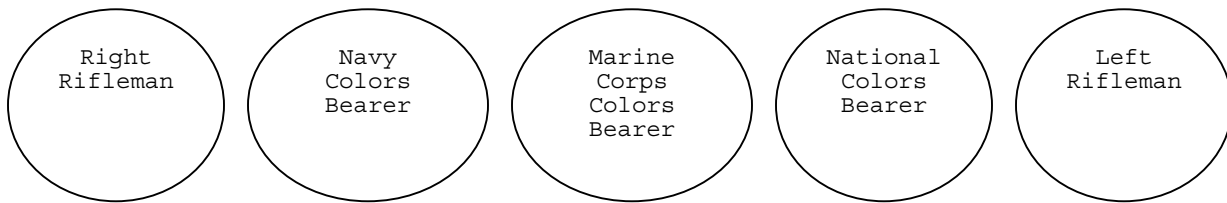

Figure 6-4 b. Composition of a 5 member Color Guard carrying Marine Corps and Navy Colors



2. If a female is part of the color guard, for uniformity she wears trousers and not a skirt. The color bearers should not wear medals or ribbons and badges because the slings will destroy them. (Optional) Slings are adjusted so that the colors are the same height when at the carry or, if this isn't possible, the national colors are slightly higher than the organizational colors. If necessary, have the senior color bearer slightly taller than the organizational color bearer. All members of the color guard may wear the guard belt; the color bearers wear the guard belt over the sling to keep the sling firmly in place. If the color guard is wearing the combination cover, then they may use two chin-straps. One is worn normally and the second one (black plastic only) is worn under the chin. When only the national colors is carried, the color guard will include only one color bearer.

3. The NJROTC color guard is formed and marches in one rank at close interval with the color bearers in the center. The color guard marches at the normal cadence of 112-120 thirty-inch steps per minute (quick time). The color guard does not execute to the rear march, about face, flanking movements. When the unit to which the color guard is attached executes any such commands, the national color bearer orders an appropriate movement, which will be covered later in this chapter. The color guard is formed and marches in one rank at close interval with the color bearers in the center. While marching, members of the color guard do not swing their free arms. The color guard does not execute to the rear march, about face, flanking movements or fix bayonets. When the unit to which the color guard is attached executes any such commands, the senior color bearer orders a movement appropriate for the color guard.

Note: The aisles may be too narrow for a color guard to march in normal formation. The color guard would then march in by two's or in column of ones. If marching in by twos then the color bearers lead and the riflemen follow. Upon reaching the spot for presenting the colors, the riflemen would step into their normal position. If marching in a column of ones the order of march is **ALWAYS**, right color guard, national color bearer, organizational color bearer, left color guard. When reaching their spot the color guard would reform. Make sure the colors don't reform inverted.

4. All colors carried by the color guard are attached to staffs of equal height. The standard color staff consists of a 9 1/2-foot, hardwood pole capped at each end by metal ferrules. The staff ornament for the Colors, when displayed in the NJROTC color guard formation, shall be the battle-ax on the 9 ½ foot pole or the spearhead on the 8 foot pole. A battle-ax shall also top the flagstaff on which is flown the Navy flag and battalion colors. The cutting edge of the battle-ax shall face forward for all drill movement.

5. The 9 ½ foot wooden pole or the 8 foot wooden pole are the only authorized poles to be use for drill meet competition. Metal/Aluminum Poles are not authorized for Drill Meet Competition. The 9 ½ foot wooden pole will carry the 5' x 7' flags, and the 8 foot wooden pole will carry the 3' x 5' flags. The 3' x 5' flags will not be displayed with the 9 ½ foot wooden poles.

6. Color guards carrying the Navy and Marine Corps service colors will consist of five members, three Marines and two Navy members. The national color bearer and commander of the color guard will be a Marine. (See figure 6-4b.)
7. The flags or banners of non-U.S. military organizations (e.g., Boy Scouts, Kiwanis Club, etc.) are not carried in the color guard.
8. Color guards armed with rifles will be trained to execute a modified rifle manual. This involves pauses on the part of one or the other riflemen so that the rifles move to and from the right and left shoulders at the same time, as described in paragraph 6005.
9. The color bearers are unarmed, but the color guards carry rifles (except when inside a chapel). When participating in a ceremony inside a chapel, the color guard will be unarmed and uncovered.

NJROTC DRILL MANUAL

CHAPTER 6

SECTION 2 MANUAL OF ARMS FOR COLOR GUARD

6005. SYNCHRONIZING THE MANUAL OF ARMS FOR THE COLOR GUARDS

1. The manual of arms for color guards armed with rifles must be synchronized so that the rifles move (e.g., off of or to the shoulder) at the same time. Since the left rifleman is at left shoulder arms and the right rifleman is at right shoulder arms, moving to and from the right/left shoulder to the order, present or back to the shoulder often involves different "counts" in the movement for each rifleman. To get the rifles moving together one or the other of the rifleman will have to do an occasional pause in the manual of arms so the other rifleman may catch up. When executing the rifle manual, both riflemen will wait for the senior color bearer's command of "**Ready CUT**" before executing the final count of the movement.

a. Order Colors to Carry Colors. The command is "**Carry, COLORS.**" This is a four-count movement for both riflemen. The right rifleman goes to right shoulder arms and the left rifleman goes to the left shoulder arms.

b. Carry colors to Order Colors. The command is "**Order COLORS.**" This is a four-count movement for the right rifleman and a five-count for the left rifleman. In order to have the rifles move to the order together, the "counts" are modified as follows: (See figure 6-6.)



a. Start.



b. Count One:
Right Rifle Stands Fast.
Left Rifle Re-grasps the Small of the Stock.

Figure 6-6. - Carry Colors to Order



c. Count Two.
Both Rifles Moved from
the Shoulder



d. Count Three.
Both Riflemen Re-grasp the upper
Hand Guard



e. Count Four.
Both Rifles Moved to the
right side



f. Count Five.
Ready Cut

c. Order Colors to Present Colors. The command is "**Present, COLORS.**" This is a two-count movement for both riflemen, with both executing present arms with the rifle.

d. Present Colors to Order Colors. The command is "**Order, COLORS.**" This is a three-count movement for both riflemen, with both executing order arms with the rifle.

e. Carry Colors to Present Colors. The command is "**Present, COLORS.**" This is a three-count movement for both riflemen; however, it becomes a four-count movement to synchronize the rifles being brought from the left and right shoulder to present arms. (See figure 6-7.)



a. Start



b. Count One.
Right Rifle Stands Fast.
Left Rifle Re-grasps the Small of
the Stock

Figure 6-7 Carry Colors to Present Color.



c. Count Two.
Both Rifles Moved from the shoulder.



d. Count Three
Right Rifle Re-grasps the small of the Stock. Left Rifle Stands Fast



e. Count Four.
Both Rifles Rotated to Present Arms

Figure 6-7 Carry Colors to Present Color--Continued.

f. Present Colors to Carry Colors. The command may be "Carry, COLORS" or "Shoulder, ARMS." This is a three-count movement for the left rifleman and a four-count movement for the right rifleman to return the weapons to the left and right shoulder from present arms. (See figure 6-8.)



a. Start



b. Count One.
Both Rifles Rotated to Port Arms



c. Count Two.
Right Rifle Grasps the Butt of the Rifle.
Left Rifle Stands Fast.



d. Count Three
Both Rifles Moved to the Shoulder.



e. Count Four.
Ready Cut.

Figure 6-8 Present Colors to Carry Colors

CHAPTER 6

COLOR GUARD

SECTION 3: MANUAL OF THE COLORS

6006. ORDER COLORS

1. At order colors, the ferrule rests on the deck touching the outside edge of your right shoe.
2. The staff is gripped in a strong grip with the thumb wrapped around the front of the staff and the fingers wrapped to the rear.
3. Color guards armed with rifles are at order arms when the colors are at the order. The proper position of the color at order color is shown in the illustration below.



Fig. 6-9 a. Order Colors using either the 8 foot wooden pole or the 9 ½ foot wooden pole with Color Bearers using the "Strong Grip."



Figure 6-9 b.
Staff Held in the Strong Grip



Figure 6-9 c.
Staff held in the "V" grip

6007. CARRY COLORS FROM ORDER COLORS

1. When changing from order color to carry color, the command is **CARRY, COLORS**.
2. At the command, **CARRY**, change your grip on the staff to the "V" grip so as to grip it from the rear between your right thumb and fingers, the fingers around the staff.
3. At the command **COLORS**, raise the staff smartly with your right hand to a point where the lower ferrule is just above the sling socket. While raising it, keep the staff pointing straight up. Grasp the staff at the lower ferrule with the left hand to steady it and align it with the sling socket. Do not look down.

Note: All organizational colors will be raised to the carry with the national colors.

4. Seat the lower ferrule in the sling socket. As the ferrule is seated, let your right hand slide down the staff to a position directly in front of your chin.
5. Grip the staff firmly with the right hand and move the left hand smartly to your side. In this position, the right hand is directly in front of your face and the staff is inclined slightly to the front.
6. Color guards armed with rifles execute right and left shoulder arms at the command **COLORS** so that the rifles are on the outside shoulder. See illustrations below for proper movements and position of carry colors.
7. All members of the color guard will halt their movements before executing the last count. On the senior color bearer's command "**Ready, CUT,**" all members will move their free hands smartly to their sides. If the colors staffs need additional support due to high winds, the color bearers will grip the staff with their left hands just below their right.



Fig. 6-10 a. Colors Bearers changed grip to "V"



Figure 6-10 b. Raising Staff



Figure 6-10 d. All Movement Halted



Figure 6-10 e. Carry Colors

Movements of Carry Colors from Order Colors

6008. ORDER COLORS FROM CARRY COLORS

1. When changing from carry colors to order colors, the command is "**Order, COLORS (ARMS).**" Execution is begun on the preparatory command.

2. At the command "**Order,**" grip the staff with the left hand above the ferrule and remove the staff from the sling socket. The staff remains centered on the body with the ferrule just forward of the sling socket. (See figure 6-11a.)

3. At the command "**COLORS,**" lower the staff to a point approximately 2 inches above the deck along the outside edge of the right shoe; release the staff with the left hand and re-grip it above the right hand. (See figures 6-11b and 6-11c.)

4. Relax both hands so the staff will slide down until the ferrule rests on the deck. Then trim or strip the colors by maintaining a grip on the staff with the left hand and raising the right hand to lightly grasp the fabric of the colors. Pull it down along the staff (do not attempt to throw or tuck it) and re-grip the staff with the right hand, with the fabric under the right arm. (See figures 6-11c and d.) Then change the position of the right hand to that described for order colors.

5. Color guards armed with rifles will execute order arms from right and left shoulder as described in paragraph 6005.1b. All members of the color guard will halt their movements before executing the last count. The senior color bearer will then command "**Ready, CUT,**" at which time all members of the color guard will return their left hands smartly to their sides and color guards will assume order arms. (See figure 6-11e.)



a. Removing the Ferrule



b. Begin Lowering the Staff



c. Staff 2 in above deck. Re-grip with Left Hand



d. Trimming the Colors



e. All Movement Halted



f. Movement Complete

Figure 6-11 Order Colors from Carry Colors

6009. PRESENT COLORS FROM ORDER COLORS

1. To change from order colors to present colors the command is **"Present, COLORS (ARMS)."** Execution is begun on the preparatory command.
2. At the command **"Present,"** both color bearers change the grip on the staff in the same manner as for carry colors. **The national color bearer executes the movement to carry colors.** (See figure 6-12 a.)
3. At the command **"COLORS,"** organizational color bearer executes the movement to carry colors. The color guards execute present arms. (See figure 6-12.)
4. On the senior color bearer's command **"Ready, CUT,"** only the color bearers will move their left hands smartly to their sides.
5. Once the color guard is at present colors, and when appropriate, the organizational color bearer will render a salute with the organizational colors by straightening the right arm and lowering the staff naturally to the front. The staff will rotate naturally as it goes forward causing the sharp edge of the spearhead to face down. If carrying the 9 ½ foot pole, the cutting edge of the battle-ax shall face forward. (See figure 6-4.)
6. Salutes by the organizational colors are not automatic when presenting colors. They will be rendered only during honors to national colors, to the commander of the organization represented by the colors or to an individual senior in rank to the organizational commander. (e.g., during a parade or review when the adjutant presents the command to the commander of troops, the organizational colors do not salute, unless the commander of troops is the organizational commander or of higher rank.)
7. When musical honors are played, the organizational colors will salute on the first note of music. The colors will be returned to the vertical position following the last note of music or the last volley of a gun salute. If no music is to be played and a color salute is appropriate, the organizational colors will salute immediately after the color guard has gone to present colors.
8. When marching, the salute is rendered when 6 paces from the reviewing stand or person to be saluted. Carry colors is resumed when 6 paces beyond the reviewing stand or person to be saluted.



Figure 6-12 a. Start Present Colors from Order Colors



Figure 6-12 b. Salutes by the Organizational Colors

6010. ORDER COLORS FROM PRESENT COLORS

1. When changing from present colors to order colors, the command is **"Order, COLORS (ARMS)."**

2. At the command **"Order,"** if the organizational colors are still saluting, it will be brought back to the vertical position with the flat side of the spearhead facing the front. The color bearers then grip the staff with the left hand above the ferrule and remove the staff from the sling socket. The staff remains centered on the body with the ferrule just forward of the sling socket. (See figure 6-11a DM-88A.)

3. At the command **"COLORS,"** all colors are brought to the position of order colors. (figures 6-11a thru 6-11d DM-88A). Color guards execute order arms from the shoulder as described in para 6005.1a. Colors are trimmed, if necessary, and the command **"Ready, CUT"** is given in the same manner as for order colors from carry colors.

6011. PRESENT COLORS FROM CARRY COLORS

1. To change from carry colors to present colors, the command is **"Present, COLORS (ARMS)."**

2. At the command of execution **"COLORS,"** the color guards execute present from the shoulder. (See figure 6-7 a-e.)

3. The national color bearer remains at carry colors.

4. The organizational color will salute if appropriate.

6012. CARRY COLORS FROM PRESENT COLORS

1. To change from present colors to carry colors, the command is **"Carry, COLORS."**

2. At the command **"Carry,"** if the organizational colors are saluting, it will be brought back to the vertical position with the flat side of the spearhead facing the front.

3. At the command **"COLORS,"** color guards return to the shoulder as described in paragraph 6005. Before executing the last count, the color guards will await the senior color bearers command "Ready, CUT."

6013. RESTS WITH THE COLORS

1. The color guard assumes the parade rest position in lieu of at ease or rest. At ease or rest are not used by the color guard when carrying uncased colors. Only the senior color bearer or person in charge of a formation with which colors are posted gives the command from the position of order color. It is executed in one count.

2. At the command **"Parade, REST;" "AT EASE;"** or **"REST,"** all members of the color guard execute parade rest. The color staff will remain along the color bearer's side and will not be thrust forward as with a guidon staff. (See figure 6-13.) The national and organizational colors bearers will grasp the sling socket with their left hand.

ORDER COLORS FORM PRESENT COLORS



a. Removing the Ferrule from Present Arms



b. Begin lowering the Staff from Present Arms
Rifle Bearers begin Three-Count Manual of Arms



c. Trimming the Colors



d. All Movements Halted



e. Movement Complete

Figure 6 – 11 A - ORDER COLORS FROM PRESENT COLORS



a. Front View.

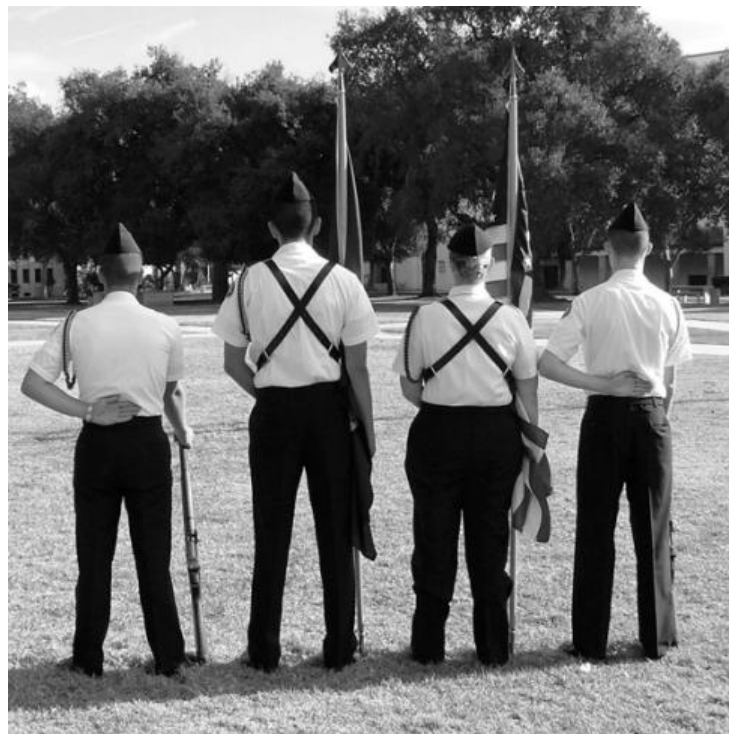

b. Rear View

Fig. 6-13 Color Guard at Parade Rest.

6014. EYES RIGHT (LEFT) FROM CARRY OR ORDER COLORS

1. The command is **"Eyes, RIGHT (LEFT)."** It will be given only when marching at carry colors or while halted at order colors.
2. When halted at order color, at the command **"RIGHT,"** all members of the color guard except the national color bearer turn their head and look 45 degrees to the right. (See figure 6-14 a.) The organizational color cannot salute from order color.
3. When halted at order color, at the command **"LEFT,"** all members of the color guard except the national color bearer turn their head and look 45 degrees to the left. The organizational color cannot salute from order color.
4. When marching at carry color, at the command **"RIGHT,"** all members of the color guard except the national color bearer and the individual on the right turn their head and look 45 degrees to the right. When the reviewing officer of a parade is entitled to a salute by the organizational colors, the salute is executed at the command **"RIGHT."** (See figure 6-14 b.)
5. When marching at carry color, at the command **"LEFT,"** all members of the color guard except the national color bearer and the individual on the extreme left turn their head and look 45 degrees to the left. When the reviewing officer of a parade is entitled to a salute by the organizational colors, the salute is executed at the command **"LEFT."**



Fig. 6-14 a. Eyes Right, Halted.



Fig. 6-14 b. Eyes Right, Marching

6015. CARRY OR ORDER COLORS FROM EYES RIGHT (LEFT)

1. The command is **"Ready, FRONT."**

2. When marching at carry colors, at the senior color bearer's command **"Ready,"** if the organizational colors saluted, it resumes to the carry. At the command **"FRONT,"** all members of the color guard who executed eyes right (left) will return their head and eyes smartly to the front.

3. When at order colors during a review when the reviewing officer troops the line, ready front will not be given after eyes right. During such a ceremony, members of the color guard who executed eyes right, will follow the reviewing officer with their eyes, turning their heads back toward the front as he passes by. Once the reviewing officer is directly in front of them, all movement of the head and eyes is halted.

6016. TRAIL ARMS WITH COLORS

1. When performing indoor ceremonies in a location that the door, ceilings, etc. are not high enough to carry colors in the normal manner, the color colors would be carried at trail.

2. Trail arms is assumed without command on any command that will cause the color guard to move. (e.g., "**Forward, MARCH;**" "**Right Turn, MARCH;**" etc.)

3. Color bearers, on the preparatory command, raise the staff 6 inches off the deck. Color guards assume trail arms.

4. On the command of execution, step off and move a short distance until given the command halt.

NOTE: If necessary to lower the colors to clear a doorway reach across the body with the left hand and grasp the colors. Left forearm is straight and parallel to the deck, the palm to the rear. All colors are tilted forward sufficiently to clear the door or ceiling spearhead flat to the front.

5. When the command to halt is given the colors bearers return the colors to the order and move the left arm back to the left side. Color guards return to the order.

CHAPTER 6

COLOR GUARD

SECTION 4: MOVEMENTS OF THE COLOR GUARD.

6017. FACE THE COLOR GUARD TO THE RIGHT (LEFT)

1. The command is **"Right (Left) Turn, MARCH."** It may be executed while halted, marking time, or marching.

2. On the command **"MARCH,"** with the right (left) flank color guard acting as a stationary pivot, the color guard turns to the right (left) while half stepping until they face the new direction. When making the turn, all members of the color guard face the same direction maintaining their alignment. (See figure 6-16.) Upon completion of the turn, the color guard will be marking time. The senior color bearer must immediately give the next appropriate command, such as **"Forward, MARCH"** or **"Colors, HALT."**

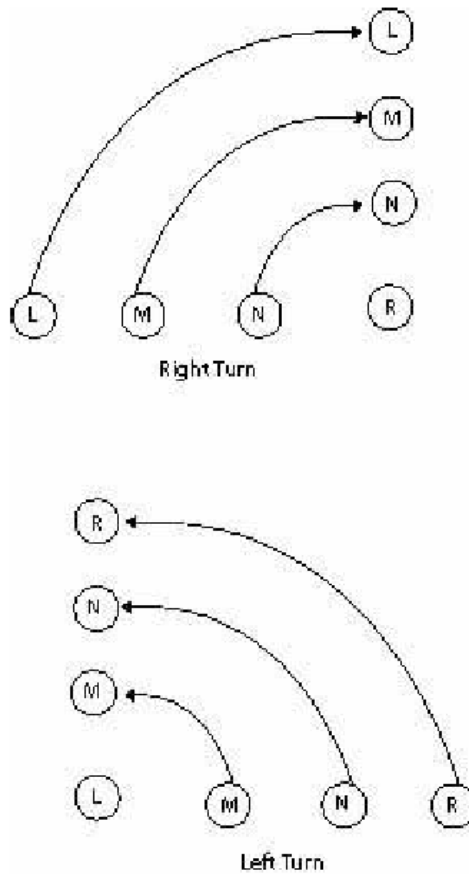

Figure 6-15

6018. FACE THE COLOR GUARD TO THE REAR

1. The command is "**Countermarch, MARCH.**" It may be executed while halted, marking time, or marching. When marking time or marching, the command of execution "**MARCH**" is given as the left foot strikes the deck. When this command is given while marking time or marching, the color guard will take one more 2-inch vertical step in place or one more 30-inch step forward with the right foot before starting the half steps for this movement. If executed from the halt, the color guard will immediately begin the designated steps starting with the left foot.

2. The national color bearer pivots to the left, moving into the position formerly occupied by the organizational color bearer, facing the new direction of march and begins marking time.

3. The organizational color bearer takes one half step forward, pivots to the right outside the national color bearer, moving into the position formerly occupied by the national color bearer, facing the new direction of march and begins marking time.

4. The right color guard takes two half-steps forward, pivots to the left, outside the organizational color bearer, moving into the position formerly occupied by the left color guard, facing the new direction of march and begins marking time.

5. The left color guard takes three half-steps forward, pivots to the right outside the right color guard, moving into the position formerly occupied by the right color guard, facing the new direction of march and begins marking time.

6. Upon completion of this movement, the entire color guard marks time until it is halted or until it receives the command "**Forward, MARCH**" or "**Colors, HALT.**"

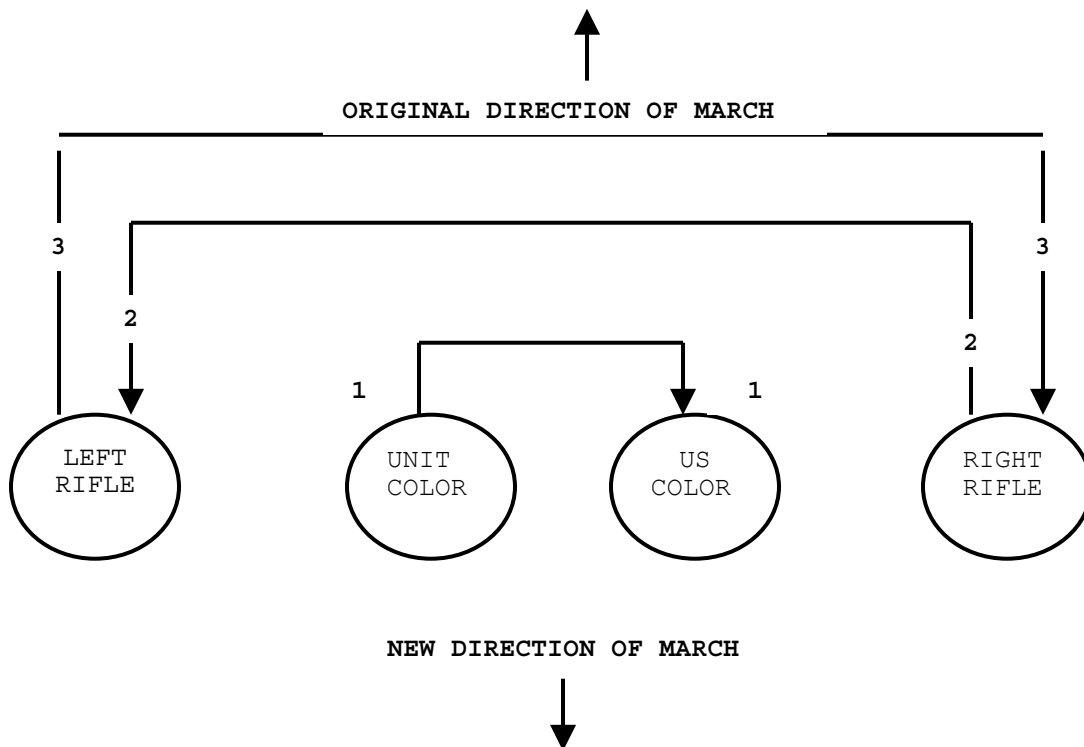

Fig. 6-17

6019. CASING AND UNCASING THE COLORS

1. While it is not a precision movement, casing and uncasing the colors should be accomplished with appropriate dignity and ceremony.

2. To uncasing the colors, the color guard will be formed at carry colors. The supernumerary or other designated individual(s) will center on the color guard. First the national color bearer and then the organizational color bearer will lower their staffs so that the cases may be removed. The individual(s) removing the cases will then step back and salute the national colors before retiring. (See figure 6-19a.)

3. To case the colors, the color guard will be formed at carry colors. The individual(s) with the cases will center on the color guard and salute the national colors. The organizational color bearer followed by the national color bearer will lower their staffs so that their colors may be furled and cased. Rather than wrapping the colors around the staff, the colors should be folded on top of the staffs and held until the cases are slipped on. The rope and tassel and streamers, if any, are kept clear until the colors are folded onto the staff, and then are placed as flat as possible, on the colors. This may require two persons to accomplish. (See figure 6-19 b. and c.) Care should be taken to ensure that color cases fit easily over the colors. Cases constructed with too narrow of a diameter cause undue wrinkling and may even damage the colors.



6-18 a. Uncasing Colors.

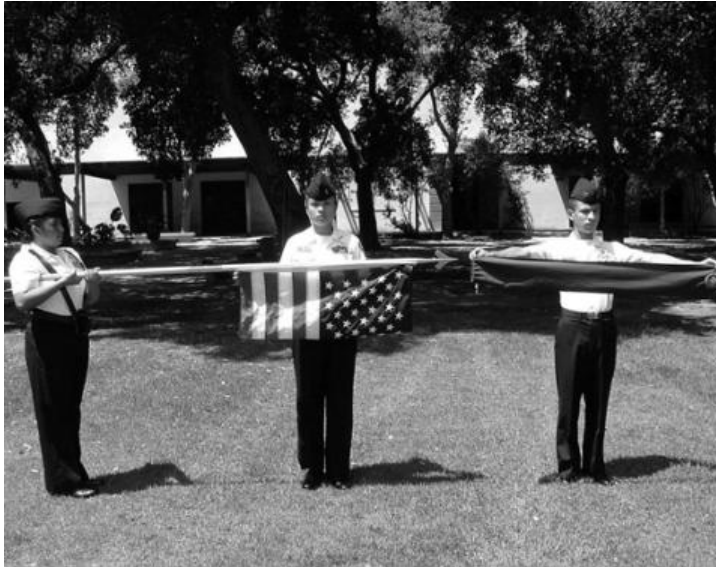

Figure 6-18 b. Casing Colors.



Figure 6-18 c. Casing Colors

6020. INDOOR CEREMONIES INVOLVING COLOR GUARDS

1. On occasion color guards will be required for indoor ceremonies, military or civilian. Normally an indoor ceremony consists of marching on the colors, the "National Anthem," (or pledge of allegiance), posting the colors and retiring the colors. Close coordination with the master of ceremonies, and an on-site rehearsal (if possible) are needed to preclude confusion and misunderstandings during the ceremony.

2. The Normal Sequence of Events Should be as Follows:

a. The master of ceremonies asks the guests to please rise for the march on the colors and to remain standing for the "National Anthem" and the posting of the colors.

b. The color guard marches in from the designated entry and moves to its position, and does a right (left) turn or countermarch to face the audience and remains at the carry. The senior color bearer then gives the command "**Present, COLORS.**" The color guard executes. After the "National Anthem" is played the senior color bearer gives the command "**Carry, COLORS.**" The senior color bearer would then give the commands necessary to move the color guard to 3 paces in front of where the colors are to be posted, halts and gives the command to "**Order, COLORS.**" Once the color guard is at the order, the organizational color bearer then steps to the right oblique and places the organizational colors in the stand. Once the organizational color bearer is back in position the national color bearer steps to the left oblique and places the national colors into the stand. (See figure 6-20.) When the national color bearer is back in position the senior color bearer commands "**Present, ARMS.**" The riflemen execute present arms and the color bearers execute a hand salute. The senior color bearer then commands "**Order, ARMS;**" "**Shoulder, ARMS;**" and then using whatever commands necessary, marches the color guard from the auditorium.

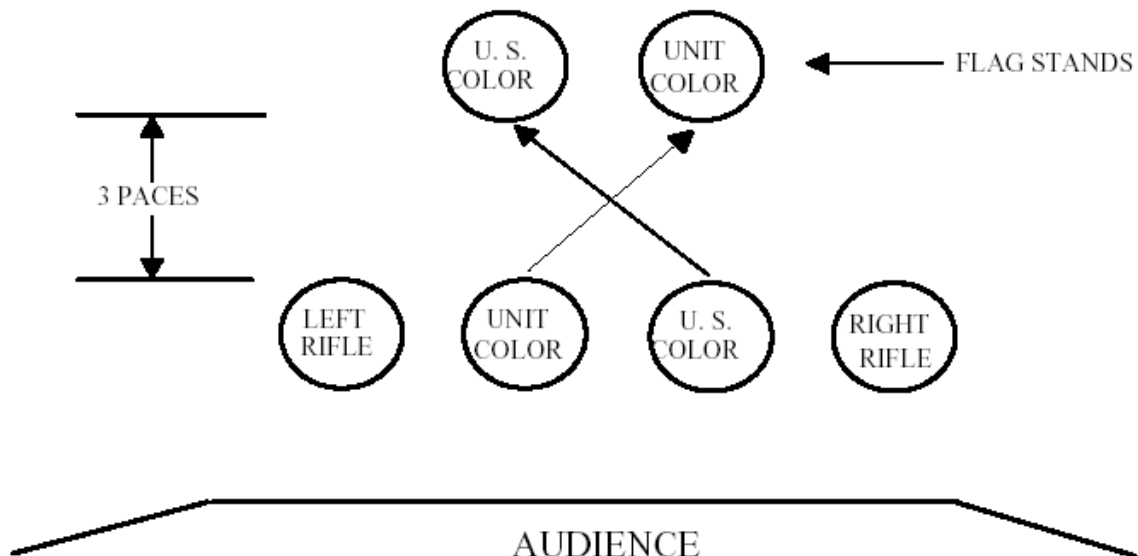

Figure 6-19.--Posting and Retrieving the Colors Indoors

3. When it is time to retire the colors, the color guard assumes its position to re-enter the auditorium for that part of the ceremony.

a. The master of ceremonies would then ask for the guests to rise for the retiring of the colors.

b. The color guard marches to a position 3 paces in front of where the colors are posted, halts and goes to the order. (See figure 6-19.) The senior color bearer then commands "**Present, ARMS,**" the riflemen execute present arms and the color bearers execute a hand salute. The senior color bearer then commands "**Order, ARMS.**" The color guard goes to the order. The national color bearer then steps to the left oblique and retrieves the national colors. When the national color bearer is back in position the organizational color bearer steps to the right oblique and retrieves the organizational colors. When the organizational color bearer is back in position the senior color bearer commands, "**Carry, COLORS**" and then, using whatever commands necessary, marches the color guard from the auditorium.

4. When performing an indoor ceremony, oddities will be encountered that will necessitate some adjustments by the color guard. Some examples are:

a. If performing in a house of worship, covers are not worn and weapons are not carried. Those portions of the ceremony requiring present arms are deleted and the riflemen may be omitted.

b. The ceiling may be too low to carry colors; if so, march in at the trail.

c. The flag stands you will be posting the colors into may be on different sides of the stage. If this occurs, the recommended sequence is:

(1) Execute the ceremony as discussed earlier.

(2) After the "*National Anthem*" the colors countermarch and halt facing the new direction. The senior color bearer would command "**Post the Colors**". The national color bearer and right rifleman step off to the left oblique and move to the flag stand and mark time. The right rifleman positions himself so as to be outboard of the national colors. After the national color bearer and right rifleman have cleared, the organizational color bearer and left rifleman step off in the right oblique and move to the flag stand and mark time. The left rifleman positions himself so as to be outboard of the organizational colors. (See figure 6-20.) Once both colors are in position the senior color bearer commands "**Colors, HALT,**" and "**Order, COLORS.**" The organizational colors is placed in the flag stand, then the national colors is placed in the flag stand. The senior color bearer then commands "**Present, ARMS.**" The riflemen execute present arms and the color bearers execute a hand salute. The senior color bearer then commands

"Order, ARMS;" "Center, FACE;" and "Forward, MARCH." The riflemen march at trail arms. The color guard moves to the center of the stage and marks time, slowly turning left or right towards the audience. The senior color bearer then commands, "Colors, Halt;" "Shoulder, ARMS;" and then marches the color guard from the auditorium.

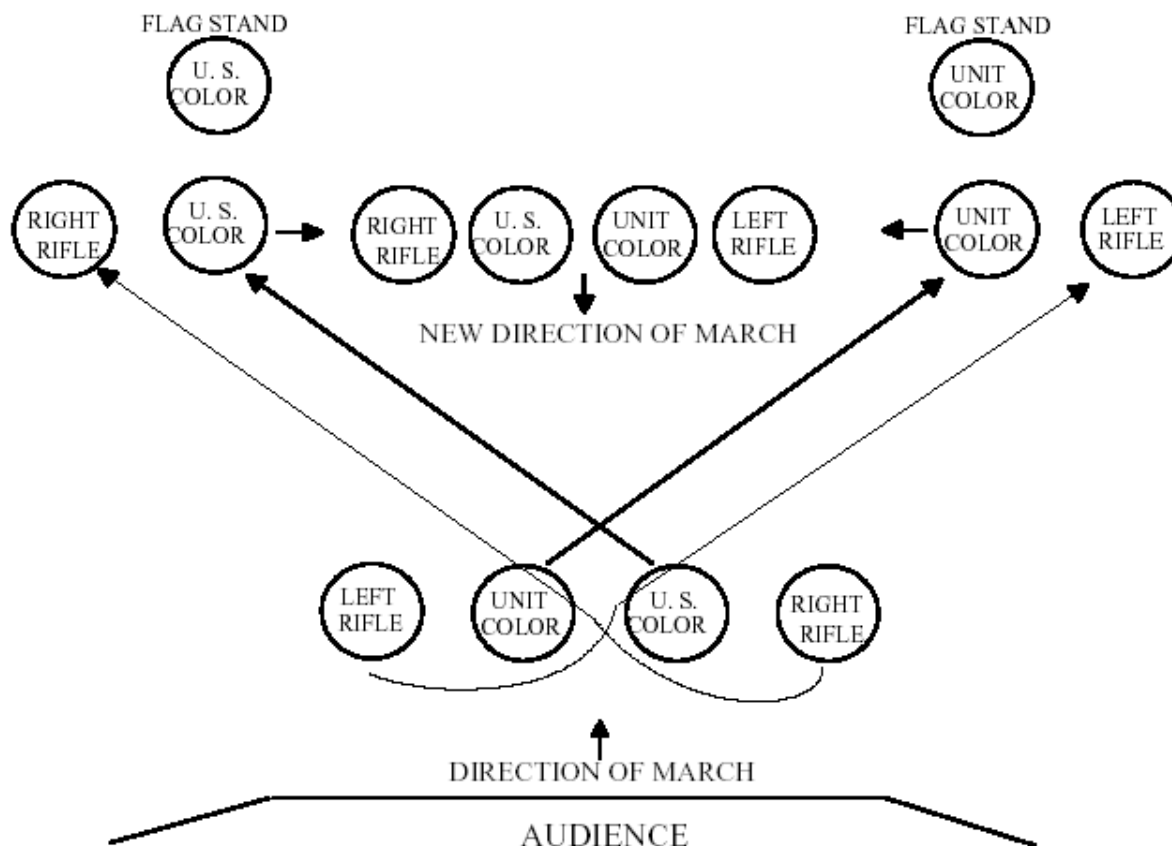

Figure 6-20.--Posting and Retrieving the Colors Indoors (Flag Stands Separated).

(3) To retire the colors from separated flagpoles, the detail is marched into position facing the colors and halts. The senior color bearer then commands "Present, ARMS." The color guard riflemen execute present arms and the color bearers execute a hand salute. The senior color bearer then commands "Shoulder, ARMS." The riflemen return to the shoulder. The national color bearer and right rifleman then step off to the left oblique and move to the flag stand and mark time. The right rifleman positions himself so as to be outboard of the national colors. After the national color bearer and right rifleman have cleared, the organizational color bearer and left rifleman step off in the right oblique and move to the flag stand and mark time. The left rifleman positions himself so as to be outboard of the organizational colors. (See figure 6-10.) Once all are in position the senior color bearer commands "Colors, HALT," and "Order, ARMS." The senior color bearer then retrieves the national colors. The organizational color bearer then retrieves the organizational colors. The senior color bearer then commands "Center, FACE," and "Forward, MARCH." The color guard, at trail arms, moves to the center of the stage and marks time, slowly turning left or right towards the audience. The senior color bearer then commands "Colors, HALT;" "Carry, COLORS;" and then marches the color guard from the auditorium.

d. The rule of thumb for all unusual situations not covered by this Manual is to perform in a military manner. However, never do something that would embarrass the Unit or the United States Navy.

CHAPTER 7

SQUAD DRILL

7000. GENERAL

1. A squad is a group of 8-12 individuals formed for the purpose of instruction, discipline, control, and order.
2. Members of the squad take positions, move, and execute the manual of arms as stated in this Manual. All individuals execute the movements at the same time. Squads may drill as squads or as part of a platoon or larger formation.
3. Squads are kept intact when practicable. The normal formation for a squad is a single rank (squad in line) or single file (squad in column). (See figure 7-1.) This permits variation in the number of individuals composing the squad. The first formation is always in line. Column formation may be taken from line formation. A squad, not at drill, may be marched in column of twos by forming in two ranks.
4. The squad marches in line for minor changes of position only.
5. When the Squad is Armed with Rifles
 - a. The command "**Right (Left) Shoulder, ARMS;**" "**Port, ARMS;**" or "**Sling, ARMS**" is given before commanding the squad to move, except for short distances. When moving short distances the command "**Trail, ARMS**" may be given or it may be executed automatically.
 - b. At the command "**Squad, HALT**" remain at the position of right shoulder (left shoulder, port or sling) arms until "**Order, ARMS**" or some other manual command is given.
6. In this Chapter the term "unit leader," (e.g., "The unit leader then checks the alignment) means the individual drilling the squad. He/she may be the squad leader, or squad member drilling the squad for an inspection or evaluation. If the unit leader is the squad leader, then the number two Cadet (see figure 7-1) executes the movements of the squad leader. The unit leader must maintain proper distance (3 paces) from the squad and remain centered on the squad during all drill movements.
 - a. If the squad executes a right step, the unit leader, who is facing the squad, would execute a left step in cadence with the squad to maintain proper position. For a right step the unit leader would execute a left step.
 - b. If the squad executes a back step, the unit leader would execute a half step, in cadence with the squad to maintain proper position.
 - c. Movements of the unit leader during other squad movements are explained in the paragraph describing the movement.

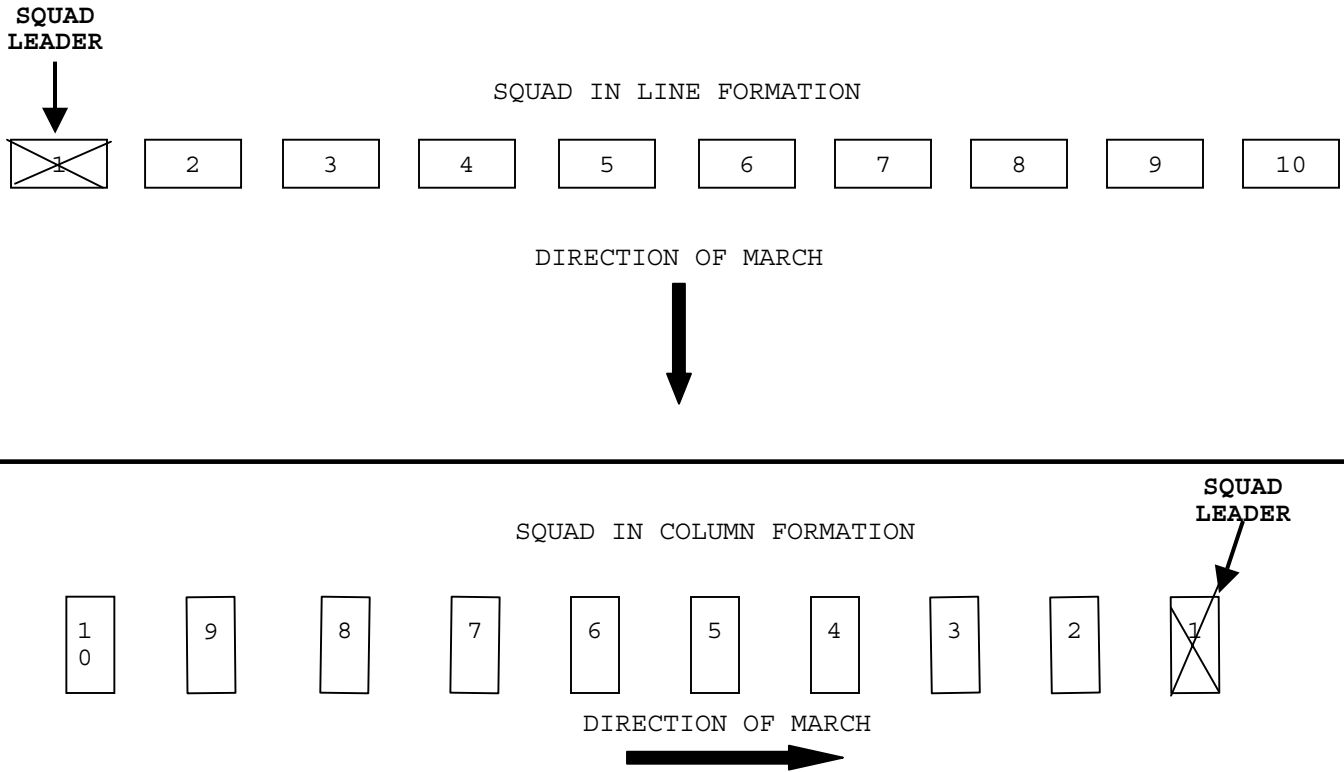

Figure 7-1 Squad Formations

7001 TO FORM THE SQUAD

1. Members of the squad normally form as indicated in figure 7-1 (e.g. to maintain squad integrity.) However, for parades and ceremonies where appearance is more important, the squads should be sized. To size the squad the tallest member takes position 2 in figure 7-1 with the shortest squad member in position 10. The squad leader, regardless of height, always forms as the squad leader, in position one of figure 7-2.



a. Squad Formed with Unit Integrity.



b. Squad Sized

Figure 7-2. Sizing Squads

2. To form at normal interval, the command is "**FALL IN.**"

3. The squad forms in line on the left of the squad leader. Each member of the squad, except the individual on the left flank, raises their left arm shoulder high in line with their body. Fingers are extended and joined, palm down thumb extended along the forefinger. Each individual except the squad leader turns their head and looks to the right. To obtain a normal interval, everyone places himself in line so their right shoulder touches the fingertips of the person on their right. As soon as each individual is in line with the person on their right, and the person on their left has obtained normal interval, they assume the position of attention smartly but quietly.

4. To form at close interval, the command is "**At Close Interval, FALL IN.**"

5. The squad forms in line on the left of the squad leader. Each member of the squad, except the individual on the left flank, places their left hand on their hip, elbow in line with the body. They rest the heel of the palm on the hip with fingers extended and joined and pointing down. Everyone except the squad leader turns their head and looks to the right. To obtain close interval, they place themselves in line so their right arm touches the elbow of the person on their right. As soon as each individual is in line with the person on their right, and the person on their left has obtained close interval, they assume the position of attention smartly but quietly.

6. If the squad is armed, members fall in with weapons at the position of order arms. Weapons are inspected at once unless a report is to be taken. If so they will be inspected immediately following the report with the following commands: "**Inspection, ARMS;**" "**Port, ARMS;**" and "**Order, ARMS.**" (See paragraph 3011.)

7002. TO DISMISS THE SQUAD

1. The squad is dismissed only from a line with individuals at attention.

2. Armed troops are dismissed with the commands "**Inspection, ARMS;**" and "**DISMISSED**" (See paragraph 3011).

3. Unarmed troops are dismissed with the command "**DISMISSED.**"

7003. TO COUNT OFF

1. In line, the command is "**Count, OFF.**" At the command "**OFF,**" everyone except the squad leader, turn their heads 90 degrees over the shoulder and look to the right. The squad leaders shout ONE. The person in the file to the left of the squad leaders turns his/her head smartly back to the front and at the same time shouts TWO. After the person to their right has shouted their number, each subsequent person to the left turns his/her head back to the front and at the same time shouts the next higher number. Numbers are counted off in quick time cadence.

2. In column, on the command "**From Front to Rear, Count, OFF,**" the squad leader smartly turns his/her head to the right 90 degrees over the shoulder and shouts ONE as the head is turned back to the front. Each subsequent rank, having seen the person's head in front of them return to the front, turns his/her head to the right and shouts the next higher number as the head is turned smartly back to the front. This is carried on in sequence at quick time cadence.

7004. TO ALIGN THE SQUAD

1. The purpose of these movements is to dress the alignment of the squad. They may be executed when the squad is halted at attention in line. The commands are "**Dress Right (Left), DRESS**" or "**At Close Interval, Dress Right (Left), DRESS.**" These commands are given only when the squad is at approximately the same interval as the interval at which the dress is commanded.

2. Dress Right Dress

a. On the command "**Dress Right, DRESS,**" everyone except the squad leader, smartly turn their heads to the right, 90 degrees over the shoulder look, and align themselves. At the same time, everyone except the individual on the left flank, provide interval by smartly raising their left arm to shoulder height and in line with their body. Fingers are extended and joined, thumb along the forefinger, palm down. (See figure 7-3.)

b. As the base of the movement, the squad leader keeps his/her head and eyes to the front. All other members of the squad position themselves by short steps until their right shoulders lightly touch the fingertips of the person on their right.

c. The unit leader, on his/her own command of execution "**DRESS,**" faces half left, as in marching, and proceeds by the most direct route to a position on line with and one pace to the right of the individual on the right flank. At this position, the unit leader executes a halt in the oblique facing the rear of the formation, and then executes a right face, facing down the line of the squad. The unit leader aligns the squad by commanding those individuals in advance or rear of the line to move forward or backward until in line. These individuals are designated by name or number. For example: "**Jones, FORWARD;**" or "**Number Three, BACKWARD.**" Those individuals will move until receiving the command "**STEADY.**" The unit leader may execute a series of short side steps to the right or left in order to identify an individual. However, prior to commanding the identified individual to move, the unit leader will be on line with the rank. After verifying the alignment of the squad, the unit leader faces to the right in marching, marches straight to a point 3 paces beyond the squad, halts, faces to the left, and commands "**Ready, FRONT.**" Immediately after commanding "**FRONT,**" the unit leader marches by the most direct route back to a post 3 paces front and centered on the squad.

d. On the command "**Ready, FRONT,**" all members of the squad who raised their left arm and turned their head to the right, will smartly but quietly lower their arm to their side and at the same time turn their head back to the front, assuming the position of attention.

e. When aligning a squad of well-drilled troops or when there is insufficient time to verify alignment, the unit leader may command "**Ready, FRONT**" from his/her normal position (3 paces front and centered), without having verified alignment.



Figure 7-3. Dress Right Dress.

3. At Close Interval Dress Right Dress. This movement is executed in the same manner as dress right dress except for the following:

a. On the command "**At Close Interval, Dress Right, DRESS,**" those individuals providing interval will do so by placing the heel of their left hand on their hip with the elbow in line with their body. Fingers are extended and joined and pointing down. Members gaining interval will move by short steps until their right arm is touching the left elbow of the individual to their left. (See figure 7-4.)



Figure 7-4. At Close Interval Dress Right Dress.

4. Dress Left Dress and at Close Interval Dress Left Dress. These movements are similar to dress right dress and at close interval dress right dress except that alignment is made toward the left. The individual on the left flank of the rank is the base of the movement and stands fast. On the command "**Dress Left, DRESS**" or "**At Close Interval, Dress Left, DRESS,**" everyone except the individual on the left flank smartly turn their heads to the left, look, and align themselves. At the same time they will smartly raise their left arm or elbow to provide interval (the left arm is used for both dress right and dress left). The unit leader will verify alignment of the squad from its left flank. (See figure 7-5.)



Figure 7-5. Dress Left.

5. To align in column, the command is "**COVER.**" At this command, members move as necessary to place themselves directly behind the person in front of them, still maintaining a 40-inch distance.

7005. TO OBTAIN CLOSE INTERVAL FROM NORMAL INTERVAL IN LINE

1. The purpose of this movement is to close the interval between individuals of a squad in line to 4 inches. It may be executed when the squad is halted at attention and in line at normal interval. The command is "**Close, MARCH.**"

2. The squad leader is the base of this movement. On the command of execution "**MARCH,**" the squad leader stands fast and places his/her left hand on his/her hip, as if dressing at close interval, to provide interval for the individuals to the left. At the same time, all other members of the squad face to the right as in marching, march toward the right flank until approximately 4 inches from the person in front of them, halt, and face to the left. They then execute at close interval dress right dress. After aligning and without command, they will smartly lower their left hands and turn their heads to the front as soon as the individual to their left has touched their elbow with his/her right arm and stopped moving.

3. On his/her command of execution, the unit leader steps to the left in marching. He/she marches parallel to the squad maintaining a distance of 3 paces from the squad. When approximately on the center of the squad at close interval the unit leader halts and faces the squad. He/she then adjusts to the center of the squad by taking small steps left, right, forward or back.

7006. TO OBTAIN NORMAL INTERVAL FROM CLOSE INTERVAL IN LINE

1. The purpose of this movement is to extend the interval between individuals of a squad in line to one arm length. It may be executed when the squad is halted at attention and in line at close interval. The command is **"Extend, MARCH."**
2. The squad leader is the base of this movement. On the command of execution **"MARCH,"** the squad leader stands fast and raises his/her left arm to shoulder height to provide interval for the person on the left. At the same time, all other members of the squad face to the left as in marching, march toward the left flank until they have opened approximately a 30-inch distance from the person behind them, halt, and face to the right. They then execute dress right dress. After aligning and without command, they will smartly, and quietly, lower their left arms and turn their heads to the front as soon as the individual to their left has touched their finger tips with his/her right shoulder and has stopped moving.
3. On his/her command of execution, the unit leader steps to the right in marching. He/she marches parallel to the squad maintaining a distance of 3 paces from the squad. When approximately on the center of the squad at normal interval the unit leader halts and faces the squad. He/she then adjusts to the center of the squad by taking small steps left, right, forward or back.

7007. TO MARCH IN THE OBLIQUE

1. The purpose of this movement is to shift the line of march to the right or left and then resume marching in the original direction. It may be executed from any formation that is marching at quick time cadence. The command is **"Right (Left) Oblique, MARCH."** The word oblique is pronounced to rhyme with strike. The command of execution is given as the foot in the direction of the turn strikes the deck. The command to resume the original direction of march is **"Forward, MARCH."** The command of execution is given as the foot toward the original front strikes the deck.
2. To teach the squad to march to the oblique, the unit leader aligns the unit and has members face half right (left). The unit leader then explains that these positions are maintained when marching to the oblique. This is achieved by individuals keeping their shoulders parallel to the persons in front and/or adjacent to them. The squad leader is the base of the movement, and must maintain a steady line of march keeping his/her shoulders blocked perpendicular to the direction of march.
3. At the command **"Right Oblique, MARCH"** the command of execution is given as the right foot strikes the deck. Everyone then takes one more 30-inch step to the front with the left foot and pivots 45 degrees to the right on the ball of the left foot. Stepping out of the pivot with a 30-inch step, the entire squad marches to the right oblique until given another command. (See figure 7-6.) For the squad to resume marching in the original direction, the command is **"Forward, MARCH"** in this case the command of execution will be given as the left foot strikes the deck. Everyone then takes one more step in the oblique direction; pivots back to the original front and continue to march. To march to the left oblique, substitute left for right and right for left in the above sequence.

RIGHT OBLIQUE

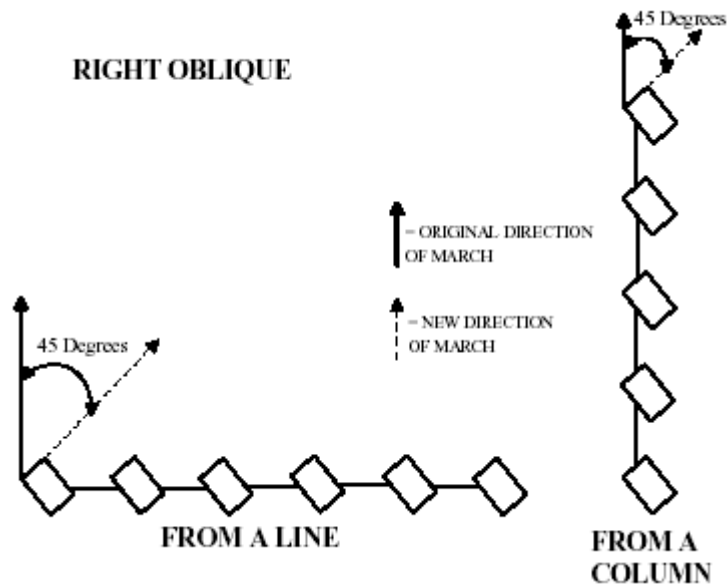

Figure 7-6. Marching to Right Oblique.

4. To halt the squad facing in the original direction of march the command is **"Squad, HALT."** The command of execution **"HALT"** is given on the left foot when marching to the right oblique and on the right foot when marching to the left oblique. At the command **"HALT,"** everyone takes one more step in the oblique direction, pivots to the original front on the toe of the right (left) foot, and places the left (right) foot beside the other at the position of attention.

5. To temporarily halt the squad in the oblique direction, in order to correct errors, the command is **"In Place, HALT."** The command of execution **"HALT"** may be given as either foot strikes the deck. At the command of execution **"HALT,"** the squad halts in two counts as in quick time and remains facing in the oblique direction. The only command that can be given after halting in place is **"Resume, MARCH."** At that command, the movement continues marching in the oblique direction.

6. When given half step or mark time while marching in the oblique, the only commands that may be given are **"Resume, MARCH"** to continue marching with a 30-inch step in the oblique; or **"In Place, HALT"** to halt in the oblique in order to correct errors.

7008. TO MARCH TO THE REAR

1. The purpose of this movement is to march the squad to the rear for a short distance. It may be executed when halted or marching forward at quick time or double time. The command is **"To the Rear, MARCH."** The command of execution will be given as the right foot strikes the deck.

2. When halted, on the command of execution **"MARCH,"** everyone takes one 15-inch step to the front with the left foot and then pivots 180 degrees toward the right on the balls of both feet. Stepping out of the pivot with a 30-inch step, the entire squad marches to the rear. For the squad to resume marching in the original direction the command **"To the Rear, MARCH"** is given again. No other command may be given when marching to the rear until the unit has resumed marching to the original front.

3. When marching at quick time, on the command of execution **"MARCH,"** everyone takes one 15 inch step to the front with the left foot and then pivots 180 degrees toward the right on the balls of both feet. Stepping out of the pivot with a 30-inch step, the entire squad marches to the rear. For the squad to resume marching in the original direction, the command **"To the Rear, MARCH"** is

given again. No other command may be given when marching to the rear until the unit has resumed marching to the original front.

4. When marching at double-time, on the command of execution "**MARCH,**" everyone takes two more 36-inch steps to the front and then four, 6-inch vertical steps in place at double time cadence. On the first and third steps in place, everyone pivots 180 degrees to the right, 90 degrees on the first step and 90 degrees on the third. After the fourth step in place, and for the fifth step, they step off with a 36-inch step in the new direction. For the squad to resume marching in the original direction, the command "**To the Rear, MARCH**" is given again. No other command may be given when marching to the rear until the unit has resumed marching to the original front.

7009. TO MARCH TO THE FLANK

1. The purpose of this movement is to march the squad to the right or left flank for a short distance. It may be executed from any formation that is marching at quick time or double time cadence. The command is "**By the Right (Left) Flank, MARCH.**" The command of execution is given as the foot in the direction of the turn strikes the deck.

2. To march to the right flank, when marching at quick time, the command is "**By the Right Flank, MARCH.**" On the command of execution "**MARCH,**" everyone takes one more 30-inch step to the front with the left foot and then pivots 90 degrees to the right on the ball of the left foot. Stepping out of the pivot with a 30-inch step, the entire squad marches in line to the right flank. The unit leader executes the flanking movement with the squad maintaining his/her distance from the squad. For the squad to resume marching in the original direction, the command is "**By the Left Flank, MARCH.**" To march to the left flank, substitute left for right and right for left in the above sequence. No other command may be given when marching to the flank until the unit has resumed marching to the original front.

3. When marching at double time, on the command of execution "**MARCH,**" everyone takes two more 36-inch steps to the front and then two, 6-inch vertical steps in place at double time cadence. While stepping in place, everyone turns 90 degrees toward the direction commanded and then steps off with a 36-inch step in the new direction. No other command may be given when marching to the flank until the unit has resumed marching to the original front.

7010. TO CHANGE DIRECTION OF A COLUMN

1. The purpose of this movement is to change the direction of march of a column. It may be executed when the squad is halted or marching in column. The command is "**Column Right (Column Left, Column Half Right, or Column Half Left), MARCH.**" The squad leader establishes the pivot point for the movement.

2. When marching, the commands of execution are given on the foot in the direction of the turn. On the command of execution "**MARCH,**" the squad leader takes one more 30-inch step to the front and then pivots 90 degrees to the right (left) on the ball of the left (right) foot. He/she then takes a 30-inch step in the new direction. The remaining members of the squad continue to march to the point where the squad leader pivoted. They would then pivot 90 degrees in the new direction of march.

3. When halted, at the command of execution "**MARCH,**" the squad leader faces to the right (left) as in marching by turning to the right (left) on his right toe and takes one 30-inch step in the new direction with the left foot. The remaining members of the squad step off to the front as in forward march. The remainder of the movement is executed the same as in marching.

4. Column half right (left) is executed as described above except that the pivot is 45 degrees to the right (left).

5. During column movements, the unit leader executes the movement with the squad, maintaining proper distance from the squad.

6. For slight changes of direction, the command is "INCLINE TO THE RIGHT (LEFT)." At that command, the squad leader changes direction slightly as commanded. This is not a precision movement and is executed only while marching.

CHAPTER 8

PLATOON DRILL

8000. GENERAL

1. The first phase of drill has been explained in earlier chapters of this Manual. This Chapter discusses the next phase, platoon drill. In platoon drill, the squad is merged with other squads into a platoon.
2. A platoon consists of a platoon headquarters and two or more squads. Platoon headquarters consists at a minimum of a platoon commander, a mustering petty officer and a platoon guide. One or more assistants may be designated.
3. Squads in a platoon are numbered from right to left in column (when facing the front of the column) and from front to rear in line.
4. The platoon forms in two or more ranks with a 40-inch distance between ranks. Movements in this Section are described for columns of threes or fours and may be executed by either formation.
5. The platoon changes interval while in line and counts off in the same manner as the squad. Squad leaders are the base for these movements. The guide moves to the right when interval is taken to the left, and does not count off.
6. In platoon drill, if all members of the platoon are to execute a movement simultaneously, the movement is executed on the command of the platoon commander. In this case, squad leaders do not repeat or give any commands. When squads of the platoon are to execute a movement in successive order, such as forming column of twos (files) and reforming into column (of threes, etc.), squad leaders give appropriate supplemental commands for the movement of their squads.
7. Unless specified for the platoon to be at close interval, all changes in formation should be executed with normal interval and distance between files and ranks.
8. The unit leader will march to the left and parallel to the platoon, from a position where he/she can best control the unit.
9. All commands given by the unit leader while the platoon is halted will be 6 paces in front of the unit and centered on the element.
10. In confined arenas Unit Leaders are permitted to march three paces centered on the left side of the unit where they can best control the unit.

8001. FORMATIONS

1. Column and line are the two formations for a platoon. (See figures 8-1 and 8-2.)

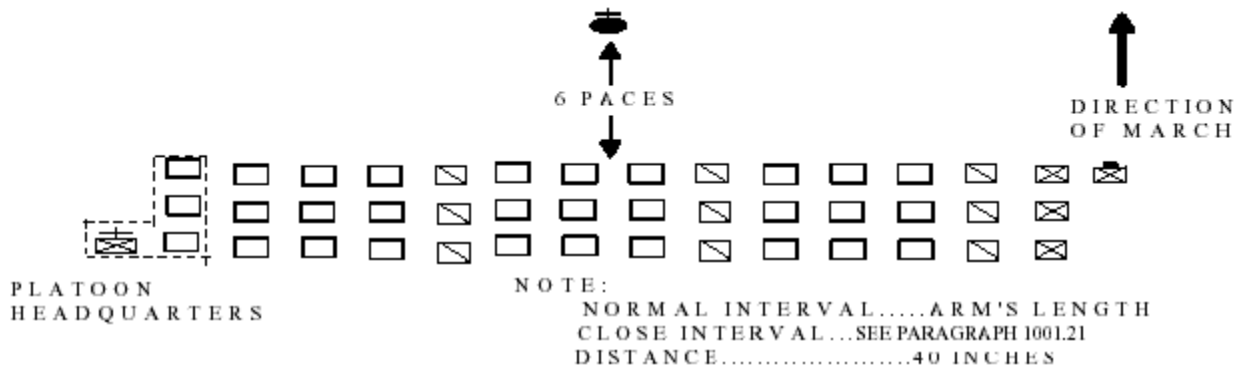

Figure 8-1. Platoon in Line at Normal Interval.

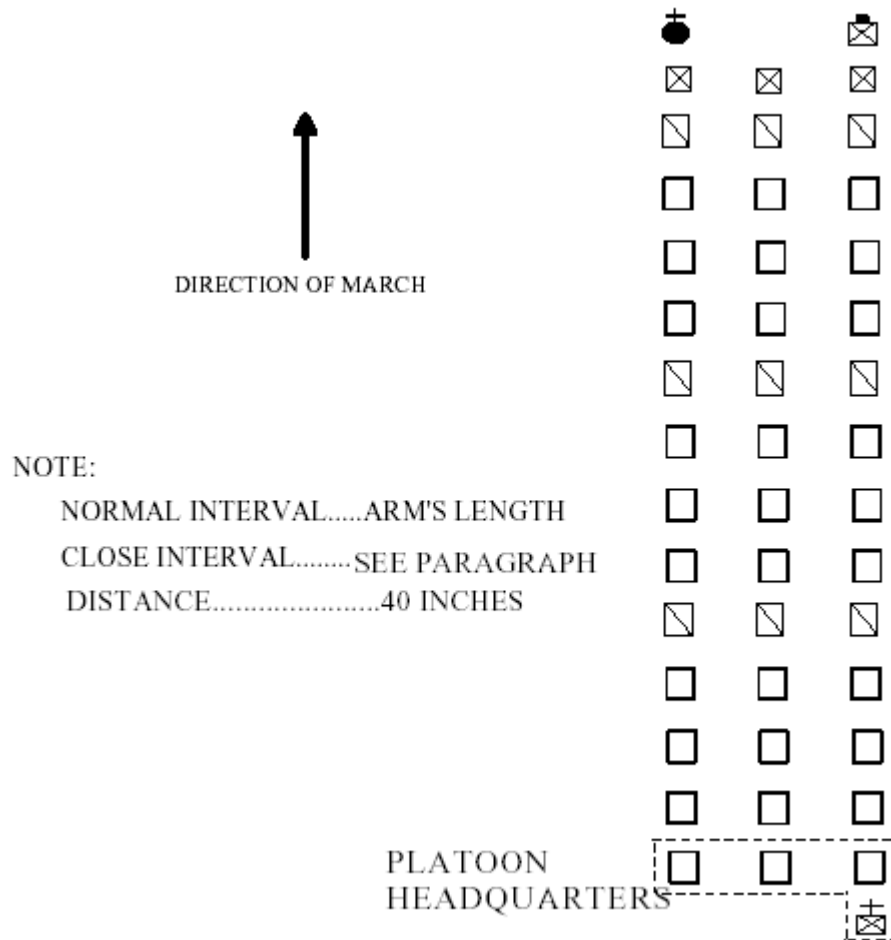

Figure 8-2. Platoon in Column at Normal Interval.

2. The platoon normally forms in line with the squad leaders on the right of their squads and the guide on the right of the first squad leader. (See figure 8-1.) The platoon marches in line for short distances only. The platoon is normally marched in column with the squad leaders in front of their squads and the guide in front of the third (right) squad leader. The unit leader takes a position in front of the 1st squad during parade and ceremony. (See figure 8-2.)

8002. POSTS OF INDIVIDUALS

1. In line, the platoon commander's post is 6 paces in front of the center of the front rank of the platoon. (See figure 8-1.) In column, the platoon commander marches at the head of the left file of the platoon (see figure 8-2), unless drilling the platoon, in which case he/she would maintain a position 6 paces from the platoon.

2. When the platoon commander is present, the mustering petty officer takes post to the left of the left member of the rear rank when the platoon is in line. When in column, the mustering petty officer follows the last member of the right file (squad). When the platoon commander is not present, the mustering petty officer takes the platoon commander's post and drills the platoon in the manner prescribed for the platoon commander.

3. The platoon guide takes post as stated in paragraph 8003.

4. Extra members may fall in on the left when the platoon is in line and in the rear when in column. If the squads are evenly filled, the first extra member falls in with the first squad, the second with the third (fourth) squad and then remaining squads. The mustering petty officer will reposition when necessary so as to remain the last person in the last rank.

5. In this Chapter the term "platoon commander," e.g., the platoon commander then checks the alignment, means the individual drilling the platoon. He/she may be the platoon leader, mustering petty officer, or platoon member drilling the platoon for an inspection or evaluation. Except when marching at the head of a platoon column, the platoon commander must maintain proper distance (6 paces) from the platoon and remain centered on the platoon during all drill movements.

a. If the platoon were executing a right step, the platoon commander, who is facing the platoon, would execute a left step in cadence with the platoon in order to maintain proper position. For a left step the platoon commander would execute a right step.

b. If the platoon were executing a back step, the platoon commander would execute a half step, in cadence with the platoon in order to maintain proper position.

c. Movements of the platoon commander during other platoon movements are explained in the paragraph describing the movement.

8003. RULES FOR THE GUIDE

1. Unless otherwise directed, guide is right and the platoon guide takes post on the right. In line, the guide is posted to the right of the squad leader of the first squad. In column, the guide is posted in front of the squad leader of the third or right squad.

2. In column, when it is desired to guide left or center, the command "**GUIDE LEFT**" is given. At this command, the guide and the platoon commander exchange positions. The guide crosses between the platoon commander and the platoon. To return the guide to normal position, "**GUIDE RIGHT**" is commanded. The guide and platoon commander return to their normal positions with the guide again passing between the platoon commander and the platoon. This movement may be made at a halt or while marching. The base squad or file is the one behind the guide.

3. The guide does not change position at the command "**Dress Left, DRESS.**"

4. When a platoon in line is given the command "**Right, FACE,**" the platoon guide executes right face with the platoon. The guide then steps to the right in marching, moves to a position in front of the right squad leader, halts, and executes left face. If a platoon in line is given "**Left, FACE,**" the guide executes left face with the platoon but does not change position within the platoon.

5. When a platoon in column is given the command "**Column of Files from the Left,**" the guide takes position in front of the left squad leader so as to remain at the head of the column.
6. When a platoon in column is given the command "**Column of Twos from the Left,**" the guide takes position in front of the second squad so as to remain at the head of the right file of the column. These movements are executed by facing left as in marching, moving to the appropriate position, halting, and facing right.
7. When reforming in a column of threes or fours from a column of files or twos, the guide takes post at his normal position when the movement is completed.
8. The guide sets the direction and cadence of the march. The leading member of each file is responsible for interval.
9. When a platoon is marching in column and the command "**By the Right (Left) Flank, MARCH**" or "**To the Rear, MARCH**" is given, the guide executes the movement with the platoon but does not change relative position except during specific movements of company drill. (See paragraph 10011.2 in the Marine Corps Drill and Ceremonies Manual--MCO P 5060.20 for an exception.)
10. The guide does not count off.

8004. TO FORM THE PLATOON

1. The platoon forms in line at normal interval and distance between files and ranks (see figure 8-1) on the command "**FALL IN.**" To form at close interval, the command is "**At Close Interval, FALL IN,**" in which case the platoon forms in line with normal distance between ranks, but with close interval between files. The mustering petty officer or platoon commander forms the platoon as described below.

2. Forming the Platoon by the Mustering petty officer

a. The mustering petty officer takes post 3 paces in front of the point where the center of the platoon will be, faces that point, draws sword if so armed, and commands either "**FALL IN**" or "**At Close Interval, FALL IN.**" At this command, the guide takes post so that the first rank, when aligned on the guide will be centered on and 3 paces from the mustering petty officer. The squad leader of the first squad falls in to the left of the guide and aligns at normal or close interval. Other squad leaders fall in directly behind the squad leader of the first squad with 40 inches distance between them. The members of the squads fall in and align on their squad leaders at normal or close interval as prescribed in squad drill, except that exact interval is measured only by the front rank. Individuals in the rear ranks gain their interval by covering the corresponding member of the rank in front of them. All personnel fall in at attention and, if armed with the rifle, at the position of order arms.

b. When a report is appropriate, after all personnel are formed, the mustering petty officer commands, "**REPORT.**" Remaining in position (at order arms if armed with the rifle), the squad leaders, in sequence from front to rear, salute and report, "All present" or "(Rank and Name) absent." If the cadets are armed, the mustering petty officer commands, "**Inspection, ARMS;**" and "**Order, ARMS**" paragraph 3011). The mustering petty officer then executes about face.

NOTE: If the platoon cannot be formed in regularly organized squads prior to forming the platoon, the mustering petty officer commands "**Inspection, ARMS;**" "**Right Shoulder, ARMS;**" and calls the roll. Each cadet answers "here," and goes to order arms as their name is called. The mustering petty officer then organizes the platoon into squads and faces the front. (The manual of arms is omitted for personnel not armed with rifles.)

c. To receive the platoon, the platoon commander takes post 3 paces in front of the mustering petty officer (sword in scabbard if so armed), the mustering petty officer salutes and reports, "Sir (Ma'am), all present or accounted for" or "Sir (Ma'am), (number) absent." The platoon commander returns the salute and may discuss absentees and issue necessary instructions to the mustering petty officer. The platoon commander then commands the mustering petty officer, "**TAKE YOUR POST.**" The mustering petty officer marches by the most direct route to a

post on the left of the rear rank. The platoon commander then draws sword, if so armed.

d. If the platoon commander does not receive the platoon, the mustering petty officer takes 3 paces forward, faces about and assumes the post and duties of the platoon commander.

3. Forming the Platoon by the Platoon Commander

a. When appropriate, the platoon may be formed by the platoon commander rather than the mustering petty officer. The procedures are the same except that the platoon commander takes post 6 paces in front of the point where the center of the platoon will be, faces that point, draws sword and commands "**FALL IN**" or "**At Close Interval, FALL IN.**"

b. The platoon forms on the platoon commander, the mustering petty officer falling in on the left of the rear rank with sword drawn, if so armed. The platoon commander then receives the report from the squad leaders and causes the platoon to execute inspection arms if the troops are armed.

8005. TO DISMISS THE PLATOON

1. The platoon is dismissed only from in line while at attention.
2. Armed troops are dismissed with the commands "**Inspection, ARMS;**" and "**DISMISSED.**"
3. Unarmed troops are dismissed with the command "**DISMISSED.**"
4. The mustering petty officer usually dismisses the platoon.

8006. COUNT OFF

1. The purpose of this movement is to designate the relative position in ranks of each member of the platoon. It may be executed when the platoon is halted at attention in line or column. When in line the command is "**Count, OFF;**" when in column the command is "**From Front to Rear, Count, OFF.**"
2. In line, on the command "**Count, OFF,**" everyone except the guide and squad leaders turn their heads 90 degrees to the right and look to the right. The squad leaders shout ONE. The persons in the file to the left of the squad leaders turn their heads smartly back to the front and at the same time shout TWO. After the file to their right has shouted its number, each subsequent file to the left turn their heads back to the front and shouts the next higher number. Numbers are counted off in quick time cadence.
3. In column, on the command "**From Front to Rear, Count, OFF,**" the squad leaders smartly turn their heads to the right and shout ONE as they return their heads back to the front. Each subsequent rank, having seen the heads in front of them return to the front, turn their heads to the right and shout the next higher number as they bring their heads smartly back to the front. This is carried on in sequence at quick time cadence. The guide does not turn his/her head nor count off. The platoon commander gives the command from a position 6 paces in front and centered on the squad leaders.

8007. TO FORM COLUMN FROM LINE. The purpose of this movement is to change the formation from line to column. It may be executed only when halted at normal interval, at attention, and at order arms if armed with rifles. The command is "**Right, FACE.**" On the command of execution "**FACE,**" all members of the platoon face to the right, thereby forming column. The guide moves to his/her position in front of the right squad leader. The platoon commander may then command any halted movement from his/her current position, (e.g., right/left shoulder, port, sling, arms; facing movements, right/left step; etc.) unless otherwise indicated in this Chapter. If the platoon is to march as part of a larger formation the platoon commander takes post in front of the left file and the guide in front of the right file. (See figure 8-2.) From this position the platoon commander would

command **"Forward (Column Right {Left}), MARCH"** to cause the platoon to march in column.

NOTE: Since the platoon becomes inverted if faced to the left, this should only be done for short adjusting movements. To properly form column facing to the left, the platoon should first form column by facing to the right, then execute successive column movements until the column is faced in the desired direction.

8008. TO FORM LINE FROM COLUMN. The purpose of this movement is to change the formation from a column back to a line. It may be executed when halted at attention and at order arms if armed with rifles. The command is **"Left, FACE."** (NOTE: If the platoon is in column at close interval they must be extended to normal interval, paragraph 8013, prior to executing left face. Otherwise there will not be 40 inches distance between ranks.) At the command of execution **"FACE,"** all members of the platoon face to the left, the platoon commander, if necessary, moves by the most direct route to a post 6 paces front and center of the platoon, and the platoon guide takes post on the right of the front rank.

NOTE: When in column, if the platoon is faced to the right it becomes inverted. This should only be done for short adjusting movements.

8009. TO ALIGN THE PLATOON

1. The purpose of these movements is to dress the alignment of the platoon. They may be executed when the platoon is halted at attention in line or column. When in line, the commands are **"Dress Right (Left), DRESS"** or **"At Close Interval, Dress Right (Left), DRESS."** These commands are given only when the platoon is at approximately the same interval as the interval at which the dress is commanded. When in column, halted or marching, the command to dress alignment is **"COVER."**

2. Dress Right Dress

a. On the command **"Dress Right, DRESS,"** everyone except those individuals on the right flank, smartly turn their heads to the right, look, and align themselves. At the same time, everyone except those individuals on the left flank, provide interval by smartly raising their extended left arm to shoulder height and in line with their body. Fingers are extended and joined, thumb along the forefinger, palm down.

b. As the base of the movement, the guide stands fast and remains looking to the front. The first squad leader looks to the right and aligns on the guide. The other squad leaders cover the first squad leader and look to the front, ensuring they have a 40-inch distance. All other members position themselves by short steps until their right shoulders touch or come into alignment with the fingertips of the person on their right.

NOTE: Squad members should not raise or lower their arms to touch the top of the member next to them if the member next to them is taller or shorter.

c. The platoon commander, on his/her own command of execution **"DRESS,"** faces half left, as in marching, and proceeds by the most direct route to a position on line with the front rank and 1 pace to the guide's right (or first squad leader if there is no guide). (See figure 8-3a.) At this position, the platoon commander executes a halt while facing rear, and then executes a right face, facing down the line of the first rank. (See figure 8-3b.) The platoon commander aligns the front rank by commanding those individuals in advance or rear of the line to move forward or backward until in line. These individuals are designated by name or number. For example: **"Jones, FORWARD;"** or **"Number Three, BACKWARDS."** Those commanded to move will move the designated number of steps or will continue to move (taking small steps) until receiving the command **"STEADY."** The commander may execute a series of short side steps to the right or left in order to identify an individual. However, prior to commanding the identified individual to move, the commander will be on line with the rank. After verifying the alignment of the first rank, the platoon commander faces to the left as in marching, and moves to a position on line with the next rank. The 1 pace interval from the guide is maintained (this results in a 2 pace interval from the second and subsequent squad leaders). The commander halts on line with each succeeding rank, executes right face, and aligns the rank. (See figures 8-3c and d.) After verifying the

alignment of the last rank, the platoon commander faces to the right in marching, marches straight to a point 3 paces beyond the front rank, maintaining the 1 pace interval to the guide's right, halts, (see figure 8-3e) faces to the left, (see figure 8-3f) and commands "Ready, FRONT" and "COVER." Immediately after commanding, "COVER," the platoon commander marches by the most direct route back to a post 6 paces front and centered on the platoon.

d. On the command "Ready, FRONT," all members of the platoon who raised their left arm and turned their head to the right, will smartly but quietly lower their arm to their side and at the same time turn their head back to the front, assuming the position of attention. On the command "COVER," all members of the second and subsequent ranks will cover on the individual in front of them.

e. When aligning a platoon of well-drilled troops or when there is insufficient time to verify alignment, the platoon commander may command "Ready, FRONT" and "COVER" from his/her normal position (6 paces front and centered), without having verified alignment.

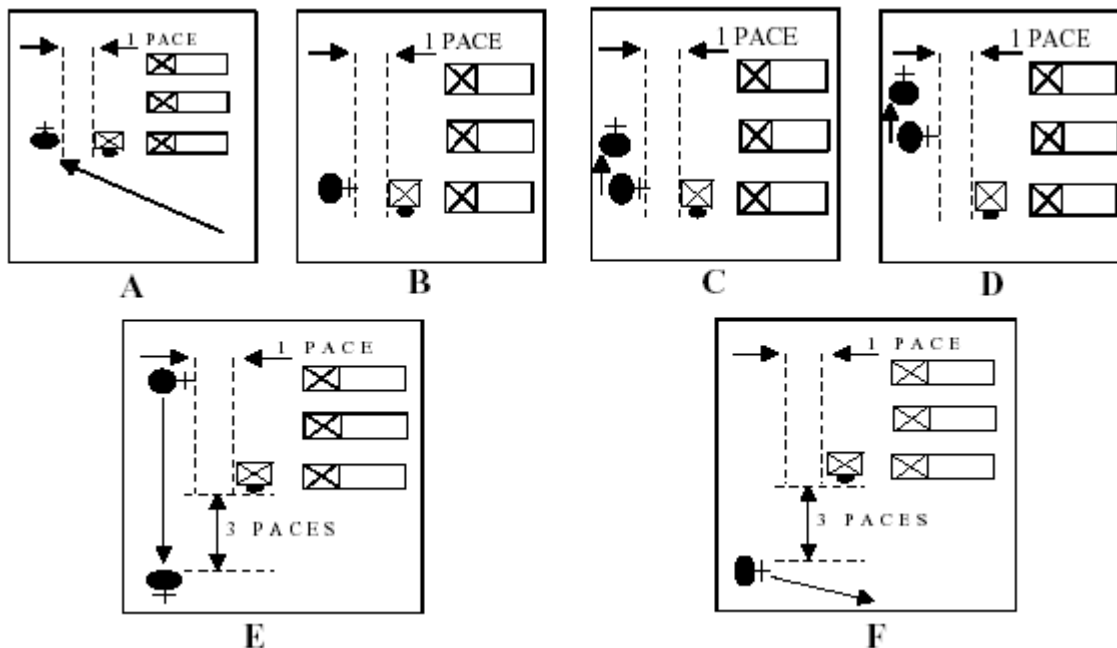

Figure 8-3.--Movements of the Platoon Commander when Aligning the Platoon.

3. At Close Interval Dress Right Dress. This movement is executed in the same manner as dress right dress except for the following: On the command "At Close Interval, Dress Right, DRESS," those individuals providing interval will do so by placing the heel of their left hand on their hip with the elbow in line with their body. Fingers are extended and joined and pointing down. Members gaining interval will move by short steps until their right arm is touching the left elbow of the individual to their right.

4. Dress Left Dress and at Close Interval Dress Left Dress. These movements are similar to dress right dress and at close interval dress right dress except that alignment is made toward the left. The last individual in the first rank is the base of the movement and stands fast. On the command "Dress Left, DRESS" or "At Close Interval, Dress Left, DRESS," everyone except those on the left flank smartly turn their heads to the left, look, and align themselves. At the same time they will smartly raise their left arm or elbow to provide interval (the left arm is used for both dress right and dress left). The last individuals in the second and subsequent ranks will cover the person in front of them and ensure that they have a 40-inch distance. The platoon commander will verify alignment of the platoon from its left flank.

5. Aligning in Column

a. The base squad for maintaining alignment while halted or marching in column is normally the third (right) squad. However, when executing a column left, column half left or eyes left alignment is to the first (left) squad. While marching, alignment is maintained by constantly glancing out of the corner of the right (left) eye, without turning the head.

b. Halted. When halted in column, (except for parades and ceremonies) the platoon is aligned by the command "**COVER.**" At the command, the base squad leader obtains a 40-inch distance from the guide and covers on him/her. Other squad leaders obtain proper interval from the base squad leader and align toward the base by glancing out of the corner of their right (left) eye without turning their heads. Other members of the base squad obtain a 40-inch distance and covers on the person in front of them. At the same time, the remaining members of the platoon align on the base squad, by glancing out of the corner of their right (left) eye without turning the head and covers on the person in front of them. Only small adjusting steps are taken by platoon members to gain cover and alignment.

c. Marching. While marching, cover and alignment are constantly maintained by glancing out of the corner of the right (left) eye, without turning the head, to align on the base squad. The command of "**COVER**" is only given if required.

8010. TO OBTAIN CLOSE INTERVAL FROM NORMAL INTERVAL IN LINE

1. The purpose of this movement is to close the interval between files of a platoon in line to 4 inches. It may be executed when the platoon is halted at attention and in line at normal interval. The command is "**Close, MARCH.**"

2. The squad leaders are the base of this movement. On the command of execution "**MARCH,**" the squad leaders stand fast and place their left hand on their hip to provide interval for the individuals to their left. At the same time, all other members of the platoon, except for the guide, face to the right as in marching, march toward the right flank until approximately 4 inches from the person in front of them, halt, and face to the left. They then execute at close interval dress right dress. After aligning and without command, they will smartly lower their left hands and turn their heads to the front as soon as the individual to their left has touched their elbow with his/her right arm and stopped moving. Cover is then obtained without command.

3. On the command of execution, the guide will step to the left as in marching and close to 4 inches on the first squad leader. After halting and facing to the right, the guide will execute a "**close interval dress left dress.**" When aligned and at the proper interval the guide will return to the position of attention.

4. The platoon commander on his/her own command of execution "**MARCH**" will step to the left in marching. He/she marches parallel to the platoon maintaining a distance of 6 paces from the platoon. When approximately on the center of the platoon at close interval the platoon commander halts and faces the platoon. The platoon commander then adjusts to the center of the platoon by taking small steps left, right, forward or back.

8011. TO OBTAIN NORMAL INTERVAL FROM CLOSE INTERVAL IN LINE

1. The purpose of this movement is to extend the interval between files of a platoon in line to one arm length. It may be executed when the platoon is halted at attention and in line at close interval. The command is "**Extend, MARCH.**"

2. The squad leaders are the base of this movement. On the command of execution "**MARCH,**" the squad leaders stand fast and raise their left arms to shoulder height to provide interval for the persons on their left. At the same time, all other members of the platoon, except for the guide, face to the left as in marching, march toward the left flank until they have opened approximately a 30-inch distance from the person behind them, halt, and face to the right. They then execute dress right dress. After aligning and without command, they will smartly lower their left arms and turn their heads to the front as soon as the individual to their left has touched their finger tips with his/her right shoulder and stopped moving. Cover is then obtained without command.

3. On the command of execution, the guide will take one step to the right as in marching, halt and face to the left. The guide will then execute dress left dress. When aligned on the first squad leader and at the proper interval the guide will return to the position of attention.

4. The platoon commander on his/her own command of execution "**MARCH**" will step to the right in marching. He/she marches parallel to the platoon maintaining a distance of 6 paces from the platoon. When approximately on the center of the platoon at normal interval the platoon commander halts and faces the platoon. The platoon commander then adjusts to the center of the platoon by taking small steps left, right, forward or back.

8012. TO OBTAIN CLOSE INTERVAL IN COLUMN

1. The purpose of this movement is to close the interval between files in a column to 4 inches. It may be executed when halted or marching at normal interval in column. The command is "**Close, MARCH.**"

2. When halted and the guide is right, on the command "**MARCH,**" members of the base (right) squad will stand fast. Members of the squad next to the base squad will execute two right steps. The next squad to the left will execute four right steps. If there are four squads in the platoon, the first (left) squad will execute six right steps. While side stepping, cover and alignment will be maintained. Steps may be adjusted slightly so that a 4-inch interval is obtained. Upon completion of the designated number of steps, members of the squad will halt and resume the position of attention.

3. When marching and the guide is right, the command of execution "**MARCH**" is given as the right foot strikes the deck. At this command:

a. The base (right) squad takes one more 30-inch step with the left foot and then begins to half step. (See figure 8-4.)

b. The squad to the left of the base squad takes one more 30-inch step to the front with the left foot; execute right oblique toward the base squad for one step and then steps 30 inches back to the original front. The squad then begins to half step.

c. The next squad to the left takes one more 30-inch step to the front and then executes right oblique toward the base squad for three steps and steps 30 inches back to the original front. The squad then begins to half step.

d. If there are four squads in the platoon, the first (left) squad would execute the same movements as above except the members would take five steps in the oblique.

e. Steps in the oblique may be adjusted slightly so that a 4-inch interval is obtained.

f. At the command "**Forward, MARCH**" all squads resume taking 30-inch steps.

4. If the guide has been shifted to the left or center, the base squad will become the squad behind the guide. The commands of execution will be given as the left foot strikes the deck, if guide is left, or on either foot if guide is center. Side steps or oblique movements will be made toward the base squad as appropriate.

5. The platoon commander, on his/her command "**MARCH,**" oblique the number of steps necessary to remain parallel to the platoon and picks up the half step. The platoon commander picks up a full 30-inch step on his/her command of "**Forward, MARCH.**"

e. Steps in the oblique may be adjusted slightly so that a one-arm interval is obtained between squad leaders.

f. At the command "**Forward, MARCH,**" all squads resume taking 30-inch steps.

4. If the guide has been shifted to the left or center, the base squad will become the squad behind the guide. Side steps or oblique movements will then be made away from the base squad as appropriate.

5. The platoon commander, on his/her command "**MARCH,**" oblique the number of steps necessary to remain 6 paces from the platoon and picks up the half step. The platoon commander picks up a full 30-inch step on his/her command of "**Forward, MARCH.**"

8014. TO OPEN RANKS

1. The purpose of this movement is to increase the distance between ranks to 70 inches in order to accommodate the movements of an inspection party or to stack arms. It may be executed when halted in line at attention, and at normal or close interval. If armed, rifles will be at order arms. The commands are "**(At Close Interval), Open Ranks,**" "**MARCH;**" "**Ready, FRONT;**" and "**COVER.**"

2. When at normal interval, on the command of execution "**MARCH,**" the front rank takes two 30-inch steps forward, halts, and executes dress right dress. The second rank takes one 30-inch step forward, halts, and executes dress right dress. The third rank stands fast and executes dress right. If there is a fourth rank, it takes two 15-inch back steps, halts, and executes dress right. When at close interval, all ranks will execute at close interval, dress right dress in place of dress right dress.

3. The platoon commander verifies alignment as for dress right dress, except that he/she will verify the 70-inch distance between ranks by taking two 30 inch steps and one 10-inch step when moving from one rank to the next. After verifying the alignment of the rear rank, he/she faces to the right in marching, marches 3 paces beyond the front rank, and 1 pace to the guide's right, halts, faces to the left, and commands "**Ready, FRONT**" and "**COVER.**" The platoon responds to these commands in the same manner as when they are given following dress right dress.

a. If the platoon is about to be inspected, the platoon commander, after the command "**COVER,**" will take one step to the front so that he/she is 3 paces directly in front of the guide, and then execute a right face. From this position the platoon commander reports the platoon to the inspecting officer. This is standard for all NJROTC competitions.

8015. TO CLOSE RANKS

1. The purpose of this movement is to decrease the distance between opened ranks to a normal distance (40 inches). It may only be given when the platoon is at attention at open ranks. The command is "**Close Ranks, MARCH.**" It should be given immediately after the reason for opening ranks is accomplished, and before the platoon is given further drill movements or dismissed.

2. On the command of execution "**MARCH,**" the front rank stands fast while the second rank takes one 30-inch step to the front and halts. At the same time, the third rank takes two 30-inch steps to the front and if there is a fourth squad, it takes 3 steps and halts. Each individual maintains cover and alignment while moving. No dressing movements are executed.

a. The platoon commander may give the command to close ranks when:

1. The reason for open ranks was to increase the distance between ranks to 70 inches for NJROTC basic drill competitions only, then the platoon commander gives the command to close ranks at the same position from which he/she commanded ready front.

2. After the platoon is inspected, the platoon commander returns to a position 3 paces in front of the guide and halts facing to the front. It is from this position that the inspecting officer would critique the inspection. The

platoon commander would exchange salutes with the inspection officer and after that officer has departed, the platoon commander would face to the left and then command "**Close Ranks, MARCH.**" The platoon commander, on the command "**MARCH,**" then moves to his/her position 6 paces and centered on the platoon. This is standard for all NJROTC competitions

8016. TO FORM FOR PHYSICAL DRILL

1. The purpose of the movement is to form the platoon for physical exercise. It may be executed when the platoon is halted at attention and in a column of threes or fours at normal interval. If armed with rifles, they will be at order arms. The sequence of commands is: "**From Front to Rear, Count, OFF;**" "**Take Interval to the Left, MARCH;**" "**Arms, DOWN;**" and "**Even Numbers, To the Right, MOVE.**" To reform to a column the commands are "**Assemble, MARCH**" and "**Cover.**"

2. The command "**From Front to Rear, Count OFF;**" is given by the platoon commander in order to designate odd and even ranks. It is executed as prescribed for counting off in column.

3. The next command is "**Take Interval to the Left, MARCH.**" With the platoon in column, the extended interval is set by designating the number of steps the members of each squad take to the left.

a. On the command of execution "**MARCH,**" all members of the squad on the right flank (third squad if it is a three squad platoon, fourth squad if it is a four squad platoon) and the guide, will cover in file, stand fast and each member extends both arms sideways at shoulder height, palms down with fingers extended and joined. If armed with rifles each member will grasp the upper hand guard of the rifle near the stacking swivel, keeping the trigger guard facing forward and raise it to shoulder height. This squad forms the base of the movement.

b. At the same time, the members of each squad to the left of the base squad will face to the left as in marching and take two, four, or six (if it is a four squad platoon) 30-inch steps respectively. Upon completing their designated number of steps, they will halt, execute a right face, will cover in file, stand fast, and extend their arms to the side at shoulder height in the same manner as the right file. If armed with rifles the rifles are carried at trail arms during movement and then raised in the same manner as the right file.

c. At the command "**Arms, DOWN,**" the arms are lowered smartly to the side and if armed with rifles the position of order arms is assumed.

4. On the command "**Even Numbers to the Right, MOVE,**" all even numbered individuals and the guide will move to their right to the middle of the interval between files. This will be done by swinging the right leg to the right and springing off the left foot. The movement should be completed in one hop. If armed with rifles the weapon is brought to trail arms and held against the right leg during movement. Once in position, even numbered members cover and assume the position of attention. Odd numbered members do not move. From this position physical drill may be executed without the danger of collisions between individuals.

5. Upon completion of physical drill, the command "**Assemble, MARCH**" is given. On the command of execution, the odd numbered members of the base squad stand fast. Even numbered members of the base squad step left in marching and double time to their positions covered on the odd numbered members of the base squad, and the guide will return to a position in front of the base squad leader. At the same time, all other members will face right as in marching and, at a double time cadence, reassemble in column at normal interval and stand fast. The platoon commander would then give the command of "**COVER**" in order for the platoon to quickly pick up its alignment and cover.

6. The platoon commander, once the platoon is in column, gives all commands from a position 6 paces in front of, centered on and facing the column. He/she makes those movements necessary to maintain this position during the execution of the movement(s).

8017. TO CHANGE THE DIRECTION OF A COLUMN

1. The purpose of this movement is to change the direction of march of a column. It may be executed when the platoon is halted or marching in column at normal or close interval. The command is "**Column Right (Column Left, Column Half Right or Column Half Left), MARCH.**" The base element during the turn is the squad on the flank in the direction of the turn. The leading member of the base squad, excluding the platoon commander and guide, establishes the pivot for the movement.
2. When marching, the commands of execution are given on the foot in the direction of the turn. On the command of execution "**MARCH,**" the leading member of the base squad takes one more 30-inch step to the front and then pivots 90 degrees to the right (left) on the ball of the left (right) foot. He/she then takes one 30-inch step in the new direction before beginning to half step. At the same time other members of the leading rank execute a right (left) oblique. They step in this direction until they are on line with the new line of march (normally two, four and six steps respectively) and then execute a second right (left) oblique. The original interval is maintained while in the oblique. Stepping out of the second oblique with a 30-inch step, they begin to half step as soon as they are aligned on the base squad leader. When all members of the same rank have come abreast, everyone in that rank resumes a full step. Ranks in rear of the leading rank execute the pivot movements on the same points and in the same way as the leading rank. (See figure 8-5.)
3. When halted, at the command of execution "**MARCH,**" the leading member of the base squad steps to the right (left) as in marching by turning to the right (left) on the ball of his/her right foot and takes one 30-inch step with his/her left foot in the new direction. Then he/she half steps. When other cadets of his/her rank are abreast, he/she resumes marching at a 30-inch step. At the same time other cadets of the leading rank oblique twice to the right with out changing interval and will place themselves abreast of the pivot cadet and conform to his/her step. They execute the first oblique at the command of execution. The second oblique is executed when opposite their new line of march so that when the oblique is completed they will be marching toward the new front with proper interval. The ranks to the rear of the lead rank will execute the movement on the same point and in the same way as the leading rank. The remainder of the movement is executed the same as in marching.
4. During column movements, the platoon commander and guide execute either an oblique or a 90-degree pivot (depending on the direction of the movement) on the command of execution. After completing their turn, they adjust their line of march so that they are in front of the appropriate squad.
5. For slight changes of direction, the command is "**INCLINE TO THE RIGHT (LEFT).**" At that command, the guide changes direction as commanded. This is not a precision movement and is executed only while marching.

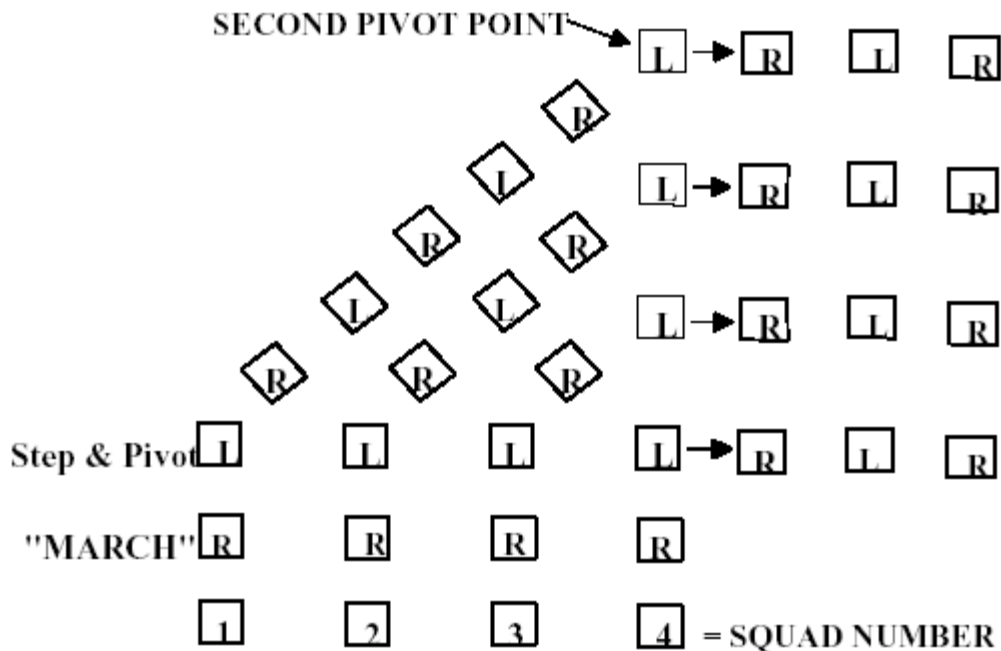

Figure 8-5. Executing Column Right (Left).

8018. TO MARCH TO THE FLANK

1. The purpose of this movement is to march the platoon to the right or left flank for a short distance. It may be executed from any formation that is marching at quick time or double time cadence. The command is "**By the Right (Left) Flank, MARCH.**" The command of execution is given as the foot in the direction of the turn strikes the deck.

2. To execute a right flank when marching at quick time, the command is "**By the Right Flank, MARCH.**" On the command of execution "**MARCH,**" everyone takes one more 30-inch step to the front with the left foot and then pivots 90 degrees to the right on the ball of the left foot. Stepping out of the pivot with a 30-inch step, the entire platoon marches in line to the right flank. The platoon commander and guide execute the flanking movement with the platoon, but do not change their position within the platoon. For the platoon to resume marching in the original direction, the command is "**By the Left Flank, MARCH.**" To march to the left flank, substitute left for right and right for left in the above sequence. No other command may be given when marching to the flank until the unit has resumed marching to the original front. (See figure 8-6.)

3. When this movement is executed from a column at close interval, squad(s) to the rear of the squad that becomes the leading squad takes up the half step. They resume a full step as soon as a 40-inch distance has opened between squads. After such a movement, the platoon maintains normal interval until close march is commanded.

4. When marching at double time, on the command of execution "**MARCH,**" everyone takes two more 36-inch steps to the front and then two 6-inch vertical steps in place at double time cadence. While stepping in place, everyone turns 90 degrees toward the direction commanded and then steps off with a 36-inch step in the new direction.

5. When the platoon executes flank movements from a column at close interval, squad(s) to the rear of the squad that becomes the leading squad, will take up a half step. They resume a full step as soon as a 40-inch distance has opened between squads. After such a movement, the platoon maintains normal interval until close march is commanded.

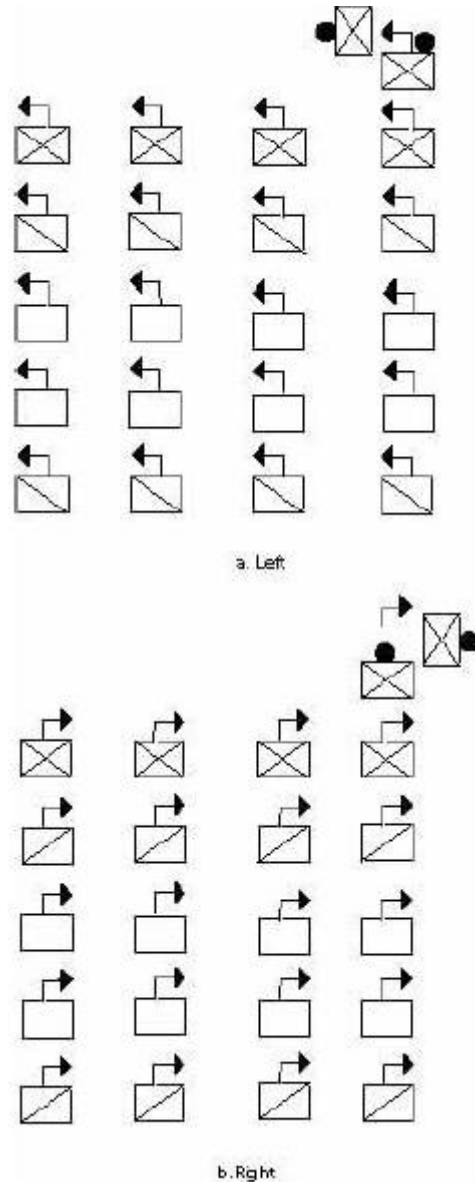

Figure 8-6. Right (Left) Flank.

8019. TO MARCH IN THE OBLIQUE

1. The purpose of this movement is to shift the line of march to the right or left for a short distance and then resume marching in the original direction. It may be executed from any formation that is marching at quick time cadence. The command is **"Right (Left) Oblique, MARCH."** The word oblique is pronounced to rhyme with strike. The command of execution is given as the foot in the direction of the turn strikes the deck. The command to resume the original direction of march is **"Forward, MARCH."** The command of execution is given as the foot toward the original front strikes the deck.

2. To teach the platoon to march to the oblique, the leader aligns the unit and has members face half right (left). The leader then explains that these positions are maintained when marching to the oblique. This is achieved by individuals keeping their shoulders parallel to the persons in front and/or adjacent to them. The individual at the corner of the platoon towards the direction of the oblique is the base of the movement, and must maintain a steady line of march keeping his/her other shoulders blocked perpendicular to the direction of march.

3. To march the platoon in the right oblique, the command is **"Right Oblique, MARCH."** On the command **"MARCH,"** everyone then takes one more 30-inch step to the

front with the left foot and pivots 45 degrees to the right on the ball of the left foot. Stepping out of the pivot with a 30-inch step, the entire platoon marches to the right oblique until given another command. (See figure 8-7.) For the platoon to resume marching in the original direction, the command is **"Forward, MARCH,"** in this case the command of execution will be given as the left foot strikes the deck. Everyone then takes one more step in the oblique direction with the right foot; pivots back to the original front and continue to march. To march to the left oblique, substitute left for right and right for left in the above sequence.

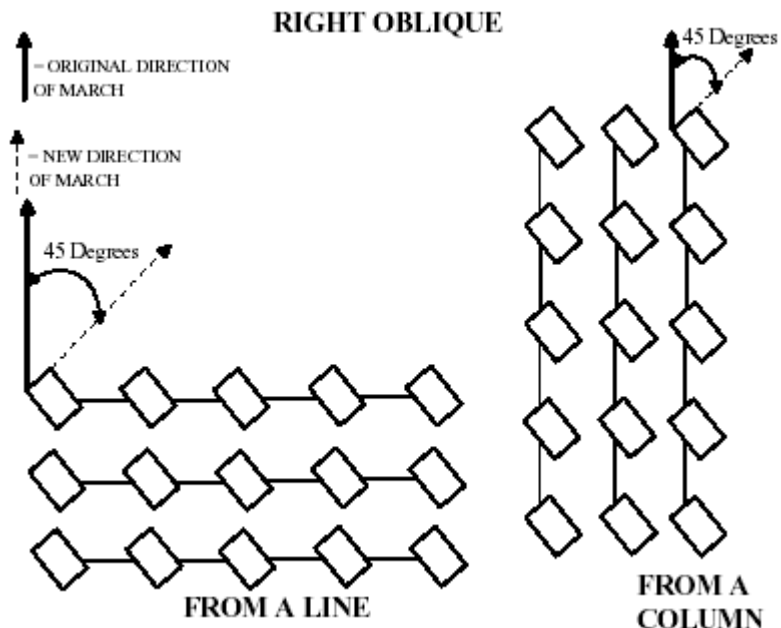

Figure 8-7.--Marching to Right Oblique.

4. To halt the squad facing in the original direction of march the command is **"Platoon, HALT."** The command of execution **"HALT"** is given on the left foot when marching to the right oblique, and on the right foot when marching to the left oblique. At the command **"HALT,"** everyone takes one more step in the oblique direction, pivots to the original front on the toe of the right (left) foot, and places the left (right) foot beside the other at the position of attention.

5. To temporarily halt the squad in the oblique direction, in order to correct errors, the command is **"In Place, HALT."** The command of execution **"HALT"** may be given as either foot strikes the deck. At the command of execution **"HALT,"** the squad halts in two counts as in quick time and remains facing in the oblique direction. The only command that can be given after halting in place is **"Resume, MARCH."** At that command the movement continues marching in the oblique direction.

6. When given half step or mark time while marching in the oblique, the only commands that may be given are, **"Resume, MARCH,"** to continue marching with a 30-inch step in the oblique; or **"In Place, HALT."** to halt in the oblique in order to correct errors.

8020. TO MARCH TO THE REAR

1. The purpose of this movement is to march the platoon to the rear for a short distance. It may be executed when halted or marching forward at quick time or double time. The command is **"To the Rear, MARCH"** it will be given as the right foot strikes the deck when marching.

2. When halted, on the command of execution **"MARCH,"** everyone takes one 15-inch step to the front with the left foot and then pivots 180 degrees toward the right on the balls of both feet. Stepping out of the pivot with a 30-inch step, the entire platoon marches to the rear. For the platoon to resume marching in the

original direction, the command **"To the Rear, MARCH"** is given again. No other command may be given when marching to the rear until the unit has resumed marching to the original front.

3. When marching at quick time, on the command of execution **"MARCH,"** everyone takes one 15-inch step to the front with the left foot and then pivots 180 degrees toward the right on the balls of both feet. Stepping out of the pivot with a 30-inch step, the entire platoon marches to the rear. For the platoon to resume marching in the original direction, the command **"To the Rear, MARCH"** is given again. No other command may be given when marching to the rear until the unit has resumed marching to the original front.

4. When marching at double time, on the command of execution **"MARCH,"** everyone takes two more 36-inch steps to the front and then four 6-inch vertical steps in place at double time cadence. On the first and third steps in place, everyone pivots 180 degrees to the right, 90 degrees on the first step and 90 degrees on the third. After the fourth step in place, and for the fifth step, they step off with a 36-inch step in the new direction. For the platoon to resume marching in the original direction, the command **"To the Rear, MARCH"** is given again. No other command may be given when marching to the rear until the unit has resumed marching to the original front.

8021. FILES AND REFORM

1. The purpose of these movements is to diminish the front of the platoon in column. They may be executed when the platoon is halted at attention in column of threes or fours, and when at normal or close interval. Squads may be taken from either the right or left side of the platoon. The command to form a column of twos is **"Column of Twos from the Right (Left), MARCH."** The command to form a column of files is **"Column of Files from the Right (Left), MARCH."** When the squad leaders give supplemental commands they turn their head and eyes toward the direction of the movement, give the supplemental command, and turn their head and eyes back to the front. When commanding, **"Squad, HALT,"** the squad leaders turn their head and eyes in the direction of the halted element, regardless of the direction of the movement.

2. When forming a column of files and reforming to threes (fours) it is important to note, in order to keep from inverting the platoon, that:

a. If a column of files were taken FROM the LEFT, then a column of threes (fours) must be formed TO the RIGHT.

b. If a column of files were taken FROM the RIGHT, then a column of threes (fours) must be formed TO the LEFT.

3. Form a Column of Files and Reform.

a. On the preparatory command **"Column of Files From the Right,"** squad leaders turn their head and eyes to the right and give the following supplementary commands. Simultaneously, the third squad leader commands **"Forward."** The remaining squad leaders command, **"STAND FAST."** The guide remains in position. On the platoon commander's command of execution **"MARCH,"** the third squad marches forward; the remaining squads stand fast, then as the fourth to the last member of the squad to the right is about to pass their position the squad leader.

(1) The second squad leader turns his/her head and eyes to the right and commands **"Column Half Right, Column Half Left, MARCH."** The squad leader on his/her own command of execution **"MARCH,"** steps in the right oblique then pivots back to the left, so as to march at normal distance in single file behind the leading squad. The remaining squad members march forward and execute the pivots on the same point as established by the squad leader. (See figure 8-10.)

(2) The first squad leader turns his/her head and eyes to the right and commands **"Column Half Right, MARCH"** and **"Column Half Left, MARCH"** so as to march at normal distance in single file behind the leading squad.

b. To reform into a column of threes, the command is **"Column of Threes to the Left, MARCH."** On the preparatory command, squad leaders, in sequence, give the following supplementary commands: the third squad leader turns his/her head and eyes to the left and commands **"STAND FAST;"** the second squad leader turns his/her head and eyes to the left and commands **"Column Half Left, Column Half Right;"** and

the first squad leader turns his/her head and eyes to the left and commands "**Forward.**" On the platoon commander's command of execution "**MARCH:**"

(1) The leading squad stands fast.

(2) The second squad leader takes one step in the left oblique then pivots back to the right, so as to be marching to the left of and parallel to the lead squad. The remaining squad members march forward and execute the pivots on the same point as established by the squad leader. The squad leader would continue to march forward until nearing the lead squad leader, at which time he/she turns his/her head and eyes to the right and gives the command "**Squad, HALT.**" The squad is halted so that it is aligned with, and the proper interval from the two lead squads.

(3) The first squad marches forward until approaching the end of the lead squad. The squad leader then turns his/her head and eyes to the left and commands, "**Column Half Left, MARCH.**" The squad leader then turns his/her head and eyes to the right and commands "**Column Half Right, MARCH**" in order to place his/her squad to the left of and at proper interval from the second squad. The squad would continue to march forward until nearing the second squad leaders, at which time the squad leader turns his head/her and eyes to the right and gives the command "**Squad, HALT.**" The squad is halted so that it is aligned with, and the proper interval from the two lead squads.

c. To form a column of files from the left and reform to a column of threes to the right, use the same procedure as described in paragraphs 8021.3 a and b above substituting left for right and right for left. On the platoon commander's preparatory command of "**Column of Files from the Left,**" the guide changes position to be in front of the first squad leader. When reforming to threes, after all squads have halted, the guide moves back in front of the third squad leader.

4. Forming a column of files and reforming when in a column of fours is executed in a similar manner as when in a column of threes.

5. When marching in column of twos, the platoon commander is ahead of the left file and the guide is in front of the right file. When marching in single file, the guide leads the platoon, the platoon commander marches abreast of and to the left of the guide. If executing the movements for practice or instructional purposes the platoon commander would position himself/herself where he/she could best supervise the platoon.

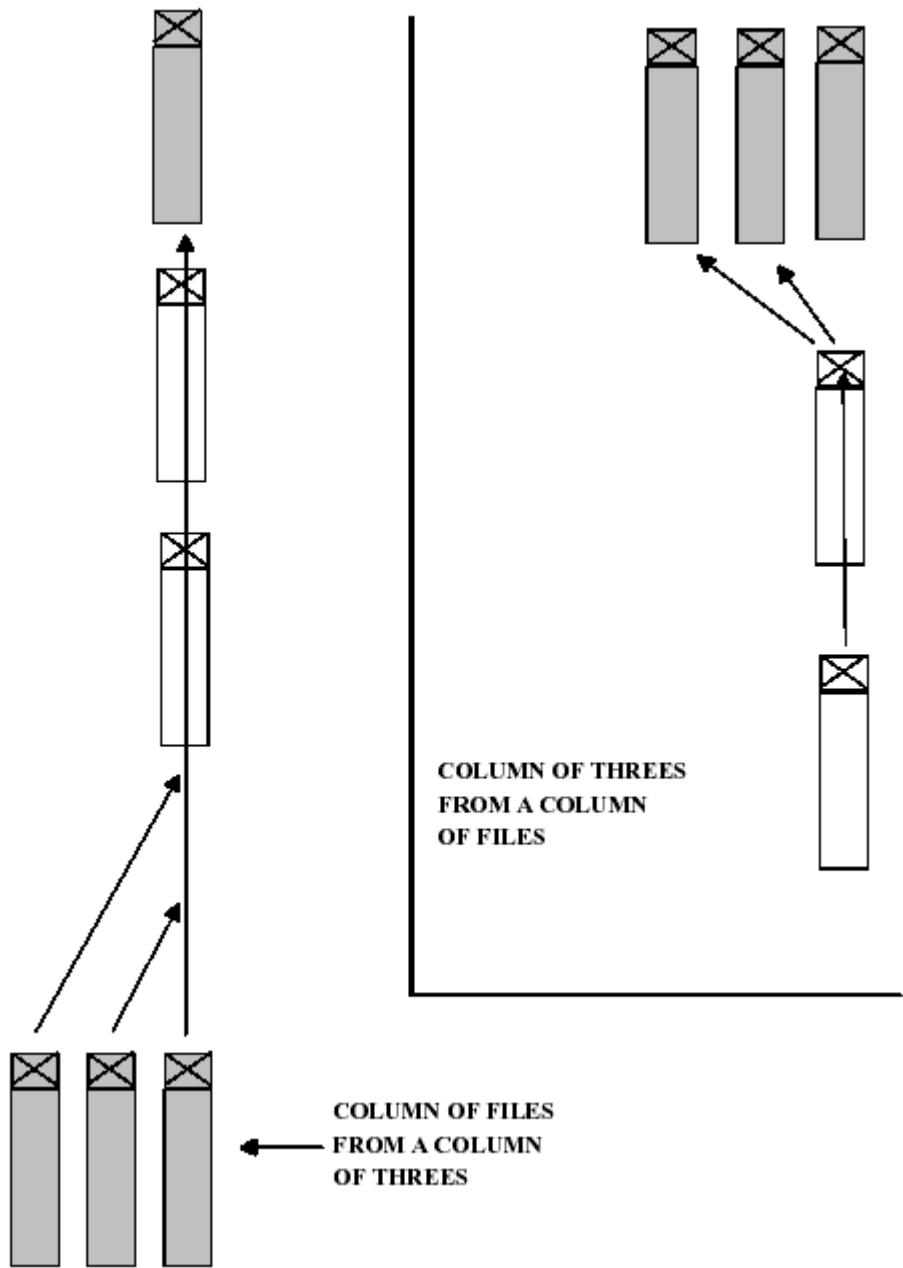

Figure 8-10. Column of Files from Column of Threes and Reform.

CHAPTER 9

COMPANY DRILL

9000. GENERAL

1. A company consists of a company staff and two or more platoons.
2. Most NJROTC units will have three platoons in their company. Some units choose to make a separate platoon out of the unit's drill teams and have them march under arms in major parades. Also, all NJROTC units will have a Color Guard. Local parade/march requirements will require flexibility on the part of the SNSI/NSI in the formation of the unit.
3. Formations used by the company are line, column (of threes, etc.), mass, extended mass, and column of platoons in line. In all these formations, the platoons that comprise the company will either be in line (each squad forming one rank) or in column (each squad forming one file). The company may also form column of files in a manner similar to that prescribed for a platoon, in which case the platoons are arranged as in column, except that each platoon is in column of twos or files. Formations of the company for drills and ceremonies, to include posts of cadet officers and key cadet petty officers, are shown in figures 9-1 through 9-4.

a. When the company commander is absent, the senior officer present with the company takes post and drills the company as prescribed for the company commander. In the absence of the senior enlisted cadet, the next senior enlisted cadet takes post and performs the duties of the senior enlisted cadet.

b. When officers are not present, after the company is formed, the senior enlisted cadet, or in his/her absence, the next senior enlisted cadet takes post and drills the company as prescribed for the company commander, and mustering petty officers take post and perform the duties of platoon commanders. This also applies when, for any reason, the company commander directs the senior enlisted cadet (or senior cadet or mustering petty officer) to take charge of the company for purposes other than dismissing the company. When this occurs, the officers retire and the senior enlisted cadet and mustering petty officers march by the most direct route to take post as the company commander and platoon commanders, respectively.

c. For drill and ceremonies, the following minimum key billets within the company must be filled by applying the above rules: company commander, guidon bearer, and senior enlisted cadet in the company staff; and a platoon commander, mustering petty officer, and guide for each platoon, plus one squad leader per squad within each platoon.

NOTE: When officers are not present and the senior enlisted cadet and mustering petty officers are acting as company commander and platoon commanders respectively, cadets need not be detailed to also act as senior enlisted cadet and/or mustering petty officers.

d. For drill and ceremonies, the company guidon is carried by the guidon bearer. In all formations, the guidon bearer is 1 pace to the rear and 1 pace to the left of the company commander or senior enlisted cadet, as appropriate.

9001. RULES FOR COMPANY DRILL

1. The platoon, rather than the company, is the basic drill unit. Only such formations are prescribed for the company as are necessary for marches, drills, and ceremonies.
2. In company drill, if all cadets in the unit are to execute the same movement simultaneously, platoon commanders will not repeat preparatory commands of the company commander when commands such as "**FALL OUT**" are given, which combine the preparatory command and command of execution. When the preparatory command of the company commander is "**Company,**" the platoon commanders give the preparatory command "**Platoon.**"

a. When in mass formation, platoon commanders repeat preparatory commands only when the order will require independent movement by a platoon.

b. When the platoons of the company are to execute a movement in successive order, such as a column movement, the platoon commander of the first platoon to execute the movement repeats the company commander's preparatory command, and those of following platoons give an appropriate caution such as "**Continue to March.**" Platoon commanders of following platoons repeat the company commander's preparatory command and command of execution at the proper time to cause their platoons to execute the movement on the same ground as the first platoon.

c. When participating in parades and ceremonies when commands by the adjutant, commander of troops, or company commander can be clearly heard, supplemental commands need not be given.

3. Platoon commanders turn their head and eyes when giving supplemental commands using the following rules.

a. When executing halted movements, such as the manual of arms, the platoon commander turns his/her head and eyes to the right.

b. For movements that involve marching, (e.g., forming from column into mass, mass into column or column movements) the platoon commander turns his/her head and eyes to the direction of the movement to give supplemental command.

c. When bringing the platoon on line with a halted element the platoon commander turns his/her head and eyes towards the halted element to give the command of mark time or halt.

4. When commands involve movements of the company in which one platoon stands fast or continues the march, while one or more of the others do not, its commander commands "**STAND FAST**" or "**Continue to March,**" as the case may be.

5. The company marches, executes change of direction, closes and extends intervals between squads in column, opens and closes ranks, and stacks and takes arms as in platoon drill.

6. The company executes marching in line only for minor changes in position.

7. Unless otherwise specified for the company to be at close interval, all changes in formation must be executed with files and ranks formed at normal interval and distance.

9002. TO FORM THE COMPANY

1. At the command "**FALL IN,**" the company forms in line formation at normal interval and distance. If it is desired to form the company at close interval between files, the command "**At Close Interval, FALL IN**" is given. In this case, the platoons form in line, but files within each platoon are at close interval (4 inches). The company forms at close interval only for roll calls or when space is limited. The company may be formed by the senior enlisted cadet or mustering petty officer under charge of the senior enlisted cadet, or by its officers under command of the company commander, as described below.

2. Forming the Company by Senior Enlisted Cadets

a. The senior enlisted cadet takes post 9 paces in front of the point where the center of the company is to be, faces that point, draws sword if so armed, and commands "**FALL IN**" ("**At Close Interval, FALL IN**"). At this command, the guidon bearer takes post facing the front 1 pace to the front and 1 pace to the right of the senior enlisted cadet (the senior enlisted cadet facing the company), and the company forms in line with platoons in line at normal (close) interval and 4 paces between platoons. Each mustering petty officer takes post 3 paces in front of and facing the point where the center of the platoon is to be, faces that point, and draws sword if so armed. Each platoon then forms (as prescribed in paragraph 8004), under the supervision of the mustering petty officer.

b. Mustering petty officers then command "**REPORT.**" Remaining in position (at order arms if armed with the rifle), the squad leaders, in succession from front to rear in each platoon, salute and report, "All present," or "Private _____ absent." Mustering petty officers then command "**Inspection, ARMS;**" and "**Order, ARMS**" if troops are armed with rifles, then face about to the front. If troops are not armed with rifles, the mustering petty officer immediately faces the front after receiving the reports of the squad leaders. (NOTE: If platoons cannot be formed in regularly organized squads prior to forming the company, the mustering petty officers command "**Inspection, ARMS;**" "**Right Shoulder, ARMS;**" and call the roll. Each cadet answers "here," and goes to order arms as their name is called. The mustering petty officer then organizes the platoon into squads and faces the front. (The manual of arms is omitted for personnel not armed with rifles.)

c. After all mustering petty officers have completed receiving the reports of their squad leaders and are facing the front, the senior enlisted cadet commands "**REPORT,**" at which time the mustering petty officers, beginning with the right platoon, successively salute and report, "All present or accounted for" or " _____ absent." The senior enlisted cadet returns each salute individually. What occurs next depends upon whether the company commander and platoon commanders receive the company or not.

(1) If company officers do not receive the formation, after receiving the reports of all the mustering petty officers, the senior enlisted cadet commands, "**POST.**" On this command, the mustering petty officers and guidon bearer step forward three steps; simultaneously, the senior enlisted cadet faces about and steps forward three steps. The company is now formed with the senior enlisted cadet and mustering petty officers occupying the posts prescribed for the company commander and platoon commanders.

(2) If company officers receive the formation, the company commander and platoon commanders normally observe the initial procedures from a location to the rear of where the company is forming (officers remain with swords in their scabbards, if so armed). In this case, after receiving the reports of the platoon sergeants, the senior enlisted cadet faces the front and awaits the arrival of the company commander. When the company commander has taken post 12 paces front and center of the company, the senior enlisted cadet salutes and reports "Sir/Ma'am, all present or accounted for." or "Sir/Ma'am, _____ cadets absent." The company commander returns the salute, and may discuss absentees and issue necessary instructions to the senior enlisted cadet. Next, the company commander directs the senior enlisted cadet to "**TAKE YOUR POST,**" at which the guidon bearer marches forward 3 paces, and the senior enlisted cadet and mustering petty officers march by the most direct routes to their posts, the former in rear of the company, the latter on the left of the rear rank of their platoons; simultaneously, the company executive officer takes post to the rear of the company and the platoon commanders move around the right front of their platoons and take their posts 6 paces front and center of their platoons. After all officers are in position, if armed with the sword, the company commander draws sword; the company executive officer and platoon commanders draw sword with the company commander.

3. Forming the Company by Officers

a. Normally, the company is initially formed by the senior enlisted cadet or mustering petty officer, then received by the officers as described in paragraph 9002 above. This permits detailed musters to be taken by the staff noncommissioned or noncommissioned officers. During the course of training, if the company has been dismissed for a short period of time, it may be initially reformed by the company commander to save time.

b. When the company is initially formed by the company commander, the procedures are the same as forming with the senior enlisted cadet or mustering petty officer, except that the company commander takes post 12 paces front and center and facing the point where the center of the company is to be, draws sword if so armed, and commands "**FALL IN.**" Platoon commanders then take posts 6 paces front and center and facing the point where the center of their platoons will be, draw sword if so armed, form their platoons and receive the reports of their squad leaders, then face the front. After all platoon commanders have formed their platoons and are facing the front, the company commander commands "**REPORT,**" at which time each platoon commander, in succession from right to left,

salutes and reports, "Sir/Ma'am, all present or accounted for," or "Sir/Ma'am, cadets absent."

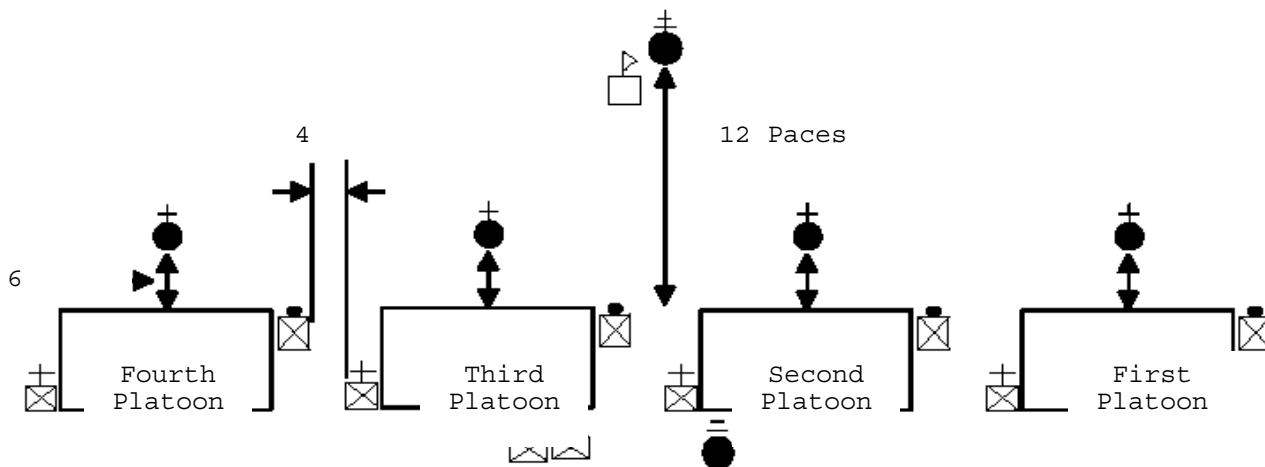

Figure 9-1. --Company in Line Formation.

9003. TO DISMISS THE COMPANY

1. The commands are "**SENIOR ENLISTED CADET**" and "**DISMISS THE COMPANY.**" The company being in line at a halt, at the command "**SENIOR ENLISTED CADET,**" the senior enlisted cadet moves by the most direct route to a point 3 paces from the company commander (9 paces in front of the center of the company), halts, and salutes. The company commander returns the salute and passes any directions or information necessary to the senior enlisted cadet. The company commander directs the senior enlisted cadet to "**DISMISS THE COMPANY.**" The senior enlisted cadet and company commander exchange salutes. After returning the senior enlisted cadet's salute, the company commander returns sword, if so armed, and falls out. Other officers of the company return sword, if so armed, and fall out at the same time and in the same manner as described in **paragraph 9001.2c**. The mustering petty officers take their posts 3 paces in front of the centers of their platoons. The senior enlisted cadet, when the company commander returns his/her salute, executes an about face. When the mustering petty officers have taken their positions, the senior enlisted cadet commands "**Inspection, ARMS;**" and "**DISMISSED.**"

2. The company being in line at a halt, dismissal may also be ordered by the command "**DISMISS YOUR PLATOONS.**" The platoon commanders salute; the company commander returns their salute, returns sword, if so armed, and falls out. The platoon commanders execute about face and command "**MUSTERING PETTY OFFICER.**" The platoon sergeant takes his/her post 3 paces in front of the center of the platoon halts, facing the platoon commander and salutes. The platoon commander returns the salute and passes any directions or information necessary to the mustering petty officer. The platoon commander then directs the mustering petty officer to "**DISMISS THE PLATOON,**" the mustering petty officer and platoon commander exchange salutes. After the platoon commander has returned the mustering petty officer's salute, he/she returns sword if so armed, and falls out. The mustering petty officer then faces the platoon and commands "**Inspection, ARMS;**" and "**DISMISSED.**"

3. The senior enlisted cadet may cause platoons to be dismissed by the mustering petty officers by commanding "**DISMISS YOUR PLATOONS.**" The mustering petty officers salute; the senior enlisted cadet returns the salute, returns sword if so armed, and falls out. The platoon sergeants then execute about face and command "**Inspection, ARMS;**" and "**DISMISSED.**"

9004. BEING IN LINE, TO FORM COLUMN AND REFORM INTO LINE

1. Being at a halt and at the order in line, to form column, the company commander orders "**Right, FACE.**" After facing to the right, all officers, key

senior enlisted cadets or mustering petty officers, and the guidon bearer march by the most direct routes to their posts in column. The company commander may then cause the column to march (NOTE: As platoons and squads become inverted if the company is faced to the left, this should be done only for short movements.).

2. Being at a halt and at the order in column, to form line, the company commander commands "**Left, FACE.**" (NOTE: If the company is at close interval they must be extended to normal interval, paragraph 8012, prior to executing left face. Otherwise there will not be 40 inches of distance between ranks.) After facing to the left, all officers, key mustering petty officers, and the guidon bearer march by the most direct routes to their posts in line.

NOTE: When in column, if the company is faced to the right, platoons and squads become inverted. Therefore, to form line facing the right flank of a column, the company should first be marched by executing necessary changes in direction, so that after halting the left, line will be formed facing the desired direction.

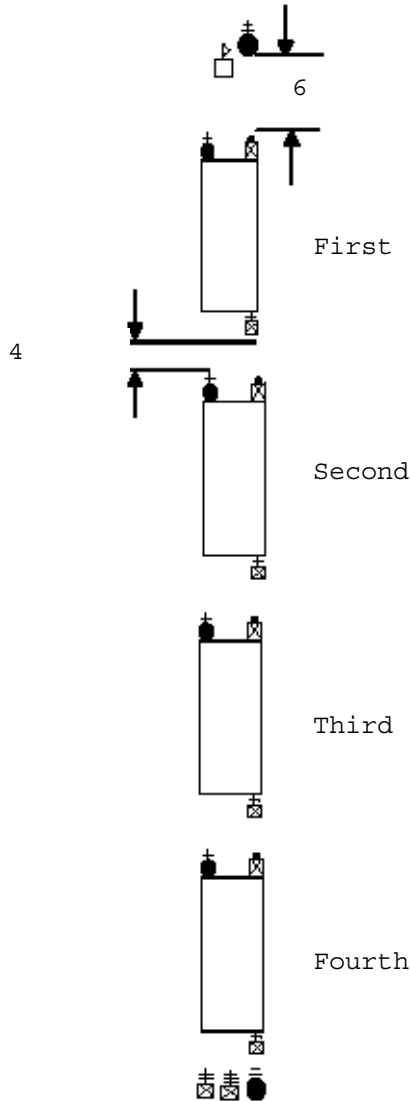

Figure 9-2.--Company in Column Formation.

9005. TO ALIGN THE COMPANY

1. To align the company when in line at a halt, the company commander commands, **"DRESS RIGHT (CENTER, LEFT)."** At the command **"DRESS RIGHT,"** the platoon commander of the base platoon aligns his/her platoon immediately by the commands **"Dress Right, DRESS;" "Ready, FRONT;"** and **"COVER."** After the platoon commander of the base platoon gives the command to dress right, the remaining platoon commanders will align their platoons in successive order. When **"DRESS CENTER"** is given, the commander of the center platoon, which is the base platoon for this movement, aligns the platoon to the center of the company. The base platoon for this movement is the second platoon in both three and four platoon companies. After the base platoon commander has aligned the platoon, the remaining platoon commanders will align their respective platoons on the base platoon by executing **"Dress Right (Left), DRESS;" "Ready, FRONT;"** and **"COVER,"** as explained in paragraph 8009.

2. To align the company when in mass formation at a halt, the company commander commands **"Dress Right (Left), DRESS"** or **"At Close Interval, Dress Right (Left), DRESS;" "Ready, FRONT;"** and **"COVER."**

a. At the command **"Dress Right (Left),"** the platoon commander of the base platoon goes to carry sword if so armed.

b. On the command of execution **"DRESS,"** the platoon commander of the base platoon takes one step forward, executes a right flank, moves to a position 1 pace to the right of the right squad leader, executes another right flank and halts 1 pace to the right of the rank of squad leaders. He/she then executes a right face and verifies the alignment of the squad leaders in the same manner as alignment is verified in paragraph 8009. He/she then verifies the alignment of the rest of the company as described in paragraph 8009. (Note: During parades and ceremonies the platoon commander of the base platoon would normally only check the alignment of the 1st, 5th, 9th and 13th (last) rank.) After verifying the alignment of the last rank the platoon commander marches back to the front of the formation 1 pace past the guide. He/she then executes a left flank and moves, by the most direct route, back to his/her position at the head of his/her platoon. The platoon commander then halts, from the oblique, faces right and goes to order sword. When the platoon commander resumes his/her post, the company commander commands **"Ready, FRONT"** and **"COVER."**

3. To align the company when in extended mass formation at a halt, the company commander commands **"Dress Right (Left), DRESS"** or **"At Close Interval, Dress Right (Left), DRESS;" "Ready, FRONT;"** and **"COVER."** Alignment is verified as described in paragraph 9005.2b, above. Except that all platoon commanders move to verify the alignment of their platoons.

4. To align the company when in column, platoons in column, the command is **"COVER."** At that command, the second and following platoons obtain the proper 4-pace distances between platoons and cover on the files of the leading platoon. Each platoon aligns internally as prescribed in paragraph 9009.

5. To align the company when in column of platoons in line at halt, the company commander commands, **"DRESS RIGHT (LEFT)."** At this command, the leading platoon (which is the base platoon) is immediately aligned by its commander who commands, **"Dress Right (Left), DRESS;" "Ready, FRONT;"** and **"COVER."** After the platoon commander of the base platoon has given the command to align the platoon, the remaining platoon commanders in succession from front to rear give the command to align their platoons. Platoon commanders follow the procedures prescribed in paragraph 8009, and ensure that the guides are covered on the guide of the leading platoon.

9006. BEING IN COLUMN, TO CHANGE DIRECTION

1. Being at a halt or in march while in column, to change direction 90 degrees to the right (left), the company commander orders **"Column Right (Left), MARCH."** On the preparatory command, platoon commanders give the following supplementary commands: leading platoon commander, **"Column Right (Left);"** and remaining platoon commanders, **"Forward,"** if initiated from a halt (**"Continue to March,"** if initiated while marching). On the company commander's command of execution **"MARCH,"** the leading platoon executes a column right (left). Succeeding platoons march forward, and on the commands of their platoon commanders, execute a column right (left) on the same ground as the leading platoon.

2. To execute a 45-degree change in direction, the execution is the same as above, except the command "**Column Half Right (Left), MARCH**" is used. Platoon commanders give appropriate supplementary commands.

3. For slight changes in direction, on the command of the company commander to "**INCLINE TO THE RIGHT (LEFT),**" the guide of the leading platoon changes direction as commanded. Succeeding platoons march forward and change direction on the same ground as the leading platoon. No supplementary commands are given by the platoon commanders.

9007. COMPANY AWARDS FORMATIONS

1. The ceremonies that are normally conducted at the company level are, but not limited to, the following:

- a. Promotions/Advancements
- b. Cadet Awards
- c. Special Recognition

2. The company formation normally used for company ceremonies is the Company in Line.

3. The senior enlisted cadet forms the company in line with those personnel to receive awards, promotions, etc., forming a single rank behind the last squad of the first platoon. (See figure 9-6.) They are arranged in reverse sequence of presentation priority, to ensure that they are presented to the company commander in the appropriate sequence. (e.g., The junior award recipient would be first in line to march out.) The priority sequence will normally be:

- a. Cadet awards.
- b. Promotions/Advancements.
- c. Other certificates

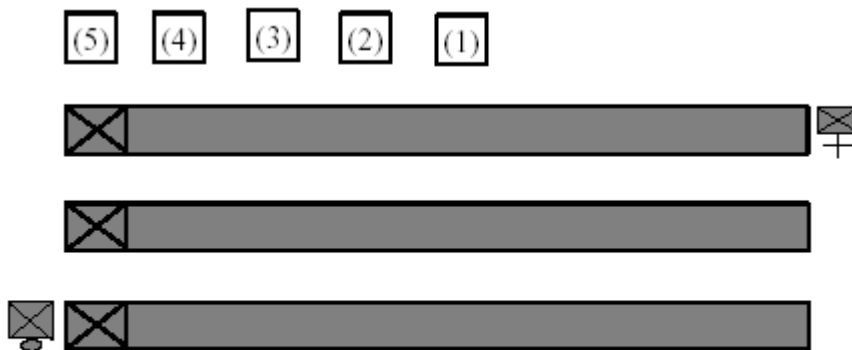

Figure 9-3.--Placing of Award Recipients for the Ceremony.

4. The company is formed as depicted in paragraph 9002. After the senior enlisted cadet receives the report from the mustering petty officers he/she faces about and waits for the company commander to take the formation. The senior enlisted cadet executes a hand salute and reports the company to the company commander. The company commander returns the salute, and commands "**TAKE YOUR POST.**"

a. At this command, rather than taking his/her normal post at the rear of the company, the senior enlisted cadet will step off in the left oblique and march around the commander's right, and continuing to march until he/she has positioned himself/herself 1 pace to the left and 1 pace to the rear of the company

commander. (See figure 9-7.) Platoon commanders take their post centered on their platoons, mustering petty officers post as shown in figure 9-7 and the guidon bearer takes 3 paces forward.

b. The senior enlisted cadet will then command "**cadets to Receive Awards (be Promoted, Reenlisted, etc.), Center, MARCH.**"

(1) On the command of "**Center,**" the cadets receiving awards execute a right face.

(2) On the command "**MARCH,**" the award recipients will step off and continue to march until they have cleared the guide of the first platoon. The senior cadet receiving an award will then command "**Column Left, MARCH.**" (See figure 9-7.)

(3) They will continue to march to a position that places them at a point half way between the line of platoon commanders and the company commander. The senior cadet will then command "**Column Left, MARCH.**"

(4) They will continue to march on this line until the rank of award recipients is centered on the company commander, at which time the senior cadet will command "**Mark Time, MARCH;" "Detail, HALT;" "Right, FACE;" and "Hand, SALUTE.**" (See figure 9-7.)

c. After the commander has returned the salute, the senior cadet will then command "**Ready, TWO.**"

5. The senior enlisted cadet or narrator, if one is used, will then read the first citation or warrant. The commander and the senior enlisted cadet will then step off and march directly to the first cadet and halt, so the commander is directly in front. The senior enlisted cadet will pass the award or warrant to the commander who will then present it to the cadet. After the cadet receives his/her citation the commander and the senior enlisted cadet will face to the right as in marching, and march until the commander is in front of the next cadet, halt, and execute a left face. The senior enlisted cadet or narrator will read the next citation and the commander will present it. They will continue until the last award or citation is presented. They will then face to the right as in marching, and march in the most direct route to their original positions.

6. Once the company commander and senior enlisted cadet are back in position, the senior enlisted cadet will then command "**POST.**" On the command "**POST,**" the senior cadet will command "**Hand, SALUTE.**" The entire detail will execute. After the commander returns the salute, the senior cadet commands "**Ready, TWO**" followed by "**Left, FACE.**"

7. The senior enlisted cadet then commands "**Forward, MARCH.**" On the command of execution "**MARCH,**" the award recipients under the command of the senior cadet will march forward until they are at a position past the mustering petty officer of the last platoon and command "**Column Left, MARCH.**" They will continue to march until they are 1 pace past the last rank of the last platoon, the senior cadet will then command "**Column Left, MARCH.**" They will continue to march to a position behind the last rank. The senior cadet will then command "**Mark Time, MARCH;" "Detail, HALT;" "Left, FACE.**" (See figure 9-7.)

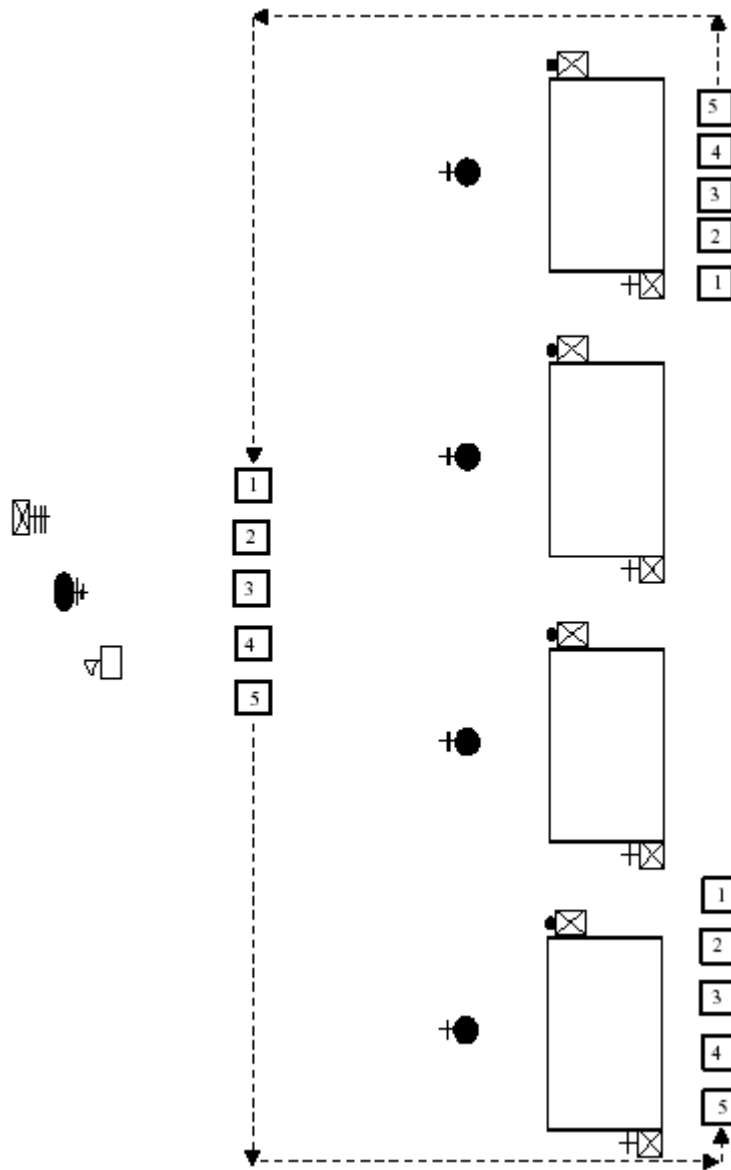

Figure 9-4.--Movements of the Award Recipients.

8. This completes the ceremony. The company commander would then dismiss the company, turn the unit over to the senior enlisted cadet, or carry out the plan of the day.

9. When promoting a number of cadets to the same grade, it is appropriate to read only one warrant, inserting all of the names of the cadets being promoted/advanced at the appropriate place. However, one warrant is read for each grade being promoted (e.g., one warrant read for the two petty officers 2nd class, another warrant read for the five seamen, etc.)

Appendix A

Rifle Manual for all Service Rifles used by the NJROTC Units



Start Order Arms from
Left Shoulder Arms

a.

b.



c.

d.

Order Arms

Figure A-2.- Order Arms from Left Shoulder Arms

Rifle Manual For all Service Rifles used by the NJROTC Units



Start Left Shoulder Arms From
Right Shoulder Arms



a.



b.



c.



Order Arms

Figure A-3.— Left Shoulder Arms from Right Shoulder Arms.

Appendix B

INDIVIDUAL/ TIME	COMMANDS	ACTIONS
<p>10:15 SHARP</p> <p>ADJUTANT</p>	<p>SOUND ATTENTION</p> <p>SOUND ADJ'S CALL</p>	<p>Co CDR's will call their companies to attention (in sequence from front to rear. "If armed" company will be given "Right Shoulder ARMS."</p> <p>Music will start: Forward March will be given to start the march on.</p> <p>Adjutant then takes his/her post ½ way between the COT and the Line of Company's</p>
<p>COMPANY CDR'S</p>	<p>LEFT TURN, MARCH</p>	<p>Companies will march until they reach their designated spot on the parade field. At the CMD "Left Turn MARCH," the entire company will execute a "Left Turn." Co commander will command "Guide Off Right Platoon on Line." At this time the right guide will post. The company will guide on the "Right Guide." When the company nears their position, the "CO" will command "Mark Time, MARCH," "Company, HALT." If armed, command Order Arms. Company commander then will face the reviewing officer.</p>
<p>COT</p>	<p>Staff, "FORWARD MARCH"</p>	<p>COT and Staff march on at the first note of the music, and take their position.</p>
<p>ADJ</p>	<p>PARADE, REST Company Commander's Echo Command</p>	<p>ADJ Commands Parade, Rest once all Company's are in their designated position on the parade field.</p>
<p>MCPO Battalion Commander</p> <p>Boatswain Side Buoys</p>	<p>"Senior Naval Science Instr., arriving" "Inspecting Officer, arriving" "Union Grove, H.S., arriving"</p>	<p>4 bell by MCPO for each VIP BN CO announces arrival of VIP's Boatswain's whistles arrival Side Buoys render salute</p>
<p>ADJ</p>	<p>Battalion, "ATTENTION" "DRESS THE BATTALION"</p>	<p>Company Commanders "Render Present Arms" and "Aye Aye, Sir/Ma'am then Face About</p>
<p>COMPANY COMMANDERS</p>	<p>AT CLOSE INTERVAL, DRESS RIGHT DRESS "In Sequence"</p>	<p>Company Command's will step off as in Marching and align the Company. Only align 1st, 3rd, and 5th rank. ONCE ALL CO'S ARE IN FRONT OF THEIR COMPANY'S: READY FRONT, COVER...(In sequence) CO's then step off and return to their position.</p>

ADJ	"MARCH ON THE COLORS"	Colors will be trooped in from the Left Flank. When Colors reach mid-field they will execute a Left Turn and Halt. Company Commanders will command "Present Arms" as Colors march in front of their Company.
BATTALION COMMANDER	Ladies and Gentlemen please rise for the Marching on of the Colors, Remain Standing for the playing of the National Anthem and the Invocation	
ADJ	"PRESENT, ARMS"	The Battalion executes Present, Arms. The Color Guard executes Present Colors from the Carry. National Anthem played at this time.
ADJ	"ORDER, ARMS" <i>INVOCATION IS GIVEN</i>	Battalion executes Order Arms, Colors execute Carry Colors
ADJ	"POST THE COLORS"	Colors execute "Counter-march" and take their position in the Line of Company's
ADJ	"PARADE, REST" "SOUND - OFF"	The Battalion goes to Parade Rest The band plays
ADJ	"Battalion, ATTENTION" "PRESENT, ARMS"	The battalion executes attention and present arms. The color guard riflemen execute present arms and the colors go to carry colors.
ADJ	ADJ salutes and reports: "SIR / MAAM, THE PARADE IS FORMED"	
COT	"TAKE YOUR POST, SIR "	The ADJ returns to carry sword and marches by the most direct route to the designated post in the staff, halts, faces the line of troops and goes to order sword.
COT	Commands just loud enough for the staff to hear "Draw Swords". The staff will go to "order swords"	
COT	ORDER...ARMS!! RIGHT, FACE LEFT, FACE ABOUT, FACE ABOUT, FACE PARADE, REST "Battalion, ATTENTION	Exercise the Battalion.
COT	"RECEIVE THE REPORT, SIR / MAAM	The adjutant goes to carry sword and marches to position 3 paces in front of the COT and facing the line of troops.
ADJ	"REPORT"	Company Commanders, in sequence, from right to left salute the adjutant and report: "Sir / Maam ____ Company All Present or Accounted For."
ADJ	Salutes and Reports to the COT "Sir / Maam" All Present or Accounted For	

COT	COT returns the salute and commands, "PUBLISH THE ORDER, SIR"	
ADJ		"ATTENTION TO ORDERS" Thursday, 23 October 2003, Union Grove Naval Junior Reserve Officer's Training Corps holds its Annual Military Inspection. VIP's include: Dr. Parish, Supt. Henry Co. Schools; Mr. Hudalla, Chairman of the Henry Co. School Board; Mr. Bowler, Principal UGHS. Inspecting Officer, Capt. Holbrook, Commanding Officer, Ga. Tech NROTC Unit.
ADJ	"OFFICERS.....CENTER.....MARCH"	"OFFICER" - the Company Commanders and Platoon Commanders go to carry sword if armed. All Guide-Ons go to the carry. "CENTER" - Company Commanders and Guides face left/right towards the center of the parade. Platoon Commanders take one step forward, halt and then face left/right. Platoon Guides face left/right with their Platoon Commander. "MARCH" - Key Personnel march to the center of the parade field. Adj marches back to his position in the staff. The band plays on the command of "march"
SENIOR OFFICER	"OFFICER'S.....CENTER.....FACE FORWARD...MARCH"	Once all Key Personnel are in place the Senior Officer Commands; Center, Face and Forward, March.
SENIOR OFFICER	"OFFICER'S....HALT"	Key Personnel Halt and Salute. If armed with sword - present sword, Not armed - hand salute Guides - present guideon <u>THIS SALUTE IS EXECUTED IN A 4 - COUNT MOVEMENT</u>
COT	Returns Key Personnel's Salute	
COT	"CARRY - SWORDS"	CARRY - Swords execute Order Sword, Guideon execute first count of carry guideon. SWORDS - Key Personnel execute carry swords and guideon
COT	"POST - MARCH"	POST - Key Personnel execute "about face" MARCH - Key Personnel return to the center of the Line of Troops.

SENIOR OFFICER	"OFFICER...HALT" "POST...MARCH"	Key Personnel Halt POST - Key Personnel face left/right MARCH - Key Personnel step off in pairs starting from the outside. Each Plt Cdr and Gd will step off in counts of four (4) "count will be; step, 2, 3, 4, step...etc) Company Cdr's execute same movements. MUSIC STOPS WHEN ALL KEY PERSONNEL ARE FACING THE REVIEWING STANDS.
COT	"BOX THE STAFF"	The adjutant boxes the staff with the following commands: "Staff, carry, sword" "Staff, left, face" "Staff, Column Right, March" second Column Right is done without commands. Mark Time March/Staff Halt/Facing Movement
COT	"PARADE, REST" **at this time members of the Drill Team should go to the rear of the Battalion and form for routine.**	Armed Exhibition Team performs; ___ Regulation Drill Routine ___ Exhibition Drill Routine *** Team Cdr's change as needed.
	***During the Drill Routine, Personnel receiving awards or recognition should form up in the rear of the Battalion in a single line.	
COT	"Battalion...ATTENTION" "Cadets to receive Awards and Promotions... Center....March"	On CENTER.... Awardees face to the Right On MARCH... Awardees step off as in marching
AWARDEES	Senior Cadet commands; Hand Salute. Once the salute has been returned.. they then command...Ready, Two	
SNSI Inspecting Officer Battalion CO	SNSI and the Inspecting Officer will depart the Reviewing Stand to present awards and promotions. The Battalion CO will read any and all special awards, and announce any promotions.	
AWARDEES	Once all awards have been presented the Senior Cadet will command; Hand Salute, once the salute has been returned they will then command, Ready, Two, LEFT, FACE & FORWARD, MARCH	Once all Awardees have returned to the rear of the Battalion, the Senior Cadet will command; LEFT, FACE & FALL OUT. The awardees will return to their plt's.
INSPECTING OFFICER	HONOR PLATOON RECOGNIZED	Plt Cdr and Gd from the Honor Plt will march forward and halt apprx. 6 paces from the Inspecting Officer. The plt cdr will command present arms. The Insp. Officer will place "streamer" on the guide on. Plt

		Cdr will command Order, Arms, about face. They will return to their position in the Battalion.
COT	"PARADE, REST"	
INSPECTING OFFICER	INSPECTING OFFICER'S COMMENTS	
BATTALION CO	"PASS - IN - REVIEW"	
COT	"Battalion...ATTENTION" "CARRY, SWORDS"	
PLATOON COMMANDER'S	"COLUMN OF THREE'S RIGHT PLATOON, COLUMN RIGHT, MARCH"	Each Platoon Commander will command his/her platoon. This will be done in sequence starting with "Alpha One, then Alpha Two, the Bravo One, etc....."
COMPANY COMMANDERS AND GUIDEON	"FORWARD, MARCH" "COLUMN RIGHT, MARCH" "COLUMN LEFT, MARCH"	
COLOR GUARD	"RIGHT TURN, MARCH" "FORWARD, MARCH" "LEFT TURN, MARCH" "LEFT TURN, MARCH"	
	"EYES, RIGHT" "READY, FRONT"	
BATTALION COMMANDER	C/CDR JEREMEY DRENNAN	
C.O.T.	C/LCDR SOLIS	
ADJUTANT	C/LT ZACH CHERRY	
"ALPHA" COMPANY		GUIDE:
"A" - 1		GUIDE:
"A" - 2		GUIDE:
"BRACO" COMPANY		GUIDE:
"B" - 1		GUIDE:
"B" - 2		GUIDE:
"CHARLIE" COMPANY		GUIDE:
"C" - 1		GUIDE:

"C" - 2		GUIDE :
"DELTA" COMPANY		GUIDE :
"D" - 1		GUIDE :
"D" - 2		GUIDE :
"ECHO" COMPANY		GUIDE :
"E" - 1		GUIDE :
"E" - 2		GUIDE :

12. Appendix (C) addition

Procedures, if required at Joint/ multiple Drill Meets. Insert as Appendix C: DM-146.

Over the years, we have had several requests for a standard way to Case and Uncase Colors. Many units participate in multiple joint service drill meets that require them to case and uncase Colors as part of their Color Guard routine. Units have asked that a copy of the Army procedures for casing and uncasing Colors be added to our Drill Manual. Add the procedures listed below as appendix DM-146.

FM 3-21.5 Army Drill and Ceremony

15-6. CASING AND UNCASING THE COLORS

Use the following procedures to case and uncase the Colors.

a. The Color guard forms in a line formation with the cased Colors at the *Carry Position (Order Position* when indoors). The command sergeant major (or his direct representative) positions himself six steps in front of and centered on the formation. He then commands ***Sling, ARMS.***

(1) The Color guards immediately adjust their slings and assume *Sling Arms*. The command sergeant major commands **POST**. The Color guards face to the *Half Left (Right)* in marching, take four steps, halt, and execute *About Face*.

(2) The command sergeant major then directs **UNCASE THE COLORS**. The Color bearers lower the Colors (same as *Present Guidon*). The two guards move forward and untie and uncase the Colors. The Color bearers unfurl and immediately return the Colors to the *Carry (Order) Position*. While the Colors are being unfurled, the guards fold the cases and secure them in their left hand.

(3) When the Colors are in the *Carry Position*, the command sergeant major commands ***Present, ARMS.*** The command sergeant major, Color guards, and the organizational Color salute.

(4) The command sergeant major commands ***Order, ARMS,*** and then commands **POST**. On the command of execution **POST**, the Color guards place the folded canvas cases inside the cartridge belts (center rear) of the Color bearers. The Color guards assume their original positions, adjust their slings, and return to *Right Shoulder Arms*.

(5) If the command sergeant major or his representative is not present, the senior Color sergeant gives the necessary commands.

b. **To case the Colors,** the procedures are basically the same except *Present Arms* is given before the Colors are lowered.

c. When casing or uncasing the Colors with the command present, the commander directs **UNCASE (CASE) THE COLORS**. The command sergeant major and Color guards execute the movement (as previously stated) except that they execute *Present Arms* and *Order Arms* with the Color company. When the Colors are uncased and returned to the *Carry Position*, the commander directs **BRING YOUR UNITS TO PRESENT ARMS**. After the units have executed this directive, he then directs **BRING YOUR UNITS TO ORDER ARMS**.

d. If the Colors are to be cased or uncased during the receiving or dismissing by the Color company, the Color guards execute *Present Arms* and *Order Arms* on command of the company commander.

e. The command sergeant major uncases the organizational Color when it is displayed by itself. He may also assist the Color guards when uncasing more than two Colors.