

# math madness!

## 1st Grade



**Fact Fluency**  
Add & Subtract within 10

15.  $9 - 2 =$

16.  $5 + 4 =$

17.  $4 + 4 =$

18.  $8 - 6 =$

19.  $5 - 5 =$

**Count Up the Points!**  
Relating Counting to Addition

Count up the number line to add.

11.  $3 + 6 =$

12.  $7 + 2 =$

**Take it Away!**  
Relating Counting to Subtraction

Count back on the number line to subtract.

11.  $13 - 4 =$

12.  $17 - 2 =$

13.  $14 - 1 =$

14.  $16 - 3 =$

15.  $19 - 5 =$

**Fact Teams**  
Related Facts

Finish the fact family.

8

$5 + 3 = 8$

$6 + 2 = 4$

$4 + 1 = 5$

11.  $13 - 4 =$

12.  $17 - 2 =$

13.  $14 - 1 =$

14.  $16 - 3 =$

15.  $19 - 5 =$

**Fact Teams**  
Related Facts

Finish the fact family.

9

$7 + 2 = 9$

$4 + 1 = 5$

11.  $13 - 4 =$

12.  $17 - 2 =$

13.  $14 - 1 =$

14.  $16 - 3 =$

15.  $19 - 5 =$

**Time Out!**  
Time to the Hour & Half-Hour

Draw hands on the clock face.

1. 5:00

2. 8:00

3. 1:30

4. 4:30

5. 11:00

6. 1:30

## Common Core Math Review

## Practice Sheets

6 Pages





# Fact Fluency

Add & Subtract within 10

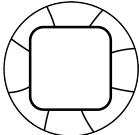
1.  $4 + 3 =$  

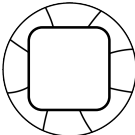
8.  $5 + 5 =$  

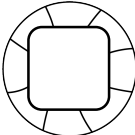
15.  $9 - 2 =$  

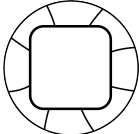
2.  $2 + 2 =$  

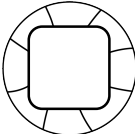
9.  $10 - 6 =$  

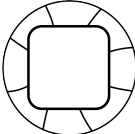
16.  $5 + 4 =$  

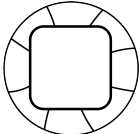
3.  $6 - 3 =$  

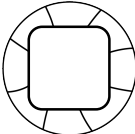
10.  $9 - 8 =$  

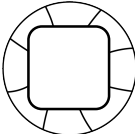
17.  $4 + 4 =$  

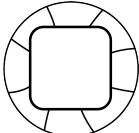
4.  $8 + 1 =$  

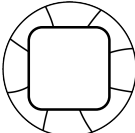
11.  $3 + 6 =$  

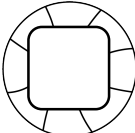
18.  $8 - 6 =$  

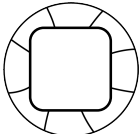
5.  $9 - 5 =$  

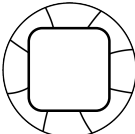
12.  $7 + 2 =$  

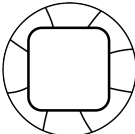
19.  $5 - 5 =$  

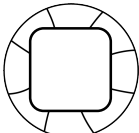
6.  $10 - 4 =$  

13.  $7 - 5 =$  

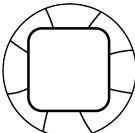
20.  $4 + 2 =$  

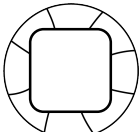
7.  $6 + 2 =$  

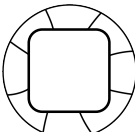
14.  $9 + 1 =$  

21.  $7 - 6 =$  

Name \_\_\_\_\_ Date \_\_\_\_\_

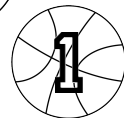

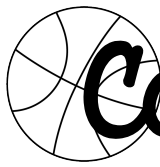

# Count Up the Points!

Relating Counting to Addition

1.OA.5



Count up the number line to add.

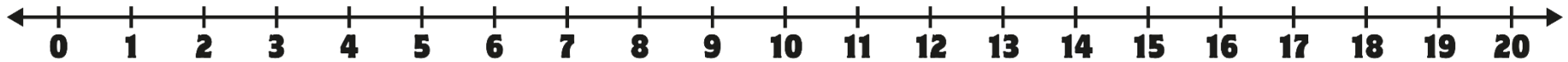

1.  $15 + 3 =$

6.  $10 + 4 =$

11.  $13 + 6 =$

2.  $12 + 4 =$

7.  $6 + 6 =$

12.  $7 + 7 =$

3.  $16 + 2 =$

8.  $12 + 5 =$

13.  $11 + 5 =$

4.  $18 + 1 =$

9.  $11 + 6 =$

14.  $9 + 8 =$

5.  $9 + 5 =$

10.  $13 + 5 =$

15.  $12 + 2 =$

Name \_\_\_\_\_ Date \_\_\_\_\_

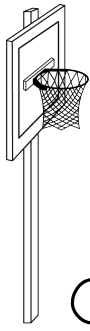

# Take it Away!

Relating Counting to Subtraction

1.OA.5



Count back on the number line to subtract.

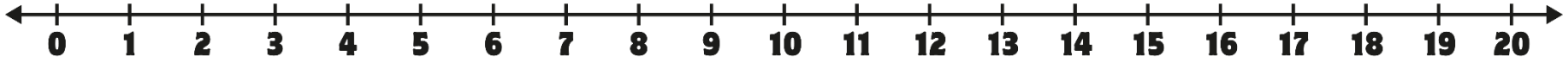

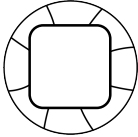
1.  $18 - 3 =$  

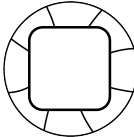
6.  $14 - 3 =$  

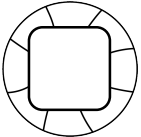
11.  $13 - 4 =$  

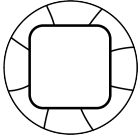
2.  $12 - 8 =$  

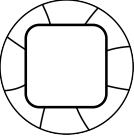
7.  $16 - 4 =$  

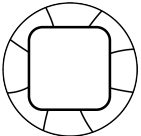
12.  $17 - 2 =$  

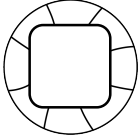
3.  $15 - 4 =$  

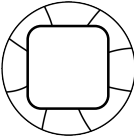
8.  $12 - 3 =$  

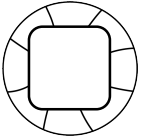
13.  $14 - 1 =$  

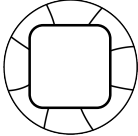
4.  $18 - 6 =$  

9.  $11 - 5 =$  

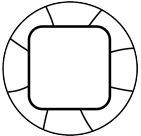
14.  $16 - 3 =$  

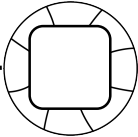
5.  $20 - 2 =$  

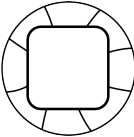
10.  $18 - 1 =$  

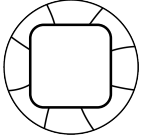
15.  $19 - 5 =$  

Name \_\_\_\_\_ Date \_\_\_\_\_



# Fact Teams

Related Facts

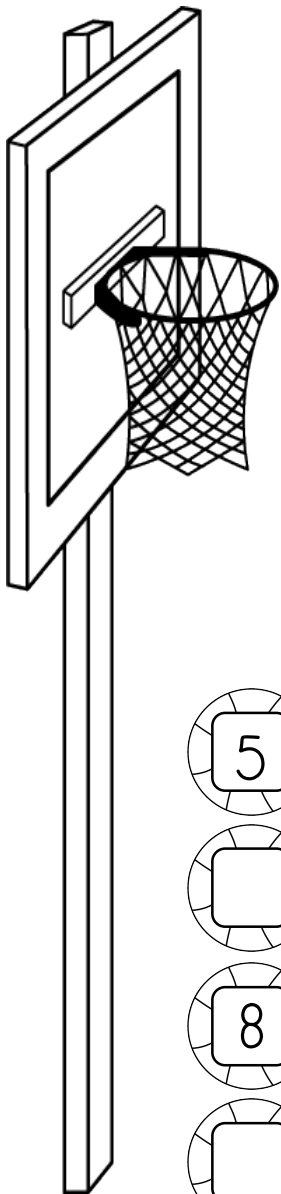

Finish the fact family.



$$\begin{array}{c} \text{5} + \text{3} = \text{8} \\ \square + \square = \square \\ \text{8} - \square = \square \\ \square - \text{3} = \square \end{array}$$

$$\begin{array}{c} \square + \text{2} = \square \\ \square + \square = \square \\ \text{6} - \text{2} = \text{4} \\ \square - \text{4} = \square \end{array}$$

$$\begin{array}{c} \square + \square = \square \\ \text{4} + \text{1} = \text{5} \\ \square - \square = \text{1} \\ \text{5} - \square = \square \end{array}$$

Name \_\_\_\_\_ Date \_\_\_\_\_



# Fact Teams

Related Facts

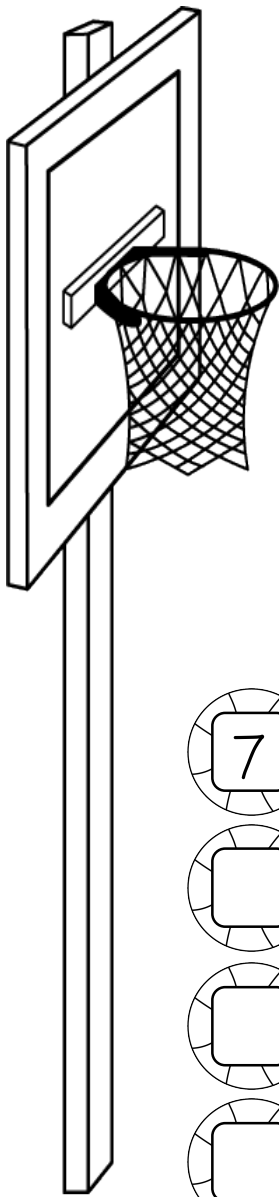
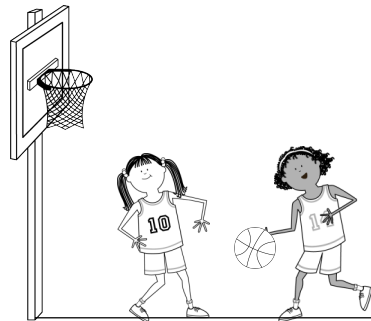

Finish the fact family.



$$\begin{array}{l} \text{7} + \text{2} = \text{9} \\ \square + \square = \square \\ \square - \square = \square \\ \square - \square = \square \end{array}$$

$$\begin{array}{l} \square + \square = \square \\ \square + \square = \square \\ \text{7} - \text{3} = \text{4} \\ \square - \square = \square \end{array}$$



$$\begin{array}{l} \square + \square = \square \\ \text{2} + \text{8} = \text{10} \\ \square - \square = \square \\ \square - \square = \square \end{array}$$

Name \_\_\_\_\_ Date \_\_\_\_\_





# Time Out!

Time to the Hour & Half-Hour

Draw hands on the clock face.

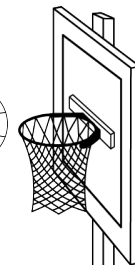

1. 5:00

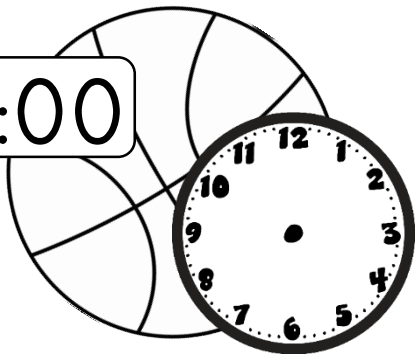

4. 4:30

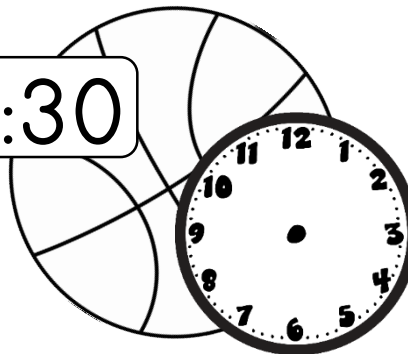

2. 2:30

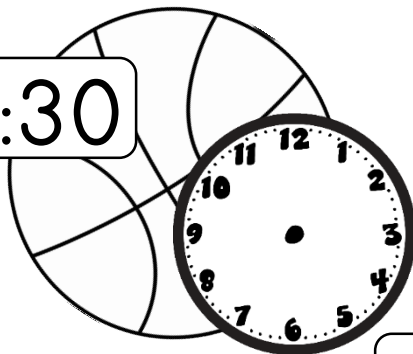

5. 11:00

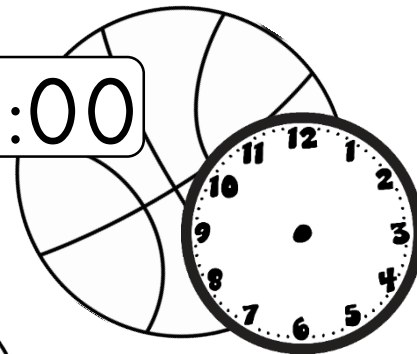

3. 8:00

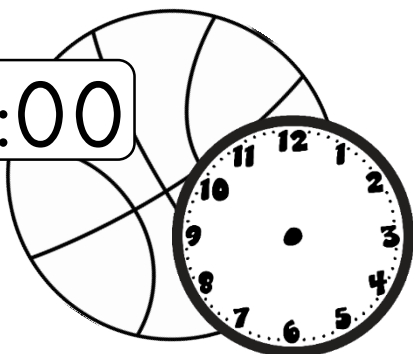

6. 1:30

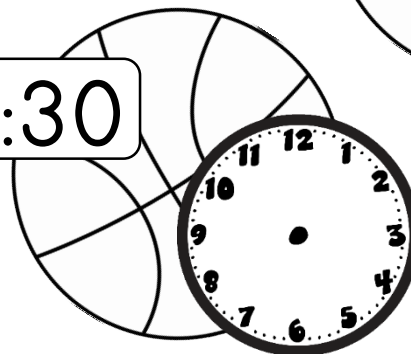

Name \_\_\_\_\_ Date \_\_\_\_\_



# Thank You!

Thank you for downloading my product!  
Check back often for more products & freebies.

<http://www.teacherspayteachers.com/Store/Brandy-Owens>

[brandy.owens@outlook.com](mailto:brandy.owens@outlook.com)

E-mail with questions or product requests.

Fonts by [Cara Carroll](#) and [Kimberly Geswein](#)

Graphics, Frames, Backgrounds:

