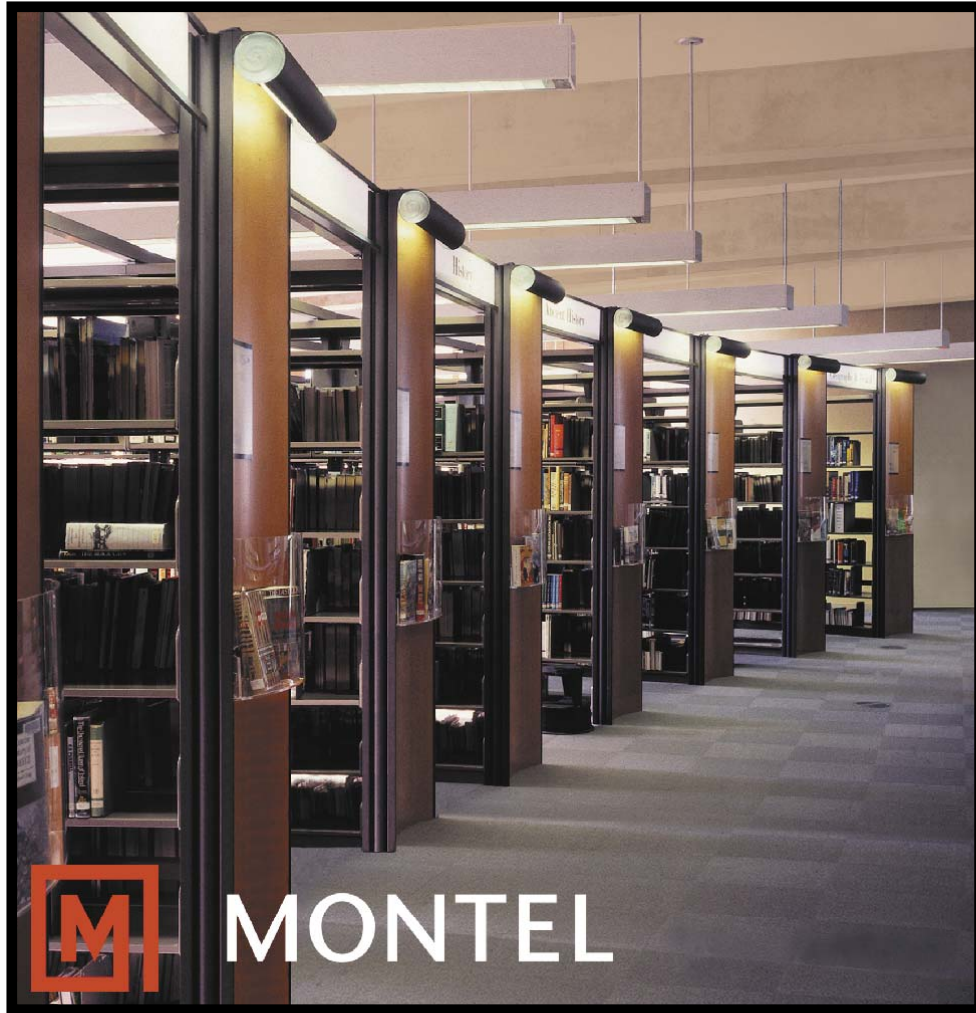


AETNASTAK

Cantilever Shelving



Phone : **418-248-0235**
Fax : **418-248-7266**
Toll Free : **800-935-0235**
E-Mail : **system@montel.com**
Web : **www.montel.com**

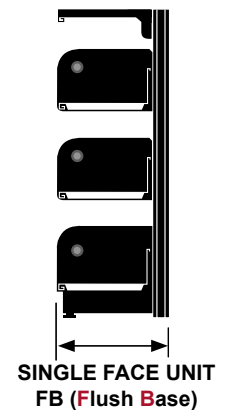
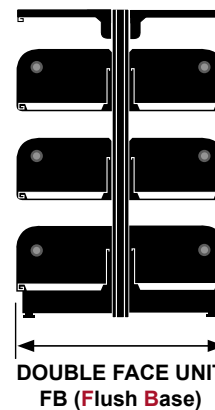
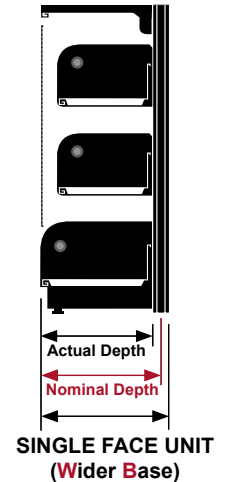
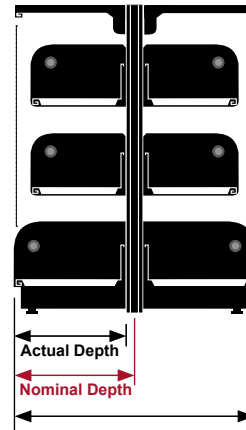
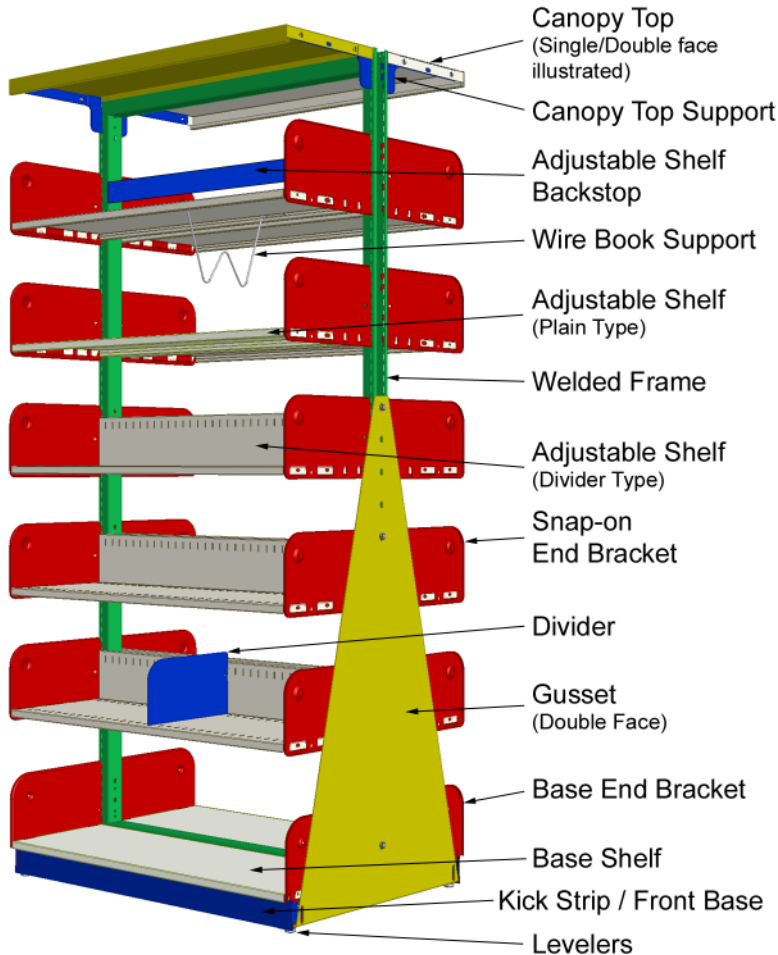


MONTEL
The Intelligent Use of Space

Bookstack Assembly_____	AE/3
Shelves spacing explanation_____	AE/4
Personal notes_____	AE/5
Assembly with plain shelves_____	AE/6-AE/9
Assembly with slotted shelves_____	AE/10-AE/13
Assembly with fixed and hinged periodical shelving_____	AE/14
Assembly with sloped display shelving_____	AE/15
Periodical display cabinet_____	AE/15
T-Base units_____	AE/16-AE/17
Patterned/Textured steel front or end panels_____	AE/18-AE/23
Canopy tops_____	AE/24
Wall column & welded frame_____	AE/25
Welded frame and gusset for seismic zone_____	AE/26
Shelves_____	AE/27-AE/30
Speciality shelves_____	AE/31-AE/35
Speciality shelves and accessories_____	AE/36-AE/37
Accessories_____	AE/38-AE/42
Electrical accessories_____	AE/43
Booktrucks_____	AE/44

ACTUAL VS NOMINAL DIMENSIONS

Please notice that dimensions in this catalog are either **actual** or **nominal**. For library **nominal** dimensions, add 1" to the **actual** depth.



- Actual Depth** _____ Real depth dimension
- Adjustable Shelf** _____ Shelf with **SNAP-ON END BRACKETS**
- Adjustable Shelf (Divider Type)** _____ Slotted shelves with **SNAP-ON END BRACKETS** to accomodate **DIVIDERS**
- Adjustable Shelf BackStop** _____ Adjustable backstop be used with plain shelves
- Base End Bracket** _____ Brackets supporting **BASE SHELF**
- Base Shelf** _____ Shelf with **BASE END BRACKETS**, **KICK STRIP** and **LEVELERS**
- Canopy Top** _____ Top shelf with **CANOPY TOP SUPPORTS** (included)
- Canopy Top Support** _____ Brackets supporting **CANOPY TOP**
- Divider** _____ Adjustable partition
- Double Face Unit** _____ Unit with shelves on both sides
- Gusset** _____ If reinforcement is required
- Kick Strip / Front Base** _____ Front base (standard black color)
- Levelers** _____ Adjustable leveling feet (included with each unit)
- Nominal Depth** _____ Depth from the center of the **VERTICAL UPRIGHT** to the shelf front edge
- Single Face Unit** _____ Unit with shelves on one side
- Snap-on End Bracket** _____ Brackets supporting **ADJUSTABLE SHELF**
- Welded Frame** _____ One **UPRIGHT FRAME** with cross members welded together
- Wire Book Support** _____ Adjustable book support underneath shelf

SHELVES SPACING EXPLANATION

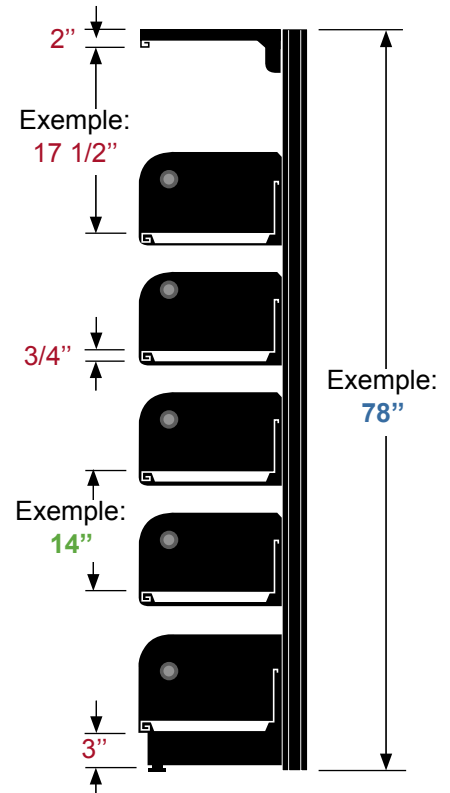
Required information to calculate distance between shelves :

- Aetnastak shelves are 3/4" thick and have 4-bend
- **Welded Frames** are slotted at every 1" increments for shelves adjustment
- Allow a minimum of 7 1/4" between shelves or 8" c/c (because of the **snap-on end brackets**)
- Allow 2" under an adjustable shelf for a **reference shelf**
- Allow 3" at the base for a **front base**
- Allow 2" at the top of the **welded frame** for a **canopy top**

To determine the number of available shelving levels :

1. Desired distance between shelf center **14"** (or **13 1/4" clear**)
2. Height of frame **78"** (**78" - 3"** (base), (**75" - 2"** (top) / **14"** = **5.21 = 5 levels of storage**)
3. (**78" - 3"** (base), (**75" - 2"** (top) - (5 x **14"**) = **3"** which can be used anywhere

TYPICAL HEIGHTS FOR AETNASTAK SHELVING UNITS (with kick strip, with canopy top)			
Frame height	Qty levels of storage	Dist. from shelf surface to shelf surface	Space left in shelving unit
42"	3	12"	1"
48"	3	14"	1"
66"	5	12"	1"
78"	6	12"	1"
84"	7	11"	2"
90"	7	12"	1"



ASSEMBLY WITH PLAIN SHELVES

Single face

AETNASTAK

Shelf and base are **NOMINAL** dimensions
 Panel and top are **ACTUAL** dimensions

CODE #	W	Adj. Shelf D	Base Shelf D	H	Not included		lbs	\$
					Panel D	Lower Top D		
2 ADJUSTABLE SHELVES AND 1 BASE SHELF								
L423608FB	36	8	8	42	9 3/8	9 7/32	44.4	\$170.00
L423608	36	8	10	42	11 3/8	11 7/32	46.8	\$174.00
L423609FB	36	9	9	42	10 3/8	10 7/32	48.0	\$175.00
L423609	36	9	10	42	11 3/8	11 7/32	49.2	\$178.00
L423610FB	36	10	10	42	11 3/8	11 7/32	51.6	\$181.00
L423610	36	10	12	42	13 3/8	13 7/32	54.0	\$183.00
L423611FB	36	11	11	42	12 3/8	12 7/32	55.2	\$183.00
L423612FB	36	12	12	42	13 3/8	13 7/32	58.8	\$192.00
L423613FB	36	13	13	42	14 3/8	14 7/32	62.4	\$204.00
2 ADJUSTABLE SHELVES AND 1 BASE SHELF								
L483608FB	36	8	8	48	9 3/8	9 7/32	45.6	\$173.00
L483608	36	8	10	48	11 3/8	11 7/32	48.0	\$176.00
L483609FB	36	9	9	48	10 3/8	10 7/32	49.2	\$177.00
L483609	36	9	10	48	11 3/8	11 7/32	50.4	\$179.00
L483610FB	36	10	10	48	11 3/8	11 7/32	52.8	\$182.00
L483610	36	10	12	48	13 3/8	13 7/32	55.2	\$188.00
L483611FB	36	11	11	48	12 3/8	12 7/32	56.4	\$188.00
L483612FB	36	12	12	48	13 3/8	13 7/32	60.0	\$193.00
L483613FB	36	13	13	48	14 3/8	14 7/32	63.6	\$198.00
4 ADJUSTABLE SHELVES AND 1 BASE SHELF								
L663608FB	36	8	8	66	9 3/8	9 7/32	63.6	\$230.00
L663608	36	8	10	66	11 3/8	11 7/32	66.0	\$235.00
L663609FB	36	9	9	66	10 3/8	10 7/32	69.6	\$239.00
L663609	36	9	10	66	11 3/8	11 7/32	70.8	\$241.00
L663610FB	36	10	10	66	11 3/8	11 7/32	75.6	\$248.00
L663610	36	10	12	66	13 3/8	13 7/32	78.0	\$250.00
L663611FB	36	11	11	66	12 3/8	12 7/32	81.6	\$250.00
L663612FB	36	12	12	66	13 3/8	13 7/32	87.6	\$266.00
L663613FB	36	13	13	66	14 3/8	14 7/32	93.6	\$287.00

42" HIGH

48" HIGH

66" HIGH



Illustration to be used as a reference only

Notes :

- All single face units must be anchored to the wall (wall anchor included)
- 24" and 30" widths are available at the same price
- Substitute 24 or 30 within code number when required
- To order front or end panels, refer to "Panel D" (see page **AE/18 to AE/23**) and choose the appropriate panel code
- To order canopy top, refer to "Lower top D" (see page **AE/24**) and choose the appropriate top code

AE/6

ASSEMBLY WITH PLAIN SHELVES

Single face

AETNASTAK

Shelf and base are **NOMINAL** dimensions
 Panel and top are **ACTUAL** dimensions

CODE #	W	Adj. Shelf D	Base Shelf D	H	Not included		lbs	\$
					Panel D	Higher Top D		
5 ADJUSTABLE SHELVES AND 1 BASE SHELF								
L783608FB	36	8	8	78	9 3/8	7 7/32	73.2	\$263.00
L783608	36	8	10	78	11 3/8	9 7/32	75.6	\$266.00
L783609FB	36	9	9	78	10 3/8	8 7/32	80.4	\$273.00
L783609	36	9	10	78	11 3/8	9 7/32	81.6	\$275.00
L783610FB	36	10	10	78	11 3/8	9 7/32	87.6	\$283.00
L783610	36	10	12	78	13 3/8	11 7/32	90.0	\$285.00
L783611FB	36	11	11	78	12 3/8	10 7/32	94.8	\$285.00
L783612FB	36	12	12	78	13 3/8	11 7/32	102.0	\$307.00
L783613FB	36	13	13	78	14 3/8	12 7/32	109.2	\$333.00
6 ADJUSTABLE SHELVES AND 1 BASE SHELF								
L843608FB	36	8	8	84	9 3/8	7 7/32	81.6	\$292.00
L843608	36	8	10	84	11 3/8	9 7/32	84.0	\$296.00
L843609FB	36	9	9	84	10 3/8	8 7/32	90.0	\$303.00
L843609	36	9	10	84	11 3/8	9 7/32	91.2	\$306.00
L843610FB	36	10	10	84	11 3/8	9 7/32	98.4	\$316.00
L843610	36	10	12	84	13 3/8	11 7/32	100.8	\$318.00
L843611FB	36	11	11	84	12 3/8	10 7/32	106.8	\$318.00
L843612FB	36	12	12	84	13 3/8	11 7/32	115.2	\$343.00
L843613FB	36	13	13	84	14 3/8	12 7/32	123.6	\$374.00
6 ADJUSTABLE SHELVES AND 1 BASE SHELF								
L903608FB	36	8	8	90	9 3/8	7 7/32	82.8	\$295.00
L903608	36	8	10	90	11 3/8	9 7/32	85.2	\$299.00
L903609FB	36	9	9	90	10 3/8	8 7/32	91.2	\$307.00
L903609	36	9	10	90	11 3/8	9 7/32	92.4	\$310.00
L903610FB	36	10	10	90	11 3/8	9 7/32	99.6	\$320.00
L903610	36	10	12	90	13 3/8	11 7/32	102.0	\$322.00
L903611FB	36	11	11	90	12 3/8	10 7/32	108.0	\$322.00
L903612FB	36	12	12	90	13 3/8	11 7/32	116.4	\$347.00
L903613FB	36	13	13	90	14 3/8	12 7/32	124.8	\$378.00

78" HIGH

84" HIGH

90" HIGH



Illustration to be used as a reference only

Notes :

- All single face units must be anchored to the wall (wall anchor included)
- 24" and 30" widths are available at the same price
- Substitute 24 or 30 within code number when required
- To order front or end panels, refer to "Panel D" (see page **AE/18** to **AE/23**) and choose the appropriate panel code
- To order canopy top, refer to "Higher top D" (see page **AE/24**) and choose the appropriate top code

ASSEMBLY WITH PLAIN SHELVES

Double face

AETNASTAK

Shelf and base are **NOMINAL** dimensions
 Panel and top are **ACTUAL** dimensions

CODE #	W	Adj. Shelf D	Base Shelf D	H	Not included		lbs	\$
					Panel D	Lower Top D		
4 ADJUSTABLE SHELVES AND 2 BASE SHELVES								
L423616FB	36	8	8	42	16 3/4	16 3/8	70.8	\$259.00
L423616	36	8	10	42	20 3/4	20 3/8	75.6	\$266.00
L423618FB	36	9	9	42	18 3/4	18 3/8	78.0	\$271.00
L423618	36	9	10	42	20 3/4	20 3/8	80.4	\$274.00
L423620FB	36	10	10	42	20 3/4	20 3/8	85.2	\$279.00
L423620	36	10	12	42	24 3/4	24 3/8	90.0	\$284.00
L423622FB	36	11	11	42	22 3/4	22 3/8	92.4	\$284.00
L423624FB	36	12	12	42	24 3/4	24 3/8	99.6	\$301.00
L423626FB	36	13	13	42	26 3/4	26 3/8	106.8	\$325.00
4 ADJUSTABLE SHELVES AND 2 BASE SHELVES								
L483616FB	36	8	8	48	16 3/4	16 3/8	72.0	\$262.00
L483616	36	8	10	48	20 3/4	20 3/8	76.8	\$270.00
L483618FB	36	9	9	48	18 3/4	18 3/8	79.2	\$271.00
L483618	36	9	10	48	20 3/4	20 3/8	81.6	\$275.00
L483620FB	36	10	10	48	20 3/4	20 3/8	86.4	\$282.00
L483620	36	10	12	48	24 3/4	24 3/8	91.2	\$286.00
L483622FB	36	11	11	48	22 3/4	22 3/8	93.6	\$286.00
L483624FB	36	12	12	48	24 3/4	24 3/8	100.8	\$304.00
L483626FB	36	13	13	48	26 3/4	26 3/8	108.0	\$315.00
8 ADJUSTABLE SHELVES AND 2 BASE SHELVES								
L663616FB	36	8	8	66	16 3/4	16 3/8	104.4	\$368.00
L663616	36	8	10	66	20 3/4	20 3/8	109.2	\$378.00
L663618FB	36	9	9	66	18 3/4	18 3/8	116.4	\$386.00
L663618	36	9	10	66	20 3/4	20 3/8	118.8	\$390.00
L663620FB	36	10	10	66	20 3/4	20 3/8	128.4	\$403.00
L663620	36	10	12	66	24 3/4	24 3/8	133.2	\$408.00
L663622FB	36	11	11	66	22 3/4	22 3/8	140.4	\$408.00
L663624FB	36	12	12	66	24 3/4	24 3/8	152.4	\$443.00
L663626FB	36	13	13	66	26 3/4	26 3/8	164.4	\$485.00

42" HIGH

48" HIGH

66" HIGH



Illustration to be used as a reference only

Notes :

- 24" and 30" widths are available at the same price
- Substitute 24 or 30 within code number when required
- To order front or end panels, refer to "Panel D" (see page **AE/18 to AE/23**) and choose the appropriate panel code
- To order canopy top, refer to "Lower top D" (see page **AE/24**) and choose the appropriate top code

AE/8

ASSEMBLY WITH PLAIN SHELVES

Double face

AETNASTAK

Shelf and base are **NOMINAL** dimensions
Panel and top are **ACTUAL** dimensions

Not included

CODE #	W	Adj. Shelf D	Base Shelf D	H	Panel D	Hinger Top D	lbs	\$
10 ADJUSTABLE SHELVES AND 2 BASE SHELVES								
L783616FB *	36	8	8	78	16 3/4	7 7/32	121.2	\$426.00
L783616	36	8	10	78	20 3/4	9 7/32	126.0	\$434.00
L783618FB *	36	9	9	78	18 3/4	8 7/32	135.6	\$447.00
L783618	36	9	10	78	20 3/4	9 7/32	138.0	\$451.00
L783620FB *	36	10	10	78	20 3/4	9 7/32	150.0	\$467.00
L783620	36	10	12	78	24 3/4	11 7/32	154.8	\$471.00
L783622FB	36	11	11	78	22 3/4	10 7/32	164.4	\$471.00
L783624FB	36	12	12	78	24 3/4	11 7/32	178.8	\$515.00
L783626FB	36	13	13	78	26 3/4	12 7/32	193.2	\$567.00
12 ADJUSTABLE SHELVES AND 2 BASE SHELVES								
L843616FB *	36	8	8	84	16 3/4	7 7/32	136.8	\$481.00
L843616	36	8	10	84	20 3/4	9 7/32	141.6	\$489.00
L843618FB *	36	9	9	84	18 3/4	8 7/32	153.6	\$503.00
L843618	36	9	10	84	20 3/4	9 7/32	156.0	\$508.00
L843620FB *	36	10	10	84	20 3/4	9 7/32	170.4	\$528.00
L843620	36	10	12	84	24 3/4	11 7/32	175.2	\$533.00
L843622FB	36	11	11	84	22 3/4	10 7/32	187.2	\$533.00
L843624FB	36	12	12	84	24 3/4	11 7/32	204.0	\$585.00
L843626FB	36	13	13	84	26 3/4	12 7/32	220.8	\$646.00
12 ADJUSTABLE SHELVES AND 2 BASE SHELVES								
L903616FB *	36	8	8	90	16 3/4	7 7/32	138.0	\$485.00
L903616	36	8	10	90	20 3/4	9 7/32	142.8	\$493.00
L903618FB *	36	9	9	90	18 3/4	8 7/32	154.8	\$508.00
L903618	36	9	10	90	20 3/4	9 7/32	157.2	\$513.00
L903620FB *	36	10	10	90	20 3/4	9 7/32	171.6	\$531.00
L903620	36	10	12	90	24 3/4	11 7/32	176.4	\$536.00
L903622FB	36	11	11	90	22 3/4	10 7/32	188.4	\$536.00
L903624FB	36	12	12	90	24 3/4	11 7/32	205.2	\$588.00
L903626FB	36	13	13	90	26 3/4	12 7/32	222.0	\$649.00



Illustration to be used as a reference only

Notes :

- * Units with an **asterisk** following the code number must be anchored to the floor or using a top tie strut (see page **AE/26**)
- 24" and 30" widths are available at the same price
- Substitute 24 or 30 within code number when required
- To order front or end panels, refer to "Panel D" (see page **AE/18 to AE/23**) and choose the appropriate panel code
- To order canopy top, refer to "Higher top D" (see page **AE/24**) and choose the appropriate top code

ASSEMBLY WITH SLOTTED SHELVES

Single face

AETNASTAK

Shelf and base are **ACTUAL** dimensions
 Panel and top are **ACTUAL** dimensions

Not included

CODE #	W	Adj. Shelf D	Base Shelf D	H	Panel D	Lower Top D	lbs	\$
2 ADJUSTABLE SHELVES AND 1 BASE SHELF								
S423609FB	36	9	9	42	11 3/8	11 7/32	58.8	\$215.00
S423609	36	9	11	42	13 3/8	13 7/32	61.2	\$219.00
S423610FB	36	10	10	42	12 3/8	12 7/32	62.4	\$222.00
S423611FB	36	11	11	42	13 3/8	13 7/32	66.0	\$230.00
S423612FB	36	12	12	42	14 3/8	14 7/32	67.2	\$238.00
S423613	36	13	15	42	17 3/8	17 7/32	74.4	\$252.00

42" HIGH

2 ADJUSTABLE SHELVES AND 1 BASE SHELF								
S483609FB	36	9	9	48	11 3/8	11 7/32	60.0	\$217.00
S483609	36	9	11	48	13 2/9	13 7/32	62.4	\$221.00
S483610FB	36	10	10	48	12 3/8	12 7/32	63.6	\$224.00
S483611FB	36	11	11	48	13 3/8	13 7/32	67.2	\$232.00
S483612FB	36	12	12	48	14 3/8	14 7/32	70.8	\$240.00
S483613	36	13	15	48	17 3/8	17 7/32	75.6	\$254.00

48" HIGH

4 ADJUSTABLE SHELVES AND 1 BASE SHELF								
S663609FB	36	9	9	66	11 3/8	11 7/32	87.6	\$300.00
S663609	36	9	11	66	13 2/9	13 7/32	90.0	\$305.00
S663610FB	36	10	10	66	12 3/8	12 7/32	94.8	\$313.00
S663611FB	36	11	11	66	13 3/8	13 7/32	99.6	\$325.00
S663612FB	36	12	12	66	14 3/8	14 7/32	105.6	\$339.00
S663613	36	13	15	66	17 3/8	17 7/32	112.8	\$358.00

66" HIGH



Illustration to be used as a reference only
 Dividers not included (See page AE/38)

Notes :

- All single face units must be anchored to the wall (wall anchor included)
- 24" and 30" widths are available at the same price
- Substitute 24 or 30 within code number when required
- Shelves are slotted on 1" centers for dividers and have a 5" high back
- **Dividers not included** (See page AE/38)
- To order front or end panels, refer to "Panel D" (see page AE/18 to AE/23) and choose the appropriate panel code
- To order canopy top, refer to "Lower top D" (see page AE/24) and choose the appropriate top code

AE/10



ASSEMBLY WITH SLOTTED SHELVES

Single face

AETNASTAK

Shelf and base are **ACTUAL** dimensions
 Panel and top are **ACTUAL** dimensions

Not included

CODE #	W	Adj. Shelf D	Base Shelf D	H	Panel D	Higher Top D	lbs	\$
5 ADJUSTABLE SHELVES AND 1 BASE SHELF								
S783609FB	36	9	9	78	11 3/8	9 7/32	102.0	\$346.00
S783609	36	9	11	78	13 2/9	11 7/32	104.4	\$350.00
S783610FB	36	10	10	78	12 3/8	10 7/32	109.2	\$361.00
S783611FB	36	11	11	78	13 3/8	11 7/32	116.4	\$376.00
S783612FB	36	12	12	78	14 3/8	12 7/32	123.6	\$392.00
S783613	36	13	15	78	17 3/8	15 7/32	132.0	\$414.00

78" HIGH

6 ADJUSTABLE SHELVES AND 1 BASE SHELF								
S843609FB	36	9	9	84	11 3/8	9 7/32	115.2	\$376.00
S843609	36	9	11	84	13 2/9	11 7/32	117.6	\$381.00
S843610FB	36	10	10	84	12 3/8	10 7/32	123.6	\$391.00
S843611FB	36	11	11	84	13 3/8	11 7/32	132.0	\$404.00
S843612FB	36	12	12	84	14 3/8	12 7/32	140.4	\$434.00
S843613	36	13	15	84	17 3/8	15 7/32	150.0	\$454.00

84" HIGH

6 ADJUSTABLE SHELVES AND 1 BASE SHELF								
S903609FB	36	9	9	90	11 3/8	9 7/32	116.4	\$392.00
S903609	36	9	11	90	13 2/9	11 7/32	118.8	\$396.00
S903610FB	36	10	10	90	12 3/8	10 7/32	124.8	\$410.00
S903611FB	36	11	11	90	13 3/8	11 7/32	133.2	\$427.00
S903612FB	36	12	12	90	14 3/8	12 7/32	141.6	\$446.00
S903613	36	13	15	90	17 3/8	15 7/32	151.2	\$470.00

90" HIGH



Illustration to be used as a reference only
 Dividers not included (See page AE/38)

- Notes:**
- All single face units must be anchored to the wall (wall anchor included)
 - 24" and 30" widths available are at the same price
 - Substitute 24 or 30 within code number when required
 - Shelves are slotted on 1" centers for dividers and have a 5" high back
 - **Dividers not included** (See page AE/38)
 - To order front or end panels, refer to "Panel D" (see page AE/18 to AE/23) and choose the appropriate panel code
 - To order canopy top, refer to "Higher top D" (see page AE/24) and choose the appropriate top code

ASSEMBLY WITH SLOTTED SHELVES

Double face

AETNASTAK

Shelf and base are **ACTUAL** dimensions
 Panel and top are **ACTUAL** dimensions

Not included

CODE #	W	Adj. Shelf D	Base Shelf D	H	Panel D	Lower Top D	lbs	\$
4 ADJUSTABLE SHELVES AND 2 BASE SHELVES								
S423618FB	36	9	9	42	20 3/4	20 3/8	99.6	\$349.00
S423618	36	9	11	42	23 3/4	23 3/8	104.4	\$358.00
S423620FB	36	10	10	42	22 3/4	22 3/8	106.8	\$364.00
S423622FB	36	11	11	42	24 3/4	24 3/8	114.0	\$379.00
S423624FB	36	12	12	42	26 3/4	26 3/8	121.2	\$396.00
S423626	36	13	15	42	32 3/4	32 3/8	130.8	\$423.00

42" HIGH



4 ADJUSTABLE SHELVES AND 2 BASE SHELVES								
S483618FB	36	9	9	48	20 3/4	20 3/8	100.8	\$351.00
S483618	36	9	11	48	23 3/4	23 3/8	105.6	\$360.00
S483620FB	36	10	10	48	22 3/4	22 3/8	108.0	\$366.00
S483622FB	36	11	11	48	24 3/4	24 3/8	115.2	\$381.00
S483624FB	36	12	12	48	26 3/4	26 3/8	122.4	\$398.00
S483626	36	13	15	48	32 3/4	32 3/8	132.0	\$425.00

48" HIGH



8 ADJUSTABLE SHELVES AND 2 BASE SHELVES								
S663618FB	36	9	9	66	20 3/4	20 3/8	152.4	\$510.00
S663618	36	9	11	66	23 3/4	23 3/8	157.2	\$519.00
S663620FB	36	10	10	66	22 3/4	22 3/8	164.4	\$535.00
S663622FB	36	11	11	66	24 3/4	24 3/8	176.4	\$559.00
S663624FB	36	12	12	66	26 3/4	26 3/8	188.4	\$587.00
S663626	36	13	15	66	32 3/4	32 3/8	202.8	\$625.00

66" HIGH

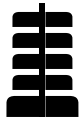


Illustration to be used as a reference only
 Dividers not included (See page AE/38)

Notes :

- 24" and 30" widths are available at the same price
- Substitute 24 or 30 within code number when required
- Shelves are slotted on 1" centers for dividers and have a 5" high back
- **Dividers not included** (See page AE/38)
- To order front or end panels, refer to "Panel D" (see page AE/18 to AE/23) and choose the appropriate panel code
- To order canopy top, refer to "Lower top D" (see page AE/24) and choose the appropriate top code

AE/12

ASSEMBLY WITH SLOTTED SHELVES

Double face

AETNASTAK

Shelf and base are **ACTUAL** dimensions
 Panel and top are **ACTUAL** dimensions

CODE #	W	Adj. Shelf D	Base Shelf D	H	Not included		lbs	\$
					Panel D	Higher Top D		
10 ADJUSTABLE SHELVES AND 2 BASE SHELVES								
S783618FB *	36	9	9	78	20 3/4	18 7/32	178.8	\$593.00
S783618	36	9	11	78	23 3/4	20 7/32	183.6	\$602.00
S783620FB *	36	10	10	78	22 3/4	20 7/32	193.2	\$623.00
S783622FB	36	11	11	78	24 3/4	22 7/32	207.6	\$653.00
S783624FB	36	12	12	78	26 3/4	24 7/32	222.0	\$686.00
S783626	36	13	15	78	32 3/4	28 7/32	238.8	\$729.00

78" HIGH



12 ADJUSTABLE SHELVES AND 2 BASE SHELVES								
S843618FB *	36	9	9	84	20 3/4	18 7/32	204.0	\$649.00
S843618	36	9	11	84	23 3/4	20 7/32	208.8	\$657.00
S843620FB *	36	10	10	84	22 3/4	20 7/32	220.8	\$678.00
S843622FB	36	11	11	84	24 3/4	22 7/32	237.6	\$706.00
S843624FB	36	12	12	84	26 3/4	24 7/32	254.4	\$765.00
S843626	36	13	15	84	32 3/4	28 7/32	273.6	\$804.00

84" HIGH



12 ADJUSTABLE SHELVES AND 2 BASE SHELVES								
S903618FB *	36	9	9	90	20 3/4	18 7/32	205.2	\$677.00
S903618	36	9	11	90	23 3/4	20 7/32	210.0	\$686.00
S903620FB *	36	10	10	90	22 3/4	20 7/32	222.0	\$712.00
S903622FB	36	11	11	90	24 3/4	22 7/32	238.8	\$747.00
S903624FB	36	12	12	90	26 3/4	24 7/32	255.6	\$785.00
S903626	36	13	15	90	32 3/4	28 7/32	274.8	\$833.00

90" HIGH



Illustration to be used as a reference only
 Dividers not included (See page AE/38)

Notes :

- * Units with an **asterisk** following the code number must be anchored to the floor or using a top tie strut (see page **AE/26**)
- 24" and 30" widths are available at the same price
- Substitute 24 or 30 within code number when required
- Shelves are slotted on 1" centers for dividers and have a 5" high back
- Dividers not included** (See page **AE/38**)
- To order front or end panels, refer to "Panel **D**" (see page **AE/18** to **AE/23**) and choose the appropriate panel code
- To order canopy top, refer to "Higher top **D**" (see page **AE/24**) and choose the appropriate top code

ASSEMBLY WITH FIXED & HINGED PERIODICAL SHELVING

AETNASTAK

	CODE #	W	D	H	Qty Sloped Shelves	Qty Plain Shelves	Not included		lbs	\$	
							Panel D	Top D			
SINGLE FACE	FIXED PERIODICAL SHELVING										
	LPF42	36	11	42	2	1	13 3/8	Lower 14 7/32	63.6	\$251.00	
	LPF66	36	11	66	3	2	13 3/8	14 7/32	87.6	\$339.00	
	LPF78	36	11	78	4	3	13 3/8	Higher 14 7/32	109.2	\$426.00	
LPF90	36	11	90	5	4	13 3/8	14 7/32	130.8	\$514.00		
DOUBLE FACE	LPF42DF	36	22	42	4	2	24 3/8	Lower 24 3/8	109.2	\$420.00	
	LPF66DF	36	22	66	6	4	24 3/8	24 3/8	152.4	\$588.00	
	LPF78DF	36	22	78	8	6	24 3/8	Higher 24 3/8	193.2	\$754.00	
	LPF90DF	36	22	90	10	8	24 3/8	24 3/8	234.0	\$920.00	



- Display surface is 11" high
- All units include plain shelves and a base shelf at 11" actual



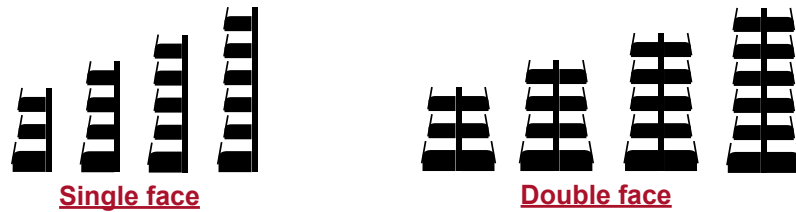
Single face

Double face

	CODE #	W	D	H	Qty Sloped Shelves	Qty Plain Shelves	Not included		lbs	\$	
							Panel D	Top D			
SINGLE FACE	HINGED PERIODICAL SHELVING										
	LPH42-2	36	11	42	2	2	13 3/8	Lower 14 7/32	63.6	\$218.00	
	LPH66-4	36	11	66	4	4	13 3/8	14 7/32	111.6	\$354.00	
	LPH78-5	36	11	78	5	5	13 3/8	Higher 14 7/32	135.6	\$423.00	
LPH90-6	36	11	90	6	6	13 3/8	14 7/32	159.6	\$494.00		
DOUBLE FACE	LPH42-4DF	36	22	42	4	4	24 3/8	Lower 24 3/8	109.2	\$356.00	
	LPH66-8DF	36	22	66	8	8	24 3/8	24 3/8	200.4	\$616.00	
	LPH78-10DF	36	22	78	10	10	24 3/8	Higher 24 3/8	246.0	\$748.00	
	LPH90-12DF	36	22	90	12	12	24 3/8	24 3/8	291.6	\$881.00	



- Display surface is 14" high
- All units include plain shelves and a base shelf at 11" actual
- If you would like to have a lip, add **LIP** to the CODE # Ex. : **LPH42-2-LIP** and add **\$3.00** for each sloped shelves



Single face

Double face

- Notes :**
- All single face units must be anchored to the wall (wall anchor included)

AE/14

ASSEMBLY WITH SLOPED DISPLAY SHELVING AND PERIODICAL DISPLAY CABINET

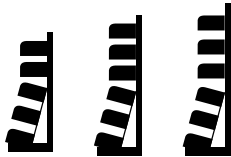
AETNASTAK

	CODE #	W	D	H	Qty Hinged Shelves	Qty Plain Shelves	lbs	\$
SLOPED DISPLAY SHELVING								
SINGLE FACE	ADS6636SF	36	8	66	5	2	100.8	\$369.00
	ADS8436SF	36	8	84	7	3	121.2	\$438.00
	ADS9036SF	36	8	90	7	3	122.4	\$442.00
DOUBLE FACE	ADS6636DF	36	8	66	10	4	178.8	\$651.00
	ADS8436DF	36	8	84	14	6	230.4	\$831.00
	ADS9036DF	36	8	90	14	6	231.6	\$844.00

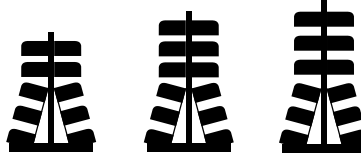


Illustration to be used as a reference only

- Closed back available for the upper portion
- Lower sloped full back included
- Backstops included
- Shelf depth dimensions are **nominal**



Single face



Double face

PERIODICAL DISPLAY CABINET

BREP-1**	37	17	72	5	5	206.0	\$1,218.00
----------	----	----	----	---	---	-------	------------

- Pre-assembled at the factory
- ** Available on QuickShip program (see **QuickShip** tab)



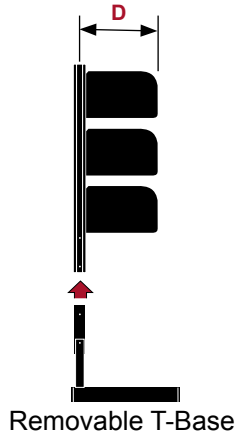
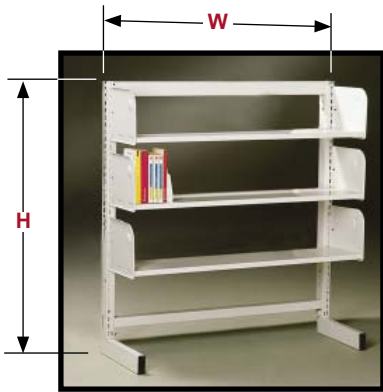
Notes :

- All single face units must be anchored to the wall (wall anchor included)

T-BASE UNITS

Single face

AETNASTAK



STARTER

ADDER

	CODE #	W	D	H	Qty Of Shelves	lbs	\$
42" HIGH	3 ADJUSTABLE SHELVES						
	TP423608S	36	8	42	3	51.6	\$281.00
	TP423609S	36	9	42	3	55.2	\$285.00
	TP423610S	36	10	42	3	58.8	\$289.00
	TP423612S	36	12	42	3	66.0	\$303.00
48" HIGH	3 ADJUSTABLE SHELVES						
	TP483608S	36	8	48	3	54.0	\$283.00
	TP483609S	36	9	48	3	56.4	\$287.00
	TP483610S	36	10	48	3	61.2	\$291.00
	TP483612S	36	12	48	3	68.4	\$306.00
66" HIGH	5 ADJUSTABLE SHELVES						
	TP663608S	36	8	66	5	70.8	\$341.00
	TP663609S	36	9	66	5	79.2	\$347.00
	TP663610S	36	10	66	5	82.8	\$356.00
	TP663612S	36	12	66	5	94.8	\$379.00
78" HIGH	6 ADJUSTABLE SHELVES						
	TP783608S	36	8	78	6	79.2	\$374.00
	TP783609S	36	9	78	6	86.4	\$384.00
	TP783610S	36	10	78	6	93.6	\$392.00
	TP783612S	36	12	78	6	108.0	\$419.00
90" HIGH	7 ADJUSTABLE SHELVES						
	TP903608S	36	8	90	7	90.0	\$407.00
	TP903609S	36	9	90	7	98.4	\$418.00
	TP903610S	36	10	90	7	106.8	\$429.00
	TP903612S	36	12	90	7	123.6	\$459.00



	CODE #	W	D	H	Qty Of Shelves	lbs	\$
42" HIGH	3 ADJUSTABLE SHELVES						
	TP423608A	36	8	42	3	45.6	\$217.00
	TP423609A	36	9	42	3	49.2	\$223.00
	TP423610A	36	10	42	3	52.8	\$227.00
	TP423612A	36	12	42	3	60.0	\$241.00
48" HIGH	3 ADJUSTABLE SHELVES						
	TP483608A	36	8	48	3	48.0	\$219.00
	TP483609A	36	9	48	3	51.6	\$225.00
	TP483610A	36	10	48	3	55.2	\$230.00
	TP483612A	36	12	48	3	62.4	\$243.00
66" HIGH	5 ADJUSTABLE SHELVES						
	TP663608A	36	8	66	5	64.8	\$278.00
	TP663609A	36	9	66	5	70.8	\$286.00
	TP663610A	36	10	66	5	76.8	\$294.00
	TP663612A	36	12	66	5	88.8	\$317.00
78" HIGH	6 ADJUSTABLE SHELVES						
	TP783608A	36	8	78	6	73.2	\$311.00
	TP783609A	36	9	78	6	80.4	\$321.00
	TP783610A	36	10	78	6	87.6	\$330.00
	TP783612A	36	12	78	6	102.0	\$357.00
90" HIGH	7 ADJUSTABLE SHELVES						
	TP903608A	36	8	90	7	84.0	\$343.00
	TP903609A	36	9	90	7	92.4	\$355.00
	TP903610A	36	10	90	7	100.8	\$366.00
	TP903612A	36	12	90	7	117.6	\$398.00

Notes :

- Shelf depth dimensions are **nominal**
- Must be anchored to the wall to prevent tipping (see page **AE/26**)
- Levelers not included

AE/16

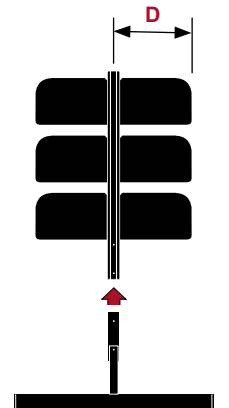
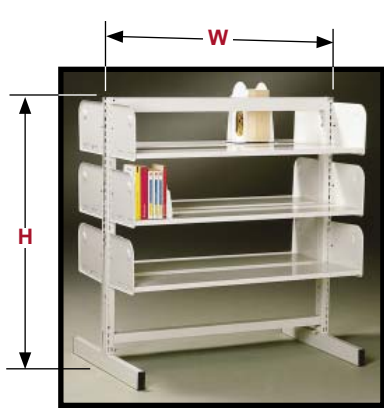


MONTEL
The Intelligent Use of Space

T-BASE UNITS

Double face

AETNASTAK



STARTER

Removable T-Base

ADDER

	CODE #	W	D	H	Qty Of Shelves	lbs	\$		CODE #	W	D	H	Qty Of Shelves	lbs	\$
42" HIGH	6 ADJUSTABLE SHELVES														
	TP423616S	36	8	42	6	78.0	\$368.00		TP423616A	36	8	42	6	69.6	\$299.00
	TP423618S	36	9	42	6	85.2	\$378.00		TP423618A	36	9	42	6	76.8	\$309.00
	TP423620S	36	10	42	6	92.4	\$387.00		TP423620A	36	10	42	6	84.0	\$319.00
	TP423624S	36	12	42	6	106.8	\$413.00	TP423624A	36	12	42	6	98.4	\$344.00	
48" HIGH	6 ADJUSTABLE SHELVES														
	TP483616S	36	8	48	6	80.4	\$370.00		TP483616A	36	8	48	6	72.0	\$300.00
	TP483618S	36	9	48	6	87.6	\$380.00		TP483618A	36	9	48	6	79.2	\$311.00
	TP483620S	36	10	48	6	94.8	\$387.00		TP483620A	36	10	48	6	86.4	\$321.00
	TP483624S	36	12	48	6	109.2	\$415.00	TP483624A	36	12	48	6	100.8	\$346.00	
66" HIGH	10 ADJUSTABLE SHELVES														
	TP663616S	36	8	66	10	111.6	\$479.00		TP663616A	36	8	66	10	103.2	\$409.00
	TP663618S	36	9	66	10	123.6	\$493.00		TP663618A	36	9	66	10	115.2	\$424.00
	TP663620S	36	10	66	10	135.6	\$511.00		TP663620A	36	10	66	10	127.2	\$442.00
	TP663624S	36	12	66	10	159.6	\$553.00	TP663624A	36	12	66	10	151.2	\$485.00	
78" HIGH	12 ADJUSTABLE SHELVES														
	TP783616S	36	8	78	12	127.2	\$535.00		TP783616A	36	8	78	12	118.8	\$467.00
	TP783618S	36	9	78	12	141.6	\$554.00		TP783618A	36	9	78	12	133.2	\$487.00
	TP783620S	36	10	78	12	156.0	\$574.00		TP783620A	36	10	78	12	147.6	\$505.00
	TP783624S	36	12	78	12	170.4	\$627.00	TP783624A	36	12	78	12	176.4	\$558.00	
90" HIGH	14 ADJUSTABLE SHELVES														
	TP903616S	36	8	90	14	145.2	\$594.00		TP903616A	36	8	90	14	136.8	\$526.00
	TP903618S	36	9	90	14	162.0	\$616.00		TP903618A	36	9	90	14	153.6	\$547.00
	TP903620S	36	10	90	14	178.8	\$638.00		TP903620A	36	10	90	14	170.4	\$570.00
	TP903624S	36	12	90	14	212.4	\$700.00	TP903624A	36	12	90	14	204.0	\$630.00	

Notes :

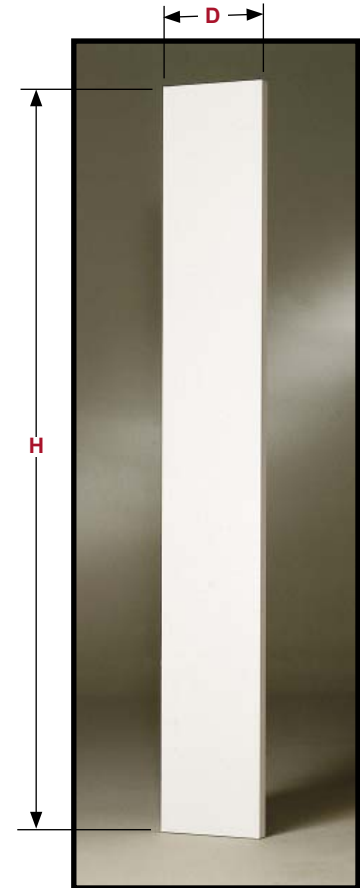
- Shelf depth dimensions are **nominal**
- Levelers not included

PATTERNED/TEXTURED STEEL FRONT OR END PANELS

AETNASTAK

Single face

	CODE #	D	Thickness	H	lbs	\$
36" HIGH	EPAS3608-PAT	9 3/8	1 1/2	36	9.6	\$81.75
	EPAS3609-PAT	10 3/8	1 1/2	36	10.8	\$84.38
	EPAS3610-PAT	11 3/8	1 1/2	36	12.0	\$86.75
	EPAS3611-PAT	12 3/8	1 1/2	36	13.2	\$89.25
	EPAS3612-PAT	13 3/8	1 1/2	36	14.4	\$91.75
	EPAS3613-PAT	14 3/8	1 1/2	36	15.6	\$94.25
	EPAS3616-PAT	17 3/8	1 1/2	36	16.8	\$102.63
42" HIGH	EPAS4208-PAT	9 3/8	1 1/2	42	12.0	\$85.50
	EPAS4209-PAT	10 3/8	1 1/2	42	13.2	\$88.13
	EPAS4210-PAT	11 3/8	1 1/2	42	14.4	\$90.50
	EPAS4211-PAT	12 3/8	1 1/2	42	15.6	\$93.00
	EPAS4212-PAT	13 3/8	1 1/2	42	16.8	\$95.50
	EPAS4213-PAT	14 3/8	1 1/2	42	18.0	\$98.00
	EPAS4216-PAT	17 3/8	1 1/2	42	19.2	\$106.38
48" HIGH	EPAS4808-PAT	9 3/8	1 1/2	48	13.2	\$90.50
	EPAS4809-PAT	10 3/8	1 1/2	48	14.4	\$93.13
	EPAS4810-PAT	11 3/8	1 1/2	48	15.6	\$95.50
	EPAS4811-PAT	12 3/8	1 1/2	48	16.8	\$98.00
	EPAS4812-PAT	13 3/8	1 1/2	48	18.0	\$100.50
	EPAS4813-PAT	14 3/8	1 1/2	48	19.2	\$103.00
	EPAS4816-PAT	17 3/8	1 1/2	48	20.4	\$111.38
54" HIGH	EPAS5408-PAT	9 3/8	1 1/2	54	14.4	\$95.50
	EPAS5409-PAT	10 3/8	1 1/2	54	15.6	\$98.13
	EPAS5410-PAT	11 3/8	1 1/2	54	16.8	\$100.50
	EPAS5411-PAT	12 3/8	1 1/2	54	18.0	\$103.00
	EPAS5412-PAT	13 3/8	1 1/2	54	19.2	\$105.50
	EPAS5413-PAT	14 3/8	1 1/2	54	20.4	\$108.00
	EPAS5416-PAT	17 3/8	1 1/2	54	21.6	\$116.38



Notes :

- The depth dimensions are **actual**
- Front or end panels are patterned steel
- For plain steel front or end panels remove -PAT within CODE # Ex. : **EPAS3612**
- To install a front or end panel without a canopy top, use a special bracket (see page **AE/41**)

AE/18

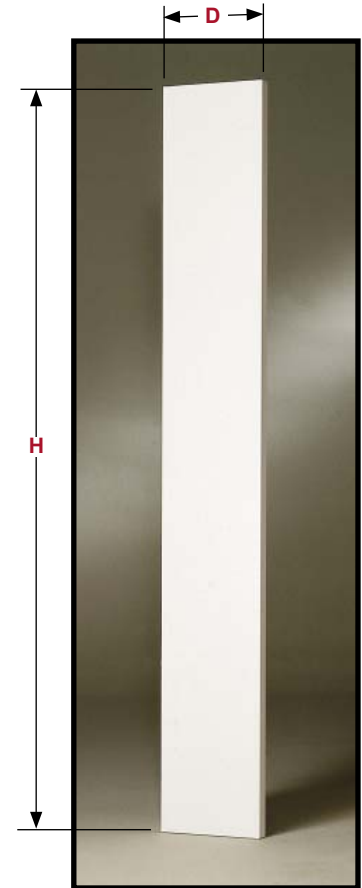


PATTERNED/TEXTURED STEEL FRONT OR END PANELS

AETNASTAK

Single face

	CODE #	D	Thickness	H	lbs	\$
60" HIGH	EPAS6008-PAT	9 3/8	1 1/2	60	15.6	\$101.75
	EPAS6009-PAT	10 3/8	1 1/2	60	16.8	\$104.38
	EPAS6010-PAT	11 3/8	1 1/2	60	18.0	\$106.75
	EPAS6011-PAT	12 3/8	1 1/2	60	19.2	\$109.25
	EPAS6012-PAT	13 3/8	1 1/2	60	20.4	\$111.75
	EPAS6013-PAT	14 3/8	1 1/2	60	21.6	\$114.25
	EPAS6016-PAT	17 3/8	1 1/2	60	22.8	\$122.63
66" HIGH	EPAS6608-PAT	9 3/8	1 1/2	66	18.0	\$107.25
	EPAS6609-PAT	10 3/8	1 1/2	66	19.2	\$110.88
	EPAS6610-PAT	11 3/8	1 1/2	66	20.4	\$114.75
	EPAS6611-PAT	12 3/8	1 1/2	66	21.6	\$118.00
	EPAS6612-PAT	13 3/8	1 1/2	66	22.8	\$121.25
	EPAS6613-PAT	14 3/8	1 1/2	66	24.0	\$124.50
	EPAS6616-PAT	17 3/8	1 1/2	66	25.2	\$138.75
72" HIGH	EPAS7208-PAT	9 3/8	1 1/2	72	19.2	\$112.25
	EPAS7209-PAT	10 3/8	1 1/2	72	20.4	\$115.88
	EPAS7210-PAT	11 3/8	1 1/2	72	21.6	\$119.75
	EPAS7211-PAT	12 3/8	1 1/2	72	22.8	\$123.00
	EPAS7212-PAT	13 3/8	1 1/2	72	24.0	\$126.25
	EPAS7213-PAT	14 3/8	1 1/2	72	25.2	\$129.50
	EPAS7216-PAT	17 3/8	1 1/2	72	26.4	\$143.75
78" HIGH	EPAS7808-PAT	9 3/8	1 1/2	78	20.4	\$116.25
	EPAS7809-PAT	10 3/8	1 1/2	78	21.6	\$121.25
	EPAS7810-PAT	11 3/8	1 1/2	78	22.8	\$126.25
	EPAS7811-PAT	12 3/8	1 1/2	78	25.2	\$131.25
	EPAS7812-PAT	13 3/8	1 1/2	78	26.4	\$136.25
	EPAS7813-PAT	14 3/8	1 1/2	78	28.8	\$141.25
	EPAS7816-PAT	17 3/8	1 1/2	78	30.0	\$156.25



Notes :

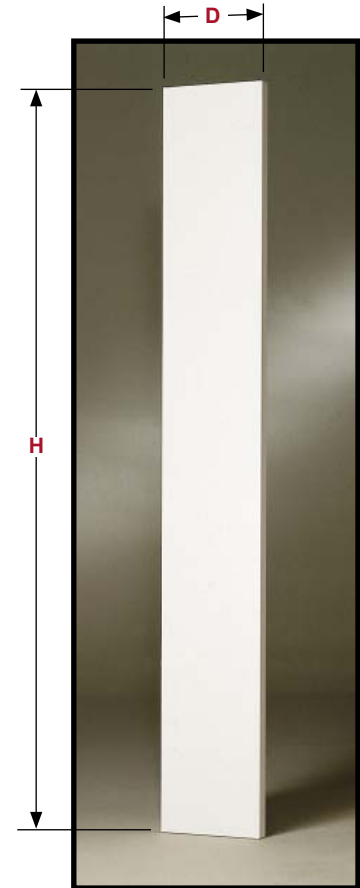
- The depth dimensions are **actual**
- Front or end panels are patterned steel
- For plain steel front or end panels remove -PAT within CODE # Ex. : **EPAS6012**
- To install a front or end panel without a canopy top, use a special bracket (see page **AE/41**)

PATTERNED/TEXTURED STEEL FRONT OR END PANELS

AETNASTAK

Single face

	CODE #	D	Thickness	H	lbs	\$
84" HIGH	EPAS8408-PAT	9 3/8	1 1/2	84	22.8	\$121.25
	EPAS8409-PAT	10 3/8	1 1/2	84	24.0	\$126.25
	EPAS8410-PAT	11 3/8	1 1/2	84	25.2	\$132.50
	EPAS8411-PAT	12 3/8	1 1/2	84	27.6	\$135.00
	EPAS8412-PAT	13 3/8	1 1/2	84	28.8	\$137.50
	EPAS8413-PAT	14 3/8	1 1/2	84	31.2	\$140.00
	EPAS8416-PAT	17 3/8	1 1/2	84	32.4	\$162.50
90" HIGH	EPAS9008-PAT	9 3/8	1 1/2	90	24.0	\$126.25
	EPAS9009-PAT	10 3/8	1 1/2	90	25.2	\$132.50
	EPAS9010-PAT	11 3/8	1 1/2	90	27.6	\$137.50
	EPAS9011-PAT	12 3/8	1 1/2	90	30.0	\$142.50
	EPAS9012-PAT	13 3/8	1 1/2	90	31.2	\$146.25
	EPAS9013-PAT	14 3/8	1 1/2	90	33.6	\$151.25
	EPAS9016-PAT	17 3/8	1 1/2	90	34.8	\$168.75
93" HIGH	EPAS9308-PAT	9 3/8	1 1/2	93	25.2	\$128.75
	EPAS9309-PAT	10 3/8	1 1/2	93	26.4	\$135.00
	EPAS9310-PAT	11 3/8	1 1/2	93	28.8	\$140.00
	EPAS9311-PAT	12 3/8	1 1/2	93	31.2	\$146.25
	EPAS9312-PAT	13 3/8	1 1/2	93	32.4	\$151.25
	EPAS9313-PAT	14 3/8	1 1/2	93	36.0	\$157.50
	EPAS9316-PAT	17 3/8	1 1/2	93	37.2	\$172.50
102" HIGH	EPAS10208-PAT	9 3/8	1 1/2	102	27.6	\$141.25
	EPAS10209-PAT	10 3/8	1 1/2	102	28.8	\$147.50
	EPAS10210-PAT	11 3/8	1 1/2	102	31.2	\$152.50
	EPAS10211-PAT	12 3/8	1 1/2	102	33.6	\$158.75
	EPAS10212-PAT	13 3/8	1 1/2	102	34.8	\$163.75
	EPAS10213-PAT	14 3/8	1 1/2	102	38.4	\$170.00
	EPAS10216-PAT	17 3/8	1 1/2	102	40.8	\$185.00



Notes :

- The depth dimensions are **actual**
- Front or end panels are patterned steel
- For plain steel front or end panels remove -PAT within CODE # Ex. : **EPAS8412**
- To install a front or end panel without a canopy top, use a special bracket (see page **AE/41**)

AE/20

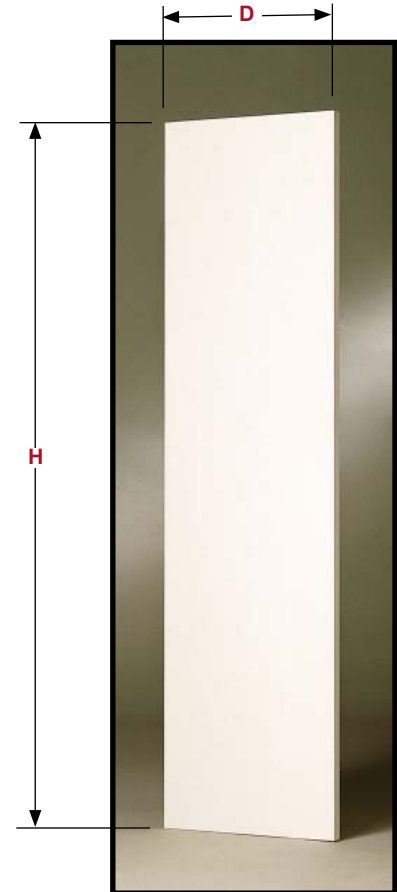


PATTERNED/TEXTURED STEEL FRONT OR END PANELS

AETNASTAK

Double face

	CODE #	D	Thickness	H	lbs	\$
36" HIGH	EPAD3616-PAT	16 3/4	1 1/2	36	16.8	\$116.25
	EPAD3618-PAT	18 3/4	1 1/2	36	18.0	\$122.50
	EPAD3620-PAT	20 3/4	1 1/2	36	20.4	\$130.00
	EPAD3622-PAT	22 3/4	1 1/2	36	22.8	\$135.00
	EPAD3624-PAT	24 3/4	1 1/2	36	25.2	\$140.00
	EPAD3626-PAT	26 3/4	1 1/2	36	26.4	\$145.00
	EPAD3632-PAT	32 3/4	1 1/2	36	27.6	\$160.00
42" HIGH	EPAD4216-PAT	16 3/4	1 1/2	42	19.2	\$120.00
	EPAD4218-PAT	18 3/4	1 1/2	42	21.6	\$126.25
	EPAD4220-PAT	20 3/4	1 1/2	42	24.0	\$133.75
	EPAD4222-PAT	22 3/4	1 1/2	42	26.4	\$138.75
	EPAD4224-PAT	24 3/4	1 1/2	42	28.8	\$143.75
	EPAD4226-PAT	26 3/4	1 1/2	42	31.2	\$148.75
	EPAD4232-PAT	32 3/4	1 1/2	42	32.4	\$163.75
48" HIGH	EPAD4816-PAT	16 3/4	1 1/2	48	21.6	\$125.00
	EPAD4818-PAT	18 3/4	1 1/2	48	25.2	\$131.25
	EPAD4820-PAT	20 3/4	1 1/2	48	27.6	\$138.75
	EPAD4822-PAT	22 3/4	1 1/2	48	30.0	\$143.75
	EPAD4824-PAT	24 3/4	1 1/2	48	32.4	\$148.75
	EPAD4826-PAT	26 3/4	1 1/2	48	36.0	\$153.75
	EPAD4832-PAT	32 3/4	1 1/2	48	37.2	\$168.75
54" HIGH	EPAD5416-PAT	16 3/4	1 1/2	54	25.2	\$130.00
	EPAD5418-PAT	18 3/4	1 1/2	54	28.8	\$136.25
	EPAD5420-PAT	20 3/4	1 1/2	54	31.2	\$143.75
	EPAD5422-PAT	22 3/4	1 1/2	54	33.6	\$148.75
	EPAD5424-PAT	24 3/4	1 1/2	54	37.2	\$153.75
	EPAD5426-PAT	26 3/4	1 1/2	54	40.8	\$158.75
	EPAD5432-PAT	32 3/4	1 1/2	54	42.0	\$173.75



Notes :

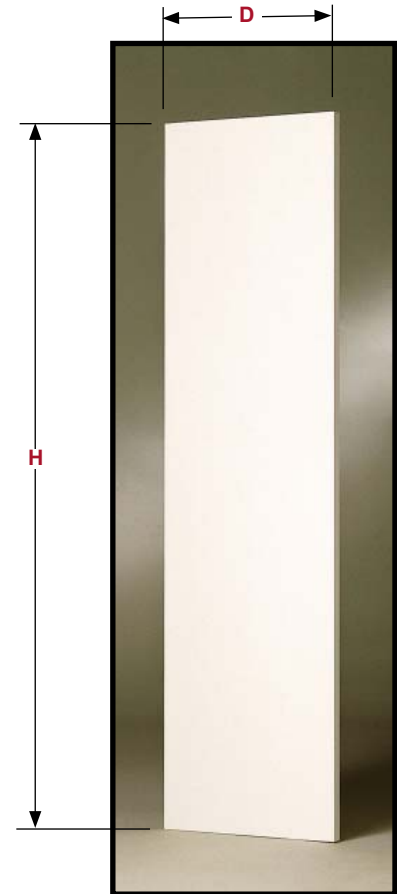
- The depth dimensions are **actual**
- Front or end panels are patterned steel
- For plain steel front or end panels remove -PAT within CODE # Ex. : **EPAD3612**
- To install a front or end panel without a canopy top, use a special bracket (see page **AE/41**)

PATTERNED/TEXTURED STEEL FRONT OR END PANELS

AETNASTAK

Double face

	CODE #	D	Thickness	H	lbs	\$
60" HIGH	EPAD6016-PAT	16 3/4	1 1/2	60	27.6	\$136.25
	EPAD6018-PAT	18 3/4	1 1/2	60	32.4	\$142.50
	EPAD6020-PAT	20 3/4	1 1/2	60	34.8	\$150.00
	EPAD6022-PAT	22 3/4	1 1/2	60	37.2	\$155.00
	EPAD6024-PAT	24 3/4	1 1/2	60	40.8	\$160.00
	EPAD6026-PAT	26 3/4	1 1/2	60	44.4	\$165.00
	EPAD6032-PAT	32 3/4	1 1/2	60	45.6	\$180.00
66" HIGH	EPAD6616-PAT	16 3/4	1 1/2	66	30.0	\$155.00
	EPAD6618-PAT	18 3/4	1 1/2	66	32.4	\$163.75
	EPAD6620-PAT	20 3/4	1 1/2	66	34.8	\$172.50
	EPAD6622-PAT	22 3/4	1 1/2	66	37.2	\$180.00
	EPAD6624-PAT	24 3/4	1 1/2	66	39.6	\$186.25
	EPAD6626-PAT	26 3/4	1 1/2	66	42.0	\$193.75
	EPAD6632-PAT	32 3/4	1 1/2	66	44.4	\$207.50
72" HIGH	EPAD7216-PAT	16 3/4	1 1/2	72	32.4	\$160.00
	EPAD7218-PAT	18 3/4	1 1/2	72	34.8	\$168.75
	EPAD7220-PAT	20 3/4	1 1/2	72	38.4	\$177.50
	EPAD7222-PAT	22 3/4	1 1/2	72	40.8	\$185.00
	EPAD7224-PAT	24 3/4	1 1/2	72	43.2	\$191.25
	EPAD7226-PAT	26 3/4	1 1/2	72	45.6	\$198.75
	EPAD7232-PAT	32 3/4	1 1/2	72	49.2	\$212.50
78" HIGH	EPAD7816-PAT	16 3/4	1 1/2	78	34.8	\$172.50
	EPAD7818-PAT	18 3/4	1 1/2	78	37.2	\$180.00
	EPAD7820-PAT	20 3/4	1 1/2	78	39.6	\$190.00
	EPAD7822-PAT	22 3/4	1 1/2	78	42.0	\$198.75
	EPAD7824-PAT	24 3/4	1 1/2	78	44.4	\$207.50
	EPAD7826-PAT	26 3/4	1 1/2	78	46.8	\$216.25
	EPAD7832-PAT	32 3/4	1 1/2	78	52.8	\$243.75



Notes :

- The depth dimensions are **actual**
- Front or end panels are patterned steel
- For plain steel front or end panels remove -PAT within CODE # Ex. : **EPAD6012**
- To install a front or end panel without a canopy top, use a special bracket (see page **AE/41**)

AE/22

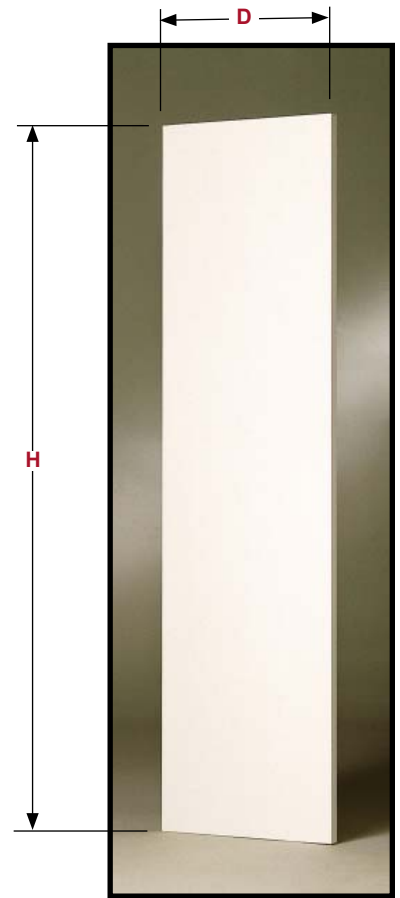


PATTERNED/TEXTURED STEEL FRONT OR END PANELS

AETNASTAK

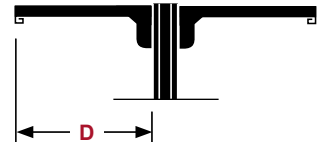
Double face

	CODE #	D	Thickness	H	lbs	\$
84" HIGH	EPAD8416-PAT	16 3/4	1 1/2	84	38.4	\$180.00
	EPAD8418-PAT	18 3/4	1 1/2	84	40.8	\$191.25
	EPAD8420-PAT	20 3/4	1 1/2	84	43.2	\$198.75
	EPAD8422-PAT	22 3/4	1 1/2	84	45.6	\$203.75
	EPAD8424-PAT	24 3/4	1 1/2	84	48.0	\$207.50
	EPAD8426-PAT	26 3/4	1 1/2	84	50.4	\$212.50
	EPAD8432-PAT	32 3/4	1 1/2	84	56.4	\$252.50
90" HIGH	EPAD9016-PAT	16 3/4	1 1/2	90	40.8	\$191.25
	EPAD9018-PAT	18 3/4	1 1/2	90	43.2	\$198.75
	EPAD9020-PAT	20 3/4	1 1/2	90	45.6	\$207.50
	EPAD9022-PAT	22 3/4	1 1/2	90	48.0	\$215.00
	EPAD9024-PAT	24 3/4	1 1/2	90	50.4	\$223.75
	EPAD9026-PAT	26 3/4	1 1/2	90	52.8	\$231.25
	EPAD9032-PAT	32 3/4	1 1/2	90	60.0	\$261.25
93" HIGH	EPAD9316-PAT	16 3/4	1 1/2	93	42.0	\$196.25
	EPAD9318-PAT	18 3/4	1 1/2	93	44.4	\$202.50
	EPAD9320-PAT	20 3/4	1 1/2	93	46.8	\$212.50
	EPAD9322-PAT	22 3/4	1 1/2	93	49.2	\$222.50
	EPAD9324-PAT	24 3/4	1 1/2	93	51.6	\$232.50
	EPAD9326-PAT	26 3/4	1 1/2	93	54.0	\$242.50
	EPAD9332-PAT	32 3/4	1 1/2	93	61.2	\$265.00
102" HIGH	EPAD10216-PAT	16 3/4	1 1/2	102	45.6	\$215.00
	EPAD10218-PAT	18 3/4	1 1/2	102	49.2	\$221.25
	EPAD10220-PAT	20 3/4	1 1/2	102	51.6	\$231.25
	EPAD10222-PAT	22 3/4	1 1/2	102	54.0	\$241.25
	EPAD10224-PAT	24 3/4	1 1/2	102	56.4	\$251.25
	EPAD10226-PAT	26 3/4	1 1/2	102	58.8	\$261.25
	EPAD10232-PAT	32 3/4	1 1/2	102	67.2	\$283.75

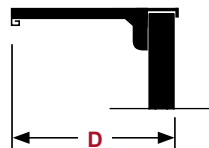


Notes :

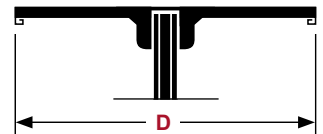
- The depth dimensions are **actual**
- Front or end panels are patterned steel
- For plain steel front or end panels remove -PAT within CODE # Ex. : **EPAD8412**
- To install a front or end panel without a canopy top, use a special bracket (see page **AE/41**)



SINGLE / DOUBLE FACE



LOWER SINGLE FACE



LOWER DOUBLE FACE

CODE #	W	D	H	lbs	\$
ACTS3608A	36	7 7/32	1 1/2	6.0	\$40.90
ACTS3609A	36	8 7/32	1 1/2	7.2	\$42.20
ACTS3610A	36	9 7/32	1 1/2	8.4	\$43.70
ACTS3611A	36	10 7/32	1 1/2	9.6	\$44.80
ACTS3612A	36	11 7/32	1 1/2	10.8	\$45.90
ACTS3613A	36	12 7/32	1 1/2	12.0	\$48.90
ACTS3616A	36	15 7/32	1 1/2	13.2	\$51.80

SINGLE FACE DOUBLE FACE

- Canopy top depth dimensions are **actual**
- Canopy top does not cover the welded frame
- Recommended for higher sections (78" high and higher)
- 2 canopies are required for double face units

ACTS3608ULA	36	9 7/32	1 1/2	6.0	\$42.50
ACTS3609ULA	36	10 7/32	1 1/2	7.2	\$43.90
ACTS3610ULA	36	11 7/32	1 1/2	8.4	\$45.20
ACTS3611ULA	36	12 7/32	1 1/2	9.6	\$47.20
ACTS3612ULA	36	13 7/32	1 1/2	10.8	\$49.10
ACTS3613ULA	36	14 7/32	1 1/2	12.0	\$52.45
ACTS3616ULA	36	17 7/32	1 1/2	13.2	\$55.80

SINGLE FACE

- Canopy top depth dimensions are **actual**
- Canopy top does cover the welded frame
- Recommended for lower sections (66" high and lower)
- Cannot be used for double face units

ACTD3616A	36	16 3/8	1 1/2	13.2	\$81.80
ACTD3618A	36	18 3/8	1 1/2	14.4	\$84.50
ACTD3620A	36	20 3/8	1 1/2	15.6	\$87.40
ACTD3622A	36	22 3/8	1 1/2	16.8	\$89.60
ACTD3624A	36	24 3/8	1 1/2	18.0	\$91.80
ACTD3626A	36	26 3/8	1 1/2	19.2	\$95.00
ACTD3632A	36	32 3/8	1 1/2	21.6	\$100.00

DOUBLE FACE

- Canopy top depth dimensions are **actual**
- Canopy top covers both sides
- Recommended for lower sections (66" high and lower)
- Cannot be used for single face units

Notes :

- 24" and 30" widths are available at the same price
- Substitute 24 or 30 within catalog number when required
- Channel is required to use a wire book support
- If you would like to have the "J" channel for a wire book support, add **WJ** to the CODE # Ex. : **ACTS3608WJA** and add **\$7.00** per single face to the price

CODE # W Thickness H lbs \$

WALL COLUMN

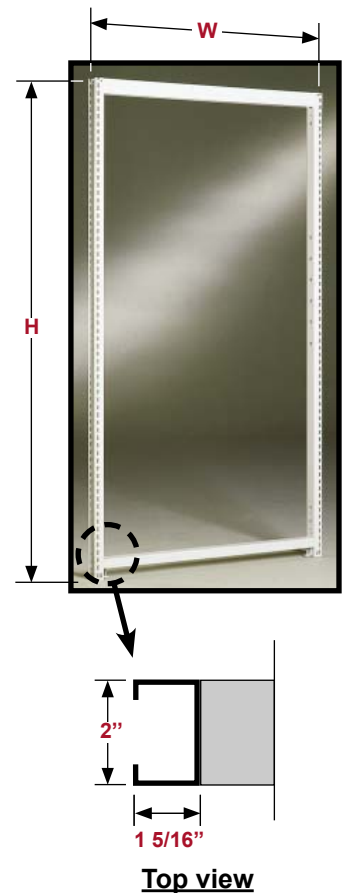
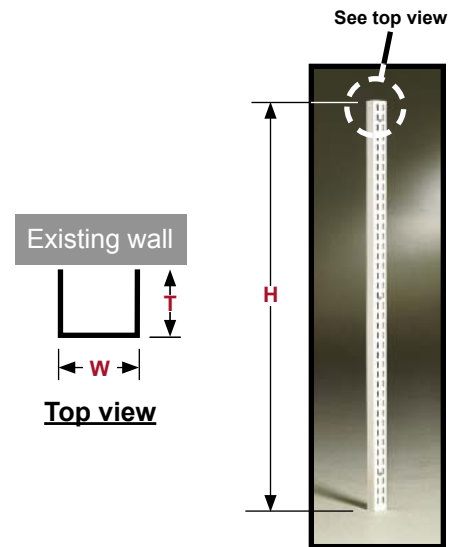
L36WSC	1 5/8	1 1/4	36	3.0	\$21.50
L42WSC	1 5/8	1 1/4	42	3.6	\$22.50
L48WSC	1 5/8	1 1/4	48	4.2	\$23.60
L54WSC	1 5/8	1 1/4	54	4.8	\$24.60
L60WSC	1 5/8	1 1/4	60	5.4	\$25.40
L66WSC	1 5/8	1 1/4	66	6.0	\$26.60
L72WSC	1 5/8	1 1/4	72	6.6	\$27.40
L78WSC	1 5/8	1 1/4	78	7.2	\$28.50
L84WSC	1 5/8	1 1/4	84	7.8	\$29.50
L90WSC	1 5/8	1 1/4	90	8.4	\$30.50
L93WSC	1 5/8	1 1/4	93	9.0	\$32.50
L102WSC	1 5/8	1 1/4	102	10.8	\$35.50

• Hardware not included

WELDED FRAME

L3636A	36	1 5/16	36	16.8	\$78.50
L4236A	36	1 5/16	42	18.0	\$80.40
L4836A	36	1 5/16	48	19.2	\$82.40
L5436A	36	1 5/16	54	20.4	\$84.30
L6036A	36	1 5/16	60	21.6	\$86.50
L6636A	36	1 5/16	66	22.8	\$90.40
L7236A	36	1 5/16	72	24.0	\$94.40
L7836A	36	1 5/16	78	25.2	\$98.40
L8436A	36	1 5/16	84	26.4	\$103.00
L9036A	36	1 5/16	90	27.6	\$107.00
L9336A	36	1 5/16	93	28.8	\$113.00
L10236A	36	1 5/16	102	30.0	\$125.00

- **Nominal** dimensions. Add 1/16 for overall **actual** dimensions
- 24" and 30" widths are available at the same price
- Substitute 24 or 30 within catalog number when required



CODE # W D H lbs \$

SEISMIC FRAME EXTRA TUBE (Gussets not included)

L78362TA	36	-	78	27.1	\$115.60
L84362TA	36	-	84	28.0	\$120.20
L90362TA	36	-	90	29.2	\$124.20
L93362TA	36	-	93	29.7	\$130.20
L102362TA	36	-	102	Call Montel	

- **Nominal** dimensions : add 1/16 for overall **actual** dimensions
- 24" and 30" widths are available at the same price
- Substitute 24 or 30 within catalog number when required

GUSSET SINGLE FACE LEFT AND RIGHT

G9008SFLA or SFRA	-	7	47 1/8	4.9	\$53.50
G9009SFLA or SFRA	-	8	47 1/8	4.9	\$53.50
G9010SFLA or SFRA	-	9	47 1/8	5.4	\$53.50
G9012SFLA or SFRA	-	11	47 1/8	6.2	\$53.50
G9013SFLA or SFRA	-	12	47 1/8	7.1	\$53.50
G9015SFLA or SFRA	-	14	47 1/8	7.9	\$53.50

- Base depth dimensions are **actual**
- Specify (L) for left or (R) for right

GUSSET DOUBLE FACE

G9016DFA	-	14	47 1/8	13.2	\$67.90
G9018DFA	-	16	47 1/8	14.4	\$67.90
G9020DFA	-	18	47 1/8	15.6	\$67.90
G9022DFA	-	20	47 1/8	16.8	\$67.90
G9024DFA	-	22	47 1/8	18.0	\$67.90
G9026DFA	-	24	47 1/8	19.2	\$67.90
G9030DFA	-	28	47 1/8	20.4	\$67.90

- Base depth dimensions are **actual**
- All necessary spacers are included

WALL ANCHOR ANGLE *

LWAA	2	-	2	0.2	\$2.40
------	---	---	---	-----	--------

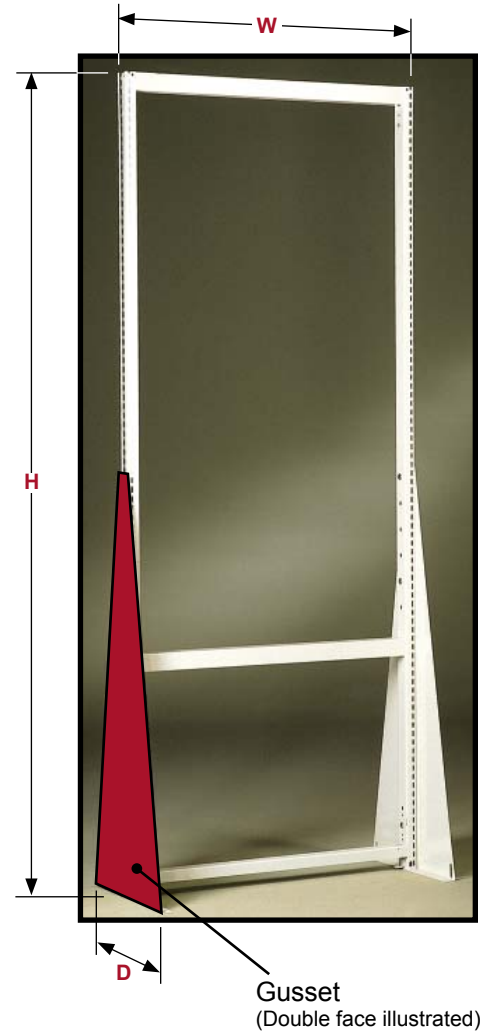
FLOOR ANCHOR ANGLE *

AE.SKSG12	For seismic zones 1, 2, 2B	\$2.08
AE.SKSG34	For seismic zones 3, 4	\$4.88

TOP TIE STRUT *

	Length	
TTS92	-	90 - 7.2 \$25.40

- * Hardware included

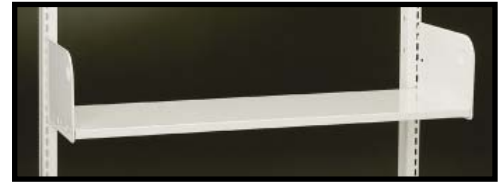


CODE # W D H lbs \$

ADJUSTABLE SHELF

LS3608A	36	8	-	7.2	\$25.40
LS3609A	36	9	-	8.4	\$26.60
LS3610A	36	10	-	9.6	\$28.20
LS3611A	36	11	-	10.8	\$30.70
LS3612A	36	12	-	12.0	\$32.60
LS3613A	36	13	-	13.2	\$34.80
LS3616A	36	16	-	15.6	\$44.60

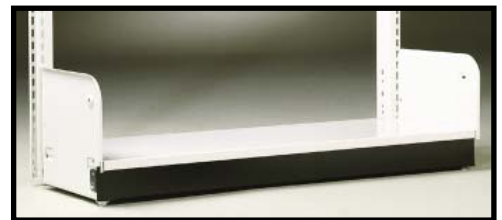
• Shelf depth dimensions are **nominal**



BASE SHELF

L3608BSA	36	8	-	12.0	\$39.00
L3609BSA	36	9	-	13.2	\$41.20
L3610BSA	36	10	-	14.4	\$43.20
L3611BSA	36	11	-	15.6	\$44.50
L3612BSA	36	12	-	16.8	\$45.50
L3613BSA	36	13	-	18.0	\$46.70
L3616BSA	36	16	-	21.6	\$54.50

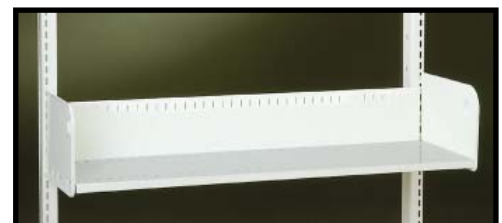
• Shelf depth dimensions are **nominal**



ADJUSTABLE DIVIDER SHELF

FS3607A	36	7	-	9.6	\$32.60
FS3608A	36	8	-	10.8	\$34.40
FS3609A	36	9	-	12.0	\$36.10
FS3610A	36	10	-	13.2	\$38.20
FS3611A	36	11	-	14.4	\$40.10
FS3612A	36	12	-	15.6	\$42.00
FS3613A	36	13	-	16.8	\$44.10
FS3615A	36	15	-	18.0	\$47.32

• Shelf depth dimensions are **actual**



Dividers not included (see page **AE/38**)

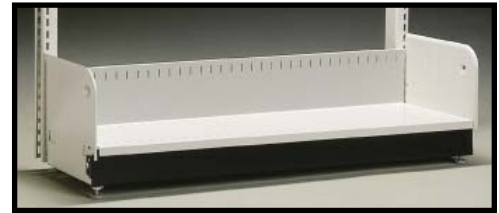
Notes :

- 24" and 30" widths are available at the same price
- Substitute 24 or 30 within catalog number when required

CODE # W D H lbs \$

DIVIDER BASE SHELF

F3607BSA	36	7	-	14.4	\$52.30
F3608BSA	36	8	-	15.6	\$54.30
F3609BSA	36	9	-	16.8	\$56.34
F3610BSA	36	10	-	18.0	\$58.40
F3611BSA	36	11	-	19.2	\$60.70
F3612BSA	36	12	-	20.4	\$78.80
F3613BSA	36	13	-	21.6	\$81.50
F3615BSA	36	15	-	22.8	\$85.94



Dividers not included (see page **AE/38**)

• Shelf depth dimensions are **actual**

ADJUSTABLE LOW BACK SHELF 1 1/2" HIGH

FS3607LBA	36	7	-	7.2	\$25.40
FS3608LBA	36	8	-	8.4	\$26.60
FS3609LBA	36	9	-	9.6	\$28.20
FS3610LBA	36	10	-	10.8	\$30.70
FS3611LBA	36	11	-	12.0	\$32.60
FS3612LBA	36	12	-	13.2	\$34.80



ADJUSTABLE LOW BACK BASE SHELF 1 1/2" HIGH

F3607LBBSA	36	7	-	12.0	\$39.00
F3608LBBSA	36	8	-	13.2	\$41.20
F3609LBBSA	36	9	-	14.4	\$43.20
F3610LBBSA	36	10	-	15.6	\$44.50
F3611LBBSA	36	11	-	16.8	\$45.50
F3612LBBSA	36	12	-	18.0	\$46.70

• Shelf depth dimensions are **actual**
 • Accommodates sliding wire book support (see page **AE/38**)

Notes :

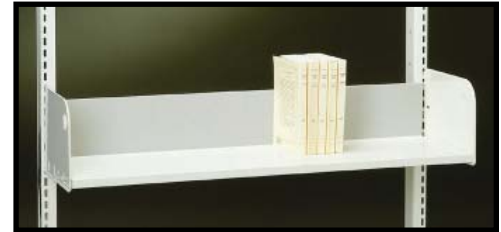
- 24" and 30" widths are available at the same price
- Substitute 24 or 30 within catalog number when required



CODE # W D H lbs \$

INTEGRAL BACKSTOP SHELF 5”H

FS3607NSA	36	7	-	9.6	\$30.60
FS3608NSA	36	8	-	10.8	\$32.30
FS3609NSA	36	9	-	12.0	\$34.20
FS3610NSA	36	10	-	13.2	\$37.31
FS3611NSA	36	11	-	14.4	\$38.10
FS3612NSA	36	12	-	15.6	\$39.40



INTEGRAL BACKSTOP BASE SHELF 5”H

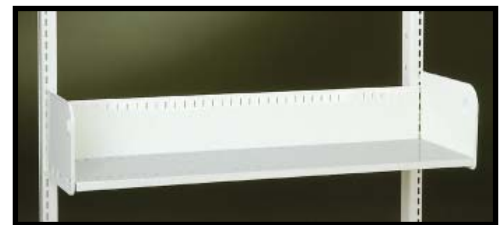
F3607NSBSA	36	7	-	13.2	\$50.30
F3608NSBSA	36	8	-	15.6	\$51.70
F3609NSBSA	36	9	-	16.8	\$54.30
F3610NSBSA	36	10	-	18.0	\$57.40
F3611NSBSA	36	11	-	19.2	\$58.50
F3612NSBSA	36	12	-	20.4	\$75.94

• Shelf depth dimensions are **actual**

ADJUSTABLE DIVIDER SLOPED SHELF (5 degree slope)

FS3607SA	36	7	-	9.6	\$40.40
FS3608SA	36	8	-	10.8	\$42.40
FS3609SA	36	9	-	12.0	\$43.10
FS3610SA	36	10	-	13.2	\$45.10
FS3611SA	36	11	-	14.4	\$48.10
FS3612SA	36	12	-	15.6	\$49.30
FS3613SA	36	13	-	16.8	\$50.50
FS3615SA	36	15	-	18.0	\$58.50

• Shelf depth dimensions are **actual**



Dividers not included (see page **AE/38**)

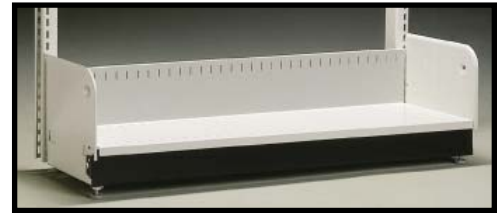
Notes :

- 24” and 30” widths are available at the same price
- Substitute 24 or 30 within catalog number when required

CODE # W D H lbs \$

DIVIDER SLOPED BASE SHELF (5 degree slope)

F3607SBSA	36	7	-	14.4	\$60.60
F3608SBSA	36	8	-	15.6	\$62.60
F3609SBSA	36	9	-	16.8	\$64.30
F3610SBSA	36	10	-	18.0	\$67.20
F3611SBSA	36	11	-	19.2	\$69.20
F3612SBSA	36	12	-	20.4	\$87.10
F3613SBSA	36	13	-	21.6	\$89.80
F3615SBSA	36	15	-	22.8	\$94.24

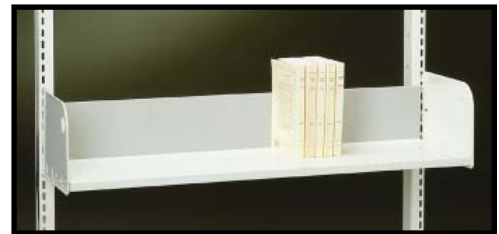


Dividers not included (see page **AE/38**)

• Shelf depth dimensions are **actual**

INTEGRAL BACKSTOP SLOPED SHELF 5”H (5 degree slope)

FS3607SNSA	36	7	-	12.0	\$35.20
FS3608SNSA	36	8	-	13.2	\$37.90
FS3609SNSA	36	9	-	14.4	\$40.50
FS3610SNSA	36	10	-	15.6	\$43.00
FS3611SNSA	36	11	-	16.8	\$45.50
FS3612SNSA	36	12	-	18.0	\$48.20
FS3613SNSA	36	13	-	19.2	\$51.70
FS3615SNSA	36	15	-	21.6	\$56.00



INTEGRAL BACKSTOP SLOPED BASE SHELF 5”H (5 degree slope)

F3607SNSBSA	36	7	-	14.4	\$53.80
F3608SNSBSA	36	8	-	15.6	\$56.60
F3609SNSBSA	36	9	-	16.8	\$61.90
F3610SNSBSA	36	10	-	18.0	\$64.20
F3611SNSBSA	36	11	-	19.2	\$66.50
F3612SNSBSA	36	12	-	20.4	\$72.50
F3613SNSBSA	36	13	-	21.6	\$74.00
F3615SNSBSA	36	15	-	24.0	\$78.50

• Shelf depth dimensions are **actual**

Notes :

- 24” and 30” widths are available at the same price
- Substitute 24 or 30 within catalog number when required

CODE # W D H lbs \$

UNIVERSAL DISPLAY SHELF

LS3610UDA	36	10	-	10.8	\$42.70
LS3612UDA	36	12	-	13.6	\$45.30

UNIVERSAL DISPLAY BASE SHELF

L3610UDBSA	36	10	-	15.6	\$57.85
L3612UDBSA	36	12	-	16.8	\$60.10

• Depth dimensions are **nominal**



UNIVERSAL DISPLAY DIVIDER SHELF

FS3609UDA	36	9	-	10.8	\$45.70
FS3611UDA	36	11	-	12.4	\$48.25

UNIVERSAL DISPLAY DIVIDER BASE SHELF

F3609UDBSA	36	9	-	16.8	\$76.20
F3611UDBSA	36	11	-	18.0	\$78.50

• Depth dimensions are **actual**



Dividers not included (see below)



DIVIDER FOR UNIVERSAL DISPLAY SHELF

F57	-	-	-	0.5	\$2.90
-----	---	---	---	-----	---------------

SLIDING REFERENCE SHELF (Adjustable shelf not included)

L3612SRA	36	11	-	14.4	\$100.00
----------	----	----	---	------	-----------------

• For use on 9" to 15" **actual** shelves



PIVOTED PERIODICAL DISPLAY SHELF

LS3614PHA	36	11	-	21.6	\$62.50
-----------	----	----	---	------	----------------

• 14" hinged display shelf with 11" **actual** storage shelf

LS3614PHA-16	36	15	-	25.2	\$74.50
--------------	----	----	---	------	----------------

• 14" hinged display shelf with 15" **actual** storage shelf
 • If you would like to have a lip, add **LIP** to the CODE #
 Ex. : **LS3614PHA-LIP** and add **\$3.00** for each sloped shelves



Front or end panels and tops need to be deeper if used with display shelf

Notes :

- 24" and 30" widths are available at the same price
- Substitute 24 or 30 within catalog number when required

CODE # W D H lbs \$

PIVOTED PERIODICAL DISPLAY BASE SHELF

L3614PHBA 36 11 - 24.0 **\$75.30**

- 14" hinged display shelf with 11" **actual** storage shelf

L3614PHBA-16 36 15 - 27.6 **\$87.30**

- 14" hinged display shelf with 15" **actual** storage shelf
- If you would like to have a lip, add **LIP** to the CODE #
Ex. : **LS3614PHA-LIP** and add **\$3.00** for each sloped shelves

HINGED PERIODICAL DISPLAY SHELF With 1" lip

LS3612BRMA-12 36 12 - 30.0 **\$112.20**

LS3614BRMA-15 36 15 - 37.5 **\$122.20**

HINGED PERIODICAL DISPLAY BASE SHELF With 1" lip

L3612BRMBSA-12 36 12 - 34.1 **\$132.00**

L3614BRMBSA-15 36 15 - 42.6 **\$142.00**

- 12" hinged display shelf with 12" **actual** storage shelf
- 14" hinged display shelf with 15" **actual** storage shelf

PICTURE BOOK SHELF

LS3609BRAA 36 9 - 18.0 **\$112.20**

LS3610BRAA 36 10 - 19.2 **\$118.80**

LS3611BRAA 36 11 - 20.4 **\$125.40**

LS3613BRAA 36 13 - 21.6 **\$138.60**

PICTURE BOOK BASE SHELF

L3609BRABSA 36 9 - 22.8 **\$137.20**

L3610BRABSA 36 10 - 24.0 **\$143.80**

L3611BRABSA 36 11 - 25.2 **\$150.40**

L3613BRABSA 36 13 - 26.4 **\$163.60**

PIVOTED PERIODICAL DISPLAY SHELF With divider storage

LS3614PHA-DV11 36 11 - 22.8 **\$84.30**

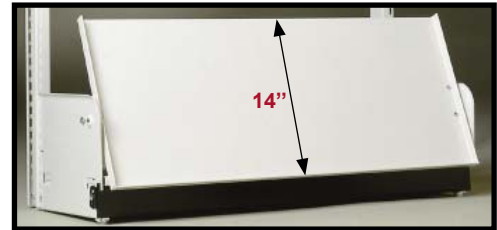
LS3614PHA-DV15 36 15 - 26.4 **\$96.30**

PIVOTED PERIODICAL DISPLAY BASE SHELF With div. storage

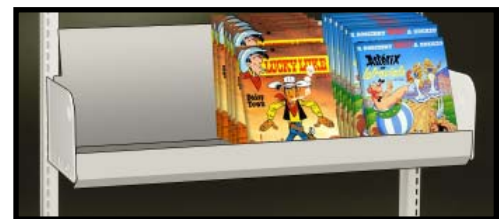
L3614PHBA-DV11 36 11 - 25.2 **\$105.00**

L3614PHBA-DV15 36 15 - 28.8 **\$107.00**

- 14" hinged display shelf with 15" **actual** storage divider shelf
- Dividers provide storage compartments



Front or end panels and tops need to be deeper if used with display shelf



Dividers not included (see page **AE/33**)
Front or end panels and tops need to be deeper if used with display shelf

Notes :

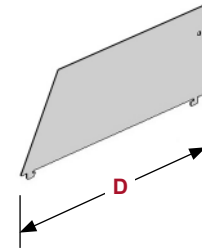
- 24" and 30" widths are available at the same price
- Substitute 24 or 30 within catalog number when required

CODE # W D H lbs \$

DIVIDER FOR PIVOTED PERIODICAL DISPLAY SHELF

FH610	-	11	-	1.1	\$4.50
FH614	-	15	-	1.4	\$5.20

- **Actual** storage shelf dimensions



FIXED PERIODICAL DISPLAY SHELF

L3611PF	36	10	-	9.6	\$45.50
---------	----	----	---	-----	---------

FIXED PERIODICAL DISPLAY BASE SHELF

L3611PFBA	36	10	-	12.0	\$57.00
-----------	----	----	---	------	---------

- 11" **actual** sloped surface with 10" **actual** side depth



PIVOTED SLOPED DISPLAY SHELF With plexiglass cover

LS3614PHA-P	36	11	-	22.8	\$231.00
LS3614PHA-16P	36	15	-	26.4	\$251.00

PIVOTED SLOPED DISPLAY BASE SHELF With plexiglass cover

L3614PHBA-P	36	11	-	24.0	\$246.00
L3614PHBA-16P	36	15	-	27.6	\$264.00

- 14" hinged display shelf with 15" **actual** storage shelf
- **1 piece** plexiglass cover



Front or end panels and tops need to be deeper if used with display shelf

PIVOTED SLOPED DISPLAY SHELF With plexiglass cover

LS3614PHA-P2	36	11	-	22.8	\$231.00
LS3614PHA-16P2	36	15	-	26.4	\$251.00

PIVOTED SLOPED DISPLAY BASE SHELF With plexiglass cover

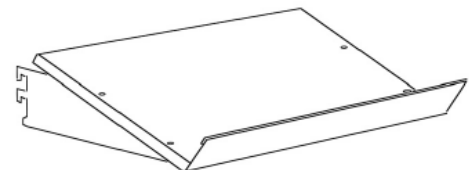
L3614PHBA-P2	36	11	-	24.0	\$246.00
L3614PHBA-16P2	36	15	-	27.6	\$264.00

- 14" hinged display shelf with 15" **actual** storage shelf
- **2 pieces** plexiglass cover

FIXED DISPLAY SHELF With 3" front lip

L3611LPF	36	11	-	9.6	\$45.50
----------	----	----	---	-----	---------

- **Actual** sloped surface with 10" **actual** depth on the side



Notes :

- 24" and 30" widths are available at the same price
- Substitute 24 or 30 within catalog number when required

CODE # W D H lbs \$

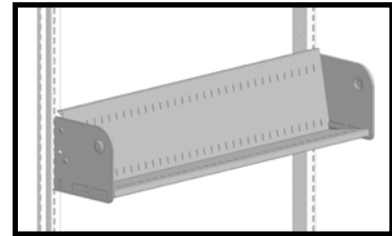
SINGLE TIER MEDIA SHELF

FS3608MSA	36	8	-	12.0	\$45.70
FS3609MSA	36	9	-	13.2	\$49.70

SINGLE TIER MEDIA BASE SHELF

F3608MSBA	36	8	-	16.8	\$67.10
F3609MSBA	36	9	-	18.0	\$68.50

• Shelf depth dimensions are **actual**

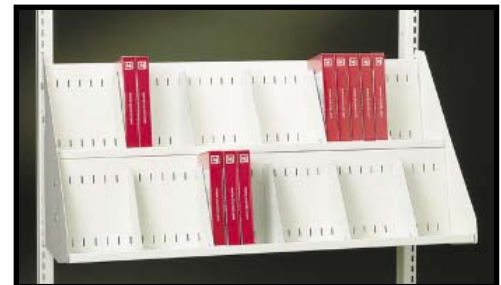
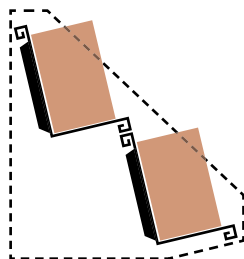


Special dividers not included (see below)

DOUBLE TIER MEDIA SHELF

FS3615MSA	36	15	-	31.2	\$131.00
-----------	----	----	---	------	-----------------

• Shelf depth dimensions are **actual**



Special dividers not included (see below)

MEDIA SHELF DIVIDER

FMS67	-	-	-	0.6	4.60
-------	---	---	---	-----	-------------



ADJUSTABLE LOW PROFILE SHELF With 4" H end brackets

LS3608LPA	36	8	-	7.2	\$28.90
LS3609LPA	36	9	-	8.4	\$30.50
LS3610LPA	36	10	-	9.6	\$32.20
LS3612LPA	36	12	-	12.0	\$36.50
LS3616LPA	36	16	-	16.8	\$48.50

• Shelf depth dimensions are **nominal**
• Lip included



Notes :

- 24" and 30" widths are available at the same price
- Substitute 24 or 30 within catalog number when required

CODE # W D H lbs \$

ADJUSTABLE STORAGE SHELF

L3608UA	36	8	-	6.0	\$27.90
L3609UA	36	9	-	7.2	\$29.00
L3610UA	36	10	-	8.4	\$30.20
L3612UA	36	12	-	9.6	\$33.90
L3616UA	36	16	-	12.0	\$43.80
U3618A	36	18	-	16.8	\$74.50
U3622A	36	22	-	24.0	\$83.10



- Shelf depth dimensions are **nominal**
- Lip not included

FIXED MEDIA BROWSING BOX (6 Rods, 5 Spaces)

F3611FDA	36	11	-	43.2	\$203.00
----------	----	----	---	------	-----------------

- Shelf depth dimensions are **actual**



PULL OUT MEDIA BROWSING BOX (6 Rods, 5 Spaces)

F3611SDA	36	11	-	43.2	\$307.00
----------	----	----	---	------	-----------------

- Shelf depth dimensions are **actual**



SLIDING DRAWER WITH SINGLE TRAY (6 Dividers)

F3611STDA	36	11	-	43.2	\$192.00
-----------	----	----	---	------	-----------------

- Shelf depth dimensions are **actual**



SLIDING DRAWER WITH TWO TRAYS (6 Dividers)

F3611DTDA	36	11	-	43.2	\$323.00
-----------	----	----	---	------	-----------------

- Shelf depth dimensions are **actual**



- Notes :**
- 24" and 30" widths are available at the same price
 - Substitute 24 or 30 within catalog number when required

CODE # W D H lbs \$

NEWSPAPER RACK Dowels not included

LNB36	dowel not included	36	12	14	8.4	\$253.00
LNB36-10	dowel not included	36	12	22	13.2	\$306.00

• Shelf depth dimensions are **nominal**



BROWSING BOX

L3610BBA		36	10	8	15.6	\$183.00
L3612BBA		36	12	8	18.0	\$201.00
L3616BBA		36	16	8	22.8	\$233.00

• Shelf depth dimensions are **nominal**



HANGING BAG ROD (for various objects)

L12RODA	dowel included	36	12	-	10.3	\$79.20
---------	----------------	----	----	---	------	----------------

• Shelf depth dimensions are **nominal**



WORK SHELF BRACKETS

LTB19		36	19	-	4.8	\$35.20
-------	--	----	----	---	-----	----------------

• Depth dimensions are **nominal**
 • To be used with 20" to 22" wood or plastic laminated work shelf (not included)



PAPERBACK ZIG ZAG BACKSTOP

L36PDA		36	-	-	9.6	\$33.30
--------	--	----	---	---	-----	----------------

• Shelf not included



Notes :

- 24" and 30" widths are available at the same price
- Substitute 24 or 30 within catalog number when required

CODE # W D H lbs \$

MULTI-TIER SHELF

L3610TTSA 36 10 - 16.8 **\$79.20**

- Shelf depth dimensions are **nominal**



CASSETTE DISPLAY SHELF

L3611MFBS 36 12 - 18.6 **\$139.00**

- Shelf depth dimensions are **nominal**
- For microfilms, cassettes, paperbacks...



MICROFILM SHELF

L3604MF 36 5 - 4.8 **\$52.30**

L3606MF 36 7 - 6.0 **\$53.80**

- Shelf depth dimensions are **nominal**
- BackStop included



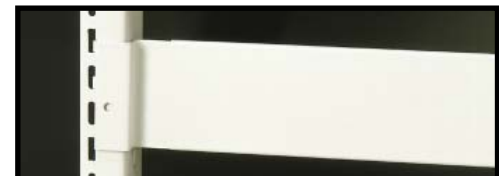
ADJUSTABLE SHELF BACKSTOP

L36X 36 - 3 2.4 **\$6.10**



RECESSED SHELF BACKSTOP

L36RX 36 - 3 2.4 **\$20.00**



ADJUSTABLE BACKSTOP FOR WIRE BOOK SUPPORT

L36XWB 36 - 3 2.4 **\$6.60**

- Shelf and wire book supports not included (see page **AE/38** for wire book supports)



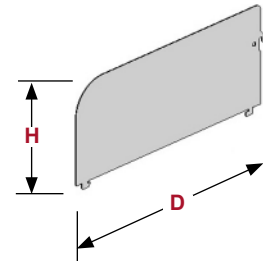
Notes :

- 24" and 30" widths are available at the same price
- Substitute 24 or 30 within catalog number when required

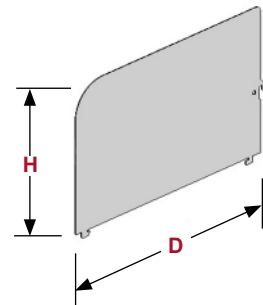
6" HIGH

9" HIGH

CODE #	W	D	H	lbs	\$
DIVIDER					
	<small>Actual divider dim.</small>	<small>To be used with actual shelf dim.</small>			
F66	6	7	6	0.6	\$3.00
F67	7	8	6	0.7	\$3.10
F68	8	9	6	0.8	\$3.10
F69	9	10	6	1.0	\$3.40
F610	10	11	6	1.1	\$3.70
F611	11	12	6	1.2	\$4.00
F612	12	13	6	1.3	\$4.20
F614	14	15	6	1.4	\$4.50
F96	6	7	9	1.3	\$5.70
F97	7	8	9	1.5	\$5.70
F98	8	9	9	1.6	\$5.70
F99	9	10	9	1.8	\$6.10
F910	10	11	9	1.9	\$6.70
F911	11	12	9	2.2	\$7.10
F912	12	13	9	2.3	\$7.60
F914	14	15	9	2.6	\$8.30



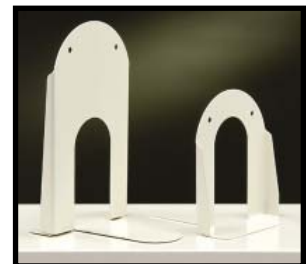
Ex. : With FS3609A use F68 divider



• **Actual** divider dimensions

FINDABLE BOOK SUPPORT

LM6S	Plain base	6	1.1	\$6.00
LM9S	Plain base	9	1.5	\$7.30
LM6SCORK	Cork base	6	1.1	\$8.40
LM9SCORK	Cork base	9	1.5	\$9.60
LM6SMAG	Magnetic base	6	1.1	\$8.40
LM9SMAG	Magnetic base	9	1.5	\$9.60



WIRE BOOK SUPPORT

L8-9XWB	-	-	-	0.1	\$4.30
L10-12XWB	-	-	-	0.1	\$4.30

• To be used with an adjustable backstop (see page **AE/37**)



SLIDING WIRE BOOK SUPPORT

L8-9LBWB	-	-	-	0.2	\$6.90
----------	---	---	---	-----	--------

• To be used with a low back shelf (see page **AE/28**)

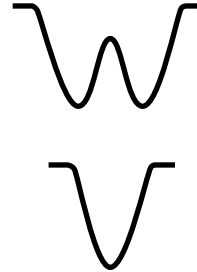


CODE # W D H lbs \$

WIRE BOOK SUPPORT

L8W	7" & 8" shelves	W Type	0.2	\$6.00
L12W	9" & 11" shelves	W Type	0.2	\$7.30
L8-12W	7" to 11" shelves	V Type	0.1	\$4.00

- To be used with a plain shelf and a canopy top
- If used with a canopy top, a "J" channel is required



RANGE FINDER - BRUSHED ALUMINUM

L2RFA	-	-	-	0.1	\$17.00
-------	---	---	---	-----	---------



CARD HOLDER - BRUSHED ALUMINUM

L2CHA	-	-	-	0.1	\$7.30
-------	---	---	---	-----	--------



LABEL HOLDER - CLEAR PLASTIC

L5LHP	5" length	-	-	-	0.1	\$1.40
L34LHP	34" length	-	-	-	0.2	\$6.80



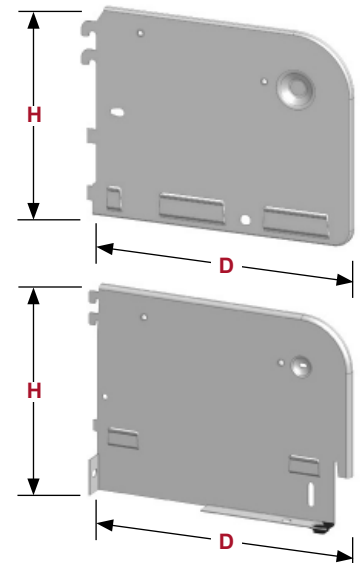
SNAP-ON END BRACKET (punched holes to be used pivoted shelves)

LS12PHR or PHL	-	12	-	1.8	\$5.80
LS16PHR or PHL	-	16	-	2.5	\$6.40

BASE END BRACKET (punched holes to be used pivoted shelves)

L12BSKPHRA or PHLA	-	12	-	2.5	\$13.75
L16BSKPHRA or PHLA	-	16	-	4.3	\$20.15

- Depth dimensions are **nominal**
- Specify (L) for left or (R) for right
- To be used with pivoted shelves only (see page **AE/31** and **AE/33**)



CODE # W D H lbs \$

SNAP-ON END BRACKET (for adjustable shelves)

LS08R or L	-	8	-	1.2	\$3.40
LS09R or L	-	9	-	1.3	\$3.65
LS10R or L	-	10	-	1.6	\$4.10
LS11R or L	-	11	-	1.7	\$4.20
LS12R or L	-	12	-	1.8	\$4.60
LS13R or L	-	13	-	2.0	\$4.90
LS16R or L	-	16	-	2.5	\$5.90

BASE END BRACKET (for adjustable shelves)

L08BSKRA or BSKLA	-	8	-	1.7	\$8.55
L09BSKRA or BSKLA	-	9	-	1.9	\$8.90
L10BSKRA or BSKLA	-	10	-	2.0	\$9.50
L11BSKRA or BSKLA	-	11	-	2.3	\$9.75
L12BSKRA or BSKLA	-	12	-	2.5	\$10.20
L13BSKRA or BSKLA	-	13	-	2.8	\$10.50
L16BSKRA or BSKLA	-	16	-	4.3	\$11.85

- Depth dimensions are **nominal**
- Specify (L) for left or (R) for right

KICK STRIP / FRONT BASE

L36KS	36	-	3	2.5	\$6.90
-------	----	---	---	-----	---------------

- 24" and 30" widths are available at the same price
- Substitute 24 or 30 within catalog number
- Standard color is black unless otherwise specified

CANOPY BRACKET

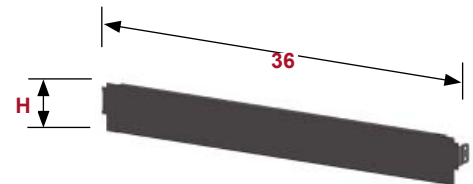
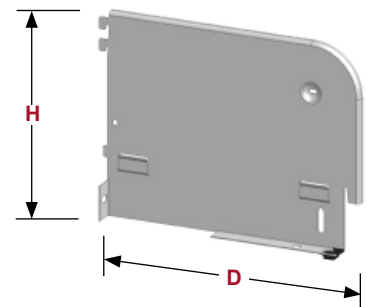
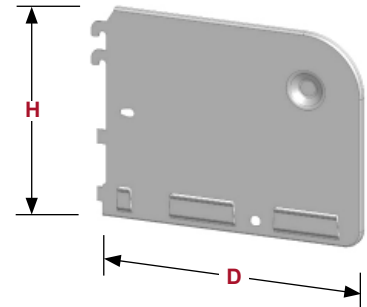
L08UCTR or UCTL	-	8	-	0.8	\$3.70
L09UCTR or UCTL	-	9	-	1.0	\$3.70
L10UCTR or UCTL	-	10	-	1.1	\$3.70
L12UCTR or UCTL	-	12	-	1.2	\$3.70

- Specify (L) for left or (R) for right

BRACKET FOR WOOD OR PLASTIC LAMINATED CANOPY TOPS

L08UWT2-LSF or RSF	-	8	-	0.8	\$5.40
L09UWT2-LSF or RSF	-	9	-	1.0	\$5.70
L10UWT2-LSF or RSF	-	10	-	1.1	\$5.80
L12UWT2-LSF or RSF	-	12	-	1.2	\$6.70

- Specify (L) for left or (R) for right



CODE # W D H lbs \$

BRACKET FOR SECTIONS WITH STEEL, WOOD OR PLASTIC LAMINATED FRONT OR END PANEL (WHEN CANOPY TOP IS NOT USED)

ATTOPL.08 or PR.08	-	8	-	0.8	\$12.00
ATTOPL.09 or PR.09	-	9	-	1.0	\$12.00
ATTOPL.10 or PR.10	-	10	-	1.1	\$12.00
ATTOPL.12 or PR.12	-	12	-	1.2	\$12.00

ATTOPD.16	-	16	-	1.7	\$17.00
ATTOPD.18	-	18	-	1.9	\$17.00
ATTOPD.20	-	20	-	2.2	\$17.00
ATTOPD.24	-	24	-	2.4	\$17.00

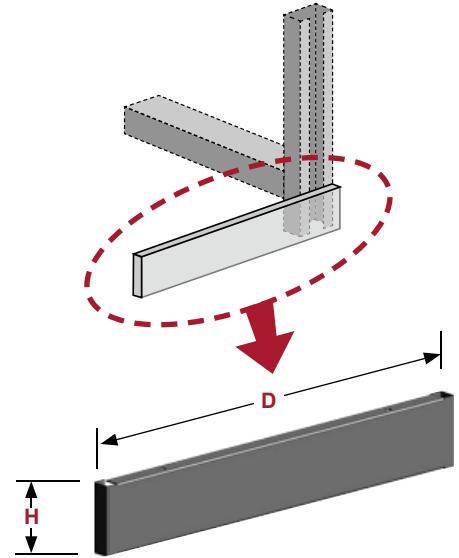
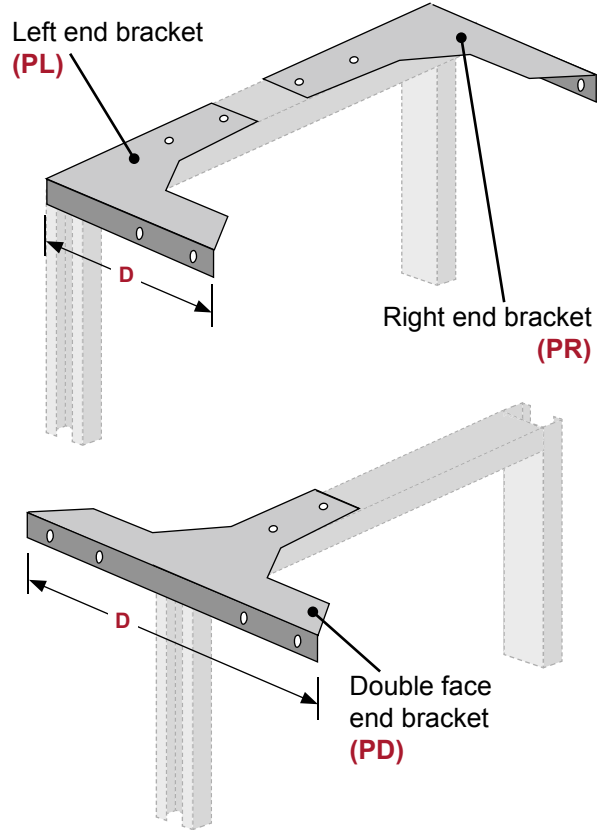
- Depth dimensions are **nominal**
- Specify (L) for left, (R) for right or (D) for double face

SIDE KICK STRIP

KICP08	-	7	-	0.7	\$8.40
KICP09	-	8	-	0.8	\$9.00
KICP10	-	9	-	1.0	\$9.50
KICP11	-	10	-	1.1	\$10.00
KICP12	-	11	-	1.2	\$10.50
KICP13	-	12	-	1.3	\$11.00
KICP16	-	15	-	1.6	\$12.20

KICPD08	-	7	-	1.6	\$9.50
KICPD09	-	8	-	1.8	\$10.50
KICPD10	-	9	-	1.9	\$11.50
KICPD11	-	10	-	2.2	\$12.50
KICPD12	-	11	-	2.4	\$13.50
KICPD13	-	12	-	2.6	\$14.50
KICPD16	-	15	-	3.1	\$17.50

- Depth dimensions are **actual**
- To be used with custom End Panel
- Standard color is black unless otherwise specified



CODE # W D H lbs \$

CLOSED BACK PANEL

L3636BA	36	-	36	14.4	\$93.00
L4236BA	36	-	42	18.0	\$110.00
L4836BA	36	-	48	20.4	\$118.00
L5436BA	36	-	54	22.8	\$126.00
L6036BA	36	-	60	25.2	\$132.00
L6636BA	36	-	66	27.6	\$142.00
L7236BA	36	-	72	30.0	\$149.00
L7836BA	36	-	78	33.6	\$159.00
L8436BA	36	-	84	39.6	\$166.00
L9036BA	36	-	90	42.0	\$175.00
L9336BA	36	-	93	43.2	\$193.00
L10236BA	36	-	102	44.4	\$213.00

- All dimensions are **nominal**
- 24" and 30" widths are available at the same price
- Substitute 24 or 30 within catalog number when required
- If ordered with welded frame, closed back is pre-assembled



Frame not included (see page **AE/25**)

Optional **full back panels** are available upon request. Call Montel for more information

INTERMEDIATE FILLERS

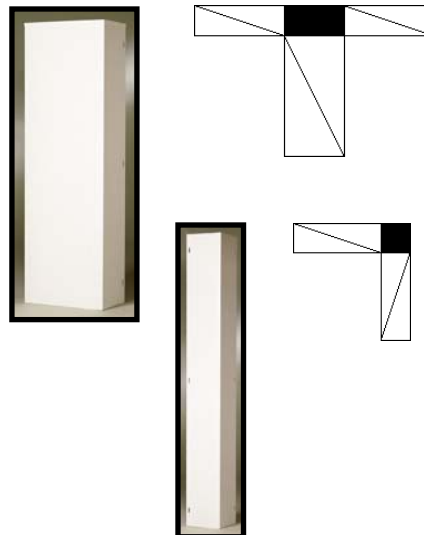
LSFDFSHTA Ex. : L12241284A for 12" **nominal** shelves

SF : Single face unit (**nominal** depth)

DF : Double face unit (**nominal** depth)

SF : Single face unit (**nominal** depth)

HT : Height of units



CORNER FILLERS


LSFSFHTA Ex. : L121284A for 12" **nominal** shelves

SF : Single face unit (**nominal** depth)

SF : Single face unit (**nominal** depth)

HT : Height of units

Call Montel for more information

CODE # W D H lbs \$ c 

POWER BAR ASSEMBLY

AE.PBAR - - - 3.6 \$700.00

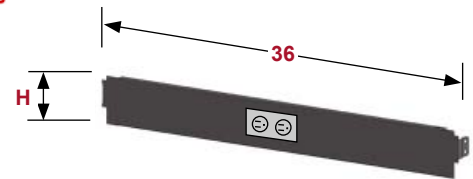
- 2 dual receptacles and 2 jacks are included
- On-site hardwired connections must be made by certified electrician using 3X14 AWG armoured cable
- Maximum shelf depth is 15" deep
- Joining power cords are not included



KICK STRIP / FRONT BASE WITH ELECTRICAL OUTLET

L36KSEL 36 - 3 3.7 \$92.00

- 24" and 30" widths are available at the same price
- Substitute 24 or 30 within catalog number
- Standard color is black unless otherwise specified
- One dual receptacle is included



CANOPY LIGHT

Optional **overhead aisle lighting** available. Call Montel for more information



CODE # W D H lbs \$

BOOKTRUCK WITH 4" WHEEL (BCL-A)

56.127.001.01	34	14	40	102.0	\$602.00
---------------	----	----	----	-------	-----------------

BOOKTRUCK WITH 5" WHEEL (BCL-A)

56.127.004.01	34	14	40	102.0	\$714.00
---------------	----	----	----	-------	-----------------

- 2 sloped shelves with integral backstop + 1 plain shelf
- 2 fixed wheels and 2 pivoted wheels

BOOKTRUCK WITH 4" WHEEL (BCL-A)

56.127.012.01	34	14	40	102.0	\$612.00
---------------	----	----	----	-------	-----------------

BOOKTRUCK WITH 5" WHEEL (BCL-A)

56.127.014.01	34	14	40	102.0	\$749.00
---------------	----	----	----	-------	-----------------

- 2 sloped shelves with integral backstop + 1 plain shelf
- 4 pivoted wheels

BOOKTRUCK WITH 4" WHEEL (BCL-B)

56.127.002.01	34	14	40	90.0	\$514.00
---------------	----	----	----	------	-----------------

BOOKTRUCK WITH 5" WHEEL (BCL-B)

56.127.005.01	34	14	40	90.0	\$625.00
---------------	----	----	----	------	-----------------

- 3 plain shelves
- 2 fixed wheels and 2 pivoted wheels

BOOKTRUCK WITH 4" WHEEL (BCL-B)

56.127.013.01	34	14	40	90.0	\$524.00
---------------	----	----	----	------	-----------------

BOOKTRUCK WITH 5" WHEEL (BCL-B)

56.127.015.01	34	14	40	90.0	\$661.00
---------------	----	----	----	------	-----------------

- 3 plain shelves
- 4 pivoted wheels

BOOKTRUCK (Heavy Duty)

56.127.010.01	43	14	47	120.0	\$964.00
---------------	----	----	----	-------	-----------------

- 3 plain shelves

