

2017

Product Map

- Reception Desks
- Credenzas
- Desks
- Desk Storage
- Overhead Storage
- Desk Hutches
- Filing
- Closed Storage
- Bookcases
- Executive Storage
- Keyboard Support
- Study Carrels
- Tables

 Search



# Terms & Conditions of Sale

## Price:

All prices shown are suggested retail prices and are subject to change without notice. Taxes are extra. These prices are guaranteed for 30 days from the date of quotation and are firm and final after acceptance of the order.

## Terms

Initial orders COD, net 30 days thereafter upon approved credit; 2% monthly interest (24% yearly) on past due invoices. All applicable taxes are extra. No orders will be shipped if invoices are past due. Prices do not include installation.

## Orders

All orders are subject to acceptance by BRC. Any written order is considered final. Order confirmations are binding, and the information received is the customer's responsibility to verify and correct within 24 hours. Any subsequent change is subject to approval by BRC. BRC reserves the right to apply a handling charge of 25% for any order change. Any order placed by phone will require a written confirmation within 24 hours, or will not be processed.

Cancellation/Changes No order can be cancelled without the written consent of BRC.

BRC reserves the right to charge the customer for that portion of the order which has been completed to date of cancellation, including a handling charge for disposal.

b) No order can be changed without the written consent of BRC. All change requests must be received in writing by BRC either by email or fax.

c) BRC reserves the right to apply a minimum handling fee of \$150.00 or 25% of the order value whichever is greater.

d) all deposits received are non-refundable.

## Storage

BRC reserves the right to assess storage charges on all items not accepted by the customer one week after the scheduled shipping date. The minimum charge is \$10.00 per skid per day. Note: The invoice for merchandise is dated and issued when the merchandise is ready for shipment.

## Return of Goods

a) Non-Catalogue and Customized Items are non - returnable.

b) No merchandise may be returned without the written consent of BRC, the issuance of a return authorization number and specific instructions by BRC for shipment. If this procedure is not followed, the merchandise will not be accepted by the factory and will be returned to sender collect without notice.

c) Claims for factory defects must be made within ten days of receipt of goods.

Merchandise must be returned to the BRC factory within 15 days after receipt of the return authorization from BRC. These conditions will be strictly adhered to.

d) Returns of items authorized by BRC are subject to a re-stocking charge of 25%, plus any repair costs deemed necessary. Items must be returned freight prepaid.

## Shipping/Claims

a) All freight prices quoted are based on dock to dock shipment F.O.B. Georgetown Ontario. Any pre-paid freight is based on established minimum order amounts.

Where order minimums are not met, drop charges will apply. Any special delivery arrangements including, but not limited to site delivery, specific delivery time or date, use of tailgate, blanket wrap, inside delivery will require additional costs to be paid by the customer.

b) Merchandise is carefully packed and thoroughly inspected before leaving the BRC warehouse. BRC will choose the carrier, unless otherwise indicated on customers order. Shipments will be handed over to the carrier in good condition and BRC liability ceases at this point. The carrier, upon acceptance of the shipment, assumes responsibility for its safe delivery. Claims for loss or damage sustained in transit must therefore be made upon the carrier as follows.

c) Claims for damages or shortages must adhere to the following processes: i) All damages or shortages must be claimed from the carrier within 48 hours of receipt, ii) All damages or shortages must be noted directly on the original delivery slip, iii) Photos of shipping damage must be forwarded to the carrier and BRC to properly process the claim, iv) All packaging materials must be retained until a freight inspection has been made and authorized by the carrier. Caution: Failure to note damages or shortages on the delivery slip or to retain packaging will make claims impossible.

d) Concealed loss or damage: i) Concealed loss or damage means loss or damage that does not become apparent until the merchandise has been unpacked. The carton contents may be damaged in transit due to rough handling even though the carton may not show external damage. The receiver of the merchandise must file for concealed damage with the carrier within 48 hours of receipt. ii) Photos of concealed damage must accompany the claim to the carrier, and must also be forwarded to BRC customer service to coordinate repair or replacement of goods. Failure to do so will make claims impossible.

e) Visible loss or damage: Any external evidence of loss or damage must be noted on the freight bill or delivery receipt and signed by the carrier's agent. Failure to adequately describe such external evidence of loss or damage may result in the carrier refusing to honor a damage claim. The form required to file such claim will be supplied by the carrier.

f) If the order is shipped directly to your customer, any claims should be handled through you using the procedure described in d), e).

g) No allowance is given for orders picked up at the factory.

h) Customer carrier: When the client chooses a carrier, all charges remain the responsibility of the client. BRC assumes no responsibility for insurance, standby, loss, damage, waiting, unloading, packing, haulage, or any other charges whatsoever associated with this carrier.

i) Backorders: Freight for all backorders will be the responsibility of the customer and will be billed at the time of the backorder shipment.

j) Customers may be subject to any and all extra freight costs including but not limited to freight charges for missed pickups or deliveries, extended wait times or unloading times, unauthorized use of freight or handling equipment, etc.

## Customer's Specifications

BRC actively solicits contract projects. Our advanced design and manufacturing capabilities facilitate custom project design with relative ease and extremely competitive prices.

## Product Specifications

BRC reserves the right to modify product specifications, materials, design or accessories without notice. BRC also reserves the right to halt production of any product at any time. The products, accessories, materials and finishes as described in the price list will prevail over the content of brochures or folders. BRC assumes no responsibility for lot changes in paint, material color or finishes. Customers are encouraged to verify specifications with current publications and price lists available on the company website at: [www.brc.group](http://www.brc.group)

## Weight/Volumes

The weights and volumes shown on the price lists include packaging, are approximate, and are listed per item unskidded. Volumes will vary with skidded shipments.

## Warrantees

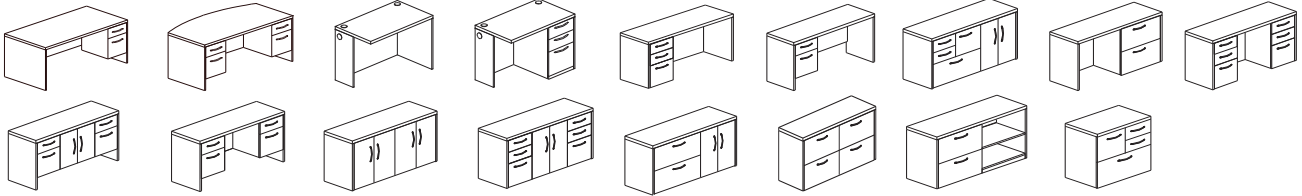
BRC product carries a 10 year limited structural warranty. Panel and table 8 wire electrical cabling carry a three year limited warranty. All moving user adjustable components carry a five year limited structural warranty. All other electrical or electronic elements of BRC furniture carry a one year limited warranty. The validity of these warranties starts at the date of purchase, and only if purchased directly from BRC or one of its authorized dealers. Only the warranty label, original purchase order or an original signed and dated bill of lading will be recognized as an official document as proof of purchase. These warranties are limited to replacing or repairing at BRC's option any defective products and only if the product has become defective through normal operating conditions. In order to process any warranty claim BRC requires photographs of the product shown in its entirety and at least two photos detailing the specific nature of the deficiency or warranty claim. BRC may request that product(s) are returned prepaid to BRC where assessment or repairs can be affected. All transportation charges remain the responsibility of the customer unless agreed upon in writing prior to receipt by BRC. All returned goods must have a return authorization number (RA#). These limited warranties do not apply to damages caused by accident, abuse, or adverse climatic conditions where temperatures and humidity exceed normal office conditions. These limited warranties will not be honored if BRC products are misused or if installation instructions are not followed properly. Any attempt by personnel unauthorized by BRC to repair or modify a BRC product will render these limited warranties invalid. The responsibility of BRC is limited exclusively to the above mentioned remedy. In no way will BRC be held responsible for circumstantial damages consequent to the use of their products. In the case of products such as paints and vinyls where manufacturers cannot warranty absolute color match, BRC declines all responsibility for any color variations, discrepancies or fading. BRC does not warrant the following: light bulbs or ballasts; grain match or colour variation, or products that must be replaced due to normal life cycle. Under no circumstances or event will BRC be liable in either tort or contract for any loss direct or indirect caused by special, incidental, consequential or exemplary damages caused by product or installation.

# Product Map

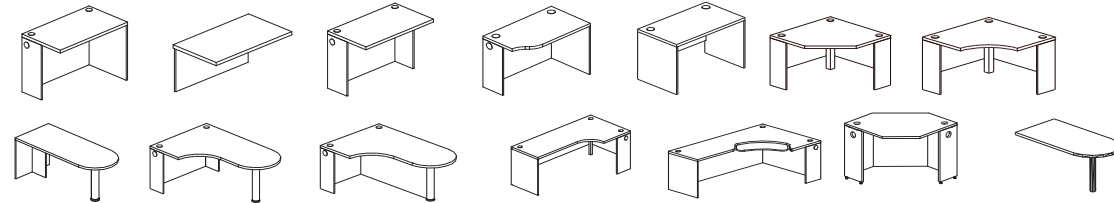
## RECEPTION



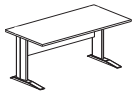
## TABLE DESKS, CRENZAS



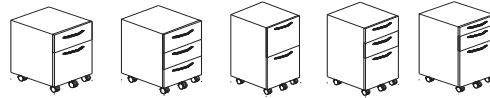
## TABLES



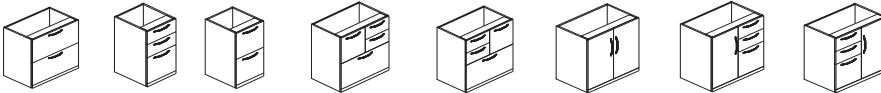
## SMART TABLES



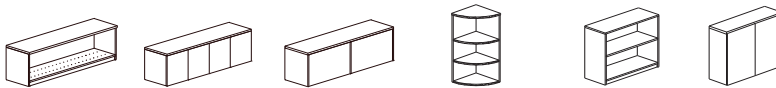
## MOBILE PEDESTALS



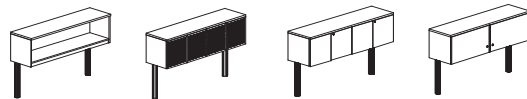
## DESK STORAGE



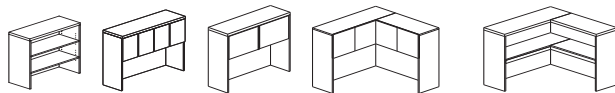
## WALL MOUNT STORAGE



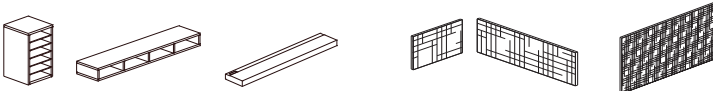
## POST MOUNTED STORAGE



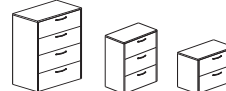
## DESK MOUNT HUTCH



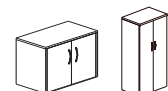
## HUTCH ACCESSORIES



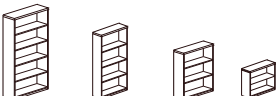
## LATERAL FILES



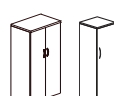
## CLOSED STORAGE



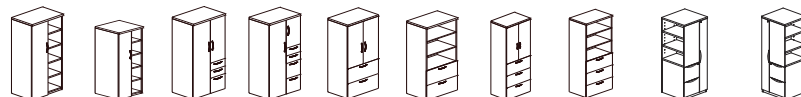
## BOOKCASES



## WARDROBES



## EXECUTIVE STORAGE



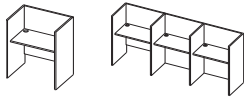
# Product Map



COMPUTER ACCESSORIES



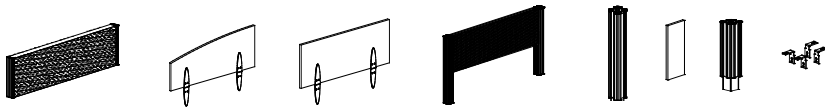
STUDY CARRELS



CONFERENCE & AUDIO-VISUAL



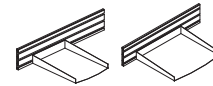
DESK PANELS



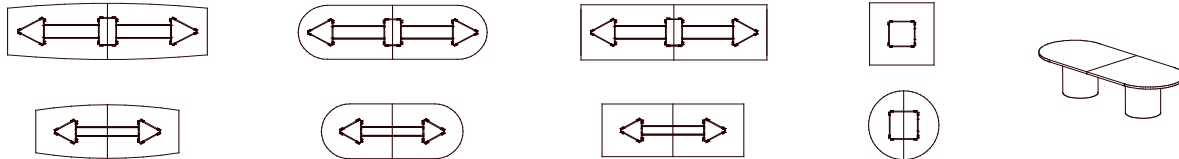
WIRE MANAGEMENT



ACCESSORY RAIL TRAYS



BOARDROOM TABLES



# Index

Product Overview		7
Product Finishes		8
Ordering Nomenclature		9
NATURAL	<b>Reception Desk Specifications</b>	<b>10</b>
NATURAL	Reception Desks	11
NATURAL	Reception Counter Tops, Posts & Inserts	16
NATURAL	<b>Table Desks, Desks, Bridges, Returns, Credenzas Specifications</b>	<b>20</b>
NATURAL	Table Desk	21
NATURAL	Desks	22
NATURAL	Bridge Tops/ Returns	27
NATURAL	Sculptured Bridge Tables	30
NATURAL	Credenzas	31
NATURAL	Personal Pedestals Credenzas Radiused	40
NATURAL	<b>Table Specifications</b>	<b>41</b>
NATURAL	Tables	42
NATURAL	Sculptured Tables	43
NATURAL	Smart C-Leg Tables	44
NATURAL	<b>Extended Corner Table Specifications</b>	<b>45</b>
NATURAL	Extended Corner Tables	46
NATURAL	Corner Tables	52
NATURAL	Bullet Tables	53
NATURAL	Extended Bullet Tables	56
NATURAL	Extended "P" Tables	58
NATURAL	<b>Modular Component Specifications</b>	<b>62</b>
NATURAL	Mobile Pedestals	63
NATURAL	Freestanding Storage	64
NATURAL	Modular Component Worksurfaces	66
NATURAL	<b>Wall Mounted Storage Specifications</b>	<b>67</b>
NATURAL	Wall Mounted Casegoods Storage	68
NATURAL	<b>Post Mounted Storage Specifications</b>	<b>70</b>
NATURAL	Post Mounted Storage	71
NATURAL	<b>Hutch Specifications</b>	<b>72</b>
NATURAL	Open Bookcase Hutches	73
NATURAL	Open Hutches	74
NATURAL	Closed Hutches	75
NATURAL	Sliding Door Hutches	77
NATURAL	Corner Hutches	79
NATURAL	Extended Corner Hutches	80

# Index

NATURAL	Hutch Accessories & Options	82
NATURAL	Tack Boards	83
NATURAL	<b>Storage Specifications</b>	<b>85</b>
NATURAL	<b>Bookcase &amp; Executive Storage Specifications</b>	<b>86</b>
NATURAL	Lateral Files	87
NATURAL	Lateral Height Closed Storage	88
NATURAL	Bookcases	90
NATURAL	Executive Storage	92
NATURAL	Keyboards	104
NATURAL	Accessories	106
NATURAL	Study Carrels	107
NATURAL	<b>Conference &amp; Audio-Visual Specifications</b>	<b>108</b>
NATURAL	Conference & Audio-Visual	109
NATURAL	Boardroom Credenzas	111
NATURAL	<b>Panel Specifications</b>	<b>112</b>
NATURAL	Panels	113
NATURAL	Panel Post Options	120
NATURAL	<b>Boardroom &amp; Meeting Table Specifications</b>	<b>122</b>
NATURAL	Boardroom Tables	123
NATURAL	Desking Electrical Accessories	125

# Product Overview

- Desks
- Tables
- Returns
- Bridges
- Corner Units
- Pedestals
- Modular Components
- Credenzas
- Hutches
- Bookcases
- Wardrobes
- Closed and Open Storage
- Executive Depth Storage
- Wall Mounted Components
- Adjustable Height Tables

**BRC is an ISO 9001 certified corporation.**

**All BRC products meet or exceed ANSI / BIFMA standards.**

Test reports from independent testing labs are available upon request.

Tables and desks are shipped knocked-down. Pedestals, credenzas, storage units and hutches are shipped assembled.

## **General Construction**

Tables, table desks, desks, bridges, returns and credenzas are available in a multitude of widths, depths and styles, with a vast array of drawer and storage arrangements.

Tables, bridges, returns and credenzas have flush modesty panels. Desks and table desks have modesty panels recessed 6".

Grommets are standard in the tops and recessed gables of bridges, returns and tables.

Two grommets are standard on all tops of tables, bridges, and returns. If single grommet is required for tables 48" wide or less, specify in part description.

Grommets are optional on desks, table desks and credenzas. If desired they must be specified with order.

Worksurfaces are available with four core/surface material options: M1 - 1" or M2 - 1-1/2" low pressure laminate and H1 - 1-1/8" or H2 - 1-1/2" HPL.

Accessory units (storage units, hutches, etc.) are constructed with 3/4" thick low pressure laminate. Worksurfaces, door and drawer fronts are also available in HPL.

All low pressure laminate panels are 45lbs density and finished both sides.

Gables are constructed of 1" thick, low pressure laminate.

Modesty panels are standard in 3/4 height (20") and are constructed of 1" thick, Low pressure laminate. Certain desks and credenzas come standard with full modesty panels. Modesty panels are optionally available in full height, half height (12"), and one-quarter height (7").

Black handles are standard on all pedestals and storage units. For other styles and finishes see BRC Finish Guide.

One pencil tray is included in every pedestal with a box drawer.

All drawers have 100 lb. rated, steel ball bearing sliders. All lateral file drawers have 150lb rated sliders.

Lateral file drawers have 4.2mm solid bottoms with a standard feature of an inter-lock (anti-tilt) mechanism.

## **Locks**

Locks are standard on all pedestals, hutches and storage units. Locks are not available on glazed door units.

All locks will be randomly keyed and cores installed, unless customer specifies keyed alike option. All orders requiring keyed alike cores must be noted at the time of order, and the specific requirements clearly detailed on the order.

There is no upcharge for keyed alike cores, however, they will not be installed in the lock barrels to facilitate easy key co-ordination.

## **Environmental Considerations**

BRC actively pursues improvements to products which improve the work and global environment. Its products are approved to the BIFMA M7.1 Indoor Air Quality Standard. All wood products are FSC Certified where possible and all adhesives, wherever possible, are water based or hot melt based to eliminate VOC emissions. All product surfaces, including edges, are sealed wherever possible to reduce or eliminate formaldehyde emissions. All fabrics carry the TERRATEX designation for sustainable textiles. All TERRATEX fabrics have 100% recycled fibers or natural material that is itself recyclable or compostable. A full copy of BRC's environmental policy and its movement towards ISO 14001 the international environmental standard is available upon request.

# Product Finishes

BRC Natural series product is available in low pressure (LPL) and high pressure (HPL) finishes, as listed in the BRC Finish Guide. All high pressure finish options:

- worksurfaces
- door and drawer fronts
- transaction surfaces

Certain products are available with all surfaces in high pressure laminate (HPL). Please consult customer service with your requirements.

Most products are offered in monochrome or two tone at no extra charge. Two tone products are manufactured as follows. (unless otherwise specified at time of order).

- Drawer fronts and bodies will match.
- All tops (horizontal surfaces) will match.
- All edge banding will match respective laminates or HPL (as per BRC Finish Guide).

Metal finishes are available in:

- Black
- Silver

Custom finishes are available. Minimum charges may apply.

All visible edge trim finishes are durable 2.5mm PVC hot melt applied. The choice of trim and trim finish is listed in the BRC finish guide. All custom HPL finishes must have an edge detail specified at time of order.

In the case that worksurfaces are specified in wood grain laminates, the worksurface edge trim will be matching wood grain edge banding.

## **Special Laminates**

Formica and Wilsonart HPL: See minimum below for any non-carded HPL.  
Nevamar and Pionite add 20% to HPL **list** prices, and apply minimum below.  
All special HPL finishes have a minimum \$120.00 NET charge.  
**All custom laminate must be factory approved for costs and availability.**

## **Fabrics**

Please consult the BRC finish guide for available fabrics.  
Given the modularity of the Natural product, all fabrics must be railroaded.  
All COM (Customer's Own Material) fabrics must be shipped prepaid and approved by the factory.  
BRC is not responsible for delays or costs incurred with processing COM orders.  
BRC does not warranty COM fabrics including the manufacturing, assembly, or labour involved in their use of COM.

## **Installation**

Products that contain a door or drawer (eg. pedestal or hutch) will be shipped from the factory fully assembled. Otherwise, product will be shipped unassembled.  
Installation manuals are available upon request.



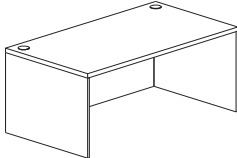
# Ordering Nomenclature

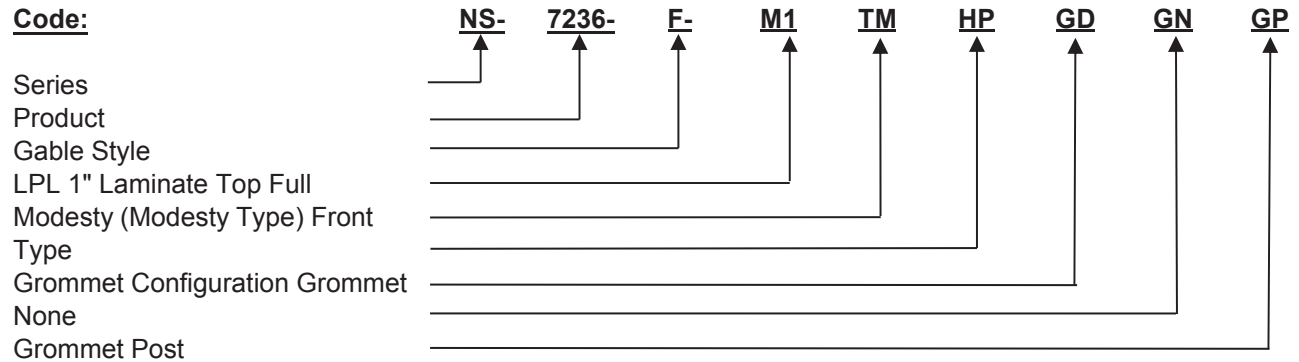
## HOW TO ORDER NATURAL SERIES PRODUCT

The following examples list descriptions and corresponding codes for frequently specified products:

**Table - all surfaces LPL, 1 color, 1" worksurface, full gables:**

**Code:** NS7236FM1

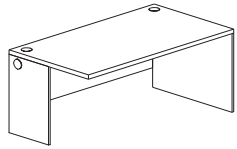
Natural Series:	NS		Specify per item: (a) Single finish of item or 2 tone finishes. (b) Metal Finish if applicable.
Rectangular Table Size:	7236		
Gable Full:	F		
LPL 1" Laminate Top: 3/4	M1		
Modesty -Standard (No Code)			

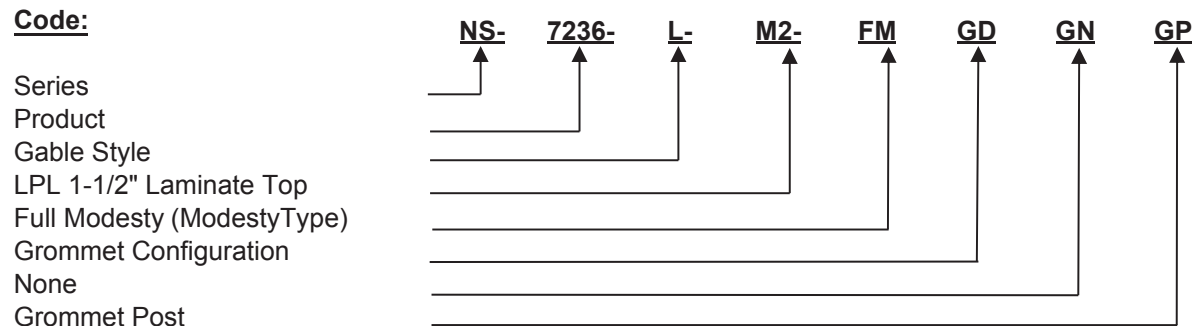


**Table - all surfaces LPL, 2 colors, 1-1/2" worksurface, left recessed gable:**

**Description:**

**Code:** NS7236LM2FM

Natural Series:	NS		Specify per item: (a) Single finish of item or 2 tone finishes. (b) Metal Finish if applicable.
Rectangular Table Size:	7236		
Gable Style Left Recessed LPL	L		
1-1/2" Laminate Top: Full Modesty	M2		
	FM		



# Reception Desks

Worksurfaces are available with four core/surface material options, 1" or 1-1/2" LPL and 1-1/8" or 1-1/2" HPL. Worksurfaces, door and drawer fronts are available in HPL or LPL. All other surfaces are available in LPL, as per BRC Finish Guide. Transaction surfaces can be either bow front or rectangular.

Optionally available with Classic and Landscape fronts. See below.

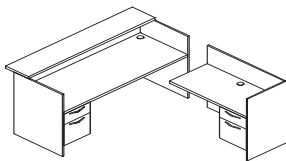
All doors, drawer fronts, and modesties are 3/4" thick. All gables are 1: thick. All surfaces, vertical and horizontal, are banded with PVC edge. All drawer suspensions are 100lbs rated steel ball bearing.

One pencil tray is included in every pedestal with a box drawer. Handles are standard on all drawers.

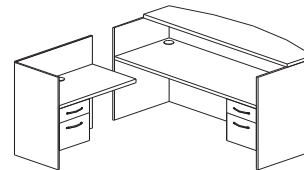
Grommets are standard, two on main worksurfaces, one on return worksurfaces.

Locks with interchangeable cores are standard on all pedestals.

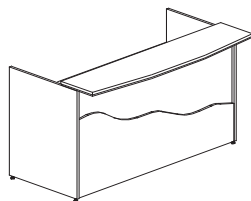
Other sizes available upon request.



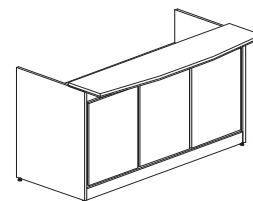
**Gallery Reception Desk, Right Return**



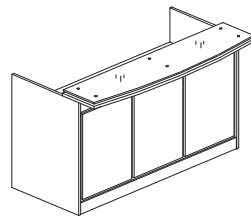
**Bow Top Gallery Reception Desk, Left Return**



**Optional LANDSCAPE Front**  
(front shown without return)



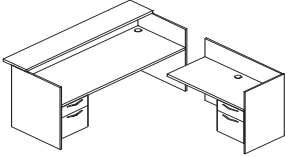
**Optional CLASSIC Front**  
(front shown without return)



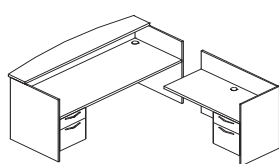
**Optional GLASS transaction top**

\* Please note, expandable modular style galleries are created by choosing tables, corners or returns from Natural's standard product offering and adding reception transaction hutches. Reception hutches are available with or without glazing. Accent transactions tops, suspended on steel posts can be selected from reception gallery pages.

# Reception Desks

RECEPTION DESKS, LEFT WITH LOWER STORAGE	Model	Size (WDH)	Wt./Cube	LPL		HPL	
				1"	1-1/2"	1-1/8"	1-1/2"
	NSGM(*)9630L(X)	96x30x42	310/74	1,826	1,953	1,967	2,136
	NSGM(*)8430L(X)	84x30x42	302/69	1,597	1,708	1,720	1,868
	NSGM(*)7830L(X)	78x30x42	295/64	1,383	1,493	1,506	1,653
	NSGM(*)7230L(X)	72x30x42	278/59	1,198	1,309	1,321	1,469
	NSGM(*)6630L(X)	66x30x42	260/50	1,167	1,278	1,289	1,437
	NSGM(*)6030L(X)	60x30x42	258/47	1,135	1,246	1,258	1,406

**Main Left Accepts Right Return** *Return not included.*



NSBGM(*)9630L(X)	96x30x42	310/74	1,931	2,094	2,106	2,275
NSBGM(*)8430L(X)	84x30x42	302/69	1,689	1,831	1,843	1,991
NSBGM(*)7830L(X)	78x30x42	295/64	1,474	1,616	1,629	1,776
NSBGM(*)7230L(X)	72x30x42	278/59	1,290	1,372	1,444	1,592
NSBGM(*)6630L(X)	66x30x42	268/53	1,259	1,341	1,412	1,560
NSBGM(*)6030L(X)	60x30x42	258/47	1,227	1,309	1,381	1,529

**Bow Top Gallery Main Left Accepts Right Return** *Return not included.*

<b>Right Ped Gallery Return for Main Left Galleries</b>	NSGR(*)6024R(X)	60x24x42	145/36	1,050	1,399	1,204	1,342
	NSGR(*)5424R(X)	54x24x42	142/34	1,019	1,367	1,173	1,310
	NSGR(*)4824R(X)	48x24x42	142/33	840	950	963	1,073
	NSGR(*)4224R(X)	42x24x42	139/29	795	914	918	1,036
	NSGR(*)3624R(X)	36x24x42	136/26	763	882	886	1,005

**Ordering Details:** Transaction tops and worksurfaces:  
(X) - Specify 'M1' for 1" LPL, 'M2' for 1-1/2" LPL, 'H1' for 1-1/8" HPL, or 'H2' for 1-1/2" HPL.

Optional for transaction tops: 3/4" brushed aluminum accent reveal (specify SVR) or 3/4" black accent reveal (specify BVR) at the end of the product code.

Add \$236.00 list to M2 or H2 above prices.

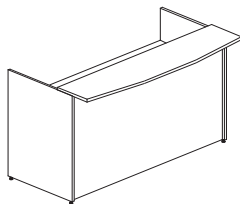
(\*) - To change Box/File Pedestal shown to 2 Box/File, insert "F"; to 2 File, insert "2F", add \$121 to list price.

Grommets are standard, two on main worksurfaces, one on return worksurfaces.

Custom size tables are available. Please call for details and pricing.

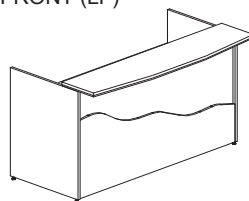
**HPL drawer fronts add \$121 list to above prices, and specify on order.**

STANDARD FRONT



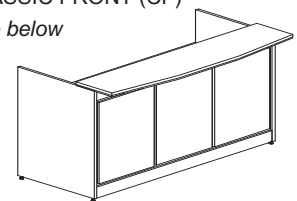
LANDSCAPED FRONT (LF)

*See below*



CLASSIC FRONT (CF)

*See below*

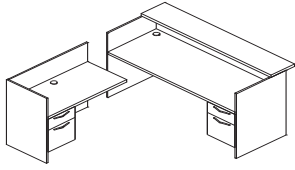


**For landscape fronts, add \$341 to list price, and LF to model number.**

**For classic fronts, add \$341 to list price, and CF to model number.**

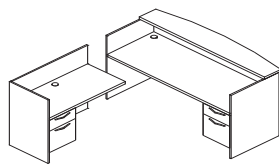
Landscape and Classic fronts will match transaction finish, unless specified with order.

# Reception Desks

RECEPTION DESKS, RIGHT WITH LOWER STORAGE	Model	Size (WDH)	Wt./Cube	LPL		HPL	
				1"	1-1/2"	1-1/8"	1-1/2"
	NSGM(*)9630R(X)	96x30x42	310/74	1,826	1,953	1,967	2,136
	NSGM(*)8430R(X)	84x30x42	302/69	1,597	1,708	1,720	1,868
	NSGM(*)7830R(X)	78x30x42	295/64	1,383	1,493	1,506	1,653
	NSGM(*)7230R(X)	72x30x42	278/59	1,198	1,309	1,321	1,469
	NSGM(*)6630R(X)	66x30x42	260/50	1,167	1,278	1,289	1,437
	NSGM(*)6030R(X)	60x30x42	258/47	1,135	1,246	1,258	1,406

**Main Right Accepts Left Return**

*Return not included.*



NSBGM(*)9630R(X)	96x30x42	310/74	1,931	2,094	2,106	2,275
NSBGM(*)8430R(X)	84x30x42	302/69	1,689	1,831	1,843	1,991
NSBGM(*)7830R(X)	78x30x42	295/64	1,474	1,616	1,629	1,776
NSBGM(*)7230R(X)	72x30x42	278/59	1,290	1,372	1,444	1,592
NSBGM(*)6630R(X)	66x30x42	268/53	1,259	1,341	1,412	1,560
NSBGM(*)6030R(X)	60x30x42	258/47	1,227	1,309	1,381	1,529

**Bow Top Gallery Main Right Accepts Left Return**

*Return not included.*

**Left Ped Gallery Return for Main Right Galleries**

NSGR(*)6024L(X)	60x24x42	145/36	1,050	1,399	1,204	1,342
NSGR(*)5424L(X)	54x24x42	142/34	1,019	1,367	1,173	1,310
NSGR(*)4824L(X)	48x24x42	142/33	840	950	963	1,073
NSGR(*)4224L(X)	42x24x42	139/29	795	914	918	1,036
NSGR(*)3624L(X)	36x24x42	136/26	763	882	886	1,005

**Ordering Details:**

Transaction tops and worksurfaces:

(X) - Specify 'M1' for 1" LPL, 'M2' for 1-1/2" LPL, 'H1' for 1-1/8" HPL, or 'H2' for 1-1/2" HPL.

Optional for transaction tops: 3/4" brushed aluminum accent reveal (specify SVR) or 3/4" black accent reveal (specify BVR) at the end of the product code.

Add \$236.00 list to M2 or H2 above prices.

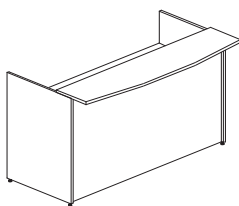
(\*) - To change Box/File Pedestal shown to 2 Box/File, insert "F"; to 2 File, insert "2F", add \$121 to list price.

Grommets are standard, two on main worksurfaces, one on return worksurfaces.

Custom size tables are available. Please call for details and pricing.

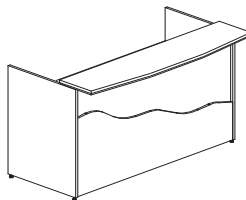
**HPL drawer fronts add \$121 list to above prices, and specify on order.**

STANDARD FRONT



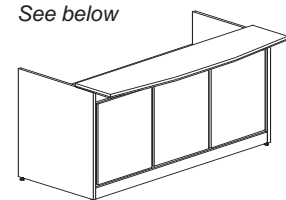
LANDSCAPED FRONT (LF)

*See below*



CLASSIC FRONT (CF)

*See below*

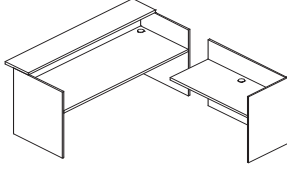


**For landscape fronts, add \$341 to list price, and LF to model number.**

**For classic fronts, add \$341 to list price, and CF to model number.**

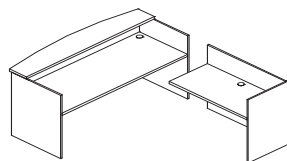
Landscape and Classic fronts will match transaction finish, unless specified with order.

# Reception Desks

RECEPTION DESKS, LEFT OPEN	Model	Size (WDH)	Wt./Cube	LPL		HPL	
				1"	1-1/2"	1-1/8"	1-1/2"
	NSGMO9630L(X)	96x30x42	310/74	1,616	1,743	1,757	1,926
	NSGMO8430L(X)	84x30x42	302/69	1,387	1,498	1,510	1,658
	NSGMO7830L(X)	78x30x42	295/64	1,173	1,283	1,296	1,443
	NSGMO7230L(X)	72x30x42	278/59	988	1,099	1,111	1,259
	NSGMO6630L(X)	66x30x42	260/50	957	1,068	1,079	1,227
	NSGMO6030L(X)	60x30x42	258/47	925	1,036	1,048	1,196

**Main Left Accepts Right Return**

*Return not included.*



NSBGMO9630L(X)	96x30x42	310/74	1,721	1,884	1,896	2,065
NSBGMO8430L(X)	84x30x42	302/69	1,479	1,621	1,633	1,781
NSBGMO7830L(X)	78x30x42	295/64	1,264	1,406	1,419	1,566
NSBGMO7230L(X)	72x30x42	278/59	1,080	1,162	1,234	1,382
NSBGMO6630L(X)	66x30x42	268/53	1,049	1,131	1,202	1,350
NSBGMO6030L(X)	60x30x42	258/47	1,017	1,099	1,171	1,319

**Bow Top Gallery Main Left Accepts Right Return**

*Return not included.*

**Right Open Gallery Return for Main Left Galleries**

NSGRO6024R(X)	60x24x42	145/36	840	1,189	994	1,132
NSGRO5424R(X)	54x24x42	142/34	809	1,157	963	1,100
NSGRO4824R(X)	48x24x42	142/33	630	740	753	863
NSGRO4224R(X)	42x24x42	139/29	585	704	708	826
NSGRO3624R(X)	36x24x42	136/26	553	672	676	795

**Ordering Details:**

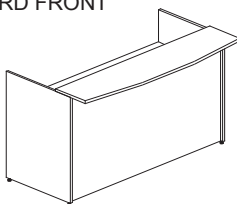
Transaction tops and worksurfaces:  
 (X) - Specify 'M1' for 1" LPL, 'M2' for 1-1/2" LPL, 'H1' for 1-1/8" HPL, or 'H2' for 1-1/2" HPL.

Optional for transaction tops: 3/4" brushed aluminum accent reveal (specify SVR) or 3/4" black accent reveal (specify BVR) at the end of the product code.  
 Add \$236.00 list to M2 or H2 above prices.

Grommets are standard, two on main worksurfaces, one on return worksurfaces.

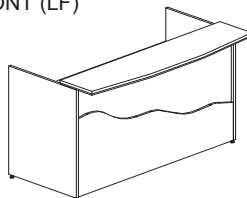
Custom size tables are available. Please call for details and pricing.

STANDARD FRONT



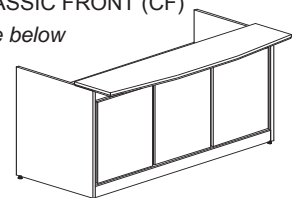
LANDSCAPED FRONT (LF)

*See below*



CLASSIC FRONT (CF)

*See below*



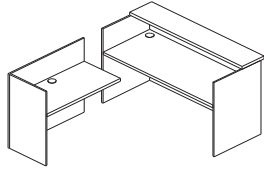
**For landscape fronts, add \$341 to list price, and LF to model number.**

**For classic fronts, add \$341 to list price, and CF to model number.**

Landscape and Classic fronts will match transaction finish, unless specified with order.

# Reception Desks

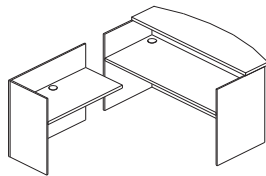
RECEPTION DESKS, RIGHT OPEN	Model	Size (WDH)	Wt./Cube	LPL		HPL	
				1"	1-1/2"	1-1/8"	1-1/2"



NSGMO9630R(X)	96x30x42	310/74	1,616	1,743	1,757	1,926
NSGMO8430R(X)	84x30x42	302/69	1,387	1,498	1,510	1,658
NSGMO7830R(X)	78x30x42	295/64	1,173	1,283	1,296	1,443
NSGMO7230R(X)	72x30x42	278/59	988	1,099	1,111	1,259
NSGMO6630R(X)	66x30x42	260/50	957	1,068	1,079	1,227
NSGMO6030R(X)	60x30x42	258/47	925	1,036	1,048	1,196

**Main Right Accepts Left Return**

*Return not included.*



NSBGMO9630R(X)	96x30x42	310/74	1,721	1,884	1,896	2,065
NSBGMO8430R(X)	84x30x42	302/69	1,479	1,621	1,633	1,781
NSBGMO7830R(X)	78x30x42	295/64	1,264	1,406	1,419	1,566
NSBGMO7230R(X)	72x30x42	278/59	1,080	1,162	1,234	1,382
NSBGMO6630R(X)	66x30x42	268/53	1,049	1,131	1,202	1,350
NSBGMO6030R(X)	60x30x42	258/47	1,017	1,099	1,171	1,319

**Bow Top Gallery Main Right Accepts Left Return**

*Return not included.*

**Left Open Gallery Return for Main Right Galleries**

NSGRO6024L(X)	60x24x42	145/36	840	1,189	994	1,132
NSGRO5424L(X)	54x24x42	142/34	809	1,157	963	1,100
NSGRO4824L(X)	48x24x42	142/33	630	740	753	863
NSGRO4224L(X)	42x24x42	139/29	585	704	708	826
NSGRO3624L(X)	36x24x42	136/26	553	672	676	795

**Ordering Details:**

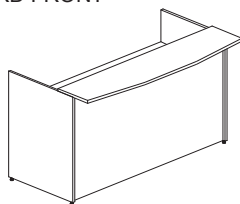
Transaction tops and worksurfaces:  
 (X) - Specify 'M1' for 1" LPL, 'M2' for 1-1/2" LPL, 'H1' for 1-1/8" HPL, or 'H2' for 1-1/2" HPL.

Optional for transaction tops: 3/4" brushed aluminum accent reveal (specify SVR) or 3/4" black accent reveal (specify BVR) at the end of the product code.  
 Add \$236.00 list to M2 or H2 above prices.

Grommets are standard, two on main worksurfaces, one on return worksurfaces.

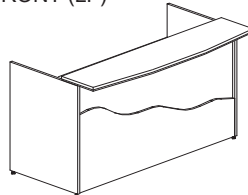
Custom size tables are available. Please call for details and pricing.

STANDARD FRONT



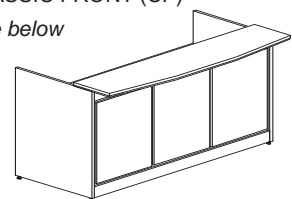
LANDSCAPED FRONT (LF)

*See below*



CLASSIC FRONT (CF)

*See below*



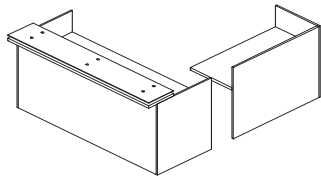
**For landscape fronts, add \$341 to list price, and LF to model number.**

**For classic fronts, add \$341 to list price, and CF to model number.**

Landscape and Classic fronts will match transaction finish, unless specified with order.

# Reception Desks - Glass Transaction

RECEPTION GLASS TRANSACTION TOPS	Model	Size (WDH)	Wt./Cube	Price
----------------------------------	-------	------------	----------	-------

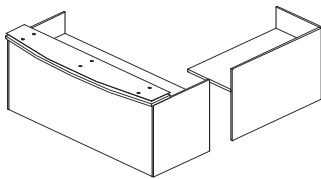


*Includes 10 MM Tempered Glass Top and silver standoffs*

**Glass for Rectangular Transaction**

RECPR96G(X)	96x14	30/22	2,676
RECPR90G(X)	90x14	28/20	2,508
RECPR84G(X)	84x14	26/18	2,102
RECPR78G(X)	78x14	24/16	1,412
RECPR72G(X)	72x14	22/14	1,976
RECPR66G(X)	66x14	22/12	1,913
RECPR60G(X)	60x14	20/10	1,485

*Reception desk not included.*



*Includes 10 MM Tempered Glass Top and silver standoffs*

**Glass for Bow Transaction**

RECPBW96G(X)	96x14	30/22	2,676
RECPBW90G(X)	90x14	28/20	2,508
RECPBW84G(X)	84x14	26/18	2,102
RECPBW78G(X)	78x14	24/16	1,412
RECPBW72G(X)	72x14	22/14	1,976
RECPBW66G(X)	66x14	22/12	1,913
RECPBW60G(X)	60x14	20/10	1,485

*Reception desk not included.*


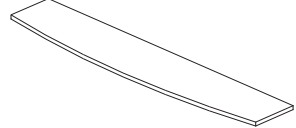
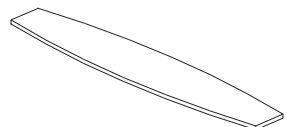
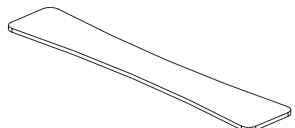
**Note:**

10 MM glass transaction top with chamfer edge. Silver standoff hardware included. Can be configured with reception desk from factory or ordered and drilled on site later.

**Ordering Details:**

When ordering glass transaction top, specify clear or frosted glass.

# Laminate Transaction Top

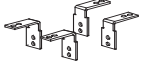
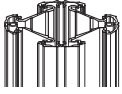

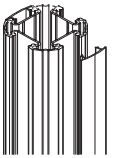

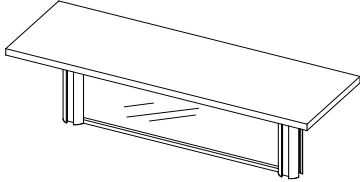
RECEPTION TRANSACTION TOPS	Model	Size (WDH)	Wt./Cube	LPL		HPL	
				1"	1-1/2"	1-1/8"	1-1/2"
 <p><i>Includes worksurface only</i> <b>Rectangular Transaction</b> Work Surface for Post System</p>	RECPR72(X)	72x14	22/14	299	370	377	512
	RECPR66(X)	66x14	22/12	291	358	366	498
	RECPR60(X)	60x14	20/10	287	353	360	490
	RECPR54(X)	54x14	18/6	281	348	355	483
	RECPR48(X)	48x14	16/6	193	239	245	333
	RECPR42(X)	42x14	14/5	185	229	233	318
	RECPR36(X)	36x14	12/4	175	217	223	303
	RECPR30(X)	30x14	10/3	141	174	179	244
RECPR24(X)	24x14	8/2	123	152	155	214	
 <p><i>Includes worksurface only</i> <b>Bow Transaction</b> Work Surface for Post System</p>	RECBW72(X)	72x14	22/14	310	380	387	523
	RECBW66(X)	66x14	22/12	301	369	377	508
	RECBW60(X)	60x14	20/10	297	363	371	501
	RECBW54(X)	54x14	18/6	292	358	365	494
	RECBW48(X)	48x14	16/6	204	250	255	343
	RECBW42(X)	42x14	14/5	195	239	244	329
	RECBW36(X)	36x14	12/4	186	228	233	314
	RECBW30(X)	30x14	10/3	151	185	189	254
RECBW24(X)	24x14	8/2	133	163	166	225	
 <p><i>Includes worksurface only</i> <b>Boat Shape Transaction</b> Work Surface for Post System</p>	RECPB72(X)	72x14	22/14	310	380	387	523
	RECPB66(X)	66x14	22/12	301	369	377	508
	RECPB60(X)	60x14	20/10	297	363	371	501
	RECPB54(X)	54x14	18/6	292	358	365	494
	RECPB48(X)	48x14	16/6	204	250	255	343
	RECPB42(X)	42x14	14/5	195	239	244	329
	RECPB36(X)	36x14	12/4	186	228	233	314
	RECPB30(X)	30x14	10/3	151	185	189	254
RECPB24(X)	24x14	8/2	133	163	166	225	
 <p><i>Includes worksurface only</i> <b>Dog Bone Transaction</b> Work Surface for Post System</p>	RECPD72(X)	72x14	22/14	310	380	387	523
	RECPD66(X)	66x14	22/12	301	369	377	508
	RECPD60(X)	60x14	20/10	297	363	371	501
	RECPD54(X)	54x14	18/6	292	358	365	494
	RECPD48(X)	48x14	16/6	204	250	255	343
	RECPD42(X)	42x14	14/5	195	239	244	329
	RECPD36(X)	36x14	12/4	186	228	233	314
	RECPD30(X)	30x14	10/3	151	185	189	254
RECPD24(X)	24x14	8/2	133	163	166	225	

**Ordering Details:**

(X) - Specify 'M1' for 1" LPL, 'M2' for 1-1/2" LPL, 'H1' for 1-1/8" HPL, or 'H2' for 1-1/2" HPL.



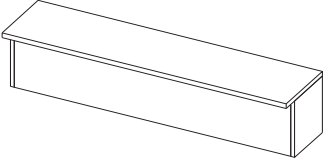
# Reception Panel & Post

RECEPTION DESK POST ACCESSORIES	Model	Size (WDH)	Wt./Cube	Price
 <b>Post Mount Bracket Kit for Transaction Work Surface</b>	DSPKIT 4 <i>Note: Kit is for one Post.</i>	1"w x 2"h		40
 <b>Desk Panel Post</b>	DSP12(*) <i>Mounting hardware included; additional heights on page 137.</i>	3" Dia x 12"h	10/.3	88
 <b>Desk Panel Post Cap</b>	DSPCAP(*)	3" Dia		39
 <b>Desk Panel Post Covers</b>	DSPCOVER			1.05 per/ft.
 <b>Panel Support Bracket</b>	PSB-6BLACK PSB-6SILVER	7x7 7x7	.5/.5 .5/.5	86 86
 <i>Worksurface &amp; Posts not included</i> <b>Reception Counter Glazed Insert</b> <i>Aluminum frame &amp; frosted plexiglass</i>	ADPGG72 ADPGG66 ADPGG60 ADPGG54 ADPGG48 ADPGG42 ADPGG36 ADPGG30 ADPGG24	62x12 56x12 50x12 44x12 38x12 32x12 26x12 20x12 14x12	22/14 22/12 20/10 18/6 16/6 14/5 12/4 10/3 8/2	487 468 449 415 394 377 357 326 305

**Ordering Details:**

(\*) Specify Black or Silver Posts

# Open Reception Hutches

MODULAR RECEPTION HUTCHES	Model	Size (WDH)	Wt./Cube	LPL		HPL	
				1"	1-1/2"	1-1/8"	1-1/2"
 <p><b>Laminate Reception Hutch</b></p>	RDO84(X)	84x14x14	75/13.5	560	646	633	719
	RDO78(X)	78x14x14	70/12.6	525	611	599	685
	RDO72(X)	72x14x14	65/11.6	488	574	562	648
	RDO66(X)	66x14x14	60/10.7	452	538	525	611
	RDO60(X)	60x14x14	55/9.7	371	457	444	530
	RDO54(X)	54x14x14	50/8.8	351	437	424	510
	RDO48(X)	48x14x14	45/7.9	309	395	382	468
	RDO42(X)	42x14x14	43/6.9	291	377	364	450
	RDO36(X)	36x14x14	40/5.9	269	354	342	428
	RDO30(X)	30x14x14	32/5.0	169	255	243	329
	RDO24(X)	24x14x14	28/4.1	161	246	234	320

*Note: RDO's have 13" of clearance from table.*

**Ordering Details:**

(X) - Specify 'M1' for 1" LPL, 'M2' for 1-1/2" LPL, 'H1' for 1-1/8" HPL, or 'H2' for 1-1/2" LPL.

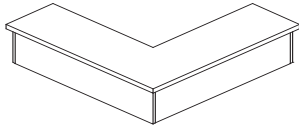
**Options:**

Custom sizes are available. Please call for details and pricing.  
Pigeon hole dividers are available, see hutch accessories section.

Tackboard option available for Laminate Reception Hutch. Refer to page 96.

# Open Corner Reception Hutches

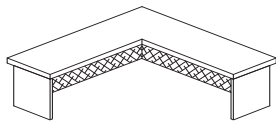
MODULAR RECEPTION CORNER HUTCHES	Model	Size (WDH)	Wt./Cube	LPL		HPL	
				1"	1-1/2"	1-1/8"	1-1/2"



**Laminate Option**

CRDO48(X)	48x14x14	95/10.0	676	848	799	885
CRDO42(X)	42x14x14	85/9.0	553	726	676	762
CRDO36(X)	36x14x14	75/8.0	516	688	638	725

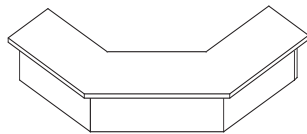
**Reception Corner,  
Transaction Height**



*Fabric option shown.*

**Fabric Option.**

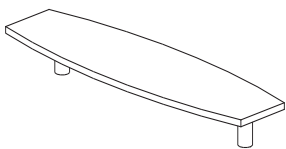
CRDO48FAB(X)	48x14x14	95/10.0	866	1,038	978	1,075
CRDO42FAB(X)	42x14x14	85/9.0	732	903	855	941
CRDO36FAB(X)	36x14x14	75/8.0	675	847	798	884



**Angled Reception  
Corner, Transaction  
Height**

*Note: CRDO's have 13" of clearance from table.*

*Note: For angled reception corners add "KR" to above model numbers and 263.00 to list price.*



**Transaction Table for  
Modular Receptions**

RECTR72(X)	72x14x7	22/14	488	574	562	648
RECTR66(X)	66x14x7	22/12	452	538	525	611
RECTR60(X)	60x14x7	20/10	371	457	444	530
RECTR54(X)	54x14x7	18/6	351	437	424	510
RECTR48(X)	48x14x7	16/6	309	395	382	468
RECTR42(X)	42x14x7	14/5	291	377	364	450
RECTR36(X)	36x14x7	12/4	269	354	342	428
RECTR30(X)	30x14x7	10/3	169	255	243	329

*Above includes all mounting brackets and posts.*

*Specify post color, silver or black.*

**Ordering Details:**

(X) - Specify 'M1' for 1" LPL, 'M2' for 1-1/2" LPL, 'H1' for 1-1/8" HPL, or 'H2' for 1-1/2" HPL.

**Options:**

Custom sizes are available. Please call for details and pricing.

# Desks, Bridges, Returns & Credenzas

BRC manufactures tables, table desks, desks, bridges, returns and credenzas. They are available in a multitude of widths, depths and styles, with a vast array of drawer and storage arrangements. **For clarification:** tables, bridges, returns and credenzas have flush modesty panels. Desks and table desks have modesty panels recessed 6".

Modesty panels are standard in 3/4 height (20") and are constructed of 1" thick, high density, LPL. Certain desks and credenzas come standard with full modesty panels.

Modesty panels are optionally available in full height, half height (12"), and one-quarter height (7").

Grommets are standard in the tops and recessed gables of bridges, returns and tables.

Two grommets are standard on all tops of tables, bridges, and returns.

Grommets are optional on desks, table desks and credenzas. If desired they must be specified at time of order.

All worksurfaces are available with four core/surface material options, M1 - 1" or M2 - 1-1/2" thick high density LPL and H1 - 1-1/8" or H2 - 1-1/2" thick HPL, including woodgrain finishes.

All gables and modesty panels are 1" thick.

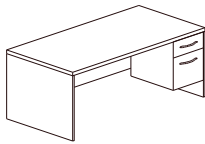
All drawers have 100 lb. rated, steel ball bearing sliders. All lateral file drawers have 150lb rated sliders. Interlocking lock mechanism is standard on all lateral file drawers.

Locks are standard on all pedestals and cabinets. Keyed alike locks must be specified.

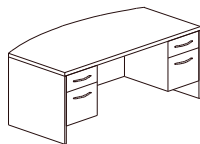
Drawer pulls are standard on all drawers.

One pencil tray is included in every pedestal with a box drawer.

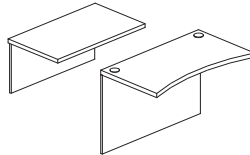
Silver or Black (0.5" height) reveal available. Specify laminate M2 or H2 and add code SVR/BVR + 40% to list price.



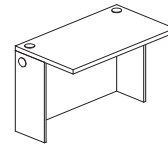
**Single Right Pedestal  
3/4 Modesty, Box-File**



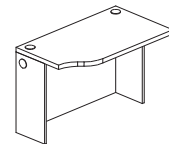
**Bow Top Double Pedestal  
3/4 Modesty, Box-File L & R**



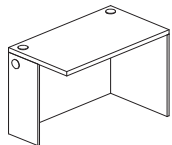
**Bridge Tops  
& Modesty**



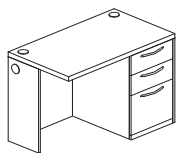
**Bridge Table w/Double  
Recessed Gables &  
Full Modesty**



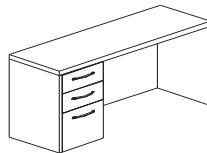
**Single Sculpture  
Left, Full Modesty**



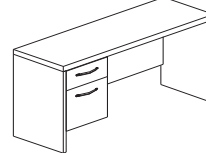
**Open Return  
Full Modesty**



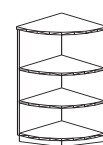
**Return Right Pedestal  
Full Modesty  
2 Box, File**



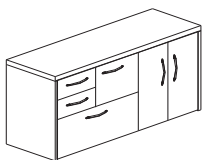
**Single Left Pedestal  
Credenza, Full Modesty  
2 Box, File**



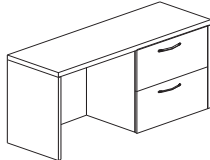
**Single Left Pedestal  
Credenza 3/4 Modesty  
Box, File**



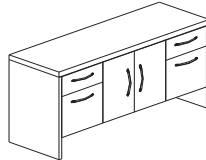
**Credenza Corner  
Radiused End Bookcase**



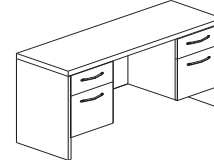
**Personal Pedestal/  
Storage Credenza  
Personal Pedestal RF Left  
Closed Storage Right**



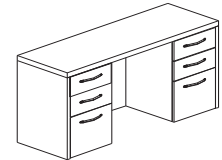
**Lateral Right  
Credenza**



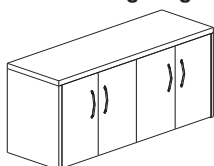
**Full Credenza, 3/4 Mod  
Box, File Left and Right  
Closed Storage, Center**



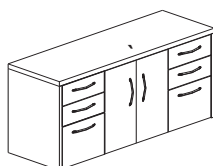
**Kneespace Credenza  
3/4 Modesty  
Box, File Left & Right**



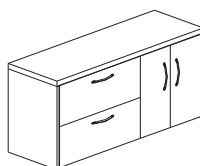
**Kneespace Credenza  
Full Modesty  
2 Box, File Left & Right**



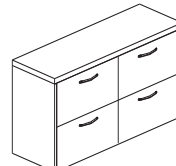
**Double Closed  
Storage Credenza**



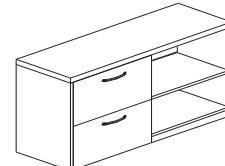
**Full Credenza  
2 Box, File Left & Right**



**Lateral / Storage  
Credenza**

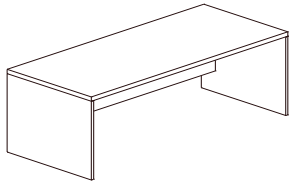
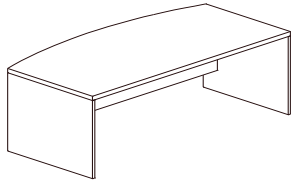


**Double  
Lateral**



**Lat./Storage Credenza  
Lat. Left, Open Right**

# Table Desks

TABLE DESKS	Model	Size (WDH)	Wt./Cube	LPL		HPL		
				1"	1-1/2"	1-1/8"	1-1/2"	
	NSD8442TD(X)	84x42x29	204/12.9	944	1,002	1,067	1,125	
	NSD7842TD(X)	78x42x29	197/11.9	920	994	1,053	1,114	
	NSD7242TD(X)	72x42x29	193/11.0	870	981	1,041	1,101	
	NSD8436TD(X)	84x36x29	196/12.9	893	992	966	1,113	
	NSD7836TD(X)	78x36x29	187/11.9	861	966	942	1,094	
	NSD7236TD(X)	72x36x29	181/9.5	809	944	931	1,079	
	NSD6636TD(X)	66x36x29	164/8.8	758	907	881	1,030	
	NSD6036TD(X)	60x36x29	113/8.0	764	863	851	949	
	<b>Rectangular 3/4 Recessed Modesty</b>	NSD8430TD(X)	84x30x29	170/11.0	676	735	823	882
		NSD7830TD(X)	78x30x29	160/10.0	634	693	781	840
NSD7230TD(X)		72x30x29	150/9.0	529	588	676	735	
NSD6630TD(X)		66x30x29	142/8.0	519	569	667	717	
NSD6030TD(X)		60x30x29	131/7.0	491	549	639	697	
NSD5430TD(X)		54x30x29	128/6.6	483	541	631	689	
NSD4830TD(X)		48x30x29	125/6.0	458	507	605	654	
NSD4230TD(X)		42x30x29	120/5.8	449	499	596	646	
	NSBOW8442TD(X)	84x42x29	204/12.9	1,024	1,115	1,147	1,238	
	NSBOW7842TD(X)	78x42x29	197/11.9	1,000	1,090	1,122	1,213	
	NSBOW7242TD(X)	72x42x29	193/11.0	974	1,066	1,097	1,189	
	NSBOW6642TD(X)	66x42x29	188/10.2	947	1,045	1,071	1,160	
	NSBOW6042TD(X)	60x42x29	180/9.6	929	1,031	1,048	1,142	
	NSBOW8436TD(X)	84x36x29	196/12.9	1,003	1,093	1,126	1,216	
	NSBOW7836TD(X)	78x36x29	187/11.9	977	1,067	1,099	1,190	
	NSBOW7236TD(X)	72x36x29	181/9.5	950	1,041	1,073	1,163	
	NSBOW6636TD(X)	66x36x29	164/8.8	926	1,016	1,049	1,139	
	NSBOW6036TD(X)	60x36x29	153/8.2	901	992	1,024	1,115	

**Ordering Details:**

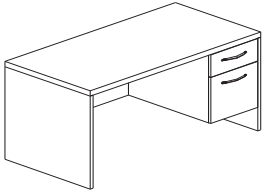
(X) - Specify 'M1' for 1" LPL, 'M2' for 1-1/2" LPL, 'H1' for 1-1/8" HPL, or 'H2' for 1-1/2" HPL.

**Options:**

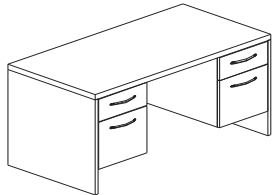
**Full Modesty Panels are available, add "FM" to part.  
 1/2 Modesty Panels (12") are available, add "TM" to part.  
 1/4 Modesty Panels (7") are available, add "QM" to part. & 158.00 to price.**

Custom size tables are available. Please call for details and pricing.

# Desks

STANDARD DESKS	Model	Size (WDH)	Wt./Cube	LPL		HPL	
				1"	1-1/2"	1-1/8"	1-1/2"
	NSD8442(R)(X)	84x42x29	254/61.0	1,085	1,154	1,275	1,323
	NSD7842(R)(X)	78x42x29	249/59.0	1,038	1,099	1,159	1,212
	NSD7242(R)(X)	72x42x29	243/53.0	1,024	1,083	1,145	1,203
	NSD8436(R)(X)	84x36x29	250/58.0	1,083	1,135	1,203	1,262
	NSD7836(R)(X)	78x36x29	245/55.0	1,022	1,082	1,142	1,202
	NSD7236(R)(X)	72x36x29	231/50.0	916	1,061	1,036	1,181
	NSD6636(R)(X)	66x36x29	214/46.0	866	1,012	987	1,133
	NSD6036(R)(X)	60x36x29	203/43.0	826	978	947	1,098
	NSD5436(R)(X)	54x36x29	192/38.0	754	905	875	1,020
	NSD4836(R)(X)	48x36x29	183/34.0	670	820	791	936
<b>Single Right Pedestal 3/4 Recessed Modesty Box, File</b>	NSD8430(R)(X)	84x30x29	220/49.0	1,051	1,202	1,172	1,238
	NSD7830(R)(X)	78x30x29	208/46.0	998	1,149	1,166	1,182
	NSD7230(R)(X)	72x30x29	200/42.0	891	1,043	1,090	1,163
	NSD6630(R)(X)	66x30x29	192/40.0	831	904	951	1,025
	NSD6030(R)(X)	60x30x29	181/36.0	746	855	903	975
	NSD5430(R)(X)	54x30x29	179/32.0	722	795	843	904
	NSD4830(R)(X)	48x30x29	175/28.0	595	673	716	794

\* For left pedestal desks, change (R) to (L) in model number.

	NSD8442D(X)	84x42x29	289/61.0	1,525	1,551	1,645	1,672	
	NSD7842D(X)	78x42x29	285/59.0	1,519	1,544	1,640	1,659	
	NSD7242D(X)	72x42x29	278/53.0	1,484	1,527	1,604	1,647	
	NSD8436D(X)	84x36x29	280/58.0	1,447	1,538	1,568	1,655	
	NSD7836D(X)	78x36x29	275/55.0	1,389	1,517	1,510	1,639	
	NSD7236D(X)	72x36x29	263/50.0	1,363	1,503	1,484	1,623	
	NSD6636D(X)	66x36x29	232/46.0	1,352	1,472	1,473	1,593	
	NSD6036D(X)	60x36x29	228/43.0	1,296	1,448	1,416	1,569	
	<b>Double Pedestal 3/4 Recessed Modesty Box, File Left Box, File Right</b>	NSD8430D(X)	84x30x29	257/49.0	1,387	1,527	1,508	1,647
		NSD7830D(X)	78x30x29	242/46.0	1,350	1,510	1,471	1,631
NSD7230D(X)		72x30x29	225/42.0	1,326	1,478	1,447	1,599	
NSD6630D(X)		66x30x29	222/40.0	1,285	1,454	1,406	1,575	
NSD6030D(X)		60x30x29	211/36.0	1,230	1,369	1,323	1,490	

**Ordering Details:**

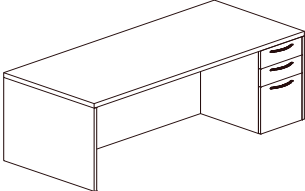
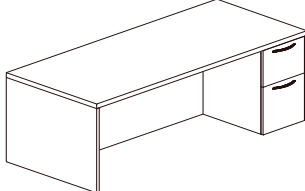
(X) - Specify 'M1' for 1" LPL, 'M2' for 1-1/2" LPL, 'H1' for 1-1/8" HPL, or 'H2' for 1-1/2" HPL. **Full Modesty Panels are available, add "FM" to part.**

**Options:**

**High pressure drawer fronts add \$121 list to above prices for single ped, and \$242 list for double ped, and specify on order.**

Custom size tables are available. Please call for details and pricing.

# Desks

STANDARD DESKS	Model	Size (WDH)	Wt./Cube	LPL		HPL		
				1"	1-1/2"	1-1/8"	1-1/2"	
	NSDF8442(R)(X)	84x42x29	269/61	1,190	1,247	1,313	1,370	
	NSDF7842(R)(X)	78x42x29	265/59	1,179	1,235	1,299	1,360	
	NSDF7242(R)(X)	72x42x29	258/53	1,163	1,224	1,286	1,347	
	NSDF8436(R)(X)	84x36x29	265/58	1,177	1,241	1,288	1,335	
	NSDF7836(R)(X)	78x36x29	261/55	1,140	1,229	1,239	1,331	
	NSDF7236(R)(X)	72x36x29	259/50	1,054	1,202	1,177	1,325	
	NSDF6636(R)(X)	66x36x29	246/46	1,004	1,153	1,127	1,276	
	NSDF6036(R)(X)	60x36x29	218/43	964	1,117	1,087	1,240	
	NSDF5436(R)(X)	54x36x29	198/38	922	1,068	1,045	1,203	
	NSDF4836(R)(X)	48x36x29	189/34	855	1,007	978	1,136	
<b>Single Right Pedestal Full Recessed Modesty 2 Box, File Right</b>	NSDF8430(R)(X)	84x30x29	230/49	1,101	1,223	1,224	1,326	
	NSDF7830(R)(X)	78x30x29	220/46	1,082	1,211	1,212	1,319	
	NSDF7230(R)(X)	72x30x29	215/42	1,024	1,183	1,147	1,306	
	NSDF6630(R)(X)	66x30x29	207/40	967	1,043	1,090	1,166	
	NSDF6030(R)(X)	60x30x29	196/36	898	971	1,041	1,115	
	NSDF5430(R)(X)	54x30x29	193/32	858	931	1,021	1,093	
	NSDF4830(R)(X)	48x30x29	185/28	729	807	852	930	
	<i>* For left pedestal desks, change (R) to (L) in model number.</i>							
		NSD2F8442(R)(X)	84x42x29	269/61	1,190	1,247	1,313	1,370
		NSD2F7842(R)(X)	78x42x29	265/59	1,179	1,235	1,299	1,360
NSD2F7242(R)(X)		72x42x29	258/53	1,163	1,224	1,286	1,347	
NSD2F8436(R)(X)		84x36x29	265/58	1,177	1,241	1,288	1,335	
NSD2F7836(R)(X)		78x36x29	261/55	1,140	1,229	1,239	1,331	
NSD2F7236(R)(X)		72x36x29	259/50	1,054	1,202	1,177	1,325	
NSD2F6636(R)(X)		66x36x29	246/46	1,004	1,153	1,127	1,276	
NSD2F6036(R)(X)		60x36x29	218/43	964	1,117	1,087	1,240	
NSD2F5436(R)(X)		54x36x29	198/38	922	1,068	1,045	1,203	
NSD2F4836(R)(X)		48x36x29	189/34	855	1,007	978	1,136	
<b>Single Right Pedestal Full Recessed Modesty 2 File Right</b>	NSD2F8430(R)(X)	84x30x29	230/49	1,101	1,223	1,224	1,326	
	NSD2F7830(R)(X)	78x30x29	220/46	1,082	1,211	1,212	1,319	
	NSD2F7230(R)(X)	72x30x29	215/42	1,024	1,183	1,147	1,306	
	NSD2F6630(R)(X)	66x30x29	207/40	967	1,043	1,090	1,166	
	NSD2F6030(R)(X)	60x30x29	196/36	898	865	1,041	1,115	
	NSD2F5430(R)(X)	54x30x29	193/32	858	971	1,021	1,093	
	NSD2F4830(R)(X)	48x30x29	185/28	729	807	852	930	
	<i>* For left pedestal desks, change (R) to (L) in model number.</i>							

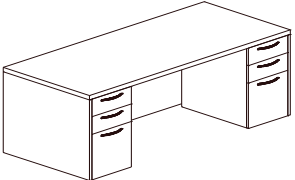
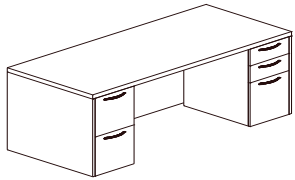
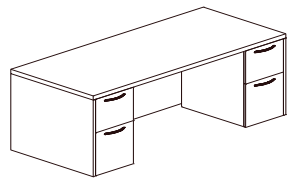
**Ordering Details:**

(X) - Specify 'M1' for 1" LPL, 'M2' for 1-1/2" LPL, 'H1' for 1-1/8" HPL, or 'H2' for 1-1/2" HPL.

**Options:**

**High pressure drawer fronts add \$121 list to above prices for single ped, and \$242 list for double ped, and specify on order.**  
 Custom size tables are available. Please call for details and pricing.

# Desks

STANDARD DESKS	Model	Size (WDH)	Wt./Cube	LPL		HPL	
				1"	1-1/2"	1-1/8"	1-1/2"
	NSDF8442(D)(X)	84x42x29	304/61	1,476	1,503	1,599	1,625
	NSDF7842(D)(X)	78x42x29	298/59	1,455	1,491	1,578	1,614
	NSDF7242(D)(X)	72x42x29	293/53	1,434	1,478	1,557	1,601
	NSDF8436(D)(X)	84x36x29	290/58	1,458	1,497	1,523	1,614
	NSDF7836(D)(X)	78x36x29	285/55	1,339	1,469	1,462	1,601
	NSDF7236(D)(X)	72x36x29	278/50	1,311	1,454	1,434	1,577
	NSDF6636(D)(X)	66x36x29	247/46	1,302	1,423	1,425	1,546
	NSDF6036(D)(X)	60x36x29	243/43	1,244	1,399	1,367	1,521
	NSDF8430D(X)	84x30x29	260/49	1,336	1,474	1,458	1,601
<b>Double Pedestal Full Recessed Modesty</b> 2 Box, File Left 2 Box, File Right	NSDF7830D(X)	78x30x29	250/46	1,299	1,454	1,422	1,577
	NSDF7230D(X)	72x30x29	240/42	1,275	1,429	1,398	1,552
	NSDF6630D(X)	66x30x29	237/40	1,233	1,405	1,356	1,528
	NSDF6030D(X)	60x30x29	226/36	1,176	1,319	1,299	1,442
	NSD3F8442D(X)	84x42x29	304/61	1,476	1,503	1,599	1,625
	NSD3F7842D(X)	78x42x29	298/59	1,455	1,491	1,578	1,614
	NSD3F7242D(X)	72x42x29	293/53	1,434	1,478	1,557	1,601
	NSD3F8436D(X)	84x36x29	290/58	1,458	1,491	1,523	1,614
	NSD3F7836D(X)	78x36x29	285/55	1,339	1,469	1,462	1,601
	NSD3F7236D(X)	72x36x29	278/50	1,311	1,454	1,434	1,577
	NSD3F6636D(X)	66x36x29	247/46	1,302	1,423	1,425	1,546
	NSD3F6036D(X)	60x36x29	243/43	1,244	1,399	1,367	1,521
	NSD3F8430D(X)	84x30x29	260/49	1,336	1,474	1,458	1,601
	NSD3F7830D(X)	78x30x29	250/46	1,299	1,454	1,422	1,577
	NSD3F7230D(X)	72x30x29	240/42	1,275	1,429	1,398	1,552
	NSD3F6630D(X)	66x30x29	237/40	1,233	1,405	1,356	1,528
	NSD3F6030D(X)	60x30x29	226/36	1,176	1,319	1,299	1,442
	<b>Double Pedestal Full Recessed Modesty</b> 2 File Left 2 Box, File Right	NSD4F8442D(X)	84x42x29	304/61	1,476	1,503	1,599
NSD4F7842D(X)		78x42x29	298/59	1,455	1,491	1,578	1,614
NSD4F7242D(X)		72x42x29	293/53	1,434	1,478	1,557	1,601
NSD4F8436D(X)		84x36x29	290/58	1,458	1,491	1,523	1,614
NSD4F7836D(X)		78x36x29	285/55	1,339	1,469	1,462	1,601
NSD4F7236D(X)		72x36x29	278/50	1,311	1,454	1,434	1,577
NSD4F6636D(X)		66x36x29	247/46	1,302	1,423	1,425	1,546
NSD4F6036D(X)		60x36x29	243/43	1,244	1,399	1,367	1,521
NSD4F8430D(X)		84x30x29	260/49	1,336	1,474	1,458	1,601
	NSD4F7830D(X)	78x30x29	250/46	1,299	1,454	1,422	1,577
	NSD4F7230D(X)	72x30x29	240/42	1,275	1,429	1,398	1,552
	NSD4F6630D(X)	66x30x29	237/40	1,233	1,405	1,356	1,528
	NSD4F6030D(X)	60x30x29	226/36	1,176	1,319	1,299	1,442

**Ordering Details:**

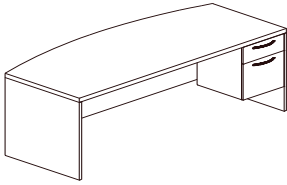
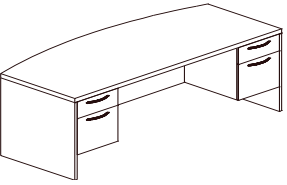
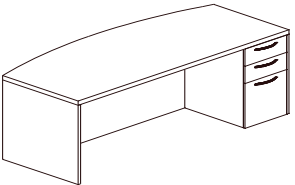
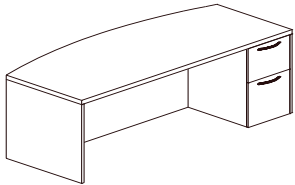
(X) - Specify 'M1' for 1" LPL, 'M2' for 1-1/2" LPL, 'H1' for 1-1/8" HPL, or 'H2' for 1-1/2" HPL.

**Options:**

**High pressure drawer fronts add \$121 list to above prices for single ped, and \$242 list for double ped, and specify on order.**  
 Custom size tables are available. Please call for details and pricing.



# Desks

BOW FRONT DESKS	Model	Size (WDH)	Wt./Cube	LPL		HPL	
				1"	1-1/2"	1-1/8"	1-1/2"
 <p><b>Single Right Pedestal 3/4 Recessed Modesty Box, File</b></p>	NSBOW8442(#)(X)	84x42x29	254/61	1,147	1,238	1,331	1,361
	NSBOW7842(#)(X)	78x42x29	249/57	1,122	1,225	1,306	1,348
	NSBOW7242(#)(X)	72x42x29	243/53	1,097	1,189	1,220	1,311
	NSBOW8436(#)(X)	84x36x29	248/57	1,126	1,212	1,244	1,335
	NSBOW7836(#)(X)	78x36x29	241/54	1,099	1,188	1,220	1,310
	NSBOW7236(#)(X)	72x36x29	231/50	1,073	1,163	1,196	1,286
	NSBOW6636(#)(X)	66x36x29	214/46	1,049	1,139	1,172	1,262
	NSBOW6036(#)(X)	60x36x29	203/43	1,024	1,115	1,147	1,238
	<b>Full Modesty Panels are available, add "FM" to part.</b>						
 <p><b>Bow Top Double Pedestal 3/4 Recessed Modesty Box, File Left/Box, File Right</b></p>	NSBOW8442D(X)	84x42x29	278/61	1,268	1,372	1,391	1,495
	NSBOW7842D(X)	78x42x29	272/57	1,245	1,348	1,367	1,478
	NSBOW7242D(X)	72x42x29	269/53	1,220	1,325	1,343	1,448
	NSBOW8436D(X)	84x36x29	269/61	1,244	1,348	1,369	1,473
	NSBOW7836D(X)	78x36x29	262/57	1,221	1,327	1,344	1,448
	NSBOW7236D(X)	72x36x29	258/53	1,196	1,300	1,319	1,423
	NSBOW6636D(X)	66x36x29	232/46	1,172	1,276	1,295	1,399
	NSBOW6036D(X)	60x36x29	228/43	1,147	1,252	1,269	1,374
	<b>Full Modesty Panels are available, add "FM" to part.</b>						
 <p><b>Bow Top Single Pedestal Full Recessed Modesty 2 Box, File</b></p>	NSBOWF8442(#)(X)	84x42x29	269/61	1,269	1,361	1,392	1,484
	NSBOWF7842(#)(X)	78x42x29	262/57	1,245	1,348	1,368	1,471
	NSBOWF7242(#)(X)	72x42x29	258/53	1,220	1,311	1,343	1,434
	NSBOWF8436(#)(X)	84x36x29	269/61	1,248	1,339	1,369	1,496
	NSBOWF7836(#)(X)	78x36x29	262/57	1,222	1,313	1,345	1,470
	NSBOWF7236(#)(X)	72x36x29	258/53	1,196	1,286	1,319	1,409
	NSBOWF6636(#)(X)	66x36x29	259/46	1,172	1,262	1,295	1,385
	NSBOWF6036(#)(X)	60x36x29	218/43	1,147	1,238	1,269	1,361
	 <p><b>Bow Top Single Pedestal Full Recessed Modesty 2 File</b></p>	NSBOW2F8442(#)(X)	84x42x29	269/61	1,269	1,361	1,392
NSBOW2F7842(#)(X)		78x42x29	262/57	1,245	1,348	1,368	1,471
NSBOW2F7242(#)(X)		72x42x29	258/53	1,220	1,311	1,343	1,434
NSBOW2F8436(#)(X)		84x36x29	269/61	1,248	1,339	1,371	1,496
NSBOW2F7836(#)(X)		78x36x29	262/57	1,222	1,313	1,345	1,470
NSBOW2F7236(#)(X)		72x36x29	258/53	1,196	1,286	1,319	1,409
NSBOW2F6636(#)(X)		66x36x29	239/46	1,172	1,262	1,295	1,385
NSBOW2F6036(#)(X)		60x36x29	218/43	1,147	1,238	1,269	1,361

**Ordering Details:**

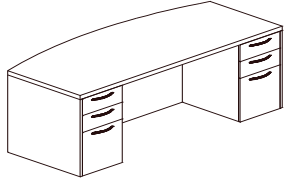
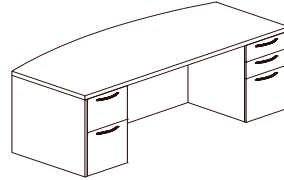
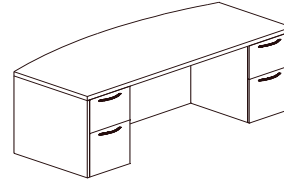
(X) - Specify 'M1' for 1" LPL, 'M2' for 1-1/2" LPL, 'H1' for 1-1/8" HPL, or 'H2' for 1-1/2" HPL. (#) - Specify L for Left or R for right

**Options:**

**High pressure drawer fronts add \$121 list to above prices for single ped, and \$242 list for double ped, and specify on order.**

Custom size tables are available. Please call for details and pricing.

# Desks

BOW FRONT DESKS	Model	Size (WDH)	Wt./Cube	LPL		HPL	
				1"	1-1/2"	1-1/8"	1-1/2"
 <p><b>Bow Top Double Pedestal Full Recessed Modesty</b> 2 Box, File Left &amp; Right</p>	NSBOWF8442D(X)	84x42x29	304/61	1,514	1,618	1,637	1,778
	NSBOWF7842D(X)	78x42x29	297/57	1,491	1,594	1,613	1,754
	NSBOWF7242D(X)	72x42x29	293/53	1,466	1,571	1,589	1,694
	NSBOWF8436D(X)	84x36x29	288/55	1,494	1,598	1,617	1,721
	NSBOWF7836D(X)	78x36x29	283/53	1,468	1,572	1,591	1,695
	NSBOWF7236D(X)	72x36x29	278/50	1,442	1,546	1,565	1,668
	NSBOWF6636D(X)	66x36x29	247/46	1,418	1,521	1,546	1,663
	NSBOWF6036D(X)	60x36x29	243/43	1,392	1,361	1,515	1,638
	 <p><b>Bow Top Double Pedestal Full Recessed Modesty</b> 2 File Left &amp; Right</p>	NSBOW3F8442D(X)	84x42x29	304/61	1,514	1,618	1,637
NSBOW3F7842D(X)		78x42x29	297/57	1,491	1,594	1,613	1,754
NSBOW3F7242D(X)		72x42x29	293/53	1,466	1,571	1,589	1,694
NSBOW3F8436D(X)		84x36x29	288/55	1,494	1,598	1,617	1,721
NSBOW3F7836D(X)		78x36x29	283/53	1,468	1,572	1,591	1,695
NSBOW3F7236D(X)		72x36x29	278/50	1,442	1,546	1,565	1,668
NSBOW3F6636D(X)		66x36x29	247/46	1,418	1,521	1,546	1,663
NSBOW3F6036D(X)		60x36x29	243/43	1,392	1,361	1,515	1,638
 <p><b>Bow Top Double Pedestal Full Recessed Modesty</b> 2 File Left &amp; Right</p>		NSBOW4F8442D(X)	84x42x29	304/61	1,514	1,618	1,637
	NSBOW4F7842D(X)	78x42x29	297/57	1,491	1,594	1,613	1,754
	NSBOW4F7242D(X)	72x42x29	293/53	1,466	1,571	1,589	1,694
	NSBOW4F8436D(X)	84x36x29	288/55	1,494	1,598	1,617	1,721
	NSBOW4F7836D(X)	78x36x29	283/53	1,468	1,572	1,591	1,695
	NSBOW4F7236D(X)	72x36x29	278/50	1,442	1,546	1,565	1,668
	NSBOW4F6636D(X)	66x36x29	247/46	1,418	1,521	1,546	1,663
	NSBOW4F6036D(X)	60x36x29	243/43	1,392	1,361	1,515	1,638

**Ordering Details:**

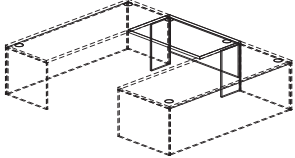
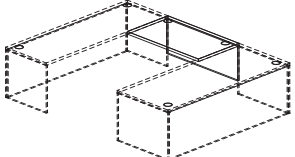
(X) - Specify 'M1' for 1" LPL, 'M2' for 1-1/2" LPL, 'H1' for 1-1/8" HPL, or 'H2' for 1-1/2" HPL.

**Options:**

**High pressure drawer fronts add \$121 list to above prices for single ped, and \$242 list for double ped, and specify on order.**

Custom size tables are available. Please call for details and pricing.

# Bridge Tops & Returns

BRIDGE TABLE UNITS	Model	Size (WD)	Wt./Cube (KD)	LPL		HPL	
				1"	1-1/2"	1-1/8"	1-1/2"
 <p><b>Bridge Table w/ Two Recessed Gables 3/4 Modesty</b></p>	NS6030D(X)	60x30x29	95/7.0	491	549	639	697
	NS5430D(X)	54x30x29	85/6.5	486	527	633	675
	NS4830D(X)	48x30x29	75/6.0	458	507	605	654
	NS4230D(X)	42x30x29	73/5.5	426	483	574	631
	NS3630D(X)	36x30x29	70/5.0	410	459	558	606
	NS3030D(X)	30x30x29	65/4.0	393	435	540	582
	NS6024D(X)	60x24x29	85/5.6	453	512	600	660
	NS5424D(X)	54x24x29	79/5.0	449	491	596	639
	NS4824D(X)	48x24x29	70/4.5	428	471	575	618
	NS4224D(X)	42x24x29	67/3.9	403	446	551	594
 <p><b>Bridge Top Only, No Gables, shown with optional 3/4 Modesty Panel</b></p>	NS3624D(X)	36x24x29	65/3.4	374	397	522	545
	NS3024D(X)	30x24x29	57/2.8	349	384	496	531
	NS6020D(X)	60x20x29	75/5.6	453	512	600	660
	NS5420D(X)	54x20x29	69/5.0	449	491	596	639
	NS4820D(X)	48x20x29	60/4.5	428	471	575	618
	NS4220D(X)	42x20x29	57/3.9	403	446	551	594
	NS3620D(X)	36x20x29	55/3.4	374	397	522	545
	NS3020D(X)	30x20x29	53/2.8	349	384	496	531
	NSJT6024(X)	60x24	49/3.4	390	478	487	657
	NSJT5424(X)	54x24	44/1.7	345	423	432	583
NSJT4824(X)	48x24	39/2.8	253	311	317	427	
NSJT4224(X)	42x24	32/2.1	249	305	311	419	
NSJT3624(X)	36x24	28/1.1	217	266	271	366	
NSJT3024(X)	30x24	26/9	190	230	234	309	
NSJT4820(X)	48x20	22/1.0	163	215	286	338	
NSJT4220(X)	42x20	18/1.0	129	166	252	289	
NSJT3620(X)	36x20	16/1.0	123	161	246	284	
NSJT3020(X)	30x20	14/1.0	118	154	240	277	

For optional curved bridge top, add 'CUR' to part code, and \$84.00 list to prices. Shown with optional full modesty. If modesty is required order separately.

**Curved Bridge Top**  
**Optional-Separate,**  
**3/4 Modesty Panel for all**  
**Bridge Tops above**  
*\*Grain runs horizontal*

NS-MP48	48x20	23/1.0	135
NS-MP42	42x20	20/1.0	129
NS-MP36	36x20	17/1.0	123
NS-MP30	30x20	15/1.0	99

Includes connecting hardware kit consisting of pins and cams to connect top to modesty and flat plates to connect modesty to adjacent end gables.

**Ordering Details:**

(X) - Specify 'M1' for 1" LPL, 'M2' for 1-1/2" LPL, 'H1' for 1-1/8" HPL, or 'H2' for 1-1/2" HPL. Grommets are standard in the tops, recessed and full end gables of bridges, returns and tables. Two grommets are standard on all tops of tables, bridges, and returns.

Full Modesty Panels are available, add "FM" to part.

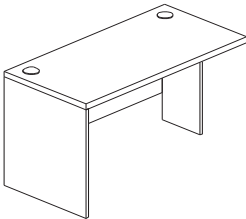
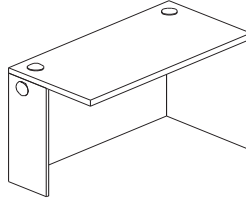
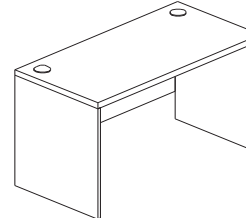
1/2 Modesty Panels (12") are available, add "TM" to part.

1/4 Modesty Panels (7") are available, add "QM" to part. & 158.00 to list price.

For vertical grain on modesty panels, add VG to modesty part code, add \$63.

**Options:**

# Bridge Tops & Returns

DESK HEIGHT RETURNS & DESK SHELLS	Model	Size (WDH)	Wt./Cube	LPL		HPL	
				1"	1-1/2"	1-1/8"	1-1/2"
 <p><b>Return, 3/4 Modesty Right Recessed Gable</b></p>	NS8420R(X)	84x20x29	134/7.8	726	785	873	933
	NS7820R(X)	78x20x29	128/7.2	603	663	750	811
	NS7220R(X)	72x20x29	110/6.7	489	549	637	697
	NS6620R(X)	66x20x29	97/6.1	465	525	612	672
	NS6020R(X)	60x20x29	85/5.6	453	512	600	660
	NS5420R(X)	54x20x29	79/5.0	449	491	596	639
	NS4820R(X)	48x20x29	70/4.5	428	471	575	618
	NS4220R(X)	42x20x29	67/3.9	403	446	551	594
	NS3620R(X)	36x20x29	65/3.4	374	397	522	545
	NS3020R(X)	30x20x29	57/2.8	349	384	496	531
NS2420R(X)	24x20x29	52/2.3	344	356	491	503	
 <p><b>Return, Full Modesty (FM) Left Recessed Gable</b></p>	NS8420L(X)	84x20x29	134/7.8	726	785	873	933
	NS7820L(X)	78x20x29	128/7.2	603	663	750	811
	NS7220L(X)	72x20x29	110/6.7	489	549	637	697
	NS6620L(X)	66x20x29	97/6.1	465	525	612	672
	NS6020L(X)	60x20x29	85/5.6	453	512	600	660
	NS5420L(X)	54x20x29	79/5.0	449	491	596	639
	NS4820L(X)	48x20x29	70/4.5	428	471	575	618
	NS4220L(X)	42x20x29	67/3.9	403	446	551	594
	NS3620L(X)	36x20x29	65/3.4	374	397	522	545
	NS3020L(X)	30x20x29	57/2.8	349	384	496	531
NS2420L(X)	24x20x29	52/2.3	344	356	491	503	
 <p><b>Desk Shell Full Gables</b></p>	NS8420F(X)	84x20x29	134/7.8	726	785	873	933
	NS7820F(X)	78x20x29	128/7.2	603	663	750	811
	NS7220F(X)	72x20x29	110/6.7	489	549	637	697
	NS6620F(X)	66x20x29	97/6.1	465	525	612	672
	NS6020F(X)	60x20x29	85/5.6	453	512	600	660
	NS5420F(X)	54x20x29	79/5.0	449	491	596	639
	NS4820F(X)	48x20x29	70/4.5	428	471	575	618
	NS4220F(X)	42x20x29	67/3.9	403	446	551	594
	NS3620F(X)	36x20x29	65/3.4	374	397	522	545
	NS3020F(X)	30x20x29	57/2.8	349	384	496	531
NS2420F(X)	24x20x29	52/2.3	344	356	491	503	

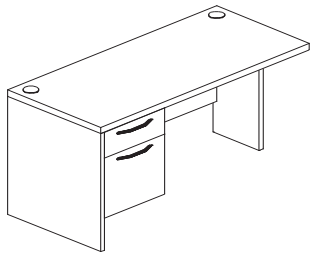
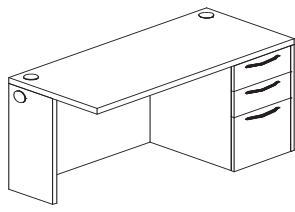
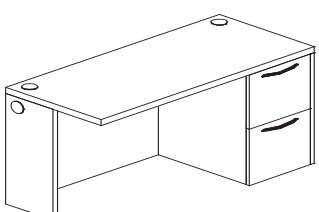
**Ordering Details:**

(X) - Specify 'M1' for 1" LPL, 'M2' for 1-1/2" LPL, 'H1' for 1-1/8" HPL, or 'H2' for 1-1/2" HPL.

**Options:**

**Full Modesty Panels are available, add "FM" to part.**  
**1/2 Modesty Panels (12") are available, add "TM" to part.**  
 1/4 Modesty Panels (7") are available, add "QM" to part. & 158.00 to list price.  
 Custom size tables are available. Please call for details and pricing.  
 Double recessed gables are available. Add 'D' to code - eg. NS4820D(X)

# Bridge Tops & Returns

DESK HEIGHT RETURNS	Model	Size (WD)	Wt./Cube (KD)	LPL		HPL	
				1"	1-1/2"	1-1/8"	1-1/2"
 <p><b>Return Left Pedestal 3/4 Modesty Box, File</b></p>	NSR6024(L)(X)	60x24x29	166/28.9	839	991	1,001	1,154
	NSR5424(L)(X)	54x24x29	144/26.1	774	917	922	1,064
	NSR4824(L)(X)	48x24x29	123/23.3	707	841	842	977
	NSR4224(L)(X)	42x24x29	114/21.0	699	801	834	937
	NSR3624(L)(X)	36x24x29	100/21.3	672	775	807	910
	NSR3024(L)(X)	30x24x29	96/21.0	646	749	780	884
	NSR6020(L)(X)	60x20x29	121/28.9	758	916	920	1,077
	NSR5420(L)(X)	54x20x29	111/26.1	715	834	864	983
	NSR4820(L)(X)	48x20x29	114/23.3	672	753	807	888
	NSR4220(L)(X)	42x20x29	105/21.0	646	686	781	863
	NSR3620(L)(X)	36x20x29	100/21.3	618	658	753	834
	NSR3020(L)(X)	30x20x29	96/21.0	591	632	727	807
<i>*For right returns, change (L) to (R) in model number.</i>							
 <p><b>Return Right Pedestal Full Modesty 2 Box, File</b></p>	NSRF6024(R)(X)	60x24x29	196/28.9	973	1,194	1,135	1,289
	NSRF5424(R)(X)	54x24x29	165/26.1	900	1,086	1,062	1,199
	NSRF4824(R)(X)	48x24x29	133/23.3	842	977	985	1,111
	NSRF4224(R)(X)	42x24x29	123/21.0	834	937	969	1,072
	NSRF3624(R)(X)	36x24x29	100/21.3	809	910	943	1,046
	NSRF3024(R)(X)	30x24x29	96/21.0	781	884	916	1,019
	NSRF6020(R)(X)	60x20x29	151/28.9	893	1,051	1,054	1,213
	NSRF5420(R)(X)	54x20x29	135/26.1	851	969	1,000	1,118
	NSRF4820(R)(X)	48x20x29	120/23.3	807	888	943	1,023
	NSRF4220(R)(X)	42x20x29	115/21.0	781	821	916	996
	NSRF3620(R)(X)	36x20x29	100/21.3	753	794	888	969
	NSRF3020(R)(X)	30x20x29	96/21.0	727	767	862	943
<i>*For left returns, change (R) to (L) in model number.</i>							
 <p><b>Return Right Pedestal Full Modesty 2 File</b></p>	NSR2F6024(R)(X)	60x24x29	196/28.9	885	1,086	1,032	1,172
	NSR2F5424(R)(X)	54x24x29	165/26.1	818	987	965	1,090
	NSR2F4824(R)(X)	48x24x29	133/23.3	765	887	896	1,010
	NSR2F4224(R)(X)	42x24x29	123/21.0	758	852	881	974
	NSR2F3624(R)(X)	36x24x29	100/21.3	735	827	857	950
	NSR2F3024(R)(X)	30x24x29	96/21.0	710	803	833	926
	NSR2F6020(R)(X)	60x20x29	151/28.9	812	956	959	1,103
	NSR2F5420(R)(X)	54x20x29	135/26.1	773	881	908	1,016
	NSR2F4820(R)(X)	48x20x29	120/23.3	734	807	857	930
	NSR2F4220(R)(X)	42x20x29	115/21.0	710	747	833	869
	NSR2F3620(R)(X)	36x20x29	100/21.3	685	721	807	881
	NSR2F3020(R)(X)	30x20x29	96/21.0	660	697	783	857
<i>*For left returns, change (R) to (L) in model number.</i>							

**Ordering Details:**

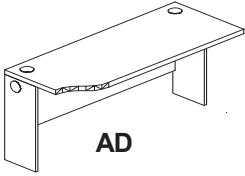
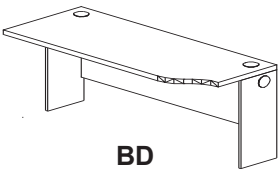
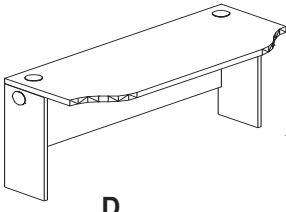
(X) - Specify 'M1' for 1" LPL, 'M2' for 1-1/2" LPL, 'H1' for 1-1/8" HPL, or 'H2' for 1-1/2" HPL.

**Options:**

**High pressure drawer fronts add \$121 list to above prices and specify on order.**

Custom size tables are available. Please call for details and pricing.

# Sculptured Bridge Tables

SCULPTURED BRIDGE TABLES	Model	Size (WDD)	Wt./Cube (KD)	LPL		HPL	
				1"	1-1/2"	1-1/8"	1-1/2"
 <p><b>AD</b></p> <p><b>Single Sculpture Left (A)</b> <b>Double Recessed Gables (D)</b> <b>3/4 Modesty</b></p>	NSS603024(#)(X)	60x30x24	69/6.9	520	574	627	804
	NSS543024(#)(X)	54x30x24	62/6.2	503	553	606	768
	NSS483024(#)(X)	48x30x24	55/6.5	477	532	587	747
	NSS423024(#)(X)	42x30x24	48/4.8	459	507	582	705
	NSS363024(#)(X)	36x30x24	42/4.2	435	483	558	680
	NSS303024(#)(X)	30x30x24	35/3.5	410	452	532	655
	NSS243024(#)(X)	24x30x24	28/2.8	406	426	529	652
	<i>30" depth on full end, 24" depth on one sculptured end.</i>						
 <p><b>BD</b></p> <p><b>Single Sculpture Right (B)</b> <b>Double Recessed Gables (D)</b> <b>3/4 Modesty</b></p>	NSS602418(#)(X)	60x24x18	67/5.6	471	525	614	761
	NSS542418(#)(X)	54x24x18	60/1.6	467	516	594	749
	NSS482418(#)(X)	48x24x18	54/4.5	453	507	574	697
	NSS422418(#)(X)	42x24x18	47/3.9	428	483	551	674
	NSS362418(#)(X)	36x24x18	41/3.4	401	459	524	647
	NSS302418(#)(X)	30x24x18	34/2.8	379	435	502	625
	NSS242418(#)(X)	24x24x18	28/2.3	369	410	491	614
	<i>24" depth on full end, 18" depth on one sculptured end.</i>						
 <p><b>D</b></p> <p><b>Double Sculpture</b> <b>Double Recessed Gables</b> <b>3/4 Modesty</b></p>	NSS603024D(X)	60x30x24	69/6.9	565	635	712	816
	NSS543024D(X)	54x30x24	62/6.2	547	614	691	779
	NSS483024D(X)	48x30x24	55/6.5	522	594	671	758
	NSS423024D(X)	42x30x24	48/4.8	503	568	667	717
	NSS363024D(X)	36x30x24	42/4.2	479	537	642	692
	NSS303024D(X)	30x30x24	35/3.5	454	511	617	668
	<i>30" tables sculptured to 24" on both ends.</i>						
	NSS602418D(X)	60x24x18	67/6.9	546	587	672	804
	NSS542418D(X)	54x24x18	60/6.2	529	566	652	768
	NSS482418D(X)	48x24x18	54/6.5	503	545	632	747
	NSS422418D(X)	42x24x18	47/4.8	484	519	627	705
	NSS362418D(X)	36x24x18	41/4.2	460	487	603	680
	NSS302418D(X)	30x24x18	34/3.5	436	462	578	655
	<i>24" tables sculptured to 18" on both ends.</i>						

**Ordering Details:**

(#) - Specify Style - 'AD', 'BD' or 'D'.

(X) - Specify 'M1' for 1" LPL, 'M2' for 1-1/2" LPL,

'H1' for 1-1/8" HPL, or 'H2' for 1-1/2" HPL. **Full Modesty Panels are available, add "FM" to part.**

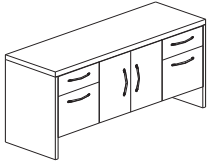
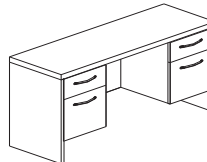
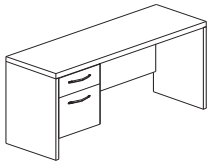
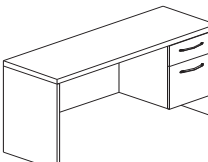
**Options:**

**1/2 Modesty Panels (12") are available, add "TM" to part.**

**1/4 Modesty Panels (7") are available, add "QM" to part. & 158.00 to price.**

Shorter modesties will result in pedestal or storage visibility from the visitor side of tables. As a result, some pedestals or storage elements may have finishes which differ from the modesty. BRC accepts no responsibility for these circumstances. Custom size tables are available. Please call for details and pricing.

# Credenzas

CREDENZAS	Model	Size (WDH)	Wt./Cube	LPL		HPL	
				1"	1-1/2"	1-1/8"	1-1/2"
 <p><b>Full Credenza</b> Box, File Left and Right Closed Storage, Center</p>	NSC7224C1(X)	72x24x29	228/35.0	1,235	1,434	1,383	1,581
	NSC7220C1(X)	72x20x29	208/27.5	1,196	1,392	1,343	1,540
	NSC6624C1(X)	66x24x29	221/31.7	1,198	1,372	1,346	1,520
	NSC6620C1(X)	66x20x29	201/26.8	1,155	1,348	1,303	1,495
	NSC6024C1(X)	60x24x29	213/28.9	1,187	1,331	1,334	1,478
	NSC6020C1(X)	60x20x29	193/24.5	1,125	1,311	1,272	1,458
 <p><b>Kneespace Credenza 3/4 Modesty</b> Box, File Left and Right</p>	NSC7224C2(X)	72x24x29	186/35.0	1,021	1,127	1,168	1,293
	NSC7220C2(X)	72x20x29	166/27.5	965	1,097	1,112	1,260
	NSC6624C2(X)	66x24x29	179/31.7	999	1,103	1,146	1,275
	NSC6620C2(X)	66x20x29	159/26.8	922	1,086	1,069	1,217
	NSC6024C2(X)	60x24x29	171/28.9	972	1,078	1,068	1,267
	NSC6020C2(X)	60x20x29	151/24.5	898	1,061	1,045	1,192
 <p><b>Single Left Ped Credenza 3/4 Modesty</b> Box, File</p>	NSC7224L(X)	72x24x29	181/35.0	818	956	965	1,103
	NSC7220L(X)	72x20x29	161/27.5	799	906	946	1,053
	NSC6624L(X)	66x24x29	174/31.7	786	926	935	1,061
	NSC6620L(X)	66x20x29	141/26.8	713	857	860	1,004
	NSC6024L(X)	60x24x29	166/28.9	762	901	909	1,049
	NSC6020L(X)	60x20x29	121/24.5	689	833	836	980
	NSC5424L(X)	54x24x29	144/26.1	704	834	838	967
	NSC5420L(X)	54x20x29	111/26.1	650	758	785	894
	NSC4824L(X)	48x24x29	123/23.3	643	764	765	887
	NSC4820L(X)	48x20x29	114/23.3	611	685	734	807
 <p><b>Single Right Ped Credenza 3/4 Modesty</b> Box, File</p>	NSC7224R(X)	72x24x29	181/35.0	818	956	965	1,103
	NSC7220R(X)	72x20x29	161/27.5	799	906	946	1,053
	NSC6624R(X)	66x24x29	174/31.7	786	926	935	1,061
	NSC6620R(X)	66x20x29	141/26.8	713	857	860	1,004
	NSC6024R(X)	60x24x29	166/28.9	762	901	909	1,049
	NSC6020R(X)	60x20x29	121/24.5	689	833	836	980
	NSC5424R(X)	54x24x29	158/26.1	704	834	838	967
	NSC5420R(X)	54x20x29	128/22.1	650	758	785	894
	NSC4824R(X)	48x24x29	150/23.3	643	764	765	887
	NSC4820R(X)	48x20x29	120/19.7	611	685	734	807

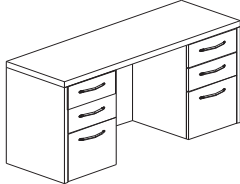
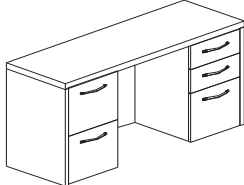
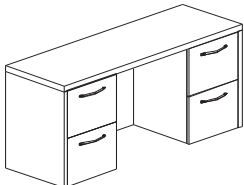
**Ordering Details:**

(X) - Specify 'M1' for 1" LPL, 'M2' for 1-1/2" LPL, 'H1' for 1-1/8" HPL, or 'H2' for 1-1/2" HPL. **Full Modesty Panels are available, add "FM" to part.**

**Options:**

**High pressure drawer fronts add \$121 list to above prices for single ped, and \$242 list for double ped, and \$474 list for full credenza, and specify on order.**

# Credenzas

CREDENZAS KNEESPACE	Model	Size (WDH)	Wt./Cube	LPL		HPL	
				1"	1-1/2"	1-1/8"	1-1/2"
 <p><b>Kneespace Credenza Full Modesty</b> 2 Box, File Left 2 Box, File Right</p>	NSC7224C5(X)	72x24x29	246/35.0	1,266	1,372	1,387	1,520
	NSC7220C5(X)	72x20x29	226/27.5	1,211	1,343	1,358	1,491
	NSC6624C5(X)	66x24x29	239/31.7	1,244	1,348	1,391	1,495
	NSC6620C5(X)	66x20x29	219/26.8	1,168	1,331	1,315	1,478
	NSC6024C5(X)	60x24x29	231/28.9	1,218	1,324	1,314	1,513
	NSC6020C5(X)	60x20x29	211/24.5	1,143	1,306	1,290	1,437
 <p><b>Kneespace Credenza Full Modesty</b> 2 File Left 2 Box, File Right</p>	NSC7224C6(X)	72x24x29	246/35.0	1,266	1,372	1,413	1,520
	NSC7220C6(X)	72x20x29	226/27.5	1,211	1,343	1,358	1,491
	NSC6624C6(X)	66x24x29	239/31.7	1,244	1,348	1,391	1,495
	NSC6620C6(X)	66x20x29	219/26.8	1,168	1,331	1,315	1,478
	NSC6024C6(X)	60x24x29	231/28.9	1,218	1,324	1,314	1,513
	NSC6020C6(X)	60x20x29	211/24.5	1,143	1,306	1,290	1,437
 <p><b>Kneespace Credenza Full Modesty</b> 2 File Left, 2 File Right</p>	NSC7224C7(X)	72x24x29	246/35.0	1,266	1,372	1,413	1,520
	NSC7220C7(X)	72x20x29	226/27.5	1,211	1,343	1,358	1,491
	NSC6624C7(X)	66x24x29	239/31.7	1,244	1,348	1,391	1,495
	NSC6620C7(X)	66x20x29	219/26.8	1,168	1,331	1,315	1,478
	NSC6024C7(X)	60x24x29	231/28.9	1,218	1,324	1,314	1,513
	NSC6020C7(X)	60x20x29	211/24.5	1,143	1,306	1,290	1,437

**Ordering Details:**

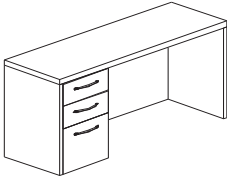
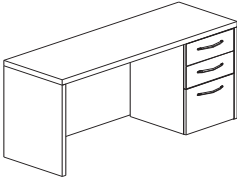
(X) - Specify 'M1' for 1" LPL, 'M2' for 1-1/2" LPL, 'H1' for 1-1/8" HPL, or 'H2' for 1-1/2" HPL.

**Options:**

High pressure drawer fronts add \$121 list to above prices for single ped, and \$242 list for double ped, and specify on order.



# Credenzas

CREDENZAS	Model	Size (WDH)	Wt./Cube	LPL		HPL	
				1"	1-1/2"	1-1/8"	1-1/2"
 <p><b>Single Left Pedestal Credenza</b> <b>Full Modesty</b> 2 Box, File</p>	NSCF7224L(X)	72x24x29	211/35.0	941	1,078	1,088	1,225
	NSCF7220L(X)	72x20x29	191/27.5	922	1,029	1,069	1,176
	NSCF6624L(X)	66x24x29	204/31.7	909	1,049	1,057	1,196
	NSCF6620L(X)	66x20x29	171/26.8	836	980	983	1,127
	NSCF6024L(X)	60x24x29	196/28.9	885	1,024	1,032	1,172
	NSCF6020L(X)	60x20x29	151/24.5	812	956	959	1,103
	NSCF5424L(X)	54x24x29	188/26.1	812	946	959	1,094
	NSCF5420L(X)	54x20x29	131/22.1	737	750	885	1,021
	NSCF4824L(X)	48x24x29	180/23.3	695	830	842	978
	NSCF4820L(X)	48x20x20	111/19.7	621	756	769	903
 <p><b>Single Right Pedestal Credenza</b> <b>Full Modesty</b> 2 Box, File</p>	NSCF7224R(X)	72x24x29	211/35.0	941	1,078	1,088	1,225
	NSCF7220R(X)	72x20x29	191/27.5	922	1,029	1,069	1,176
	NSCF6624R(X)	66x24x29	204/31.7	909	1,049	1,057	1,196
	NSCF6620R(X)	66x20x29	171/26.8	836	980	983	1,127
	NSCF6024R(X)	60x24x29	196/28.9	885	1,024	1,032	1,172
	NSCF6020R(X)	60x20x29	151/24.5	812	956	959	1,103
	NSCF5424R(X)	54x24x29	188/26.1	812	946	959	1,094
	NSCF5420R(X)	54x20x29	131/22.1	737	750	885	1,021
	NSCF4824R(X)	48x24x29	180/23.3	695	830	842	978
	NSCF4820R(X)	48x20x29	111/19.7	621	756	769	903

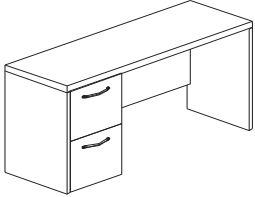
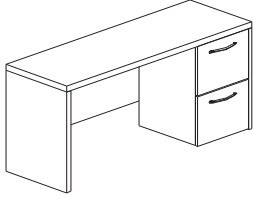
**Ordering Details:**

(X) - Specify 'M1' for 1" LPL, 'M2' for 1-1/2" LPL, 'H1' for 1-1/8" HPL, or 'H2' for 1-1/2" HPL.

**Options:**

**High pressure drawer fronts add \$121 list to above prices and specify on order.**

# Credenzas

CREDENZAS	Model	Size (WDH)	Wt./Cube	LPL		HPL	
				1"	1-1/2"	1-1/8"	1-1/2"
 <p><b>Single Left Pedestal Credenza</b> 3/4 Modesty 2 File</p>	NSC2F7224L(X)	72x24x29	211/35.0	941	1,078	1,088	1,225
	NSC2F7220L(X)	72x20x29	191/27.5	922	1,029	1,069	1,176
	NSC2F6624L(X)	66x24x29	204/31.7	909	1,049	1,057	1,196
	NSC2F6620L(X)	66x20x29	171/26.8	836	980	983	1,127
	NSC2F6024L(X)	60x24x29	196/28.9	885	1,024	1,032	1,172
	NSC2F6020L(X)	60x20x29	151/24.5	812	956	959	1,103
	NSC2F5424L(X)	54x24x29	188/26.1	812	946	959	1,094
	NSC2F5420L(X)	54x20x29	131/22.1	737	750	885	1,021
	NSC2F4824L(X)	48x24x29	180/23.3	695	830	842	978
	NSC2F4820L(X)	48x20x29	111/19.7	621	756	769	903
 <p><b>Single Right Pedestal Credenza</b> 3/4 Modesty 2 File</p>	NSC2F7224R(X)	72x24x29	211/35.0	941	1,078	1,088	1,225
	NSC2F7220R(X)	72x20x29	191/27.5	922	1,029	1,069	1,176
	NSC2F6624R(X)	66x24x29	204/31.7	909	1,049	1,057	1,196
	NSC2F6620R(X)	66x20x29	171/26.8	836	980	983	1,127
	NSC2F6024R(X)	60x24x29	196/28.9	885	1,024	1,032	1,172
	NSC2F6020R(X)	60x20x29	151/24.5	812	956	959	1,103
	NSC2F5424R(X)	54x24x29	188/26.1	812	946	959	1,094
	NSC2F5420R(X)	54x20x29	131/22.1	737	750	885	1,021
	NSC2F4824R(X)	48x24x29	180/23.3	695	830	842	978
	NSC2F4820R(X)	48x20x29	111/19.7	621	756	769	903

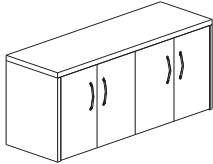
**Ordering Details:**

(X) - Specify 'M1' for 1" LPL, 'M2' for 1-1/2" LPL, 'H1' for 1-1/8" HPL, or 'H2' for 1-1/2" HPL.

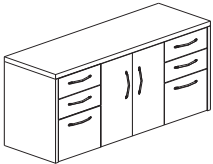
**Options:**

**High pressure drawer fronts add \$121 list to above prices and specify on order.**

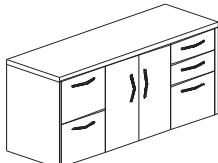
# Credenzas

CREDENZAS	Model	Size (WDH)	Wt./Cube	LPL		HPL	
				1"	1-1/2"	1-1/8"	1-1/2"
 <p><b>Full Credenza Double Closed Storage</b></p>	NSC7224S1(X)	72x24x29	242/35.0	1,137	1,213	1,284	1,361
	NSC7220S1(X)	72x20x29	198/27.5	1,106	1,147	1,254	1,295
	NSC6624S1(X)	66x24x29	232/31.7	1,112	1,152	1,260	1,299
	NSC6620S1(X)	66x20x29	188/26.8	1,069	1,086	1,217	1,233
	NSC6024S1(X)	60x24x29	222/28.9	1,045	1,103	1,192	1,250
	NSC6020S1(X)	60x20x29	178/24.5	1,021	1,036	1,168	1,183
	NSC5424S1(X)	54x24x29	220/27	1,013	1,071	1,160	1,218
	NSC5420S1(X)	54x20x29	172/23	989	1,005	1,136	1,152
	NSC4824S1(X)	48x24x29	215/25	982	1,040	1,129	1,187
	NSC4820S1(X)	48x20x29	163/21	958	973	1,105	1,120
	NSC4224S1(X)	42x24x29	211/22	950	1,008	1,097	1,155
	NSC4220S1(X)	42x20x29	160/18	926	942	1,073	1,089

All above cabinets come standard with 4 hinged doors.

 <p><b>Full Credenza</b> 2 Box, File Left Closed Storage Center 2 Box, File Right</p>	NSC7224D3(X)	72x24x29	242/35.0	1,552	1,671	1,707	1,830
	NSC7220D3(X)	72x20x29	221/27.5	1,387	1,495	1,535	1,671
	NSC6624D3(X)	66x24x29	232/31.7	1,458	1,572	1,592	1,715
	NSC6620D3(X)	66x20x29	188/26.8	1,295	1,407	1,432	1,592
	NSC6024D3(X)	60x24x29	222/28.9	1,378	1,478	1,525	1,647
	NSC6020D3(X)	60x20x29	178/24.5	1,213	1,380	1,400	1,523

Hinged doors

 <p><b>Full Credenza</b> 2 File Left Closed Storage Center 2 Box, File Right</p>	NSC7224D4(X)	72x24x29	242/35.0	1,552	1,671	1,707	1,830
	NSC7220D4(X)	72x20x29	221/27.5	1,387	1,495	1,535	1,671
	NSC6624D4(X)	66x24x29	232/31.7	1,458	1,572	1,592	1,715
	NSC6620D4(X)	66x20x29	188/26.8	1,295	1,407	1,432	1,592
	NSC6024D4(X)	60x24x29	222/28.9	1,378	1,478	1,525	1,647
	NSC6020D4(X)	60x20x29	178/24.5	1,213	1,380	1,400	1,523

Hinged doors

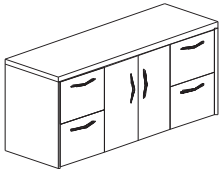
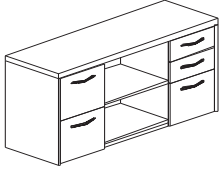
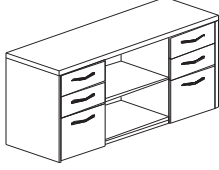
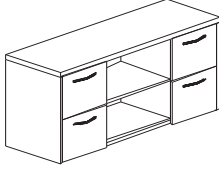
**Ordering Details:**

(X) - Specify 'M1' for 1" LPL, 'M2' for 1-1/2" LPL, 'H1' for 1-1/8" HPL, or 'H2' for 1-1/2" HPL.

**Options:**

**High pressure drawer fronts add \$483 list to above prices, and specify on order.**

# Credenzas

CREDENZAS	Model	Size (WDH)	Wt./Cube	LPL		HPL		
				1"	1-1/2"	1-1/8"	1-1/2"	
 <p>2 File Left Closed Storage Center 2 File Right</p>	NSC7224D5(X)	72x24x29	273/35.0	1,552	1,671	1,707	1,830	
	NSC7220D5(X)	72x20x29	231/27.5	1,387	1,495	1,535	1,671	
	NSC6624D5(X)	66x24x29	263/28.9	1,458	1,572	1,592	1,715	
	NSC6620D5(X)	66x20x29	221/26.8	1,295	1,407	1,432	1,592	
	NSC6024D5(X)	60x24x29	242/31.7	1,378	1,478	1,525	1,647	
	NSC6020D5(X)	60x20x29	200/24.5	1,213	1,380	1,400	1,523	
	<i>Hinged doors</i>							
	<i>Note: Storage cupboard has one adjustable shelf.</i>							
 <p><b>Double Ped Credenza</b> 2 File Left Open Storage Center 2 Box, File Right</p>	NSC7224D6(X)	72x24x29	222/35.0	1,491	1,609	1,645	1,768	
	NSC7220D6(X)	72x20x29	201/27.5	1,326	1,434	1,473	1,609	
	NSC6624D6(X)	66x24x29	212/31.7	1,398	1,510	1,530	1,653	
	NSC6620D6(X)	66x20x29	168/26.8	1,233	1,346	1,370	1,530	
	NSC6024D6(X)	60x24x29	202/28.9	1,317	1,418	1,464	1,587	
	NSC6020D6(X)	60x20x29	158/24.5	1,152	1,319	1,339	1,462	
	<i>Note: Storage cupboard has one adjustable shelf.</i>							
	 <p><b>Double Ped Credenza</b> 2 Box, File Left Open Storage Center 2 Box, File Right</p>	NSC7224D7(X)	72x24x29	222/35.0	1,491	1,609	1,645	1,768
NSC7220D7(X)		72x20x29	201/27.5	1,326	1,434	1,473	1,609	
NSC6624D7(X)		66x24x29	212/31.7	1,398	1,510	1,530	1,653	
NSC6620D7(X)		66x20x29	168/26.8	1,233	1,346	1,370	1,530	
NSC6024D7(X)		60x24x29	202/28.9	1,317	1,418	1,464	1,587	
NSC6020D7(X)		60x20x29	158/24.5	1,152	1,319	1,339	1,462	
<i>Note: Storage cupboard has one adjustable shelf.</i>								
 <p><b>Double Ped Credenza</b> 2 File Left Open Storage Center 2 File Right</p>		NSC7224D8(X)	72x24x29	222/35.0	1,491	1,609	1,645	1,768
	NSC7220D8(X)	72x20x29	201/27.5	1,326	1,434	1,473	1,609	
	NSC6624D8(X)	66x24x29	212/31.7	1,398	1,510	1,530	1,653	
	NSC6620D8(X)	66x20x29	168/26.8	1,233	1,346	1,370	1,530	
	NSC6024D8(X)	60x24x29	202/28.9	1,317	1,418	1,464	1,587	
	NSC6020D8(X)	60x20x29	158/24.5	1,152	1,319	1,339	1,462	
	<i>Note: Storage cupboard has one adjustable shelf.</i>							

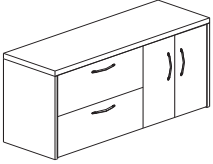
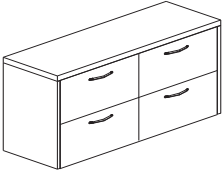
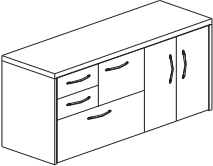
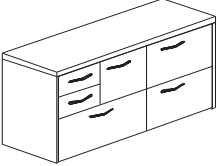
**Ordering Details:**

(X) - Specify 'M1' for 1" LPL, 'M2' for 1-1/2" LPL, 'H1' for 1-1/8" HPL, or 'H2' for 1-1/2" HPL.

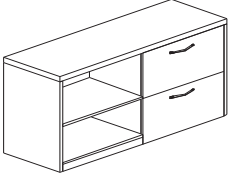
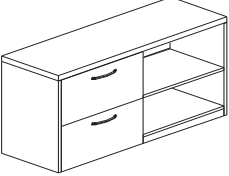
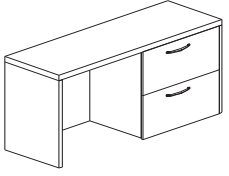
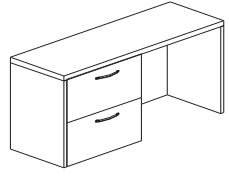
**Options:**

**High pressure drawer fronts add \$242 list to above prices for double ped, and \$483 list for full credenza, and specify on order.**

# Credenzas

LATERAL FILE CREDENZAS	Model	Size (WDH)	Wt./Cube	LPL		HPL		
				1"	1-1/2"	1-1/8"	1-1/2"	
 <p><b>Lateral/Storage Credenza</b> Lateral File Left Closed Storage Right</p>	NSC7224LS(X)	72x24x29	270/34.5	1,260	1,466	1,407	1,555	
	NSC7220LS(X)	72x20x29	219/29.2	1,235	1,383	1,383	1,530	
	<i>Laterals above are 36" wide, storage cupboard has one adjustable shelf.</i>							
	NSC6624LS(X)	66x24x29	260/31.7	1,253	1,449	1,400	1,548	
	NSC6620LS(X)	66x20x29	188/26.8	1,216	1,363	1,363	1,510	
	<i>Laterals above are 36" wide, storage cupboard has one adjustable shelf.</i>							
 <p><b>Double Lateral Credenza</b></p>	NSC6024LS(X)	60x24x29	245/28.9	1,242	1,376	1,397	1,544	
	NSC6020LS(X)	60x20x29	209/24.5	1,167	1,314	1,314	1,462	
	<i>Laterals above are 30" wide, storage cupboard has one adjustable shelf.</i>							
	NSC7224LL(X)	72x24x29	298/34.5	1,401	1,545	1,549	1,693	
	NSC7220LL(X)	72x20x29	240/29.2	1,358	1,471	1,506	1,618	
	<i>Laterals above are 36" wide.</i>							
 <p><b>Personal Pedestal/Storage Credenza</b> Personal Pedestal 2 Box Left, Left Closed Storage Right</p>	NSC6024LL(X)	60x24x29	240/28.9	1,289	1,462	1,436	1,609	
	NSC6020LL(X)	60x20x29	182/24.5	1,216	1,387	1,363	1,510	
	<i>Laterals above are 30" wide.</i>							
	NSC7224PS(X)	72x24x29	271/34.5	1,671	1,793	1,940	2,076	
	NSC7220PS(X)	72x20x29	239/29.2	1,481	1,603	1,751	1,891	
	<i>Personal Pedestals above are 36" wide, closed storage has one adjustable shelf.</i>							
 <p><b>Personal Pedestal/Lateral File Credenza</b> Personal Pedestal 2 Box Left, Left Lateral Right</p>	NSC6624PS(X)	66x24x29	261/31.7	1,596	1,719	1,854	2,001	
	NSC6620PS(X)	66x20x29	229/26.8	1,412	1,535	1,682	1,818	
	<i>Personal Pedestals above are 36" wide, closed storage has one adjustable shelf.</i>							
	NSC6024PS(X)	60x24x29	240/28.9	1,523	1,645	1,793	1,928	
	NSC6020PS(X)	60x20x29	208/24.5	1,339	1,462	1,609	1,756	
	<i>Personal Pedestals above are 30" wide, closed storage has one adjustable shelf.</i>							
<p><b>Ordering Details:</b></p> <p><b>Options:</b></p>	(X) - Specify 'M1' for 1" LPL, 'M2' for 1-1/2" LPL, 'H1' for 1-1/8" HPL, or 'H2' for 1-1/2" HPL. <b>High pressure drawer fronts add \$483 list to above prices, and specify on order.</b>							
	<i>Substitute 'SP' for 'PS' in model number above for Storage on left, Personal Pedestal 2 Box Right on right.</i>							
	NSC7224PL(X)	72x24x29	271/34.5	1,916	2,039	2,186	2,322	
	NSC7220PL(X)	72x20x29	239/29.2	1,726	1,849	1,997	2,137	
	NSC6624PL(X)	66x24x29	261/31.7	2,333	2,456	2,591	2,738	
	NSC6620PL(X)	66x20x29	229/26.8	1,658	1,781	1,928	2,063	
<i>Personal Pedestals above are 36" wide.</i>								
NSC6024PL(X)	60x24x29	240/28.9	1,768	1,891	2,039	2,174		
NSC6020PL(X)	60x20x29	208/24.5	1,584	1,707	1,854	2,001		
<i>Personal Pedestals above are 30" wide.</i>								
<i>Substitute 'LP' for 'PL' in model number above for Lateral File on left, Personal Pedestal 2 Box Right on right</i>								

# Credenzas

LATERAL FILE CREDENZAS	Model	Size (WDH)	Wt./Cube	LPL		HPL		
				1"	1-1/2"	1-1/8"	1-1/2"	
	NSC7224L1(X)	72x24x29	270/34.5	1,326	1,400	1,473	1,609	
	NSC7220L1(X)	72x20x29	231/25.0	1,167	1,289	1,314	1,449	
	<i>Laterals above are 36" wide, open storage has one adjustable shelf.</i>							
	NSC6624L1(X)	66x24x29	260/31.7	1,253	1,376	1,400	1,535	
	NSC6620L1(X)	66x20x29	209/26.8	1,093	1,216	1,240	1,376	
	<i>Laterals above are 36" wide, open storage has one adjustable shelf.</i>							
<b>Lateral/Storage Credenza</b> Open Storage Left Lateral File Right	NSC6024L1(X)	60x24x29	239/28.9	1,179	1,302	1,326	1,462	
	NSC6020L1(X)	60x20x29	188/24.5	1,019	1,141	1,167	1,302	
<i>Laterals above are 30" wide, open storage has one adjustable shelf.</i>								
	NSC7224L2(X)	72x24x29	270/34.5	1,326	1,400	1,473	1,609	
	NSC7220L2(X)	72x20x29	231/25.0	1,167	1,289	1,314	1,449	
	<i>Laterals above are 36" wide, open storage has one adjustable shelf.</i>							
	NSC6624L2(X)	66x24x29	260/31.7	1,253	1,376	1,400	1,535	
	NSC6620L2(X)	66x20x29	209/26.8	1,093	1,216	1,240	1,376	
	<i>Laterals above are 36" wide, open storage has one adjustable shelf.</i>							
<b>Lateral/Storage Credenza</b> Lateral File Left Open Storage Right	NSC6024L2(X)	60x24x29	239/28.9	1,179	1,302	1,326	1,462	
	NSC6020L2(X)	60x20x29	188/24.5	1,019	1,141	1,167	1,302	
<i>Laterals above are 30" wide, open storage has one adjustable shelf.</i>								
	NSC7224L3(X)	72x24x29	195/34.5	1,032	1,220	1,180	1,368	
	NSC7220L3(X)	72x20x29	161/25.0	989	1,134	1,137	1,282	
	<i>Laterals above are 36" wide.</i>							
	NSC6624L3(X)	66x24x29	169/31.7	995	1,140	1,143	1,290	
	NSC6620L3(X)	66x20x29	139/26.8	959	1,049	1,106	1,254	
	<i>Laterals above are 36" wide.</i>							
<b>Lateral Right</b>	NSC6024L3(X)	60x24x29	150/28.9	978	1,141	1,125	1,272	
	NSC6020L3(X)	60x20x29	128/24.5	946	1,031	1,094	1,241	
<i>Laterals above are 30" wide.</i>								
	NSC7224L4(X)	72x24x29	195/34.5	1,032	1,220	1,180	1,368	
	NSC7220L4(X)	72x20x29	161/25.0	989	1,134	1,137	1,282	
	<i>Laterals above are 36" wide.</i>							
	NSC6624L4(X)	66x24x29	169/31.7	995	1,140	1,143	1,290	
	NSC6620L4(X)	66x20x29	139/26.8	959	1,049	1,106	1,254	
	<i>Laterals above are 36" wide.</i>							
<b>Lateral Left</b>	NSC6024L4(X)	60x24x29	150/28.9	978	1,141	1,125	1,272	
	NSC6020L4(X)	60x20x29	128/24.5	946	1,031	1,094	1,241	
<i>Laterals above are 30" wide.</i>								

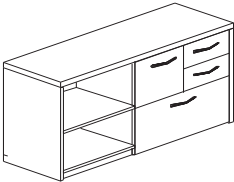
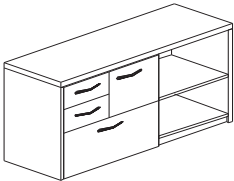
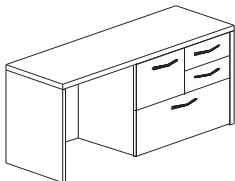
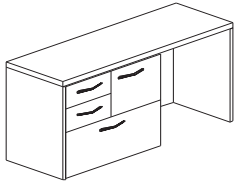
**Ordering Details:**

(X) - Specify 'M1' for 1" LPL, 'M2' for 1-1/2" LPL,

'H1' for 1-1/8" HPL, or 'H2' for 1-1/2" HPL. **High pressure drawer fronts add \$242 list to above prices, and specify on order.**

**Options:**

# Credenzas

PERSONAL PEDESTAL CREDENZAS	Model	Size (WDH)	Wt./Cube	LPL		HPL		
				1"	1-1/2"	1-1/8"	1-1/2"	
	NSC7224L5(X)	72x24x29	270/34.5	1,449	1,523	1,596	1,731	
	NSC7220L5(X)	72x20x29	231/25.0	1,289	1,412	1,436	1,572	
	<i>Personal Peds above are 36" wide, open storage has one adjustable shelf.</i>							
	NSC6624L5(X)	66x24x29	260/31.7	1,376	1,498	1,523	1,658	
	NSC6620L5(X)	66x20x29	209/26.8	1,216	1,339	1,363	1,498	
	<i>Personal Peds above are 36" wide, open storage has one adjustable shelf.</i>							
<b>Credenza</b> Open Storage Left Personal Pedestal Right	NSC6024L5(X)	60x24x29	239/28.9	1,302	1,425	1,449	1,584	
	NSC6020L5(X)	60x20x29	188/24.5	1,141	1,264	1,289	1,425	
	<i>Personal Peds above are 30" wide, open storage has one adjustable shelf.</i>							
		NSC7224L6(X)	72x24x29	270/34.5	1,449	1,523	1,596	1,731
		NSC7220L6(X)	72x20x29	231/25.0	1,289	1,412	1,436	1,572
		<i>Personal Peds above are 36" wide, open storage has one adjustable shelf.</i>						
NSC6624L6(X)		66x24x29	260/31.7	1,376	1,498	1,523	1,658	
NSC6620L6(X)		66x20x29	209/26.8	1,216	1,339	1,363	1,498	
<i>Personal Peds above are 36" wide, open storage has one adjustable shelf.</i>								
<b>Personal Pedestal/Storage Credenza</b> Open Storage Right Personal Pedestal Left	NSC6024L6(X)	60x24x29	239/28.9	1,302	1,425	1,449	1,584	
	NSC6020L6(X)	60x20x29	188/24.5	1,141	1,264	1,289	1,423	
	<i>Personal Peds above are 30" wide, open storage has one adjustable shelf.</i>							
		NSC7224L7(X)	72x24x29	195/34.5	1,155	1,343	1,303	1,491
		NSC7220L7(X)	72x20x29	161/25.0	1,112	1,257	1,260	1,405
		<i>Laterals above are 36" wide.</i>						
NSC6624L7(X)		66x24x29	169/31.7	1,118	1,263	1,266	1,413	
NSC6620L7(X)		66x20x29	139/26.8	1,082	1,172	1,229	1,377	
<i>Laterals above are 36" wide.</i>								
<b>Personal Pedestal Right</b>	NSC6024L7(X)	60x24x29	150/28.9	1,100	1,264	1,247	1,394	
	NSC6020L7(X)	60x20x29	128/24.5	1,069	1,154	1,217	1,364	
	<i>Laterals above are 30" wide.</i>							
		NSC7224L8(X)	72x24x29	195/34.5	1,155	1,343	1,303	1,491
		NSC7220L8(X)	72x20x29	161/25.0	1,112	1,257	1,260	1,405
		<i>Laterals above are 36" wide.</i>						
NSC6624L8(X)		66x24x29	169/31.7	1,118	1,263	1,266	1,413	
NSC6620L8(X)		66x20x29	139/26.8	1,082	1,172	1,229	1,377	
<i>Laterals above are 36" wide.</i>								
<b>Personal Pedestal Left</b>	NSC6024L8(X)	60x24x29	150/28.9	1,100	1,264	1,247	1,394	
	NSC6020L8(X)	60x20x29	128/24.5	1,069	1,154	1,217	1,364	
<i>Laterals above are 30" wide.</i>								

**Ordering Details:**

(X) - Specify 'M1' for 1" LPL, 'M2' for 1-1/2" LPL,

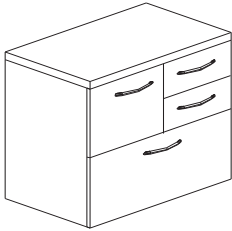
'H1' for 1-1/8" HPL, or 'H2' for 1-1/2" HPL. **High pressure drawer fronts add**

**Options:**

**\$242 list to above prices, and specify on order.**

# Personal Pedestal & Radius End

PERSONAL PEDESTALS/ CREDENZAS RADIUS END	Model	Size (WDH)	Wt./Cube	LPL		HPL	
				1"	1-1/2"	1-1/8"	1-1/2"



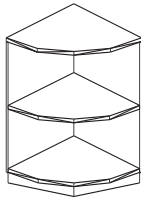
**Personal Pedestal  
2 Box Right**

PP2BR362429(X)	36x24x29	120/16.0	811	819	978	1,100
PP2BR362029(X)	36x20x29	100/16.0	903	1,026	952	1,088
PP2BR302429(X)	30x24x29	115/14.0	879	1,002	928	1,051
PP2BR302029(X)	30x20x29	95/14.0	842	965	903	1,026

*Personal Pedestal 2 Box Right*

PP2BL362429(X)	36x24x29	120/16.0	811	819	978	1,100
PP2BL362029(X)	36x20x29	100/16.0	903	1,026	952	1,088
PP2BL302429(X)	30x24x29	115/14.0	879	1,002	928	1,051
PP2BL302029(X)	30x20x29	95/14.0	842	965	903	1,026

*Personal Pedestal 2 Box Left*



**Credenza Corner  
Radiused End Bookcase**  
Open Storage  
with Base and Top

CRE3029(X)	30x30x29	90/13.0	487	559	565	635
CRE2429(X)	24x24x29	85/11.8	390	446	452	508
CRE2029(X)	20x20x29	70/8.5	329	384	390	445

*29" high*

**Ordering Details:**

(X) - Specify 'M1' for 1" LPL, 'M2' for 1-1/2" LPL, 'H1' for 1-1/8" HPL, or 'H2' for 1-1/2" HPL.

**Options:**

**High pressure drawer fronts add \$242 list to above prices, and specify on order.**



# Table Specifications

BRC manufactures tables, table desks, desks, bridges, returns and credenzas. They are available in a multitude of widths, depths and styles, with a vast array of drawer and storage arrangements. **For clarification:** tables, bridges, returns and credenzas have flush modesty panels. Desks and table desks have modesty panels recessed 6".

Modesty panels are standard in 3/4 height (20") and are constructed of 1" thick, high density, LPL.

Modesty panels are optionally available in full height, half height (12"), and one-quarter height (7").

Grommets are standard in the tops and recessed gables of bridges, returns and tables.

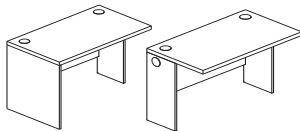
Two grommets are standard on all tops of tables, bridges, and returns.

Grommets are optional on desks, table desks and credenzas. If desired they must be specified at time of order.

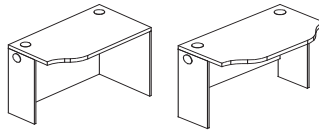
Worksurfaces are available with four core/surface material options, M1 - 1" or M2 - 1-1/2" thick high density LPL and H1 - 1-1/8" or H2 - 1-1/2" thick HPL, including woodgrain finishes.

Table tops have a wide variety of widths and are available in 6" increments from 24" to 84". All exposed edges are coated with rigid PVC 1/8" (2.5mm) thick.

Most tables are shipped knocked down.



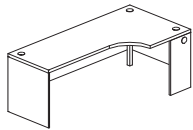
**Regular Tables**



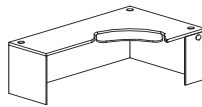
**Sculptured Tables**



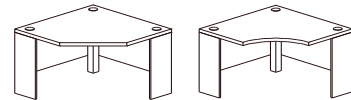
**Rear Cut-Away Corners**



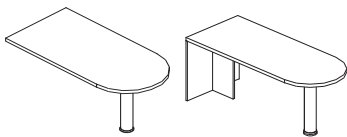
**Extended Corner Curved**



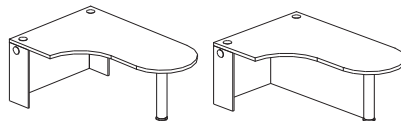
**Extended Corner Keyboard Cut-Out**



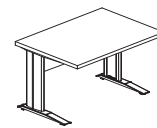
**Full Corners**



**Bullet Worksurfaces**

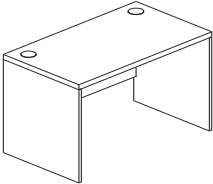
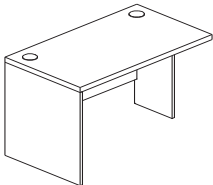
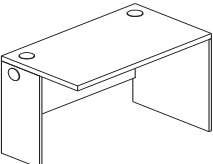
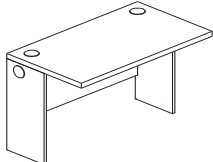


**Extended Bullet Worksurfaces**



**C-Leg Tables**

# Tables

REGULAR TABLES	Model	Size (WDH)	Wt./Cube	LPL		HPL	
				1"	1-1/2"	1-1/8"	1-1/2"
 <b>Full Gables (F)</b>	NS8436(#)(X)	84x36x29	157/11.0	1,019	1,093	1,105	1,203
	NS7836(#)(X)	78x36x29	150/10.5	958	1,031	1,044	1,141
	NS7236(#)(X)	72x36x29	181/9.5	809	944	931	1,079
	NS6636(#)(X)	66x36x29	164/8.8	758	907	881	1,030
	NS6036(#)(X)	60x36x29	113/8.0	764	863	851	949
	NS5436(#)(X)	54x36x29	103/7.0	737	836	823	922
	NS4836(#)(X)	48x36x29	93/6.5	704	801	790	887
	NS4236(#)(X)	42x36x29	91/5.8	674	772	760	858
	NS3636(#)(X)	36x36x29	89/5.0	657	758	743	842
	<i>36" deep</i>						
 <b>Right Recessed Gable (R)</b>	NS8430(#)(X)	84x30x29	139/9.5	785	844	933	992
	NS7830(#)(X)	78x30x29	132/8.8	692	751	840	899
	NS7230(#)(X)	72x30x29	115/8.2	529	588	676	735
	NS6630(#)(X)	66x30x29	105/7.6	519	569	667	717
	NS6030(#)(X)	60x30x29	95/6.9	491	549	639	697
	NS5430(#)(X)	54x30x29	85/6.2	486	527	633	675
	NS4830(#)(X)	48x30x29	75/5.5	458	507	605	654
	NS4230(#)(X)	42x30x29	73/4.8	426	483	574	631
	NS3630(#)(X)	36x30x29	70/4.2	410	459	558	606
	<i>30" deep</i>						
 <b>Left Recessed Gable (L)</b>	NS8424(#)(X)	84x24x29	134/7.8	726	785	873	933
	NS7824(#)(X)	78x24x29	128/7.2	603	663	750	811
	NS7224(#)(X)	72x24x29	110/6.7	489	549	637	697
	NS6624(#)(X)	66x24x29	97/6.1	465	525	612	672
	NS6024(#)(X)	60x24x29	85/5.6	453	512	600	660
	NS5424(#)(X)	54x24x29	79/5.0	449	491	596	639
	NS4824(#)(X)	48x24x29	70/4.5	428	471	575	618
	NS4224(#)(X)	42x24x29	67/3.9	403	446	551	594
	NS3624(#)(X)	36x24x29	65/3.4	374	397	522	545
	<i>24" deep</i>						
 <b>Double Recessed Gable (D)</b>	NS3024(#)(X)	30x24x29	57/2.8	349	384	496	531
	NS2424(#)(X)	24x24x29	52/2.3	344	356	491	503

**Ordering Details:**

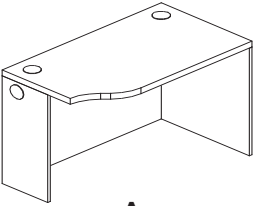
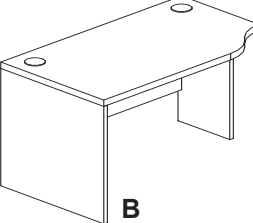
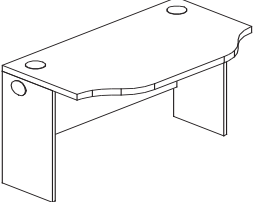
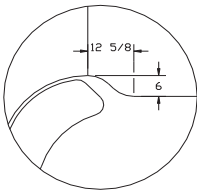
(#) - Specify gable - 'F', 'R', 'L' or 'D'.  
 Recessed gable depth: 11".  
 (X) - Specify 'M1' for 1" LPL, 'M2' for 1-1/2" LPL,  
 'H1' for 1-1/8" HPL, or 'H2' for 1-1/2" HPL.

**Options:**

**Full Modesty Panels are available, add "FM" to part.**  
**1/2 Modesty Panels (12") are available, add "TM" to part.**  
**1/4 Modesty Panels (7") are available, add "QM" to part. & 158.00 to list price.**  
 Keyboard cut-out (not incl mechanism), add \$84 list; add (CO) to model number.  
 Specify keyboard cut-out location including width and depth.

Shorter modesties will result in pedestal or storage visibility from the visitor side of the tables. Some pedestals or storage elements have finishes which differ from the modesty and may be seen. BRC accepts no responsibility for these circumstances.

# Sculptured Tables

SCULPTURED TABLES	Model	Size (WDD)	Wt./Cube (KD)	LPL		HPL																																																																														
				1"	1-1/2"	1-1/8"	1-1/2"																																																																													
 <p><b>A</b> Single Sculpture Left Full Modesty -FM</p>	<b>29" Fixed Height</b>																																																																																			
	NSS843024(#)(X)	84x30x24	96/4.0	798	859	945	1,004																																																																													
	NSS783024(#)(X)	78x30x24	88/4.0	705	764	852	910																																																																													
	NSS723024(#)(X)	72x30x24	82/3.0	558	611	713	816																																																																													
	NSS663024(#)(X)	66x30x24	76.3.0	539	599	670	812																																																																													
	NSS603024(#)(X)	60x30x24	69/2.0	520	574	627	804																																																																													
	NSS543024(#)(X)	54x30x24	62/2.0	503	553	606	768																																																																													
	NSS483024(#)(X)	48x30x24	55/1.5	477	532	587	807																																																																													
	NSS423024(#)(X)	42x30x24	48/1.5	459	507	582	705																																																																													
	NSS363024(#)(X)	36x30x24	42/1.2	435	483	558	680																																																																													
NSS303024(#)(X)	30x30x24	35/1.0	410	452	532	655																																																																														
NSS243024(#)(X)	24x30x24	28/1.0	406	426	529	652																																																																														
<i>30" depth on full end, 24" depth on one sculptured end.</i>																																																																																				
 <p><b>B</b> Single Sculpture Right 3/4 Modesty</p>	<table border="1"> <tbody> <tr> <td>NSS842418(#)(X)</td> <td>84x24x18</td> <td>95/3.0</td> <td>749</td> <td>778</td> <td>939</td> <td>994</td> </tr> <tr> <td>NSS782418(#)(X)</td> <td>78x24x18</td> <td>87/3.0</td> <td>655</td> <td>735</td> <td>845</td> <td>894</td> </tr> <tr> <td>NSS722418(#)(X)</td> <td>72x24x18</td> <td>80/2.0</td> <td>508</td> <td>594</td> <td>707</td> <td>799</td> </tr> <tr> <td>NSS662418(#)(X)</td> <td>66x24x18</td> <td>73/2.0</td> <td>489</td> <td>545</td> <td>663</td> <td>785</td> </tr> <tr> <td>NSS602418(#)(X)</td> <td>60x24x18</td> <td>67/2.0</td> <td>471</td> <td>525</td> <td>614</td> <td>761</td> </tr> <tr> <td>NSS542418(#)(X)</td> <td>54x24x18</td> <td>60/1.6</td> <td>467</td> <td>516</td> <td>594</td> <td>749</td> </tr> <tr> <td>NSS482418(#)(X)</td> <td>48x24x18</td> <td>54/1.5</td> <td>453</td> <td>507</td> <td>574</td> <td>697</td> </tr> <tr> <td>NSS422418(#)(X)</td> <td>42x24x18</td> <td>47/1.3</td> <td>428</td> <td>483</td> <td>551</td> <td>674</td> </tr> <tr> <td>NSS362418(#)(X)</td> <td>36x24x18</td> <td>41/1.1</td> <td>401</td> <td>459</td> <td>524</td> <td>647</td> </tr> <tr> <td>NSS302418(#)(X)</td> <td>30x24x18</td> <td>34/1.0</td> <td>379</td> <td>435</td> <td>502</td> <td>625</td> </tr> <tr> <td>NSS242418(#)(X)</td> <td>24x24x18</td> <td>28/1.0</td> <td>369</td> <td>410</td> <td>491</td> <td>614</td> </tr> </tbody> </table>							NSS842418(#)(X)	84x24x18	95/3.0	749	778	939	994	NSS782418(#)(X)	78x24x18	87/3.0	655	735	845	894	NSS722418(#)(X)	72x24x18	80/2.0	508	594	707	799	NSS662418(#)(X)	66x24x18	73/2.0	489	545	663	785	NSS602418(#)(X)	60x24x18	67/2.0	471	525	614	761	NSS542418(#)(X)	54x24x18	60/1.6	467	516	594	749	NSS482418(#)(X)	48x24x18	54/1.5	453	507	574	697	NSS422418(#)(X)	42x24x18	47/1.3	428	483	551	674	NSS362418(#)(X)	36x24x18	41/1.1	401	459	524	647	NSS302418(#)(X)	30x24x18	34/1.0	379	435	502	625	NSS242418(#)(X)	24x24x18	28/1.0	369	410	491	614
	NSS842418(#)(X)	84x24x18	95/3.0	749	778	939	994																																																																													
	NSS782418(#)(X)	78x24x18	87/3.0	655	735	845	894																																																																													
	NSS722418(#)(X)	72x24x18	80/2.0	508	594	707	799																																																																													
	NSS662418(#)(X)	66x24x18	73/2.0	489	545	663	785																																																																													
	NSS602418(#)(X)	60x24x18	67/2.0	471	525	614	761																																																																													
	NSS542418(#)(X)	54x24x18	60/1.6	467	516	594	749																																																																													
	NSS482418(#)(X)	48x24x18	54/1.5	453	507	574	697																																																																													
	NSS422418(#)(X)	42x24x18	47/1.3	428	483	551	674																																																																													
	NSS362418(#)(X)	36x24x18	41/1.1	401	459	524	647																																																																													
NSS302418(#)(X)	30x24x18	34/1.0	379	435	502	625																																																																														
NSS242418(#)(X)	24x24x18	28/1.0	369	410	491	614																																																																														
<i>24" depth on full end, 18" depth on one sculptured end.</i>																																																																																				
 <p><b>D</b> Double Sculpture 3/4 Modesty</p>	<table border="1"> <tbody> <tr> <td>NSS843024D(X)</td> <td>84x30x24</td> <td>96/4.0</td> <td>827</td> <td>886</td> <td>974</td> <td>1,044</td> </tr> <tr> <td>NSS783024D(X)</td> <td>78x30x24</td> <td>88/4.0</td> <td>741</td> <td>790</td> <td>888</td> <td>936</td> </tr> <tr> <td>NSS723024D(X)</td> <td>72x30x24</td> <td>80/2.0</td> <td>602</td> <td>672</td> <td>749</td> <td>841</td> </tr> <tr> <td>NSS663024D(X)</td> <td>66x30x24</td> <td>73/2.0</td> <td>589</td> <td>660</td> <td>736</td> <td>836</td> </tr> <tr> <td>NSS603024D(X)</td> <td>60x30x24</td> <td>67/2.0</td> <td>565</td> <td>635</td> <td>712</td> <td>816</td> </tr> </tbody> </table>							NSS843024D(X)	84x30x24	96/4.0	827	886	974	1,044	NSS783024D(X)	78x30x24	88/4.0	741	790	888	936	NSS723024D(X)	72x30x24	80/2.0	602	672	749	841	NSS663024D(X)	66x30x24	73/2.0	589	660	736	836	NSS603024D(X)	60x30x24	67/2.0	565	635	712	816																																										
	NSS843024D(X)	84x30x24	96/4.0	827	886	974	1,044																																																																													
	NSS783024D(X)	78x30x24	88/4.0	741	790	888	936																																																																													
	NSS723024D(X)	72x30x24	80/2.0	602	672	749	841																																																																													
	NSS663024D(X)	66x30x24	73/2.0	589	660	736	836																																																																													
	NSS603024D(X)	60x30x24	67/2.0	565	635	712	816																																																																													
	<i>30" tables sculptured to 24" on both ends.</i>																																																																																			
	 <p><b>Top View Sculpted Corner</b></p>	<table border="1"> <tbody> <tr> <td>NSS842418D(X)</td> <td>84x24x18</td> <td>95/3.0</td> <td>798</td> <td>855</td> <td>959</td> <td>1,019</td> </tr> <tr> <td>NSS782418D(X)</td> <td>78x24x18</td> <td>87/3.0</td> <td>729</td> <td>777</td> <td>877</td> <td>918</td> </tr> <tr> <td>NSS722418D(X)</td> <td>72x24x18</td> <td>78/2.0</td> <td>583</td> <td>655</td> <td>729</td> <td>816</td> </tr> <tr> <td>NSS662418D(X)</td> <td>66x24x18</td> <td>71/2.0</td> <td>570</td> <td>606</td> <td>700</td> <td>812</td> </tr> <tr> <td>NSS602418D(X)</td> <td>60x24x18</td> <td>65/2.0</td> <td>546</td> <td>587</td> <td>672</td> <td>804</td> </tr> </tbody> </table>							NSS842418D(X)	84x24x18	95/3.0	798	855	959	1,019	NSS782418D(X)	78x24x18	87/3.0	729	777	877	918	NSS722418D(X)	72x24x18	78/2.0	583	655	729	816	NSS662418D(X)	66x24x18	71/2.0	570	606	700	812	NSS602418D(X)	60x24x18	65/2.0	546	587	672	804																																									
		NSS842418D(X)	84x24x18	95/3.0	798	855	959	1,019																																																																												
		NSS782418D(X)	78x24x18	87/3.0	729	777	877	918																																																																												
NSS722418D(X)		72x24x18	78/2.0	583	655	729	816																																																																													
NSS662418D(X)		66x24x18	71/2.0	570	606	700	812																																																																													
NSS602418D(X)	60x24x18	65/2.0	546	587	672	804																																																																														
<i>24" tables sculptured to 18" on both ends.</i>																																																																																				

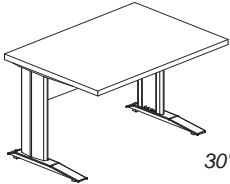
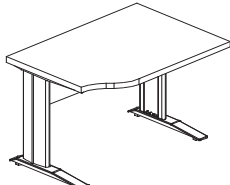
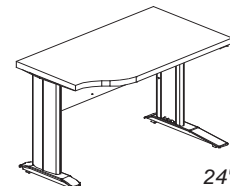
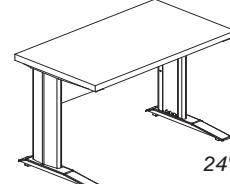
**Ordering Details:**

(#) - Specify Sculpture - 'A', 'B' For additional recessed gable, replace 'A' with 'AD' or 'B' with 'BD'.  
 (X) - Specify 'M1' for 1" LPL, 'M2' for 1-1/2" LPL, 'H1' for 1-1/8" HPL, or 'H2' for 1-1/2" HPL.

**Options:**

**Full Modesty Panels are available, add "FM" to part.**  
**1/2 Modesty Panels (12") are available, add "TM" to part.**  
**1/4 Modesty Panels (7") are available, add "QM" to part. & 158.00 to price.**  
 Shorter modesties will result in pedestal or storage visibility from the visitor side of the tables. Some pedestals or storage elements have finishes which differ from the modesty and may be seen. BRC accepts no responsibility for these circumstances.

# Smart C-Leg Tables

SMART C-LEG TABLES	Model	Size (WDH)	Wt./Cube	LPL		HPL		
				1"	1-1/2"	1-1/8"	1-1/2"	
 <p>30" deep</p>	ST8430(#)(X)	84x30x29	139/9.5	747	802	886	942	
	ST7830(#)(X)	78x30x29	132/8.8	657	714	798	854	
	ST7230(#)(X)	72x30x29	115/8.2	502	559	643	698	
	ST6630(#)(X)	66x30x29	105/7.6	494	541	633	681	
	ST6030(#)(X)	60x30x29	95/6.9	467	522	607	663	
	ST5430(#)(X)	54x30x29	85/6.2	462	501	602	642	
	ST4830(#)(X)	48x30x29	75/5.5	435	481	574	622	
	ST4230(#)(X)	42x30x29	73/4.8	405	459	546	600	
	ST3630(#)(X)	36x30x29	70/4.2	390	436	529	575	
	ST3030(#)(X)	30x30x29	65/3.5	373	413	512	552	
 <p>30" deep</p> <p>Sculpted Left "L" Shown</p>	ST2430(#)(X)	24x30x29	60/2.8	369	395	497	536	
	 <p>24" deep</p> <p>Sculpted Left "L" Shown</p>	ST8424(#)(X)	84x24x29	134/7.8	689	747	830	886
		ST7824(#)(X)	78x24x29	128/7.2	572	630	713	770
		ST7224(#)(X)	72x24x29	110/6.7	465	522	605	663
		ST6624(#)(X)	66x24x29	97/6.1	442	499	582	638
		ST6024(#)(X)	60x24x29	85/5.6	431	487	570	627
		ST5424(#)(X)	54x24x29	79/5.0	426	467	567	607
		ST4824(#)(X)	48x24x29	70/4.5	406	447	547	588
		ST4224(#)(X)	42x24x29	67/3.9	383	424	523	564
		ST3624(#)(X)	36x24x29	65/3.4	355	378	496	518
ST3024(#)(X)		30x24x29	57/2.8	331	364	470	505	
 <p>24" deep</p>	ST2424(#)(X)	24x24x29	52/2.3	328	338	467	478	

**Ordering Details:**

(X) - Specify M1 for 1" LPL, M2 for 1-1/2" LPL, H1 for 1-1/8" HPL, H2 for 1-1/2" HPL  
 (#) - Specify 'R' for sculpted right tables, 'L' for sculpted left tables.

Standard modesty panel is 12"h. Additional modesty panel heights are available.  
 3/4 modesty add (TQM) to part number (15") no price change.  
 Full modesty (FM) panels (25") add \$147.00 list to above prices.

**Legs available in black or silver only; modesty finish matches top colour.**

All Grommets are optional: add \$40.00 list and specify GR (grommet right) GL (grommet left) or GC (grommet centre). Grommets are located inside modesty panel.

**Options:**

For keyboard cut-out, add \$84 list to above prices plus '(CO)' to model number. Specify cut-out location including width and depth.

Shorter modesties will result in pedestal or storage visibility from the visitor side of tables. Some pedestals or storage elements have finishes which differ from the modesty and may be seen. BRC accepts no responsibility for these circumstances.

# Extended Corner Table Specifications

BRC manufactures extended corner tables in a multitude of widths, depths and styles. All corner tables have flush modesty panels. Modesty panels are standard in 3/4 height (20") and are constructed of 1" thick, high density, LPL. Modesty panels are optionally available in full height, half height (12"), and one-quarter height (7").

Modesty panels and gables are 1" thick LPL.

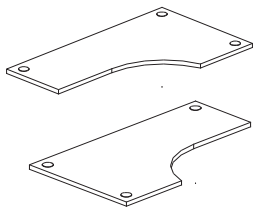
Three grommets are standard in extended corner tables except as noted.

Worksurfaces are available with four core/surface material options, M1 - 1" or M2 - 1-1/2" thick high density LPL and H1 - 1-1/8" or H2 - 1-1/2" thick HPL, including woodgrain finishes.

All exposed edges are coated with rigid PVC 1/8" (2.5 mm) thick.

**Custom size tables are available. Please call for details and pricing.**

There are two types of extended corner tables to specify:



"A" - Left Extended

"B" - Right Extended

There are four gable styles to specify:

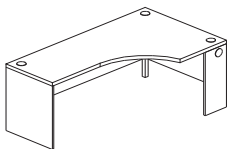
"L" - Left Recessed Gable

"R" - Right Recessed Gable

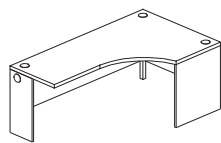
"F" - Full Gable

"D" - Double Recessed Gable

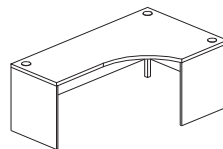
Most extended corner tables are shipped knocked down.



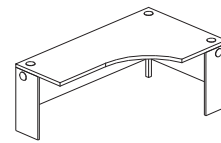
**AR**



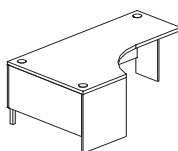
**AL**



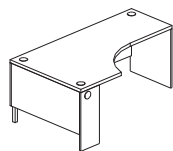
**AF**



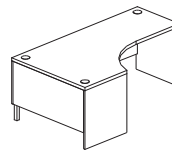
**AD**



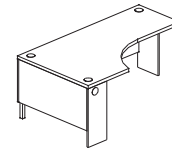
**BR**



**BL**

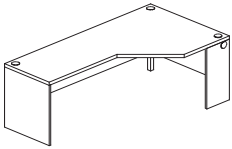
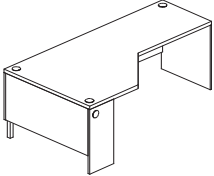
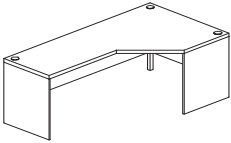
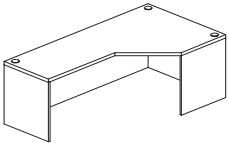
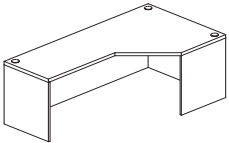


**BF**



**BD**

# Extended Corner Tables

EXTENDED CORNER ANGLE FRONT	Model	Size (GLWGH)	Wt./Cube	LPL (KD)		HPL	
				1"	1-1/2"	1-1/8"	1-1/2"
<b>24" Deep Gables</b>							
	NSXCA284602(#)(X)	24x84x60x24x29	205/18.5	1,122	1,306	1,349	1,430
	NSXCA278602(#)(X)	24x78x60x24x29	192/17.2	1,096	1,275	1,317	1,398
	NSXCA272602(#)(X)	24x72x60x24x29	179/15.9	1,071	1,242	1,289	1,364
	NSXCA266602(#)(X)	24x66x60x24x29	166/14.6	1,045	1,211	1,262	1,343
	NSXCA260602(#)(X)	24x60x60x24x29	153/13.3	1,025	1,191	1,233	1,314
<b>Right Recessed Gable (R) 3/4 Modesty</b>							
	NSXCA284542(#)(X)	24x84x54x24x29	191/16.0	1,082	1,259	1,302	1,383
	NSXCA278542(#)(X)	24x78x54x24x29	178/15.0	1,051	1,227	1,263	1,344
	NSXCA272542(#)(X)	24x72x54x24x29	165/14.0	1,019	1,191	1,213	1,300
	NSXCA266542(#)(X)	24x66x54x24x29	152/12.0	987	1,153	1,188	1,268
	NSXCA260542(#)(X)	24x60x54x24x29	145/11.0	967	1,133	1,161	1,242
<b>Right Extended (B) Left Recessed Gable (L) 3/4 Modesty</b>							
	NSXCA284482(#)(X)	24x84x48x24x29	177/14.0	1,044	1,227	1,244	1,341
	NSXCA278482(#)(X)	24x78x48x24x29	165/13.0	1,006	1,183	1,195	1,292
	NSXCA272482(#)(X)	24x72x48x24x29	153/12.0	967	1,139	1,147	1,237
	NSXCA266482(#)(X)	24x66x48x24x29	145/11.0	929	1,095	1,097	1,194
	NSXCA260482(#)(X)	24x60x48x24x29	135/11.0	909	1,075	1,051	1,172
<b>Left Extended (A) Full Gables (F) 3/4 Modesty</b>							
	NSXCA284422(#)(X)	24x84x42x24x29	152/12.0	961	1,146	1,127	1,223
	NSXCA278422(#)(X)	24x78x42x24x29	142/11.0	936	1,114	1,076	1,197
	NSXCA272422(#)(X)	24x72x42x24x29	132/11.0	909	1,082	1,028	1,166
	NSXCA266422(#)(X)	24x66x42x24x29	122/10.0	884	1,050	979	1,140
	NSXCA260422(#)(X)	24x60x42x24x29	115/10.0	864	1,030	928	1,119
<b>Left Extended (A) Full Gables (F) Full Modesty (FM)</b>							
	NSXCA284362(#)(X)	24x84x36x24x29	150/11.0	884	980	1,031	1,127
	NSXCA278362(#)(X)	24x78x36x24x29	140/10.0	853	961	1,001	1,148
	NSXCA272362(#)(X)	24x72x36x24x29	124/10.0	736	844	884	1,030
	NSXCA266362(#)(X)	24x66x36x24x29	120/9.0	710	807	857	1,004
	NSXCA260362(#)(X)	24x60x36x24x29	112/9.0	697	795	844	992

**Ordering Details:**

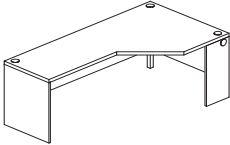
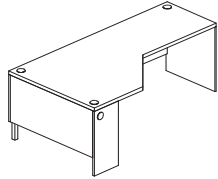
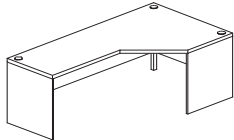
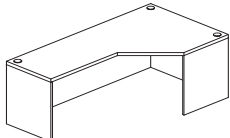
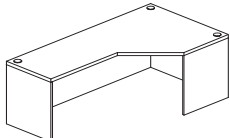
(#) - Specify style 'A' extended, or 'B' extended followed by:  
 Gables - 'L' - left recessed; 'R' - right recessed, 'D' - double recessed or  
 F' - 2 full gables.

(X) - Specify 'M1' for 1" LPL, 'M2' for 1-1/2" LPL,  
 'H1' for 1-1/8" HPL, or 'H2' for 1-1/2" HPL. Woodgrain runs horizontally on top and  
 modesty.

**Options:**

**Both Full Modesty Panels are available, add "FM" to part.**  
**Both 1/2 Modesty Panels (12") are available, add "TM" to part.**  
**Both 1/4 Modesty Panels (7") are available, add "QM" to part. & 158.00 to price.**  
**Split Modesty panels, FM (\*) TM (\*) where (\*) is insert the length of the side  
 required for FM or TM.**

# Extended Corner Tables

EXTENDED CORNER ANGLE FRONT	Model	Size (GLWGH)	Wt./Cube (KD)	LPL		HPL		
				1"	1-1/2"	1-1/8"	1-1/2"	
<b>30" Deep Gables</b>								
	NSXCA384603(#)(X)	30x84x60x30x29	215/18.5	1,162	1,347	1,390	1,471	
	NSXCA378603(#)(X)	30x78x60x30x29	202/17.2	1,134	1,313	1,355	1,435	
	NSXCA372603(#)(X)	30x72x60x30x29	189/15.9	1,106	1,278	1,325	1,400	
	NSXCA366603(#)(X)	30x66x60x30x29	176/14.6	1,075	1,241	1,293	1,374	
	NSXCA360603(#)(X)	30x60x60x30x29	163/13.3	1,065	1,231	1,272	1,353	
<b>Right Recessed Gable (R) 3/4 Modesty</b>								
	NSXCA384543(#)(X)	30x84x54x30x29	201/16.0	1,122	1,313	1,315	1,423	
	NSXCA378543(#)(X)	30x78x54x30x29	188/15.0	1,089	1,266	1,264	1,383	
	NSXCA372543(#)(X)	30x72x54x30x29	175/14.0	1,054	1,226	1,212	1,336	
	NSXCA366543(#)(X)	30x66x54x30x29	162/12.0	1,017	1,183	1,158	1,299	
	NSXCA360543(#)(X)	30x60x54x30x29	149/11.0	1,007	1,173	1,104	1,282	
<b>Right Extended (B) Left Recessed Gable (L) 3/4 Modesty</b>								
	NSXCA384483(#)(X)	30x84x48x30x29	187/14.0	1,079	1,263	1,277	1,377	
	NSXCA378483(#)(X)	30x78x48x30x29	175/13.0	1,040	1,218	1,227	1,326	
	NSXCA372483(#)(X)	30x72x48x30x29	163/12.0	1,001	1,173	1,179	1,269	
	NSXCA366483(#)(X)	30x66x48x30x29	151/11.0	961	1,127	1,130	1,225	
	NSXCA360483(#)(X)	30x60x48x30x29	139/11.0	938	1,104	1,076	1,199	
<b>Left Extended (A) Full Gables (F) 3/4 Modesty</b>								
	NSXCA384423(#)(X)	30x84x42x30x29	162/12.0	1,032	1,217	1,213	1,295	
	NSXCA378423(#)(X)	30x78x42x30x29	152/11.0	994	1,173	1,175	1,256	
	NSXCA372423(#)(X)	30x72x42x30x29	142/11.0	957	1,129	1,137	1,212	
	NSXCA366423(#)(X)	30x66x42x30x29	132/10.0	918	1,084	1,098	1,180	
	NSXCA360423(#)(X)	30x60x42x30x29	122/10.0	899	1,065	1,073	1,154	
<b>Left Extended (A) Full Gables (F)</b>								
	NSXCA384363(#)(X)	30x84x36x30x29	160/11.0	922	1,017	1,069	1,166	
	NSXCA378363(#)(X)	30x78x36x30x29	150/10.0	838	946	986	1,094	
	NSXCA372363(#)(X)	30x72x36x30x29	140/10.0	783	891	930	1,038	
	NSXCA366363(#)(X)	30x66x36x30x29	130/9.0	742	841	890	988	
	NSXCA360363(#)(X)	30x60x36x30x29	120/9.0	732	830	879	978	

**Ordering Details:**

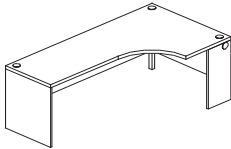
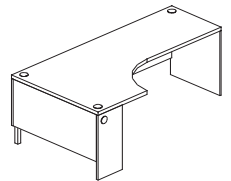
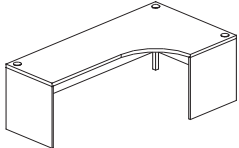
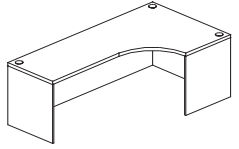
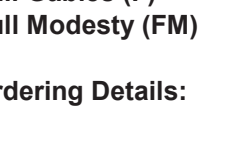
(#) - Specify style 'A' extended, or 'B' extended followed by:  
 Gables - 'L' - left recessed; 'R' - right recessed, 'D' - double recessed or  
 F' - 2 full gables.

(X) - Specify 'M1' for 1" LPL, 'M2' for 1-1/2" LPL,  
 'H1' for 1-1/8" HPL, or 'H2' for 1-1/2" HPL. Woodgrain runs horizontally on top and  
 modesty.

**Options:**

**Both Full Modesty Panels are available, add "FM" to part.**  
**Both 1/2 Modesty Panels (12") are available, add "TM" to part.**  
**Both 1/4 Modesty Panels (7") are available, add "QM" to part. & 158.00 to price.**  
**Split Modesty panels, FM (\*) TM (\*) where (\*) is insert the length of the side  
 required for FM or TM.**

# Extended Corner Tables

EXTENDED CORNER CURVED FRONT	Model	Size (GLWGH)	Wt./Cube	LPL (KD)		HPL	
				1"	1-1/2"	1-1/8"	1-1/2"
<b>24" Deep Gables</b>							
	NSXCC284602(#)(X)	24x84x60x24x29	205/18.5	1,122	1,306	1,349	1,430
	NSXCC278602(#)(X)	24x78x60x24x29	192/17.2	1,096	1,275	1,317	1,398
	NSXCC272602(#)(X)	24x72x60x24x29	179/15.9	1,071	1,242	1,289	1,364
	NSXCC266602(#)(X)	24x66x60x24x29	166/14.6	1,045	1,211	1,262	1,343
	NSXCC260602(#)(X)	24x60x60x24x29	153/13.3	1,025	1,191	1,233	1,314
<i>Curve Radius is 24" - see 24" Radius Curved Keyboard Platforms.</i>							
<b>Right Recessed Gable (R) 3/4 Modesty</b>							
	NSXCC284542(#)(X)	24x84x54x24x29	191/16.0	1,082	1,259	1,302	1,383
	NSXCC278542(#)(X)	24x78x54x24x29	178/15.0	1,051	1,227	1,263	1,344
	NSXCC272542(#)(X)	24x72x54x24x29	165/14.0	1,019	1,191	1,213	1,300
	NSXCC266542(#)(X)	24x66x54x24x29	152/12.0	987	1,153	1,188	1,268
	NSXCC260542(#)(X)	24x60x54x24x29	145/11.0	967	1,133	1,161	1,242
<i>Curve Radius is 24" - see 24" Radius Curved Keyboard Platforms.</i>							
<b>Right Extended (B) Left Recessed Gable (L) 3/4 Modesty</b>							
	NSXCC284482(#)(X)	24x84x48x24x29	177/14.0	1,044	1,227	1,244	1,341
	NSXCC278482(#)(X)	24x78x48x24x29	165/13.0	1,006	1,183	1,195	1,292
	NSXCC272482(#)(X)	24x72x48x24x29	153/12.0	967	1,139	1,147	1,237
	NSXCC266482(#)(X)	24x66x48x24x29	145/11.0	929	1,095	1,097	1,194
	NSXCC260482(#)(X)	24x60x48x24x29	135/11.0	909	1,075	1,051	1,172
<i>Curve Radius is 24" - see 24" Radius Curved Keyboard Platforms.</i>							
<b>Left Extended (A) Full Gables (F) 3/4 Modesty</b>							
	NSXCC284422(#)(X)	24x84x42x24x29	152/12.0	961	1,146	1,127	1,223
	NSXCC278422(#)(X)	24x78x42x24x29	142/11.0	936	1,114	1,076	1,197
	NSXCC272422(#)(X)	24x72x42x24x29	132/11.0	909	1,082	1,028	1,166
	NSXCC266422(#)(X)	24x66x42x24x29	122/10.0	884	1,050	979	1,140
	NSXCC260422(#)(X)	24x60x42x24x29	115/10.0	864	1,030	928	1,119
<i>Curve Radius is 18" - see 18" Radius Curved Keyboard Platforms.</i>							
<b>Left Extended (A) Full Gables (F) Full Modesty (FM)</b>							
	NSXCC284362(#)(X)	24x84x36x24x29	150/11.0	884	980	1,031	1,127
	NSXCC278362(#)(X)	24x78x36x24x29	140/10.0	853	961	1,001	1,148
	NSXCC272362(#)(X)	24x72x36x24x29	124/10.0	736	844	884	1,030
	NSXCC266362(#)(X)	24x66x36x24x29	120/9.0	710	807	857	1,004
	NSXCC260362(#)(X)	24x60x36x24x29	112/9.0	697	795	844	992
<i>Curve radius is 12" - see 12" Radius Curved Keyboard Platforms.</i>							

**Ordering Details:**

(#) - Specify style 'A' extended, or 'B' extended followed by:  
Gables - 'L' - left recessed; 'R' - right recessed, 'D' - double recessed or  
F' - 2 full gables.

(X) - Specify 'M1' for 1" LPL, 'M2' for 1-1/2" LPL,  
'H1' for 1-1/8" HPL, or 'H2' for 1-1/2" HPL. Woodgrain runs horizontally on top and  
modesty.

**Options:**

**Both Full Modesty Panels are available, add "FM" to part.**

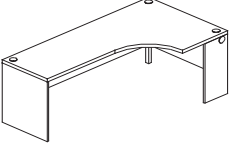
**Both 1/2 Modesty Panels (12") are available, add "TM" to part.**

**Both 1/4 Modesty Panels (7") are available, add "QM" to part. & 158.00 to price.**

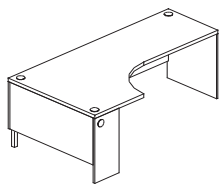
**Split Modesty panels, FM (\*) TM (\*) where (\*) is insert the length of the side  
required for FM or TM.**



# Extended Corner Tables

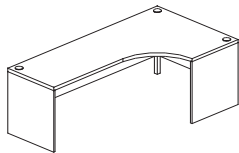
EXTENDED CORNER CURVED FRONT	Model	Size (GLWGH)	Wt./Cube (KD)	LPL		HPL		
				1"	1-1/2"	1-1/8"	1-1/2"	
<b>30" Deep Gables</b>								
	NSXCC384603(#)(X)	30x84x60x30x29	215/18.5	1,162	1,347	1,390	1,471	
	NSXCC378603(#)(X)	30x78x60x30x29	202/17.2	1,134	1,313	1,355	1,435	
	NSXCC372603(#)(X)	30x72x60x30x29	189/15.9	1,106	1,278	1,325	1,400	
	NSXCC366603(#)(X)	30x66x60x30x29	176/14.6	1,075	1,241	1,293	1,374	
	NSXCC360603(#)(X)	30x60x60x30x29	163/13.3	1,065	1,231	1,272	1,353	
<i>Curve Radius is 24" - see 24" Radius Curved Keyboard Platforms.</i>								

**Right Recessed Gable (R)  
3/4 Modesty**



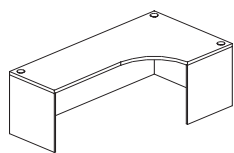
NSXCC384543(#)(X)	30x84x54x30x29	201/16.0	1,122	1,313	1,315	1,423		
NSXCC378543(#)(X)	30x78x54x30x29	188/15.0	1,089	1,266	1,264	1,383		
NSXCC372543(#)(X)	30x72x54x30x29	175/14.0	1,054	1,226	1,212	1,336		
NSXCC366543(#)(X)	30x66x54x30x29	162/12.0	1,017	1,183	1,158	1,299		
NSXCC360543(#)(X)	30x60x54x30x29	149/11.0	1,007	1,173	1,104	1,282		
<i>Curve Radius is 24" - see 24" Radius Curved Keyboard Platforms.</i>								

**Right Extended (B)  
Left Recessed Gable (L)  
3/4 Modesty**



NSXCC384483(#)(X)	30x84x48x30x29	187/14.0	1,079	1,263	1,277	1,377		
NSXCC378483(#)(X)	30x78x48x30x29	175/13.0	1,040	1,218	1,227	1,326		
NSXCC372483(#)(X)	30x72x48x30x29	163/12.0	1,001	1,173	1,179	1,269		
NSXCC366483(#)(X)	30x66x48x30x29	151/11.0	961	1,127	1,130	1,225		
NSXCC360483(#)(X)	30x60x48x30x29	139/11.0	938	1,104	1,076	1,199		
<i>Curve Radius is 18" - see 18" Radius Curved Keyboard Platforms.</i>								

**Left Extended (A)  
Full Gables (F)  
3/4 Modesty**



NSXCC384423(#)(X)	30x84x42x30x29	162/12.0	1,032	1,217	1,213	1,295		
NSXCC378423(#)(X)	30x78x42x30x29	152/11.0	994	1,173	1,175	1,256		
NSXCC372423(#)(X)	30x72x42x30x29	142/11.0	957	1,129	1,137	1,212		
NSXCC366423(#)(X)	30x66x42x30x29	132/10.0	918	1,084	1,098	1,180		
NSXCC360423(#)(X)	30x60x42x30x29	122/10.0	899	1,065	1,073	1,154		
<i>Curve radius is 12" - see 12" Radius Curved Keyboard Platforms.</i>								

**Left Extended (A)  
Full Gables (F)  
Full Modesty (FM)**

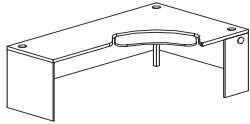
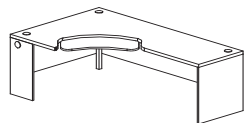
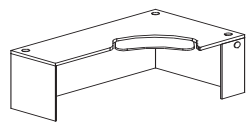
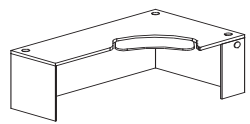
**Ordering Details:**

(#) - Specify style 'A' extended, or 'B' extended followed by:  
 Gables - 'L' - left recessed; 'R' - right recessed, 'D' - double recessed or  
 F' - 2 full gables.  
 (X) - Specify 'M1' for 1" LPL, 'M2' for 1-1/2" LPL,  
 'H1' for 1-1/8" HPL, or 'H2' for 1-1/2" HPL. Woodgrain runs horizontally on top and  
 modesty.

**Options:**

**Both Full Modesty Panels are available, add "FM" to part.**  
**Both 1/2 Modesty Panels (12") are available, add "TM" to part.**  
**Both 1/4 Modesty Panels (7") are available, add "QM" to part. & 158.00 to price.**  
**Split Modesty panels, FM (\*) TM (\*) where (\*) is insert the length of the side  
 required for FM or TM.**

# Extended Corner Tables

EXTENDED CORNER W/ KEYBOARD PLATFORM INSERT		Model	Size (GLWGH)	Wt./Cube (KD)	LPL		HPL	
24" Deep Gables					1"	1-1/2"	1-1/8"	1-1/2"
 <p><b>Left Extended (A)</b> <b>Right Recessed Gable (R)</b> <b>3/4 Modesty</b></p>	NSXK284602(#)(X)	24x84x60x24x29	205/18.5	1,422	1,607	1,650	1,730	
	NSXK278602(#)(X)	24x78x60x24x29	192/17.2	1,397	1,574	1,616	1,697	
	NSXK272602(#)(X)	24x72x60x24x29	179/15.9	1,370	1,542	1,589	1,664	
	NSXK266602(#)(X)	24x66x60x24x29	166/14.6	1,344	1,510	1,562	1,643	
	NSXK260602(#)(X)	24x60x60x24x29	153/13.3	1,325	1,491	1,532	1,614	
		<i>Curve radius is 24"</i>						
 <p><b>Right Extended (B)</b> <b>Left Recessed Gable (L)</b> <b>3/4 Modesty</b></p>	NSXK284542(#)(X)	24x84x54x24x29	191/16.0	1,382	1,558	1,601	1,682	
	NSXK278542(#)(X)	24x78x54x24x29	178/15.0	1,350	1,528	1,563	1,644	
	NSXK272542(#)(X)	24x72x54x24x29	165/14.0	1,319	1,491	1,513	1,600	
	NSXK266542(#)(X)	24x66x54x24x29	152/12.0	1,286	1,452	1,487	1,568	
	NSXK260542(#)(X)	24x60x54x24x29	145/11.0	1,267	1,433	1,462	1,542	
		<i>Curve radius is 24"</i>						
 <p><b>Left Extended (A)</b> <b>Right Recessed Gable (R)</b> <b>Full Modesty (FM)</b></p>	NSXK284482(#)(X)	24x84x48x24x29	177/14.0	1,343	1,528	1,544	1,640	
	NSXK278482(#)(X)	24x78x48x24x29	165/13.0	1,305	1,484	1,494	1,592	
	NSXK272482(#)(X)	24x72x48x24x29	153/12.0	1,267	1,440	1,447	1,536	
	NSXK266482(#)(X)	24x66x48x24x29	145/11.0	1,229	1,394	1,398	1,493	
	NSXK260482(#)(X)	24x60x48x24x29	135/11.0	1,210	1,376	1,350	1,471	
		<i>Curve radius is 24"</i>						
 <p><b>Left Extended (A)</b> <b>Right Recessed Gable (R)</b> <b>Full Modesty (FM)</b></p>	NSXK284422(#)(X)	24x84x42x24x29	152/12.0	1,261	1,445	1,427	1,523	
	NSXK278422(#)(X)	24x78x42x24x29	142/11.0	1,235	1,413	1,377	1,497	
	NSXK272422(#)(X)	24x72x42x24x29	132/11.0	1,210	1,382	1,327	1,465	
	NSXK266422(#)(X)	24x66x42x24x29	122/10.0	1,183	1,349	1,278	1,441	
	NSXK260422(#)(X)	24x60x42x24x29	115/10.0	1,163	1,329	1,227	1,420	
		<i>Curve radius is 18"</i>						

**KBW-L keyboard mechanism with KBCV platform is included in above pricing.**

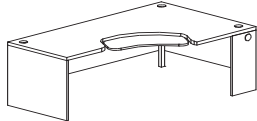
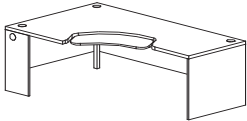
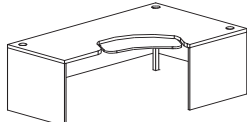
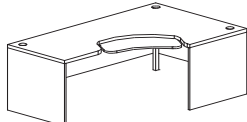
**Ordering Details:**

(#) - Specify style 'A' extended, or 'B' extended followed by:  
 Gables - 'L' - left recessed; 'R' - right recessed, 'D' - double recessed or  
 F' - 2 full gables.  
 (X) - Specify 'M1' for 1" LPL, 'M2' for 1-1/2" LPL,  
 'H1' for 1-1/8" HPL, or 'H2' for 1-1/2" HPL. Woodgrain runs horizontally on top and  
 modesty.

**Options:**

**Both Full Modesty Panels are available, add "FM" to part.**  
**Both 1/2 Modesty Panels (12") are available, add "TM" to part.**  
**Both 1/4 Modesty Panels (7") are available, add "QM" to part. & 158.00 to price.**  
**Split Modesty panels, FM (\*) TM (\*) where (\*) is insert the length of the side  
 required for FM or TM.**

# Extended Corner Tables

EXTENDED CORNER W/ KEYBOARD PLATFORM INSERT 30" Deep Gables	Model	Size (GLWGH)	Wt./Cube (KD)	LPL		HPL	
				1"	1-1/2"	1-1/8"	1-1/2"
 <p><b>Left Extended (A)</b> <b>Right Recessed Gable (R)</b> 3/4 Modesty</p>	NSXK384603(#)(X)	30x84x60x30x29	215/18.5	1,463	1,646	1,689	1,770
	NSXK378603(#)(X)	30x78x60x30x29	202/17.2	1,434	1,613	1,654	1,736
	NSXK372603(#)(X)	30x72x60x30x29	189/15.9	1,406	1,578	1,624	1,700
	NSXK366603(#)(X)	30x66x60x30x29	176/14.6	1,376	1,541	1,593	1,674
	NSXK360603(#)(X)	30x60x60x30x29	163/13.3	1,364	1,530	1,572	1,653
<i>Curve radius is 24"</i>							
 <p><b>Right Extended (B)</b> <b>Left Recessed Gable (L)</b> 3/4 Modesty</p>	NSXK384543(#)(X)	30x84x54x30x29	201/16.0	1,422	1,613	1,615	1,723
	NSXK378543(#)(X)	30x78x54x30x29	188/15.0	1,389	1,566	1,565	1,682
	NSXK372543(#)(X)	30x72x54x30x29	175/14.0	1,355	1,527	1,512	1,636
	NSXK366543(#)(X)	30x66x54x30x29	162/12.0	1,318	1,484	1,457	1,599
	NSXK360543(#)(X)	30x60x54x30x29	149/11.0	1,306	1,472	1,404	1,581
<i>Curve radius is 24"</i>							
 <p><b>Left Extended (A)</b> <b>Full Gables (F)</b> 3/4 Modesty</p>	NSXK384483(#)(X)	30x84x48x30x29	187/14.0	1,379	1,563	1,577	1,676
	NSXK378483(#)(X)	30x78x48x30x29	175/13.0	1,340	1,517	1,528	1,625
	NSXK372483(#)(X)	30x72x48x30x29	163/12.0	1,300	1,472	1,478	1,570
	NSXK366483(#)(X)	30x66x48x30x29	151/11.0	1,261	1,427	1,429	1,525
	NSXK360483(#)(X)	30x60x48x30x29	139/11.0	1,238	1,404	1,377	1,499
<i>Curve radius is 24"</i>							
 <p><b>Left Extended (A)</b> <b>Full Gables (F)</b> 3/4 Modesty</p>	NSXK384423(#)(X)	30x84x42x30x29	162/12.0	1,332	1,516	1,513	1,594
	NSXK378423(#)(X)	30x78x42x30x29	152/11.0	1,295	1,472	1,474	1,556
	NSXK372423(#)(X)	30x72x42x30x29	142/11.0	1,256	1,428	1,436	1,512
	NSXK366423(#)(X)	30x66x42x30x29	132/10.0	1,218	1,384	1,399	1,479
	NSXK360423(#)(X)	30x60x42x30x29	122/10.0	1,198	1,364	1,372	1,454
<i>Curve radius is 18"</i>							

**KBW-L keyboard mechanism with KBCV platform is included in above pricing.**

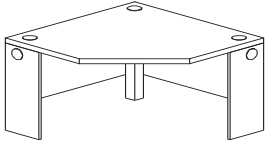
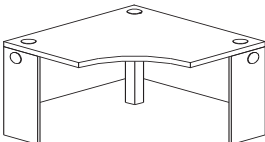
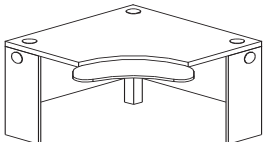
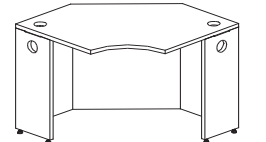
**Ordering Details:**

(#) - Specify style 'A' extended, or 'B' extended followed by:  
 Gables - 'L' - left recessed; 'R' - right recessed, 'D' - double recessed or  
 F' - 2 full gables.  
 (X) - Specify 'M1' for 1" LPL, 'M2' for 1-1/2" LPL,  
 'H1' for 1-1/8" HPL, or 'H2' for 1-1/2" HPL. Woodgrain runs horizontally on top and  
 modesty.

**Options:**

**Both Full Modesty Panels are available, add "FM" to part.**  
**Both 1/2 Modesty Panels (12") are available, add "TM" to part.**  
**Both 1/4 Modesty Panels (7") are available, add "QM" to part. & 158.00 to price.**  
**Split Modesty panels, FM (\*) TM (\*) where (\*) is insert the length of the side  
 required for FM or TM.**

# Corner Tables

CORNER TABLES SYMMETRICAL	Model	Size (GLWG)	(Angle) Radius	Wt./Cube (KD)	LPL		HPL	
					1"	1-1/2"	1-1/8"	1-1/2"
	NSCA483030(X)	30x48x48x30	(25)	96/3.8	680	732	827	916
	NSCA423030(X)	30x42x42x30	(17)	84/3.3	657	710	803	894
	NSCA482424(X)	24x48x48x24	(34)	96/3.8	680	732	827	916
	NSCA422424(X)	24x42x42x24	(25)	84/3.3	657	710	803	894
	NSCA362424(X)	24x36x36x24	(17)	67/3.3	517	549	664	734
	NSCA482020(X)	20x48x48x20	(39)	96/3.8	680	732	827	916
	NSCA422020(X)	20x42x42x20	(31)	84/3.3	657	710	803	894
	NSCA362020(X)	20x36x36x20	(22)	67/3.3	517	549	664	734
	NSCA481818(X)	18x48x48x18	(42)	96/3.8	680	732	827	916
	NSCA421818(X)	18x42x42x18	(34)	84/3.3	657	710	803	894
NSCA361818(X)	18x36x36x18	(25)	67/3.3	517	549	664	734	
	NSCC483030(X)	30x48x48x30	18	96/3.8	692	743	840	928
	NSCC423030(X)	30x42x42x30	12	84/3.3	670	721	815	906
	NSCC482424(X)	24x48x48x24	24	96/3.8	692	743	840	928
	NSCC422424(X)	24x42x42x24	18	84/3.3	670	721	815	906
	NSCC362424(X)	24x36x36x24	12	67/3.3	529	562	676	747
	NSCC482020(X)	20x48x48x20	18	96/3.8	692	743	840	928
	NSCC422020(X)	20x42x42x20	22	84/3.3	670	721	815	906
	NSCC362020(X)	20x36x36x20	16	67/3.3	529	562	676	747
	NSCC481818(X)	18x48x48x18	30	96/3.8	692	743	840	928
	NSCC421818(X)	18x42x42x18	24	84/3.3	670	721	815	906
NSCC361818(X)	18x36x36x18	18	67/3.3	529	562	676	747	
	NSCS483030(X)	30x48x48x30	18	162/3.8	1,668	1,720	1,817	1,905
	NSCS423030(X)	30x42x42x30	12	147/3.8	1,646	1,698	1,791	1,883
	NSCS482424(X)	24x48x48x24	24	144/3.3	1,668	1,720	1,817	1,905
	NSCS422424(X)	24x42x42x24	18	130/3.3	1,646	1,698	1,791	1,883
	NSCS362424(X)	24x36x36x24	12	112/3.3	1,506	1,538	1,653	1,723
	NSCS481818(X)	18x48x48x18	30	162/3.8	1,668	1,720	1,817	1,905
	NSCS421818(X)	18x42x42x18	24	147/3.8	1,646	1,698	1,791	1,883
	NSCS361818(X)	18x36x36x18	18	112/3.3	1,506	1,538	1,653	1,723

**Curved Front Corner Table**

**Curved Front Corner Table w/ Sit-Stand Platform**

The corner tables grouped immediately above are sold with the KBKW, sit-stand mechanism for effortless, one hand position control, and KBCV Keyboard Platform which accommodates keyboard and mouse. Keyboard radius is shown in column above. Straight front platform available (min. 25" to 36")- add SF to part number. Optional wrist rests are listed below. Range: 16" height adjustment, 9.5" above worksurface and 6.5" below worksurface 15 degrees positive or 15 degrees negative tilt.

**Notched Back Corner Table (shown with curved front, straight front available)**  
**Wrist Rest For KBCV Above**

For notched back corners on any of the above tables, add 'KR' to part number and \$315 to the list price.

WRKBCV18	for KBCV12, 15, 16, and 18	145	145
WRKBCV24	for KBCV24	155	155

Padded wrist rest available in black only. For straight front wrist rest see Accessories.

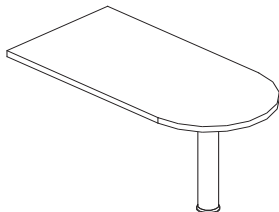
**Ordering Details:**

(X) - Specify 'M1' for 1" LPL, 'M2' for 1-1/2" LPL, 'H1' for 1-1/8" HPL, or 'H2' for 1-1/2" HPL. Woodgrain runs diagonally top, vertical on gables.

**Options:**

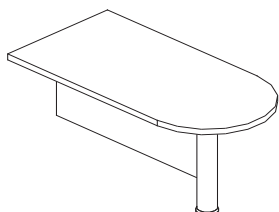
**Full Modesty Panels are available, add "FM" to part.**  
**1/2 Modesty Panels (12") are available, add "TM" to part.**  
**1/4 Modesty Panels (7") are available, add "QM" to part. & 158.00 to price.**

# Bullet Tables

BULLET SHAPED WORKSURFACES	Model	Size (WDH)	Wt./Cube (KD)	LPL		HPL	
				1"	1-1/2"	1-1/8"	1-1/2"
 <p><b>Bullet Worksurface with Column</b></p>	NSB8436(X)	84x36x29	95/11.0	606	712	729	852
	NSB8430(X)	84x30x29	89/11.0	547	705	670	793
	NSB7236(X)	72x36x29	90/11.0	545	643	668	791
	NSB7230(X)	72x30x29	85/11.0	520	660	643	765
	NSB7224(X)	72x24x29	80/11.0	453	608	621	738
	NSB6636(X)	66x36x29	87/10.0	508	618	631	754
	NSB6630(X)	66x30x29	82/10.0	483	606	606	729
	NSB6624(X)	66x24x29	79/10.0	402	551	600	726
	NSB6036(X)	60x36x29	85/9.0	483	587	593	725
	NSB6030(X)	60x30x29	80/9.0	471	579	594	717
	NSB6024(X)	60x24x29	78/9.0	397	532	520	698
	NSB5430(X)	54x30x29	72/8.0	404	540	527	650
	NSB5424(X)	54x24x29	69/8.0	392	526	515	637
	NSB4830(X)	48x30x29	68/6.0	397	532	520	643
	NSB4824(X)	48x24x29	60/6.0	365	501	488	611
	NSB4230(X)	42x30x29	65/4.0	358	494	481	604
	NSB4224(X)	42x24x29	58/4.0	352	487	475	597
	NSB3624(X)	36x24x29	55/4.0	347	482	469	592

*Includes 5" diameter **black** steel column leg. Available in silver. Specify in item description.*

**3/4 Modesty Panel Recessed on approach side.**



NSBWMP96(**)	84x20	55/1.0	197
NSBWMP84(**)	72x20	49/1.0	191
NSBWMP78(**)	66x20	45/1.0	185
NSBWMP72(**)	60x20	40/1.0	179
NSBWMP66(**)	54x20	38/1.0	172
NSBWMP60(**)	48x20	35/1.0	166
NSBWMP54(**)	42x20	28/1.0	161
NSBWMP48(**)	36x20	25/1.0	154
NSBWMP42(**)	30x20	22/1.0	148
NSBWMP36(**)	24x20	15/1.0	142

**(\*\*) - Modesty Panel options:**

3/4 Modesty Panels are standard.

Full Modesty Panels are available, add "FM" to part.

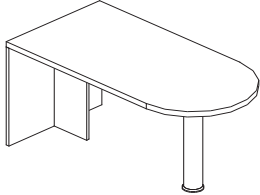
1/2 Modesty Panels (12") are available, add "TM" to part.

1/4 Modesty Panels (7") are available, add "QM" to part. & 158.00 to price.

**Ordering Details:**

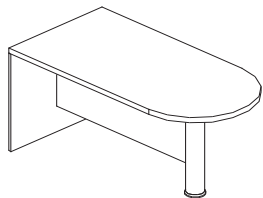
(X) - Specify 'M1' for 1" LPL, 'M2' for 1-1/2" LPL, 'H1' for 1-1/8" HPL, or 'H2' for 1-1/2" HPL.

# Bullet Tables

BULLET SHAPED WORKSURFACES	Model	Size (WDH)	Wt./Cube (KD)	LPL		HPL	
				1"	1-1/2"	1-1/8"	1-1/2"
 <p><b>Bullet Worksurface with Column &amp; T-Gable Free-Standing</b></p>	NSBT9636(X)	96x36x29	160/12.0	795	865	943	1,014
	NSBT9630(X)	96x30x29	157/12.0	769	820	915	982
	NSBT8436(X)	84x36x29	154/11.0	672	742	820	891
	NSBT8430(X)	84x30x29	149/11.0	646	697	792	859
	NSBT7836(X)	78x36x29	145/11.0	656	727	804	874
	NSBT7830(X)	78x30x29	140/11.0	628	693	776	851
	NSBT7236(X)	72x36x29	133/11.0	639	697	786	857
	NSBT7230(X)	72x30x29	125/11.0	611	690	758	844
	NSBT7224(X)	72x24x29	120/11.0	595	663	742	811
	NSBT6636(X)	66x36x29	127/10.0	626	697	754	820
	NSBT6630(X)	66x30x29	123/10.0	604	685	726	833
	NSBT6624(X)	66x24x29	118/10.0	574	656	683	777
	NSBT6036(X)	60x36x29	125/9.0	613	685	729	807
	NSBT6030(X)	60x30x29	122/9.0	578	663	700	803
	NSBT6024(X)	60x24x29	116/9.0	551	599	614	721
	NSBT5430(X)	54x30x29	118/8.0	567	609	623	756
	NSBT5424(X)	54x24x29	115/8.0	541	583	609	689
	NSBT4830(X)	48x30x29	116/6.0	525	575	604	681
	NSBT4824(X)	48x24x29	113/6.0	499	551	588	656
	NSBT4230(X)	42x30x29	112/5.0	515	562	604	651
NSBT4224(X)	42x24x29	109/5.0	488	541	589	635	
NSBT3624(X)	36x24x29	105/5.0	473	525	593	630	

*Includes 5" diameter **black** steel column leg. Available in silver. Specify in item description.*

**3/4 Modesty Panel Recessed on approach side.**



NSBTMP96(**)	84x20	55/1.0	197
NSBTMP84(**)	72x20	49/1.0	191
NSBTMP78(**)	66x20	45/1.0	185
NSBTMP72(**)	60x20	40/1.0	179
NSBTMP66(**)	54x20	38/1.0	172
NSBTMP60(**)	48x20	35/1.0	166
NSBTMP54(**)	42x20	28/1.0	161
NSBTMP48(**)	36x20	25/1.0	154
NSBTMP42(**)	30x20	22/1.0	148
NSBTMP36(**)	24x20	15/1.0	142

**(\*\*) - Modesty Panel options:**

3/4 Modesty Panels are standard.

Full Modesty Panels are available, add "FM" to part.

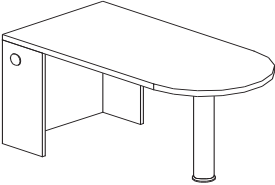
1/2 Modesty Panels (12") are available, add "TM" to part.

1/4 Modesty Panels (7") are available, add "QM" to part. & 158.00 to price.

**Ordering Details:**

(X) - Specify 'M1' for 1" LPL, 'M2' for 1-1/2" LPL, 'H1' for 1-1/8" HPL, or 'H2' for 1-1/2" HPL.

# Bullet Tables

BULLET SHAPED WORKSURFACES	Model	Size (WDH)	Wt./Cube (KD)	LPL		HPL	
				1"	1-1/2"	1-1/8"	1-1/2"
	NSBC9636CG(X)	96x36x29	160/12.0	795	865	943	1,014
	NSBC9630CG(X)	96x30x29	157/12.0	769	820	915	982
	NSBC8436CG(X)	84x36x29	154/11.0	672	742	820	891
	NSBC8430CG(X)	84x30x29	149/11.0	646	697	792	859
	NSBC7836CG(X)	78x36x29	145/11.0	656	727	804	874
	NSBC7830CG(X)	78x30x29	140/11.0	628	693	776	851
	NSBC7236CG(X)	72x36x29	133/11.0	639	697	786	857
	NSBC7230CG(X)	72x30x29	125/11.0	611	690	758	844
	NSBC7224CG(X)	72x24x29	120/11.0	595	663	742	811
	NSBC6636CG(X)	66x36x29	127/10.0	626	697	754	820
<b>Bullet Worksurface with Column &amp; C-Gable Free-Standing</b>  <b>Can be used with posts or post mounted storage</b>	NSBC6630CG(X)	66x30x29	123/10.0	604	685	726	833
	NSBC6624CG(X)	66x24x29	118/10.0	574	656	683	777
	NSBC6036CG(X)	60x36x29	125/9.0	613	685	729	807
	NSBC6030CG(X)	60x30x29	122/9.0	578	663	700	803
	NSBC6024CG(X)	60x24x29	116/9.0	551	599	614	721
	NSBC5430CG(X)	54x30x29	118/8.0	567	609	623	756
	NSBC5424CG(X)	54x24x29	115/8.0	541	583	609	689
	NSBC4830CG(X)	48x30x29	116/6.0	525	575	604	681
	NSBC4824CG(X)	48x24x29	113/6.0	499	551	588	656
	NSBC4230CG(X)	42x30x29	112/5.0	515	562	604	651
NSBC4224CG(X)	42x24x29	109/5.0	488	541	589	635	
NSBC3624CG(X)	36x24x29	105/5.0	473	525	593	630	

*Includes 5" diameter **black** steel column leg. Available in silver. Specify in item description.*

**Ordering Details:**

(X) - Specify 'M1' for 1" LPL, 'M2' for 1-1/2" LPL, 'H1' for 1-1/8" HPL, or 'H2' for 1-1/2" HPL.

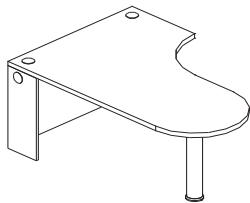
**Full Modesty Panels are available, add "FM" to part.  
1/2 Modesty Panels (12") are available, add "TM" to part.**

Custom size tables are available. Please call for details and pricing.

# Extended Bullet Tables

EXTENDED CORNER BULLET WORKSURFACES NO MODESTY PANEL	Model	Size (GWL B)	Wt./Cube (KD)	LPL		HPL	
				1"	1-1/2"	1-1/8"	1-1/2"

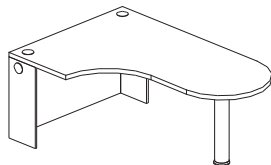
**30" deep at connection position.**



**Left Extended  
Bullet Worksurface  
No Modesty  
Approach Side**

NSEBN(#)	845430(X)	30x54x84x30	201/16.0	1,065	1,250	1,093	1,334
NSEBN(#)	785430(X)	30x54x78x30	189/15.0	966	1,152	994	1,235
NSEBN(#)	725430(X)	30x54x72x30	177/14.0	933	1,130	970	1,204
NSEBN(#)	665430(X)	30x54x66x30	164/12.0	910	1,095	941	1,174
NSEBN(#)	605430(X)	30x54x60x30	155/11.0	886	1,071	916	1,149
<i>Curve Radius is 24"</i>							
NSEBN(#)	844830(X)	30x48x84x30	189/14.0	1,031	1,216	1,056	1,296
NSEBN(#)	784830(X)	30x48x78x30	176/13.0	933	1,117	958	1,197
NSEBN(#)	724830(X)	30x48x72x30	165/12.0	906	1,090	935	1,170
NSEBN(#)	664830(X)	30x48x66x30	153/11.0	880	1,065	910	1,140
NSEBN(#)	604830(X)	30x48x60x30	149/10.0	857	1,040	886	1,116
<i>Curve Radius is 18"</i>							
<i>Includes 5" diameter <b>black</b> steel column leg. Available in silver. Specify in item description.</i>							

**24" deep at connection position.**



**Right Extended  
Bullet Worksurface  
No Modesty  
Approach Side**

NSEBN(#)	845424(X)	24x54x84x30	190/16.0	1,041	1,248	1,057	1,300
NSEBN(#)	785424(X)	24x54x78x30	183/15.0	943	1,151	959	1,202
NSEBN(#)	725424(X)	24x54x72x30	170/14.0	926	1,122	930	1,183
NSEBN(#)	665424(X)	24x54x66x30	157/12.0	908	1,106	900	1,168
NSEBN(#)	605424(X)	24x54x60x30	149/11.0	884	1,082	876	1,143
<i>Curve Radius is 24"</i>							
NSEBN(#)	844824(X)	24x48x84x30	179/14.0	1,019	1,191	1,049	1,283
NSEBN(#)	784824(X)	24x48x78x30	168/13.0	921	1,093	950	1,184
NSEBN(#)	724824(X)	24x48x72x30	157/12.0	881	1,066	921	1,148
NSEBN(#)	664824(X)	24x48x66x30	146/11.0	843	1,028	888	1,103
NSEBN(#)	604824(X)	24x48x60x30	135/10.0	806	991	860	1,065
<i>Curve Radius is 18"</i>							
NSEBN(#)	844224(X)	24x42x84x30	179/14.0	1,019	1,191	1,049	1,283
NSEBN(#)	784224(X)	24x42x78x30	168/13.0	921	1,093	950	1,184
NSEBN(#)	724224(X)	24x42x72x30	157/12.0	881	1,066	921	1,148
NSEBN(#)	664224(X)	24x42x66x30	146/11.0	843	1,028	888	1,103
NSEBN(#)	604224(X)	24x42x60x30	135/10.0	806	991	860	1,065
<i>Curve Radius is 12"</i>							

*Includes 5" diameter **black** steel column leg. Available in silver. Specify in item description.*

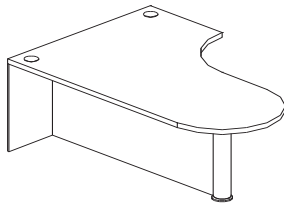
**Ordering Details:** (#) - Specify (L) left or (R) right extended bullet worksurface.  
 (X) - Specify 'M1' for 1" LPL, 'M2' for 1-1/2" LPL,  
 'H1' for 1-1/8" HPL, or 'H2' for 1-1/2" HPL. Woodgrain runs horizontally on top.



# Extended Bullet Tables

EXTENDED CORNER BULLET WORKSURFACES WITH MODESTY PANEL	Model	Size (GWL B)	Wt./Cube (KD)	LPL		HPL	
				1"	1-1/2"	1-1/8"	1-1/2"

**30" deep at connection position.**



**Left Extended  
Bullet Worksurface  
Modesty Approach Side  
Full Modesty Standard**

NSEB(#)	845430(X)	30x54x84x30	201/16.0	1,261	1,447	1,289	1,530
NSEB(#)	785430(X)	30x54x78x30	189/15.0	1,162	1,348	1,191	1,432
NSEB(#)	725430(X)	30x54x72x30	177/14.0	1,130	1,326	1,167	1,401
NSEB(#)	665430(X)	30x54x66x30	164/12.0	1,108	1,292	1,137	1,370
NSEB(#)	605430(X)	30x54x60x30	155/11.0	1,083	1,267	1,112	1,346

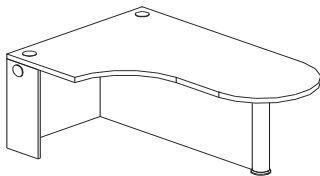
*Curve Radius is 24"*

NSEB(#)	844830(X)	30x48x84x30	189/14.0	1,227	1,412	1,253	1,492
NSEB(#)	784830(X)	30x48x78x30	176/13.0	1,130	1,314	1,154	1,393
NSEB(#)	724830(X)	30x48x72x30	165/12.0	1,103	1,286	1,131	1,367
NSEB(#)	664830(X)	30x48x66x30	153/11.0	1,076	1,261	1,108	1,337
NSEB(#)	604830(X)	30x48x60x30	149/10.0	1,053	1,237	1,083	1,313

*Curve Radius is 18"*

*Includes 5" diameter **black** steel column leg. Available in silver. Specify in item description.*

**24" deep at connection position**



**Right Extended  
Bullet Worksurface  
Modesty Approach Side  
Full Modesty Standard**

NSEB(#)	845424(X)	24x54x84x30	190/16.0	1,238	1,445	1,254	1,497
NSEB(#)	785424(X)	24x54x78x30	183/15.0	1,139	1,347	1,155	1,399
NSEB(#)	725424(X)	24x54x72x30	170/14.0	1,122	1,319	1,127	1,380
NSEB(#)	665424(X)	24x54x66x30	157/12.0	1,105	1,303	1,096	1,364
NSEB(#)	605424(X)	24x54x60x30	149/11.0	1,080	1,278	1,072	1,340

*Curve Radius is 24"*

NSEB(#)	844824(X)	24x48x84x30	179/14.0	1,216	1,387	1,245	1,479
NSEB(#)	784824(X)	24x48x78x30	168/13.0	1,117	1,289	1,147	1,382
NSEB(#)	724824(X)	24x48x72x30	157/12.0	1,078	1,262	1,117	1,344
NSEB(#)	664824(X)	24x48x66x30	146/11.0	1,040	1,224	1,086	1,299
NSEB(#)	604824(X)	24x48x60x30	135/10.0	1,003	1,188	1,057	1,261

*Curve Radius is 18"*

NSEB(#)	844224(X)	24x42x84x30	179/14.0	1,216	1,387	1,245	1,479
NSEB(#)	784224(X)	24x42x78x30	168/13.0	1,117	1,289	1,147	1,382
NSEB(#)	724224(X)	24x42x72x30	157/12.0	1,078	1,262	1,117	1,344
NSEB(#)	664224(X)	24x42x66x30	146/11.0	1,040	1,224	1,086	1,299
NSEB(#)	604224(X)	24x42x60x30	135/10.0	1,003	1,188	1,057	1,261

*Curve Radius is 12"*

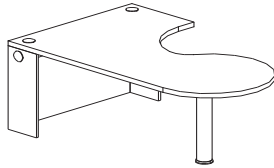
*Includes 5" diameter **black** steel column leg. Available in silver. Specify in item description.*

**Ordering Details:**

- (#) - Specify (L) left or (R) right extended bullet worksurface.
- (X) - Specify 'M1' for 1" LPL, 'M2' for 1-1/2" LPL, 'H1' for 1-1/8" HPL, or 'H2' for 1-1/2" HPL. Woodgrain runs horizontally on top.
- 3/4 Modesty Panels (20") are available, add "TQM" to part.**
- 1/2 Modesty Panels (12") are available, add "TM" to part.**

# Extended P Tables

INSIDE "P" SHAPED WORKSURFACES	Model	Size (LWDP)	Wt./Cube (KD)	LPL		HPL	
				1"	1-1/2"	1-1/8"	1-1/2"



**30" deep at connection position and neck of "P"**

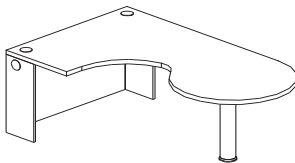
NSEIPN(#)	845430(X)	84x54x30x36	201/16.0	1,065	1,250	1,127	1,334
NSEIPN(#)	785430(X)	78x54x30x36	189/15.0	966	1,152	1,029	1,235

*Curve Radius is 24" - see 24" Radius Curved Keyboard Platforms.*

**Left Extended Inside  
"P" Worksurface  
No Modesty  
Approach Side**

NSEIPN(#)	844830(X)	80x48x30x36	189/14.0	1,031	1,216	1,093	1,296
NSEIPN(#)	784830(X)	78x48x30x36	176/13.0	933	1,117	994	1,197

*Curve Radius is 18" - see 18" Radius Curved Keyboard Platforms.  
Includes 5" diameter **black** steel column leg. Available in silver.  
Specify in item description.*



**24" deep at connection position and neck of "P"**

NSEIPN(#)	845424(X)	84x54x24x30	190/14.0	1,041	1,248	1,126	1,300
NSEIPN(#)	785424(X)	78x54x24x30	183/13.0	943	1,151	1,028	1,202

*Curve Radius is 24" - see 24" Radius Curved Keyboard Platforms.*

**Right Extended Inside  
"P" Worksurface  
No Modesty  
Approach Side**

NSEIPN(#)	844824(X)	84x48x24x30	179/14.0	1,019	1,191	1,080	1,283
NSEIPN(#)	784824(X)	78x48x24x30	168/13.0	921	1,093	982	1,184

*Curve Radius is 24" - see 24" Radius Curved Keyboard Platforms.  
Includes 5" diameter **black** steel column leg. Available in silver.  
Specify in item description.*

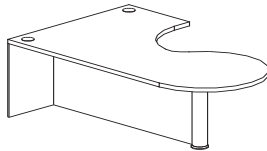
**Ordering Details:**

(#) - Specify (L) left extended or (R) right extended.  
 (X) - Specify 'M1' for 1" LPL, 'M2' for 1-1/2" LPL,  
 'H1' for 1-1/8" HPL, or 'H2' for 1-1/2" HPL. Woodgrain runs horizontally on top.

# Extended P Tables

INSIDE "P" SHAPED WORKSURFACES	Model	Size (LWDP)	Wt./Cube (KD)	LPL		HPL	
				1"	1-1/2"	1-1/8"	1-1/2"

**30" deep at connection position and neck of "P"**



**Left Extended Inside "P" Worksurface Full Modesty Standard**

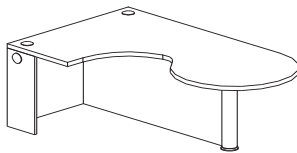
NSEIP(#)	845430(X)	84x54x30x36	201/16.0	1,261	1,447	1,324	1,530
NSEIP(#)	785430(X)	78x54x30x36	189/15.0	1,162	1,348	1,225	1,432

*Curve Radius is 24" - see 24" Radius Curved Keyboard Platforms.*

NSEIP(#)	844830(X)	80x48x30x36	189/14.0	1,227	1,412	1,289	1,492
NSEIP(#)	784830(X)	78x48x30x36	176/13.0	1,130	1,314	1,191	1,393

*Curve Radius is 18" - see 18" Radius Curved Keyboard Platforms. Includes 5" diameter **black** steel column leg. Available in silver. Specify in item description.*

**24" deep at connection position and neck of "P"**



**Right Extended Inside "P" Worksurface Full Modesty Standard**

NSEIP(#)	845424(X)	84x54x24x30	190/14.0	1,238	1,445	1,322	1,497
NSEIP(#)	785424(X)	78x54x24x30	183/13.0	1,139	1,347	1,224	1,399

*Curve Radius is 24" - see 24" Radius Curved Keyboard Platforms.*

NSEIP(#)	844824(X)	84x48x24x30	179/14.0	1,216	1,387	1,277	1,479
NSEIP(#)	784824(X)	78x48x24x30	168/13.0	1,117	1,289	1,179	1,382

*Curve Radius is 24" - see 24" Radius Curved Keyboard Platforms. Includes 5" diameter **black** steel column leg. Available in silver. Specify in item description.*

**Ordering Details:**

(#) - Specify (L) left extended or (R) right extended.  
 (X) - Specify 'M1' for 1" LPL, 'M2' for 1-1/2" LPL, 'H1' for 1-1/8" HPL, or 'H2' for 1-1/2" HPL. Woodgrain runs horizontally on top and modesty.

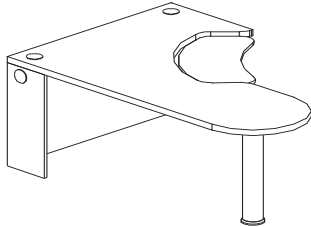
**Options:**

**3/4 Modesty Panels (20") are available, add "TQM" to part.**  
**1/2 Modesty Panels (12") are available, add "TM" to part.**

# Extended P Tables

EXTENDED CORNER P- WORKSURFACES w/KEYBOARD INSERT	Model	Size (GWLP)	Wt./Cube (KD)	LPL		HPL	
				1"	1-1/2"	1-1/8"	1-1/2"

**30" deep at connection position.**



**Left Extended  
Inside P-Worksurface  
No Modesty Approach Side  
w/Keyboard Insert**

NSEIPKN(#)	845430(X)	30x54x84x30	201/16.0	1,364	1,550	1,427	1,633
NSEIPKN(#)	785430(X)	30x54x78x30	189/15.0	1,266	1,451	1,328	1,535
NSEIPKN(#)	725430(X)	30x54x72x30	177/14.0	1,233	1,429	1,306	1,505
NSEIPKN(#)	665430(X)	30x54x66x30	164/12.0	1,211	1,394	1,272	1,473

*Includes 5" diameter **black** steel column leg. Available in silver.  
Specify in item description.*

NSEIPKN(#)	844830(X)	30x48x84x30	189/14.0	1,331	1,515	1,392	1,595
NSEIPKN(#)	784830(X)	30x48x78x30	176/13.0	1,233	1,418	1,295	1,497
NSEIPKN(#)	724830(X)	30x48x72x30	165/12.0	1,205	1,390	1,267	1,470
NSEIPKN(#)	664830(X)	30x48x66x30	153/11.0	1,180	1,364	1,241	1,441

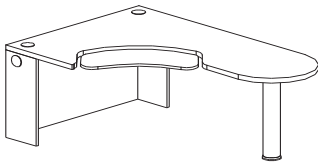
*Includes 5" diameter **black** steel column leg. Available in silver.  
Specify in item description.*

**Keyboard Mechanism KBW-L and Keyboard Platform KBCV are included in all models on this page.**

**For straight front keyboards add "SF" to code.**

**Optional WRKBCV curved wrist rests available.**

**24" deep at connection position.**



**Right Extended  
Inside P-Worksurface  
No Modesty Approach Side  
w/Keyboard Insert**

NSEIPKN(#)	845424(X)	24x54x84x30	190/16.0	1,341	1,549	1,426	1,600
NSEIPKN(#)	785424(X)	24x54x78x30	183/15.0	1,242	1,450	1,327	1,502
NSEIPKN(#)	725424(X)	24x54x72x30	170/14.0	1,225	1,422	1,299	1,484
NSEIPKN(#)	665424(X)	24x54x66x30	157/12.0	1,209	1,392	1,269	1,441

*Includes 5" diameter **black** steel column leg. Available in silver.  
Specify in item description.*

NSEIPKN(#)	844824(X)	24x48x84x30	179/14.0	1,319	1,491	1,380	1,582
NSEIPKN(#)	784824(X)	24x48x78x30	168/13.0	1,220	1,392	1,282	1,485
NSEIPKN(#)	724824(X)	24x48x72x30	157/12.0	1,181	1,365	1,242	1,448
NSEIPKN(#)	664824(X)	24x48x66x30	146/11.0	1,143	1,327	1,204	1,402

*Includes 5" diameter **black** steel column leg. Available in silver.  
Specify in item description.*

**Keyboard Mechanism KBW-L and Keyboard Platform KBCV are included in all models on this page.**

**For straight front keyboards add "SF" to code.**

**Ordering Details:**

(#) - Specify (L) left or (R) right extended bullet worksurface.

(X) - Specify 'M1' for 1" LPL, 'M2' for 1-1/2" LPL,

'H1' for 1-1/8" HPL, or 'H2' for 1-1/2" HPL. Woodgrain runs horizontally on top.

**Options:**

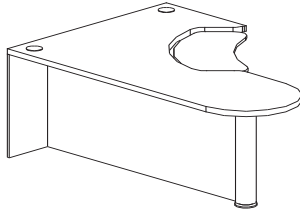
**3/4 Modesty Panels (20") are available, add "TQM" to part.**

**1/2 Modesty Panels (12") are available, add "TM" to part.**

# Extended P Tables

EXTENDED CORNER P- WORKSURFACES w/KEYBOARD INSERT	Model	Size (GWLP)	Wt./Cube (KD)	LPL		HPL	
				1"	1-1/2"	1-1/8"	1-1/2"

**30" deep at connection position.**



NSEIPK(#)845430(X)	30x54x84x30	201/16.0	1,560	1,746	1,623	1,830
NSEIPK(#)785430(X)	30x54x78x30	189/15.0	1,463	1,647	1,525	1,731
NSEIPK(#)725430(X)	30x54x72x30	177/14.0	1,429	1,625	1,503	1,701
NSEIPK(#)665430(X)	30x54x66x30	164/12.0	1,407	1,592	1,469	1,671

*Includes 5" diameter **black** steel column leg. Available in silver. Specify in item description.*

**Left Extended  
Inside P-Worksurface  
w/Modesty Approach Side  
Full Modesty Standard  
w/Keyboard Insert**

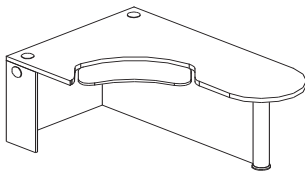
NSEIPK(#)844830(X)	30x48x84x30	189/14.0	1,528	1,712	1,589	1,791
NSEIPK(#)784830(X)	30x48x78x30	176/13.0	1,429	1,614	1,491	1,694
NSEIPK(#)724830(X)	30x48x72x30	165/12.0	1,402	1,587	1,464	1,666
NSEIPK(#)664830(X)	30x48x66x30	153/11.0	1,377	1,560	1,437	1,637

*Includes 5" diameter **black** steel column leg. Available in silver. Specify in item description.*

**Keyboard Mechanism KBW-L and Keyboard Platform KBCV are included in all models on this page.**

**Optional WRKBCV curved wrist rests available.**

**24" deep at connection position**



NSEIPK(#)845424(X)	24x54x84x30	190/16.0	1,537	1,745	1,622	1,797
NSEIPK(#)785424(X)	24x54x78x30	183/15.0	1,440	1,646	1,524	1,698
NSEIPK(#)725424(X)	24x54x72x30	170/14.0	1,422	1,618	1,495	1,680
NSEIPK(#)665424(X)	24x54x66x30	157/12.0	1,405	1,589	1,466	1,637

*Includes 5" diameter **black** steel column leg. Available in silver. Specify in item description.*

**Right Extended  
Inside P-Worksurface  
w/Modesty Approach Side  
Full Modesty Standard  
w/Keyboard Insert**

NSEIPK(#)844824(X)	24x48x84x30	179/14.0	1,515	1,687	1,577	1,780
NSEIPK(#)784824(X)	24x48x78x30	168/13.0	1,418	1,589	1,478	1,681
NSEIPK(#)724824(X)	24x48x72x30	157/12.0	1,378	1,562	1,440	1,644
NSEIPK(#)664824(X)	24x48x66x30	146/11.0	1,340	1,524	1,401	1,599

*Includes 5" diameter **black** steel column leg. Available in silver. Specify in item description.*

**Keyboard Mechanism KBW-L and Keyboard Platform KBCV are included in all models on this page.**

**For straight front keyboards add "SF" to code.**

**Ordering Details:**

(#) - Specify (L) left or (R) right extended bullet worksurface.  
 (X) - Specify 'M1' for 1" LPL, 'M2' for 1-1/2" LPL,  
 'H1' for 1-1/8" HPL, or 'H2' for 1-1/2" HPL. Woodgrain runs horizontally on top and modesty.

**Options:**

**3/4 Modesty Panels (20") are available, add "TQM" to part.**  
**1/2 Modesty Panels (12") are available, add "TM" to part.**

# Modular Component Specifications

1. 2 Box 1 file floor pedestal, 12/12 with lock, 18.75", 22", or 28" deep.
2. 2 file floor pedestal, 12/12 with lock, 18.75", 22", or 28" deep.
3. Lateral file (2 drawers) with lock, 18.75", 22", or 28" deep and 30", 36", or 42" wide.
4. Storage cabinet with lock, 18.75" or 22" deep and 18.75", 24", 30" and 36" wide.
5. Personal pedestal 2 box, 1 file, 1 lateral drawer with lock, 18.75" or 22" deep, 30" or 36" wide.
6. Personal combo 2 box, 1 file, 1 cabinet with lock, 18.75" or 22" deep, 30" or 36" wide
7. Box file mobile pedestal with lock, 18.75" 22", or 28" deep.
8. 3 box mobile pedestal, no lock, 18.75", 22" or 28" deep.
9. 2 box file mobile pedestal with lock, 18.75", 22" or 28" deep.
10. 2 file mobile pedestal with lock, 18.75", 22" or 28" deep.
11. Pencil box file mobile with lock, 18.75", 22" or 28" deep.

**Key alike:**

To specify key cores, you may select any key number from 500-509 and 551-700. You must indicate on your order the quantity of each key number needed.

**Notes:**

All drawers have 100lb. rated, steel ball bearing sliders. All lateral file drawers have 150lb. rated sliders. All mobile pedestals are equipped with a fifth caster to prevent overbalancing.

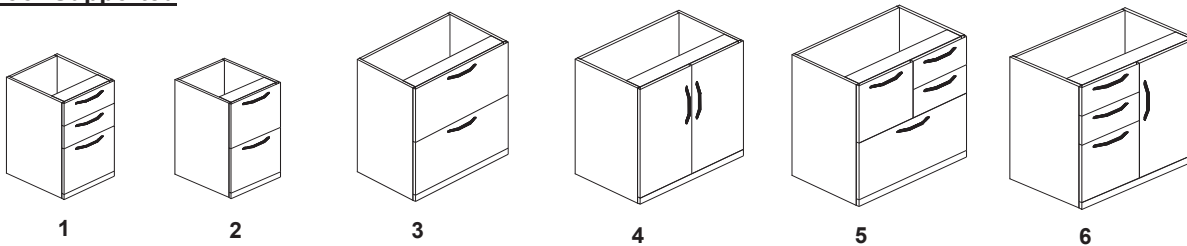
One pencil tray is included in every pedestal with a box drawer.

All lateral file drawers accommodate letter and legal size files front to back or side to side. All pedestal file drawers accommodate legal size files side to side only and letter front to back or side to side.

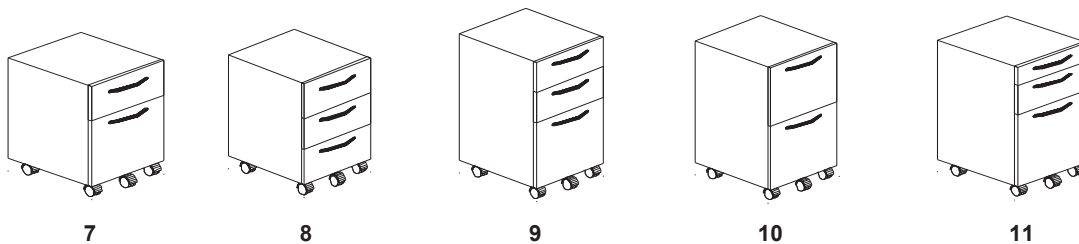
Modular component worksurfaces are available in widths to accommodate all combinations. Constructed of 3/4" LPL with optional HPL doors and tops. Shipped assembled. Drawer pulls are standard on all drawers.

Locks are standard on all pedestals and cabinets.

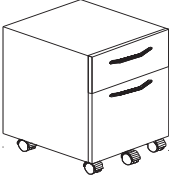

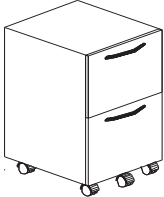
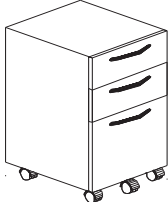
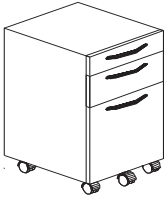
**Floor Supported**



**Mobile Pedestals**



# Mobile Pedestals

MOBILE PEDESTALS	Model	Size (WDH)	Wt./Cube (KD)	Price	H/P Drawer Front
<b>Box, File</b>	 MP1B1F18(#)	15.5x18.75x22	55/6.7	560	121
	MP1B1F22(#)	15.5x22x22	70/6.7	609	121
	MP1B1F28(#)	15.5x28x22	80/6.7	659	121
<b>3 Box</b>	 MP3B18(#)	15.5x18.75x22	85/6.7	572	121
	MP3B22(#)	15.5x22x22	90/6.7	623	121
	MP3B28(#)	15.5x28x22	100/6.7	671	121
<b>2 File</b>	 MP2F18(#)	15.5x18.75x22	75/6.7	614	121
	MP2F22(#)	15.5x22x27	90/6.7	665	121
	MP2F28(#)	15.5x28x27	110/6.7	714	121
<b>2 Box, 1 File</b>	 MP2B1F18(#)	15.5x18.75x22	85/6.7	646	121
	MP2B1F22(#)	15.5x22x27	100/6.7	678	121
	MP2B1F28(#)	15.5x28x27	110/6.7	750	121
<b>1 Pencil, 1 Box, 1 File</b>	 MP1PBF18(#)	15.5x18.75x22	85/6.7	646	121
	MP1PBF22(#)	15.5x22x27	100/6.7	700	121
	MP1PBF28(#)	15.5x28x27	110/6.7	750	121

\* Note: Pencil drawer is non-locking

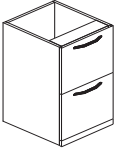

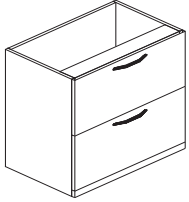
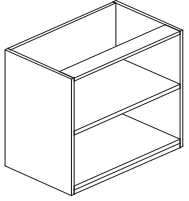
**Notes:**

1. Locks included.
2. All mobile storage units listed above will fit under Natural Series 20", 24" and 30" deep; 29" high fixed height tables. MP1B1F and MP3B will also fit under 26" tables.
3. All lateral file drawers accommodate letter and legal size files front to back or side to side. All pedestal file drawers accommodate legal size files side to side only and letter front to back or side to side.
4. One pencil tray is included with each box drawer pedestal.
5. All mobile pedestals are provided with a fifth caster to prevent overbalancing.
6. Seat cushions are available for above peds. Only MP1B1F and MP3B models with cushion fit under desks.

**Ordering Details:**

(#) - Specify 'H' for HPL drawer fronts, and add charge in right column. For seat cushions add CU to part number and \$294.00 to list price.

# Freestanding Storage

PEDESTALS & LATS FREESTANDING	Model	Size (WDH)	Wt./Cube (KD)	Price	H/P Drawer Front
	FSPED2F30(#)(*)(~)	15.5x28x28	115/6.7	653	121
	FSPED2F24(#)(*)(~)	15.5x22x28	90/6.7	610	121
	FSPED2F20(#)(*)(~)	15.5x18.75x28	75/6.7	610	121
	<i>Additional tops available to increase height to desk height, see notes below.</i>				
<b>2 File</b>					
	FSPED2B1F30(#)(*)(~)	15.5x28x28	105/6.7	711	121
	FSPED2B1F24(#)(*)(~)	15.5x22x28	100/6.7	689	121
	FSPED2B1F20(#)(*)(~)	15.5x18.75x28	85/6.7	648	121
	<i>Additional tops available to increase height to desk height, see notes below.</i>				
<b>2 Box, 1 File</b>					
	FSLAT4230(#)(*)(~)	42x28x28	145/25.3	1,100	154
	FSLAT4224(#)(*)(~)	42x22x28	140/20.5	1,156	154
	FSLAT4220(#)(*)(~)	42x18.75x28	135/17.4	1,070	154
	FSLAT3630(#)(*)(~)	36x28x28	125/21.1	811	154
	FSLAT3624(#)(*)(~)	36x22x28	120/17.2	754	154
	FSLAT3620(#)(*)(~)	36x18.75x28	115/14.0	722	154
	FSLAT3030(#)(*)(~)	30x28x28	125/17.8	769	154
	FSLAT3024(#)(*)(~)	30x22x28	115/14.0	722	154
	FSLAT3020(#)(*)(~)	30x18.75x28	95/12.6	698	154
	FSLAT2430(#)(*)(~)	24x28x28	115/16.8	742	154
	FSLAT2424(#)(*)(~)	24x22x28	105/13.0	696	154
	FSLAT2420(#)(*)(~)	24x18.75x28	85/11.6	672	154
<b>2 Drawer Lateral</b>					
<i>Lateral file interlock (anti-tilt) allows only one drawer to open at a time. Pedestal and lateral units are designed to support a worksurface in place of an end support gable. They are fastened to the underside of the worksurface and can be easily relocated for system reconfiguration.</i>					
	SO3624(#)(*)(~)	36x22x28	90/15.0	521	154
	SO3620(#)(*)(~)	36x18.75x28	90/15.0	503	154
	SO3024(#)(*)(~)	30x22x28	70/13.0	496	154
	SO3020(#)(*)(~)	30x18.75x28	70/13.0	471	154
	SO2424(#)(*)(~)	24x22x28	70/13.0	484	154
	SO2420(#)(*)(~)	24x18.75x28	70/13.0	466	154
	SO1824(#)(*)(~)	18x22x28	70/13.0	455	154
	SO1820(#)(*)(~)	18x18.75x28	70/13.0	438	154
<b>Open Storage</b>					

**Notes:**

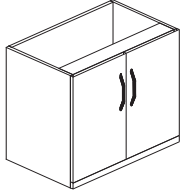
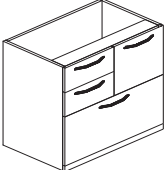
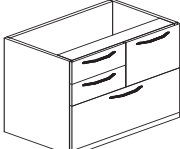
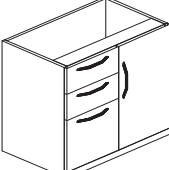
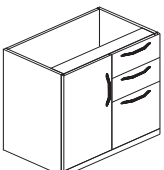
- Locks included.
- All lateral file drawers accommodate letter and legal size files front to back or side to side. All pedestal file drawers accommodate legal size files side to side only and letter front to back or side to side.
- One pencil tray is included with each box drawer pedestal.
- Most pedestals and laterals above are available as all metal products. Please call for availability.
- Seat cushions are available for above pedestals. Above models with cushions do not fit under desks.

**Ordering Details:**

- (#) - Specify 'H' for HPL drawer fronts, and add charge in right column.
- (\*) - Add "T" for laminate top to fit above products for desk height; add \$110 to price.
- (~) Add "PS" for units used with Post Mounted Storage.



# Freestanding Storage

STORAGE UNITS	Model	Size (WDH)	Wt./Cube (KD)	Price	H/P Drawer Front
 <p><b>Closed Storage</b></p>	SC3624(#)(*)(~)	36x22x28	95/16.0	552	154
	SC3620(#)(*)(~)	36x18.75x28	89/16.0	534	154
	SC3024(#)(*)(~)	30x22x28	75/14.0	527	154
	SC3020(#)(*)(~)	30x18.75x28	69/14.0	503	154
	SC2424(#)(*)(~)	24x22x28	75/14.0	516	154
	SC2420(#)(*)(~)	24x18.75x28	69/14.0	498	154
	SC1824(#)(*)(~)	18x22x28	75/14.0	486	154
	SC1820(#)(*)(~)	18x18.75x28	69/14.0	469	154
 <p><b>Personal Pedestal, 2 Box Right</b></p>	<i>One adjustable shelf included in cabinet.</i>				
	PP2BR3624(#)(*)(~)	36x22x28	120/16.0	891	154
	PP2BR3620(#)(*)(~)	36x18.75x28	100/16.0	879	154
	PP2BR3024(#)(*)(~)	30x22x28	115/14.0	855	154
 <p><b>Personal Pedestal, 2 Box Left</b></p>	PP2BL3624(#)(*)(~)	36x22x28	120/16.0	891	154
	PP2BL3620(#)(*)(~)	36x18.75x28	100/16.0	879	154
	PP2BL3024(#)(*)(~)	30x22x28	115/14.0	855	154
	PP2BL3020(#)(*)(~)	30x18.75x28	95/14.0	805	154
 <p><b>Personal Combo Storage Left</b></p>	PCSL3624(#)(*)(~)	36x22x28	120/16.0	855	154
	PCSL3620(#)(*)(~)	36x18.75x28	100/16.0	830	154
	PCSL3024(#)(*)(~)	30x22x28	115/14.0	805	154
	PCSL3020(#)(*)(~)	30x18.75x28	95/14.0	780	154
 <p><b>Personal Combo Storage Right</b></p>	<i>One adjustable shelf included in cabinet.</i>				
	PCSR3624(#)(*)(~)	36x22x28	120/16.0	855	154
	PCSR3620(#)(*)(~)	36x18.75x28	100/16.0	830	154
	PCSR3024(#)(*)(~)	30x22x28	115/14.0	805	154
	PCSR3020(#)(*)(~)	30x18.75x28	95/14.0	780	154

**Notes:**

1. Locks included.
2. All lateral file drawers accommodate letter and legal size files front to back or side to side. All pedestal file drawers accommodate legal size files side to side only and letter front to back or side to side.
3. One pencil tray is included with each storage unit containing a box drawer.

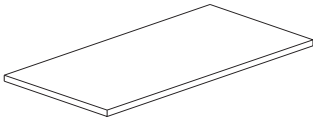
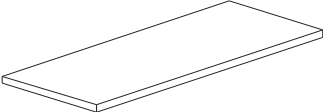
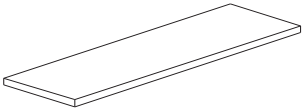
**Ordering Details:**

(#) - Specify 'H' for HPL drawer fronts, and add charge in right column.

(\*) - Add "T" for laminate top to fit above products for desk height; add \$110 to price.

(~) Add "PS" for units used with Post Mounted Storage.

# Modular Component Worksurfaces

WORKSURFACES	Model	Size (WD)	Wt./Cube	LPL		HPL	
				1"	1-1/2"	1-1/8"	1-1/2"
	NSTOP9630(X)(#)	96x30	96/6.4	363	491	470	874
	NSTOP9030(X)(#)	90x30	92/3.3	355	480	437	856
	NSTOP8430(X)(#)	84x30	86/3.1	344	470	431	823
	NSTOP7830(X)(#)	78x30	80/2.9	336	464	426	802
	NSTOP7230(X)(#)	72x30	72/5.0	334	459	393	769
	NSTOP6630(X)(#)	66x30	68/5.0	323	438	388	748
	NSTOP6030(X)(#)	60x30	62/4.2	317	371	382	579
	NSTOP5430(X)(#)	54x30	56/2.0	286	355	377	568
	NSTOP4830(X)(#)	48x30	49/3.4	224	328	339	547
	NSTOP4230(X)(#)	42x30	42/2.7	221	295	300	426
	NSTOP3630(X)(#)	36x30	39/1.4	218	289	295	415
	<b>Worksurfaces to cover up to 30" deep components</b>	NSTOP3030(X)(#)	30x30	30/1.1	213	278	286
	NSTOP2430(X)(#)	24x30	32/1.9	202	273	280	355
	NSTOP9624(X)(#)	96x24	76/2.9	358	480	437	863
	NSTOP9024(X)(#)	90x24	71/2.2	344	470	420	808
	NSTOP8424(X)(#)	84x24	66/2.5	339	459	410	779
	NSTOP7824(X)(#)	78x24	61/2.4	330	453	393	757
	NSTOP7224(X)(#)	72x24	57/4.0	328	448	388	735
	NSTOP6624(X)(#)	66x24	54/4.0	306	437	382	725
	NSTOP6024(X)(#)	60x24	49/3.4	295	349	371	459
	NSTOP5424(X)(#)	54x24	44/1.7	278	341	355	448
	NSTOP4824(X)(#)	48x24	39/2.8	263	323	284	444
	NSTOP4224(X)(#)	42x24	32/2.1	218	284	289	404
	NSTOP3624(X)(#)	36x24	28/1.1	226	276	282	381
	<b>Worksurfaces to cover up to 24" deep components</b>	NSTOP3024(X)(#)	30x24	26/1.9	198	239	244
	NSTOP2424(X)(#)	24x24	24/1.8	178	217	222	299
	NSTOP9620(X)(#)	96x20	69/2.9	342	464	420	846
	NSTOP9020(X)(#)	90x20	65/2.7	328	453	404	792
	NSTOP8420(X)(#)	84x20	61/2.5	322	442	393	762
	NSTOP7820(X)(#)	78x20	56/2.4	313	437	377	740
	NSTOP7220(X)(#)	72x20	52/2.2	311	431	371	719
	NSTOP6620(X)(#)	66x20	49/2.0	289	410	366	704
	NSTOP6020(X)(#)	60x20	45/1.8	278	333	355	442
	NSTOP5420(X)(#)	54x20	39/1.7	262	324	339	431
	NSTOP4820(X)(#)	48x20	35/1.5	252	307	268	428
	NSTOP4220(X)(#)	42x20	30/1.3	202	268	273	388
	NSTOP3620(X)(#)	36x20	25/1.1	210	260	265	365
	<b>Worksurfaces to cover up to 18" deep components</b>	NSTOP3020(X)(#)	30x20	22/1.9	181	223	227
	NSTOP2420(X)(#)	24x20	20/1.8	162	201	205	283

Note: These tops can be used, together with modular components, to create custom casegoods. For non-listed sizes use the width of components specified and use pricing for next largest depth, i.e. if components are 42" w x 18d, find 42" w top above, use 20" d pricing. Your model number is: NSTOP4218(X). You can also combine several components and obtain a common top to join them. In this case, use the pricing for next largest width AND depth. For example, if you have 3 components all with a depth of 22" and different widths of 16.5", 30", and 16.5" for a total of 63", use 66" x 24" pricing. Your model number is NSTOP6322(X).

**Ordering Details:**

(X) - Specify 'M1' for 1" LPL, 'M2' for 1-1/2" LPL,

**Options:**

'H1' for 1-1/8" HPL, or 'H2' for 1-1/2" HPL. (#) - Specify grommet position: standard locations are at rear of work surface, Left (GL), Center (CG) and Right (GR). Add \$40 list per grommet.

Any other location must be specified with a drawing and has a 68.00 list price.

# Wall Mounted Storage Specifications

## WALL MOUNTED STORAGE

A wide variety of lengths are available, in 6" increments from 24" to 72".

Gables, shelves, doors and back panels are made of 3/4" thick laminate and are available in all colors that can be found in the BRC finish guide.

Edges are rigid PVC (2.5mm) thick, and are available in all colors found in the BRC finish guide.

Locks are standard on all laminate doors.

Wall mount brackets included.

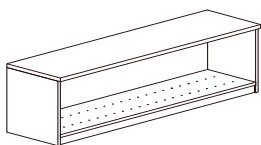
Wall mounted cabinets are available in nine models listed below and shown in order left to right:

1. Single height open front.
2. Single height hinged door.
3. Straight front flipper door(s).
4. Sculptured front flipper door(s).
5. Double height open front.
6. Double height hinged doors.
7. Radiused end open storage.
8. Glazed Door Options.
9. Single Sliding Door Options.

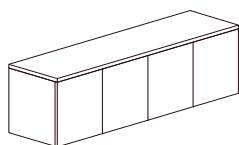
### Available options:

HPL doors.

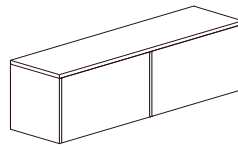
Clear or frosted glazing option available on all hinged or sliding doors.



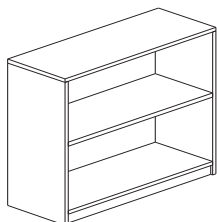
1



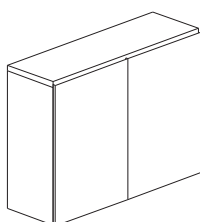
2



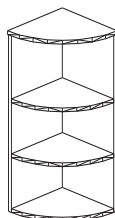
3



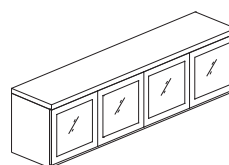
5



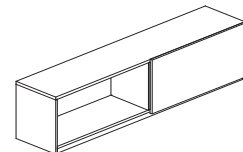
6



7

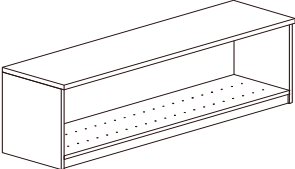


8



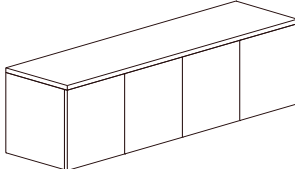
9

# Wall Mounted Storage

WALL MOUNTED CASEGOODS STORAGE	Model	Size (WDH)	Wt./Cube	LPL Top		H/P Door Fronts
				1"	1-1/2"	
	WOF7218(X)	72 x15.75 x 18.5	103/12.7	483	568	
	WOF6618(X)	66 x15.75 x 18.5	95/11.3	450	536	
	WOF6018(X)	60 x15.75 x 18.5	88/10.7	417	502	
	WOF5418(X)	54 x15.75 x 18.5	77/9.3	375	459	
	WOF4818(X)	48 x15.75 x 18.5	72/8.6	333	417	
	WOF4218(X)	42 x15.75 x 18.5	60/7.3	299	383	
	WOF3618(X)	36 x15.75 x 18.5	51/6.3	263	348	
	WOF3018(X)	30 x15.75 x 18.5	43/5.3	236	320	
	WOF2418(X)	24 x15.75 x 18.5	34/4.3	212	296	

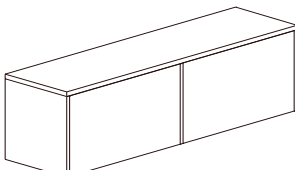
**Open Front Storage**

Above cabinet shown with optional divider holes. To include holes add (DIV) to model number and \$79.00 to list price.

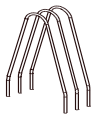
	WHD7218(X)(#)	72 x15.75 x 18.5	120/12.7	700	785	145
	WHD6618(X)(#)	66 x15.75 x 18.5	110/11.3	668	753	145
	WHD6018(X)(#)	60 x15.75 x 18.5	102/10.7	616	700	145
	WHD5418(X)(#)	54 x15.75 x 18.5	90/9.3	574	658	121
	WHD4818(X)(#)	48 x15.75 x 18.5	85/8.6	502	586	121
	WHD4218(X)(#)	42 x15.75 x 18.5	70/7.3	468	552	121
	WHD3618(X)(#)	36 x15.75 x 18.5	60/6.3	432	517	121
	WHD3018(X)(#)	30 x15.75 x 18.5	50/5.3	405	489	91
	WHD2418(X)(#)	24 x15.75 x 18.5	40/4.3	381	465	91

**Hinged Door Cabinet**

Available with framed glazed doors, clear or frosted glazing option . See below to order.

	WFD7218(X)(#)	72 x15.75 x 18.5	120/12.7	727	811	145
	WFD6618(X)(#)	66 x15.75 x 18.5	110/11.3	694	778	145
	WFD6018(X)(#)	60 x15.75 x 18.5	103/10.7	650	735	145
	WFD5418(X)(#)	54 x15.75 x 18.5	90/9.3	608	692	121
	WFD4818(X)(#)	48 x15.75 x 18.5	85/8.6	579	664	121
	WFD4218(X)(#)	42 x15.75 x 18.5	70/7.3	545	630	121
	WFD3618(X)(#)	36 x15.75 x 18.5	60/6.3	509	593	121
	WFD3018(X)(#)	30 x15.75 x 18.5	50/5.3	482	567	91
	WFD2418(X)(#)	24 x15.75 x 18.5	40/4.3	458	543	91

**Straight Front  
Flipper Door Cabinet**



**Wire Dividers (set of 4)**

PH-SD5 30  
Specify part number on which to install dividers.

*Note: Wall mount brackets included.*

**Ordering Details:**

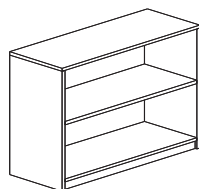
(X) - Specify 'M1' for 1" LPL, 'M2' for 1-1/2" LPL, 'H1' for 1-1/8" HPL, or 'H2' for 1-1/2" HPL.(#) - Specify 'H' for HPL doors and add upcharge in right column. Custom sizes are available. Please call for details and pricing.

**Options:**

For glazed framed doors with frosted glazing:  
(1) indicate by adding "GG" to model number,  
(2) add 252.00 to list price for cabinets up to 42" wide and 504.00 for 48" and greater.

# Wall Mounted Storage

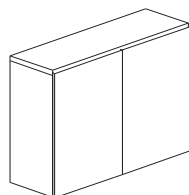
WALL MOUNTED CASEGOODS STORAGE	Model	Size (WDH)	Wt./Cube	LPL Top 1"	1-1/2"	H/P Door Fronts
-----------------------------------	-------	---------------	----------	---------------	--------	--------------------



**Double Height  
Open Front Unit**

WDOF7232(X)	72x 15.75 x32	206/24.0	786	924		
WDOF6632(X)	66x 15.75 x32	195/22.0	733	872		
WDOF6032(X)	60x 15.75 x32	180/20.0	678	816		
WDOF5432(X)	54x 15.75 x32	160/18.0	610	749		
WDOF4832(X)	48x 15.75 x32	152/16.0	541	678		
<i>Above sizes include fixed center divider</i>						
WDOF4232(X)	42x 15.75 x32	135/14.0	486	626		
WDOF3632(X)	36x 15.75 x32	118/12.0	455	602		
WDOF3032(X)	30x 15.75 x32	95/10.0	443	584		
WDOF2432(X)	24x 15.75 x32	75/8.0	431	565		

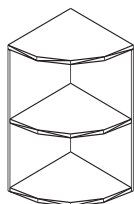
Above cabinet available with divider holes. To include holes add (DIV) to model number and \$79.00 to list price.



**Double Height  
Hinged Door Unit**

WDHD7232(X)(#)	72x 15.75 x32	250/24.0	1,212	1,363	185	
WDHD6632(X)(#)	66x 15.75 x32	230/22.0	1,167	1,302	185	
WDHD6032(X)(#)	60x 15.75 x32	215/20.0	1,066	1,216	185	
WDHD5432(X)(#)	54x 15.75 x32	190/18.0	994	1,141	154	
WDHD4832(X)(#)	48x 15.75 x32	180/16.0	869	1,014	154	
<i>Above sizes include fixed center divider</i>						
WDHD4232(X)(#)	42x 15.75 x32	155/14.0	806	958	154	
WDHD3632(X)(#)	36x 15.75 x32	125/12.0	749	896	154	
WDHD3032(X)(#)	30x 15.75 x32	110/10.0	712	859	123	
WDHD2432(X)(#)	24x 15.75 x32	95/8.0	695	835	123	

Available with framed glazed doors, clear or frosted glazing option . See below to order.



**Wall Mounted, Radiused  
End Open Storage**

WRE1632(X)	15.75 x 15.75 x32	50/5.0	284	301	
<i>includes one adjustable shelf.</i>					
WRE1618(X)	15.75 x 15.75 x18.	40/2.3	258	289	

**Ordering Details:**

(X) - Specify 'M1' for 1" LPL or 'M2' for 1 1/2" LPL.  
 (#) - Specify 'H' for HPL doors and add upcharge in right column.

**Options:**

Custom sizes are available. Please call for details and pricing.  
 For glazed framed doors with frosted glazing:

- (1) indicate by adding "GG" to model number,
- (2) add 252.00 to list price for cabinets up to 42" wide and 504.00 for 48" and greater.

# Post Mounted Storage Specifications

## **POST MOUNTED STORAGE**

A wide variety of lengths are available, in 6" increments from 24" to 72".

Gables, shelves, doors and back panels are made of 3/4" thick laminate and are available in all colors that can be found in the BRC finish guide.

Posts are constructed of aluminum and are capable of fully supporting storage elements.

Edges are rigid PVC (2.5mm) thick, and are available in all colors found in the BRC finish guide.

Locks are standard on all laminate doors.

Posts and all hardware included.

Post mounted cabinets are available in six models listed below and shown in order left to right:

1. Single height open front.
2. Single height hinged door.
3. Straight front flipper door(s).
4. Sculptured front flipper door(s).
5. Glazed Door Options.
6. Single Sliding Door Options.

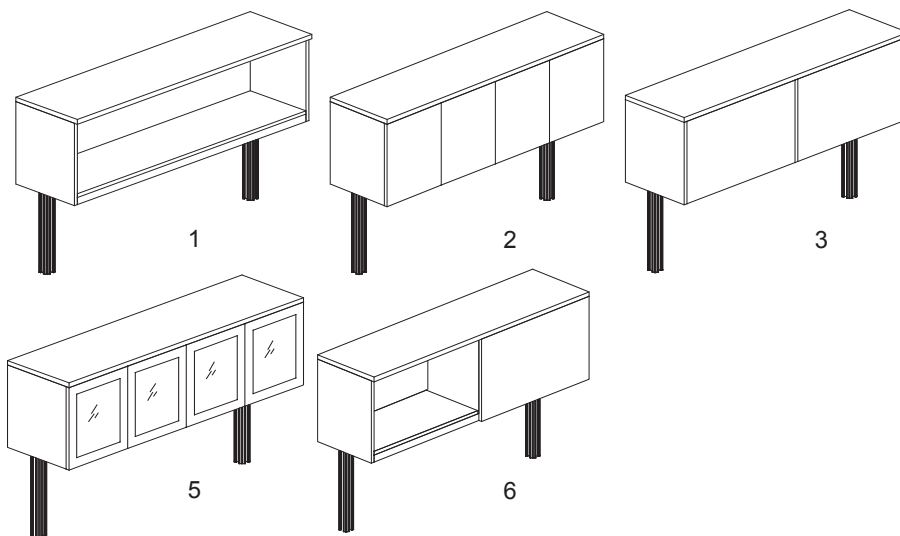
### **Available options:**

HPL doors.

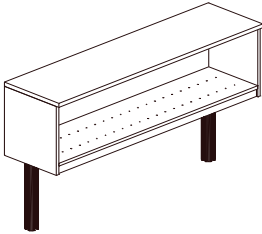
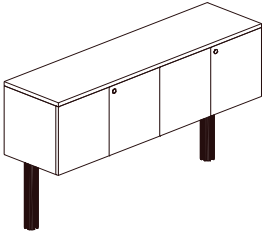
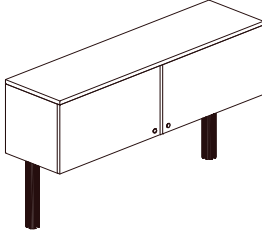
Framed doors with frosted glazing - available on all hinged and sliding doors.

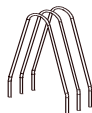
Panel inserts - fabric, laminate or glazed.

Electrical and or Communication ports in posts.



# Post Mounted Storage

POST MOUNTED CASEGOODS STORAGE	Model	Size (WDH)	Wt./Cube	LPL Top 1" 1-1/2"	H/P Door Fronts	
 <p><b>Open Front Storage</b></p>	PMOF7214(X)	72 x15.75 x 18.5	103/12.7	735	812	
	PMOF6614(X)	66 x15.75 x 18.5	95/11.3	706	782	
	PMOF6014(X)	60 x15.75 x 18.5	88/10.7	675	752	
	PMOF5414(X)	54 x15.75 x 18.5	77/9.3	637	713	
	PMOF4814(X)	48 x15.75 x 18.5	72/8.6	600	675	
	PMOF4214(X)	42 x15.75 x 18.5	60/7.3	569	645	
	PMOF3614(X)	36 x15.75 x 18.5	51/6.3	537	612	
	PMOF3014(X)	30 x15.75 x 18.5	43/5.3	512	588	
	PMOF2414(X)	24 x15.75 x 18.5	34/4.3	490	567	
Above cabinet shown with optional divider holes. To include add (DIV) to model number and \$79.00 to list price.						
 <p><b>Hinged Door Cabinet</b></p>	PMD7214(X)(#)	72 x15.75 x 18.5	120/12.7	930	1,007	145
	PMD6614(X)(#)	66 x15.75 x 18.5	110/11.3	902	978	145
	PMD6014(X)(#)	60 x15.75 x 18.5	102/10.7	855	930	145
	PMD5414(X)(#)	54 x15.75 x 18.5	90/9.3	817	893	121
	PMD4814(X)(#)	48 x15.75 x 18.5	85/8.6	752	827	121
	PMD4214(X)(#)	42 x15.75 x 18.5	70/7.3	721	797	121
	PMD3614(X)(#)	36 x15.75 x 18.5	60/6.3	689	764	121
	PMD3014(X)(#)	30 x15.75 x 18.5	50/5.3	665	740	91
	PMD2414(X)(#)	24 x15.75 x 18.5	40/4.3	643	719	91
Available with framed glazed doors, clear or frosted glazing option . See below to order.						
 <p><b>Straight Front Flipper Door Cabinet</b></p>	PMFD7214(X)(#)	72 x15.75 x 18.5	120/12.7	953	1,030	145
	PMFD6614(X)(#)	66 x15.75 x 18.5	110/11.3	924	1,001	145
	PMFD6014(X)(#)	60 x15.75 x 18.5	103/10.7	885	961	145
	PMFD5414(X)(#)	54 x15.75 x 18.5	90/9.3	847	923	121
	PMFD4814(X)(#)	48 x15.75 x 18.5	85/8.6	821	897	121
	PMFD4214(X)(#)	42 x15.75 x 18.5	70/7.3	791	866	121
	PMFD3614(X)(#)	36 x15.75 x 18.5	60/6.3	758	834	121
	PMFD3014(X)(#)	30 x15.75 x 18.5	50/5.3	734	811	91
	PMFD2414(X)(#)	24 x15.75 x 18.5	40/4.3	712	789	91



**Wire Dividers (set of 4)**

PH-SD5 30  
Specify part number on which to install dividers.

**Ordering Details:**

Note: Posts and all desk mounting hardware included.

(X) - Specify 'M1' for 1" LPL, 'M2' for 1-1/2" LPL, 'H1' for 1-1/8" HPL, or 'H2' for 1-1/2" HPL.

**Options:**

(#) - Specify 'H' for HPL doors and add upcharge in right column. Custom sizes are available. Please call for details and pricing.

For glazed framed doors with frosted glazing:

(1) indicate by adding "GG" to model number,

(2) add 252.00 to list price for cabinets up to 42" wide and 504.00 for 48" and greater.

When specifying post mounted overhead storage above FSPEDS and FSLAT - USE a

(~)-PS in the pedestal or lateral code to indicate it is for use with a post mounted system.

Posts are available separately for panels or reception tops. Please see panel section.

# Hutch Specifications

## HUTCHES AND ACCESSORIES

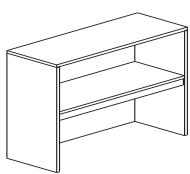
A wide variety of lengths are available, in 6" increments from 24" to 84".  
 Hutches are designed for closed office space where panels are not necessary.  
 Hutches have end gables, allowing placement on any horizontal surface.  
 The laminate base is available in 17 main body colors, including six woodgrain finishes.  
 Edges are rigid PVC (2.5 mm) thick, and are available in colors found in the BRC finish guide.

Flipper units 24" to 42" in length have one door, and 48" to 84" in length have two doors.  
 Double faced mounting tape is provided to attach hutch to worksurface.  
 Hutches are available at 37" high, with 19" of clearance, and 43" high, with 25" of clearance.  
 Locks are standard.  
 All tops are available in LPL 1" and 1-1/2" thick.  
 All hutches are shipped assembled.

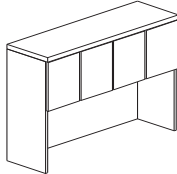
### Available options:

- HPL doors
- Framed doors with frosted glazing - available on all hinged and sliding door options.**
- Tackboards
- Pigeonholes
- Wire dividers
- Tasklights multiple widths

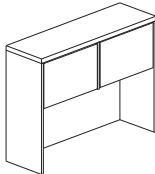
### Straight Hutches



**Open Front**

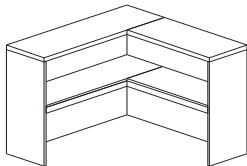


**Hinged Doors**

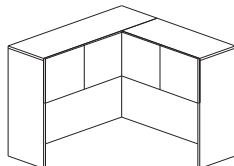


**Straight Front  
Receding Door(s)**

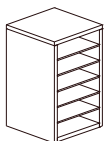
### 90 Degree Hutches



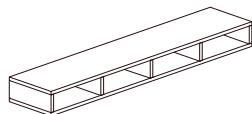
**90 Degree  
Open Corner**



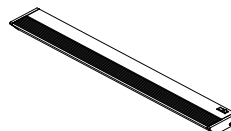
**90 Degree  
Hinged Doors**



**Vertical Pigeon Holes**



**Horizontal Pigeon Holes**

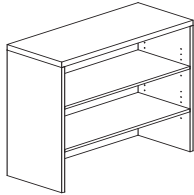


**Task Light**



# Open Bookcase Hutches

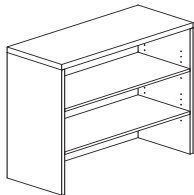
OPEN BOOKCASE HUTCHES	Model	Size (WDH)	Wt./Cube	LPL	
				1"	1-1/2"



TDOS42H(X)(*)	42x15x43	95/16.0	671	730
TDOS36H(X)(*)	36x15x43	85/13.8	645	689
TDOS30H(X)(*)	30x15x43	72/11.5	614	650
TDOS24H(X)(*)	24x15x43	65/9.4	610	638

**Open Bookcase Hutch  
43" Height**

*Note: Hutches above contain two adjustable shelves.*



TDOS42T(X)(*)	42x15x37	95/16.0	505	564
TDOS36T(X)(*)	36x15x37	85/13.8	478	531
TDOS30T(X)(*)	30x15x37	74/11.6	448	484
TDOS24T(X)(*)	24x15x37	65/9.4	443	471

**Open Bookcase Hutch  
37" Height**

*Note: Hutches above contain two adjustable shelves.*

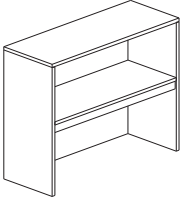
**Ordering Details:**

(X) - Specify 'M1' for 1" LPL, 'M2' for 1-1/2" LPL,

**Options:**

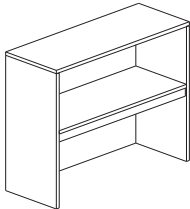
Custom sizes are available. Please call for details and pricing.

# Open Hutches

OPEN HUTCHES	Model	Size (WDH)	Wt./Cube	LPL		HPL	
				1"	1-1/2"	1-1/8"	1-1/2"
 <p><b>Open Front Hutch 43" Height</b></p>	TDO84H(X)(*)	84x15x43	179/32.9	1,070	1,162		
	TDO78H(X)(*)	78x15x43	160/29.0	1,014	1,100		
	TDO72H(X)(*)	72x15x43	141/26.9	971	1,046		
	TDO66H(X)(*)	66x15x43	132/24.7	732	805		
	TDO60H(X)(*)	60x15x43	122/24.5	714	779		
	TDO54H(X)(*)	54x15x43	115/20.3	701	757		
	TDO48H(X)(*)	48x15x43	104/18.1	622	692		
	TDO42H(X)(*)	42x15x43	95/16.0	566	625		
	TDO36H(X)(*)	36x15x43	85/13.8	540	593		
	TDO30H(X)(*)	30x15x43	74/11.6	509	545		
	TDO24H(X)(*)	24x15x43	65/9.4	505	533		

Above cabinet available with divider holes. To include add (DIV) to model number and \$79.00 to list price.

*Note: TDO\_H's have 14" of clearance between shelves and 25" from table, and a center support panel on hutches with a width of 42" or greater.*

 <p><b>Open Front Hutch 37" Height</b></p>	TDO84T(X)(*)	84x15x37	179/32.9	860	952		
	TDO78T(X)(*)	78x15x37	160/29.0	805	891		
	TDO72T(X)(*)	72x15x37	141/26.9	762	836		
	TDO66T(X)(*)	66x15x37	132/24.7	523	596		
	TDO60T(X)(*)	60x15x37	122/24.5	504	569		
	TDO54T(X)(*)	54x15x37	115/20.3	491	547		
	TDO48T(X)(*)	48x15x37	104/18.1	455	525		
	TDO42T(X)(*)	42x15x37	95/16.0	400	459		
	TDO36T(X)(*)	36x15x37	85/13.8	373	426		
	TDO30T(X)(*)	30x15x37	74/11.6	343	379		
	TDO24T(X)(*)	24x15x37	65/9.4	338	366		

Above cabinet available with divider holes. To include add (DIV) to model number and \$79.00 to list price.

*Note: TDO\_T's have 14" of clearance between shelves and 19" from table, and a center support panel on hutches with a width of 42" or greater.*

HRE1537(X)	15x15x37	55/6.2	286	303
HRE1543(X)	15x15x43	55/6.2	347	365

*Includes two adjustable shelves.*

**Hutch Radiused End  
Open Storage**

*Place on table, desk, credenza, or any 29" high unit.*

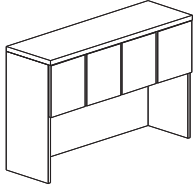
**Ordering Details:**

(X) - Specify 'M1' for 1" LPL, 'M2' for 1-1/2" LPL, 'H1' for 1-1/8" HPL, or 'H2' for 1-1/2" HPL.

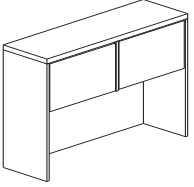
**Options:**

Custom sizes are available. Please call for details and pricing.  
 Pigeon hole dividers are available, see hutch accessories section.  
 (\*) - For recessed gable option specify 'L' left or 'R' right for recessed gable.  
 Add \$142.00 list to above prices.

# Closed Hutches

CLOSED HUTCHES	Model	Size (WDH)	Wt./Cube		LPL Top 1" 1-1/2"	H/P Door Fronts
 <p><b>Hinged Doors</b> <b>37" Height</b></p>	TDO84-TCUP(X)(#)(*)	84x15x37	197/32.9	1,009	1,227	185
	TDO78-TCUP(X)(#)(*)	78x15x37	185/29.0	959	1,172	185
	TDO72-TCUP(X)(#)(*)	72x15x37	173/26.9	916	1,049	185
	TDO66-TCUP(X)(#)(*)	66x15x37	161/24.7	750	855	185
	TDO60-TCUP(X)(#)(*)	60x15x37	148/24.5	737	820	185
	TDO54-TCUP(X)(#)(*)	54x15x37	136/20.3	712	743	154
	TDO48-TCUP(X)(#)(*)	48x15x37	124/18.1	602	668	154
	TDO42-TCUP(X)(#)(*)	42x15x37	120/16.0	541	624	154
	TDO36-TCUP(X)(#)(*)	36x15x37	100/13.8	516	581	154
	TDO30-TCUP(X)(#)(*)	30x15x37	88/11.6	479	508	123
TDO24-TCUP(X)(#)(*)	24x15x37	75/9.4	474	486	123	

Available with framed glazed doors, clear or frosted glazing option . See below to order.  
*TDO-TCUPs have 14" of clearance between shelves and 19" from table, and a center support panel on hutches with a width of 42" or greater.*

 <p><b>Straight Front Receding Door(s)</b> <b>37" Height</b></p>	TDO84-TFU(X)(#)(*)	84x15x37	197/32.9	1,137	1,240	185
	TDO78-TFU(X)(#)(*)	78x15x37	185/29.0	1,069	1,163	185
	TDO72-TFU(X)(#)(*)	72x15x37	173/26.9	1,002	1,088	185
	TDO66-TFU(X)(#)(*)	66x15x37	161/24.7	968	1,054	185
	TDO60-TFU(X)(#)(*)	60x15x37	148/24.5	924	1,010	185
	TDO54-TFU(X)(#)(*)	54x15x37	136/20.3	881	967	154
	TDO48-TFU(X)(#)(*)	48x15x37	124/18.1	852	872	154
	TDO42-TFU(X)(#)(*)	42x15x37	120/16.0	818	903	154
	TDO36-TFU(X)(#)(*)	36x15x37	100/13.8	780	866	154
	TDO30-TFU(X)(#)(*)	30x15x37	88/11.6	754	963	123
TDO24-TFU(X)(#)(*)	24x15x37	75/9.4	729	815	123	

*TDO-TFUs have 14" of clearance between shelves and 19" from table, and a center support panel on hutches with a width of 42" or greater.*

<p><b>Sculptured Receding Door(s)</b></p>	TDO84-TFUC(X)(#)(*)	84x15x37	197/32.9	1,198	1,302	185
	TDO78-TFUC(X)(#)(*)	78x15x37	185/29.0	1,131	1,225	185
	TDO72-TFUC(X)(#)(*)	72x15x37	173/26.9	1,064	1,149	185
	TDO66-TFUC(X)(#)(*)	66x15x37	161/24.7	1,030	1,116	185
	TDO60-TFUC(X)(#)(*)	60x15x37	148/24.5	986	1,072	185

*TDO-TFUCs have 14" of clearance between shelves and 19" from table, and a center support panel on hutches with a width of 42" or greater.*

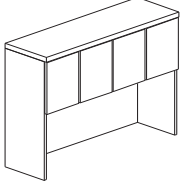
**Ordering Details:**

(X) - Specify 'M1' for 1" LPL or 'M2' for 1-1/2" LPL.  
 (#) - Specify 'H' for HPL doors and add upcharge in right column.

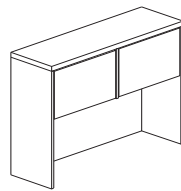
**Options:**

Custom sizes are available. Please call for details and pricing.  
 Pigeon hole dividers are available, see hutch accessories section.  
 For glazed framed doors with frosted glazing:  
 (available only on models with hinged doors):  
 (1) indicate by adding "GG" to model number,  
 (2) add 252.00 to list price for cabinets up to 42" wide and 504.00 for 48" and greater.  
 (\*) - For recessed gable option specify 'L' left or 'R' right for recessed gable.  
 Add \$142.00 list to above prices.

# Closed Hutches

CLOSED HUTCHES	Model	Size (WDH)	Wt./Cube	LPL Top 1"	1-1/2"	H/P Door Fronts
 <p><b>Hinged Doors</b> <b>43" Height</b></p>	TDO84-HCUP(X)(#)(*)	84x15x43	197/32.9	1,324	1,542	185
	TDO78-HCUP(X)(#)(*)	78x15x43	185/29.0	1,274	1,486	185
	TDO72-HCUP(X)(#)(*)	72x15x43	173/26.9	1,231	1,363	185
	TDO66-HCUP(X)(#)(*)	66x15x43	161/24.7	1,065	1,169	185
	TDO60-HCUP(X)(#)(*)	60x15x43	148/24.5	1,052	1,134	185
	TDO54-HCUP(X)(#)(*)	54x15x43	136/20.3	1,026	1,058	154
	TDO48-HCUP(X)(#)(*)	48x15x43	124/18.1	873	939	154
	TDO42-HCUP(X)(#)(*)	42x15x43	120/16.0	813	895	154
	TDO36-HCUP(X)(#)(*)	36x15x43	100/13.8	786	852	154
	TDO30-HCUP(X)(#)(*)	30x15x43	88/11.6	750	779	123
TDO24-HCUP(X)(#)(*)	24x15x43	75/9.4	744	757	123	

Available with framed glazed doors, clear or frosted glazing option . See below to order.  
*TDO-HCUPs have 14" of clearance between shelves and 25" from table, and a center support panel on hutches with a width of 42" or greater.*

 <p><b>Straight Front Receding Door(s)</b> <b>43" Height</b></p>	TDO84-HFU(X)(#)(*)	84x15x43	197/32.9	1,451	1,554	185
	TDO78-HFU(X)(#)(*)	78x15x43	185/29.0	1,384	1,478	185
	TDO72-HFU(X)(#)(*)	72x15x43	173/26.9	1,316	1,402	185
	TDO66-HFU(X)(#)(*)	66x15x43	161/24.7	1,283	1,369	185
	TDO60-HFU(X)(#)(*)	60x15x43	148/24.5	1,239	1,325	185
	TDO54-HFU(X)(#)(*)	54x15x43	136/20.3	1,196	1,282	154
	TDO48-HFU(X)(#)(*)	48x15x43	124/18.1	1,124	1,143	154
	TDO42-HFU(X)(#)(*)	42x15x43	120/16.0	1,089	1,175	154
	TDO36-HFU(X)(#)(*)	36x15x43	100/13.8	1,052	1,138	154
	TDO30-HFU(X)(#)(*)	30x15x43	88/11.6	1,025	1,234	123
TDO24-HFU(X)(#)(*)	24x15x43	75/9.4	1,001	1,087	123	

*TDO-HFUs have 14" of clearance between shelves and 25" from table, and a center support panel on hutches with a width of 42" or greater.*

<p><b>Sculptured Receding Door(s)</b></p>	TDO84-HFUC(X)(#)(*)	84x15x43	197/32.9	1,513	1,616	185
	TDO78-HFUC(X)(#)(*)	78x15x43	185/29.0	1,445	1,539	185
	TDO72-HFUC(X)(#)(*)	72x15x43	173/26.9	1,378	1,464	185
	TDO66-HFUC(X)(#)(*)	66x15x43	161/24.7	1,344	1,430	185
	TDO60-HFUC(X)(#)(*)	60x15x43	148/24.5	1,300	1,386	185

*TDO-HFUCs have 14" of clearance between shelves and 25" from table, and a center support panel on hutches with a width of 42" or greater.*

**Ordering Details:**

(X) - Specify 'M1' for 1" LPL or 'M2' for 1-1/2" LPL.

**Options:**

(#) - Specify 'H' for HPL doors and add upcharge in right column. Custom sizes are available. Please call for details and pricing.

Pigeon hole dividers are available, see hutch accessories section.

For glazed framed doors with frosted glazing:

(available only on models with hinged doors):

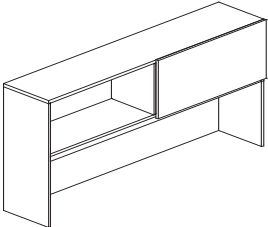
(1) indicate by adding "GG" to model number,

(2) add 252.00 to list price for cabinets up to 42" wide and 504.00 for 48" and greater.

(\*) - For recessed gable option specify 'L' left or 'R' right for recessed gable.

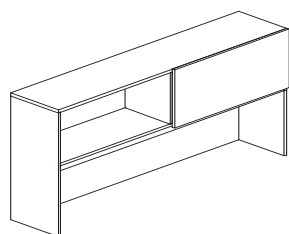
Add \$142.00 list to above prices.

# Sliding Door Hutches

SINGLE SLIDING DOOR HUTCHES	Model	Size (WDH)	Wt./Cube	Price	H/P Door Fronts	W/B Door Fronts
	TDO84HSS(#)(*)	84x15x43	197/32.9	1,819	90	111
	TDO78HSS(#)(*)	78x15x43	185/29.0	1,751	90	111
	TDO72HSS(#)(*)	72x15x43	173/26.9	1,683	90	111
	TDO66HSS(#)(*)	66x15x43	161/24.7	1,651	90	111
	TDO66HSS(#)(*)	60x15x43	148/21.6	1,607	90	111
	TDO66HSS(#)(*)	54x15x43	136/20.3	1,563	90	111
	TDO48HSS(#)(*)	48x15x43	124/18.1	1,491	90	111
	TDO42HSS(#)(*)	42x15x43	120/16.0	1,456	90	111

**Single Sliding Door Hutch  
43" Height**

*Note: TDO\_H's have 14" of clearance between shelves and 25" from table, and a center support panel on hutches with a width of 42" or greater. Each hutch comes with a single sliding door.*



TDO84TSS(#)(*)	84x15x37	197/32.9	1,505	90	111
TDO78TSS(#)(*)	78x15x37	185/29.0	1,436	90	111
TDO72TSS(#)(*)	72x15x37	173/26.9	1,369	90	111
TDO66TSS(#)(*)	66x15x37	161/24.7	1,336	90	111
TDO60TSS(#)(*)	60x15x37	148/24.5	1,292	90	111
TDO54TSS(#)(*)	54x15x37	136/20.3	1,248	90	111
TDO48TSS(#)(*)	48x15x37	124/18.1	1,219	90	111
TDO42TSS(#)(*)	42x15x37	120/16.0	1,185	90	111

**Single Sliding Door Hutch  
37" Height**

*Note: TDO\_T's have 14" of clearance between shelves and 19" from table, and a center support panel on hutches with a width of 42" or greater. Each hutch comes with a single sliding door.*

**Ordering Details:**

(#) - Specify 'H' for HPL doors and add upcharge under H/P Door Fronts.

(\*) - Specify 'WB' for white board doors and add upcharge under W/B Door Fronts. Magnetic white board option is available. Add \$480.00 to list price. (\*) Specify 'MWB'.

**Options:**

Custom sizes are available. Please call for details and pricing. Pigeon hole dividers are available, see hutch accessories section.

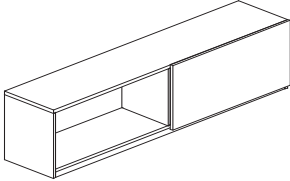
For glazed doors with frosted glazing:

- (1) indicate by adding "GG" to model number,
- (2) add 252.00 to list price for cabinets up to 42" wide and 504.00 for 48" and greater.

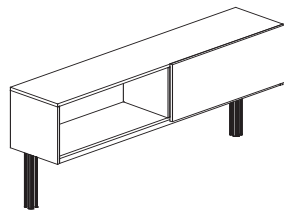
**Note:**

Lock is available on laminate door fronts only. Call for details.

# Sliding Door Hutches

SINGLE SLIDING DOOR HUTCHES	Model	Size (WDH)	Wt./Cube	Price	H/P Door Fronts	W/B Door Fronts
	WSS7218(#)(*)	72 x15.75 x 18.5	120/12.7	1,094	90	111
	WSS6618(#)(*)	66 x15.75 x 18.5	110/11.3	1,062	90	111
	WSS6018(#)(*)	60 x15.75 x 18.5	103/10.7	1,017	90	111
	WSS5418(#)(*)	54 x15.75 x 18.5	98/9.3	975	90	111
	WSS4818(#)(*)	48 x15.75 x 18.5	85/8.6	946	90	111
	WSS4218(#)(*)	42 x15.75 x 18.5	70/7.3	912	90	111

### Single Sliding Door Hutch Wall mounted



PMSS7214(#)(*)	72 x15.75 x 18.5	120/12.7	1,321	90	111
PMSS6614(#)(*)	66 x15.75 x 18.5	110/11.3	1,292	90	111
PMSS6014(#)(*)	60 x15.75 x 18.5	103/10.7	1,253	90	111
PMSS5414(#)(*)	54 x15.75 x 18.5	90/9.3	1,215	90	111
PMSS4814(#)(*)	48 x15.75 x 18.5	85/8.6	1,189	90	111
PMSS4214(#)(*)	42 x15.75 x 18.5	70/7.3	1,158	90	111

**Single Sliding Door Hutch (~)-PS** in the pedestal or lateral code to indicate it is for use with a post mounted system.

### Ordering Details:

(#) - Specify 'H' for HPL doors and add upcharge under H/P Door Fronts.  
 (\*) - Specify 'WB' for white board doors and add upcharge under W/B Door Fronts. Magnetic white board option is available. Add \$480.00 to list price. (\*) Specify 'MWB'.

### Options:

Custom sizes are available. Please call for details and pricing.  
 Pigeon hole dividers are available, see hutch accessories section.

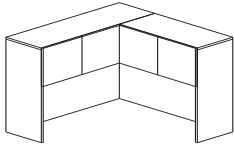
For glazed doors with frosted glazing:  
 (1) indicate by adding "GG" to model number,  
 (2) add 252.00 to list price for cabinets up to 42" wide and 504.00 for 48" and greater.

### Note:

Lock is available on laminate door fronts only. Call for details.

# Corner Hutches

CORNER HUTCHES	Model	Size (WDH)	Wt./Cube	LPL 1" 1-1/2"	H/P Door Fronts
----------------	-------	------------	----------	---------------	-----------------

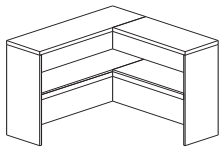


CTDO48-T(X)(*)	48x15x37	185/28.0	847	918	
CTDO42-T(X)(*)	42x15x37	161/24.0	713	807	
CTDO36-T(X)(*)	36x15x37	141/20.0	664	747	

Note: CTDO's have 14" of clearance between shelves and 19" from table.

Above cabinet available with optional divider holes. To include add (DIV) to model number and \$158.00 to list price.

### Open Corner

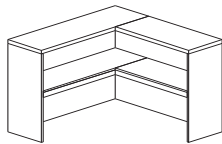


CTDO48-TCDR(X)(#)(*)	48x15x37	110/28.0	1,021	1,110	222
CTDO42-TCDR(X)(#)(*)	42x15x37	100/24.0	983	1,073	222
CTDO36-TCDR(X)(#)(*)	36x15x37	141/20.0	885	992	222

Available with framed glazed doors, clear or frosted glazing option . See below to order.

Note: CTDO's have 14" of clearance between shelves and 19" from table.

### 90 Degree - 37" Height Hinged Door Corner

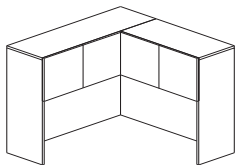


CTDOH48-T(X)(*)	48x15x43	185/28.0	1,180	1,251	
CTDOH42-T(X)(*)	42x15x43	161/24.0	1,046	1,140	
CTDOH36-T(X)(*)	36x15x43	141/20.0	996	1,079	

Note: CTDOH's have 14" of clearance between shelves and 19" from table.

### 90 Degree - 43" Height Open Corner

Above cabinet available with optional divider holes. To order add (DIV) to model number and \$158.00 to list price.



CTDOH48-TCDR(X)(#)(*)	48x15x43	110/28.0	1,353	1,443	222
CTDOH42-TCDR(X)(#)(*)	42x15x43	100/24.0	1,316	1,406	222
CTDOH36-TCDR(X)(#)(*)	36x15x43	141/20.0	1,218	1,325	222

Available with framed glazed doors, clear or frosted glazing option . See below to order.

Note: CTDOH's have 14" of clearance between shelves and 19" from table.

### 90 Degree - 43" Height Hinged Door Corner

#### Ordering Details:

(X) - Specify 'M1' for 1" LPL, 'M2' for 1-1/2" LPL, 'H1' for 1-1/8" HPL, or 'H2' for 1-1/2" HPL.(#) - Specify 'H' for HPL doors and add upcharge in right column.

#### Options:

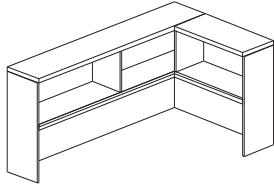
Custom sizes are available. Please call for details and pricing.

For glazed framed doors with frosted glazing:  
 (available only on models with hinged doors):  
 (1) indicate by adding "GG" to model number,  
 (2) add 252.00 to list price for cabinets up to 42" wide and 504.00 for 48" and greater.

(\*) - For recessed gable option specify 'L' left or 'R' right for recessed gable  
 Add \$142.00 list to above prices.

# Extended Corner Hutches

EXTENDED CORNER HUTCHES	Model	Size (WDH)	Wt./Cube	LPL 1"	1-1/2"	H/P Door Fronts
-------------------------	-------	------------	----------	--------	--------	-----------------



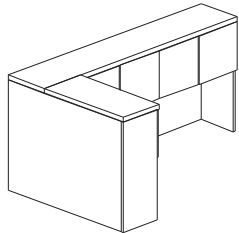
CTDO8436T(L)(X)(#)(*)	84x36x37	218/39.0	1,289	1,334	
CTDO7836T(L)(X)(#)(*)	78x36x37	209/37.0	1,167	1,210	
CTDO7236T(L)(X)(#)(*)	72x36x37	200/35.0	1,014	1,086	
CTDO6636T(L)(X)(#)(*)	66x36x37	191/33.0	860	956	
CTDO6036T(L)(X)(#)(*)	60x36x37	182/31.0	798	853	

Note: CTDO's have 14" of clearance between shelves and 19" from table.

### Left Extended Corner

\* For right hand corner hutches, change (L) to (R) in model number.

Above cabinet available with optional divider holes. To include add (DIV) to model number and \$158.00 to list price.



CTDO8436TC(R)(X)(#)(*)	84x36x37	247/39.0	1,584	1,688	246
CTDO7836TC(R)(X)(#)(*)	78x36x37	236/37.0	1,462	1,528	246
CTDO7236TC(R)(X)(#)(*)	72x36x37	225/35.0	1,272	1,367	222
CTDO6636TC(R)(X)(#)(*)	66x36x37	214/33.0	1,106	1,244	222
CTDO6036TC(R)(X)(#)(*)	60x36x37	203/31.0	1,100	1,141	222

Available with framed glazed doors, clear or frosted glazing option . See below to order.

### Right Extended Corner Hutch With Doors 37" Height

Note: CTDO's have 14" of clearance between shelves and 19" from table.

\* For right hand corner hutches, change (L) to (R) in model number.

### Ordering Details:

(X) - Specify 'M1' for 1" LPL or 'M2' for 1-1/2" LPL,.  
 (#) - Specify 'H' for HPL doors and add upcharge in right column.

### Options:

Custom sizes are available. Please call for details and pricing.

For glazed framed doors with frosted glazing: (only on models with hinged doors):

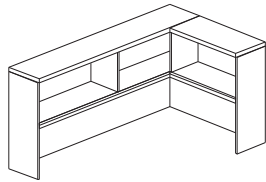
- (1) indicate by adding "GG" to model number,
- (2) add 609.00 to list prices.

(\*) - For recessed gable option specify 'L' left or 'R' right for recessed gable  
 Add \$142.00 list to above prices.



# Extended Corner Hutches

EXTENDED CORNER HUTCHES	Model	Size (WDH)	Wt./Cube	LPL 1"	1-1/2"	H/P Door Fronts
-------------------------	-------	------------	----------	--------	--------	-----------------



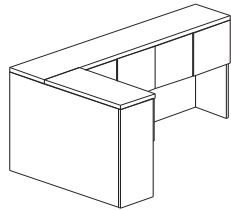
**Left Extended Corner Hutch Open - 43" Height**

CTDOH8436T(L)(X)(#)(*)	84x36x43	218/39.0	1,708	1,752		
CTDOH7836T(L)(X)(#)(*)	78x36x43	209/37.0	1,586	1,629		
CTDOH7236T(L)(X)(#)(*)	72x36x43	200/35.0	1,433	1,505		
CTDOH6636T(L)(X)(#)(*)	66x36x43	191/33.0	1,280	1,374		
CTDOH6036T(L)(X)(#)(*)	60x36x43	182/31.0	1,217	1,273		

*Note: CTDO's have 14" of clearance between shelves and 25" from table.*

*\* For right hand corner hutches, change (L) to (R) in model number.*

Above cabinet available with optional divider holes. To include add (DIV) to model number and \$158.00 to list price.



**Right Extended Corner Hutch With Doors 43" Height**

CTDOH8436TC(R)(X)(#)(*)	84x36x43	247/39.0	2,003	2,108	246	
CTDOH7836TC(R)(X)(#)(*)	78x36x43	236/37.0	1,881	1,947	246	
CTDOH7236TC(R)(X)(#)(*)	72x36x43	225/35.0	1,692	1,786	222	
CTDOH6636TC(R)(X)(#)(*)	66x36x43	214/33.0	1,526	1,663	222	
CTDOH6036TC(R)(X)(#)(*)	60x36x43	203/31.0	1,519	1,561	222	

Available with framed glazed doors, clear or frosted glazing option . See below to order.

*Note: CTDO's have 14" of clearance between shelves and 25" from table.*

*\* For right hand corner hutches, change (L) to (R) in model number.*

**Ordering Details:**

(X) - Specify 'M1' for 1" LPL or 'M2' for 1-1/2" LPL,.  
 (#) - Specify 'H' for HPL doors and add upcharge in right column.

**Options:**

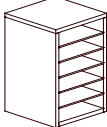
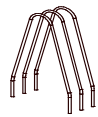
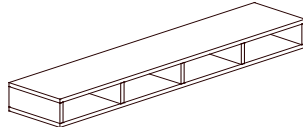
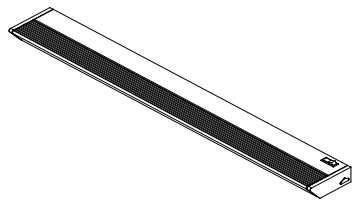
Custom sizes are available. Please call for details and pricing.

For glazed framed doors with frosted glazing: (only on models with hinged doors):

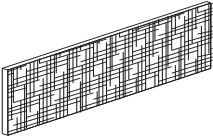
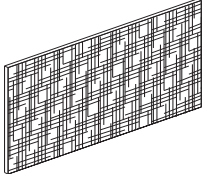
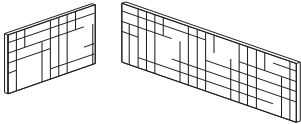
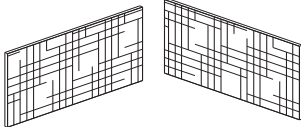
- (1) indicate by adding "GG" to model number,
- (2) add 609.00 to list prices.

(\*) - For recessed gable option specify 'L' left or 'R' right for recessed gable  
 Add \$142.00 list to above prices.

# Hutch Accessories & Options

HUTCH UNIT ACCESSORIES & OPTIONS	Model	Size (WDH)	Wt./Cube	Price
 <p><b>Vertical Pigeon Holes</b></p>	VPLG18	18x12x19	30/3.1	357
	VPLT12	12x12x19	26/2.3	326
<i>Available for 37" high hutches.</i>				
<p><b>Vertical Pigeon Holes</b></p>	VPLG18H	18x12x25	30/3.1	567
	VPLT12H	12x12x25	26/2.3	326
<i>Available for 43" high hutches.</i>				
<i>Available in any LPL color.</i>				
 <p><b>Wire Dividers (set of 4)</b></p>	PH-SD5			30
	<i>Specify part number on which to install dividers.</i>			
 <p><b>Horizontal Pigeon Holes</b></p>	HPH82	82x12x4	45/4.0	374
	HPH76	76x12x4	39/3.8	350
	HPH70	70x12x4	36/2.6	337
	HPH64	64x12x4	33/2.4	330
	HPH58	58x12x4	30/2.2	326
	HPH52	52x12x4	27/2.0	317
	HPH46	46x12x4	24/1.8	313
	HPH40	40x12x4	21/1.5	285
	HPH34	34x12x4	18/1.3	272
	<i>Must be ordered at the same time as hutch, cannot be field installed.</i>			
<i>Available in any LPL color.</i>				
 <p><b>Casegoods Task Light</b></p>	CTL3036	24x8x2	8.25/0.6	132
	CTL4248	36x8x2	11.0/0.9	181
	CTL60	48x8x2	13.0/1.1	236
<i>For hutches and wall mounted cabinets.</i>				
<i>2 - 18" vertical wire manager is included with each light.</i>				

# Tackboards

HUTCH TACKBOARDS	Model	Size (WDH)	Wt./Cube (KD)	Grade 3	Grade 4 COM
 <p><b>Reception Desk Hutch Tackboard</b></p>	TK84RDO(*)	82.5x11	10.5/1.1	299	357
	TK78RDO(*)	76.5x11	10/1.0	277	332
	TK72RDO(*)	70.5x11	9.5/0.90	255	308
	TK66RDO(*)	64.5x11	8.6/0.85	227	277
	TK60RDO(*)	58.5x11	7.8/0.75	200	246
	TK54RDO(*)	52.5x11	7/0.7	189	234
	TK48RDO(*)	46.5x11	6.3/0.60	172	215
	TK42RDO(*)	40.5x11	5.5/0.55	161	204
	TK36RDO(*)	34.5x11	4.7/0.45	144	185
	TK30RDO(*)	28.5x11	4/0.40	139	179
TK24RDO(*)	22.5x11	3/0.30	133	172	
 <p><b>Tackboard for 37" Height Hutch</b></p>	TK84TDO(*)	82.5x18	23/2.2	310	369
	TK78TDO(*)	76.5x18	21/2.0	288	344
	TK72TDO(*)	70.5x18	19/1.8	266	320
	TK66TDO(*)	64.5x18	18/1.7	238	289
	TK60TDO(*)	58.5x18	16/1.5	211	258
	TK54TDO(*)	52.5x18	14/1.4	194	240
	TK48TDO(*)	46.5x18	13/1.2	183	228
	TK42TDO(*)	40.5x18	11/1.1	172	215
	TK36TDO(*)	34.5x18	9/0.90	155	197
	TK30TDO(*)	28.5x18	8/0.80	150	191
TK24TDO(*)	22.5x18	6/0.60	144	185	
 <p><b>Extended Corner Tackboard for 37" Height Hutch</b></p>	TK8436CTDO(*)	84x36x18	49/3.2	509	614
	TK7836CTDO(*)	78x36x18	43/3.0	465	566
	TK7236CTDO(*)	72x36x18	38/2.8	421	517
	TK6636CTDO(*)	66x36x18	34/2.6	399	491
	TK6036CTDO(*)	60x36x18	30/2.4	377	467
 <p><b>Symmetrical Corner Tackboard for 37" Height Hutch</b></p>	TK4730CTDO(*)	46.25x18	26/1.9	455	480
	TK4124CTDO(*)	40.25x18	22/1.7	406	431
	TK3518CTDO(*)	34.25x18	20/1.3	375	400

**Ordering Details:**

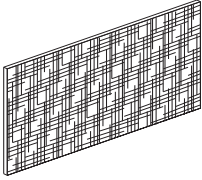
(\*) - Specify Grade 3 or COM for customer supplied fabrics  
 Call customer service for COM pricing and details.

**Note:**

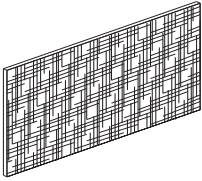
Custom styles and sizes for other purposes are available. Please call for details and pricing. Consult the finish guide for standard available fabric colours.

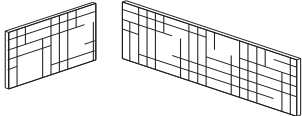
BRC does not warranty material, construction or labour on materials that are not supplied by BRC.

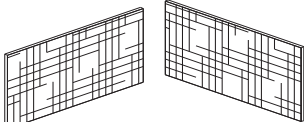
# Tackboards

HUTCH TACKBOARDS with and without Post System	Model	Size (WDH)	Wt./Cube (KD)	Grade 3	Grade 4 COM
 <p><b>Post Mounted Hutch Tackboard</b> (Tackboard on one side only; includes 3/4" melamine support backer)</p>	TK8419HTPSLF(*)	75x19	23/2.2	632	689
	TK7819HTPSLF(*)	69x19	21/2.0	610	671
	TK7219HTPSLF(*)	63x19	19/1.8	588	647
	TK6619HTPSLF(*)	57x19	18/1.7	561	616
	TK6019HTPSLF(*)	51x19	16/1.5	533	586
	TK5419HTPSLF(*)	45x19	14/1.4	487	536
	TK4819HTPSLF(*)	39x19	13/1.2	459	504
	TK4219HTPSLF(*)	33x19	11/1.1	422	464
	TK3619HTPSLF(*)	27x19	9/.90	379	417
	TK3019HTPSLF(*)	21x19	8/.80	374	412
TK2419HTPSLF(*)	15x19	6/.60	369	405	

Item is for post mounted hutch only. For post mounted tackboards without hutch see pages 130-132.

 <p><b>Tackboard for 43" Height Hutch</b></p>	TK84HTDO(*)	82.5x24	23/2.2	445	502
	TK78HTDO(*)	76.5x24	21/2.0	423	477
	TK72HTDO(*)	70.5x24	19/1.8	401	453
	TK66HTDO(*)	64.5x24	18/1.7	374	421
	TK60HTDO(*)	58.5x24	16/1.5	347	286
	TK54HTDO(*)	52.5x24	14/1.4	330	373
	TK48HTDO(*)	46.5x24	13/1.2	301	341
	TK42HTDO(*)	40.5x24	11/1.1	291	330
	TK36HTDO(*)	34.5x24	9/.90	274	311
	TK30HTDO(*)	28.5x24	8/.80	269	305
TK24HTDO(*)	22.5x24	6/.60	264	298	

 <p><b>Extended Corner Tackboard for 43" Height Hutch</b></p>	TK8436CHTDO(*)	84x36x24	49/3.2	642	737
	TK7836CHTDO(*)	78x36x24	43/3.0	597	689
	TK7236CHTDO(*)	72x36x24	38/2.8	553	639
	TK6636CHTDO(*)	66x36x24	34/2.6	531	614
	TK6036CHTDO(*)	60x36x24	30/2.4	509	590

 <p><b>Symmetrical Corner Tackboard for 43" Height Hutch</b></p>	TK4730CHTDO(*)	46.25x24	26/1.9	578	603
	TK4124CHTDO(*)	40.25x24	22/1.7	529	553
	TK3518CHTDO(*)	34.25x24	20/1.3	498	523

**Ordering Details:**

(\*) - Specify Grade 3 or COM for customer supplied fabrics  
Call customer service for COM pricing and details.

**Note:**

Custom styles and sizes for other purposes are available. Please call for details and pricing. Consult the finish guide for standard available fabric colours.

BRC does not warranty material, construction or labour on materials that are not supplied by BRC.

# Storage Specifications

## **STORAGE UNITS**

Laminate base available per BRC finish guide.

Edges are rigid PVC (2.5mm) thick, and are available in selections from BRC finish guide.

Drawer and door handles are black or silver, per BRC finish guide.

All tops are available in LPL 1" or 1-1/2" thick and are available in a variety of finishes. Refer to the BRC finish guide for more information.

All file drawers have 100lbs rated ball-bearing suspension, all lateral file drawers have 150lbs rated steel ball-bearing suspension.

All free standing lateral file units have a safety interlock system to prevent more than one drawer from opening at a time.

Locks are standard on all storage units. On certain 84" high units locks may be placed at top of unit due to cabinet design.

All product shipped assembled.

### Key alike and Other Key Options:

Contact customer service for options.

Locks will be randomly keyed with cores installed, unless "keyed alike" is specified on the order.

### Available options:

Framed doors with frosted glazing - available on all hinged and sliding doors. Some units may not accommodate locks.

Shelves for storage units.

# Bookcase & Storage Specifications

## PRODUCT DETAILS

1. 2, 3 or 4 drawer laterals with lock, 20" deep, 30", 36" or 42" wide and 29", 42" or 56" high.
2. Storage cupboard with lock, 20" deep, 18", 24", 30" and 36" wide, and 29", 36" and 48" high.
3. Bookcase 2, 3, 4 and 5 shelf, 12" or 15" deep, 24", 30", 36" or 42" wide, 29", 48", 60", 66", 72" or 84" high 3/4" case construction with 1" shelves.
4. Executive bookcase, with or without doors, 20" or 24" deep, 24" or 36" wide and 66" or 84" high
5. Wardrobe, 20" or 24" deep, 24", 30" or 36" wide and 66" or 84" high.
6. Combination wardrobe/bookcase, 20" or 24" deep, 24", 30" or 36" wide and 66" or 84" high.

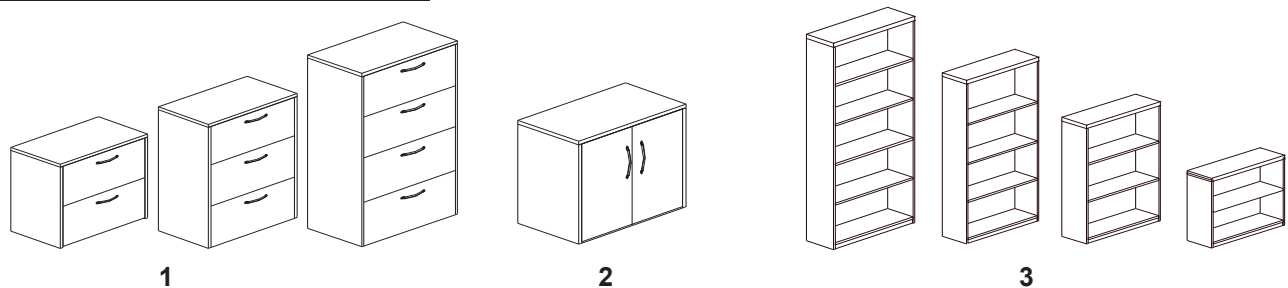
side, 20" or 24" deep, 24" or 36" wide and 66" or 84" high.

8. Wardrobe storage combo 2 file drawers, 2 box drawers and 1 storage unit on one side, wardrobe on opposite side, 20" or 24" deep, 24" or 36" wide and 66" or 84" high.
9. Lateral combination, with or without doors, 2 lateral file drawers plus storage, 20" or 24" deep 24" or 36" wide and 66" or 84" high.
10. Wardrobe with open storage, ped and locks. 20" or 24" deep, 20" or 24" wide, 66", 72" or 84" high.
11. Lateral combination, as above but with 3 lateral file drawers.

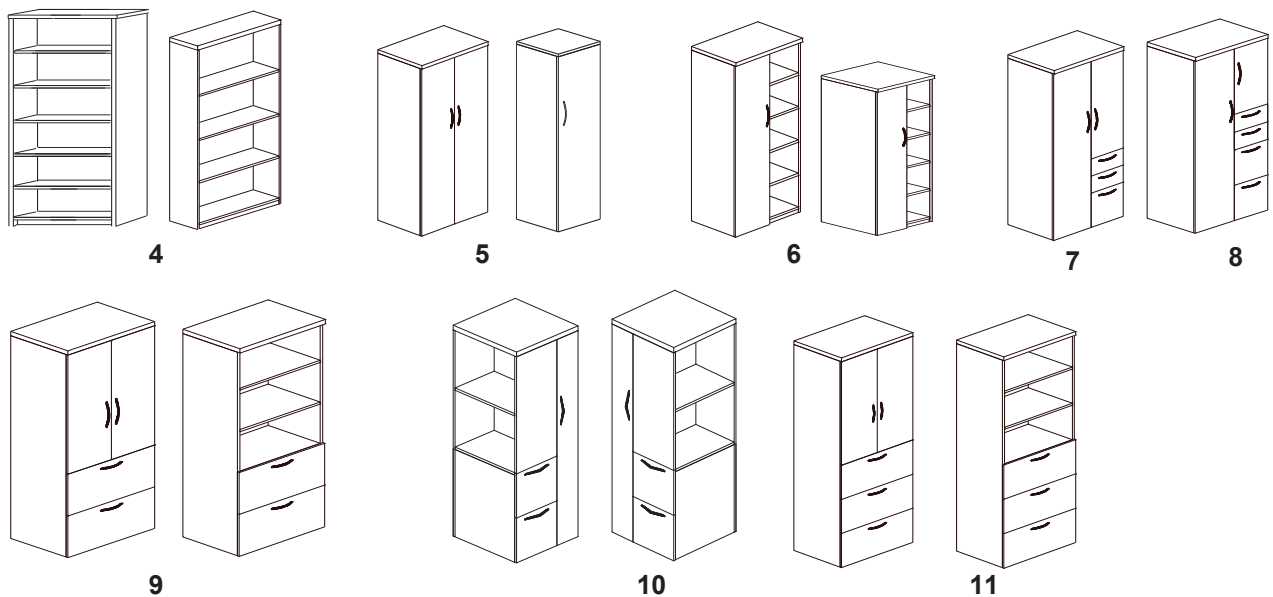
Storage products over 72" must be secured to an additional support structure (eg. wall).

All product shipped assembled.

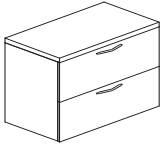
## Lateral Files. Storage and Bookcases



## Executive Depth Storage



# Lateral Files

LATERAL FILES	Model	Size (WDH)	Wt./Cube	LPL		HPL		H/P Fronts
				1"	1-1/2"	1-1/8"	1-1/2"	
	LAT(2)4220(X)(#)	42x20x29	135/16.0	1,154	1,277	1,216	1,364	154
	LAT(2)3620(X)(#)	36x20x29	115/14.0	737	903	842	1,014	154
	LAT(2)3020(X)(#)	30x20x29	95/12.6	719	855	795	974	154
	LAT(2)4224(X)(#)	42x24x29	140/20.5	1,240	1,363	1,302	1,450	154
	LAT(2)3624(X)(#)	36x24x29	120/17.2	775	950	1,019	1,172	154
	LAT(2)3024(X)(#)	30x24x29	115/14.0	737	941	881	1,061	154

**Two Drawer**

*Lateral file interlock (anti-tilt) allows only one drawer to open at a time. Locks included.*



LAT(3)4220(X)(#)	42x20x42	165/20.4	1,264	1,387	1,339	1,462	308
LAT(3)3620(X)(#)	36x20x42	145/17.5	1,141	1,264	1,216	1,339	308
LAT(3)3020(X)(#)	30x20x42	125/14.6	1,029	1,152	1,103	1,225	308

**Three Drawer**

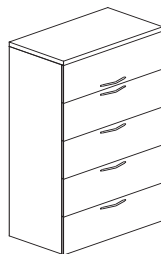
*Lateral file interlock (anti-tilt) allows only one drawer to open at a time. Locks included.*



LAT(4)4220(X)(#)	42x20x56	300/32.0	1,607	1,730	1,681	1,803	431
LAT(4)3620(X)(#)	36x20x56	268/28.0	1,484	1,607	1,558	1,681	431
LAT(4)3020(X)(#)	30x20x56	240/24.0	1,370	1,493	1,443	1,566	431

**Four Drawer**

*Lateral file interlock (anti-tilt) allows only one drawer to open at a time. Locks included. Four high lateral includes counterweight.*



LAT(5)4220(X)(#)	42x20x66	440/47.0	2,657	2,780	2,731	2,853	431
LAT(5)3620(X)(#)	36x20x66	408/43.0	2,429	2,552	2,503	2,626	431
LAT(5)3020(X)(#)	30x20x66	340/39.0	2,210	2,333	2,283	2,406	431

**Five Drawer**

*Lateral file interlock (anti-tilt) allows only one drawer to open at a time. Locks included. Five high lateral includes counterweight.*

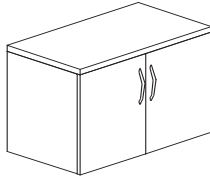
**Ordering Details:** (X) - Specify 'M1' for 1" LPL, 'M2' for 1-1/2" LPL, 'H1' for 1-1/8" HPL, or 'H2' for 1-1/2" HPL.  
Metal lateral files are available by special order. Please call for details and pricing.

**Options:** (#) - Specify 'H' for HPL doors and add upcharge in right column. Metal lateral files are available by special order. Please call for details and pricing.

**Note:** BRC strongly recommends that four and five drawer lateral files be secured to additional support structure.

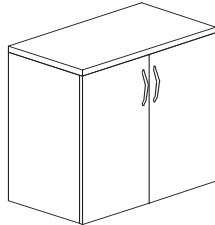
# Closed Storage

EXECUTIVE CLOSED STORAGE	Model	Size (WDH)	Wt./Cube	LPL		HPL		H/P Fronts
				1"	1-1/2"	1-1/8"	1-1/2"	



SC362029(X)(#)	36x20x29	100/15.9	565	650	725	811	154
SC362429(X)(#)	36x24x29	104/16.9	622	715	797	891	154
SC302029(X)(#)	30x20x29	90/12.6	523	609	683	769	154
SC302429(X)(#)	30x24x29	94/13.6	575	670	751	845	154
SC242029(X)(#)	24x20x29	80/10.5	498	590	652	749	154
SC242429(X)(#)	24x24x29	84/11.5	547	649	716	823	154
SC182029(X)(#)	18x20x29	76/9.8	486	568	627	732	154
SC182429(X)(#)	18x24x29	80/10.8	534	625	690	805	154

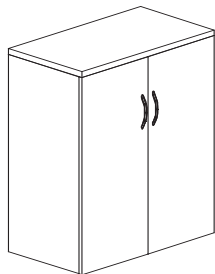
Available with framed doors and clear or frosted glazing option. See below to order.



SC362036(X)(#)	36x20x36	145/17.5	769	874	735	938	369
SC362436(X)(#)	36x24x36	149/18.5	845	961	809	1,031	369
SC302036(X)(#)	30x20x36	125/14.6	672	777	832	840	369
SC302436(X)(#)	30x24x36	129/15.6	739	855	915	924	369
SC362042(X)(#)	36x20x42	145/17.5	896	1,019	970	1,093	369
SC362442(X)(#)	36x24x42	149/18.5	985	1,120	1,067	1,171	369
SC302042(X)(#)	30x20x42	125/14.6	783	906	857	980	369
SC302442(X)(#)	30x24x42	129/15.6	862	996	943	1,077	369

Available with framed doors and clear or frosted glazing option. See below to order.

Above sizes include two adjustable shelves.



SC362054(X)(#)	36x20x54	268/28.0	1,084	1,206	1,158	1,281	491
SC362454(X)(#)	36x24x54	272/29.0	1,192	1,327	1,274	1,409	491
SC302054(X)(#)	30x20x54	240/24.0	970	1,093	1,044	1,167	491
SC302454(X)(#)	30x24x54	244/25.0	1,088	1,202	1,148	1,283	491
SC362056(X)(#)	36x20x56	268/28.0	1,084	1,206	1,158	1,281	491
SC362456(X)(#)	36x24x56	272/29.0	1,192	1,327	1,274	1,409	491
SC302056(X)(#)	30x20x56	240/24.0	970	1,093	1,044	1,167	491
SC302456(X)(#)	30x24x56	244/25.0	1,088	1,202	1,148	1,283	491

Available with framed doors and clear or frosted glazing option. See below to order.

Above sizes include three adjustable shelves.

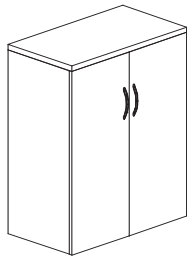
**Ordering Details:**

(X) - Specify 'M1' for 1" LPL, 'M2' for 1-1/2" LPL, 'H1' for 1-1/8" HPL, or 'H2' for 1-1/2" HPL. (#) - Specify 'H' for HPL doors and add upcharge in right column.



# Closed Storage

EXECUTIVE CLOSED STORAGE	Model	Size (WDH)	Wt./Cube	LPL		HPL		H/P Fronts
				1"	1-1/2"	1-1/8"	1-1/2"	



SC362060(X)(#)	36x20x60	268/28.0	1,206	1,329	1,281	1,404	491
SC362460(X)(#)	36x24x60	272/29.0	1,327	1,463	1,409	1,478	491
SC302060(X)(#)	30x20x60	240/24.0	1,093	1,216	1,167	1,289	491
SC302460(X)(#)	30x24x60	244/25.0	1,202	1,338	1,283	1,419	491

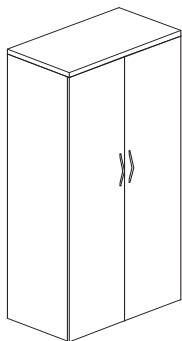
**Available with framed glazed doors, clear or frosted glazing option . See below to order.**

*Above sizes include three adjustable shelves.*

SC362066(X)(#)	36x20x66	293/38.7	1,287	1,410	1,362	1,485	491
SC362466(X)(#)	36x24x66	287/34.4	1,410	1,545	1,492	1,626	491
SC302066(X)(#)	30x20x66	273/37.7	1,174	1,297	1,247	1,370	491
SC302466(X)(#)	30x24x66	277/35.4	1,285	1,421	1,366	1,502	491

**Available with framed glazed doors, clear or frosted glazing option . See below to order.**

*Above sizes include four adjustable shelves.*



SC362072(X)(#)	36x20x72	293/38.7	1,329	1,452	1,404	1,527	491
SC362472(X)(#)	36x24x72	287/34.4	1,463	1,597	1,545	1,679	491
SC302072(X)(#)	30x20x72	273/37.7	1,216	1,339	1,289	1,412	491
SC302472(X)(#)	30x24x72	277/35.4	1,338	1,473	1,419	1,554	491

**Available with framed glazed doors, clear or frosted glazing option . See below to order.**

*Above sizes include four adjustable shelves.*

SC362084(X)(#)	36x20x84	372/49.2	1,452	1,575	1,527	1,650	491
SC362484(X)(#)	36x24x84	365/41.6	1,597	1,733	1,679	1,814	491
SC302084(X)(#)	30x20x84	362/48.2	1,339	1,462	1,412	1,535	491
SC302484(X)(#)	30x24x84	355/40.6	1,473	1,608	1,554	1,688	491

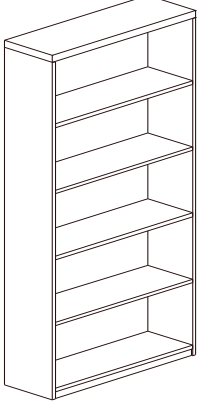
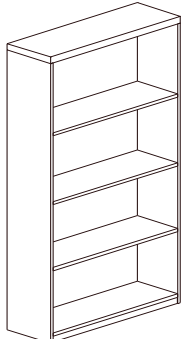
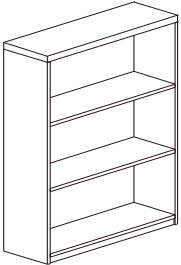
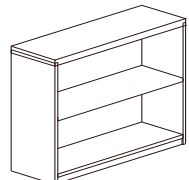
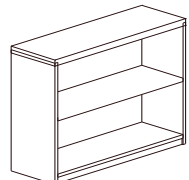
**Available with framed glazed doors, clear or frosted glazing option . See below to order.**

*Above sizes include four adjustable shelves and 1 fixed.*

**Note:** Storage products over 72" must be secured to an additional support structure (eg. wall).

**Ordering Details:** (X) - Specify 'M1' for 1" LPL, 'M2' for 1-1/2" LPL, 'H1' for 1-1/8" HPL, or 'H2' for 1-1/2" HPL. (#) - Specify 'H' for HPL doors and add upcharge in right column.

# Bookcases

STANDARD BOOKCASES	Model	Size (WDH)	Wt./Cube	LPL Top	
				1"	1-1/2"
<b>3/4" Thick Case Construction, with 1" Shelves - 12" Deep</b>					
	BCMD3684(X)	36x12x84	200/21.0	725	778
	BCMD3084(X)	30x12x84	180/18.0	704	757
	BCMD2484(X)	24x12x84	170/15.0	624	677
	<i>Bookcases above contain four adjustable shelves and one fixed shelf.</i>				
	BCMD3672(X)	36x12x72	160/19.0	568	643
	BCMD3072(X)	30x12x72	130/16.0	547	623
	BCMD2472(X)	24x12x72	130/13.0	529	604
	<i>Bookcases above contain three adjustable shelves and one fixed shelf.</i>				
	BCMD3666(X)	36x12x66	140/13.0	501	597
BCMD3066(X)	30x12x66	135/12.0	468	566	
BCMD2466(X)	24x12x66	118/17.0	442	539	
<i>Bookcases above contain three adjustable shelves and one fixed shelf.</i>					
	BCMD3660(X)	36x12x60	138/16.0	486	583
	BCMD3060(X)	30x12x60	130/13.0	454	551
	BCMD2460(X)	24x12x60	105/11.0	426	524
	<i>Bookcases above contain three adjustable shelves.</i>				
	BCMD3648(X)	36x12x48	100/13.0	426	512
	BCMD3048(X)	30x12x48	95/10.0	397	483
BCMD2448(X)	24x12x48	85/8.0	373	459	
<i>Bookcases above contain three adjustable shelves.</i>					
	BCMD3642(X)	36x12x42	100/10.0	508	444
	BCMD3042(X)	30x12x42	95/7.0	391	419
	BCMD2442(X)	24x12x42	85/5.0	378	363
	<i>Bookcases above contain two adjustable shelves.</i>				
	BCMD3636(X)	36x12x36	100/10.0	361	402
	BCMD3036(X)	30x12x36	95/7.0	349	377
	BCMD2426(X)	24x12x36	85/5.0	336	321
	<i>Bookcases above contain two adjustable shelf.</i>				
	BCMD3629(X)	36x12x29	100/10.0	319	360
	BCMD3029(X)	30x12x29	95/7.0	307	335
	BCMD2429(X)	24x12x29	85/5.0	294	321
<i>Bookcases above contain one adjustable shelf.</i>					

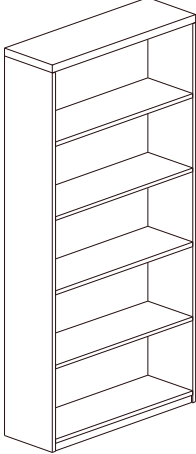
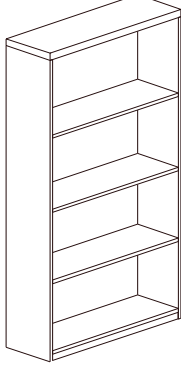
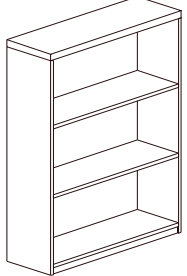
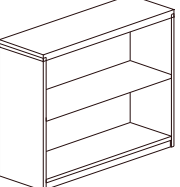
**Ordering Details:**

(X) - Specify 'M1' for 1" LPL or 'M2' for 1-1/2" LPL. 1" thick shelves are standard.

**Note:**

Storage products over 72" must be secured to an additional support structure (eg. wall).

# Bookcases

HEAVY DUTY BOOKCASES	Model	Size (WDH)	Wt./Cube	LPL Top		
				1"	1-1/2"	
<b>3/4" Thick Case Construction, with 1" Shelves - 15" Deep</b>	BCHD3684(X)	36x15x84	210/21.0	873	928	
	BCHD3084(X)	30x15x84	190/18.0	840	914	
	BCHD2484(X)	24x15x84	180/15.0	772	834	
	<i>Bookcases above contain four adjustable shelves and one fixed shelf.</i>					
	BCHD4272(X)	42x15x72	165/20.0	1,006	1,075	
	BCHD3672(X)	36x15x72	160/19.0	775	844	
	BCHD3072(X)	30x15x72	130/16.0	754	815	
	BCHD2472(X)	24x15x72	130/13.0	674	735	
	<i>Bookcases above contain three adjustable shelves and one fixed shelf.</i>					
	BCHD4266(X)	42x15x66	145/14.0	996	1,067	
BCHD3666(X)	36x15x66	140/13.0	765	836		
BCHD3066(X)	30x15x66	135/15.0	751	813		
BCHD2466(X)	24x15x66	118/17.0	664	726		
<i>Bookcases above contain three adjustable shelves and one fixed shelf.</i>						
	BCHD4263(X)	42x15x63	148/17.4	987	1,061	
	BCHD4260(X)	42x15x60	148/17.0	966	1,040	
	BCHD3660(X)	36x15x60	138/16.0	756	830	
	BCHD3060(X)	30x15x60	130/13.0	748	809	
	BCHD2460(X)	24x15x60	105/11.0	653	714	
	<i>Bookcases above contain three adjustable shelves.</i>					
		BCHD4248(X)	42x15x48	105/14.0	944	1,006
		BCHD3648(X)	36x15x48	100/13.0	713	775
		BCHD3048(X)	30x15x48	95/10.0	684	746
		BCHD2448(X)	24x15x48	85/8.0	623	684
<i>Bookcases above contain three adjustable shelves.</i>						
BCHD4242(X)		42x15x42	105/11.0	916	1,014	
BCHD3642(X)		36x15x42	100/10.0	685	783	
BCHD3042(X)		30x15x42	95/7.0	659	733	
BCHD2442(X)		24x15x42	85/5.0	534	633	
<i>Bookcases above contain two adjustable shelves.</i>						
	BCHD4236(X)	42x15x36	105/11.0	811	909	
	BCHD3636(X)	36x15x36	100/10.0	580	678	
	BCHD3036(X)	30x15x36	95/7.0	554	628	
	BCHD2436(X)	24x15x36	85/5.0	429	528	
	<i>Bookcases above contain two adjustable shelf.</i>					
		BCHD4229(X)	42x15x29	105/11.0	706	804
		BCHD3629(X)	36x15x29	100/10.0	475	573
		BCHD3029(X)	30x15x29	95/7.0	449	523
		BCHD2429(X)	24x15x29	85/5.0	324	423
		<i>Bookcases above contain one adjustable shelf.</i>				

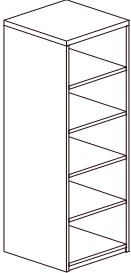
**Ordering Details:**

(X) - Specify 'M1' for 1" LPL or 'M2' for 1-1/2" LPL. 1" thick shelves are standard

**Note:**

Storage products over 72" must be secured to an additional support structure (eg. wall).

# Executive Storage

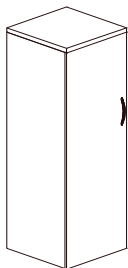
EXECUTIVE DEPTH BOOKCASES - 24" WIDE	Model	Size (WDH)	Wt./Cube	LPL Top		H/P Door Fronts
				1"	1-1/2"	
	XBC-242484(X)	24x24x84	246/33.6	891	952	
	XBC-242084(X)	24x20x84	235/28.4	823	885	
	<i>Bookcases above contain four adjustable shelves and one fixed shelf</i>					
	XBC-242472(X)	24x24x72	194/26.0	812	873	
	XBC-242072(X)	24x20x72	183/24.2	743	805	
	XBC-242466(X)	24x24x66	194/26.0	737	799	
	XBC-242066(X)	24x20x66	183/24.2	670	732	

**Open Bookcase - 24" Wide** *Bookcases above contain four adjustable shelves.*



XBC-242484HR(X)(#)	24x24x84	278/33.6	1,400	1,462	308
XBC-242084HR(X)(#)	24x20x84	264/28.4	1,346	1,407	308
<i>Bookcases above contain four adjustable shelves and one fixed shelf</i>					
XBC-242472HR(X)(#)	24x24x72	278/33.6	1,376	1,419	308
XBC-242072HR(X)(#)	24x20x72	264/28.4	1,216	1,277	308

**Closed Bookcase  
Hinged Right 24" Wide**



XBC-242466HR(X)(#)	24x24x66	219/26.0	1,007	1,068	308
XBC-242066HR(X)(#)	24x20x66	208/24.2	970	1,031	308
<i>Available with framed glazed doors, clear or frosted glazing option . See below to order.</i>					
<i>Bookcases above contain four adjustable shelves.</i>					

**Closed Bookcase  
Hinged Left 24" Wide**

XBC-242484HL(X)(#)	24x24x84	278/33.6	1,400	1,462	308
XBC-242084HL(X)(#)	24x20x84	264/28.4	1,346	1,407	308
<i>Bookcases above contain four adjustable shelves and one fixed shelf</i>					
XBC-242472HL(X)(#)	24x24x72	219/26.0	1,376	1,419	308
XBC-242072HL(X)(#)	24x20x72	208/24.2	1,216	1,277	308

XBC-242466HL(X)(#)	24x24x66	219/26.0	1,007	1,068	308
XBC-242066HL(X)(#)	24x20x66	208/24.2	970	1,031	308
<i>Available with framed glazed doors, clear or frosted glazing option . See below to order.</i>					
<i>Bookcases above contain four adjustable shelves.</i>					

**Ordering Details:**

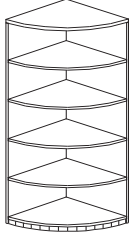
(X) - Specify 'M1' for 1" LPL or 'M2' for 1-1/2" LPL.  
 (#) - Specify 'H' for HPL door fronts, and add charge in right column.

**Note:**

Storage products over 72" must be secured to an additional support structure (eg. wall).

# Executive Storage

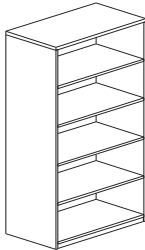
EXECUTIVE DEPTH BOOKCASES	Model	Size (WDH)	Wt./Cube	LPL Top		H/P Door Fronts
				1"	1-1/2"	



**Tower, Radiused End  
Open Storage with Base**

TRE242484(X)	24x24x84	125/38.7	842	915
TRE202084(X)	20x20x84	105/34.4	739	789
TRE242472(X)	24x24x72	125/38.7	721	794
TRE202072(X)	20x20x72	105/34.4	618	668
TRE242466(X)	24x24x66	125/38.7	601	673
TRE202066(X)	20x20x66	105/34.4	498	547
<i>66" and 72" towers contain four adjustable shelves, 84" towers have four adjustable shelves and one fixed shelf</i>				
XBC-362484(X)	36x24x84	296/49.2	1,027	1,111
XBC-362084(X)	36x20x84	288/41.6	900	985
XBC-302484(X)	30x24x84	288/48.2	964	1,048
XBC-302084(X)	30x20x84	280/40.6	837	922

*Bookcases above contain four adjustable shelves and one fixed shelf.*



**Open Bookcase**

XBC-362472(X)	36x24x72	233/38.7	966	1,051
XBC-362072(X)	36x20x72	227/34.4	900	985
XBC-302472(X)	30x24x72	225/37.7	903	988
XBC-302072(X)	30x20x72	219/33.4	837	922
<i>Bookcases above contain four adjustable shelves.</i>				
XBC-362466(X)	36x24x66	233/38.7	876	961
XBC-362066(X)	36x20x66	227/34.4	810	894
XBC-302466(X)	30x24x66	225/37.7	813	898
XBC-302066(X)	30x20x66	219/33.4	747	831

*Bookcases above contain four adjustable shelves.*

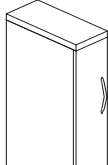
**Ordering Details:**

- (X) - Specify 'M1' for 1" LPL or 'M2' for 1-1/2" LPL.
- (#) - Specify 'H' for HPL door fronts, and add charge in right column.

**Note:**

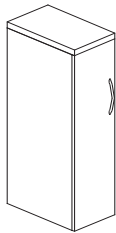
Storage products over 72" must be secured to an additional support structure (eg. wall).

# Executive Storage

EXECUTIVE WARDROBES	Model	Size (WDH)	Wt./Cube	LPL Top		H/P Door Fronts
				1"	1-1/2"	
	XW92454HL(X)(#)	9x24x54	203/19.8	780	840	350
	XW92054HL(X)(#)	9x20x54	192/19.2	730	780	350
	XW92448HL(X)(#)	9x24x48	203/19.8	739	799	350
	XW92048HL(X)(#)	9x20x48	192/19.2	689	739	350

**Wardrobe Hinged Left  
9" Wide**

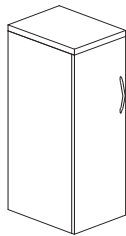
Available with framed glazed doors, clear or frosted glazing option . See below to order.  
*Above wardrobes contain one fixedshelf and one hanger bar.*  
 Specify 'HR' for Hinged Right.  
 Extra shelf 9" wide add \$47.00 list each.  
 Unit must be secured to the wall or other.



XW122454HL(X)(#)	12x24x54	207/22.0	810	870	375
XW122054HL(X)(#)	12x20x54	196/21.2	760	820	375
XW122448HL(X)(#)	12x24x48	207/22.0	759	819	375
XW122048HL(X)(#)	12x20x48	196/21.2	709	769	375

**Wardrobe Hinged Left  
12" Wide**

Available with framed glazed doors, clear or frosted glazing option . See below to order.  
*Above wardrobes contain one fixedshelf and one hanger bar.*  
 Specify 'HR' for Hinged Right.  
 Extra shelf 12" wide add \$47.00 list each.  
 Unit must be secured to the wall or other.



XW152454HL(X)(#)	15.50x24x54	210/23.0	858	918	400
XW152054HL(X)(#)	15.50x20x54	199/22.8	808	868	400
XW152448HL(X)(#)	15.50x24x48	210/23.0	799	859	400
XW152048HL(X)(#)	15.50x20x48	199/22.8	749	809	400

**Wardrobe Hinged Left  
15.50" Wide**

Available with framed glazed doors, clear or frosted glazing option . See below to order.  
*Above wardrobes contain one fixedshelf and one hanger bar.*  
 Specify 'HR' for Hinged Right.  
 Extra shelf 15.50" wide add \$47.00 list each.

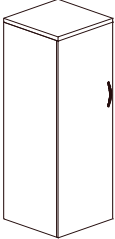
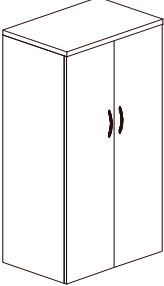
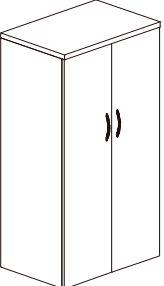
**Ordering Details:**

(X) - Specify 'M1' for 1" LPL or 'M2' for 1-1/2" LPL.  
 (#) - Specify 'H' for HPL door fronts, and add charge in right column.

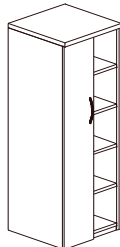
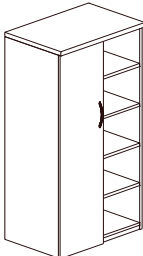
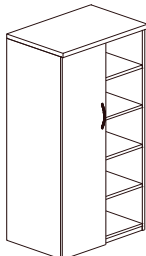
**Options:**

Custom sizes are available. Please call for details and pricing.

# Executive Storage

EXECUTIVE WARDROBES	Model	Size (WDH)	Wt./Cube	LPL Top		H/P Door Fronts	
				1"	1-1/2"		
 <p><b>Wardrobe Hinged Left 24" Wide</b></p>	XW242484HL(X)(#)	24x24x84	278/33.6	1,350	1,436	308	
	XW242084HL(X)(#)	24x20x84	264/28.4	1,247	1,334	308	
	<i>Above wardrobes contain one fixed shelf and one hanger bar.</i>						
	XW242472HL(X)(#)	24x24x72	219/26.0	1,203	1,289	308	
	XW242072HL(X)(#)	24x20x72	208/24.2	1,117	1,203	308	
	XW242466HL(X)(#)	24x24x66	219/26.0	958	1,044	308	
 <p><b>Wardrobe - 30" Wide</b></p>	XW302484(X)(#)	30x24x84	334/41.4	1,510	1,596	614	
	XW302084(X)(#)	30x20x84	321/35.0	1,390	1,476	614	
	<i>Above wardrobes contain one fixed shelf and one hanger bar.</i>						
	XW302472(X)(#)	30x24x72	263/32.7	1,385	1,466	491	
	XW302072(X)(#)	30x20x72	228.27.7	1,302	1,387	491	
	XW302466(X)(#)	30x24x66	263/32.7	1,078	1,163	491	
 <p><b>Wardrobe - 36" Wide</b></p>	XW362484(X)(#)	36x24x84	390/49.2	1,572	1,658	614	
	XW362084(X)(#)	36x20x84	378/41.6	1,451	1,537	614	
	<i>Above wardrobes contain one fixed shelf and one hanger bar.</i>						
	XW362472(X)(#)	36x24x72	307/38.7	1,324	1,409	491	
	XW362072(X)(#)	36x20x72	247/34.4	1,240	1,326	491	
	XW362466(X)(#)	36x24x66	307/38.7	1,139	1,225	491	
	XW362066(X)(#)	36x20x66	247/34.4	1,056	1,141	491	
<i>Available with framed glazed doors, clear or frosted glazing option . See below to order. Above wardrobes contain one fixed shelf and one hanger bar. Extra shelf Extra shelf 30" wide add \$58.00 list each.</i>							
<i>Available with framed glazed doors, clear or frosted glazing option . See below to order. Above wardrobes contain one fixed shelf and one hanger bar. Extra shelf Extra shelf 36" wide add \$63.00 list each.</i>							
<b>Ordering Details:</b>	(X) - Specify 'M1' for 1" LPL or 'M2' for 1-1/2" LPL. (#) - Specify 'H' for HPL door fronts, and add charge in right column.						
<b>Options:</b>	Custom sizes are available. Please call for details and pricing.						
<b>Note:</b>	Storage products over 72" must be secured to an additional support structure (eg. wall).						

# Executive Storage

EXECUTIVE WARDROBES/ OPEN STORAGE	Model	Size (WDH)	Wt./Cube	LPL Top		H/P Fronts	
				1"	1-1/2"		
 <p><b>Wardrobe/Bookcase 24" Wide</b></p>	XWBC242484(X)(#)	24x24x84	327/44.2	1,217	1,303	246	
	XWBC242084(X)(#)	24x20x84	316/41.6	1,180	1,266	246	
	<i>Bookcases above contain four adjustable shelves and one fixed shelf.</i>						
	XWBC242472(X)(#)	24x24x72	257/38.7	1,072	1,121	185	
	XWBC242072(X)(#)	24x20x72	249/34.4	973	1,011	185	
	XWBC242466(X)(#)	24x24x66	257/38.7	826	876	185	
 <p><b>Wardrobe/Bookcase 30" Wide</b></p>	XWBC302484(X)(#)	30x24x84	334/41.4	1,452	1,538	277	
	XWBC302084(X)(#)	30x20x84	321/35.0	1,372	1,458	277	
	<i>Bookcases above contain four adjustable shelves.</i>						
	XWBC302472(X)(#)	30x24x72	263/32.7	1,234	1,319	215	
	XWBC302072(X)(#)	30x20x72	228/27.7	1,168	1,244	215	
	XWBC302466(X)(#)	30x24x66	263/32.7	988	1,073	215	
 <p><b>Wardrobe/Bookcase 36" Wide</b></p>	XWBC362484(X)(#)	36x24x84	390/49.2	1,689	1,776	308	
	XWBC362084(X)(#)	36x20x84	378/41.6	1,567	1,653	308	
	<i>Bookcases above contain four adjustable shelves and one fixed shelf.</i>						
	XWBC362472(X)(#)	36x24x72	307/38.7	1,520	1,638	246	
	XWBC362072(X)(#)	36x20x72	247/34.4	1,484	1,597	246	
	XWBC362466(X)(#)	36x24x66	307/38.7	1,152	1,269	246	
<p><b>Ordering Details:</b></p> <p>(X) - Specify 'M1' for 1" LPL or 'M2' for 1-1/2" LPL.                  (#) - Specify 'H' for HPL door fronts, and add charge in right column.</p>							
<p><b>Note:</b> Storage products over 72" must be secured to an additional support structure (eg. wall).</p>							



# Executive Storage

EXECUTIVE WARDROBES/CLOSED STORAGE	Model	Size (WDH)	Wt./Cube	LPL Top		H/P Fronts
				1"	1-1/2"	



**Wardrobe/Bookcase  
24" Wide**

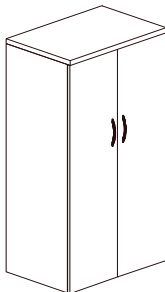
XWBC242484D(X)(#)	24x24x84	327/44.2	1,479	1,566	491	
XWBC242084D(X)(#)	24x20x84	316/41.6	1,443	1,529	491	
<i>Bookcases above contain four adjustable shelves and one fixed shelf.</i>						
XWBC242472D(X)(#)	24x24x72	257/38.7	1,335	1,384	491	
XWBC242072D(X)(#)	24x20x72	249/34.4	1,236	1,274	491	
XWBC242466D(X)(#)	24x24x66	257/38.7	1,089	1,138	491	
XWBC242066D(X)(#)	24x20x66	249/34.4	990	1,028	491	

Available with framed glazed door, clear or frosted option. See below to order.

*Bookcases above contain four adjustable shelves.*

*Model number indicates wardrobe with hanger bar on left and bookcase on right.*

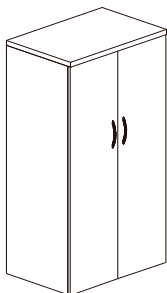
*Reverse configuration is available - specify 'XBCW', Bookcase Left, Wardrobe Right.*



**Wardrobe/Bookcase  
30" Wide**

XWBC302484D(X)(#)	30x24x84	334/41.4	1,715	1,801	491
XWBC302084D(X)(#)	30x20x84	321/35.0	1,635	1,721	491
XWBC302472D(X)(#)	30x24x72	263/32.7	1,496	1,580	491
XWBC302072D(X)(#)	30x20x72	228/27.7	1,430	1,507	491
XWBC302466D(X)(#)	30x24x66	263/32.7	1,251	1,336	491
XWBC302066D(X)(#)	30x20x66	228/27.7	1,184	1,261	491

Available with framed glazed door, clear or frosted option. See below to order.



**Wardrobe/Bookcase  
36" Wide**

XWBC362484D(X)(#)	36x24x84	390/49.2	1,952	2,038	491	
XWBC362084D(X)(#)	36x20x84	378/41.6	1,829	1,915	491	
<i>Bookcases above contain four adjustable shelves and one fixed shelf.</i>						
XWBC362472D(X)(#)	36x24x72	307/38.7	1,783	1,901	491	
XWBC362072D(X)(#)	36x20x72	247/34.4	1,746	1,860	491	
XWBC362466D(X)(#)	36x24x66	307/38.7	1,414	1,532	491	
XWBC362066D(X)(#)	36x20x66	247/34.4	1,378	1,491	491	

Available with framed glazed door, clear or frosted option. See below to order.

*Bookcases above contain four adjustable shelves.*

*Model number indicates wardrobe with hanger bar on left and bookcase on right.*

*Reverse configuration is available - specify 'XBCW', Bookcase Left, Wardrobe Right.*

**Ordering Details:**

(X) - Specify 'M1' for 1" LPL or 'M2' for 1-1/2" LPL.

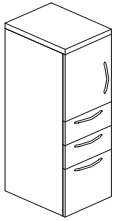
(#) - Specify 'H' for HPL door fronts, and add charge in right column.

**Note:**

Storage products over 72" must be secured to an additional support structure (eg. wall).

# Executive Storage

EXECUTIVE WARDROBES	Model	Size (WDH)	Wt./Cube	LPL Top		H/P Door Fronts
				1"	1-1/2"	



**BBF/ Closed Storage  
Hinged Left, 15.50 Wide**

XSO2BF152454HL(X)(# 15.5X24X54	270/30.6	1,210	1,270	425
XSO2BF152054HL(X)(# 15.5X20X54	254/25.4	1,990	2,050	425
XSO2BF152448HL(X)(#	270/30.6	1,185	1,245	500
15.5X24X48 XSO2BF152048HL(X)	254/25.4	1,165	1,225	500
(#) 15.5X20X48				

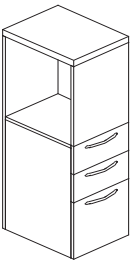
*Specify 'HR' for Hinged Right. For file/file option, substitute '2BF' in part code, for 'FF'.*



**BBF/ Closed Storage  
Hinged Left, 15.50 Wide  
'FF'.**

XS2BF152484HL(X)(# 15.5X24X84	278/33.6	1,675	1,735	500
XS2BF152084HL(X)(# 15.5X20X84	264/28.4	1,625	1,685	500
XS2BF152472HL(X)(# 15.5X24X72	278/33.6	1,560	1,620	425
XS2BF152072HL(X)(# 15.5X20X72	264/28.4	1,520	1,580	425
XS2BF152466HL(X)(# 15.5X24X66	278/33.6	1,230	1,290	425
XS2BF152066HL(X)(# 15.5X20X66	264/28.4	1,190	1,250	425

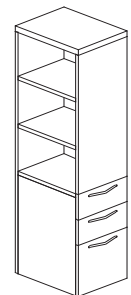
*Specify 'HR' for Hinged Right. For file/file option, substitute '2BF' in part code, for 'FF'.*



**BBF/ Open Left Storage  
15.50 Wide**

XW2BF152484OL(X)(# 15.5X24X84	278/33.6	1,675	1,735	500
XW2BF152084OL(X)(# 15.5X20X84	264/28.4	1,625	1,685	500
XW2BF152472OL(X)(# 15.5X24X72	278/33.6	1,560	1,620	425
XW2BF152072OL(X)(# 15.5X20X72	264/28.4	1,520	1,580	425
XW2BF152466OL(X)(# 15.5X24X66	278/33.6	1,230	1,290	425
XW2BF152066OL(X)(# 15.5X20X66	264/28.4	1,190	1,250	425

*Specify 'OR' for Open Right. For file/file option, substitute '2BF' in part code, for 'FF'.*



**BBF/ Open Left Storage  
Hinged Left, 15.50 Wide  
'FF'.**

XW2BF152484HL(X)(# 15.5X24X84	278/33.6	1,675	1,735	500
XW2BF152084OL(X)(# 15.5X20X84	264/28.4	1,625	1,685	500
XW2BF152472OL(X)(# 15.5X24X72	278/33.6	1,560	1,620	425
XW2BF152072OL(X)(# 15.5X20X72	264/28.4	1,520	1,580	425
XW2BF152466OL(X)(# 15.5X24X66	278/33.6	1,230	1,290	425
XW2BF152066OL(X)(# 15.5X20X66	264/28.4	1,190	1,250	425

*Specify 'HR' for Hinged Right. For file/file option, substitute '2BF' in part code, for 'FF'.*

**Ordering Details:**

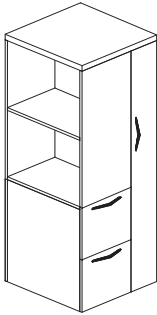
(X) - Specify 'M1' for 1" LPL or 'M2' for 1-1/2" LPL.  
 (#) - Specify 'H' for HPL door fronts, and add charge in right column.

**Note:**

Storage products over 72" must be secured to an additional support structure (eg. wall).

# Executive Storage

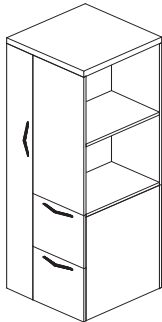
EXECUTIVE WARDROBES/ CLOSED STORAGE	Model	Size (WDH)	Wt./Cube	LPL Top		H/P Fronts
				1"	1-1/2"	



**Wardrobe Right, 2 File Left  
Storage Left, 24" Wide,  
Open side storage on left**

XWL2FF242484(X)(#)	24x24x84	334/33.6	1,862	1,924	614	
XWL2FF242084(X)(#)	24x20x84	320/28.4	1,805	1,867	614	
<i>Closed storage above 2 Box, File Pedestal contains two adjustable shelves.</i>						
XWL2FF242472(X)(#)	24x24x72	263/26.0	1,731	1,793	491	
XWL2FF242072(X)(#)	24x20x72	252/24.2	1,689	1,751	491	
XWL2FF242466(X)(#)	24x24x66	263/26.0	1,363	1,425	491	
XWL2FF242066(X)(#)	24x20x66	252/24.2	1,321	1,383	491	
<i>Closed storage above 2 File Pedestal contains two adjustable shelf.</i>						

Available with framed glazed doors, clear or frosted glazing option. See below to order.



**Wardrobe Left, 2 File Right  
Storage Right, 24" Wide,  
Open side storage on right**

XWR2FF242484(X)(#)	24x24x84	334/33.6	1,862	1,924	614	
XWR2FF242084(X)(#)	24x20x84	320/28.4	1,805	1,867	614	
<i>Closed storage above 2 Box, File Pedestal contains two adjustable shelves.</i>						
XWR2FF242472(X)(#)	24x24x72	263/26.0	1,731	1,793	491	
XWR2FF242072(X)(#)	24x20x72	252/24.2	1,689	1,751	491	
XWR2FF242466(X)(#)	24x24x66	263/26.0	1,363	1,425	491	
XWR2FF242066(X)(#)	24x20x66	252/24.2	1,321	1,383	491	
<i>Closed storage above 2 File Pedestal contains two adjustable shelf.</i>						

Available with framed glazed doors, clear or frosted glazing option. See below to order.

**Ordering Details:**

(X) - Specify 'M1' for 1" LPL or 'M2' for 1-1/2" LPL.  
(#) - Specify 'H' for HPL door fronts, and add charge in right column.

**Options:**

For box/box/file option on any of the above storage, substitute 'FF' in part code for '2BF'.

**Note:**

Storage products over 72" must be secured to an additional support structure (eg. wall).

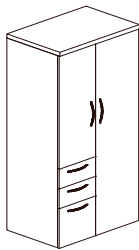
# Executive Storage

EXECUTIVE WARDROBES/ CLOSED STORAGE	Model	Size (WDH)	Wt./Cube	LPL Top 1" 1-1/2"	H/P Fronts
--	-------	---------------	----------	----------------------	---------------



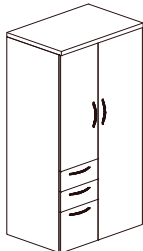
**Wardrobe Right  
24" Wide**

XWS2BF242484(X)(#)	24x24x84	334/33.6	1,862	1,924	614
XWS2BF242084(X)(#)	24x20x84	320/28.4	1,805	1,867	614
<i>Closed storage above 2 Box, File Pedestal contains two adjustable shelves.</i>					
XWS2BF242472(X)(#)	24x24x72	263/26.0	1,731	1,793	491
XWS2BF242072(X)(#)	24x20x72	252/24.2	1,689	1,751	491
XWS2BF242466(X)(#)	24x24x66	263/26.0	1,363	1,425	491
XWS2BF242466(X)(#)	24x20x66	252/24.2	1,321	1,383	491
<i>Closed storage above 2 Box, File Pedestal contains one adjustable shelf.</i>					
Available with framed glazed doors, clear or frosted glazing option. See below to order.					
<i>Reverse configuration is available - specify 'XS2BFW', Storage/BBF Left, Wardrobe Right.</i>					



**Wardrobe Right  
30" Wide**

XS2BFW302484(X)(#)	30x24x84	407/49.2	2,099	2,256	614
XS2BFW302084(X)(#)	30x20x84	393/41.6	1,994	2,046	614
<i>Closed storage above 2 Box, File Pedestal contains two adjustable shelves.</i>					
XS2BFW302472(X)(#)	30x24x72	318/36.7	1,905	1,974	491
XS2BFW302072(X)(#)	30x20x72	309/34.4	1,859	1,927	491
XS2BFW302466(X)(#)	30x24x66	318/36.7	1,500	1,570	491
XS2BFW302066(X)(#)	30x20x66	309/34.4	1,469	1,523	491
Available with framed glazed doors, clear or frosted glazing option. See below to order.					
<i>Reverse configuration is available - specify 'XWS2BF', Wardrobe Left, Storage/BBF Right.</i>					



**Wardrobe Right  
36" Wide**

XS2BFW362484(X)(#)	36x24x84	407/49.2	2,294	2,355	614
XS2BFW362084(X)(#)	36x20x84	393/41.6	2,201	2,289	614
<i>Closed storage above 2 Box, File Pedestal contains two adjustable shelves.</i>					
XS2BFW362472(X)(#)	36x24x72	318/36.7	2,041	2,127	491
XS2BFW362072(X)(#)	36x20x72	309/34.4	1,962	2,049	491
XS2BFW362466(X)(#)	36x24x66	318/36.7	1,796	1,882	491
XS2BFW362066(X)(#)	36x20x66	309/34.4	1,717	1,803	491
<i>Closed storage above 2 Box, File Pedestal contains one adjustable shelf.</i>					
Available with framed glazed doors, clear or frosted glazing option. See below to order.					
<i>Reverse configuration is available - specify 'XWS2BF', Wardrobe Left, Storage/BBF Right.</i>					

**Ordering Details:**

(X) - Specify 'M1' for 1" LPL or 'M2' for 1-1/2" LPL.  
 (#) - Specify 'H' for HPL door fronts, and add charge in right column.

**Options:**

For file/file option on any of the above storage, substitute '2BF' in part code, for 'FF'.

**Note:**

Storage products over 72" must be secured to an additional support structure (eg. wall).

# Executive Storage

EXECUTIVE WARDROBES CLOSED STORAGE	Model	Size (WDH)	Wt./Cube	LPL Top 1"	1-1/2"	H/P Door Fronts
---------------------------------------	-------	---------------	----------	---------------	--------	--------------------



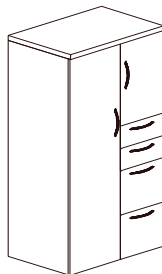
**Wardrobe Left  
24" Wide**

XWS2B2F242484(X)(#	24x24x84	334/33.6	1,924	1,985	614	
XWS2B2F242084(X)(#	24x20x84	320/28.4	1,867	1,928	614	
<i>Closed storage above 2 Box, 2 File Pedestal contains two adjustable shelves.</i>						
XWS2B2F242472(X)(#	24x24x72	263/26.0	1,793	1,854	491	
XWS2B2F242072(X)(#	24x20x72	252/24.2	1,751	1,812	491	
XWS2B2F242466(X)(#	24x24x66	263/26.0	1,425	1,486	491	
XWS2B2F242466(X)(#	24x20x66	252/24.2	1,383	1,444	491	
<i>Closed storage above 2 Box, 2 File Pedestal contains one adjustable shelf.</i>						
<i>Available with framed glazed doors, clear or frosted glazing option. See below to order.</i>						
<i>Reverse configuration is available - specify 'XS2B2FW', Storage/2B2F Left, Wardrobe Right.</i>						



**Wardrobe Left  
30" Wide**

XWS2B2F302484(X)(#	30x24x84	407/49.2	2,205	2,373	614	
XWS2B2F302084(X)(#	30x20x84	393/41.6	2,095	2,147	614	
<i>Closed storage above 2 Box, 2 File Pedestal contains two adjustable shelves.</i>						
XWS2B2F302472(X)(#	30x24x72	318/38.7	2,000	2,074	491	
XWS2B2F302072(X)(#	30x20x72	309/34.4	1,953	2,027	491	
XWS2B2F302466(X)(#	30x24x66	318/38.7	1,576	1,649	491	
XWS2B2F302066(X)(#	30x20x66	309/34.4	1,544	1,631	491	
<i>Closed storage above 2 Box, 2 File Pedestal contains one adjustable shelf.</i>						
<i>Available with framed glazed doors, clear or frosted glazing option. See below to order.</i>						
<i>Reverse configuration is available - specify 'XS2B2FW', Storage/2B2F Left, Wardrobe Right.</i>						



**Wardrobe Left  
36" Wide**

XWS2B2F362484(X)(#	36x24x84	407/49.2	2,355	2,441	614	
XWS2B2F362084(X)(#	36x20x84	393/41.6	2,262	2,351	614	
<i>Closed storage above 2 Box, 2 File Pedestal contains two adjustable shelves.</i>						
XWS2B2F362472(X)(#	36x24x72	318/38.7	2,102	2,188	491	
XWS2B2F362072(X)(#	36x20x72	309/34.4	2,023	2,109	491	
XWS2B2F362466(X)(#	36x24x66	318/38.7	1,856	1,943	491	
XWS2B2F362066(X)(#	36x20x66	309/34.4	1,778	1,864	491	
<i>Closed storage above 2 Box, 2 File Pedestal contains one adjustable shelf.</i>						
<i>Available with framed glazed doors, clear or frosted glazing option. See below to order.</i>						
<i>Reverse configuration is available - specify 'XS2B2FW', Storage/2B2F Left, Wardrobe Right.</i>						

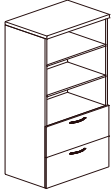

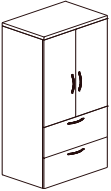
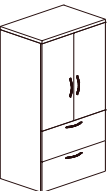
**Ordering Details:**

- (X) - Specify 'M1' for 1" LPL or 'M2' for 1-1/2" LPL.
- (#) - Specify 'H' for HPL door fronts, and add charge in right column.

**Note:**

Storage products over 72" must be secured to an additional support structure (eg. wall).

# Executive Storage

EXECUTIVE STORAGE/LATERAL	Model	Size (WDH)	Wt./Cube	LPL Top		H/P Fronts	
				1"	1-1/2"		
 <p><b>30" Wide</b></p>	XSLAT2-302484(X)(#)	30x24x84	329/49.2	2,399	2,483	154	
	XSLAT2-302084(X)(#)	30x20x84	315/41.6	2,163	2,242	154	
	<i>Open storage with three adjustable shelves. Two lateral drawers.</i>						
	XSLAT2-302472(X)(#)	30x24x72	259/38.7	1,349	1,454	154	
	XSLAT2-302072(X)(#)	30x20x72	248/34.4	1,197	1,349	154	
	XSLAT2-302466(X)(#)	30x24x66	259/38.7	1,118	1,220	154	
	XSLAT2-302466(X)(#)	30x20x66	248/34.4	971	1,111	154	
<i>Open storage with two adjustable shelves. Two lateral drawers.</i>							
 <p><b>Open Storage/Lateral 36" Wide</b></p>	XSLAT2-362484(X)(#)	36x24x84	329/49.2	2,527	2,613	154	
	XSLAT2-362084(X)(#)	36x20x84	315/41.6	2,273	2,359	154	
	<i>Closed storage with three adjustable shelves. Two lateral drawers.</i>						
	XSLAT2-362472(X)(#)	36x24x72	259/38.7	1,420	1,530	154	
	XSLAT2-362072(X)(#)	36x20x72	248/34.4	1,260	1,420	154	
	XSLAT2-362466(X)(#)	36x24x66	259/38.7	1,174	1,284	154	
	XSLAT2-362066(X)(#)	36x20x66	248/34.4	1,014	1,168	154	
<i>Closed storage with two adjustable shelves. Two lateral drawers.</i>							
 <p><b>Closed Storage/Lateral 30" Wide</b></p>	XSLAT2D-302484(X)(#)	30x24x84	361/49.2	2,861	2,941	431	
	XSLAT2D-302084(X)(#)	30x20x84	346/41.6	2,626	2,709	431	
	<i>Closed storage with three adjustable shelves. Two lateral drawers.</i>						
	XSLAT2D-302472(X)(#)	30x24x72	284/38.7	1,586	1,685	431	
	XSLAT2D-302072(X)(#)	30x20x72	272/34.4	1,433	1,576	431	
	XSLAT2D-302466(X)(#)	30x24x66	284/38.7	1,349	1,454	431	
	XSLAT2D-302066(X)(#)	30x20x66	272/34.4	1,197	1,343	431	
<i>Closed storage with two adjustable shelves. Two lateral drawers.</i>							
Available with framed glazed doors, clear or frosted glazing option. See below to order.							
 <p><b>Closed Storage/Lateral 36" Wide</b></p>	XSLAT2D-362484(X)(#)	36x24x84	361/49.2	3,010	3,096	431	
	XSLAT2D-362084(X)(#)	36x20x84	346/41.6	2,765	2,851	431	
	<i>Closed storage with three adjustable shelves. Two lateral drawers.</i>						
	XSLAT2D-362472(X)(#)	36x24x72	284/38.7	1,665	1,776	431	
	XSLAT2D-362072(X)(#)	36x20x72	272/34.4	1,506	1,659	431	
	XSLAT2D-362466(X)(#)	36x24x66	284/38.7	1,420	1,530	431	
	XSLAT2D-362066(X)(#)	36x20x66	272/34.4	1,260	1,413	431	
<i>Closed storage with two adjustable shelves. Two lateral drawers.</i>							
Available with framed glazed doors, clear or frosted glazing option. See below to order.							

**Ordering Details:**





(X) - Specify 'M1' for 1" LPL or 'M2' for 1-1/2" LPL.

(#) - Specify 'H' for HPL door fronts, and add charge in right column.

**Note:**

Storage products over 72" must be secured to an additional support structure (eg. wall).

# Executive Storage

EXECUTIVE STORAGE/LATERAL	Model	Size (WDH)	Wt./Cube	LPL Top		H/P Door Fronts	
				1"	1-1/2"		
 <p><b>30" Wide</b></p>	XSLAT3-302484(X)(#)	30x24x84	311/49.2	2,489	2,567	308	
	XSLAT3-302084(X)(#)	30x20x84	295/41.6	2,245	2,326	308	
	<i>Open storage with two adjustable shelves. Three lateral drawers.</i>						
	XSLAT3-302472(X)(#)	30x24x72	245/38.7	1,818	1,901	308	
	XSLAT3-302072(X)(#)	30x20x72	232/34.4	1,712	1,855	308	
	XSLAT3-302466(X)(#)	30x24x66	245/38.7	1,468	1,549	308	
	XSLAT3-302466(X)(#)	30x20x66	232/34.4	1,428	1,507	308	
<i>Open storage with one adjustable shelves. Three lateral drawers.</i>							
 <p><b>Open Storage/Lateral 36" Wide</b></p>	XSLAT3-362484(X)(#)	36x24x84	311/49.2	2,491	2,573	293	
	XSLAT3-362084(X)(#)	36x20x84	295/41.6	2,249	2,331	293	
	<i>Open storage with two adjustable shelves. Three lateral drawers.</i>						
	XSLAT3-362472(X)(#)	36x24x72	245/38.7	1,913	1,999	308	
	XSLAT3-362072(X)(#)	36x20x72	232/34.4	1,867	1,953	308	
	XSLAT3-362466(X)(#)	36x24x66	245/38.7	1,545	1,631	308	
	XSLAT3-362066(X)(#)	36x20x66	232/34.4	1,498	1,584	308	
<i>Open storage with one adjustable shelves. Three lateral drawers.</i>							
 <p><b>Closed Storage/Lateral 30" Wide</b></p>	XSLAT3D-302484(X)(#)	30x24x84	350/49.2	2,893	2,977	491	
	XSLAT3D-302084(X)(#)	30x20x84	333/41.6	2,714	2,793	491	
	<i>Closed storage with two adjustable shelves.</i>						
	XSLAT3D-302472(X)(#)	30x24x72	275/38.7	2,053	2,137	491	
	XSLAT3D-302072(X)(#)	30x20x72	262/34.4	2,011	2,069	491	
	XSLAT3D-302466(X)(#)	30x24x66	275/38.7	1,701	1,874	491	
	XSLAT3D-302066(X)(#)	30x20x66	262/34.4	1,659	1,717	491	
<i>Closed storage with one adjustable shelves. Three lateral drawers.</i>							
Available with framed glazed doors, clear or frosted glazing option. See below to order.							
 <p><b>Closed Storage/Lateral 36" Wide</b></p>	XSLAT3D-362484(X)(#)	36x24x84	350/49.2	3,046	3,132	491	
	XSLAT3D-362084(X)(#)	36x20x84	333/41.6	2,853	2,939	491	
	<i>Closed storage with two adjustable shelves. Three lateral drawers.</i>						
	XSLAT3D-362472(X)(#)	36x24x72	275/38.7	2,159	2,245	491	
	XSLAT3D-362072(X)(#)	36x20x72	262/34.4	2,113	2,174	491	
	XSLAT3D-362466(X)(#)	36x24x66	275/38.7	1,790	1,876	491	
	XSLAT3D-362066(X)(#)	36x20x66	262/34.4	1,744	1,805	491	
<i>Closed storage with one adjustable shelves. Three lateral drawers.</i>							
Available with framed glazed doors, clear or frosted glazing option. See below to order.							

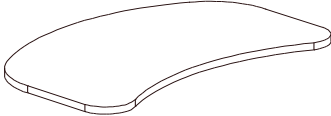
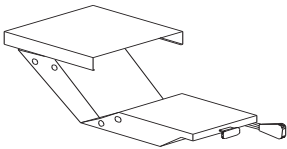
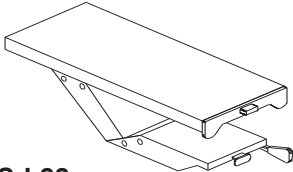
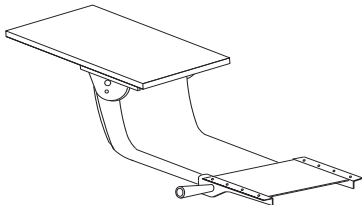
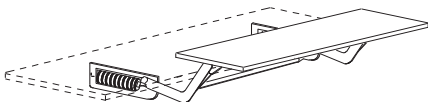
**Ordering Details:**

- (X) - Specify 'M1' for 1" LPL or 'M2' for 1-1/2" LPL.
- (#) - Specify 'H' for HPL door fronts, and add charge in right column.

**Note:**


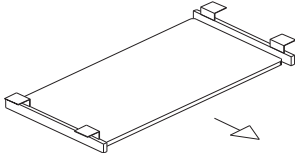
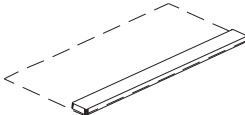
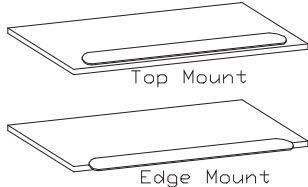
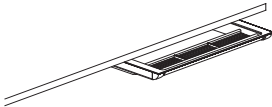
Storage products over 72" must be secured to an additional support structure (eg. wall).

# Keyboards

NATURAL KEYBOARD PLATFORM KEYBOARD MECHANISMS	Model	Size (WDH)	Wt./Cube (KD)	Price
 <p><b>KBCV Natural Series Curved</b> Laminate w/ 3mm PVC Edge</p>	KBCV12	28"x 19.0"x 12" radius		135
	KBCV15	28"x 17.5"x 15" radius		135
	KBCV16	28"x 17.0"x 16" radius		135
	KBCV18	28"x 16.5"x 18" radius		135
	KBCV24	30"x 16.0"x 24" radius		135
	<p><i>Designed to fit all BRC curved corners with same radius. Specify 'M1' LPL or 'H1' HPL. For straight front keyboard tray, add "SF" to end of code.</i></p>			
<p><b>WRKBCV Curved Wrist Rest for KBCV above</b></p>	WRKBCV18	for KBCV12, 15, 16, and 18		145
	WRKBCV24	for KBCV24		155
	<p><i>Padded wrist rest available in black only.</i></p>			
 <p><b>KBW-L Height Adjustable Keyboard Mechanism</b></p>	KBW-L		8/1.0	228
	<p><b>Non-retractable, height adjustable</b> <b>For worksurfaces of all depths.</b></p> <ul style="list-style-type: none"> <li>- 6" height adjustment below using Lever Lock actuator</li> <li>- Easy pull tab activates tray tilt feature</li> <li>- 15 degrees positive or 10 degrees negative tray tilt.</li> </ul>			
 <p><b>KBWS-L22 Heavy Duty Keyboard Mechanism Fully Articulating Steel Ball Bearing Slides</b></p>	KBWS-L22	22" attachment plate	11/1.5	374
	<p><b>Fully retractable low profile support mechanism</b> <b>For worksurfaces 24" deep or greater</b></p> <ul style="list-style-type: none"> <li>- 360 degree swivel arm</li> <li>- 6" height adjustment below using Lever Lock actuator</li> <li>- Easy pull tab activates tray tilt feature</li> <li>- 15 degrees positive or 10 degrees negative tray tilt.</li> <li>- <b>Steel Ball Bearing Slides for ease and durability</b></li> </ul>			
 <p><b>KBSS Heavy Duty Keyboard Mechanism Fully Articulating</b></p>	KBSS	22" attachment plate	11/1.5	346
	<p><b>Fully retractable low profile support mechanism</b> <b>For worksurfaces 24" deep or greater</b></p> <ul style="list-style-type: none"> <li>- 360 degree swivel arm</li> <li>- 8.2" height adjustment range above and 5.8" below worksurface.</li> <li>- Easy pull tab activates tray tilt feature.</li> <li>- 15 degrees positive or negative tray tilt.</li> <li>- <b>Steel Ball Bearing Slides for ease and durability.</b></li> </ul>			
 <p><b>KBKW-B Paddle Adjustable Double Arm - Heavy Duty</b></p>	KBKW-23	23x20		499
	KBKW-27	27x20		503
	<p><i>3/4" thick Black tray included in price above. Add \$200.00 list for matching laminate keyboard tray.</i></p>			
<p><b>All keyboards come with anti-slip feature</b></p>				



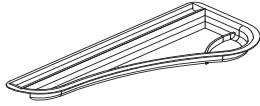
# Keyboards

KEYBOARD PLATFORMS	Model	Size (WD) RADIUS	Wt./Cube (KD)	Price
 <b>KBT Rectangular Keyboard</b>	KBTW9	9x12		113
	KBTW20	20x12		128
	KBTW26	26x12		138
	KBTW27	27x12		138
	KBTW28	28x12		138
	KBTW29	29x12		138
	KBTW30	30x12		143
	<i>Padded wrist rests available in black only.</i>			
 <b>KBR Retractable Keyboard Tray</b>	KBR21	21x12	6/1.0	90
	KBR28	28x12	6/1.0	90
<i>Retractable tray with lock-out feature. Fixed height clearance is user defined during installation. Five positions are available from 2-1/4" to 4-1/2" in 1/2" increments. Can be installed under 20" deep table.</i>				
 <b>WRU20 and WRU27 Wrist Rest for Retractable Keyboard Tray</b>	WRU20	20x2.25x.75		49
	WRU27	27x2.25x.75		56
<i>Can be installed on LPL keyboard platform above. Urethane wrist rest available in black only.</i>				
 <b>Soft Upholstered Vinyl Wrist Rest</b>	WRV20(*)	20 x 3 x .75		45
	WRV22(*)	22 x 3 x .75		48
	WRV28(*)	28 x 3 x .75		50
	WRV34(*)	34 x 3 x .75		55
	WRV40(*)	40 x 3 x .75		60
	WRV46(*)	46 x 3 x .75		63
<i>(*) Specify (E)dge or (T)op mount- e.g. WRV20E</i>				
<i>Select wrist rest size that is at least 2" narrower than platform width.</i>				
<b>Gel Wrist Rest</b>	WR-G19	19X3X.75		108
	WR-G27	27X3X.75		121
 <b>PT-4 (no lock)</b>	PT-4 (no lock)	15.25 x 13.90	8/2	103

Keyboard platforms are available by special order in various shapes and size All platforms may be ordered with a PVC lip at the back to prevent keyboard or mouse from falling off, please add "PVC" to code and \$21 list to the price.

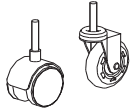
# Accessories

MISCELLANEOUS ACCESSORIES	Model	Size (WD)	Wt./Cube (KD)	Price
---------------------------	-------	-----------	---------------	-------



**Thin Series Pencil Tray**

PT2	13x8	1/5	75
-----	------	-----	----

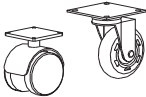


**Casters**

*shown with threaded stem*

CSC - hard wheel caster	2/04	35
CSR - soft wheel skate caster	2/04	99

*Sets of 4 - two locking, 5/16-18" threaded stem, 2-1/2" high.*

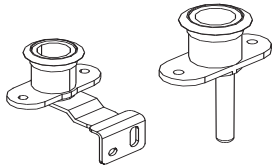


**Casters**

*shown with top plate*

CSC-PT - hard wheel caster	2/04	35
CSR-PT - soft wheel skate caster	2/04	99

*Sets of 4 - two locking, with top plate, 2-1/2" high.*



**Single Lock**

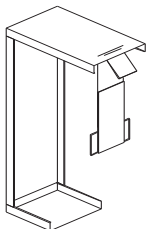
M-KEY - Master Key.	35
R-KEY - Removal Key.	35
SNLK-1 - Single lock. 1 lock core, 2 keys.	35
SNLK-2 - Single lock. 1 lock core, 2 keys, and door housing.	35
SNLK-3 - Single lock. 1 lock core, 2 keys, and drawer housing.	35

**Keys fit all current standard BRC lock series.**

To specify key cores, you may select any key number from 500-509 and 551-700.

You must indicate on your order the quantity of each key number needed.

*Note: furniture model number must be specified when ordering single locks.*



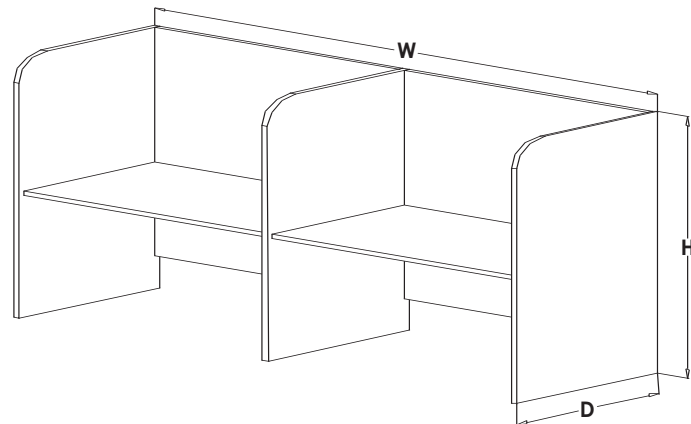
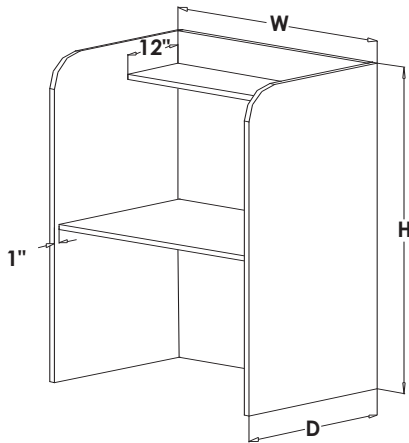
**Tower Model CPU Holder**

<b>CPU-HF</b> <b>Fixed Swivel unit</b>	206
---	-----

<b>CPU-HS</b> <b>Retractable Swivel unit</b>	257
---	-----

Mounts to underside of worksurface. 16 gauge steel construction. Height adjustable - 15"-24". Width adjustable - 3"-9". Load up to 85 lbs. Lightweight - 5.5 lbs. Self locking, ratchet style device. Swivel unit provides easy access to rear of CPU, without having to remove it from the holder.

# Study Carrels



Product Shown:

**D1C423060M1 SH GC WR FM**

Single Carrel with center grommet, full modesty,  
LPL worksurface, overhead shelf, and end gable wire pass through  
Overall size: 42" x 30" x 60" Cost: \$1251

Product Shown:

**D2C423060H1 GL GR WR**

Two set carrel with left and right worksurface grommets, 3/4 modesty,  
HPL worksurface, right hand end gable wire pass through  
Overall size: 84" x 30" x 60" Cost: \$2332

MODEL	SIZE (WDH)	SINGLE		2 STATION		3 STATION		4 STATION	
		M1	H1	M1	H1	M1	H1	M1	H1
D(#)C423060(X)	(#)(X)42x30x60	1,108	1,239	2,000	2,132	2,893	3,024	3,785	3,917
D(#)C363060(X)	(#)(X)36x30x60	1,076	1,218	1,969	2,111	2,861	3,003	3,754	3,896
D(#)C303060(X)	(#)(X)30x30x60	1,055	1,197	1,948	2,090	2,840	2,982	3,733	3,875
D(#)C422460(X)	(#)(X)42x24x60	1,040	1,166	1,880	2,006	2,720	2,846	3,560	3,686
D(#)C362460(X)	(#)(X)36x24x60	1,019	1,124	1,859	1,964	2,699	2,804	3,539	3,581
D(#)C302460(X)	(#)(X)30x24x60	998	1,092	1,838	1,932	2,678	2,772	3,518	3,612
D(#)C423048(X)	(#)(X)42x30x48	998	1,134	1,838	1,974	2,678	2,814	3,518	3,654
D(#)C363048(X)	(#)(X)36x30x48	971	1,113	1,811	1,953	2,651	2,793	3,491	3,633
D(#)C303048(X)	(#)(X)30x30x48	950	1,092	1,790	1,932	2,630	2,772	3,470	3,612
D(#)C422448(X)	(#)(X)42x24x48	935	1,061	1,722	1,848	2,510	2,636	3,297	3,423
D(#)C362448(X)	(#)(X)36x24x48	914	1,019	1,701	1,817	2,489	2,594	3,276	3,381
D(#)C302448(X)	(#)(X)30x24x48	893	987	1,680	1,775	2,468	2,562	3,255	3,150

**Product Information:** Worksurface and side gables are 1" thick material. Back panel is 3/4" material. HPL option applies to worksurface only. Inside gable wire pass through is standard on all multiple station carrels. Modesty panels are standard in 3/4 height (20"). Corner radius on upper front of gable is 6".

**Ordering Details:** (#) Specify number of carrels in a set (1, 2, 3 or 4).  
(X) Specify 'M1' - LPL, or 'H1' - HPL worksurface. Overhead Shelf: add SH to product code and \$63 list (per carrel).  
Worksurface Grommets: add GR, GL and/or GC to code and \$40 list(per grommet).  
End Gable Wire Pass through: add WL (left) and/or WR(right) to code and \$40 list.  
Modesty: Full modesty available - add FM to product code, no upcharge.

# Conference Product Specifications

## CONFERENCE AND AUDIO VISUAL

Laminate base available in all finishes, please see BRC finish guide.

Edges are rigid PVC (2.5mm) thick.

Doors and drawer fronts are available in HPL or LPL. Drawers are black, and drawer handles are available in black or silver, please see BRC finish guide for options.

Available in black.

All drawers have ball-bearing suspensions.

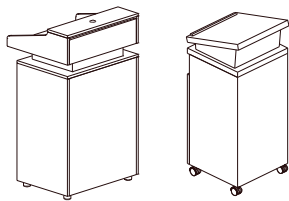
### Key alike:

To specify custom keying contact customer service for options.

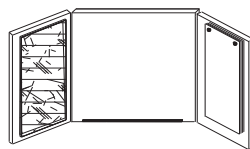
### Available options:

- tops (for all floor-level storage units).
- architectural tops (for 68" storage units).

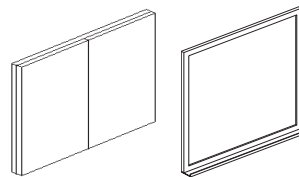
Shipped assembled.



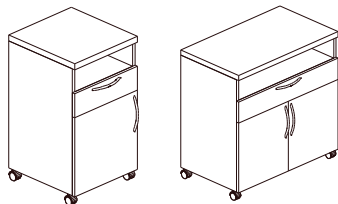
**Lecterns**



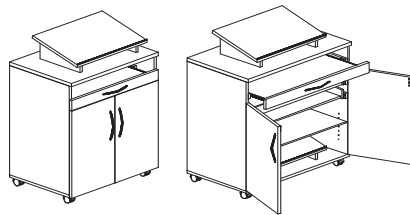
**Visual Boards**



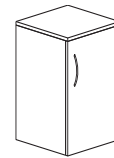
**White Boards**



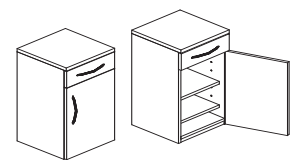
**Serving Carts**



**Lectern / Serving Cart Combo  
with Removable Lectern**



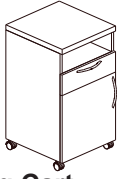
**Telephone Table**



**Projector Table**

# Conference & Audio-Visual

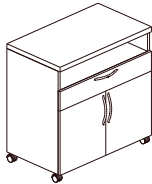
CONFERENCE ROOM ACCESSORIES	Model	Size (WDH)	Wt./Cube	LPL		HPL	
				1"	1-1/2"	1-1/8"	1-1/2"



Serving Cart

NSSC202136(X)	20x21x36	110/10	618	655	765	803
---------------	----------	--------	-----	-----	-----	-----

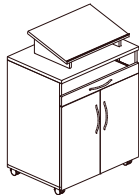
*Equipped with: 1 sliding shelf, 1 box drawer, 1 drawer, 1 adjustable shelf, 4 casters - 2 with brakes, wire access.*



Serving Cart

NSSC362136D(X)	36x21x36	170/16.5	1,041	1,147	1,189	1,295
----------------	----------	----------	-------	-------	-------	-------

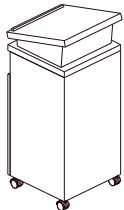
*Equipped with: 1 sliding shelf, 1 box drawer, 2 doors, 2 adjustable shelves, 4 casters - 2 with brakes, wire access.*



Serving Cart  
Lectern Combo

NSSC362136L(X)	36x21x36	175/17	1,409	1,515	1,557	1,663
NSSC302130L(X)	30x21x30	165/14	1,046	1,155	1,053	1,314

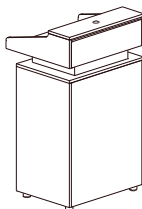
*Equipped with: 1 sliding shelf, 2 box drawers, 2 doors, 1 adjustable shelves, 4 casters - 2 with brakes, wire access.  
Removable Lectern stores in cabinet*



Lectern 18"

NSL181844(Y)	18x18x44	72/9	M3/4 573	H3/4 1,474
--------------	----------	------	-------------	---------------

*Equipped with: 1 fixed lower shelf, 4 casters - 2 with brakes.*



Lectern 24"

NSL282449(Y)	28x24x49	72/9	M3/4 1,546	H3/4 2,580
--------------	----------	------	---------------	---------------

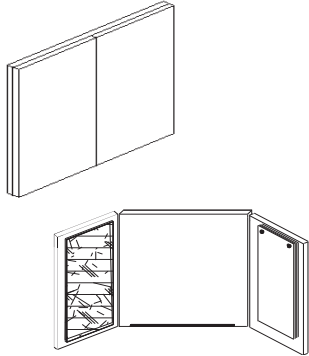
*Equipped with: Open storage and 2 adjustable shelves with 2 grommets for for wire mangement.*

**Ordering Details:**

(X) - Specify 'M1' for 1" LPL, 'M2' for 1-1/2" LPL, 'H1' for 1-1/8" HPL, or 'H2' for 1-1/2" HPL.  
 (Y) - Specify 'M3/4' for 3/4" LPL, 'H3/4' for 3/4" HPL.

# Conference & Audio-Visual

CONFERENCE ROOM ACCESSORIES	Model	Size (WDH)	Wt./Cube	Price	
-----------------------------	-------	------------	----------	-------	--

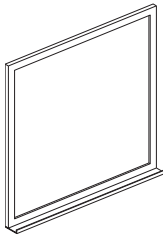


				Regular surface (A)	Magnetic surface (B)
VB48(X)(#)	48x48	105/7.0		995	1,520
VB42(X)(#)	42x42	95/6.0		922	1,447
VB36(X)(#)	36x36	85/6.0		855	1,380

Available in black.  
For HP front doors add \$293 list.

- Includes:**
- tackboard - left door - please specify fabric
  - white board and marker tray - center
  - flip chart - right door

## Visual Boards



## White Boards

				Regular surface (A)	Magnetic surface (B)
WB48(X)	48x48	105/7.0		541	1,129
WB42(X)	42x42	95/6.0		517	1,094
WB36(X)	36x36	85/6.0		480	1,057

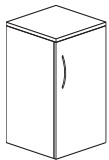
- Includes:**
- white board and marker tray



## Mobile Projector Table Hinged Right

					Full unit HPL
PJRT20HR	20x20x29	105/12		924	1,848
PJRT24HR	20x24x29	115/15		966	1,932

Specify 'HL' for hinged left.  
*Includes one adjustable shelf.*



## Telephone Tables Hinged Right

					Full unit HPL
TT36HR	20x20x34	100/10.8		640	1,344

Specify 'HL' for hinged left.  
*Includes one adjustable shelf.*

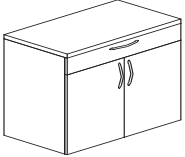
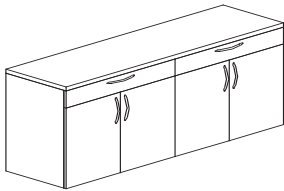
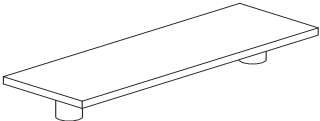
### Options:

Projection Screen, add code PJR and \$519 to list price.

### Ordering Details:

(x) - Specify "A" for regular surface or "B" for Magnetic surface (#)  
- Specify 'M' - LPL, or 'H' - HPL. For full HPL units, standard BRC 2.5mm edging must be specified.

# Boardroom Credenzas

BOARDROOM CREDENZAS	Model	Size (WDH)	Wt./Cube	LPL		HPL	
				1"	1-1/2"	1-1/8"	1-1/2"
 <p><b>Full Credenza</b> Closed Storage, Bottom</p>	NSCBF3020SB(X)	30x20x36	100/13.6	1,197	1,304	1,399	1,572
	NSCBF3024SB(X)	30x24x36	120/15.0	1,247	1,357	1,447	1,562
	NSCBF3620SB(X)	36x20x36	110/16.9	1,253	1,357	1,452	1,562
	NSCBF3624SB(X)	36x24x36	125/18.2	1,301	1,411	1,500	1,615
	NSCBF4220SB(X)	42x20x36	115/17.9	1,340	1,494	1,592	1,717
	NSCBF4224SB(X)	42x24x36	130/19.2	1,394	1,494	1,592	1,717
 <p><b>Full Credenza</b> 2 Box Drawers, Top Double Hinged Closed Storage, Bottom</p>	NSCBF6020SB4(X)	60x20x36	183/29.5	2,326	2,346	2,510	1,479
	NSCBF6024SB4(X)	60x24x36	227/33.9	2,356	2,429	2,540	2,613
	NSCBF6620SB4(X)	66x20x36	208/31.8	2,387	2,408	2,571	2,591
	NSCBF6624SB4(X)	66x24x36	252/36.7	2,440	1,965	2,625	2,673
	NSCBF7220SB4(X)	72x20x36	218/32.5	2,432	2,483	2,617	2,668
	NSCBF7224SB4(X)	72x24x36	262/40.0	2,471	2,566	2,655	2,751
	NSCBF7820SB4(X)	78x20x36	228/37.5	2,598	2,655	2,805	2,863
	NSCBF7824SB4(X)	78x24x36	272/45.0	2,642	2,748	2,848	2,955
	NSCBF8420SB4(X)	84x20x36	238/42.5	2,708	2,770	2,931	2,992
	NSCBF8424SB4(X)	84x24x36	282/50.0	2,756	2,869	2,976	3,091
 <p><b>Credenza Shelf</b> <i>add-on</i></p>	NSCFS4222(X)	42x22x4	52/2.5	263	326	331	441
	NSCFS4218(X)	42x18x4	50/1.7	194	257	263	373
	NSCFS3622(X)	36x22x4	48/1.5	217	266	271	366
	NSCFS3618(X)	36x18x4	45/1.5	202	250	255	351
	NSCFS3022(X)	30x22x4	46/1.3	190	230	234	309
	NSCFS3018(X)	30x18x4	42/1.3	174	214	218	293
	NSCCSR72(X)	72x14x7	22/14	488	574	562	648
	NSCCSR66(X)	66x14x7	22/12	452	538	525	611
	NSCCSR60(X)	60x14x7	20/10	371	457	444	530
	NSCCSR54(X)	54x14x7	18/6	351	437	424	510
NSCCSR48(X)	48x14x7	16/6	309	395	382	468	
NSCCSR42(X)	42x14x7	14/5	291	377	364	450	
NSCCSR36(X)	36x14x7	12/4	269	354	342	428	
NSCCSR30(X)	30x14x7	10/3	169	255	243	329	

Above includes all mounting brackets and posts.

Specify post color, silver or black.

**Ordering Details:**

(X) - Specify 'M1' for 1" LPL, 'M2' for 1-1/2" LPL, 'H1' for 1-1/8" HPL, or 'H2' for 1-1/2" HPL.

# Panel Specifications

## PANELS

BRC offers 3 families of panels:

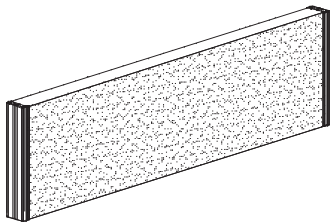
metal framed panels (fabric, glazed or laminate) which bolt on to desks,

post mounted panels (fabric, glazed or laminate),

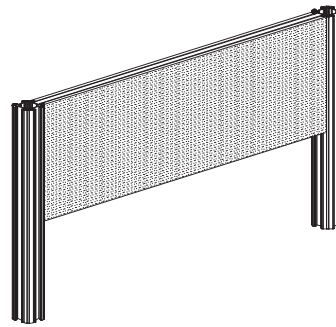
bracket mounted panels (fabric, glazed or laminate).

Posts are available in Black or Silver as standard colours with other finishes available.

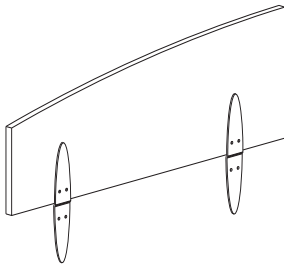
Post mounted panels are stackable in 12" increments



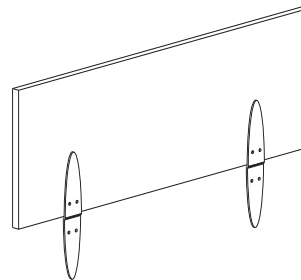
framed panel



post mounted panel  
(posts sold separately)



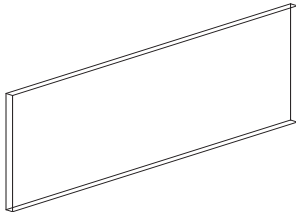
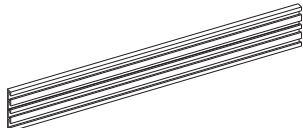
bracket mounted panel curved



bracket mounted panel rectangular



# Panels

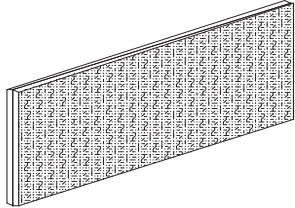
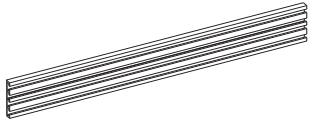
DESKING PANELS FOR POST SYSTEM	Model	Size (WDH)	Wt./Cube (KD)	3/4" LPL	
Both sides Laminate	ADP20(H)PSLL	11 x 0.75 x 13/12	20/1.8	169	
	ADP24(H)PSLL	15 x 0.75 x 13/12	22/1.8	173	
	ADP30(H)PSLL	21 x 0.75 x 13/12	24/1.8	174	
	ADP36(H)PSLL	27x1 1/4x13/12	26/1.8	180	
	ADP42(H)PSLL	33x1 1/4x13/12	28/1.8	182	
	ADP48(H)PSLL	39x1 1/4x13/12	30/2	187	
	ADP54(H)PSLL	45x1 1/4x13/12	30/2	191	
	ADP60(H)PSLL	51x1 1/4x13/12	32/2	195	
	ADP66(H)PSLL	57 x 0.75 x 13/12	34/2	203	
	ADP72(H)PSLL	63 x 0.75 x 13/12	36/2	254	
	<i>(H) For worksurface privacy requiring a minimum of 42" of height specify 13"</i>				
		ADP2024PSLL	11 x 0.75 x 24	22/2.8	174
		ADP2424PSLL	15 x 0.75 x 24	24/2.8	177
		ADP3024PSLL	21 x 0.75 x 24	26/2.8	181
ADP3624PSLL		27 x 0.75 x 24	28/2.6	184	
ADP4224PSLL		33 x 0.75 x 24	30/2.8	186	
ADP4824PSLL		39 x 0.75 x 24	30/2.8	192	
ADP5424PSLL		45 x 0.75 x 24	34/2.8	205	
ADP6024PSLL		51 x 0.75 x 24	36/2.8	211	
ADP6624PSLL		57 x 0.75 x 24	38/4	224	
ADP7224PSLL		63 x 0.75 x 24	40/4	248	
ADP2037PSLL		11 x 0.75 x 37	34/4.0	214	
ADP2437PSLL		15 x 0.75 x 37	36/4.1	226	
ADP3037PSLL		21 x 0.75 x 37	38/4.2	233	
ADP3637PSLL		27 x 0.75 x 37	40/4.3	240	
ADP4237PSLL	33 x 0.75 x 37	42/4.4	255		
ADP4837PSLL	39 x 0.75 x 37	44/4.5	270		
ADP5437PSLL	45 x 0.75 x 37	46/4.6	277		
ADP6037PSLL	51 x 0.75 x 37	48/4.7	299		
ADP6637PSLL	57 x 0.75 x 37	50/4.8	329		
ADP7237PSLL	63 x 0.75 x 37	50/5	358		
 Post Mount Single Accessory Rail (Can be stacked for multiple heights)	ARSP20	10 x 0.5 x 5	3/2.5	197	
	ARSP24	14 x 0.5 x 5	3/3.5	197	
	ARSP30	20 x 0.5 x 5	3/4.5	197	
	ARSP36	26 x 0.5 x 5	3/5.5	209	
	ARSP42	32 x 0.5 x 5	3/6.5	209	
	ARSP48	38 x 0.5 x 5	3/7.5	209	
	ARSP54	44 x 0.5 x 5	3/8.5	215	
	ARSP60	50 x 0.5 x 5	3/9.5	215	
	ARSP66	56 x 0.5 x 5	3/10.5	222	
	ARSP72	62 x 0.5 x 5	3/11.5	222	

**Ordering Details:**

Panels above are for use with posts. Posts must be ordered separately. Choose the post height which matches the panel height.

Plexi glass glazed or frosted panels are available -see 2 sided acoustic/tackable panels for details.

# Panels

DESKING PANELS FOR POST SYSTEM	Model	Size (WD)	Wt./Cube (KD)	Fabric Grade 3	
	1 side Laminate/1 side Acoustic	ADP20(H)PSLF	11x1 1/4x13/12	20/1.8	167
	ADP24(H)PSLF	15x1 1/4x13/12	22/1.8	187	
	ADP30(H)PSLF	21x1 1/4x13/12	24/1.8	205	
	ADP36(H)PSLF	27x1 1/4x13/12	26/1.8	231	
	ADP42(H)PSLF	33x1 1/4x13/12	28/1.8	248	
	ADP48(H)PSLF	39x1 1/4x13/12	30/2	261	
	ADP54(H)PSLF	45x1 1/4x13/12	30/2	279	
	ADP60(H)PSLF	51x1 1/4x13/12	32/2	309	
	ADP66(H)PSLF	57x1 1/4x13/12	34/2	323	
	ADP72(H)PSLF	63x1 1/4x13/12	36/2	339	
	<i>(H) For worksurface privacy requiring a minimum of 42" of height specify 13"</i>				
	ADP2024PSLF	11x1 1/4x24	22/2.8	187	
	ADP2424PSLF	15x1 1/4x24	24/2.8	197	
	ADP3024PSLF	21x1 1/4x24	26/2.8	224	
	ADP3624PSLF	27x1 1/4x24	28/2.6	249	
ADP4224PSLF	33x1 1/4x24	30/2.8	268		
ADP4824PSLF	39x1 1/4x24	30/2.8	291		
ADP5424PSLF	45x1 1/4x24	34/2.8	311		
ADP6024PSLF	51x1 1/4x24	36/2.8	337		
ADP6624PSLF	57x1 1/4x24	38/4	369		
ADP7224PSLF	63x1 1/4x24	40/4	399		
ADP2037PSLF	11x1 1/4x37	34/4.0	209		
ADP2437PSLF	15x1 1/4x37	36/4.1	224		
ADP3037PSLF	21x1 1/4x37	38/4.2	246		
ADP3637PSLF	27x1 1/4x37	40/4.3	279		
ADP4237PSLF	33x1 1/4x37	42/4.4	299		
ADP4837PSLF	39x1 1/4x37	44/4.5	320		
ADP5437PSLF	45x1 1/4x37	46/4.6	340		
ADP6037PSLF	51x1 1/4x37	48/4.7	374		
ADP6637PSLF	57x1 1/4x37	50/4.8	394		
ADP7237PSLF	63x1 1/4x37	50/5	417		
	ARSP20	10 x 0.5 x 5	3/2.5	197	
	ARSP24	14 x 0.5 x 5	3/3.5	197	
	ARSP30	20 x 0.5 x 5	3/4.5	197	
	ARSP36	26 x 0.5 x 5	3/5.5	209	
	ARSP42	32 x 0.5 x 5	3/6.5	209	
	ARSP48	38 x 0.5 x 5	3/7.5	209	
	ARSP54	44 x 0.5 x 5	3/8.5	215	
	ARSP60	50 x 0.5 x 5	3/9.5	215	
	ARSP66	56 x 0.5 x 5	3/10.5	222	
	ARSP72	62 x 0.5 x 5	3/11.5	222	

Post Mount Single Accessory Rail  
(Can be stacked for multiple heights)

**Ordering Details:**

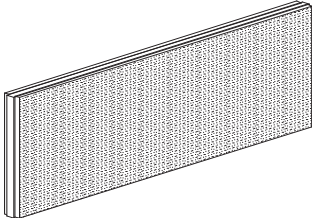
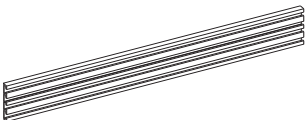
Panels above are for use with posts. Posts must be ordered separately. Choose the post height which matches the panel height. Plexi glass glazed or frosted panels are available -see 2 sided acoustic/tackable panels for details.

COM option is available add 16% to Grade 3 fabric price.

**Notes:**

BRC does not warranty material, construction or labour on materials that are not supplied by BRC.

# Panels

DESKING PANELS FOR POST SYSTEM	Model	Size (WD)	Wt./Cube (KD)	Fabric Grade 3	
	Acoustic/Tackable both Sides.	ADP20(H)PSFF	11x1 1/4x13/12	20/1.8	208
	ADP24(H)PSFF	15x1 1/4x13/12	22/1.8	233	
	ADP30(H)PSFF	21x1 1/4x13/12	24/1.8	254	
	ADP36(H)PSFF	27x1 1/4x13/12	26/1.8	286	
	ADP42(H)PSFF	33x1 1/4x13/12	28/1.8	306	
	ADP48(H)PSFF	39x1 1/4x13/12	30/2	322	
	ADP54(H)PSFF	45x1 1/4x13/12	30/2	343	
	ADP60(H)PSFF	51x1 1/4x13/12	32/2	378	
	ADP66(H)PSFF	57x1 1/4x13/12	34/2	397	
	ADP72(H)PSFF	63x1 1/4x13/12	36/2	416	
	<i>(H) For worksurface privacy requiring a minimum of 42" of height specify 13"</i>				
	ADP2024PSFF	11x1 1/4x24	22/2.8	233	
	ADP2424PSFF	15x1 1/4x24	24/2.8	246	
	ADP3024PSFF	21x1 1/4x24	26/2.8	276	
	ADP3624PSFF	27x1 1/4x24	28/2.6	308	
ADP4224PSFF	33x1 1/4x24	30/2.8	330		
ADP4824PSFF	39x1 1/4x24	30/2.8	357		
ADP5424PSFF	45x1 1/4x24	34/2.8	382		
ADP6024PSFF	51x1 1/4x24	36/2.8	413		
ADP6624PSFF	57x1 1/4x24	38/4	450		
ADP7224PSFF	63x1 1/4x24	40/4	487		
ADP2037PSFF	11x1 1/4x37	34/4.0	407		
ADP2437PSFF	15x1 1/4x37	36/4.1	432		
ADP3037PSFF	21x1 1/4x37	38/4.2	448		
ADP3637PSFF	27x1 1/4x37	40/4.3	463		
ADP4237PSFF	33x1 1/4x37	42/4.4	495		
ADP4837PSFF	39x1 1/4x37	44/4.5	526		
ADP5437PSFF	45x1 1/4x37	46/4.6	542		
ADP6037PSFF	51x1 1/4x37	48/4.7	589		
ADP6637PSFF	57x1 1/4x37	50/4.8	652		
ADP7237PSFF	63x1 1/4x37	50/5	714		
	ARSP20	10 x 0.5 x 5	3/2.5	197	
	ARSP24	14 x 0.5 x 5	3/3.5	197	
	ARSP30	20 x 0.5 x 5	3/4.5	197	
	ARSP36	26 x 0.5 x 5	3/5.5	209	
	ARSP42	32 x 0.5 x 5	3/6.5	209	
	ARSP48	38 x 0.5 x 5	3/7.5	209	
	ARSP54	44 x 0.5 x 5	3/8.5	215	
	ARSP60	50 x 0.5 x 5	3/9.5	215	
	ARSP66	56 x 0.5 x 5	3/10.5	222	
	ARSP72	62 x 0.5 x 5	3/11.5	222	

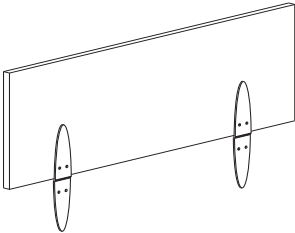
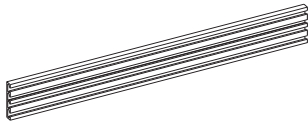
Post Mount Single Accessory Rail  
(Can be stacked for multiple heights)

**Ordering Details:**

Panels above are for use with posts. Posts must be ordered separately. Choose the post height which matches the panel height.

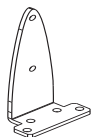
Plexiglass panels are available in all sizes at \$71 upcharge, call for details. To order add "GG" to above codes.

# Panels

DESKING PANELS	Model	Size (WD)	Wt./Cube (KD)	3/4" LPL
	ADP2012LL	20x3/4x12	20/1.8	275
	ADP2412LL	24x3/4x12	22/1.8	282
	ADP3012LL	30x3/4x12	24/1.8	285
	ADP3612LL	36x3/4x12	26/1.8	296
	ADP4212LL	42x3/4x12	28/1.8	299
	ADP4812LL	48x3/4x12	30/2	311
	ADP5412LL	54x3/4x12	30/2	318
	ADP6012LL	60x3/4x12	32/2	327
	ADP6612LL	66x3/4x12	34/2	341
	ADP7212LL	72x3/4x12	36/2	444
	ADP2018LL	20x3/4x18	22/2.8	285
	ADP2418LL	24x3/4x18	24/2.8	291
	ADP3018LL	30x3/4x18	26/2.8	297
	ADP3618LL	36x3/4x18	28/2.6	303
	ADP4218LL	42x3/4x18	30/2.8	309
	ADP4818LL	48x3/4x18	30/2.8	321
	ADP5418LL	54x3/4x18	34/2.8	347
	ADP6018LL	60x3/4x18	36/2.8	358
	ADP6618LL	66x3/4x18	38/4	383
	ADP7218LL	72x3/4x18	40/4	432
	ADP2024LL	20x3/4x24	34/4.0	315
	ADP2424LL	24x3/4x24	36/4.1	334
	ADP3024LL	30x3/4x24	38/4.2	347
	ADP3624LL	36x3/4x24	40/4.3	358
	ADP4224LL	42x3/4x24	42/4.4	383
	ADP4824LL	48x3/4x24	44/4.5	407
	ADP5424LL	54x3/4x24	46/4.6	420
	ADP6024LL	60x3/4x24	48/4.7	457
	ADP6624LL	66x3/4x24	50/4.8	506
	ADP7224LL	72x3/4x24	50/5	554
	AR-20	20x.5x5	3/2.5	197
	AR-24	24x.5x5	3/3.5	197
	AR-30	30x.5x5	3/4.5	197
	AR-36	36x.5x5	3/5.5	209
	AR-42	42x.5x5	3/6.5	209
	AR-48	48x.5x5	3/7.5	209
	AR-54	54x.5x5	3/8.5	215
	AR-60	60x.5x5	3/9.5	215
	AR-66	66x.5x5	3/10.5	222
	AR-72	72x.5x5	3/11.5	222

Optional load bar will attach to panels

**Ordering Details:**

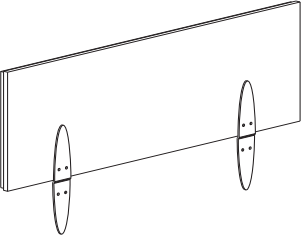
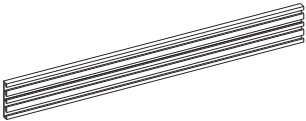


**PBAS**

Panels shown include Step Bracket System to attach to the desk and modesty panel. For tables or desks without modesty panels, use the angle Bracket System. Specify by adding 'PBAS' to the model number, price remains the same.

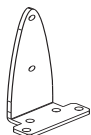
Brackets are standard in black. Silver optional. Specify with order.

# Panels

DESKING PANELS	Model	Size (WD)	Wt./Cube (KD)	Fabric Grade 3
	One side Laminate 1 side tackable			
	ADP2012LF	20x1 1/4x12	20/1.8	335
	ADP2412LF	24x1 1/4x12	22/1.8	344
	ADP3012LF	30x1 1/4x12	24/1.8	348
	ADP3612LF	36x1 1/4x12	26/1.8	362
	ADP4212LF	42x1 1/4x12	28/1.8	366
	ADP4812LF	48x1 1/4x12	30/2	381
	ADP5412LF	60x1 1/4x12	30/2	391
	ADP6012LF	60x1 1/4x12	32/2	401
	ADP6612LF	66x1 1/4x12	34/2	420
	ADP7212LF	72x1 1/4x12	36/2	536
	ADP2018LF	20x1 1/4x18	22/2.8	348
	ADP2418LF	24x1 1/4x18	24/2.8	356
	ADP3018LF	30x1 1/4x18	26/2.8	363
	ADP3618LF	36x1 1/4x18	28/2.6	372
	ADP4218LF	42x1 1/4x18	30/2.8	378
	ADP4818LF	48x1 1/4x18	30/2.8	395
	ADP5418LF	54x1 1/4x18	34/2.8	427
	ADP6018LF	60x1 1/4x18	36/2.8	442
	ADP6618LF	66x1 1/4x18	38/4	474
ADP7218LF	72x1 1/4x18	40/4	552	
	ADP2024LF	20x1 1/4x24	34/4.0	386
	ADP2424LF	24x1 1/4x24	36/4.1	411
	ADP3024LF	30x1 1/4x24	38/4.2	427
	ADP3624LF	36x1 1/4x24	40/4.3	442
	ADP4224LF	42x1 1/4x24	42/4.4	474
	ADP4824LF	48x1 1/4x24	44/4.5	505
	ADP5424LF	54x1 1/4x24	46/4.6	521
	ADP6024LF	60x1 1/4x24	48/4.7	568
	ADP6624LF	66x1 1/4x24	50/4.8	631
	ADP7224LF	72x1 1/4x24	50/5	693
	AR-20	20x.5x5	3/2.5	197
	AR-24	24x.5x5	3/3.5	197
	AR-30	30x.5x5	3/4.5	197
	AR-36	36x.5x5	3/5.5	209
	AR-42	42x.5x5	3/6.5	209
	AR-48	48x.5x5	3/7.5	209
	AR-54	54x.5x5	3/8.5	215
	AR-60	60x.5x5	3/9.5	215
	AR-66	66x.5x5	3/10.5	222
	AR-72	72x.5x5	3/11.5	222

Optional load bar will attach to panels

**Ordering Details:**



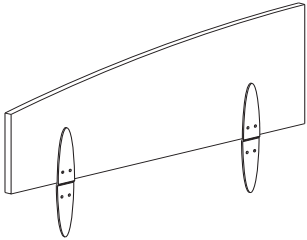
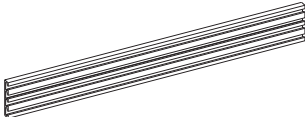
**PBAS**

Panels shown include Step Bracket System to attach to the desk and modesty panel. For tables or desks without modesty panels, use the angle Bracket System. Specify by adding 'PBAS' to the model number, price remains the same.

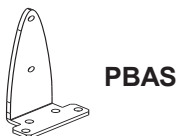
For 2 sided tackable use 'FF' instead of 'LF', and add 21% to the list price. Brackets are standard in black. Silver optional. Specify with order.

Plexiglass panels are available in all sizes at \$71 upcharge, call for details.

# Panels

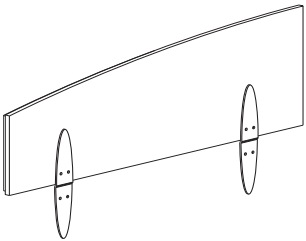
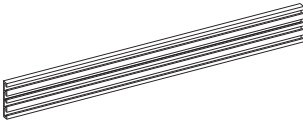
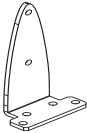
<b>DESKING PANELS</b>		<b>Model</b>	<b>Size (WD)</b>	<b>Wt./Cube (KD)</b>	<b>3/4" LPL</b>
	Both sides Laminate	ADPLX2012LL	20x3/4x12	20/1.8	320
		ADPLX2412LL	24x3/4x12	22/1.8	328
		ADPLX3012LL	30x3/4x12	24/1.8	330
		ADPLX3612LL	36x3/4x12	26/1.8	341
		ADPLX4212LL	42x3/4x12	28/1.8	344
		ADPLX4812LL	48x3/4x12	30/2	355
		ADPLX5412LL	54x3/4x12	30/2	362
		ADPLX6012LL	60x3/4x12	32/2	371
		ADPLX6612LL	66x3/4x12	34/2	384
		ADPLX7212LL	72x3/4x12	36/2	485
		ADPLX2018LL	20x3/4x18	22/2.8	330
		ADPLX2418LL	24x3/4x18	24/2.8	336
		ADPLX3018LL	30x3/4x18	26/2.8	342
		ADPLX3618LL	36x3/4x18	28/2.6	348
		ADPLX4218LL	42x3/4x18	30/2.8	353
		ADPLX4818LL	48x3/4x18	30/2.8	365
		ADPLX5418LL	54x3/4x18	34/2.8	390
		ADPLX6018LL	60x3/4x18	36/2.8	401
		ADPLX6618LL	66x3/4x18	38/4	425
		ADPLX7218LL	72x3/4x18	40/4	473
	ADPLX2024LL	20x3/4x24	34/4.0	359	
	ADPLX2424LL	24x3/4x24	36/4.1	378	
	ADPLX3024LL	30x3/4x24	38/4.2	390	
	ADPLX3624LL	36x3/4x24	40/4.3	401	
	ADPLX4224LL	42x3/4x24	42/4.4	425	
	ADPLX4824LL	48x3/4x24	44/4.5	449	
	ADPLX5424LL	54x3/4x24	46/4.6	461	
	ADPLX6024LL	60x3/4x24	48/4.7	497	
	ADPLX6624LL	66x3/4x24	50/4.8	545	
	ADPLX7224LL	72x3/4x24	50/5	592	
	Optional load bar will attach to panels	AR-20	20x.5x5	3/2.5	197
		AR-24	24x.5x5	3/3.5	197
		AR-30	30x.5x5	3/4.5	197
		AR-36	36x.5x5	3/5.5	209
		AR-42	42x.5x5	3/6.5	209
		AR-48	48x.5x5	3/7.5	209
		AR-54	54x.5x5	3/8.5	215
		AR-60	60x.5x5	3/9.5	215
	AR-66	66x.5x5	3/10.5	222	
	AR-72	72x.5x5	3/11.5	222	

**Ordering Details:**



Panels shown include Step Bracket System to attach to the desk and modesty panel. For tables or desks without modesty panels, use the angle Bracket System. Specify by adding 'PBAS' to the model number, price remains the same. Brackets are standard in black. Silver optional. Specify with order.

# Panels




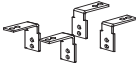

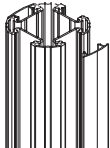
DESKING PANELS	Model	Size (WD)	Wt./Cube (KD)	Fabric Grade 3
 <p>Left Hand Shown</p>	ADPLX2012LF(X)	20x1 1/4x12	20/1.8	379
	ADPLX2412LF(X)	24x1 1/4x12	22/1.8	387
	ADPLX3012LF(X)	30x1 1/4x12	24/1.8	391
	ADPLX3612LF(X)	36x1 1/4x12	26/1.8	405
	ADPLX4212LF(X)	42x1 1/4x12	28/1.8	410
	ADPLX4812LF(X)	48x1 1/4x12	28/1.8	423
	ADPLX5412LF(X)	54x1 1/4x12	30/2	433
	ADPLX6012LF(X)	60x1 1/4x12	32/2	443
	ADPLX6612LF(X)	66x1 1/4x12	34/2	461
	ADPLX7212LF(X)	72x1 1/4x12	36/2	590
<p>Specify L or R for tackboard orientation</p>	ADPLX2018LF(X)	20x1 1/4x18	22/2.8	391
	ADPLX2418LF(X)	24x1 1/4x18	24/2.8	399
	ADPLX3018LF(X)	30x1 1/4x18	26/2.8	406
	ADPLX3618LF(X)	36x1 1/4x18	28/2.6	415
	ADPLX4218LF(X)	42x1 1/4x18	30/2.8	420
	ADPLX4818LF(X)	48x1 1/4x18	30/2.8	437
	ADPLX5418LF(X)	54x1 1/4x18	34/2.8	468
	ADPLX6018LF(X)	60x1 1/4x18	36/2.8	483
	ADPLX6618LF(X)	66x1 1/4x18	38/4	513
	ADPLX7218LF(X)	72x1 1/4x18	40/4	573
 <p>Optional load bar will attach to panels</p>	ADPLX2024LF(X)	20x1 1/4x24	34/4.0	428
	ADPLX2424LF(X)	24x1 1/4x24	36/4.1	452
	ADPLX3024LF(X)	30x1 1/4x24	38/4.2	468
	ADPLX3624LF(X)	36x1 1/4x24	40/4.3	483
	ADPLX4224LF(X)	42x1 1/4x24	42/4.4	513
	ADPLX4824LF(X)	48x1 1/4x24	44/4.5	544
	ADPLX5424LF(X)	54x1 1/4x24	46/4.6	559
	ADPLX6024LF(X)	60x1 1/4x24	48/4.7	605
	ADPLX6624LF(X)	66x1 1/4x24	50/4.8	666
	ADPLX7224LF(X)	72x1 1/4x24	50/5	601
<p>Ordering Details:</p>  <p><b>PBAS</b></p>	AR-20	20x.5x5	3/2.5	197
	AR-24	24x.5x5	3/3.5	197
	AR-30	30x.5x5	3/4.5	197
	AR-36	36x.5x5	3/5.5	209
	AR-42	42x.5x5	3/6.5	209
	AR-48	48x.5x5	3/7.5	209
	AR-54	54x.5x5	3/8.5	215
	AR-60	60x.5x5	3/9.5	215
AR-66	66x.5x5	3/10.5	222	
AR-72	72x.5x5	3/11.5	222	

Panels shown include Step Bracket System to attach to the desk and modesty panel. For tables or desks without modesty panels, use the angle Bracket System. Specify by adding 'PBAS' to the model number, price remains the same. PBAS available separately for \$38 each.

For 2 sided tackable use 'FF' instead of 'LF', and add 21% to the list price. Brackets are standard in black. Silver optional. Specify with order.




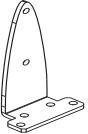
Plexiglass panels are available in all sizes at \$71 upcharge, call for details. (X) - Specify left or right

# Panel Post Options

PANEL POST OPTIONS	Model	Size (WDH)	Wt./Cube (KD)	Price
 <p><b>Post for Desk Panels</b></p>	DSP37(X)	3" dia x 37"h	16/.8	101
	DSP24(X)	3" dia x 24"h	12/.4	97
	DSP13(X)	3" dia x 13"h	10/.3	88
	DSP12(X)	3" dia x 12"h	10/.3	86
	(X) Specify "B" for Black "S" for Silver			
<p><i>Accommodates voice and data. See electrical for voice/data outlet and jacks. All brackets and hardware included</i></p>				
 <p><b>Laminate Filler Panel</b></p>	DPFP37(X)	7" w x 37"h		74
	DPFP24(X)	7" w x 24"h		63
	DPFP13(X)	7" w x 13"h		58
	DPFP12(X)	7" w x 12"h		55
	(X) Specify "B" for Black "S" for Silver			
<p><i>Filler panel between 2 vertical posts on different desks. Available in black and silver.</i></p>				
 <p><b>Stackable Post for Desk Panels or Ceiling Power Feed</b></p>	DSPST49(X)	3" dia x 49"h	21/1.2	189
	DSPST37(X)	3" dia x 37"h	16/.8	147
	DSPST12(X)	3" dia x 12"h	10/.3	88
	(X) Specify "B" for Black "S" for Silver			
	<p><i>Optional sizes available</i></p>			
 <p><b>Post Mount Bracket Kit for Transaction Work Surface</b></p>	DSPKIT 4	1"w x 2"h		40
	<i>Note: Kit is for one Post.</i>			
 <p><b>Desk Panel Post Cap</b></p>	DSPCAP(*)	3" Dia		39
 <p><b>Desk Panel Post Covers</b></p>	DSPCOVER(*)			1.05 per/ft.



# Panel Post Accessories

RECEPTION DESKS	Model	Size (WDH)	Wt./Cube	Price
 <b>Panel Support Bracket</b>	PSB-6BLACK	7x7	.5/.5	86
	PSB-6SILVER	7x7	.5/.5	86
 <b>Letter Tray for Accessory Load Bar</b>	LT-B <i>Black Only</i>	9"w x 12"d		100
 <b>Legal tray for Accessory Load Bar</b>	LGT-B <i>Black Only</i>	15"w x 12"d		100
 <b>PBAS(X)</b> (X) Specify "B" for Black "S" for Silver.		2"w x 6"h		38 each.

*Note: For more accessories for load bar, reference BRC Accessory Guide.*

# Boardroom & Meeting Tables

## BOARDROOM TABLES

Boardroom tables are available with four core/surface material options:  
 M1 - 1.00" thick LPL, H1 - 1.00" thick HPL      M2 - 1.50" thick LPL, H2 - 1.00" thick HPL

Worksurfaces and bases available in all finishes and trims found in the BRC Finish Guide. Metal portion of base available in black or silver only.

Architectural bases are constructed of 0.75" LPL with metal corners. Each base has a removeable panel for wire access. Connecting 10" high modesty panels included.

All electrical options include plugs with cords and wire managers. See page 144 for detailed electrical specifications.

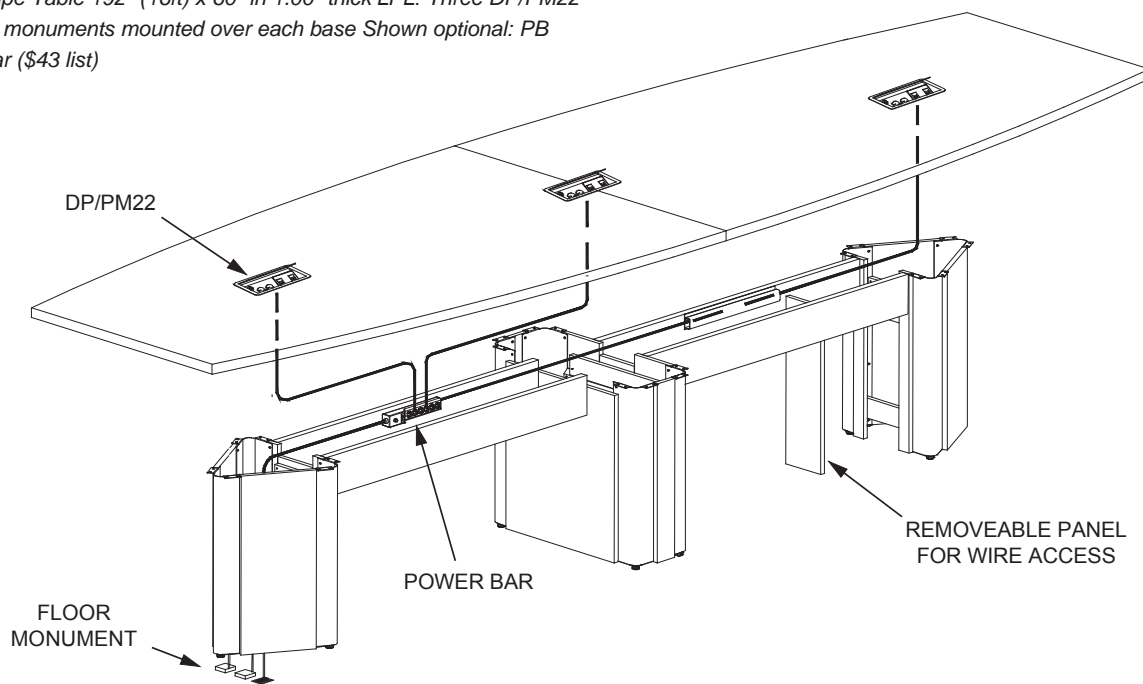
Silver or black reveal available on all boardroom tables. Note: reveal adds 0.5" to the overall height of table. Indicate M1, M2, H1 or H2 and add code REA (silver) or REB (black) to product code and 20% to list price.

### Boardroom Table Example

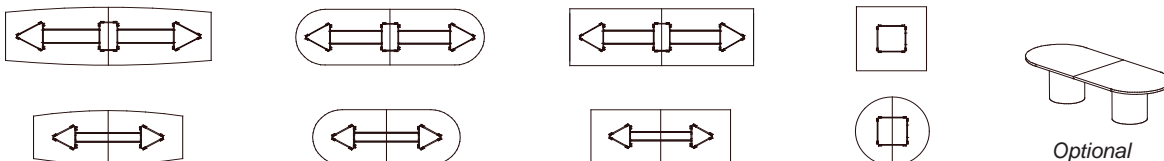
Table shown (with typical wiring):

#### BBT19260M1 E3

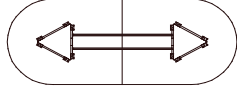
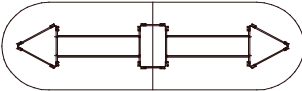

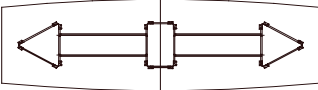
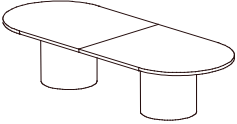
Boat Shape Table 192" (16ft) x 60" in 1.00" thick LPL. Three DP/PM22 electrical monuments mounted over each base. Shown optional: PB Power bar (\$43 list)



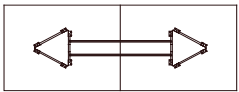
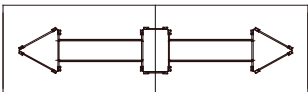
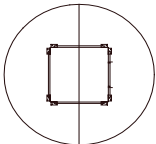
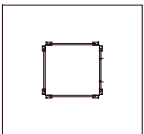
### Product Offering



# Boardroom Tables

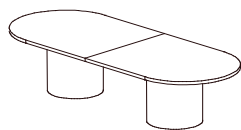
CONFIGURATIONS	Model	Size (WDH)	LPL(M1)		HPL (H1)		
			1"	1-1/2"	1-1/8"	1-1/2"	
 <p><b>Racetrack Table with Architectural Bases</b> Includes Modesty Panels</p>	BRCA9648(X)(E)(*)	96x48x29	2,099	2,275	2,290	2,546	
	BRCA12048(X)(E)(*)	120x48x29	2,315	2,398	2,408	2,699	
	BRCA14448(X)(E)(*)	144x48x29	2,318	2,468	2,470	2,889	
	BRCA14460(X)(E)(*)	144x60x29	2,336	2,532	2,545	2,852	
	BRCA16860(X)(E)(*)	168x60x29	2,502	2728	2755	3115	
	<i>Above sizes: two piece top with two bases</i>						
	BRCA19260(X)(E)(*)	192x60x29	4,019	4,381	4,425	5,000	
	<i>Above sizes: two piece top with three bases</i>						
		BRCA21660(X)(E)(*)	216x60x29	4,225	4,606	4,653	5,306
		BRCA24060(X)(E)(*)	240x60x29	4,438	4,838	4,888	5,523
BRCA26460(X)(E)(*)		264x60x29	4,644	5,063	5,113	5,778	
BRCA28860(X)(E)(*)		288x60x29	4,850	5,286	5,340	6,035	
BRCA30060(X)(E)(*)		300x60x29	4,956	5,406	5,463	6,169	
<i>Above sizes: three piece top with three bases</i>							
<i>See below for grommet and electrical options</i>							
 <p><b>Boat Shape Table with Architectural Bases</b> Includes Modesty Panels</p>	BBTA9648(X)(E)(*)	96x48/42x29	2,099	2,275	2,290	2,546	
	BBTA12048(X)(E)(*)	120x48/42x29	2,315	2,398	2,408	2,699	
	BBTA14448(X)(E)(*)	144x48/42x29	2,318	2,468	2,470	2,889	
	BBTA14460(X)(E)(*)	144x60/48x29	2,336	2,532	2,545	2,852	
	BBTA16860(X)(E)(*)	168x60/48x29	2,502	2728	2755	3115	
	<i>Above sizes: two piece top with two bases</i>						
	BBTA19260(X)(E)(*)	192x60x29	4,019	4,381	4,425	5,000	
	<i>Above sizes: two piece top with three bases</i>						
		BBTA21660(X)(E)(*)	216x60/48x29	4,225	4,606	4,653	5,306
		BBTA24060(X)(E)(*)	240x60/48x29	4,438	4,838	4,888	5,523
BBTA26460(X)(E)(*)		264x60/48x29	4,644	5,063	5,113	5,778	
BBTA28860(X)(E)(*)		288x60/48x29	4,850	5,286	5,340	6,035	
BBTA30060(X)(E)(*)		300x60/48x29	4,956	5,406	5,463	6,169	
<i>Above sizes: three piece top with three bases</i>							
<i>See below for grommet and electrical options</i>							
	<p><b>(*) - Drum Base Option:</b> Add 'DR' to code (no price change)</p> <p>Drum base option does not include modesty panels. See page 118 for base specifications. Tables without electrical/data monuments include L6 drum base. Tables with electrical/data monuments include DRBRC drum base with removeable panel.</p>						
	<p><b>Ordering Details:</b> (X) - Specify 'M1' for 1" LPL, 'M2' for 1-1/2" LPL, 'H1' for 1-1/8" HPL, or 'H2' for 1-1/2" HPL. (E) - <b>Electrical:</b> Center mounted single DP/PM22 - add \$301 list add code 'E1'. DP/PM22 mounted over each end base (2 total) - add \$602 list &amp; code 'E2'. DP/PM22 mounted over three bases (3 total) - add \$903 list and 'E3'. Center mounted single DP/PM412 - add \$998 list add code 'E4'. DP/PM412 mounted over each end base (2 total) - add \$1996 list &amp; code 'E5'. DP/PM412 mounted over three bases (3 total) - add \$2994 list and 'E6'. <i>See page 144 for electrical/data monument specifications</i></p>						
<p><b>Options:</b> <b>Grommets:</b> GC, GR, GL where required - add \$38 list per grommet</p>							

# Boardroom Tables

CONFIGURATIONS	Model	Size (WDH)	LPL(M1)		HPL (H1)		
			1"	1-1/2"	1-1/8"	1-1/2"	
	BRTA9648(X)(E)(*)	96x48x29	1,996	2,171	2,188	2,443	
	BRTA12048(X)(E)(*)	120x48x29	2,212	2,295	2,305	2,596	
	BRTA14448(X)(E)(*)	144x48x29	2,212	2,365	2,367	2,676	
	BRTA14460(X)(E)(*)	144x60x29	2,233	2,429	2,439	2,748	
	BRTA16860(X)(E)(*)	168x60x29	2,285	2,490	2,495	2,800	
	<i>Above sizes: two piece top with two bases</i>						
	BRTA19260(X)(E)(*)	192x60x29	3,898	4,250	4,292	4,850	
	<i>Above sizes: two piece top with three bases</i>						
	BRTA21660(X)(E)(*)	216x60x29	4,098	4,468	4,513	5,147	
	BRTA24060(X)(E)(*)	240x60x29	4,304	4,692	4,741	5,357	
	BRTA26460(X)(E)(*)	264x60x29	4,504	4,911	4,959	5,604	
	BRTA28860(X)(E)(*)	288x60x29	4,705	5,128	5,180	5,854	
BRTA30060(X)(E)(*)	300x60x29	4,808	5,244	5,299	5,984		
<i>Above sizes: three piece top with three bases</i>							
<b>Rectangular Table with Architectural Bases</b> Includes Modesty Panels			<i>See below for grommet and electrical options</i>				
	BRDA48(X)(E)(*)	48dia x 29	1,266	1,346	1,358	1,496	
	BRDA54(X)(E)(*)	54dia x 29	1,389	1,451	1,510	1,749	
	BRDA60(X)(E)(*)	60dia x 29	1,516	1,624	1,642	1,958	
	BRDA72(X)(E)	72dia x 29	2,614	2,797	2,826	3,137	
	BRDA84(X)(E)	84dia x 29	2,875	3,076	3,107	3,449	
	BRDA96(X)(E)	96dia x 29	3,163	3,203	3,279	3,679	
	BSQA48(X)(E)(*)	48x48x29	1,223	1,300	1,312	1,445	
	BSQA54(X)(E)(*)	54x54x29	1,342	1,402	1,459	1,690	
	BSQA60(X)(E)(*)	60x60x29	1,465	1,569	1,586	1,892	
	BSQA72(X)(E)	72x72x29	2,526	2,702	2,730	3,031	
	BSQA84(X)(E)	84x84x29	2,778	2,972	3,002	3,332	
	BSQA96(X)(E)	96x96x29	3,056	3,095	3,168	3,555	

**Square & Round Table with Architectural Bases**

*Sizes above 60" have two piece top  
Electrical options: E1 and E4 only*



**(\*) - Drum Base Option:** Add 'DR' to code (no price change)

Drum base option does not include modesty panels. See page 118 for base specifications. Tables without electrical/data monuments include L6 drum base. Tables with electrical/data monuments include DRBRC drum base with removeable panel.

**Ordering Details:**



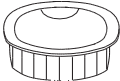
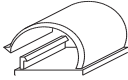
**Options:**

(X) - Specify 'M1' for 1" LPL, 'M2' for 1-1/2" LPL, 'H1' for 1-1/8" HPL, or 'H2' for 1-1/2" HPL. (E) - **Electrical:** Center mounted single DP/PM22 - add \$301 list add code 'E1'. DP/PM22 mounted over each end base (2 total) - add \$602 list & code 'E2'. DP/PM22 mounted over three bases (3 total) - add \$903 list and 'E3'. Center mounted single DP/PM412 - add \$998 list add code 'E4'. DP/PM412 mounted over each end base (2 total) - add \$1996 list & code 'E5'. DP/PM412 mounted over three bases (3 total) - add \$2994 list and 'E6'.

*See page 144 for electrical/data monument specifications*

**Grommets:** GC, GR, GL where required - add \$38 list per grommet

# Desk & Electrical Accessories

TABLE ELECTRICAL ACCESSORIES	Model	Description	Size (WDH)	Price
 <p><b>Power Bar</b></p>	DP-PWB	6 Outlet with on/off switch Single Circuit		92
		Voice / Data Outlet - Panel Post		
 <p><b>RJ11 and RJ45 Jack</b></p>	PMRJ11 PMRJ45	Voice Jack - Cat 3 Data Jack - Cat 6 <i>Fits VDODP Voice / Data Outlet</i>		25 25
 <p><b>Grommet</b></p>	GL GC GR	Grommet - Left - installed set location. Grommet - Center - installed set location Grommet - Right - installed set location <i>Price for installed option - custom location is \$68.00. Uninstalled - \$22.00. Standard grommet locations are left rear, center rear, and right rear of the table. Other locations (custom) must be specified with a diagram. Price as noted above.</i>		40 40 40
 <p><b>Vertical Wire Management</b></p>	VWM	18 inches in length, package of 2		33

*To be screw mounted on modesty panel beneath worksurface or immediately beneath power harness when harness is mounted to worksurface. Channel can be used as a additional cover with desk post channel.*

**Ordering Details:**

When specifying wire management channel for retractable power modules use wire management channel 6" narrower than suggested above to allow for their width.