

LIST PRICING

2017



STUDENT DESKS



TEACHER DESKS



STARTER / ADDER DESKS



MULTI-PURPOSE TABLES



COMPUTER TABLES



STORAGE

CATEGORY		PAGE
STUDENT DESKS and MULTI-PURPOSE TABLES (see page 1 for overview)	Straight Profile (rectangular top)	2-3
	Forum Profile (top has subtle curve)	4-5
	Wave Profile (top has curved front)	6-7
	Corner Profile	8-9
	Rounded Shapes	10-11
	Specialty Shapes	12
	Accessories	13
TEACHER DESKS and WORKSPACE STORAGE (see pages 14-15 for overview)	Open Space Desks and Storage	16-19
	Latchable Desks and Storage	20-23
	Single Pedestal Desks	24-27
	Double Pedestal Desks	28-29
	Techera Teacher Workstation	30-31
	Accessories	32
MOBILE STORAGE (see pages 34-35 for overview)	Mobile Cabinets	36-37
	Mobile Wardrobes	38-39
	Mobile Workspace / Storage	40-41
	Mobile Cubbies	42
	Stationary Storage Cabinets	43
	Accessories	44
SHUTTLEMATE COMPUTER DESKS (see pages 46-47 for overview)	ShuttleMate Straight Profile	48
	ShuttleMate Wave Profile	49
	Corner Stations	50
	Accessories	51
SHUTTLESYSTEM COMPUTER STATIONS (see pages 52-53 for overview)	Computer Desks	54
	Accessories	55
STARTER / ADDER DESKS (see pages 56-57 for overview)	Tandem	58-59
	Other Fixed Tables	60-61
	Tandem Accessories	62

ShuttleZone

Changeable Desks & Tables



The most versatile tables ever designed for schools, ShuttleZone Changeable Desks and Tables transform ordinary classrooms into changeable, technology-friendly learning spaces.









Student Desks & Classroom Tables

MultiPurpose Tables

- Rugged 14-gauge steel legs in your choice of styles
- Metal-to-metal connections and triple-arc welds
- Premium PVC edging
- Contemporary design and high-performance features
- Hundreds of shapes and sizes

INDEX

CATEGORY	PAGE
Student Desks & MultiPurpose Tables	
	Straight Profile
2 - 3	
	Forum Profile
4 - 5	
	Wave Profile
6 - 7	
	Corner Profile
8 - 9	
	Modular Rounded Shapes
10 - 11	
	Specialty Shapes
12	
Accessories	
	Mobile Pedestals
13	
	Storage Totes
13	
	Book Boxes & Center Drawers
13	
	Technology Accessories
13	

Shipping of ShuttleZone Changeable Desks & Tables

- > All orders of 10 stations and over will be bulk packed on pallets.
- > Orders under 10 stations may be individually cartoned (large components may also be palletized).
- > Weights are approximate and include shipping cartons.
- > Freight classification is 70 for disassembled flat product.



◀ **STRAIGHT PROFILE SHAPE 20"D / 24"D / 30"D**



① CHOOSE SIZE

② SELECT LEG STYLE for base model number and base price

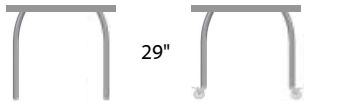
Width	Depth
26" Straight Profile	20" D
	24" D
	30" D
30" Straight Profile	20" D
	24" D
	30" D
36" Straight Profile	20" D
	24" D
	30" D
42" Straight Profile	20" D
	24" D
	30" D
48" Straight Profile	20" D
	24" D
	30" D
54" Straight Profile	20" D
	24" D
	30" D
60" Straight Profile	20" D
	24" D
	30" D
72" Straight Profile	20" D
	24" D
	30" D

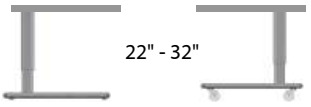
Fixed Arc Leg		Adjustable Arc Leg		Adjustable Pedestal Leg	
					
Glides	Casters	Glides		Glides	Casters
SZFT-FG-ST2026	SZFT-FC-ST2026	SZFT-AG-ST2026		Special Order	
\$276	\$343	\$294			
SZFT-FG-ST2426	SZFT-FC-ST2426	SZFT-AG-ST2426		SZFT-HG-ST2426	SZFT-HC-ST2426
\$427	\$509	\$482		\$650	\$754
SZFT-FG-ST3026	SZFT-FC-ST3026	SZFT-AG-ST3026		SZFT-HG-ST3026	SZFT-HC-ST3026
\$424	\$518	\$492		\$672	\$776
SZFT-FG-ST2030	SZFT-FC-ST2030	SZFT-AG-ST2030		Special Order	
\$383	\$465	\$440			
SZFT-FG-ST2430	SZFT-FC-ST2430	SZFT-AG-ST2430		SZFT-HG-ST2430	SZFT-HC-ST2430
\$448	\$527	\$499		\$662	\$760
SZFT-FG-ST3030	SZFT-FC-ST3030	SZFT-AG-ST3030		SZFT-HG-ST3030	SZFT-HC-ST3030
\$467	\$550	\$524		\$672	\$776
SZFT-FG-ST2036	SZFT-FC-ST2036	SZFT-AG-ST2036		Special Order	
\$406	\$487	\$461			
SZFT-FG-ST2436	SZFT-FC-ST2436	SZFT-AG-ST2436		SZFT-HG-ST2436	SZFT-HC-ST2436
\$466	\$547	\$521		\$672	\$776
SZFT-FG-ST3036	SZFT-FC-ST3036	SZFT-AG-ST3036		SZFT-HG-ST3036	SZFT-HC-ST3036
\$488	\$570	\$544		\$692	\$796
SZFT-FG-ST2042	SZFT-FC-ST2042	SZFT-AG-ST2042		Special Order	
\$435	\$518	\$492			
SZFT-FG-ST2442	SZFT-FC-ST2442	SZFT-AG-ST2442		SZFT-HG-ST2442	SZFT-HC-ST2442
\$487	\$569	\$542		\$699	\$798
SZFT-FG-ST3042	SZFT-FC-ST3042	SZFT-AG-ST3042		SZFT-HG-ST3042	SZFT-HC-ST3042
\$505	\$584	\$560		\$717	\$818
SZFT-FG-ST2048	SZFT-FC-ST2048	SZFT-AG-ST2048		Special Order	
\$466	\$547	\$521			
SZFT-FG-ST2448	SZFT-FC-ST2448	SZFT-AG-ST2448		SZFT-HG-ST2448	SZFT-HC-ST2448
\$509	\$587	\$561		\$717	\$819
SZFT-FG-ST3048	SZFT-FC-ST3048	SZFT-AG-ST3048		SZFT-HG-ST3048	SZFT-HC-ST3048
\$526	\$608	\$582		\$735	\$839
SZFT-FG-ST2054	SZFT-FC-ST2054	SZFT-AG-ST2054		Special Order	
\$494	\$577	\$552			
SZFT-FG-ST2454	SZFT-FC-ST2454	SZFT-AG-ST2454		SZFT-HG-ST2454	SZFT-HC-ST2454
\$524	\$605	\$578		\$739	\$843
SZFT-FG-ST3054	SZFT-FC-ST3054	SZFT-AG-ST3054		SZFT-HG-ST3054	SZFT-HC-ST3054
\$542	\$621	\$598		\$756	\$860
SZFT-FG-ST2060	SZFT-FC-ST2060	SZFT-AG-ST2060		Special Order	
\$566	\$647	\$620			
SZFT-FG-ST2460	SZFT-FC-ST2460	SZFT-AG-ST2460		SZFT-HG-ST2460	SZFT-HC-ST2460
\$576	\$657	\$629		\$768	\$872
SZFT-FG-ST3060	SZFT-FC-ST3060	SZFT-AG-ST3060		SZFT-HG-ST3060	SZFT-HC-ST3060
\$583	\$664	\$640		\$777	\$880
SZFT-FG-ST2072	SZFT-FC-ST2072	SZFT-AG-ST2072		Special Order	
\$634	\$714	\$688			
SZFT-FG-ST2472	SZFT-FC-ST2472	SZFT-AG-ST2472		SZFT-HG-ST2472	SZFT-HC-ST2472
\$653	\$733	\$709		\$854	\$951
SZFT-FG-ST3072	SZFT-FC-ST3072	SZFT-AG-ST3072		SZFT-HG-ST3072	SZFT-HC-ST3072
\$676	\$755	\$730		\$875	\$973



③ ADD OPTION CODES and PRICES

Add an Option Code for each category to base Model Number.

Add the price for each selected Option to base price.

Top Cutout	ShuttleLatch	Wire Tray
<p>-X No cutout N/C</p>	<p>-X No Latch N/C</p>	<p>-X No Modesty Tray N/C</p>
<p>-G One 3" Grommet \$31</p>	<p>-L ShuttleLatch \$56</p>	<p>-M 12" Modesty Height Wire Manager (stations 36" or wider) \$180</p>
<p>-2 Two Grommets (stations 48" or wider) \$62</p>		
<p>-E MiniPort \$284</p>		

EXAMPLE

- ① 24 x 60 Straight Profile ShuttleZone Table
- ② on Fixed Arc Legs with Glides and...
- ③ one grommet, ShuttleLatch, no wire tray

MODEL NUMBER	
Model Number	Option Codes
SZFT-FG-ST2460	- G - L - X

PRODUCT PRICE	
Base Price	Option Prices
\$576	+ \$31 + \$56 + 0
Total Price:	
\$663	

WORKSHEET

MODEL NUMBER	
Model Number	Option Codes
	- - -

PRODUCT PRICE	
Base Price	Option Prices
\$	+ + +
Total Price:	
\$	

Please contact your ShuttleSystem dealer to obtain discounted project pricing.

Available Accessories:	see page
• Book Boxes	13
• Power / Data MiniPort	13
• Keyboard Tray	13

◁ **FORUM PROFILE SHAPE 20"D / 24"D / 30"D**



① CHOOSE SIZE

② SELECT LEG STYLE for base model number and base price

Width	Depth
26" Forum Profile	20" D
	24" D
	30" D
30" Forum Profile	20" D
	24" D
	30" D
36" Forum Profile	20" D
	24" D
	30" D
42" Forum Profile	20" D
	24" D
	30" D
48" Forum Profile	20" D
	24" D
	30" D
54" Forum Profile	20" D
	24" D
	30" D
60" Forum Profile	20" D
	24" D
	30" D

Fixed Arc Leg		Adjustable Arc Leg		Adjustable Pedestal Leg	
29"		22"-31"		22" - 32"	
Glides	Casters	Glides		Glides	Casters
SZFT-FG-FM2026	SZFT-FC-FM2026	SZFT-AG-FM2026		Special Order	
\$276	\$343	\$294			
SZFT-FG-FM2426	SZFT-FC-FM2426	SZFT-AG-FM2426		SZFT-HG-FM2426	SZFT-HC-FM2426
\$427	\$509	\$482		\$650	\$754
SZFT-FG-FM3026	SZFT-FC-FM3026	SZFT-AG-FM3026		SZFT-HG-FM3026	SZFT-HC-FM3026
\$424	\$518	\$492		\$672	\$776
SZFT-FG-FM2030	SZFT-FC-FM2030	SZFT-AG-FM2030		Special Order	
\$383	\$465	\$440			
SZFT-FG-FM2430	SZFT-FC-FM2430	SZFT-AG-FM2430		SZFT-HG-FM2430	SZFT-HC-FM2430
\$448	\$527	\$499		\$662	\$760
SZFT-FG-FM3030	SZFT-FC-FM3030	SZFT-AG-FM3030		SZFT-HG-FM3030	SZFT-HC-FM3030
\$467	\$550	\$524		\$672	\$776
SZFT-FG-FM2036	SZFT-FC-FM2036	SZFT-AG-FM2036		Special Order	
\$406	\$487	\$461			
SZFT-FG-FM2436	SZFT-FC-FM2436	SZFT-AG-FM2436		SZFT-HG-FM2436	SZFT-HC-FM2436
\$466	\$547	\$521		\$672	\$776
SZFT-FG-FM3036	SZFT-FC-FM3036	SZFT-AG-FM3036		SZFT-HG-FM3036	SZFT-HC-FM3036
\$488	\$570	\$544		\$692	\$796
SZFT-FG-FM2042	SZFT-FC-FM2042	SZFT-AG-FM2042		Special Order	
\$435	\$518	\$492			
SZFT-FG-FM2442	SZFT-FC-FM2442	SZFT-AG-FM2442		SZFT-HG-FM2442	SZFT-HC-FM2442
\$487	\$569	\$542		\$699	\$798
SZFT-FG-FM3042	SZFT-FC-FM3042	SZFT-AG-FM3042		SZFT-HG-FM3042	SZFT-HC-FM3042
\$505	\$584	\$560		\$717	\$818
SZFT-FG-FM2048	SZFT-FC-FM2048	SZFT-AG-FM2048		Special Order	
\$466	\$547	\$521			
SZFT-FG-FM2448	SZFT-FC-FM2448	SZFT-AG-FM2448		SZFT-HG-FM2448	SZFT-HC-FM2448
\$509	\$587	\$561		\$717	\$819
SZFT-FG-FM3048	SZFT-FC-FM3048	SZFT-AG-FM3048		SZFT-HG-FM3048	SZFT-HC-FM3048
\$526	\$608	\$582		\$735	\$839
SZFT-FG-FM2054	SZFT-FC-FM2054	SZFT-AG-FM2054		Special Order	
\$494	\$577	\$552			
SZFT-FG-FM2454	SZFT-FC-FM2454	SZFT-AG-FM2454		SZFT-HG-FM2454	SZFT-HC-FM2454
\$524	\$605	\$578		\$739	\$843
SZFT-FG-FM3054	SZFT-FC-FM3054	SZFT-AG-FM3054		SZFT-HG-FM3054	SZFT-HC-FM3054
\$542	\$621	\$598		\$756	\$860
SZFT-FG-FM2060	SZFT-FC-FM2060	SZFT-AG-FM2060		Special Order	
\$566	\$647	\$620			
SZFT-FG-FM2460	SZFT-FC-FM2460	SZFT-AG-FM2460		SZFT-HG-FM2460	SZFT-HC-FM2460
\$576	\$657	\$629		\$768	\$872
SZFT-FG-FM3060	SZFT-FC-FM3060	SZFT-AG-FM3060		SZFT-HG-FM3060	SZFT-HC-FM3060
\$583	\$664	\$640		\$777	\$880



③ ADD OPTION CODES and PRICES

Add an Option Code for each category to base Model Number.
Add the price for each selected Option to base price.

Top Cutout	ShuttleLatch	Wire Tray
<p>-X No cutout N/C</p>	<p>-X No Latch N/C</p>	<p>-X No Modesty Tray N/C</p>
<p>-G One 3" Grommet \$31</p>	<p>-L ShuttleLatch \$56</p>	<p>-M 12" Modesty Height Wire Manager (stations 36" or wider) \$180</p>
<p>-2 Two Grommets (stations 48" or wider) \$62</p>		
<p>-E MiniPort \$284</p>		

EXAMPLE

- ① 24 x 60 Forum Profile ShuttleZone Table
- ② on Fixed Arc Legs with Glides and...
- ③ one grommet, ShuttleLatch, no wire tray

MODEL NUMBER	
Model Number	Option Codes
SZFT-FG-FM2460	- G - L - X

PRODUCT PRICE	
Base Price	Option Prices
\$576	+ \$31 + \$56 + 0
Total Price:	
\$663	

WORKSHEET

MODEL NUMBER	
Model Number	Option Codes
	- - -

PRODUCT PRICE	
Base Price	Option Prices
\$	+ + +
Total Price:	
\$	

Please contact your ShuttleSystem dealer to obtain discounted project pricing.

Available Accessories:	see page
• Book Boxes	13
• Power / Data MiniPort	13
• Keyboard Tray	13

◁ **WAVE PROFILE SHAPE** 20"D / 24"D / 30"D



① CHOOSE SIZE

Width	Depth
26" Wave Profile	20" D
	24" D
	30" D
30" Wave Profile	20" D
	24" D
	30" D
36" Wave Profile	20" D
	24" D
	30" D
42" Wave Profile	20" D
	24" D
	30" D
48" Wave Profile	20" D
	24" D
	30" D
54" Wave Profile	20" D
	24" D
	30" D
60" Wave Profile	20" D
	24" D
	30" D
72" Wave Profile	20" D
	24" D
	30" D

② SELECT LEG STYLE for base model number and base price

Fixed Arc Leg		Adjustable Arc Leg		Adjustable Pedestal Leg	
29"		22"-31"		22" - 32"	
Glides	Casters	Glides		Glides	Casters
SZFT-FG-WV2026	SZFT-FC-WV2026	SZFT-AG-WV2026		Special Order	
\$276	\$343	\$294			
SZFT-FG-WV2426	SZFT-FC-WV2426	SZFT-AG-WV2426		SZFT-HG-WV2426	SZFT-HC-WV2426
\$427	\$509	\$482		\$650	\$754
SZFT-FG-WV3026	SZFT-FC-WV3026	SZFT-AG-WV3026		SZFT-HG-WV3026	SZFT-HC-WV3026
\$424	\$518	\$492		\$672	\$776
SZFT-FG-WV2030	SZFT-FC-WV2030	SZFT-AG-WV2030		Special Order	
\$383	\$465	\$440			
SZFT-FG-WV2430	SZFT-FC-WV2430	SZFT-AG-WV2430		SZFT-HG-WV2430	SZFT-HC-WV2430
\$448	\$527	\$499		\$662	\$760
SZFT-FG-WV3030	SZFT-FC-WV3030	SZFT-AG-WV3030		SZFT-HG-WV3030	SZFT-HC-WV3030
\$467	\$550	\$524		\$672	\$776
SZFT-FG-WV2036	SZFT-FC-WV2036	SZFT-AG-WV2036		Special Order	
\$406	\$487	\$461			
SZFT-FG-WV2436	SZFT-FC-WV2436	SZFT-AG-WV2436		SZFT-HG-WV2436	SZFT-HC-WV2436
\$466	\$547	\$521		\$672	\$776
SZFT-FG-WV3036	SZFT-FC-WV3036	SZFT-AG-WV3036		SZFT-HG-WV3036	SZFT-HC-WV3036
\$488	\$570	\$544		\$692	\$796
SZFT-FG-WV2042	SZFT-FC-WV2042	SZFT-AG-WV2042		Special Order	
\$435	\$518	\$492			
SZFT-FG-WV2442	SZFT-FC-WV2442	SZFT-AG-WV2442		SZFT-HG-WV2442	SZFT-HC-WV2442
\$487	\$569	\$542		\$699	\$798
SZFT-FG-WV3042	SZFT-FC-WV3042	SZFT-AG-WV3042		SZFT-HG-WV3042	SZFT-HC-WV3042
\$505	\$584	\$560		\$717	\$818
SZFT-FG-WV2048	SZFT-FC-WV2048	SZFT-AG-WV2048		Special Order	
\$466	\$547	\$521			
SZFT-FG-WV2448	SZFT-FC-WV2448	SZFT-AG-WV2448		SZFT-HG-WV2448	SZFT-HC-WV2448
\$509	\$587	\$561		\$717	\$819
SZFT-FG-WV3048	SZFT-FC-WV3048	SZFT-AG-WV3048		SZFT-HG-WV3048	SZFT-HC-WV3048
\$526	\$608	\$582		\$735	\$839
SZFT-FG-WV2054	SZFT-FC-WV2054	SZFT-AG-WV2054		Special Order	
\$494	\$577	\$552			
SZFT-FG-WV2454	SZFT-FC-WV2454	SZFT-AG-WV2454		SZFT-HG-WV2454	SZFT-HC-WV2454
\$524	\$605	\$578		\$739	\$843
SZFT-FG-WV3054	SZFT-FC-WV3054	SZFT-AG-WV3054		SZFT-HG-WV3054	SZFT-HC-WV3054
\$542	\$621	\$598		\$756	\$860
SZFT-FG-WV2060	SZFT-FC-WV2060	SZFT-AG-WV2060		Special Order	
\$566	\$647	\$620			
SZFT-FG-WV2460	SZFT-FC-WV2460	SZFT-AG-WV2460		SZFT-HG-WV2460	SZFT-HC-WV2460
\$576	\$657	\$629		\$768	\$872
SZFT-FG-WV3060	SZFT-FC-WV3060	SZFT-AG-WV3060		SZFT-HG-WV3060	SZFT-HC-WV3060
\$583	\$664	\$640		\$777	\$880
SZFT-FG-WV2072	SZFT-FC-WV2072	SZFT-AG-WV2072		Special Order	
\$634	\$714	\$688			
SZFT-FG-WV2472	SZFT-FC-WV2472	SZFT-AG-WV2472		SZFT-HG-WV2472	SZFT-HC-WV2472
\$653	\$733	\$709		\$854	\$951
SZFT-FG-WV3072	SZFT-FC-WV3072	SZFT-AG-WV3072		SZFT-HG-WV3072	SZFT-HC-WV3072
\$676	\$755	\$730		\$875	\$973



③ ADD OPTION CODES and PRICES

Add an Option Code for each category to base Model Number.

Add the price for each selected Option to base price.

Top Cutout	ShuttleLatch	Wire Tray
<p>-X No cutout N/C</p>	<p>-X No Latch N/C</p>	<p>-X No Modesty Tray N/C</p>
<p>-G One 3" Grommet \$31</p>	<p>-L Shuttlelatch \$56</p>	<p>-M 12" Modesty Height Wire Manager (stations 36" or wider) \$180</p>
<p>-2 Two Grommets (stations 48" or wider) \$62</p>		
<p>-E MiniPort \$284</p>		

EXAMPLE

- ① 24 x 60 Wave Profile ShuttleZone Table
- ② on Fixed Arc Legs with Glides and...
- ③ one grommet, ShuttleLatch, no wire tray

MODEL NUMBER	
Model Number	Option Codes
SZFT-FG-WV2460	- G - L - X

PRODUCT PRICE	
Base Price	Option Prices
\$576	+ \$31 + \$56 + 0
Total Price:	
\$663	

WORKSHEET



MODEL NUMBER	
Model Number	Option Codes
	- - -

PRODUCT PRICE	
Base Price	Option Prices
\$	+ + +
Total Price:	
\$	

Please contact your ShuttleSystem dealer to obtain discounted project pricing.

Available Accessories:	see page
• Book Boxes	13
• Power / Data MiniPort	13
• Keyboard Tray	13

CORNER PROFILE SHAPE

① CHOOSE SIZE		② SELECT LEG STYLE for base model number and base price		
		Fixed Arc Leg		Adjustable Arc Leg
		29"		22"-31"
Size		Glides	Casters	Glides
Corner Profile 24" Modular Depth				
	42" D	SZFT-FG-CN2442	SZFT-FC-CN2442	SZFT-AG-CN2442
	42" W	\$553	\$638	\$611
24" ↑↓	48" D	SZFT-FG-CN2448	SZFT-FC-CN2448	SZFT-AG-CN2448
	48" W	\$597	\$678	\$653
Corner Profile 30" Modular Depth				
	42" D	SZFT-FG-CN3042	SZFT-FC-CN3042	SZFT-AG-CN3042
	42" W	\$597	\$678	\$653
30" ↑↓	48" D	SZFT-FG-CN3048	SZFT-FC-CN3048	SZFT-AG-CN3048
	48" W	\$638	\$718	\$691

USING CORNER PROFILE SHAPES

Corner Profile Groupings
Combine with other modular shapes to make L-shaped workspaces, perpendicular rows, peninsulas or pods.

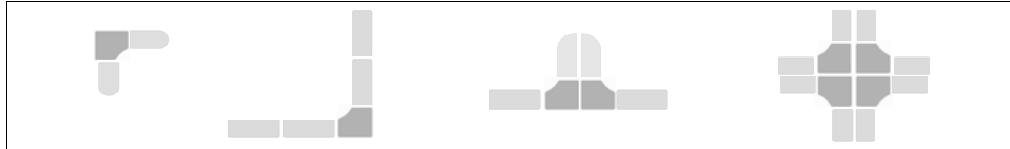



③ ADD OPTION CODES and PRICES

Add an Option Code for each category to base Model Number.

Add the price for each selected Option to base price.

Top Cutout	ShuttleLatch	Wire Tray
<p>-X No cutout N/C</p>	<p>-X No Latch N/C</p>	<p>-X No Modesty Tray N/C</p>
<p>-G One 3" Grommet \$31</p>	<p>-L Shuttlelatch \$56</p>	<p>-M 12" Modesty Height Wire Manager \$180</p>
<p>-2 Two Grommets \$62</p>		
<p>-E MiniPort \$284</p>		

EXAMPLE

- ① 42" Corner Profile (24" Modular)
- ② on Fixed Arc Legs with Glides and...
- ③ one grommet, ShuttleLatch, no wire tray

MODEL NUMBER	
Model Number	Option Codes
SZFT-FG-CN2442	- G - L - X
PRODUCT PRICE	
Base Price	Option Prices
\$553	+ \$31 + \$56 + 0
Total Price:	
\$640	

WORKSHEET



MODEL NUMBER	
Model Number	Option Codes
	- - -
PRODUCT PRICE	
Base Price	Option Prices
\$	+ + +
Total Price:	
\$	



Please contact your ShuttleSystem dealer to obtain discounted project pricing.

MODULAR ROUNDED SHAPES

① CHOOSE SHAPE & SIZE

② SELECT LEG STYLE for base model number and base price

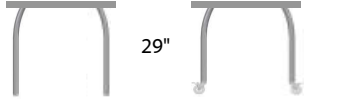
	Size
Conference End Left 	20" D 54" W
	24" D 60" W
Conference End Right 	20" D 54" W
	24" D 60" W
Half Round 	24" D 48" W
	27" D 54" W
Conference Pod 	30" D 48" W

Fixed Arc Leg		Adjustable Arc Leg	
			
29"		22"-31"	
Glides	Casters	Glides	
SZFT-FG-CL2054 \$494	SZFT-FC-CL2054 \$577	SZFT-AG-CL2054 \$552	
SZFT-FG-CL2460 \$576	SZFT-FC-CL2460 \$657	SZFT-AG-CL2460 \$629	
SZFT-FG-CL3060 \$583	SZFT-FC-CL3060 \$664	SZFT-AG-CL3060 \$640	
SZFT-FG-CR2054 \$494	SZFT-FC-CR2054 \$577	SZFT-AG-CR2054 \$552	
SZFT-FG-CR2460 \$576	SZFT-FC-CR2460 \$657	SZFT-AG-CR2460 \$629	
SZFT-FG-CR3060 \$583	SZFT-FC-CR3060 \$664	SZFT-AG-CR3060 \$640	
SZFT-FG-HR2448 \$509	SZFT-FC-HR2448 \$587	SZFT-AG-HR2448 \$561	
SZFT-FG-HR2754 \$542	SZFT-FC-HR2754 \$621	SZFT-AG-HR2754 \$598	
SZFT-FG-HR3060 \$556	SZFT-FC-HR3060 \$638	SZFT-AG-HR3060 \$612	
SZFT-FG-CP3048 \$626	SZFT-FC-CP3048 \$706	SZFT-AG-CP3048 \$682	

USING MODULAR ROUNDED SHAPES

Conference End Groupings

Combine with other modular shapes to make ovals, peninsulas outside corners or to create curved ends on straight rows.



Half Round Groupings

Combine with other modular shapes to make circles, ovals or peninsulas.

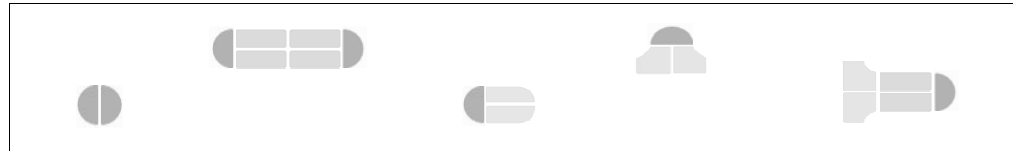

Conference Pod Groupings

Expand a desk or workspace with a small conference area or create a group gathering area at the end of a row.

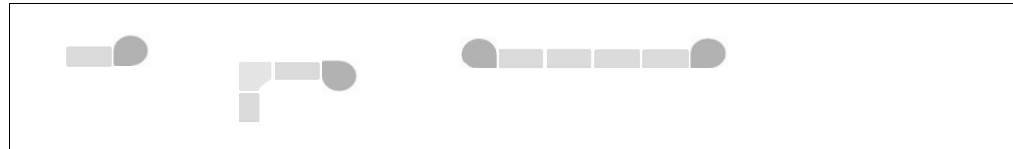







③ ADD OPTION CODES and PRICES

EXAMPLE

Add an Option Code for each category to base Model Number.
Add the price for each selected Option to base price.

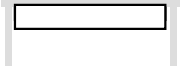
- ① 24 x 60 Conference End Left ShuttleZone Table
- ② on Fixed Arc Legs with Glides and...
- ③ one grommet, ShuttleLatch, no wire tray

Top Cutout	ShuttleLatch	Wire Tray
<p>-X No cutout N/C</p> 	<p>-X No Latch N/C</p>	<p>-X No Modesty Tray N/C</p>
<p>-G One 3" Grommet</p> <p>\$31</p> 	<p>-L Shuttlelatch</p> <p>\$56</p> 	<p>-M 12" Modesty Height Wire Manager</p> <p>\$180</p> 
<p>-2 Two Grommets</p> <p>\$62</p> 		<p><i>*Modesty Panel Option not available on Conference Pod</i></p>
<p>-E MiniPort</p> <p>\$284</p> 		

MODEL NUMBER	
Model Number	Option Codes
SZFT-FG-CL2460	- G - L - X
PRODUCT PRICE	
Base Price	Option Prices
\$576	+ \$31 + \$56 + 0
Total Price:	
\$663	

WORKSHEET	
MODEL NUMBER	
Model Number	Option Codes
_____	- - - -
PRODUCT PRICE	
Base Price	Option Prices
\$	+ + +
Total Price:	
\$	

Please contact your ShuttleSystem dealer to obtain discounted project pricing.

SPECIALTY SHAPES



① CHOOSE SHAPE & SIZE

② SELECT LEG STYLE for base model number and base price

Width Size



Trapezoid



Kidney



Fixed Arc Leg

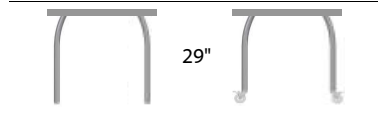

Adjustable Arc Leg

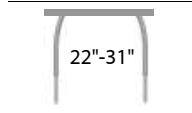

	Glides	Casters	Glides
SZFT-FG-RD3636	SZFT-FC-RD3636	SZFT-AG-RD3636	
\$587	\$669	\$644	
SZFT-FG-RD4242	SZFT-FC-RD4242	SZFT-AG-RD4242	
\$598	\$679	\$653	
SZFT-FG-RD4848	SZFT-FC-RD4848	SZFT-AG-RD4848	
\$640	\$722	\$694	
SZFT-FG-RD5454	SZFT-FC-RD5454	SZFT-AG-RD5454	
\$779	\$861	\$834	
SZFT-FG-RD6060	SZFT-FC-RD6060	SZFT-AG-RD6060	
\$807	\$886	\$861	
SZFT-FG-TR2448	SZFT-FC-TR2448	SZFT-AG-TR2448	
\$507	\$587	\$561	
SZFT-FG-TR2754	SZFT-FC-TR2754	SZFT-AG-TR2754	
\$542	\$623	\$598	
SZFT-FG-TR3060	SZFT-FC-TR3060	SZFT-AG-TR3060	
\$556	\$639	\$612	
SZFT-FG-KD4872	SZFT-FC-KD4872	SZFT-AG-KD4872	
\$994	\$1,075	\$1,050	

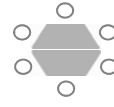

Trapezoids can be used in pairs to create six-person groupings.



Kidneys are typically used in primary grades to center students around instructor.

ACCESSORIES

Mobile Storage Pedestals

Mobile

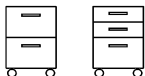

2-Drawer (12"/12")

2PED-18-M-12/12-L

\$861

3-Drawer (6"/6"/12")

3PED-18-M-6/6/12-L

\$908

> Sized to roll beneath 29" high tables

> Dimensions 15" W x 19" D x 27" H

> Locking Drawers

Pencil Drawers

Basic Pencil Drawer

Basic

ACC-PD-B

\$124

Professional Pencil Drawer

ACC-PD-P

\$396

Book Boxes

Wire Book Box

Basic

ACC-WB

\$54

Molded Book Box

ACC-MB

\$54

Metal Book Box

Acc-MTL-Bookbox

\$80

Technology Accessories

Basic CPU Holder
(for Pedestal Leg tables only)

ACC-CPUH-B

\$215

Deluxe CPU Holder - Fixed

ACC-CPUH-DF

\$300

Deluxe CPU Holder
Slide-out / Swivel

ACC-CPUH-DS

\$416

Keyboard Tray

ACC-K24

\$234

MiniPort

ACC-MINIPOINT

\$284



Storage Totes

3" Tote

ACC-T3

\$30

6" Tote

ACC-T6

\$42

ShuttleZone

Instructor & Administrative Desks



Open Space Desks



Latchable Desks



Pedestal Desks







Techera Workstations



Wonderfully flexible and technology-savvy, our Mobile ShuttleZone Workspaces are perfect for the leaders and teachers of today's schools.

Choose from dozens of high-performance formats to suit your needs and budget.

INDEX

CATEGORY		PAGE	
Instructor Desks & Administrator Desks		Open Space Desks	16 - 17
		Open Space Mobile Workspace / Storage	18 - 19
		Latchable Desks	20 - 21
		Latchable Mobile Workspace / Storage	22 - 23
		Single-Pedestal Desks	24 - 27
		Double-Pedestal Desks	28 - 29
		Techera Workstations	30 - 31
ShuttleZone Accessories		Mobile Pedestals	32
		Storage Totes	32
		Book Boxes & Center Drawers	32
		Technology Accessories	32





Shipping of ShuttleZone Instructor Desks & Administrative Desks

- > All orders of 10 stations and over will be bulk packed on pallets.
- > Orders under 10 stations may be individually cartoned (large components may also be palletized).
- > Freight classification is 70 for non-pedestal desks.
- > Freight classification is 125 for pedestal desks and Techeras.



◁ **OPEN SPACE DESKS**

① **CHOOSE SHAPE & SIZE**

	Size
Flux Desk 	30" D 54" W
	30" D 60" W
	30" D 72" W
	30" D 72" W
Straight Desk 	30" D 54" W
	30" D 60" W
	30" D 72" W
	30" D 72" W
Conference Desk Left 	30" D 54" W
	30" D 60" W
	30" D 72" W
	30" D 72" W
Conference Desk Right 	30" D 54" W
	30" D 60" W
	30" D 72" W
	30" D 72" W

② **SELECT LEG STYLE for base model number and base price**

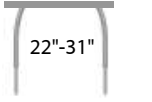
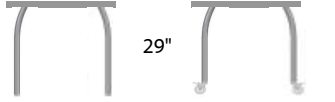
Fixed S Leg		Adjustable Arc Leg		Fixed Arc Leg	
					
Glides	Casters	Glides	Glides	Glides	Casters
SZFT-SG-FX3054 \$542	SZFT-SC-FX3054 \$621	SZFT-AG-FX3054 \$598		SZFT-FG-FX3054 \$542	SZFT-FC-FX3054 \$621
SZFT-SG-FX3060 \$583	SZFT-SC-FX3060 \$664	SZFT-AG-FX3060 \$640		SZFT-FG-FX3060 \$583	SZFT-FC-FX3060 \$664
SZFT-SG-FX3072 \$676	SZFT-SC-FX3072 \$755	SZFT-AG-FX3072 \$730		SZFT-FG-FX3072 \$676	SZFT-FC-FX3072 \$755
SZFT-SG-ST3054 \$542	SZFT-SC-ST3054 \$621	SZFT-AG-ST3054 \$598		SZFT-FG-ST3054 \$542	SZFT-FC-ST3054 \$621
SZFT-SG-ST3060 \$583	SZFT-SC-ST3060 \$664	SZFT-AG-ST3060 \$640		SZFT-FG-ST3060 \$583	SZFT-FC-ST3060 \$664
SZFT-SG-ST3072 \$676	SZFT-SC-ST3072 \$755	SZFT-AG-ST3072 \$730		SZFT-FG-ST3072 \$676	SZFT-FC-ST3072 \$755
SZFT-SG-BL3054 \$542	SZFT-SC-BL3054 \$621	SZFT-AG-BL3054 \$598		SZFT-FG-BL3054 \$542	SZFT-FC-BL3054 \$621
SZFT-SG-BL3060 \$583	SZFT-SC-BL3060 \$664	SZFT-AG-BL3060 \$640		SZFT-FG-BL3060 \$583	SZFT-FC-BL3060 \$664
SZFT-SG-BL3072 \$676	SZFT-SC-BL3072 \$755	SZFT-AG-BL3072 \$730		SZFT-FG-BL3072 \$676	SZFT-FC-BL3072 \$755
SZFT-SG-BR3054 \$542	SZFT-SC-BR3054 \$621	SZFT-AG-BR3054 \$598		SZFT-FG-BR3054 \$542	SZFT-FC-BR3054 \$621
SZFT-SG-BR3060 \$583	SZFT-SC-BR3060 \$664	SZFT-AG-BR3060 \$640		SZFT-FG-BR3060 \$583	SZFT-FC-BR3060 \$664
SZFT-SG-BR3072 \$676	SZFT-SC-BR3072 \$755	SZFT-AG-BR3072 \$730		SZFT-FG-BR3072 \$676	SZFT-FC-BR3072 \$755

WORKS WELL WITH OTHERS:

Customize and expand your Open Space Desk with these matching storage and workspace units.

Satellite Support Module

An Open Space favorite: available in two sizes and various storage formats.

See page 18

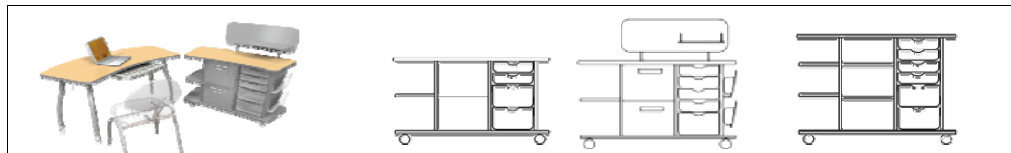

Complementary Shapes

Expand your workspace instantly with any ShuttleZone MultiPurpose table shape.

See pages 2 - 12



Mobile Wardrobes & Cabinets

Equip yourself with flexible storage for supplies, equipment and personal belongings.

See pages 34 - 44

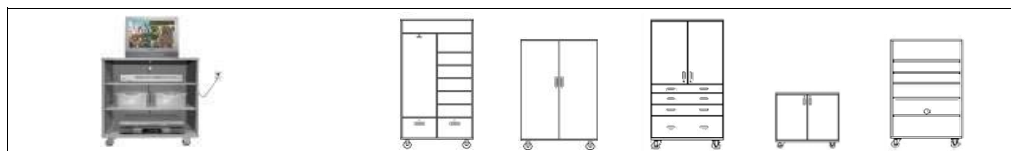

Adjustable Pedestal Leg

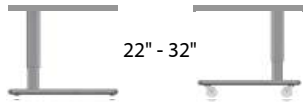

Glides	Casters
SZFT-HG-FX3054 \$756	SZFT-HC-FX3054 \$860
SZFT-HG-FX3060 \$777	SZFT-HC-FX3060 \$880
SZFT-HG-FX3072 \$875	SZFT-HC-FX3072 \$973
SZFT-HG-ST3054 \$756	SZFT-HC-ST3054 \$860
SZFT-HG-ST3060 \$777	SZFT-HC-ST3060 \$880
SZFT-HG-ST3072 \$875	SZFT-HC-ST3072 \$973
SZFT-HG-BL3054 \$756	SZFT-HC-BL3054 \$860
SZFT-HG-BL3060 \$777	SZFT-HC-BL3060 \$880
SZFT-HG-BL3072 \$875	SZFT-HC-BL3072 \$973
SZFT-HG-BR3054 \$756	SZFT-HC-BR3054 \$860
SZFT-HG-BR3060 \$777	SZFT-HC-BR3060 \$880
SZFT-HG-BR3072 \$875	SZFT-HC-BR3072 \$973

③ ADD OPTION CODES and PRICES

Add Option Codes to base Model Number.
Add each selected Option price to base price.

Top Cutout	Wire Tray
<p>-X No cutout N/C</p>	<p>-X No Modesty Tray N/C</p>
<p>-G One 3" Grommet \$31</p>	<p>-M 12" Modesty Height Wire Manager \$180</p>
<p>-E MiniPort \$284</p>	

EXAMPLE

- ① 30 x 60 Flux Desk
- ② on Fixed S-Legs with glides and...
- ③ no Top Cutout and Modesty Height Wire Tray

MODEL NUMBER	
Model Number	Option Codes
SZFT-SG-FX3060	- X - X - M <small>no latch Δ available</small>
PRODUCT PRICE	
Base Price	Option Prices
\$583	+ 0 + 0 + \$180 <small>no latch Δ available</small>
Total Price:	
\$763	

WORKSHEET

MODEL NUMBER	
Model Number	Option Codes
	- - X - <small>no latch Δ available</small>
PRODUCT PRICE	
Base Price	Option Prices
\$	+ + 0 + <small>no latch Δ available</small>
Total Price:	
\$	

Available Accessories: see page

• Power / Data MiniPort	32
• Keyboard Tray	32
• CPU Holders	32
• Center Drawer	32
• Mobile Pedestal	32

Please contact your ShuttleSystem dealer to obtain discounted project pricing.



◀ OPEN SPACE MOBILE WORKSPACE / STORAGE

Satellite Support Modules

LOW - 29" (48" W x 24" D)

STANDARD CONFIGURATION

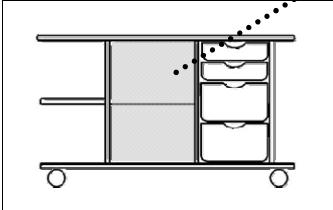

All Shelves in Shelf Bay
4 Totes in Tote Bay

SZSSM-29
\$1,620

SHELF BAY FORMATS

Standard 1 Drawer 2 Drawers 3 Drawers

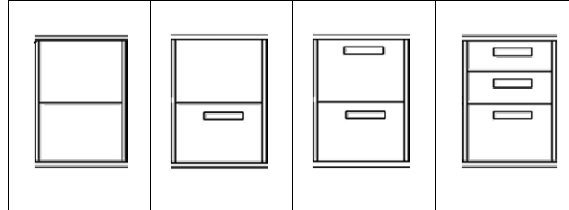

Shelf Shelf	Shelf File Drawer	File Drawer File Drawer	6" Drawer 6" Drawer File Drawer
----------------	----------------------	----------------------------	---------------------------------------

Add for Shelf Bay selection:

-XX22	-X122	-X222	-2122
\$0	\$246	\$490	\$586

STORAGE ACCESSORIES

Paper Trays

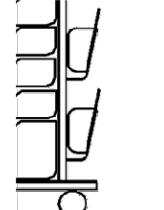

Two trays,
vertical

Add for Storage Accessories:

- 2
\$105

TALL - 42" (48" W x 24" D)

STANDARD CONFIGURATION

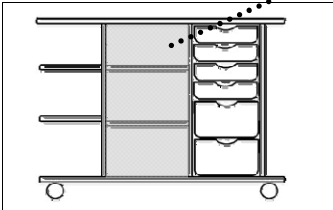

All Shelves in Shelf Bay
6 Totes in Totes Bay

SZSSM-42
\$2,387

SHELF BAY FORMATS

Standard 1 Drawer 2 Drawers 3 Drawers 4 Drawers

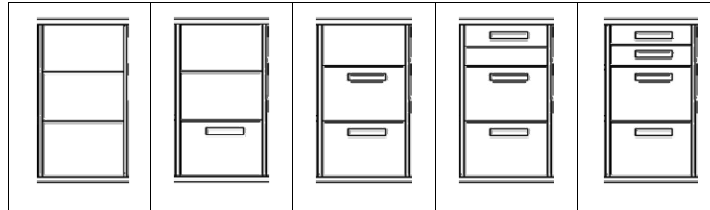

Shelf Shelf Shelf	Shelf Shelf File Drawer	Shelf File Drawer File Drawer	6" Drawer Half Shelf File Drawer File Drawer	6" Drawer 6" Drawer File Drawer File Drawer
-------------------------	-------------------------------	-------------------------------------	---	--

Add for Shelf Bay selection:

-XX42	-X142	-X242	-1242	-2242
\$0	\$246	\$490	\$659	\$828

STORAGE ACCESSORIES

Paper Trays

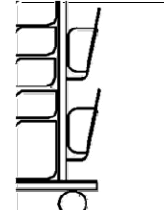

Three trays,
vertical

Add for Storage Accessories:

- 3
\$155

Mobile Storage Pedestals

- > Sized to roll beneath
29" high ShuttleZone Desks
- > Dimensions:
15" W x 19" D x 27" H
- > Locking Drawers

Two Drawers

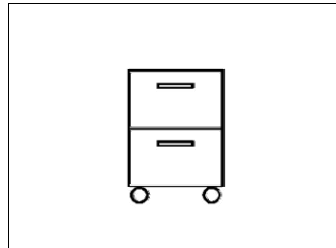

12" File
12" File

2PED-18-M-12/12-L

\$861

Three Drawers

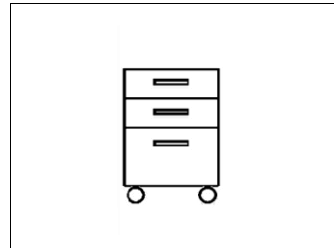

6" Drawer
6" Drawer
12" File

3PED-18-M-6/6/12-L

\$908



◁ LATCHABLE DESKS

① CHOOSE SHAPE & SIZE

	Size
Straight Desk	30" D 54" W
	30" D 60" W
	30" D 72" W
	30" D 72" W
Conference Desk Left	30" D 54" W
	30" D 60" W
	30" D 72" W
	30" D 72" W
Conference Desk Right	30" D 54" W
	30" D 60" W
	30" D 72" W
	30" D 72" W

② SELECT LEG STYLE for base model number and base price

Fixed S Leg		Adjustable Arc Leg		Fixed Arc Leg	
29"		22"-31"		29"	
Glides	Casters	Glides	Glides	Casters	Casters
SZFT-SG-ST3054	SZFT-SC-ST3054	SZFT-AG-ST3054	SZFT-FG-ST3054	SZFT-FC-ST3054	SZFT-FC-ST3054
\$542	\$621	\$598	\$542	\$621	\$621
SZFT-SG-ST3060	SZFT-SC-ST3060	SZFT-AG-ST3060	SZFT-FG-ST3060	SZFT-FC-ST3060	SZFT-FC-ST3060
\$583	\$664	\$640	\$583	\$664	\$664
SZFT-SG-ST3072	SZFT-SC-ST3072	SZFT-AG-ST3072	SZFT-FG-ST3072	SZFT-FC-ST3072	SZFT-FC-ST3072
\$676	\$755	\$730	\$676	\$755	\$755
SZFT-SG-BL3054	SZFT-SC-BL3054	SZFT-AG-BL3054	SZFT-FG-BL3054	SZFT-FC-BL3054	SZFT-FC-BL3054
\$542	\$621	\$598	\$542	\$621	\$621
SZFT-SG-BL3060	SZFT-SC-BL3060	SZFT-AG-BL3060	SZFT-FG-BL3060	SZFT-FC-BL3060	SZFT-FC-BL3060
\$583	\$664	\$640	\$583	\$664	\$664
SZFT-SG-BL3072	SZFT-SC-BL3072	SZFT-AG-BL3072	SZFT-FG-BL3072	SZFT-FC-BL3072	SZFT-FC-BL3072
\$676	\$755	\$730	\$676	\$755	\$755
SZFT-SG-BR3054	SZFT-SC-BR3054	SZFT-AG-BR3054	SZFT-FG-BR3054	SZFT-FC-BR3054	SZFT-FC-BR3054
\$542	\$621	\$598	\$542	\$621	\$621
SZFT-SG-BR3060	SZFT-SC-BR3060	SZFT-AG-BR3060	SZFT-FG-BR3060	SZFT-FC-BR3060	SZFT-FC-BR3060
\$583	\$664	\$640	\$583	\$664	\$664
SZFT-SG-BR3072	SZFT-SC-BR3072	SZFT-AG-BR3072	SZFT-FG-BR3072	SZFT-FC-BR3072	SZFT-FC-BR3072
\$676	\$755	\$730	\$676	\$755	\$755

WORKS WELL WITH OTHERS:

Customize and expand your Latchable Desk with these matching storage and workspace units.

Latchable Storage Return

A mobile and comprehensive storage system that latches to your desk. In two sizes.

See page 22

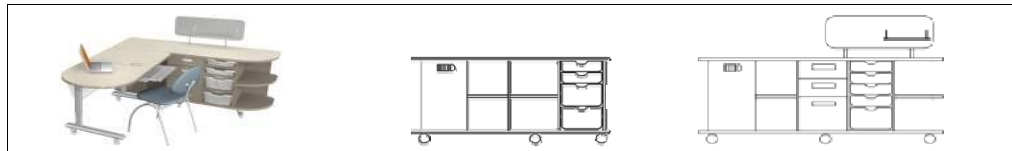

Complementary Shapes

Add ShuttleZone shapes to expand your desk or create L-shaped workspaces.

See pages 2 - 12

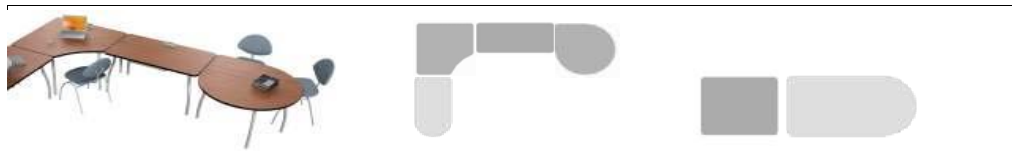

Mobile Pedestals

Tuck a Mobile Pedestal beneath any desk or a complimentary shape.

See page 23



Mobile Storage

Equip yourself with flexible storage for supplies, equipment and personal belongings.

See pages 34 - 44

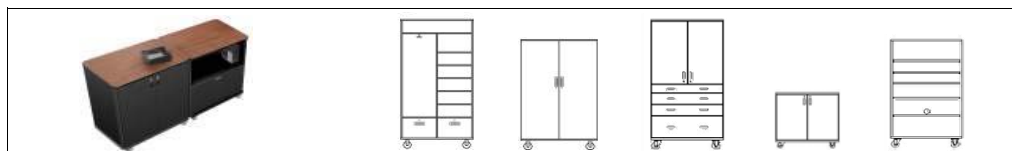

Adjustable Pedestal Leg

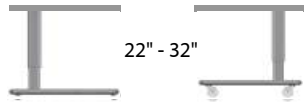

Glides	Casters
SZFT-HG-ST3054 \$756	SZFT-HC-ST3054 \$860
SZFT-HG-ST3060 \$777	SZFT-HC-ST3060 \$880
SZFT-HG-ST3072 \$875	SZFT-HC-ST3072 \$973
SZFT-HG-BL3054 \$756	SZFT-HC-BL3054 \$860
SZFT-HG-BL3060 \$777	SZFT-HC-BL3060 \$880
SZFT-HG-BL3072 \$875	SZFT-HC-BL3072 \$973
SZFT-HG-BR3054 \$756	SZFT-HC-BR3054 \$860
SZFT-HG-BR3060 \$777	SZFT-HC-BR3060 \$880
SZFT-HG-BR3072 \$875	SZFT-HC-BR3072 \$973



PLEASE NOTE:

The Latchable Return works best with desks on Pedestal style legs.

③ ADD OPTION CODES and PRICES

Add Option Codes to base Model Number.
Add each selected Option price to base price.

Top Cutout

-X No cutout N/C
-G One 3" Grommet \$31
-E MiniPort \$284

Wire Tray

-X No Modesty Tray N/C
-M 12" Modesty Height Wire Manager \$180

ShuttleLatch

-X No Latch N/C	-L ShuttleLatch \$56
-------------------------------------	--

EXAMPLE

Assumes ShuttleLatch on all desks

- ① 30 x 60 Conference Desk Left ShuttleZone Table
- ② on Fixed Arc Legs with Glides and...
- ③ one grommet, ShuttleLatch, no wire tray

MODEL NUMBER

Model Number	Option Codes
SZFT-FG-ST3060	- G - L - X

ShuttleLatch Code

Base Price	Option Prices
\$583	+ \$31 + \$56 + 0
ShuttleLatch Price	
\$670	

WORKSHEET

MODEL NUMBER

Model Number	Option Codes
-	- - -

ShuttleLatch Code

PRODUCT PRICE

Base Price	Option Prices
\$	+ + +
ShuttleLatch Price	
Total Price:	
\$	

Please contact your ShuttleSystem dealer to obtain discounted project pricing.

Available Accessories:	see page
• Power / Data MiniPort	32
• Keyboard Tray	32
• CPU Holders	32
• Center Drawer	32
• Mobile Pedestal	32



◀ LATCHABLE MOBILE WORKSPACE / STORAGE

Latchable Returns

EXTENDED - 72" Long (29" H x 24" D)

STANDARD CONFIGURATION		SHELF BAY FORMATS				STORAGE ACCESSORIES
Choose Left or Right (shown below) orientation		Standard	1 Drawer	2 Drawers	3 Drawers	Auxiliary Bay Doors
<p>> All Shelves in Shelf Bay > No Auxiliary Doors > 4 Totes in Tote Bay > No Organizer Panel</p>		<p>Shelf Shelf</p>	<p>Shelf File Drawer</p>	<p>File Drawer File Drawer</p>	<p>6" Drawer 6" Drawer File Drawer</p>	<p>Locking doors on front end storage provide security</p>
Left	Right	Add for Shelf Bay selection:				Add for Storage Accessories:
SZLR-L72	SZLR-R72	-XX22	-X122	-X222	-2122	- D
\$2,357	\$2,357	\$0	\$246	\$490	\$586	\$184

COMPACT - 61" Long (29" H x 24" D)

STANDARD CONFIGURATION		SHELF BAY FORMATS				STORAGE ACCESSORIES
Choose Left or Right (shown below) orientation		Standard	1 Drawer	2 Drawers	3 Drawers	Auxiliary Bay Doors
<p>> All Shelves in Shelf Bay > No Auxiliary Doors > 4 Totes in Tote Bay > No Organizer Panel</p>		<p>Shelf Shelf</p>	<p>Shelf File Drawer</p>	<p>File Drawer File Drawer</p>	<p>6" Drawer 6" Drawer File Drawer</p>	<p>Locking doors on front end storage provide security</p>
Left	Right	Add for Shelf Bay selection:				Add for Storage Accessories:
SZLR-L60	SZLR-R60	-XX22	-X122	-X222	-2122	- D
\$2,239	\$2,239	\$0	\$246	\$490	\$586	# \$184

The Latchable Return works best with desks that have the ShuttleLatch option and Pedestal style legs.

Mobile Storage Pedestals

- > Sized to roll beneath
29" high ShuttleZone Desks
- > Dimensions:
15" W x 19" D x 27" H
- > Locking Drawers

Two Drawers

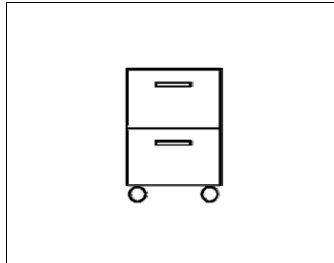

12" File
12" File

2PED-18-M-12/12-L

\$861

Three Drawers



6" Drawer
6" Drawer
12" File

3PED-18-M-6/6/12-L

\$908



◀ **Single Pedestal Desks - Left Hand Pedestal**

① **CHOOSE SIZE** for base model number & price

② **CHOOSE LEFT PEDESTAL**

③ **CHOOSE RIGHT SUPPORT**

*Add Codes for left and right supports to base Model Number
and add accompanying prices to the base price.*

	Size	
Straight Desk with Left-Hand Pedestal	30" D	SZPD54
	54" W	\$1,392
	30" D	SZPD60
	60" W	\$1,434
	30" D	SZPD72
	72" W	\$1,524

		Glides	Casters		
	-GO Open Shelves N/C		-CO Open Shelves N/C		
	-GS Fixed S Leg N/C				-CS Fixed S Leg \$42
	-GD Shelves with Door \$170		-CD Shelves with Door \$170		
	-GA Fixed Arc Leg N/C				-CA Fixed Arc Leg \$42
	-G1 One Drawer \$248		-C1 One Drawer \$248		
	-G2 Two Drawers \$493		-C2 Two Drawers \$493		
	-G3 Three Drawers \$593		-C3 Three Drawers \$593		



Built-in Writing Trays:
All supporting pedestals include space-saving pull-out writing trays

Locks:
Locks are standard on all drawers and doors.

④ ADD OPTION CODES and PRICES

Add Option Codes to base Model Number.
Add each selected Option price to base price.

Top Cutout

-X
No cutout
N/C

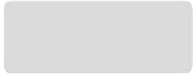

-G
One 3" Grommet
\$31



-E
MiniPort
\$284



Modesty Panel / Wire Tray

-X
No Modesty Panel
N/C



-M
12" Modesty Height
Wire Manager
\$180

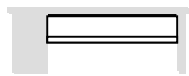

EXAMPLE

- ① 30 x 60 Single Pedestal Desk
- ② Three Drawer Glide Pedestal on left,
- ③ glide S-Legs on left and...
- ④ no Top Cutout, no Modesty / Wire Management

MODEL NUMBER

Model Number	Left Ped	Right Leg	Options
SZPD60	- G3	- GS	- X - X

PRODUCT PRICE

Base Price	Left Ped	Right Leg	Options
\$1,434	+ \$593	+ 0	+ 0 + 0

\$2,027

WORKSHEET

MODEL NUMBER

Model Number	Left Ped	Right Leg	Options
_____	- _____	- _____	- _____ - _____

PRODUCT PRICE

Base Price	Left Ped	Right Leg	Options
\$ _____	+ _____	+ _____	+ _____ + _____

\$ _____

Available Accessories:	see page
• Power / Data MiniPort	32
• Keyboard Tray	32
• Center Drawer	32

Please contact your ShuttleSystem dealer to obtain discounted project pricing.



◀ Single Pedestal Desks - Right Hand Pedestal

① CHOOSE SIZE for base model number & price

② CHOOSE LEFT SUPPORT

③ CHOOSE RIGHT PEDESTAL

Add Codes for left and right supports to base Model Number
and add accompanying prices to the base price.

	Size	
Straight Desk with Right-Hand Pedestal	30" D	SZPD54
	54" W	\$1,392
	30" D	SZPD60
	60" W	\$1,434
	30" D	SZPD72
	72" W	\$1,524

Glides		Casters	
-GS Fixed S Leg N/C		-CS Fixed S Leg \$42	
-GA Fixed Arc Leg N/C		-CA Fixed Arc Leg \$42	
-GO Open Shelves N/C		-CO Open Shelves N/C	
-GD Shelves with Door \$170		-CD Shelves with Door \$170	
-G1 One Drawer \$248		-C1 One Drawer \$248	
-G2 Two Drawers \$493		-C2 Two Drawers \$493	
-G3 Three Drawers \$593		-C3 Three Drawers \$593	







Built-in Writing Trays:
All supporting pedestals include space-saving pull-out writing trays

Locks:
Locks are standard on all drawers and doors.

④ ADD OPTION CODES and PRICES

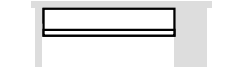
Add Option Codes to base Model Number.
Add each selected Option price to base price.

Top Cutout	Modesty Panel / Wire Tray
<p>-X No cutout N/C</p> 	<p>-X No Modesty Panel N/C</p> 
<p>-G One 3" Grommet \$31</p> 	<p>-M 12" Modesty Height Wire Manager \$180</p> 
<p>-E MiniPort \$284</p> 	

Available Accessories:	see page
• Power / Data MiniPort	32
• Keyboard Tray	32
• Center Drawer	32

EXAMPLE

- ① 30 x 60 Single Pedestal Desk
- ② with glide S-Legs on left,
- ③ Three Drawer Glide Pedestal on right and...
- ④ no Top Cutout, no Modesty / Wire Management

MODEL NUMBER			
Model Number	Left Leg	Right Ped	Options
SZPD60	- GA	- G3	- X - X

PRODUCT PRICE				
Base Price	Left Leg	Right Ped	Options	
\$1,434	+ \$0	+ \$593	+ 0	+ 0

\$2,027

WORKSHEET

MODEL NUMBER			
Model Number	Left Leg	Right Ped	Options
_____	- _____	- _____	- _____

PRODUCT PRICE				
Base Price	Left Leg	Right Ped	Options	
\$ _____	+ _____	+ _____	+ _____	+ _____

\$ _____

Please contact your ShuttleSystem dealer to obtain discounted project pricing.



◀ Double Pedestal Desks

① CHOOSE SIZE for base model number & price

② CHOOSE LEFT PEDESTAL

③ CHOOSE RIGHT PEDESTAL

Add Pedestal Codes for left and right sides to base Model Number.

Add selected Pedestal prices to the base price.

	Size	
Straight Desk with Left & Right Pedestal	30" D	SZPD54
	54" W	\$1,995
	30" D	SZPD60
	60" W	\$2,096
	30" D	SZPD72
	72" W	\$2,186

		Glides	Casters			Glides	Casters
	-GO Open Shelves N/C			-GO Open Shelves N/C			
	-GD Shelves with Door \$170			-GD Shelves with Door \$170			
	-G1 One Drawer \$248			-G1 One Drawer \$248			
	-G2 Two Drawers \$493			-G2 Two Drawers \$493			
	-G3 Three Drawers \$593			-G3 Three Drawers \$593			
		-CO Open Shelves N/C		-CO Open Shelves N/C			
		-CD Shelves with Door \$170		-CD Shelves with Door \$170			
		-C1 One Drawer \$248		-C1 One Drawer \$248			
		-C2 Two Drawers \$493		-C2 Two Drawers \$493			
		-C3 Three Drawers \$593		-C3 Three Drawers \$593			







Built-in Writing Trays:
All supporting pedestals include space-saving pull-out writing trays

Locks:
Locks are standard on all drawers and doors.

④ ADD OPTION CODES and PRICES

Add Option Codes to base Model Number.

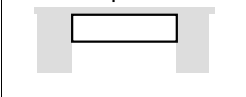
Add each selected Option price to base price.

Top Cutout	Modesty Panel / Wire Tray
<p>-X No cutout N/C</p> 	<p>-X No Modesty Panel N/C</p> 
<p>-G One 3" Grommet \$31</p> 	<p>-HM Plain Modesty Panel \$91</p> 
<p>-E MiniPort \$284</p> 	

Available Accessories:	see page
• Power / Data MiniPort	32
• Keyboard Tray	32
• Center Drawer	32

EXAMPLE

- ① 30 x 60 Double Pedestal Desk
- ② with One Drawer Glide Pedestal on Left,
- ③ Three Drawer Glide Pedestal on right and...
- ④ no Top Cutout and a Plain Modesty Panel

MODEL NUMBER			
Model Number	Left Ped	Right Ped	Options
SZPD60	- G1	- G3	- X - HM

PRODUCT PRICE			
Base Price	Left Ped	Right Ped	Options
\$2,096	+ \$248	+ \$593	+ 0 + \$91

\$3,028

WORKSHEET

MODEL NUMBER			
Model Number	Left Ped	Right Ped	Options
_____	- _____	- _____	- _____ - _____

PRODUCT PRICE			
Base Price	Left Ped	Right Ped	Options
\$ _____	+ _____	+ _____	+ _____ + _____

\$ _____

Please contact your ShuttleSystem dealer to obtain discounted project pricing.







◀ Techera Workstation

① CHOOSE FORMAT for base model number & price

② CHOOSE PEDESTAL

③ CHOOSE OPTIONS

Add pedestal and option codes to base Model Number and add accompanying prices to the base price.



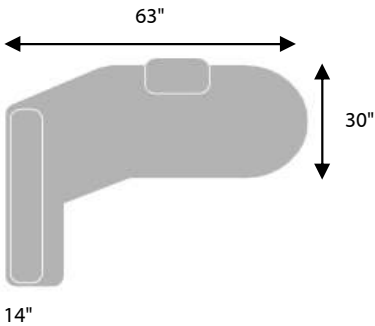



Orientation	Standard
Techera - Left (no return / bookshelf)	SZTDLXX \$1,758 
Techera - Right (no return / bookshelf)	SZTDRXX \$1,758 
TecheraPlus - Left with return and bookshelf	SZTDLXR \$2,961 
Techera - Right with return and bookshelf	SZTDRXR \$2,961 





Built-in Writing Trays:
All supporting pedestals include space-saving pull-out writing trays

Locks:
Locks are standard on all drawers and doors.

Pedestal Style

-O Open Shelves N/C 
-D Shelves with Door \$170 
-1 One Shelf, One Drawer \$248 
-S One Shelf, Two Drawers \$417 
-2 Two File Drawers \$493 
-3 Three Drawers \$593 

Top Cutout

-G One 3" Grommet N/C 
-E MiniPort \$284 

EXAMPLE

- ① Techera Left, no return, no monitor well
- ② with Two File Drawer pedestal
- ③ and no top cutout

MODEL NUMBER

Model Number	Pedestal	Top
SZTDLXX	- 2	- X

PRODUCT PRICE

Base Price	Pedestal	Top
\$1,758	+ \$493	+ 0
<div style="border: 1px solid black; display: inline-block; padding: 5px 20px;">\$2,251</div>		

WORKSHEET

MODEL NUMBER

Model Number	Pedestal	Top
_____	- _____	- _____

PRODUCT PRICE

Base Price	Pedestal	Top
\$ _____	+ _____	+ _____
<div style="border: 1px solid black; display: inline-block; padding: 5px 20px;">\$ _____</div>		

Please contact your ShuttleSystem dealer to obtain discounted project pricing.

ACCESSORIES

Mobile Storage Pedestals

Mobile



2-Drawer (12"/12")

2PED-18-M-12/12-L

\$861

3-Drawer (6"/6"/12")

3PED-18-M-6/6/12-L

\$908

- > Sized to roll beneath 29" high desks
- > Dimensions 15" W x 19" D x 27" H
- > Locking Drawers

Pencil Drawers

Basic Pencil Drawer

Basic

ACC-PD-B

\$124

Professional Pencil Drawer

ACC-PD-P

\$396

Book Boxes

Wire Book Box

Basic

ACC-WB

\$54

Molded Book Box

ACC-MB

\$54

Metal Book Box

ACC-METAL BOOKBOX

\$80

Technology Accessories

Basic CPU Holder

ACC-CPUH-B

\$215

Deluxe CPU Holder - Fixed

ACC-CPUH-DF

\$300

Deluxe CPU Holder
Slide-out / Swivel

ACC-CPUH-DS

\$416

Keyboard Tray

ACC-K24

\$234

MiniPort

ACC-MINIPOINT

\$284



< For Techera Workstations and Desks with Pedestal Legs only

Storage Totes

3" Tote

Basic

ACC-T3

\$30

6" Tote

ACC-T6

\$42

ShuttleZone Mobile Storage



Cabinets
Wardrobes
Workspace Storage
Cubbies

ShuttleZone Mobile Storage is a smarter, more flexible solution for managing supplies, student belongings and classroom equipment.

Move storage easily within a room or relocate from room to room as your needs change.

- Robust construction with steel reinforcement
- Vertical and horizontal bumper protection
- Rugged PVC edging
- Premium, heavy-duty hardware throughout
- Heavy-duty casters
- Integral wire-management to accommodate technology and electronic equipment

INDEX

CATEGORY

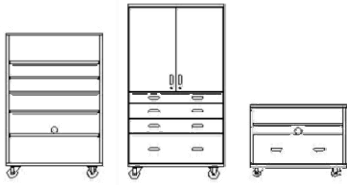

Mobile Storage Cabinets

Choose from 96 formats:

- > Four heights; Extra-Tall 72", Tall 60", Low 36" or Extra-Low 29"
- > Three widths; 30", 36", or 42"
- > Three storage configurations (two heights); all shelves, shelves and drawers or all drawers
- > Two shelf styles; open or with locking doors

All formats include wire-management to accommodate electronic equipment.

PAGE

36 - 37

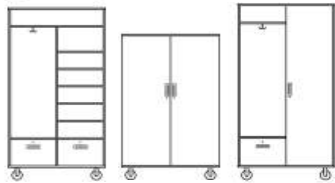

Mobile Wardrobes

Choose from 96 formats:

- > Two heights; 72" or 60"
- > Three widths; 30", 36", or 42"
- > Three styles; open, single-door or double-door
- > Single File Drawer or Double File Drawer options

All formats include wire-management to accommodate electronic equipment.

38 - 39

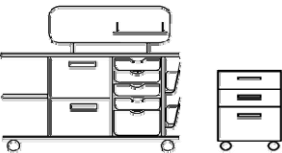

Mobile Workspace / Storage

- > Satellite Support Modules
- > Mobile Storage Pedestals

40 - 41

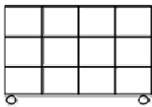

Mobile Cubbies

Four versatile formats; 30x36, 30x48, 36x36, 36x48

42

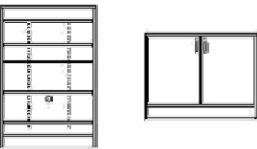

Stationary Storage Cabinets

This supplementary offering of Stationary Cabinets is complementary to the Mobile Storage System but are designed for non-mobile (fixed) applications only.

Choose from 32 formats:

- > Four heights; Extra-Tall 72", Tall 60", Low 36" or Extra-Low 29"
- > Three widths; 30", 36", or 42"
- > Two styles; open or with locking doors

43



Accessories

Storage Totes





44

Shipping of ShuttleZone Mobile Storage



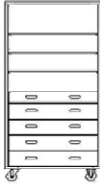

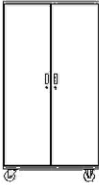
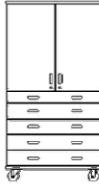
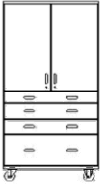

- > With the exception of loose components and accessories (adjustable shelves, totes, bins and organizer panels), all mobile cabinets, wardrobes, laptop carts, satellite support modules and latchable returns are shipped fully assembled.
- > Freight classification is 125.

ShuttleZone Mobile Cabinets

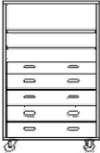



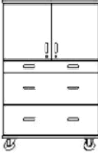

Cabinets | Extra-Tall - 72"

Open Shelves				Shelves with Doors				
(24" D)								
	No Drawers	5 Project Drawers	3 Project Drawers 1 File Drawer	1 Project Drawer 2 File Drawers	No Drawers	5 Project Drawers	3 Project Drawers 1 File Drawer	1 Project Drawer 2 File Drawers
	5 Adj. Shelves	3 Adj. Shelves	3 Adj. Shelves	3 Adj. Shelves	5 Adj. Shelves	3 Adj. Shelves	3 Adj. Shelves	3 Adj. Shelves
Widths	1 Fixed Shelf	1 Fixed Shelf	1 Fixed Shelf	1 Fixed Shelf	1 Fixed Shelf	1 Fixed Shelf	1 Fixed Shelf	1 Fixed Shelf
30"	SZMS-7230-XXXX5	SZMS-7230-X14X3	SZMS-7230-X1213	SZMS-7230-X1X23	SZMS-7230-DXXX5	SZMS-7230-H14X3	SZMS-7230-H1213	SZMS-7230-H1X23
	\$1,558	\$2,509	\$2,391	\$2,272	\$1,954	\$2,783	\$2,664	\$2,547
36"	SZMS-7236-XXXX5	SZMS-7236-X14X3	SZMS-7236-X1213	SZMS-7236-X1X23	SZMS-7236-DXXX5	SZMS-7236-H14X3	SZMS-7236-H1213	SZMS-7236-H1X23
	\$1,736	\$2,717	\$2,593	\$2,469	\$2,137	\$2,992	\$2,867	\$2,745
42"	SZMS-7242-XXXX5	SZMS-7242-X14X3	SZMS-7242-X1213	SZMS-7242-X1X23	SZMS-7242-DXXX5	SZMS-7242-H14X3	SZMS-7242-H1213	SZMS-7242-H1X23
	\$1,826	\$2,841	\$2,725	\$2,606	\$2,283	\$3,136	\$3,019	\$2,902







Cabinets | Tall - 60"

Open Shelves				Shelves with Doors				
(24" D)								
	No Drawers	5 Project Drawers	3 Project Drawers 1 File Drawer	1 Project Drawer 2 File Drawers	No Drawers	5 Project Drawers	3 Project Drawers 1 File Drawer	1 Project Drawer 2 File Drawers
	4 Adj. Shelves	2 Adj. Shelves	2 Adj. Shelves	2 Adj. Shelves	4 Adj. Shelves	2 Adj. Shelves	2 Adj. Shelves	2 Adj. Shelves
Widths	1 Fixed Shelf	1 Fixed Shelf	1 Fixed Shelf	1 Fixed Shelf	1 Fixed Shelf	1 Fixed Shelf	1 Fixed Shelf	1 Fixed Shelf
30"	SZMS-6030-XXXX4	SZMS-6030-X14X2	SZMS-6030-X1212	SZMS-6030-X1X22	SZMS-6030-DXXX4	SZMS-6030-H14X2	SZMS-6030-H1212	SZMS-6030-H1X22
	\$1,354	\$2,304	\$2,187	\$2,069	\$1,720	\$2,558	\$2,440	\$2,322
36"	SZMS-6036-XXXX4	SZMS-6036-X14X2	SZMS-6036-X1212	SZMS-6036-X1X22	SZMS-6036-DXXX4	SZMS-6036-H14X2	SZMS-6036-H1212	SZMS-6036-H1X22
	\$1,500	\$2,481	\$2,357	\$2,232	\$1,869	\$2,734	\$2,612	\$2,488
42"	SZMS-6042-XXXX4	SZMS-6042-X14X2	SZMS-6042-X1212	SZMS-6042-X1X22	SZMS-6042-DXXX4	SZMS-6042-H14X2	SZMS-6042-H1212	SZMS-6042-H1X22
	\$1,580	\$2,593	\$2,476	\$2,358	\$1,992	\$2,867	\$2,750	\$2,635

Cabinets | Low - 36"

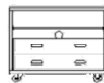
	Shelves Only		Shelves + Drawers		Drawers Only		
(24" D)							
	Open	With Doors	2 Project Drawers	1 File Drawer	5 Project Drawers	3 Project Drawers 1 File Drawer	1 Project Drawer 2 File Drawers
	2 Adj. Shelves	2 Adj. Shelves	1 Adj. Shelf	1 Adj. Shelf			
Widths	SZMS-3630-XXXX2 SZMS-3630-DXXX2		SZMS-3630-XX2X1 SZMS-3630-XXX11		SZMS-3630-X14XX SZMS-3630-X121X		SZMS-3630-X1X2X
30"	\$1,017	\$1,270	\$1,374	\$1,263	\$1,909	\$1,797	\$1,687
36"	SZMS-3636-XXXX2 SZMS-3636-DXXX2	SZMS-3636-XX2X1 SZMS-3636-XXX11	SZMS-3636-X14XX SZMS-3636-X121X	SZMS-3636-X1X2X			
	\$1,101	\$1,357	\$1,467	\$1,352	\$2,020	\$1,904	\$1,788
42"	SZMS-3642-XXXX2 SZMS-3642-DXXX2	SZMS-3642-XX2X1 SZMS-3642-XXX11	SZMS-3642-X14XX SZMS-3642-X121X	SZMS-3642-X1X2X			
	\$1,144	\$1,422	\$1,522	\$1,412	\$2,094	\$1,965	\$1,874

Cabinets | Extra-Low - 29"

	Shelves Only		Shelves + Drawers		Drawers Only	
(24" D)						
	Open	With Doors	2 Drawers (2 Project Drawer)	1 Drawer (1 File Drawer)	4 Drawers (4 Project)	3 Drawers (2 Project / 1 File)
	1 Adj. Shelf	1 Adj. Shelf	1 Adj. Shelf	1 Adj. Shelf		
Widths	SZMS-2930-XXXX1 SZMS-2930-DXXX1		SZMS-2930-XX2X1 SZMS-2930-XXX11		SZMS-2930-X13XX SZMS-2930-X111X	
30"	\$864	\$1,100	\$1,221	\$1,109	\$1,578	\$1,466
36"	SZMS-2936-XXXX1 SZMS-2936-DXXX1	SZMS-2936-XX2X1 SZMS-2936-XXX11	SZMS-2936-X13XX SZMS-2936-X111X			
	\$959	\$1,198	\$1,324	\$1,209	\$1,692	\$1,578
42"	SZMS-2942-XXXX1 SZMS-2942-DXXX1	SZMS-2942-XX2X1 SZMS-2942-XXX11	SZMS-2942-X13XX SZMS-2942-X111X			
	\$1,008	\$1,263	\$1,385	\$1,277	\$1,766	\$1,656

ShuttleZone Mobile Wardrobes

Open Wardrobes | Extra-Tall 72"

	No Drawers	1 File Drawer - Left	1 File Drawer - Right	2 File Drawers
(24" D)				
Widths				
30"	SZMW-7230-XX5 \$1,838	SZMW-7230-XL5 \$2,068	SZMW-7230-XR5 \$2,068	SZMW-7230-X25 \$2,295
36"	SZMW-7236-XX5 \$2,052	SZMW-7236-XL5 \$2,301	SZMW-7236-XR5 \$2,301	SZMW-7236-X25 \$2,553
42"	SZMW-7242-XX5 \$2,158	SZMW-7242-XL5 \$2,410	SZMW-7242-XR5 \$2,410	SZMW-7242-X25 \$2,660

Single-Door Wardrobes | Extra-Tall 72"

	No Drawers		1 File Drawer - Left		1 File Drawer - Right		2 File Drawers	
(24" D)								
Widths	Left Door	Right Door	Left Door	Right Door	Left Door	Right Door	Left Door	Right Door
30"	SZMW-7230-LX5 \$2,061	SZMW-7230-RX5 \$2,061	SZMW-7230-LL5 \$2,290	SZMW-7230-RL5 \$2,290	SZMW-7230-LR5 \$2,290	SZMW-7230-RR5 \$2,290	SZMW-7230-L25 \$2,519	SZMW-7230-R25 \$2,519
36"	SZMW-7236-LX5 \$2,277	SZMW-7236-RX5 \$2,277	SZMW-7236-LL5 \$2,528	SZMW-7236-RL5 \$2,528	SZMW-7236-LR5 \$2,528	SZMW-7236-RR5 \$2,528	SZMW-7236-L25 \$2,779	SZMW-7236-R25 \$2,779
42"	SZMW-7242-LX5 \$2,413	SZMW-7242-RX5 \$2,413	SZMW-7242-LL5 \$2,665	SZMW-7242-RL5 \$2,665	SZMW-7242-LR5 \$2,665	SZMW-7242-RR5 \$2,665	SZMW-7242-L25 \$2,916	SZMW-7242-R25 \$2,916

Double-Door Wardrobes | Extra-Tall 72"

	No Drawers	1 File Drawer - Left	1 File Drawer - Right	2 File Drawers
(24" D)				
Widths				
30"	SZMW-7230-2X5 \$2,286	SZMW-7230-2L5 \$2,512	SZMW-7230-2R5 \$2,512	SZMW-7230-225 \$2,739
36"	SZMW-7236-2X5 \$2,503	SZMW-7236-2L5 \$2,754	SZMW-7236-2R5 \$2,754	SZMW-7236-225 \$3,005
42"	SZMW-7242-2X5 \$2,670	SZMW-7242-2L5 \$2,922	SZMW-7242-2R5 \$2,922	SZMW-7242-225 \$3,172

Open Wardrobes | Tall 60"

	No Drawers	1 File Drawer - Left	1 File Drawer - Right	2 File Drawers
(24" D)				
Widths				
30"	SZMW-6030-XX4 \$1,634	SZMW-6030-XL4 \$1,869	SZMW-6030-XR4 \$1,869	SZMW-6030-X24 \$2,101
36"	SZMW-6036-XX4 \$1,813	SZMW-6036-XL4 \$2,068	SZMW-6036-XR4 \$2,068	SZMW-6036-X24 \$2,324
42"	SZMW-6042-XX4 \$1,906	SZMW-6042-XL4 \$2,164	SZMW-6042-XR4 \$2,164	SZMW-6042-X24 \$2,420

Single-Door Wardrobes | Tall 60"

	No Drawers		1 File Drawer - Left		1 File Drawer - Right		2 File Drawers	
(24" D)								
Widths	Left Door	Right Door	Left Door	Right Door	Left Door	Right Door	Left Door	Right Door
30"	SZMW-6030-LX4 \$1,845	SZMW-6030-RX4 \$1,845	SZMW-6030-LL4 \$2,079	SZMW-6030-RL4 \$2,079	SZMW-6030-LR4 \$2,079	SZMW-6030-RR4 \$2,079	SZMW-6030-L24 \$2,312	SZMW-6030-R24 \$2,312
36"	SZMW-6036-LX4 \$2,022	SZMW-6036-RX4 \$2,022	SZMW-6036-LL4 \$2,277	SZMW-6036-RL4 \$2,277	SZMW-6036-LR4 \$2,277	SZMW-6036-RR4 \$2,277	SZMW-6036-L24 \$2,534	SZMW-6036-R24 \$2,534
42"	SZMW-6042-LX4 \$2,144	SZMW-6042-RX4 \$2,144	SZMW-6042-LL4 \$2,401	SZMW-6042-RL4 \$2,401	SZMW-6042-LR4 \$2,401	SZMW-6042-RR4 \$2,401	SZMW-6042-L24 \$2,657	SZMW-6042-R24 \$2,657

Double-Door Wardrobes | Tall 60"

	No Drawers	1 File Drawer - Left	1 File Drawer - Right	2 File Drawers
(24" D)				
Widths				
30"	SZMW-6030-2X4 \$2,054	SZMW-6030-2L4 \$2,288	SZMW-6030-2R4 \$2,288	SZMW-6030-224 \$2,521
36"	SZMW-6036-2X4 \$2,233	SZMW-6036-2L4 \$2,490	SZMW-6036-2R4 \$2,490	SZMW-6036-224 \$2,746
42"	SZMW-6042-2X4 \$2,437	SZMW-6042-2L4 \$2,637	SZMW-6042-2R4 \$2,637	SZMW-6042-224 \$2,895



◀ OPEN SPACE MOBILE WORKSPACE/STORAGE

Satellite Support Modules

LOW - 29" (48" W x 24" D)

STANDARD CONFIGURATION

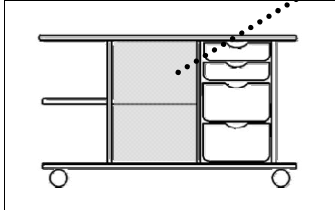

All Shelves in Shelf Bay
4 Totes in Tote Bay

SZSSM-29
\$1,620

SHELF BAY FORMATS

Standard 1 Drawer 2 Drawers 3 Drawers

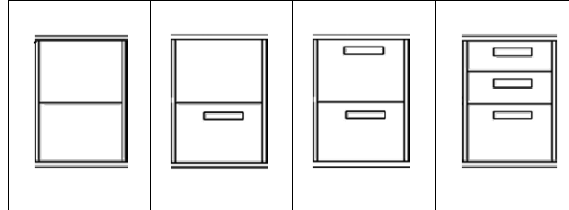

Shelf Shelf	Shelf File Drawer	File Drawer File Drawer	6" Drawer 6" Drawer File Drawer
----------------	----------------------	----------------------------	---------------------------------------

Add for Shelf Bay selection:

-XX22	-X122	-X222	-2122
\$0	\$246	\$490	\$586

STORAGE ACCESSORIES

Paper Trays

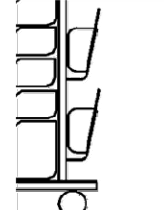

Two trays,
vertical

Add for Storage Accessories:

- 2
\$105

TALL - 42" (48" W x 24" D)

STANDARD CONFIGURATION

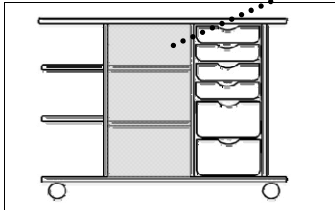

All Shelves in Shelf Bay
6 Totes in Totes Bay

SZSSM-42
\$2,387

SHELF BAY FORMATS

Standard 1 Drawer 2 Drawers 3 Drawers 4 Drawers

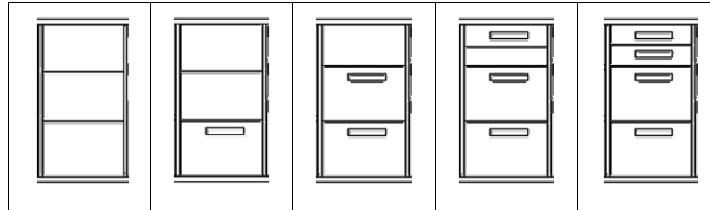

Shelf Shelf Shelf	Shelf Shelf File Drawer	Shelf File Drawer File Drawer	6" Drawer Half Shelf File Drawer File Drawer	6" Drawer 6" Drawer File Drawer File Drawer
-------------------------	-------------------------------	-------------------------------------	---	--

Add for Shelf Bay selection:

-XX42	-X142	-X242	-1242	-2242
\$0	\$246	\$490	\$659	\$828

STORAGE ACCESSORIES

Paper Trays

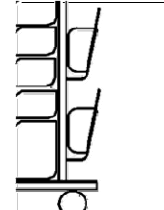

Three trays,
vertical

Add for Storage Accessories:

- 3
\$155

Mobile Storage Pedestals

- > Sized to roll beneath
29" high ShuttleZone Desks
- > Dimensions:
15" W x 19" D x 27" H
- > Locking Drawers

Two Drawers

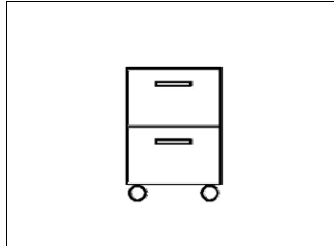

12" File
12" File

2PED-18-M-12/12-L

\$861

Three Drawers



6" Drawer
6" Drawer
12" File





2PED-18-M-6/6/12-L

\$908

ShuttleZone Mobile Cubbies

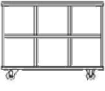
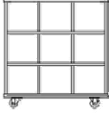
Open Cubbies

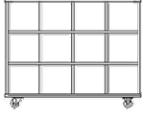
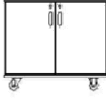
Locking Cubbies

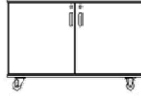
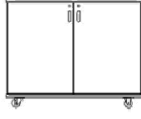
36" Wide (20" D)		48" Wide (20" D)		36" Wide (20" D)		48" Wide (20" D)	
29" High	42" High	29" High	42" High	29" High	42" High	29" High	42" High
							
SZMC-2936-X	SZMC-4236-X	SZMC-2948-X	SZMC-4248-X	SZMC-2936-D	SZMC-4236-D	SZMC-2948-D	SZMC-4248-D
\$1,080	\$1,321	\$1,207	\$1,448	\$1,223	\$1,491	\$1,379	\$1,656

Interior dimensions of each individual cubby unit are nominally 11" W x 11" H x 12" D.

72" Extra -Tall Cabinets

Extra-Tall 72" cabinets include one fixed shelf and five adjustable shelves.

30" Wide (16" D)		36" Wide (16" D)		42" Wide (16" D)	
Open	With Doors	Open	With Doors	Open	With Doors
SZSS-7230-X5	SZSS-7230-D5	SZSS-7236-X5	SZSS-7236-D5	SZSS-7242-X5	SZSS-7242-D5
\$1,003	\$1,497	\$1,080	\$1,580	\$1,155	\$1,722

60" Tall Cabinets

Tall 60" cabinets include one fixed shelf and four adjustable shelves.

30" Wide (16" D)		36" Wide (16" D)		42" Wide (16" D)	
Open	With Doors	Open	With Doors	Open	With Doors
SZSS-6030-X4	SZSS-6030-D4	SZSS-6036-X4	SZSS-6036-D4	SZSS-6042-X4	SZSS-6042-D4
\$908	\$1,365	\$968	\$1,427	\$1,035	\$1,551

36" Low Cabinets

Low 36" cabinets include three adjustable shelves.

30" Wide (16" D)		36" Wide (16" D)		42" Wide (16" D)	
Open	With Doors	Open	With Doors	Open	With Doors
SZSS-3630-X2	SZSS-3630-D2	SZSS-3636-X2	SZSS-3636-D2	SZSS-3642-X2	SZSS-3642-D2
\$714	\$1,054	\$753	\$1,097	\$797	\$1,166



29" Extra-Low Cabinets

Extra-Low 29" cabinets include two adjustable shelves

30" Wide		36" Wide		42" Wide	
Open	With Doors	Open	With Doors	Open	With Doors
SZSS-2930-X1	SZSS-2930-D1	SZSS-2936-X1	SZSS-2936-D1	SZSS-2942-X1	SZSS-2942-D1
\$635	\$951	\$672	\$989	\$707	\$1,052

Storage Totes

(12" W x 17" D)
Use these handy totes to customize
your ShuttleZone Mobile Storage
and organize small items.

3" Tote	6" Tote
	
ACC-T3	ACC-T6
\$30	\$42

ShuttleMate

Changeable Computer Workstations



With all the strength and flexibility of our patented ShuttleSystem Changeable Computer Workstations but in a more streamlined design, ShuttleMate computer tables are perfect for less wire-intensive applications. Available in two standard depths and with sleek wire-management options, you can suit ShuttleMate to your school's specific technology needs.

- Optional top-loading wire trays to keep cords handy
- ShuttleLatch table connector for instant flexibility
- Ergonomic Pedestal Legs of rugged 14-gauge steel
- Strong metal-to-metal connections at stress points
- Friendly curved shapes enable collaborative learning

INDEX

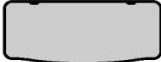
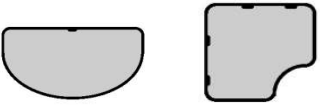
	PAGE
 Straight Profile	48
 Wave Profile	49
 Other Shapes	50
Accessories	51

NOTES

ShuttleMate Worksurface Height: 22" to 32" adjustable leg is standard, available with either glides or casters.

ADA: For required 30" wide clearance, choose any of our standard 42" or wider stations.
(Or to save classroom space, we offer a special-order 39" width at the same price as the 42".)

Shipping of ShuttleMate Changeable Computer Tables

- > All orders of 10 stations and over will be bulk packed on pallets.
 - > Orders under 10 stations may be individually cartoned (large components may also be palletized).

 - > Freight classification is 70 for disassembled flat product.
-



◀ STRAIGHT PROFILE SHAPE 24"D / 30"D

① CHOOSE DEPTH

② CHOOSE GLIDES or CASTERS

③ ADD OPTION CODES and PRICES

Profile	24" D	30" D
30" Straight Profile		
36" Straight Profile		
42" Straight Profile		
48" Straight Profile		
54" Straight Profile		
60" Straight Profile		
72" Straight Profile		
Printer Station		

Glides	Castors
SMH29G-2430ST \$563	SMH29C-2430ST \$663
SMH29G-3030ST \$594	SMH29C-3030ST \$693
SMH29G-2436ST \$583	SMH29C-2436ST \$685
SMH29G-3036ST \$613	SMH29C-3036ST \$714
SMH29G-2442ST \$603	SMH29C-2442ST \$703
SMH29G-3042ST \$635	SMH29C-3042ST \$734
SMH29G-2448ST \$621	SMH29C-2448ST \$722
SMH29G-3048ST \$656	SMH29C-3048ST \$755
SMH29G-2454ST \$642	SMH29C-2454ST \$743
SMH29G-3054ST \$676	SMH29C-3054ST \$776
SMH29G-2460ST \$660	SMH29C-2460ST \$759
SMH29G-3060ST \$694	SMH29C-3060ST \$795
SMH29G-2472ST \$751	SMH29C-2472ST \$852
SMH29G-3072ST \$790	SMH29C-3072ST \$890
SMH29G-2426PS \$549	SMH29C-2426PS \$648
SMH29G-3026PS \$577	SMH29C-3026PS \$677

Add Option Codes and Prices

Top Cutout	ShuttleLatch	Raceway
-X No cutout N/C	-X No Latch N/C	-R \$61
		-Flip* \$112
		-R \$69
		-Flip* \$124
-E MiniPort (Standard Raceway Only) \$284	-L Shuttlelatch \$56	-R \$79
		-Flip* \$137
		-R \$90
		-Flip* \$149
		-R \$100
		-Flip* \$162
		-R \$108
		-Flip* \$174
		-R \$130
		-Flip* \$205
		-R \$61
		-Flip N/A







-FLIP option provides 4.5" flip-up panel on the back edge of the desktop for wide-opening access to wiring raceway.

* Available on 30" deep stations



◀ WAVE PROFILE SHAPE 24"D / 30"D



① CHOOSE DEPTH

30" Wave Profile	24" D
	30" D
36" Wave Profile	24" D
	30" D
42" Wave Profile	24" D
	30" D
48" Wave Profile	24" D
	30" D
54" Wave Profile	24" D
	30" D
60" Wave Profile	24" D
	30" D
72" Wave Profile	24" D
	30" D

② CHOOSE GLIDES or CASTERS

Glides	Castors
SMH29G-2430WV \$563	SMH29C-2430WV \$663
SMH29G-3030WV \$594	SMH29C-3030WV \$693
SMH29G-2436WV \$583	SMH29C-2436WV \$685
SMH29G-3036WV \$613	SMH29C-3036WV \$714
SMH29G-2442WV \$603	SMH29C-2442WV \$703
SMH29G-3042WV \$635	SMH29C-3042WV \$734
SMH29G-2448WV \$621	SMH29C-2448WV \$722
SMH29G-3048WV \$656	SMH29C-3048WV \$755
SMH29G-2454WV \$642	SMH29C-2454WV \$743
SMH29G-3054WV \$676	SMH29C-3054WV \$776
SMH29G-2460WV \$660	SMH29C-2460WV \$759
SMH29G-3060WV \$694	SMH29C-3060WV \$795
SMH29G-2472WV \$751	SMH29C-2472WV \$852
SMH29G-3072WV \$790	SMH29C-3072WV \$890

③ ADD OPTION CODES and PRICES



Add Option Codes and Prices		
Top Cutout	ShuttleLatch	Raceway
-X No cutout N/C 	-X No Latch N/C	-R \$61
-E MiniPort (Standard Raceway Only) \$284 	-L Shuttlelatch \$56 	-Flip* \$112
		-R \$69
		-Flip* \$124
		-R \$79
		-Flip* \$137
		-R \$90
		-Flip* \$149
		-R \$100
		-Flip* \$162
		-R \$108
		-Flip* \$174
		-R \$130
		-Flip* \$205

-FLIP option provides 4.5" flip-up panel on the back edge of the desktop for wide-opening access to wiring raceway.

* Available on 30" deep stations

ROUNDED SHAPES and CORNER SHAPES

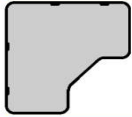
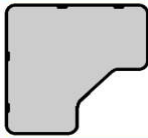

① CHOOSE SHAPE / DEPTH

Half Oval	27" D
	33" D
Quarter Profile	24" D
	30" D
42" Corner Profile	24" D
	30" D
48" Corner Profile	24" D
	30" D
60" Corner Profile	24" D
	30" D

② CHOOSE GLIDES or CASTERS

Glides	Casters
SMH29G-2748HR \$900	SMH29C-2748HR \$1,051
SMH29G-3360HR \$948	SMH29C-3360HR \$1,098
SMH29G-2424QR \$841	SMH29C-2424QR \$941
SMH29G-3030QR \$883	SMH29C-3030QR \$984
SMH29G-2442CS \$798	SMH29C-2442CS \$950
SMH29G-3042CS \$841	SMH29C-3042CS \$990
SMH29G-2448CS \$911	SMH29C-2448CS \$1,061
SMH29G-3048CS \$960	SMH29C-3048CS \$1,111
SMH29G-2460CS \$1,129	SMH29C-2460CS \$1,282
SMH29G-3060CS \$1,191	SMH29C-3060CS \$1,342

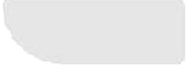
③ ADD OPTION CODES and PRICES

Add Option Codes and Prices		
Top Cutout	ShuttleLatch	Raceway
-X No cutout N/C 	-X No Latch N/C	-R \$79
-E MiniPort \$284 	-L Shuttlelatch \$56 	-R \$156
		-R \$176
		-R \$216

Flip Top Raceway not available on above Desk

ShuttleMate**Changeable Computer Workstations****ACCESSORIES****Storage Pedestals**

Suspended

2-Drawer (12"/12")

2PED-18-S-12/12-L

\$562

3-Drawer (6"/6"/12")

3PED-18-S-6/6/12-L

\$781

> Dimensions 15" W x 18" D x 25" H

> Locking Drawers

Mobile

2PED-18-M-12/12-L

\$861

3PED-18-M-6/6/12-L

\$908

> Dimensions 15" W x 19" D x 27" H

> Locking Drawers

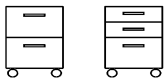
**Pencil Drawers**

Basic Pencil Drawer

Basic

ACC-PD-B

\$124

Professional Pencil Drawer

ACC-PD-P

\$396**Technology Accessories**

Basic CPU Holder

ACC-CPUH-B

\$215

Deluxe CPU Holder - Fixed

ACC-CPUH-DF

Fixed

\$300

Deluxe CPU Holder

ACC-CPUH-DS

Slide-out / Swivel

\$416

Keyboard Tray

ACC-K24

\$234

MiniPort

ACC-MINIPOINT

\$284**Electrical**

Electrical pricing is determined by workstation type, quantity and electrical requirements. Please call to receive a custom quotation for your project.

ShuttleSystem

Changeable Computer Workstations



Expertly designed for even heavily-wired computer equipment, ShuttleSystem's patented system of interlocking workstation shapes gives you all the flexibility of custom, built-in computer lab furniture but with instant flexibility. Rearrange your labs and media centers as quickly as technology and teaching methods change.

- Fully-integrated wire raceway with handy flip-top access
- ShuttleLatch table connector for instant flexibility
- Recessed side panels for ample knee room
- Strong metal-to-metal connections at stress points
- Friendly curved shapes enable collaborative learning







INDEX

	PAGE
 Workstations	54
Accessories	55

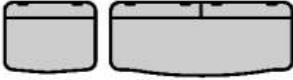
NOTES

ShuttleSystem Worksurface Height: 28" is standard, available with either glides or casters.
 Also available: 25" and 31" heights. Call for more information.

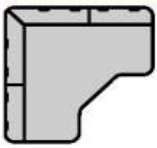
ADA: For required 30" wide clearance, choose any of our standard 42" or wider stations.
 (Or to save classroom space, we offer a special-order 39" width at the same price as the 42".)

Wave Profile		Straight Profile	
Quarter Profile		Single Printer Station Double Printer Station	
Corner Profile		Corner Connector	

Shipping of ShuttleSystem Changeable Computer Furniture

- > All orders of 10 stations and over will be bulk packed on pallets.
- > Orders under 10 stations may be individually cartoned (large components may also be palletized).
- > Freight classification is 70 for disassembled flat product.



◀ WORKSTATIONS

	Non-Locking Raceway Covers		Locking Raceway Covers		
	Glides	Casters	Glides	Casters	
Wave Profile Workstations	30" Wave Profile	SS28G-3030WVX-ST \$1,043	SS28C-3030WVX-ST \$1,170	SS28G-3030WVL-ST \$1,126	SS28C-3030WVL-ST \$1,254
	36" Wave Profile	SS28G-3036WVX-ST \$1,083	SS28C-3036WVX-ST \$1,210	SS28G-3036WVL-ST \$1,166	SS28C-3036WVL-ST \$1,293
	42" Wave Profile	SS28G-3042WVX-ST \$1,166	SS28C-3042WVX-ST \$1,293	SS28G-3042WVL-ST \$1,251	SS28C-3042WVL-ST \$1,378
	48" Wave Profile	SS28G-3048WVX-ST \$1,251	SS28C-3048WVX-ST \$1,378	SS28G-3048WVL-ST \$1,417	SS28C-3048WVL-ST \$1,544
	60" Wave Profile	SS28G-3060WVX-ST \$1,333	SS28C-3060WVX-ST \$1,460	SS28G-3060WVL-ST \$1,498	SS28C-3060WVL-ST \$1,626
	72" Wave Profile	SS28G-3072WVX-ST \$1,665	SS28C-3072WVX-ST \$1,793	SS28G-3072WVL-ST \$1,831	SS28C-3072WVL-ST \$1,960
Straight Profile Workstations	30" Straight Profile	SS28G-3030STX-ST \$1,043	SS28C-3030STX-ST \$1,170	SS28G-3030STL-ST \$1,126	SS28C-3030STL-ST \$1,254
	36" Straight Profile	SS28G-3036STX-ST \$1,083	SS28C-3036STX-ST \$1,210	SS28G-3036STL-ST \$1,166	SS28C-3036STL-ST \$1,293
	42" Straight Profile	SS28G-3042STX-ST \$1,166	SS28C-3042STX-ST \$1,293	SS28G-3042STL-ST \$1,251	SS28C-3042STL-ST \$1,378
	48" Straight Profile	SS28G-3048STX-ST \$1,251	SS28C-3048STX-ST \$1,378	SS28G-3048STL-ST \$1,417	SS28C-3048STL-ST \$1,544
	60" Straight Profile	SS28G-3060STX-ST \$1,333	SS28C-3060STX-ST \$1,460	SS28G-3060STL-ST \$1,498	SS28C-3060STL-ST \$1,626
	72" Straight Profile	SS28G-3072STX-ST \$1,665	SS28C-3072STX-ST \$1,793	SS28G-3072STL-ST \$1,831	SS28C-3072STL-ST \$1,960
Rounded	Quarter Round Profile	SS28G-3030QRX-ST \$1,376	SS28C-3030QRX-ST \$1,503	SS28G-3030QRL-ST \$1,460	SS28C-3030QRL-ST \$1,587
Corners	Corner Profile	SS28G-3048CSX-ST \$2,705	SS28C-3048CSX-ST \$2,896	SS28G-3048CSL-ST \$3,038	SS28C-3048CSL-ST \$3,230
	Corner Connector	SS28G-3042CSX-ST \$1,376	SS28C-3042CSX-ST \$1,564	SS28G-3042CSL-ST \$1,542	SS28C-3042CSL-ST \$1,731
Storage Stations	Printer Station (no storage pedestal)	SS28G-3024STX-ST \$1,000	SS28C-3024STX-ST \$1,128	SS28G-3024STL-ST \$1,083	SS28C-3024STL-ST \$1,210
	Printer Station with 2-drawer storage pedestal	SS28G-3024PSX-ST \$1,581	SS28C-3024PSX-ST \$1,709	SS28G-3024PSL-ST \$1,665	SS28C-3024PSL-ST \$1,793
	Double Storage Station	SS28G-3042DSX-ST \$2,247	SS28C-3042DSX-ST \$2,374	SS28G-3042DSL-ST \$2,332	SS28C-3042DSL-ST \$2,459

ShuttleSystem Changeable Computer Workstations

ACCESSORIES

Storage Pedestals

Suspended

2-Drawer (12"/12")

2PED-18-S-12/12-L

\$562

Mobile

2PED-18-M-12/12-L

\$861

3-Drawer (6"/6"/12")

3PED-18-S-6/6/12-L > Dimensions 15" W x 18" D x 25" H

\$781

> Locking Drawers

3PED-18-M-6/6/12-L > Dimensions 15" W x 19" D x 27" H

\$908

> Locking Drawers



Pencil Drawers

Basic Pencil Drawer

Basic

ACC-PD-B

\$124

Professional Pencil Drawer

ACC-PD-P

\$396

Technology Accessories

Basic CPU Holder

ACC-CPUH-B

\$215

Deluxe CPU Holder - Fixed
Fixed

ACC-CPUH-DF

\$300

Deluxe CPU Holder
Slide-out / Swivel

ACC-CPUH-DS

\$416

Keyboard Tray

ACC-K24

\$234

Electrical

Electrical pricing is determined by workstation type, quantity and electrical requirements. Please call to receive a custom quotation for your project.

Fixed Desks / Seating

Tandem / Navetta

Fixed
Tables



Perfect for permanent and semi-permanent computer labs, Tandem's "semi-fixed" starter/adder design has all the structural integrity of built-in systems, yet it offers future reconfigurability.



Navetta fixed tables and seating provide the perfect solution for lecture rooms, auditoriums, and training rooms. Fixed seating solutions available in virtually any size and configuration.



- Fully-integrated concealed wire-management channel
- Simple to install
- Economical
- Rugged designs with PVC edging, rugged steel tubing

Fixed Desks

INDEX

			PAGE
TANDEM		Wave Profile	58
		Other Shapes	58
		Straight Profile	59
ACCESSORIES			62
OTHER FIXED TABLES			
		Symmetra / Omnia / Monolito	60
OPTIONS			
		Other	60-61

NOTES

Tandem Worksurface Height: 28" is standard, available with glides.

ADA: For required 30" wide clearance, choose any of our standard 42" or wider stations.

(Or to save classroom space, we offer a special-order 39" width at the same price as the 42".)

Shipping of Tandem Starter / Adder Computer Workstations

- > All orders of 10 stations and over will be bulk packed on pallets.
 - > Orders under 10 stations may be individually cartoned (large components may also be palletized).
 - > Weights are approximate and include shipping cartons.
 - > Freight classification is 70 for disassembled flat product.
-

STANDARD SIZES

		Starter	Adder
Wave Profile Workstations	30" Wave Profile Workstation	TA28S-S3030WVX-S \$964	TA28A-S3030WVX-S \$747
	36" Wave Profile Workstation	TA28S-S3036WVX-S \$1,017	TA28A-S3036WVX-S \$798
	48" Wave Profile Workstation	TA28S-S3048WVX-S \$1,077	TA28A-S3048WVX-S \$857
	60" Wave Profile Workstation	TA28S-S3060WVX-S \$1,138	TA28A-S3060WVX-S \$922
	72" Wave Profile Workstation	TA28S-S3072WVX-S \$1,319	TA28A-S3072WVX-S \$1,100
	Corner Connector - 45"	TA28S-S3045CSX-S \$1,264	
Printer Station	TA28S-S3024PRX-S \$911	TA28A-S3024PRX-S \$692	

		8" Raised Backs	
		Starter	Adder
Wave Profile Workstations	30" Wave Profile Workstation	TA28S-S3030WVX-M \$1,010	TA28A-S3030WVX-M \$790
	36" Wave Profile Workstation	TA28S-S3036WVX-M \$1,075	TA28A-S3036WVX-M \$856
	48" Wave Profile Workstation	TA28S-S3048WVX-M \$1,148	TA28A-S3048WVX-M \$930
	60" Wave Profile Workstation	TA28S-S3060WVX-M \$1,224	TA28A-S3060WVX-M \$1,007
	72" Wave Profile Workstation	TA28S-S3072WVX-M \$1,424	TA28A-S3072WVX-M \$1,204
	Corner Connector - 45"	TA28S-S3045CSX-M \$1,383	
Printer Station	TA28S-S3024PRX-M \$955	TA28A-S3024PRX-M \$735	

		18" Privacy Backs and Sides	
		Starter	Adder
Wave Profile Workstations	30" Wave Profile Workstation	TA28S-H3030WVX-H \$1,268	TA28A-H3030WVX-H \$915
	36" Wave Profile Workstation	TA28S-H3036WVX-H \$1,298	TA28A-H3036WVX-H \$998
	48" Wave Profile Workstation	TA28S-H3048WVX-H \$1,385	TA28A-H3048WVX-H \$1,084
	60" Wave Profile Workstation	TA28S-H3060WVX-H \$1,476	TA28A-H3060WVX-H \$1,177
	72" Wave Profile Workstation	TA28S-H3072WVX-H \$1,690	TA28A-H3072WVX-H \$1,388
	Corner Connector - 45"	TA28S-H3045CSX-H \$1,681	
Printer Station	TA28S-H3024PRX-H \$1,165	TA28A-H3024PRX-H \$865	

CUSTOM WIDTHS

Straight Profile Workstations	30" Straight Profile Workstation
	31" - 36" Straight Profile Workstation <i>enter width** in inches into code (i.e. 33S)</i>
	37" - 48" Straight Profile Workstation <i>enter width** in inches into code (i.e. 40S)</i>
	49" - 60" Straight Profile Workstation <i>enter width** in inches into code (i.e. 52S)</i>
	61" - 72" Straight Profile Workstation <i>enter width** in inches into code (i.e. 64S)</i>

Standard Backs	
Starter	Adder
TA28S-S3030ST-X-S \$964	TA28A-S3030STX-S \$747
TA28S-S30**STX-S \$1,017	TA28A-S30**STX-S \$798
TA28S-S30**STX-S \$1,077	TA28A-S30**STX-S \$857
TA28S-S30**STX-S \$1,138	TA28A-S30**STX-S \$922
TA28S-S30**STX-S \$1,319	TA28A-S30**STX-S \$1,100

Straight Profile Workstations	30" Straight Profile Workstation
	31" - 36" Straight Profile Workstation <i>enter width** in inches into code (i.e. 33S)</i>
	37" - 48" Straight Profile Workstation <i>enter width** in inches into code (i.e. 40S)</i>
	49" - 60" Straight Profile Workstation <i>enter width** in inches into code (i.e. 52S)</i>
	61" - 72" Straight Profile Workstation <i>enter width** in inches into code (i.e. 64S)</i>

8" Raised Backs	
Starter	Adder
TA28S-S3030ST-X-M \$1,010	TA28A-S3030STX-M \$790
TA28S-S30**STX-M \$1,075	TA28A-S30**STX-M \$856
TA28S-S30**STX-M \$1,148	TA28A-S30**STX-M \$930
TA28S-S30**STX-M \$1,224	TA28A-S30**STX-M \$1,007
TA28S-S30**STX-M \$1,424	TA28A-S30**STX-M \$1,204

18" Privacy Backs and Sides	
Starter	Adder
TA28S-H3030ST-X-H \$1,268	TA28A-H3030STX-H \$915
TA28S-H30**ST-X-H \$1,298	TA28A-H30**STX-H \$998
TA28S-H30**ST-X-H \$1,385	TA28A-H30**STX-H \$1,084
TA28S-H30**ST-X-H \$1,476	TA28A-H30**STX-H \$1,177
TA28S-H30**ST-X-H \$1,690	TA28A-H30**STX-H \$1,388

Fixed Tables

STANDARD SIZES

Navetta Symmetra / Symmetra Plus	Symmetra (18" deep, per position)	SYMM-S18	\$420		
	Straight Modesty Panel	MOD	\$188		
	Wire Mgmt - Power / Data	WRMGMT	\$330		
	Symmetra Plus (18" deep, per position)				
	w/Lovano, uphol seat, mesh back	SYPL-S18-LOV-UM	\$1,099		
	Symmetra Plus (18" deep, per position)				
	w/Avalon uphol seat, plastic back	SYPL-S18-AVA-UP	\$1,199		
	w/Trilogy, uphol seat, poly back	SYPL-S18-TRI-P	\$1,008		
	w/Trilogy, uphol seat and back	SYPL-S18-TRI-U	\$1,109		
	w/Nortwood, uphol seat, wood back	SYPL-S18-UW	\$1,041		
	w/Nortwood, uphol seat and back	SYPL-S18-U	\$1,143		
	w/Smart, uphol seat and back	SYPL-S18-SMA-U	\$1,323		
	w/Zero7, uphol seat, poly back	SYPL-S18-007-UP	\$1,437		
	w/Zero7, uphol seat and back	SYPL-S18-007-U	\$1,527		
	w/Zero 7, uphol seat, mesh back	SYPL-S18-007-UM	\$1,550		
Straight Modesty Panel	MOD	\$188			
Wire Mgmt - Power / Data	WRMGMT	\$330			
Monolito	Monolito (18" deep, per position)	MONO-S18	\$673		
	Straight Modesty Panel	MOD	\$188		
	Wire Mgmt - Power / Data	WRMGMT	\$330		
Navetta Omnia	Omnia (per position)				
	Flip-up table, beechwood seat perforated metal modesty panel	OMFL-S-W-FRT	OMFL-S-W-CEN	OMFL-S-W-BAC	
		\$638	\$1,061	\$649	
	Flip-up table, upholstered seat perforated metal modesty panel	OMFL-S-U-FRT	OMFL-S-U-CEN	OMFL-S-U-BAC	
		\$685	\$1,140	\$698	
	Fixed table, beechwood seat perforated metal modesty panel	OMFX-S-W-FRT	OMFX-S-W-CEN	OMFX-S-W-BAC	
	\$566	\$943	\$578		
Fixed table, upholstered seat perforated metal modesty panel	OMFX-S-U-FRT	OMFX-S-U-CEN	OMFX-S-U-BAC		
	\$614	\$1,022	\$627		
Navetta Meeting / Auditorium	Teorama	TEO-3501-R1PNGN	TEO-3501-R2PNGN	TEO-3501-R3PNGN	TEO-3501-R4PNGN
	Unit = Single, 2, 3 or 4 Seats	\$1,606	\$2,682	\$3,731	\$5,127
	Eidos	upholstered	EID-STD-U	Ecoleather	EID-STD-EL
			\$1,406		\$1,619
	Premiere	Ecoleather	PRE-STD-EL	Leather	PRE-STD-L
			\$5,456		\$6,242
S400 Contina	upholstered	S4C-STD-U			
		\$527			

OTHER

	Four leg	Task	Sled
Lovano, uphol Seat, Mesh Back, Arms		NVLO-XXX-A-B	
		\$647	
Lovano, uphol Seat, Mesh Back, No Arms		NVLO-XXX-X-B	
		\$582	
Avalon, Upholstered Seat, Pastic Back, Arms		NVAV-XXXX-A-B	
		\$878	
Avalon, Upholstered Seat, Pastic Back,No Arms		NVAV-XXXX-X-B	
		\$813	
Trilogy, uphol seat, poly back	TRI-4DSK-P	TRI-5TSK-P	
	\$420	\$453	
Trilogy, upholstered seat and back	TRI-4DSK-U	TRI-5TSK-U	
	\$521	\$555	
Smart, upholstered seat and back	SMA-2711-RNNAN	SMA-2716-MAXND8	
	\$604	\$945	
Zero 7, uphol seat with poly back	007-7231-RNNBANTP	007-7231-MAXBNNTP	
	\$728	\$872	
Zero 7, uphol seat with mesh back	007-7231-RNNANTR	007-7231-MAXBNNTR	
	\$820	\$960	
Zero 7, uphol seat and back	007-7231-RNNBANTT	007-7231-MAXBNNTT	
	\$841	\$979	
Nortwood, uphol seat, beechwood back	NOR-4DSK-UW	NOR-5TSK-UW	
	\$606	\$606	
Nortwood, uphol seat and back	NOR-4DSK-U	NOR-5TSK-U	
	\$691	\$691	
Woody, beech wood	WDY-505-RNNNAE-W	WDY-501-BAXNNN-W	
	\$691	\$550	
Woody, uphol seat and back	WDY-505-RNNNAE-U	WDY-501-BAXNNN-U	
	\$785	\$643	
Woody, full leather	WDY-505-RNNNAE-L	WDY-501-BAXNNN-L	
	\$1,092	\$951	
Eura, uphol seat, poly back	EUR-1205-RNPNA9TP		EUR-1205-SNNNA9TP
	\$728		\$679
Eura, uphol seat, mesh back	EUR-1205-RNPNA9TR		EUR-1205-SNNNA9TR
	\$872		\$824
Eura, uphol seat and back	EUR-1205-RNPNA9TT		EUR-1205-SNNNA9TT
	\$923		\$875
Mya, upholstered	MYA-205-RNNNBN	MYA-205-BPXNNN	MYA-205-CSNNNN-D
	\$1,881	\$1,763	\$2,115
	(with folding, stackable base)		
Zero 9, poly seat and back	80A1-RNPN1N PP	Options for Zero 9 >>>	casters
	\$658		\$36
Zero 9, upholstered seat, poly back	80A1-RNPN1N TP		arms
	\$735		\$80
Zero 9, upholstered seat and back	80A1-RNPN1N TT		Tablet arm
	\$815		\$261

Navetta Seating

ACCESSORIES

Storage Pedestals

Suspended	2-Drawer (12"/12") 2PED-18-S-12/12-L \$562	3-Drawer (6"/6"/12") 3PED-18-S-6/6/12-L \$781	> Dimensions 15" W x 18" D x 25" H > Locking Drawers
Mobile	2PED-18-M-12/12-L \$861	3PED-18-M-6/6/12-L \$908	> Dimensions 15" W x 19" D x 27" H > Locking Drawers

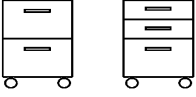

Pencil Drawers

Basic Pencil Drawer	Basic ACC-PD-B \$124
Professional Pencil Drawer	ACC-PD-P \$396

Technology Accessories

Basic CPU Holder	ACC-CPUH-B \$215
Deluxe CPU Holder - Fixed	ACC-CPUH-DF \$300
Deluxe CPU Holder - Slide-out / Swivel	ACC-CPUH-DS \$416
Keyboard Tray	ACC-K24 \$234

Electrical

Electrical pricing is determined by workstation type, quantity and electrical requirements. Please call to receive a custom quotation for your project.

ShuttleSystem

Pricing, Policy, Terms & Conditions of Sale

Pricing

All prices are F.O.B. factory at Mt. Vernon, Washington.
All prices and specifications are subject to change without notice.
All prices are for standard finishes only. Please call for pricing on custom finishes.

Packaging

All orders of 10 stations and over will be bulk packed on pallets. Orders under 10 stations may be individually cartoned (large components may also be palletized).

Shipping

All shipments are F.O.B. origin at Mt. Vernon, Washington.

Freight Claims

By FTC law, title to merchandise passes to addressee upon acceptance by carrier. Addressee is solely responsible for inspection or shipment before acceptance of delivery from carrier, and for filing any claims for shortage or damage with carrier. Notification of concealed damage must be made to carrier within 15 days after delivery; carrier responsibility ceases after 15 days.

Product Design

ShuttleSystem maintains the right to introduce design changes any time without notice. All dimensions are nominal. Worksurface dimensions based on rectangular material blank size. Colors will vary from printed literature, we recommend viewing physical samples of colors before finalizing order.

Warranty

All K-12 products are guaranteed against defective material and workmanship for a period of 15 years from date of actual receipt by the user, except optional gas strut mechanisms guaranteed for 5 years. Fixed tables (Symmetra, Symmetra Plus, Omnia, and Monolito) are guaranteed as follows: Structural components 10 yrs, other structural components 5 years, plastic, paint, wood, laminate and other surface finishes 3 years, power and electrical components, seating upholstery 1 year. Warranty does not apply to any product which has been altered or modified from the original design or specification or to any product damage resulting from accidents, negligence or shipping.



www.shuttlefurniture.com

1.800.411.1979

CUSTOM REQUESTS WELCOME

Although our standard products, with a wide selection of configurations, sizes, and shapes, meet the needs of most users, if you are interested in a custom design, please contact us. We look forward to your ideas.

SHUTTLESYSTEM LLC
4824 Socialville Foster Road
Ste 200
Mason OH, 45040
Toll Free 800.411.1979

Phone 513.489.3727
Fax 513.489.7539
www.shuttlefurniture.com



Features and specifications subject to change without notice.

Some products and features are covered by US Patents 5,878,673, D418042, D405991, D405979. Other patents may be pending. Shuttlesystem, ShuttleLatch, and ShuttleZone are registered trademarks. Shuttle, ShuttleMate, Tandem, Techera, Wave Profile, Forum Profile, Flux Desk and Open Space are trademarks of ShuttleSystem LLC. All contents Copyright 2017, ShuttleSystem LLC.

Shuttle furniture is certified under the rigorous GREENGUARD Children and School standards