

TIMES-2™ PRICE LIST



Effective January 3, 2017



TABLE OF CONTENTS

Terms and Conditions	Page 2
Lifetime Limited Warranty	Page 3
Gloss-Tek™ Colors and Laminates	Page 4
Times-2 Speed Files Dimensions	Page 5
Vertical Planning Instructions	Page 6
Weight Issues	Page 7
Conversion Charts	Page 8
Letter-Size Empty and Letter Plus-Size Empty Units	Page 9
Letter-Size Standard Units	Page 10
Letter-Size FN Units	Page 11
Letter-Size RN Units	Page 12
Letter-Size Accessories	
Shelves, Racks & Accessories	Page 13
Rollout, Security, & Tub Drawers & Accessories	Page 14-15
Wardrobe Kit, Wall Closing Strips, Closed Back Kits	Page 16
Locking & Miscellaneous Accessories	Page 17
Letter-Size Component Pricing	Page 18-19
Letter-Size Quik-Panel Slatwall	Page 20-25
Legal/A4-Size Empty Units and Legal/A4 Plus-Size Empty Units	Page 26
Legal/A4-Size Standard Units	Page 27
Legal/A4-Size FN Units	Page 28
Legal/A4-Size RN Units	Page 29
Weapons Storage Accessories	Page 30-32
Legal/A4 Accessories	
Shelves, Racks & Accessories	Page 33
Rollout, Security, & Tub Drawers & Accessories	Page 34-35
Wardrobe Kit, Wall Closing Strips, Closed Back Kits	Page 36
Locking & Miscellaneous Accessories, Special Rotor Tops & Accessories	Page 37
Legal/A4-Size Component Pricing	Page 38-39
Legal-Size Quik-Panel Slatwall	Page 40-45
Vertical Planning Worksheet	Page 46

TERMS & CONDITIONS

PRICES

All prices printed herein supersede all previous prices and are subject to change without notice. These prices are F.O.B. origin, Aurora, Illinois, exclude freight and are subject to an additional charge for special color, special packaging, states' sales or consumer taxes as required. One order constitutes one color with only one delivery address.

SALES POLICY

Possession of this price list does not constitute authority to purchase and/or sell products contained within.

GLOSS-TEK COLORS AND WOOD-TEK

Aurora Storage Products are coated in Gloss-Tek™ an eco-friendly, non-emissive textured powder coat. There are 31 standard colors; custom colors are available and are subject to longer lead time and an additional charge. A metal color chip of the special color is necessary for paint matching.

NOTE: Even with metal sample matching, shading and gloss can vary. Be careful when matching new equipment to product of the same color that has been in the field for several years. Products closely exposed to fluorescent lighting or sunlight can fade. If a perfect match is required, forward a sample to Customer Service.

WOOD-TEK PRODUCT

Orders of non-standard Wood-Tek stain and wood species require a stain match and approval. Special caution must be given to matching new product to product which has been in the field for several years. Product exposed to sunlight or fluorescent lighting can fade or darken. Aurora will not guarantee or be responsible for the character of wood including natural variations in color, grain, and texture, and may differ slightly from sample.

TERMS OF PAYMENT

Net 30 days from date of invoice. We accept Visa and Master Card.

WEIGHTS

Weights are not intended to be used for structural load bearing calculations. Shipping weights can be obtained from Quik-Quote or by consulting Aurora Customer Service.

SPECIFICATIONS

Subject to change without notice.

DISCONTINUED ITEMS

We reserve the right, without notice, to discontinue the manufacture and sale of any items printed herein.

FREIGHT POLICY

Aurora offers multiple freight options. Aurora Storage Products ship as Class 70, F.O.B., Aurora, IL 60506. Other freight options include:

- Third Party, F.O.B. point of destination
- Collect, F.O.B. point of destination
- Prepaid and add, F.O.B. point of origin
- UPS shipments will ship prepaid and add actual cost.
- PRIME Program (Positive Rate Information and Management Equalizer) is a very competitive freight program that allows Aurora to pass full freight discounts directly to all Authorized Aurora Product Dealers.

Normal delivery is dock-to-dock. Special requests such as inside delivery, lift gate service, residential delivery, etc. are subject to additional charges. All accessorial changes not requested on purchase order will be the responsibility of the consignee.

Delivery date and time are at the discretion of the carrier within reasonable transit time unless special arrangements have been made between the customer and Aurora.

Customer routed shipments and pick-ups must be picked up from Aurora within 48 hours of notification that the shipment is ready or Aurora will ship prepaid and add.

TITLE TO MERCHANDISE

Title to merchandise shall pass to the buyer upon delivery by Aurora to the carrier on FOB Factory. Buyer acknowledges that once Aurora delivers goods to the carrier, title to the goods and risk of loss will pass to the buyer. If the goods are damaged by the carrier while in transit, the buyer has the sole obligation of seeking recourse from the carrier. If the goods are lost by the carrier, buyer may at their option either:

- 1) File a freight claim with carrier.
- 2) Place a new purchase order with Aurora.

ORDER CHANGES

Any changes to an order after 5 days of the date of the first order acknowledgement are subject to a change order fee of \$100 for every change.

At the discretion of Aurora any changes to orders after receipt of an order acknowledgement are assigned a new delivery date regardless of the lead time quoted.

CANCELLATION CHARGES

If customer cancels an order after 5 days of the date of the first order acknowledgement, customer shall be subject to a charge of 20% percent of the net amount of the order.

SPECIAL ITEM CHANGES OR CANCELLATIONS

Non-standard, specially designed product, or purchased items such as Quik-Roll™ or laminates may not be changed, cancelled, or returned for credit. Aurora reserves the right to determine what products are special.

DAMAGE IN TRANSIT

CAUTION: When you give the delivering carrier a clear receipt for a shipment in which there is damaged merchandise or a shortage, the carrier and Aurora are relieved of further responsibility.

All packaging is in accordance with carrier requirements.

For your protection, before accepting any shipment, examine it carefully. If there is evidence of damage or a shortage, insist that the delivering carrier make suitable notation to that effect on the freight bill before you sign it.

If, after receipt of shipment, concealed damage is discovered, immediately **notify the delivering carrier**, requesting immediate inspection.

The inspection report should be used to support your claim against the carrier. *NOTE:* Carriers require notification of concealed damage within 24 hours of delivery. Aurora also needs to be notified of any concealed damage claims.

Any claim for damage or shortage on non-PRIME carrier shipments must be noted by you with the non-PRIME delivering carrier. Aurora will not accept the return of merchandise damaged in transit. Your recourse is with the delivering carrier. Freight claim filing is the responsibility of the consignee and not Aurora unless a PRIME carrier is used for the shipment.

SHIPMENT SHORTAGE CLAIMS

Shortage claims reported after 15 days beyond the shipment date will not be honored.

RETURN GOODS POLICY

1. Requests in writing for Return Goods Authorization must be made to the Aurora Customer Service Department within 21 days of the shipment from Aurora.
2. Aurora will determine the eligibility to return any material and will notify the requester within 5 days upon receipt of written request. Aurora will also instruct the requester to return the material to Aurora or dispose of such before the issuance of the appropriate credit.
3. Special items and items not manufactured by Aurora (purchased) will not be eligible for return.
4. Any material returned to Aurora or disposed of without the proper authorization by Aurora will be refused and no credit will be issued.
5. Returned goods must be shipped freight prepaid at the requester's expense within 30 days of receipt of written authorization. The requester must determine the carrier. If the RGA is due to a Aurora error, freight can ship collect via PRIME carrier.
6. All material returned must be received in original packaging. Credit will be given on returned resalable material, only after receipt and inspection by Aurora. All returned material must be accompanied by the Return Goods Authorization form. Credit for authorized returns are subject to a 25% restocking charge on the net acceptable material value.
7. Total value of returned material must exceed \$200.00 net.

SPECIAL PACKAGING

All material will be shipped in standard pack quantities unless otherwise specified on the purchase order. Where special requests are made for packaging that differs from the standard pack containment, customer bears full responsibility for the cost of such packaging as well as the condition of the product. Aurora shall in no way be held responsible for improper packaging or damage in transit.

Aurora reserves the right to change or modify packaging or package quantities without notice.

If customer requests that skidding be utilized, the customer shall bear the cost of the skids. At times it may be necessary to consider special crating. Consult the factory for crating charges.

PRODUCT ASSEMBLY

Aurora Storage Products are shipped "KD" (unassembled) and assembly is required at the job site. Consult appropriate installation manual.

LIFETIME LIMITED WARRANTY

Lifetime Limited Warranty: Subject to the conditions stated below Aurora Shelving, Aurora Mobile Systems, Times-2/Times-2 Elite Cabinets and Aurora Museum Cabinets warrant to the original purchaser exclusively that the shelving, carriages, the rotary cabinets and museum cabinets (“structural frames”) manufactured by Aurora Storage Products, Inc., will be free from defects in materials and workmanship other than normal wear and tear for the lifetime of the structural frames. During the warranty period, all parts will be provided at no cost. Labor is included at no cost during the first year of the warranty period. For purposes of this warranty, structural frames shall be deemed to exclude all moving parts, controls and guides that have immediate contact with moving parts.

10-Year Limited Warranty: Aurora also warrants that all carriage drive motors shall be free from defects in materials and workmanship other than normal wear and tear for a period of ten (10) years from the date of the customer’s written acceptance of installation. During the 10-year warranty period, the carriage drive motor will be provided at no cost. Labor is included at no cost during the first year of the 10-year warranty period reimbursed as per the Labor Reimbursement Schedule.

5-Year Limited Warranty: Aurora also warrants that all equipment, other than structural frames and carriage drive motors, shall be free from defects in materials and workmanship other than normal wear and tear for a period of five (5) years from the date of the customer’s written acceptance of installation. During the 5-year warranty period, all covered parts will be provided at no cost. Labor is included at no cost during the first year of the 5-year warranty period reimbursed as per the Labor Reimbursement Schedule.

1-Year Limited Warranty: Aurora also warrants that ceramic heaters contained in the Aurora Drying Cabinet shall be free from defects in materials and workmanship other than normal wear and tear for a period of 1 year from the date of the customer’s written acceptance of installation. During the 1-year warranty period, all covered parts will be provided at no cost. Labor is included at no cost during the first year of the warranty period reimbursed as per the Labor Reimbursement Schedule.

If any warranted product shall be proved to Aurora’s satisfaction to be defective, such product shall be repaired or replaced at the option of Aurora. All warranty service for any product manufactured by Aurora must be performed by an authorized Aurora factory representative. This warranty shall be void if any portion of the purchase price shall be due but unpaid in accordance with the terms pursuant to which the product was sold. This warranty shall not apply to product installed, repaired or moved by any party other than an authorized Aurora factory representative or to defects or damage caused by (a) Acts of God or other circumstances beyond Aurora’s control, (b) improper installation, (c) improper electrical supply or environmental conditions, (d) improper operation, maintenance, or storage, or (e) other than normal use or service. **EXCEPT FOR THE EXPRESS WARRANTIES SET FORTH ABOVE, AURORA MAKES NO WARRANTIES, IMPLIED OR OTHERWISE, AND AURORA SPECIFICALLY DISCLAIMS ANY IMPLIED WARRANTY OF MERCHANTABILITY OR FITNESS FOR A PARTICULAR PURPOSE.**

The Certificate of Warranty must be completed by the respective dealer, accepted and signed by the customer, and sent to Aurora Storage Products, Inc. upon completion of the installation. If the Certificate is not on file, all reimbursement for warranties shall be declined.

Limitation of Liability: Repair or replacement of any defective equipment, or refund of the purchase price paid by the customer in the event Aurora determines such equipment cannot be repaired or replaced, shall be the customer’s exclusive remedy for breach of the warranty for product defects, however caused, and in no case shall Aurora be liable for incidental, consequential, special or other damages, or loss of profits or revenues whether as a result of breach of contract of warranty, Aurora’s negligence, or otherwise. Aurora shall have no liability for any advice or assistance by any party outside the scope of Aurora’s written specification for the manufacture, operation or maintenance of the warranted equipment.

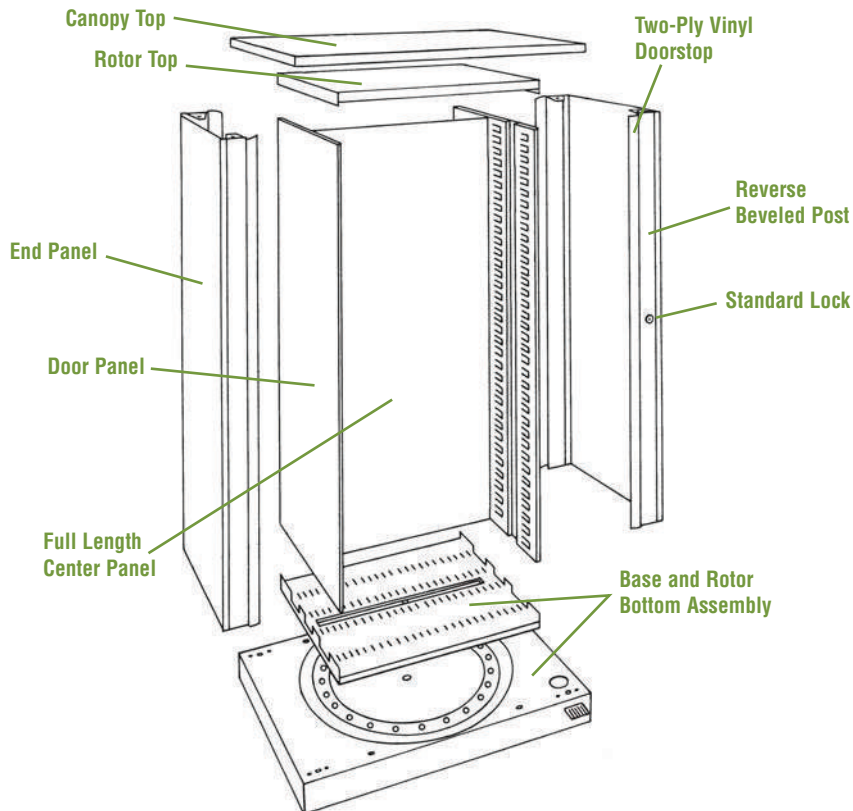

GLOSS-TEK™ COLORS AND LAMINATES

All colors are supplied in Aurora's exclusive Gloss-Tek™ powder coat finish. Always refer to the color number when ordering.

STANDARD COLORS

Color Number	Unit Color	Vinyl Color
05	Adobe ☺	Adobe
80	Beachwood	Pebble Gray
81	Black ☺	Black
30	Blue Storm	Gray Sky
19	Chisel	Chisel
60	Chocolate	Pebble Gray
42	Copra	Copra
10	Cranberry Red	Sand
53	Desert Sand	Desert Sand
02	Gray Mist ☺	Gray Mist
25	Gray Sky	Gray Sky
31	Heritage Blue	Heritage Blue
15	Moondust	Pebble Gray
64	Mushroom ☺	Mushroom
70	Obsidian	Black
50	Oliva	Pebble Tan
78	Navy	Black
86	Pebble Gray	Pebble Gray
73	Pebble Tan ☺	Pebble Tan
17	Pewter	Pewter
94	Sand ☺	Sand
40	Stone	Desert Sand

Color Number	Unit Color	Vinyl Color
51	Parchment ☺	Parchment
20	Limón	Parchment
39	Birch	Parchment
34	Summit	Summit
11	Off White ☺	Off White
90	Pure White	Gray Mist

METALLIC COLORS

Color Number	Unit Color	Vinyl Color
105	Baja	Pebble Gray
120	Aluminum	Gray Sky
115	Quicksilver	Gray Mist

Metallic finishes 15% upcharge over net value.

- Color coordinated vinyl door strips listed above are supplied as standard. All above door strip colors can be substituted at no additional charge. Four vinyl door strips per unit are standard.
- Additional charge applies for metallic paint. Add 15% of net for metallic colors.
- Add 15% of net for antimicrobial paint.

CUSTOM COLORS

- Custom Color Charge is 10% of order or \$673.00 net which ever is greater.
- Choose a standard vinyl door strip color that comes closest to matching your custom color. See www.aurorastorage.com for options.

HIGH PRESSURE

**WILSONART LAMINATE COLORS

Pricing includes standard Wilsonart High Pressure Laminates. **Wilsonart Premium and High Definition Laminates are also available as a custom order. Call Customer Service for a quote or for other laminate suppliers or color options.

LAMINATE OPTIONS

Times-2 has options for laminated tops, doors and end panels. Specify laminate manufacturer, pattern number and pattern name with your order.

- Doors can be ordered with a laminate applied directly to the steel door. Add \$300.00 List Price per door, Letter or Legal.
- Laminate Tops attach to Canopy Top. Add \$390.00 List Price for each Letter Size unit or \$523.00 List Price for each Legal Size unit. Include top view drawing with order.
- Laminate End Panels attach to standard Times-2 End Panel and add 3/4" to the width of the unit. Finished on all four sides. Add \$673.00 List Price per end panel, Letter Size, or \$776.00 List Price per End Panel for Legal Size.
- Consult Customer Service for other laminate suppliers or color options.

LAMINATE END PANEL OPTIONS

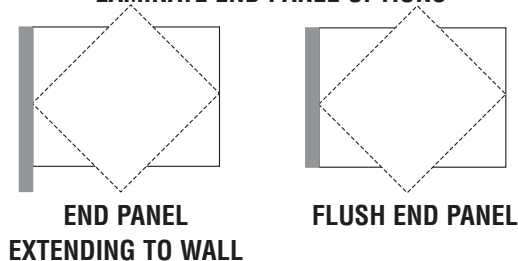

Xpress Colors

Gray Mist and Pebble Tan.
Ships within 2 business days.

Adobe, Black, Mushroom, Off-White,
Parchment, and Sand.
Ships within 5 business days.

TIMES-2 DIMENSIONS

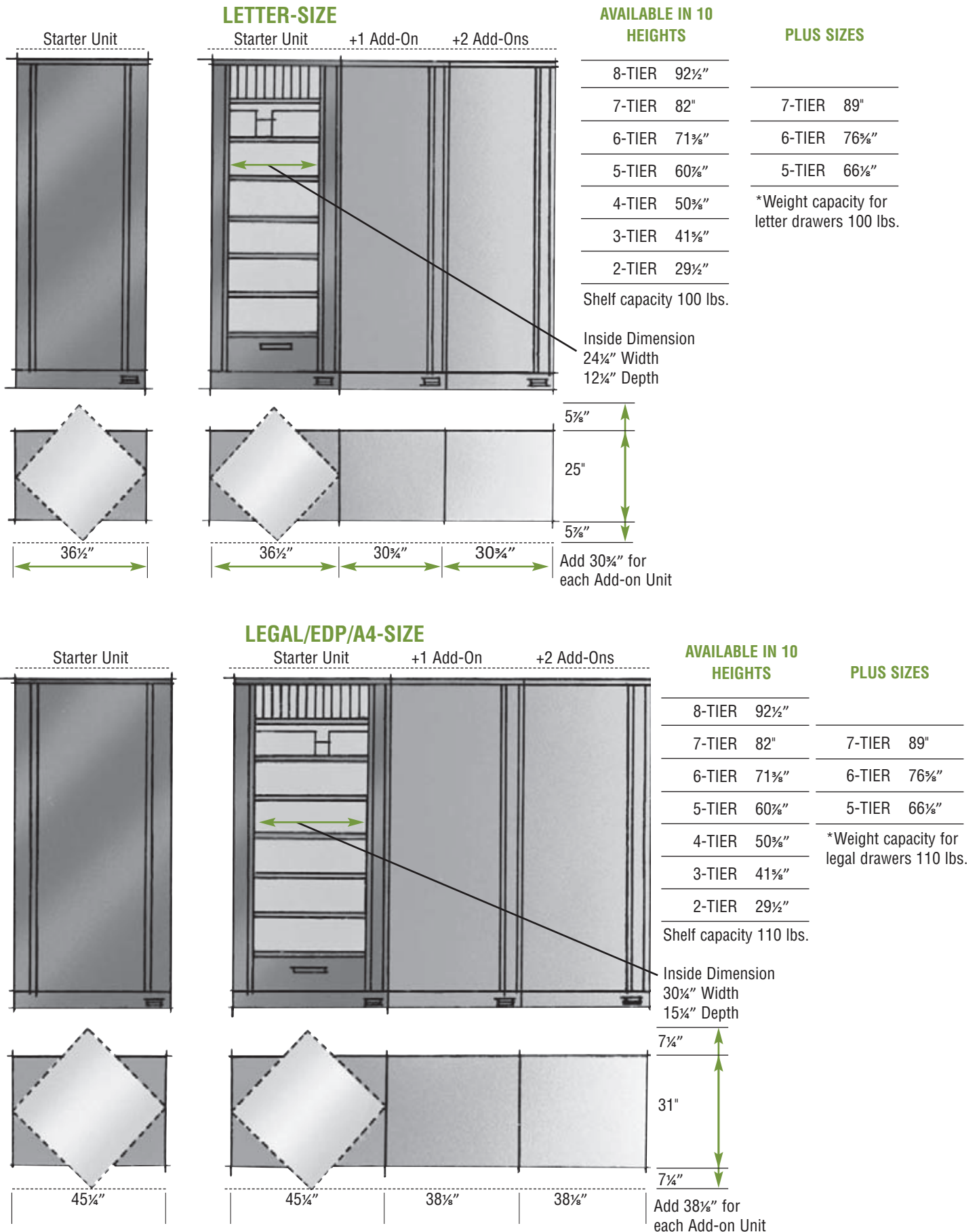

VERTICAL PLANNING INSTRUCTIONS

By knowing how many louvers are necessary to accommodate certain filing applications, the inside of Times-2 becomes easy to plan. The two following charts show available size openings and the number of louvers in each height unit.

TABLE #1

Louvers inside the Times-2 are spaced every 1¾". The shelf takes up some of that space, so the "clear" openings as marked below are somewhat smaller. For speed and convenience, a Vertical Planning Sheet is designed to lay out both stock and custom arrangements within your Times-2.

The number of louvers and useable space needed for each size opening are:

Louver	Useable Space	Application
1 Louver =	1¾"	Reference Shelf
2 Louvers =	3"	Flat forms (on shelves)
3 Louvers =	4¾"	Microfilm/fiche/trays
4 Louvers =	6½"	Accessory Drawer for CD/DVD & Small Media
5 Louvers =	8¾"	Reduced documents, e.g. Parking Tickets, Voter Registration, Fingerprint Cards
6 Louvers =	10"	Standard file folder/hanging folders/security drawer/file drawer
7 Louvers =	11¾"	3-ring binders/expanded hanging folders
8 Louvers =	13½"	Printouts/oblique folders/computer printouts
9 Louvers =	15¼"	Ledger binders

Rollout Drawers with Hanging Folder Frames:

This product usually requires 6 louvers clearance but the top most drawer always requires 7 louvers to clear tabs on top tabbed folders.

TABLE #2

Each height Times-2 has a defined number of useable louvers:

- 2-Tier (letter or legal) 13 louvers
- 3-Tier (letter or legal) 20 louvers
- 4-Tier (letter or legal) 25 louvers
- 5-Tier (letter or legal) 31 louvers
- 6-Tier (letter or legal) 37 louvers
- 7-Tier (letter or legal) 43 louvers
- 8-Tier (letter or legal) 49 louvers

Times-2 Plus Sizes (Letter or Legal)	Total Louvers	Total Height
5-Tier Adds 3 Extra Louvers	34	66½"
6-Tier Adds 3 Extra Louvers	40	76½"
7-Tier Adds 4 Extra Louvers	47	89"

Once you know both the number of louvers required for a specific size opening and the number of louvers available in the unit you've selected, then the math is simple.

Using Table #1 and Table #2 above, you can mix and match easily! **It all adds up.**

**Vertical Planning sheets are available to help you design the interior of the Times-2 cabinets. See Page 33.*

Standard Letter and Legal

Preconfigured units:

- Have 6 louvers between each shelf
- Have a 10" clearance
- Have 10½" centers
- Will lose 1 shelf if using top tab folders
- Are designed for end tab folders
- Will have 11" clearance for top shelf

WEIGHT CONSIDERATIONS

Capacity, workflow, square footage and equipment selection are four important elements for space planning. The fifth element leading to a successful design is confirmation of your building's weight load.

To ensure your project is a success, please confirm that the building floor is capable of supporting a fully loaded system that consists of the estimated Aurora system and media weight. We can help by providing your team with equipment and media weight estimates. We can also help with providing alternate equipment configurations and floor load reinforcement solutions if needed.

Please note that the estimated weight for letter and legal filing are based on an average of the ranges published by BIFMA* (Business and Institutional Furniture Manufacturers Association). Both filing estimates from BIFMA and other media estimates provide here by Aurora can vary based on the specific type of materials stored. We provide these estimates only as a guide.

*Vertical Files - Tests
ANSI/BIFMA X5.3-1997

FLOOR LOADING WEIGHTS PER FILING INCH

Media	Weight Per Filing Inch	Form Size –H–	Form Size –D–
Letter Size	2.27 lbs.	9-1/2"	11-29/32"
Legal Size	2.80 lbs.	9-1/2"	15-1/32"
Books	1.30-2.40 lbs.	Various	Various
5"x3" Index Cards	.45 lbs.	4-1/2"	5-1/32"
6"x4" Index Cards	.72 lbs.	4-1/2"	5-1/32"
6"x2 3/4" Check	.80 lbs.	2-3/4"	6"
4 1/2"x8 3/4" Check	.55 lbs.	4-1/2"	8-3/4"
Tab Cards	.71 lbs.	4-1/2"	7-13/32"
6"x4" Microfiche	1.08 lbs.	4-1/2"	6-1/6"
Securities	5.11 lbs.	12"	18-1/8"
Binders	2.75 lbs.	12"	5-7/16"
CDs	2.67 lbs.	5-5/8"	5"
Slip Case DVDs	2.00 lbs.	5-3/8"	7-1/2"
Periodicals	2.50-3.00 lbs.	Various	Various

LETTER-SIZE

Unit Height/Model	Unit	Material	Total
121S Starter, 96 LFI	174 lbs.	222 lbs.	396 lbs.
121A Add-on, 96 LFI	140 lbs.	222 lbs.	362 lbs.
131S Starter, 144 LFI	234 lbs.	334 lbs.	568 lbs.
131A Add-on, 144 LFI	190.25 lbs.	334 lbs.	524.25 lbs.
141S Starter, 192 LFI	267.25 lbs.	445 lbs.	712.25 lbs.
141A Add-on, 192 LFI	215 lbs.	445 lbs.	660 lbs.
151S Starter, 240 LFI	300.75 lbs.	557 lbs.	857.75 lbs.
151A Add-on, 240 LFI	238.25 lbs.	557 lbs.	795.25 lbs.
161S Starter, 288 LFI	339 lbs.	668 lbs.	1007 lbs.
161A Add-on, 288 LFI	266.5 lbs.	668 lbs.	934.5 lbs.
171S Starter, 336 LFI	377.5 lbs.	780 lbs.	1157.5 lbs.
171A Add-on, 336 LFI	294.5 lbs.	780 lbs.	1074.5 lbs.
181S Starter, 384 LFI	416 lbs.	891 lbs.	1307 lbs.
181A Add-on, 384 LFI	322.5 lbs.	891 lbs.	1213.5 lbs.

LEGAL/EDP/A4-SIZE

Unit Height/Model	Unit	Material	Total
221S Starter, 120 LFI	240 lbs.	278 lbs.	518 lbs.
221A Add-on, 120 LFI	193 lbs.	278 lbs.	471 lbs.
231S Starter, 180 LFI	315.5 lbs.	531 lbs.	846.5 lbs.
231A Add-on, 180 LFI	257.75 lbs.	531 lbs.	788.75 lbs.
241S Starter, 240 LFI	363.5 lbs.	708 lbs.	1071.5 lbs.
241A Add-on, 240 LFI	295.75 lbs.	708 lbs.	1003.75 lbs.
251S Starter, 300 LFI	412.75 lbs.	885 lbs.	1297.75 lbs.
251A Add-on, 300 LFI	332.75 lbs.	885 lbs.	1217.75 lbs.
261S Starter, 360 LFI	462 lbs.	1062 lbs.	1524 lbs.
261A Add-on, 360 LFI	369.75 lbs.	1062 lbs.	1431.75 lbs.
271S Starter, 420 LFI	511 lbs.	1239 lbs.	1750 lbs.
271A Add-on, 420 LFI	406.5 lbs.	1239 lbs.	1645.5 lbs.
281S Starter, 480 LFI	560.25 lbs.	1416 lbs.	1976.25 lbs.
281A Add-on, 480 LFI	443.5 lbs.	1416 lbs.	1859.5 lbs.

The charts below show the capacity of each model Times-2 and the comparison to four drawer lateral and vertical files. The chart doesn't tell the full story. A conventional drawer file will store a maximum of 35 LFI per square foot of floor space. Times-2 will house up to 72 LFI per square foot. The capacity gain, when combined with the floor space savings and the greater access improvements, means productivity increases as well as cost savings.

LETTER-SIZE UNITS

Model No.	Filing Inches	Vertical Files	Lateral Files
121S or 121A	96 LFI	.96	.75
131S or 131A	144 LFI	1.44	1.12
141S or 141A	192 LFI	1.92	1.50
151S or 151A	240 LFI	2.40	1.87
161S or 161A	288 LFI	2.88	2.25
171S or 171A	336 LFI	3.36	2.62
181S or 181A	384 LFI	3.84	3.00

LEGAL-SIZE UNITS

Model No.	Filing Inches	Vertical Files	Lateral Files
221S or 221A	120 LFI	1.20	.93
231S or 231A	180 LFI	1.80	1.40
241S or 241A	240 LFI	2.40	1.87
251S or 251A	300 LFI	3.00	2.34
261S or 261A	360 LFI	3.60	2.81
271S or 271A	420 LFI	4.20	3.28
281S or 281A	480 LFI	4.80	3.75

LETTER SIZE EMPTY UNITS

	Part #	Description	Dimensions* (WxDxH)	Capacity	Weight (lbs.)	Price
	121SE	2-Tier Starter	36½"x25"x29½"	Empty unit can be configured to hold the equivalent of 4 file drawers, or 96 linear filing inches	174.32	\$1,849.00
	121AE	2-Tier Add-on	30¾"x25"x29½"		140.39	\$1,479.00
	131SE	3-Tier Starter	36½"x25"x41½"	Empty unit can be configured to hold the equivalent of 6 file drawers, or 144 linear filing inches	199.17	\$1,887.00
	131AE	3-Tier Add-on	30¾"x25"x41½"		155.39	\$1,546.00
	141SE	4-Tier Starter	36½"x25"x50½"	Empty unit can be configured to hold the equivalent of 8 file drawers, or 192 linear filing inches	219.52	\$2,016.00
	141AE	4-Tier Add-on	30¾"x25"x50½"		167.29	\$1,756.00
	151SE	5-Tier Starter	36½"x25"x60½"	Empty unit can be configured to hold the equivalent of 10 file drawers, or 240 linear filing inches	243.81	\$2,008.00
	151AE	5-Tier Add-on	30¾"x25"x60½"		181.34	\$1,731.00
	161SE	6-Tier Starter	36½"x25"x71½"	Empty unit can be configured to hold the equivalent of 12 file drawers, or 288 linear filing inches	268.23	\$2,143.00
	161AE	6-Tier Add-on	30¾"x25"x71½"		195.54	\$1,932.00
	171SE	7-Tier Starter	36½"x25"x82"	Empty unit can be configured to hold the equivalent of 14 file drawers, or 336 linear filing inches	292.61	\$2,503.00
	171AE	7-Tier Add-on	30¾"x25"x82"		209.69	\$2,188.00
	181SE	8-Tier Starter	36½"x25"x92½"	Empty unit can be configured to hold the equivalent of 16 file drawers, or 384 linear filing inches	317.09	\$2,649.00
	181AE	8-Tier Add-on	30¾"x25"x92½"		223.84	\$2,258.00

LETTER PLUS-SIZE EMPTY UNITS

Times-2 Plus-Size units at the 5, 6, 7-Tier height increase slightly in height to accommodate applications outside of the range of a regular unit. The extra louver space can be used for a rollout reference shelf or to create any configuration that is needed.

	Part #	Description	Dimensions* (WxDxH)	Capacity	Weight (lbs.)	Price
	1513SE	5-Tier Plus Starter	36½"x25"x66½"	Empty unit can be configured to hold the equivalent of 10 file drawers, or 240 linear filing inches	256.02	\$2,008.00
	1513AE	5-Tier Plus Add-on	30¾"x25"x66½"		188.44	\$1,731.00
	1613SE	6-Tier Plus Starter	36½"x25"x76½"	Empty unit can be configured to hold the equivalent of 12 file drawers, or 288 linear filing inches	280.43	\$2,143.00
	1613AE	6-Tier Plus Add-on	30¾"x25"x76½"		202.63	\$1,932.00
	1714SE	7-Tier Plus Starter	36½"x25"x89"	Empty unit can be configured to hold the equivalent of 14 file drawers, or 336 linear filing inches	308.81	\$2,503.00
	1714AE	7-Tier Plus Add-on	30¾"x25"x89"		219.05	\$2,188.00

*Allow additional 5-⅞" depth clearance from wall to accommodate rotation of unit.







Items in bold print are also available on the Times-2 XPRESS Program.

Hand Release Option: Order part number and add "NF" suffix, example:151SENF.



LETTER-SIZE STANDARD UNITS







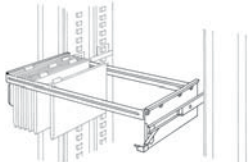

	Part #	Description	Dimensions* (WxDxH)	Capacity/Configuration	Weight (lbs.)	Price
	121S	2-Tier Starter	36½"x25"x29½"	• 96 linear filing inches	194.00	\$1,915.00
	121A	2-Tier Add-on	30¾"x25"x29½"	Unit includes: • (2) 901 Adjustable, Reversible Shelves • (1) 461P Divider Pack • (1) 462P Divider Pack	160.00	\$1,541.00
	131S	3-Tier Starter	36½"x25"x41½"	• 144 linear filing inches	234.04	\$2,054.00
	131A	3-Tier Add-on	30¾"x25"x41½"	Unit includes: • (4) 901 Adjustable, Reversible Shelves • (1) 461P Divider Pack • (2) 462P Divider Pack	190.26	\$1,731.00
	141S	4-Tier Starter	36½"x25"x50¾"	• 192 linear filing inches	267.30	\$2,288.00
	141A	4-Tier Add-on	30¾"x25"x50¾"	Unit includes: • (6) 901 Adjustable, Reversible Shelves • (3) 461P Divider Pack • (1) 462P Divider Pack	215.07	\$2,041.00
	151S	5-Tier Starter	36½"x25"x60¾"	• 240 linear filing inches	300.65	\$2,352.00
	151A	5-Tier Add-on	30¾"x25"x60¾"	Unit includes: • (8) 901 Adjustable, Reversible Shelves • (3) 461P Divider Pack • (1) 462P Divider Pack	238.18	\$2,087.00
	161S	6-Tier Starter	36½"x25"x71¾"	• 288 linear filing inches	339.02	\$2,589.00
	161A	6-Tier Add-on	30¾"x25"x71¾"	Unit includes: • (10) 901 Adjustable, Reversible Shelves • (4) 461P Divider Pack • (1) 462P Divider Pack	266.33	\$2,389.00
	171S	7-Tier Starter	36½"x25"x82"	• 336 linear filing inches	377.35	\$3,008.00
	171A	7-Tier Add-on	30¾"x25"x82"	Unit includes: • (12) 901 Adjustable, Reversible Shelves • (5) 461P Divider Pack • (1) 462P Divider Pack	294.43	\$2,743.00
	181S	8-Tier Starter	36½"x25"x92½"	• 384 linear filing inches	415.78	\$3,291.00
	181A	8-Tier Add-on	30¾"x25"x92½"	Unit includes: • (14) 901 Adjustable, Reversible Shelves • (6) 461P Divider Pack • (1) 462P Divider Pack	322.53	\$2,920.00

*Allow additional 5-7/8" depth clearance from wall to accommodate rotation of unit.
 Items in bold print are also available on the Times-2 XPRESS Program.
 Hand Release Option: Order part number and add "NF" suffix, example:151SENF.





FN unit comes with 991 Rollout Hanging Folder Frames.

	Part #	Description	Dimensions* (WxDxH)	Capacity/Configuration	Weight (lbs.)	Price
	121SFN	2-Tier Starter	36½"x25"x29½"	• 96 linear filing inches	210.50	\$2,365.00
	121AFN	2-Tier Add-on	30¾"x25"x29½"	Unit includes: • (4) 991 Rollout Hanging Folder Frame	176.50	\$1,991.00
	131SFN	3-Tier Starter	36½"x25"x41⅝"	• 144 linear filing inches	251.35	\$2,665.00
	131AFN	3-Tier Add-on	30¾"x25"x41⅝"	Unit includes: • (6) 991 Rollout Hanging Folder Frame	207.57	\$2,342.00
	141SFN	4-Tier Starter	36½"x25"x50⅝"	• 192 linear filing inches	330.78	\$3,079.00
	141AFN	4-Tier Add-on	30¾"x25"x50⅝"	Unit includes: • (8) 991 Rollout Hanging Folder Frame	236.87	\$2,829.00
	151SFN	5-Tier Starter	36½"x25"x60⅝"	• 240 linear filing inches	360.15	\$3,360.00
	151AFN	5-Tier Add-on	30¾"x25"x60⅝"	Unit includes: • (10) 991 Rollout Hanging Folder Frame	268.31	\$3,095.00
	161SFN	6-Tier Starter	36½"x25"x71⅝"	• 288 linear filing inches	369.15	\$3,598.00
	161AFN	6-Tier Add-on	30¾"x25"x71⅝"	Unit includes: • (10) 991 Rollout Hanging Folder Frame • (2) 901 Adjustable, Reversible Shelf • (1) 461P Package 10" Dividers	296.46	\$3,396.00
	171SFN	7-Tier Starter	36½"x25"x82"	• 336 linear filing inches	407.48	\$4,051.00
	171AFN	7-Tier Add-on	30¾"x25"x82"	Unit includes: • (10) 991 Rollout Hanging Folder Frame • (4) 901 Adjustable, Reversible Shelf • (2) 461P Package 10" Dividers	324.56	\$3,750.00
	181SFN	8-Tier Starter	36½"x25"x92½"	• 384 linear filing inches	445.91	\$4,299.00
	181AFN	8-Tier Add-on	30¾"x25"x92½"	Unit includes: • (10) 991 Rollout Hanging Folder Frame • (6) 901 Adjustable, Reversible Shelf • (3) 461P Package 10" Dividers	352.66	\$3,943.00

*Allow additional 5-⅝" depth clearance from wall to accommodate rotation of unit.
When using Rollout Hanging Folder Frames, deduct 1-1/2" per frame from the LFI measurement.
Hand Release Option: Order part number and add "NF" suffix, example:151SENF.

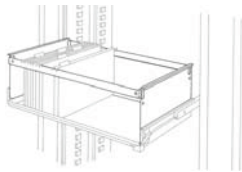

RN unit comes with 1995 Rollout Drawers with Hanging Folder Frames.

	Part #	Description	Dimensions* (WxDxH)	Capacity/Configuration	Weight (lbs.)	Price
	121SRN	2-Tier Starter	36½"x25"x29½"	• 96 linear filing inches	238.50	\$2,609.00
	121ARN	2-Tier Add-on	30¾"x25"x29½"	Unit includes: • (4) 1995 Rollout Drawer with Hanging Folder Frame	204.50	\$2,257.00
	131SRN	3-Tier Starter	36½"x25"x41½"	• 144 linear filing inches	294.33	\$3,072.00
	131ARN	3-Tier Add-on	30¾"x25"x41½"	Unit includes: • (6) 1995 Rollout Drawer with Hanging Folder Frame	250.54	\$2,747.00
	141SRN	4-Tier Starter	36½"x25"x50"	• 192 linear filing inches	346.39	\$3,623.00
	141ARN	4-Tier Add-on	30¾"x25"x50"	Unit includes: • (8) 1995 Rollout Drawer with Hanging Folder Frame	294.17	\$3,374.00
	151SRN	5-Tier Starter	36½"x25"x60⅞"	• 240 linear filing inches	402.40	\$4,039.00
	151ARN	5-Tier Add-on	30¾"x25"x60⅞"	Unit includes: • (10) 1995 Rollout Drawer with Hanging Folder Frame	339.93	\$3,773.00
	161SRN	6-Tier Starter	36½"x25"x71⅜"	• 288 linear filing inches	440.77	\$4,277.00
	161ARN	6-Tier Add-on	30¾"x25"x71⅜"	Unit includes: • (10) 1995 Rollout Drawer with Hanging Folder Frame • (2) 901 Adjustable, Reversible Shelf • (1) 461P Package 10" Dividers	345.10	\$4,074.00
	171SRN	7-Tier Starter	36½"x25"x82"	• 336 linear filing inches	479.10	\$4,730.00
	171ARN	7-Tier Add-on	30¾"x25"x82"	Unit includes: • (10) 1995 Rollout Drawer with Hanging Folder Frame • (4) 901 Adjustable, Reversible Shelf • (2) 461P Package 10" Dividers	368.08	\$4,428.00
	181SRN	8-Tier Starter	36½"x25"x92½"	• 384 linear filing inches	517.53	\$4,977.00
	181ARN	8-Tier Add-on	30¾"x25"x92½"	Unit includes: • (10) 1995 Rollout Drawer with Hanging Folder Frame • (6) 901 Adjustable, Reversible Shelf • (3) 461P Package 10" Dividers	424.28	\$4,622.00

*Allow additional 5-⅞" depth clearance from wall to accommodate rotation of unit.
 When using Rollout Drawers with Hanging Folder Frames, deduct 1-1/2" per frame from the LFI measurement.
 Items in bold print are also available on the Times-2 XPRESS Program.
 Hand Release Option: Order part number and add "NF" suffix, example:151SENF.



LETTER-SIZE ACCESSORIES

SHELVES, RACKS & ACCESSORIES MAGNETIC FOLLOWERS

Part #	Description	Weight	Price
 041	Standard Magnetic Follower (7½"H x 7"W x ¼"Foot)	1.62 lbs.	\$27.20

Part #	Description	Weight	Price
854	4" MINI-MAG Follower (4¾"H; 4"W; ¾"Foot)	.46 lbs.	\$17.40
855	5" MINI-MAG Follower (4¾"H; 5"W; ¾"Foot)	.52 lbs.	\$20.65
856	6" MINI-MAG Follower (4¾"H; 6"W; ¾"Foot)	.69 lbs.	\$21.75
857	7" MINI-MAG Follower (4¾"H; 7¾"W; ¾"Foot)	.78 lbs.	\$23.95

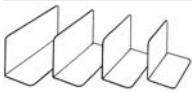

Part #	Description	Weight	Price
075	Documate Rack	4 lbs.	\$101.00





Part #	Description	Weight	Price
077	Fasthook Rack	3.73 lbs.	\$104.00

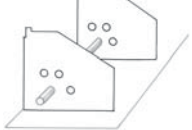

Part #	Description	Weight	Price
395	Short Stop Spacer	.5 lbs.	\$70.00



Part #	Description	Weight	Price
459P	Pkg. (5) 6½" Ht. Dividers	5.01 lbs.	\$41.00
460P	Pkg. (5) 8¼" Ht. Dividers	4.87 lbs.	\$41.00
 461P	Pkg. (5) 10" Ht. Dividers	5.85 lbs.	\$41.00
 462P	Pkg. (5) 11¼" Ht. Dividers	6.83 lbs.	\$41.00
463P	Pkg. (5) 13½" Ht. Dividers	7.81 lbs.	\$41.00
464P	Pkg. (5) 15¼" Ht. Dividers	8.78 lbs.	\$106.00
465P	Pkg. (5) 17" Ht. Dividers	9.76 lbs.	\$106.00
466P	Pkg. (5) 18¾" Ht. Dividers	10.74 lbs.	\$106.00

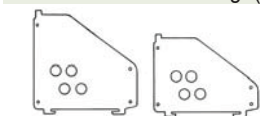

Part #	Description	Weight	Price
457P	Pkg. (5) 3" Ht. Dividers	1.94 lbs.	\$41.00
458P	Pkg. (5) 4¾" Ht. Dividers	2.20 lbs.	\$41.00

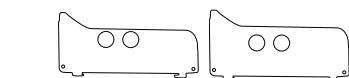

SHELVES, RACKS & ACCESSORIES

Part #	Description	Weight	Price
613	Oblique Rack	3 lbs.	\$67.00



Part #	Description	Weight	Price
 901	Adjustable, Reversible Shelf (24"L x 12¼"D) 100 lbs. Capacity per shelf.	4.53 lbs.	\$40.00



Part #	Description	Weight	Price
901R	Recessed, Adjustable Shelf (24"L x 10¼"D) 100 lbs. Capacity per shelf.	3.66 lbs.	\$40.00



Part #	Description	Weight	Price
160	Letter Size European Fixed Filing Frame.	3.36 lbs.	\$118.00

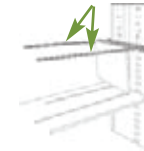

Items in bold print are also available on the Times-2 XPRESS Program.



ROLLOUT DRAWERS & ACCESSORIES

Part #	Description	Weight	Price
480	Rollout Drawer End Support and Magnetic Follower are additional options. (22½" L x 12" D x 3¼" H)	11.11 lbs.	\$137.00



Part #	Description	Weight	Price
482	End Support Plugs into side of drawer.	.24 lbs.	\$6.90 (each)



Part #	Description	Weight	Price
153F	Rollout Drawer Insert for finger print cards (Requires #480) 2 Sections @ 8¼" W each 1 Section @ 6" W	7.83 lbs.	\$225.00

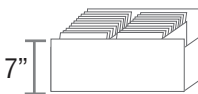

Part #	Description	Weight	Price
153P	Rollout Drawer Insert for parking tickets (Requires #480) 4 Sections @ 4¼" W each 1 Section @ 3½" W	9.46 lbs.	\$225.00



Part #	Description	Weight	Price
882	Rollout Reference Shelf Includes (1) #461P, Package of 10" Dividers.	15.23 lbs.	\$205.00



Part #	Description	Weight	Price
880	Rollout File Drawer (22⅝" L x 11⅛" D x 9⅝" H)	10.13 lbs.	\$172.00



Part #	Description	Weight	Price
815	File Divider, 10" x 6" for use with #880	0.40 lbs.	\$4.35 (each)

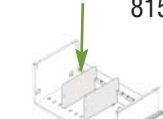

Part #	Description	Weight	Price
349P	Hanging Folder Rail Package of 2 Rails for #880, #574 & #1995	2.12 lbs.	\$39.00



Part #	Description	Weight	Price
151	Converter Bars Set of 2 for adding a legal size filing space to a letter size Times-2.	.75 lb.	\$67.00



ROLLOUT DRAWERS & ACCESSORIES

Part #	Description	Weight	Price
1995	Rollout Drawer with Hanging Folder Frame 22½" L.F.I.	15.86 lbs.	\$223.00



Part #	Description	Weight	Price
574	Hanging Folder Frame For use with #480 Rollout Drawer	4.75 lbs.	\$94.00



Part #	Description	Weight	Price
349	Hanging Folder Rail for #574, #880 and #1995	1.06 lbs.	\$30.45 (each)



Part #	Description	Weight	Price
340	Frame End Plate for #574 & #1995	1.5 lbs.	\$48.00 (each)



Part #	Description	Weight	Price
991	Rollout Hanging Folder Frame 22½" L.F.I.	8.7 lbs.	\$158.00



ROLLOUT HANGING FOLDER FRAME END PLATE FOR 991 (Slides not included)

Part #	Description	Weight	Price
993	Left Frame End Plate	1.25 lbs.	\$64.00
994	Right Frame End Plate	1.25 lbs.	\$64.00



HANGING FOLDER FRAME RAILS FOR 991 (Slides not included)

Part #	Description	Weight	Price
1001	Hanging Folder Rails	1.3 lbs.	\$48.00 (each)



SHELF DIVIDER SUPPORT

Used under Rollout Reference Shelf

Part #	Description	Weight	Price
312	Magnetic Shelf Divider Support	.76 lbs.	\$40.00

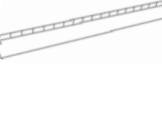

= X·P·R·E·S·S

Items in bold print are also available on the Times-2 XPRESS Program.

ROLLOUT DRAWERS & ACCESSORIES

Part #	Description	Weight	Price
480	Rollout Drawer End Support and Magnetic Follower are additional options. (22½"L x 12"D x 3¼"H)	11.11 lbs.	\$137.00



Part #	Description	Weight	Price
488	Rollout Accessory Drawer Capacity @ 120 CD's Two dividers included. (22½"L x 12"D x 3¼"H)	15.03 lbs.	\$260.00



Part #	Description	Weight	Price
913	Drawer Front Slides over drawer lip to provide 3¾" high bin front and slots every ½".	2.04 lbs.	\$43.00 (each)



Part #	Description	Weight	Price
915	Non-Slotted Drawer Divider Drops into slotted drawer front & back for adjustable compartmentation.	.4 lbs.	\$33.00 (each)



Part #	Description	Weight	Price
371	Slotted Drawer Back Clips over regular drawer back. Provides slots every ½" for use with 480.	1.09 lbs.	\$31.00 (each)

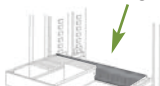

Part #	Description	Weight	Price
361	Slotted Drawer Side for use with 488.	.5 lbs.	\$28.60 (each)



Part #	Description	Weight	Price
362	Front to Back Partition for use with 488.	1.5 lbs.	\$34.00 (each)



ROLLOUT DRAWERS & ACCESSORIES

Part #	Description	Weight	Price
363.01	Drawer Divider 10½" Clear Space. Divides Drawer in two.	.4 lbs.	\$27.45 (each)



Part #	Description	Weight	Price
363.02	Drawer Divider 5 Clear Space. Divides Drawer in four.	.2 lbs.	\$22.85 (each)



Part #	Description	Weight	Price
607	Security Drawer Shelf above Security Drawer Not designed for hanging is an additional option. file folders. (22½"L x 12"D x 9¾"H)	24.46 lbs.	\$396.00



Part #	Description	Weight	Price
374RO	Tub Drawer Shelf above Tub Drawer is an additional option. Can accommodate hanging file folders. (22½"L x 12"D x 9¾"H)	21 lbs.	\$225.00



SLIDES

Part #	Description	Weight	Price
490	Suspension Slides (Pair) with Thumb Latch	3.95 lbs.	\$89.00
96310.00	Security Drawer Slides (Pair)	3.95 lbs.	\$89.00

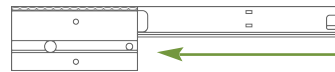

If current slides are in a tandem configuration you will need to specify our Modified Slide

96300.00MOD*	Times-2 Modified Letter Size Drawer Slide	3.95 lbs.	\$89.00
--------------	---	-----------	---------

96310.00MOD*	Times-2 Modified Letter Size Security Drawer Slide	3.95 lbs.	\$89.00
--------------	--	-----------	---------

*Please contact Design Support to make sure Modified Slides will fit on your older drawer accessory.

CASTER KIT

Part #	Description	Weight	Price
398C	Caster Kit The Times-2 Caster Kit can be added to Times-2 units from 2-Tier through 5-Tier. Kit comes with 2 brackets, 2 locking casters, 2 free spinning casters and hardware.	9.7 lbs.	\$373.00



Items in bold print are also available on the Times-2 XPRESS Program.

= X·P·R·E·S·S

LETTER-SIZE ACCESSORIES

INTERCONNECT

Interconnect varying height Times-2 units to make the most of wasted space under low windows, hallways, and other unusual spaces. \$265.00 for each change up or down. There are endless combinations. Aurora engineering review required.



Part#	Price
X2INT	\$265.00 per change

WARDROBE KIT



Part #	Description	Weight	Price
385WK	Letter Size Wardrobe Kit for 5, 6, 7, and 8-Tier Times-2	57.71 lbs.	\$474.00

Kit includes:

- A vertical panel with louvers on both sides
- Four half-shelves
- One coat hook with three prongs
- Vertical panel adapter

Does not include Security Drawer, Rollout Drawer or additional shelf depicted.

Part #	Description	Weight	Price
385WCH	Coat Hook	.46 lbs.	\$89.00

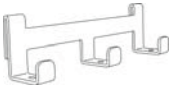

Part #	Description	Weight	Price
385WSH	Half Shelf	1.45 lbs.	\$55.00



PASS-THROUGH CENTER PANEL

The Pass Through Center Panel creates a convenient large shelf area or pass through, providing a standard 2-tier opening at the top of the unit.

Part #	Description	Weight	Price
116PT	6-Tier Pass Through	14.55 lbs.	\$186.00
117PT	7-Tier Pass Through	17.55 lbs.	\$195.00
118PT	8-Tier Pass Through	19.55 lbs.	\$202.00
Plus Size			
1163PT	6-Tier Plus Pass Through	15.55 lbs.	\$193.00
1174PT	7-Tier Plus Pass Through	18.55 lbs.	\$201.00

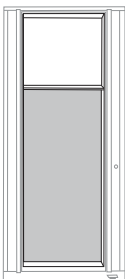

WALL CLOSING STRIPS – SINGLE DEPTH

Full-length closure between Times-2® units and wall.

Part #	Description	Weight	Price
922	2-Tier Closing Strip (Each)	2.07 lbs.	\$134.00
923	3-Tier Closing Strip (Each)	2.91 lbs.	\$135.00
9241	4-Tier Closing Strip (Each)	3.50 lbs.	\$136.00
925	5-Tier Closing Strip (Each)	4.21 lbs.	\$137.00
926	6-Tier Closing Strip (Each)	4.93 lbs.	\$139.00
927	7-Tier Closing Strip (Each)	5.64 lbs.	\$142.00
928	8-Tier Closing Strip (Each)	6.35 lbs.	\$143.00
Plus Size			
9253	5-Tier Plus Closing Strip (Each)	4.57 lbs.	\$139.00
9263	6-Tier Plus Closing Strip (Each)	5.28 lbs.	\$142.00
9274	7-Tier Plus Closing Strip (Each)	6.12 lbs.	\$143.00



The prefix "1" should be used in front of the part # above when using wall strips with extended canopy tops.

WALL CLOSING STRIPS – DOUBLE DEPTH

Full-length closure for back-to-back Times-2® units.

Part #	Description	Weight	Price
942	2-Tier Closing Strip (Each)	3.59 lbs.	\$173.00
943	3-Tier Closing Strip (Each)	5.03 lbs.	\$174.00
9441	4-Tier Closing Strip (Each)	6.06 lbs.	\$180.00
945	5-Tier Closing Strip (Each)	7.30 lbs.	\$186.00
946	6-Tier Closing Strip (Each)	8.53 lbs.	\$191.00
947	7-Tier Closing Strip (Each)	9.77 lbs.	\$198.00
948	8-Tier Closing Strip (Each)	11.00 lbs.	\$205.00
Plus Size			
9453	5-Tier Plus Closing Strip (Each)	7.91 lbs.	\$188.00
9463	6-Tier Plus Closing Strip (Each)	9.15 lbs.	\$196.00
9474	7-Tier Plus Closing Strip (Each)	10.59 lbs.	\$201.00



The prefix "1" should be used in front of the part # above when using wall strips with extended canopy tops. For extended canopy top applications consult factory.

CLOSED BACK KITS

Part #	Description	Weight	Price
1202	2-Tier Closed Back Starter	47 lbs.	\$747.00
1203	3-Tier Closed Back Starter	56.38 lbs.	\$753.00
12041	4-Tier Closed Back Starter	62.79 lbs.	\$774.00
1205	5-Tier Closed Back Starter	70.55 lbs.	\$801.00
1206	6-Tier Closed Back Starter	78.15 lbs.	\$835.00
1207	7-Tier Closed Back Starter	85.88 lbs.	\$860.00
1208	8-Tier Closed Back Starter	93.61 lbs.	\$875.00
Plus Size			
12053	5-Tier Plus Closed Back Starter	90 lbs.	\$819.00
12063	6-Tier Plus Closed Back Starter	82.15 lbs.	\$848.00
12074	7-Tier Plus Closed Back Starter	89.88 lbs.	\$867.00

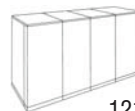

Extended Canopy Top is included.

1212	2-Tier Closed Back Add-on	35 lbs.	\$562.00
1213	3-Tier Closed Back Add-on	42.13 lbs.	\$567.00
12141	4-Tier Closed Back Add-on	46.27 lbs.	\$576.00
1215	5-Tier Closed Back Add-on	51.3 lbs.	\$593.00
1216	6-Tier Closed Back Add-on	56.3 lbs.	\$601.00
1217	7-Tier Closed Back Add-on	61.3 lbs.	\$608.00
1218	8-Tier Closed Back Add-on	66.31 lbs.	\$616.00
Plus Size			
12153	5-Tier Plus Closed Back Add-on	54.3 lbs.	\$596.00
12163	6-Tier Plus Closed Back Add-on	59.3 lbs.	\$605.00
12174	7-Tier Plus Closed Back Add-on	64.3 lbs.	\$612.00

Items in bold print are also available on the Times-2 XPRESS Program.

= X·P·R·E·S·S

LETTER-SIZE ACCESSORIES

LOCKING ACCESSORIES

Part #	Description	Weight	Price
424	All Times-2 Locks	.5 lbs.	\$20.65
424B	Replacement key part # for all Times-2 units with 1353 key code	.2 lbs.	\$10.90
423M	All Times-2 Locks when requested to be keyed different than 1353	.5 lbs.	\$20.65
426	Dual locks option	.5 lbs.	\$20.65
968	Security Drawer Lock for use with #607 #608	.25 lbs.	\$21.25
1118	Medeco Lock, Keyed in Groups	.5 lbs.	\$166.00
1118M	Medeco Lock, special order Keyed different with master	.5 lbs.	\$166.00
XX424B.1	Replacement key for all Times-2 locks keyed different than 1353	.2 lbs.	\$16.20

ELECTRONIC KEYPAD LOCK

The Vertical Electronic Keypad Lock replaces the Key Assembly on the Aurora Times-2 Unit Lock Post. Available in Black or Chrome color with an optional Key-Fob for remote access. Lock has a 10 Year Lithium Battery. Electronic Lock cannot be used on Times-2 Security Drawers.

Dimensions: 5"L x 1"W x 2"D, Weight: < 1 Lb.

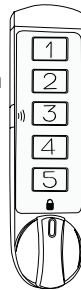

ELECTRONIC KEYPAD LOCK

TIMES-2 FOOT PEDAL UNITS

PART NUMBER
422C1 Chrome
422B1 Black

TIMES-2 HAND RELEASE UNITS

PART NUMBER
421C1 Chrome
421B1 Black

WT.	PRICE
<1 lb.	\$388.00
<1 lb.	\$388.00

ELECTRONIC KEYPAD LOCK W/ KEY-FOB

TIMES-2 FOOT PEDAL UNITS

PART NUMBER
422C2 Chrome
422B2 Black

TIMES-2 HAND RELEASE UNITS

PART NUMBER
421C2 Chrome
421B2 Black

WT.	PRICE
<1 lb.	\$776.00
<1 lb.	\$776.00

MISCELLANEOUS ACCESSORIES

Part #	Description	Weight	Price
003	Under Base Dolly For moving Letter-Size Times-2 Speed Files.	18 lbs.	\$286.00

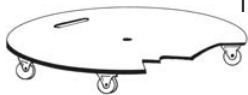

Part #	Description	Weight	Price
538I	Dual Foot Pedal Factory installed	4 lbs.	\$82.00
538K	Dual Foot Pedal Kit Field installation	4 lbs.	\$82.00

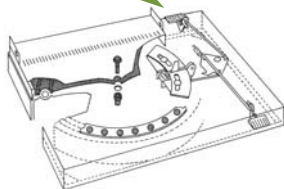

HAND RELEASE

Any Times-2 unit can be ordered with hand release factory installed instead of a foot pedal at no additional charge. Order standard part number and add "NF" suffix Example: 151SENF 5 Tier empty starter with hand release.

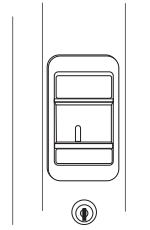

MISCELLANEOUS ACCESSORIES

Part #	Description	Weight	Price
839H	Horizontal Rangefinder Holds two 3" x 5" index cards, attaches magnetically to the post.	1 lbs.	\$47.00

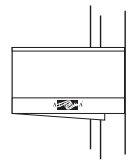

Part #	Description	Weight	Price
839V	Vertical Rangefinder Holds two 5" x 3" index cards, attaches magnetically to the post.	1 lbs.	\$47.00



Part #	Description	Weight	Price
LABH99	Horizontal Card Holder 3" x 5" Doubleface tape and adhesive magnetic tape included. Attaches to door.	.14 lbs.	\$14.80



Part #	Description	Weight	Price
LABV99	Vertical Card Holder 5" x 3" Doubleface tape and adhesive magnetic tape included. Attaches to post.	.14 lbs.	\$16.70



Part #	Description	Weight	Price
579	Floor Anchors for seismic and special applications. Order 4 per unit. Hardware to be determined by independent seismic engineer. Hardware not included.	1 lbs. (each)	\$37.00



Part #	Description	Weight	Price
TUP.XX	Touch-up Paint Jars XX = Gloss-Tek Color Code	.7 oz.	\$11.45

Items in bold print are also available on the Times-2 XPRESS Program.

= X·P·R·E·S·S

LETTER-SIZE COMPONENT PRICING

END PANELS

Part #	Description	Weight	Price
132	2-Tier End Panel	10.75 lbs.	\$137.00
133	3-Tier End Panel	15.98 lbs.	\$139.00
1341	4-Tier End Panel	19.52 lbs.	\$152.00
135	5-Tier End Panel	22.66 lbs.	\$170.00
136	6-Tier End Panel	26.71 lbs.	\$194.00
137	7-Tier End Panel	32.27 lbs.	\$212.00
138	8-Tier End Panel	36.52 lbs.	\$235.00
Plus Sizes			
1353	5-Tier Plus End Panel	22.66 lbs.	\$182.00
1363	6-Tier Plus End Panel	29.51 lbs.	\$202.00
1374	7-Tier Plus End Panel	34.27 lbs.	\$223.00

POSTS (VINYL AND LOCKS EXTRA)

Part #	Description	Weight	Price
092	2-Tier Plain Post	3.10 lbs.	\$80.00
093	3-Tier Plain Post	3.57 lbs.	\$81.00
0941	4-Tier Plain Post	3.82 lbs.	\$87.00
095	5-Tier Plain Post	4.43 lbs.	\$90.00
096	6-Tier Plain Post	5.17 lbs.	\$93.00
097	7-Tier Plain Post	6.10 lbs.	\$95.00
098	8-Tier Plain Post	6.86 lbs.	\$107.00
Plus Sizes			
0953	5-Tier Plus Plain Post	5 lbs.	\$91.00
0963	6-Tier Plus Plain Post	5.5 lbs.	\$94.00
0974	7-Tier Plus Plain Post	6.6 lbs.	\$102.00

Specify .01 after part # if you need post with lock hole.

CENTER PANELS

Part #	Description	Weight	Price
112	2-Tier Center Panel	4.75 lbs.	\$118.00
113	3-Tier Center Panel	7.92 lbs.	\$121.00
1141	4-Tier Center Panel	9.89 lbs.	\$134.00
115	5-Tier Center Panel	12.21 lbs.	\$147.00
116	6-Tier Center Panel	14.55 lbs.	\$160.00
117	7-Tier Center Panel	16.91 lbs.	\$170.00
118	8-Tier Center Panel	19.25 lbs.	\$201.00
Plus Sizes			
1153	5-Tier Plus Center Panel	13.21 lbs.	\$153.00
1163	6-Tier Plus Center Panel	15.5 lbs.	\$166.00
1174	7-Tier Plus Center Panel	17.91 lbs.	\$187.00

DOORS

Part #	Description	Weight	Price
142	2-Tier Door	10.5 lbs.	\$213.00
143	3-Tier Door	17 lbs.	\$215.00
1441	4-Tier Door	20.3 lbs.	\$217.00
145	5-Tier Door	25.03 lbs.	\$227.00
146	6-Tier Door	29.77 lbs.	\$268.00
147	7-Tier Door	34.51 lbs.	\$284.00
148	8-Tier Door	39.25 lbs.	\$324.00
Plus Sizes			
1453	5-Tier Plus Door	27.5 lbs.	\$247.00
1463	6-Tier Plus Door	32 lbs.	\$277.00
1474	7-Tier Plus Door	36.01 lbs.	\$304.00

COMPLETE BASE ASSEMBLIES

Includes Rotor Bottom, Bearings, and Ball Cage

Part #	Description	Weight	Price
025	Base Starter Complete	109.98 lbs.	\$830.00
026	Base Add-on Complete	105.22 lbs.	\$798.00

CANOPY TOPS

Part #	Description	Weight	Price
060	Canopy Top, Starter*	13.26 lbs.	\$137.00
052	Canopy Top, Add-on*	11.73 lbs.	\$136.00
1096	Ext. Canopy Top, Starter*	16.24 lbs.	\$237.00
1098	Ext. Canopy Top, Add-on*	14.30 lbs.	\$235.00

*Extended Tops require special length wall closing strips, see page 16.

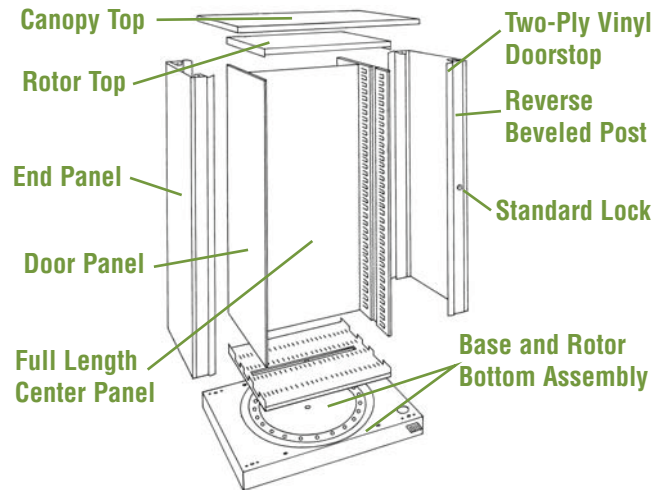

ROTOR TOP

Part #	Description	Weight	Price
049	Rotor Top	6.95 lbs.	\$105.00

FILLER BASE (FOR CONVERSION KITS)

Part #	Description	Weight	Price
070	Filler Base	8 lbs.	\$230.00

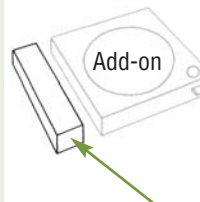

Use filler base to add to the left. Use with Add-on to create a Starter.
25" x 5-3/4" x 3-3/8"

LETTER-SIZE COMPONENT PRICING

COMMON COMPONENTS

Part #	Description	Weight	Price
018	Levelers	.5 lbs.	\$1.25
020	Base Lock Nut	0.1 lbs.	\$1.25
034	5/8" Diameter Bearing (Letter 22)	0.05 lbs.	\$1.25
056M	Bronze Base Washer	0.25 lbs.	\$4.75
066	"U" Clamps	0.25 lbs.	\$3.60
162	2-Tier Vinyl Strip	0.25 lbs.	\$15.25
163	3-Tier Vinyl Strip	0.38 lbs.	\$16.30
1641	4-Tier Vinyl Strip	0.5 lbs.	\$17.40
165	5-Tier Vinyl Strip	0.63 lbs.	\$18.50
166	6-Tier Vinyl Strip	0.75 lbs.	\$22.30
167	7-Tier Vinyl Strip	0.88 lbs.	\$24.50
168	8-Tier Vinyl Strip	1.0 lbs.	\$26.95
1653	5-Tier Plus Vinyl Strip	.75 lbs.	\$21.25
1663	6-Tier Plus Vinyl Strip	1.05 lbs.	\$23.40
1674	7-Tier Plus Vinyl Strip	1.08 lbs.	\$24.50
316	Wire Folder Guard	0.25 lbs.	\$2.20
424	Lock Cylinders, Cams & Keys	0.5 lbs.	\$20.65
428	Vertical Lock Rod**	0.5 lbs.	\$16.30
440	Floor Protectors	0.05 lbs.	\$8.20
513	Lock Access Hole Cover	0.1 lbs.	\$1.10
527	Bolts (5/16 - 18)	0.5 lbs.	\$1.10
529	Tinnerman Nuts	0.1 lbs.	\$1.10
531	Plug Buttons - 3/8"	0.1 lbs.	\$1.10
532P	Aluminum Drive Rivets for Pre-1997 units (Bag of 38)	1.9 lbs.	\$16.30
968	Security Drawer Lock	0.25 lbs.	\$21.25
TUP.XX	Touch-up Paint (Jar)	.7 lbs.	\$11.45
999	Tie Strap	0.82 lbs.	\$28.30

XX = Variable color code.

**Not for 2-Tier units.

MAGNETIC DRY ERASE OVERLAYS

Part #	Description	Width	Length	Weight	Price
239DE.X	2-Tier	25"	24 1/4"	2.72 lbs.	\$198.00
339DE.X	3-Tier	25"	36 1/2"	2.72 lbs.	\$218.00
439DE.X	4-Tier	25"	45 1/4"	3.37 lbs.	\$248.00
539DE.X	5-Tier	25"	55 3/4"	4.16 lbs.	\$279.00
639DE.X	6-Tier	25"	66 1/4"	4.94 lbs.	\$318.00
739DE.X	7-Tier	25"	76 3/4"	5.73 lbs.	\$342.00
839DE.X	8-Tier	25"	87 1/4"	6.51 lbs.	\$385.00
Plus Size					
5393DE.X	5-Tier Plus	25"	60 7/8"	4.5 lbs.	\$298.00
6393DE.X	6-Tier Plus	25"	71 3/8"	5.5 lbs.	\$329.00
7394DE.X	7-Tier Plus	25"	83 3/4"	6.3 lbs.	\$363.00
005DE	Board Eraser			0.12 lbs.	\$29.35

X = G (Greystone), W (White), or S (Sandstone).
Pricing per panel.



MAGNETIC FABRIC OVERLAYS

Part #	Description	Width	Length	Weight	Price
239FO	2-Tier	25"	24 1/4"	2.72 lbs.	\$198.00
339FO	3-Tier	25"	36 1/2"	2.72 lbs.	\$218.00
439FO	4-Tier	25"	45 1/4"	3.37 lbs.	\$248.00
539FO	5-Tier	25"	55 3/4"	4.16 lbs.	\$279.00
639FO	6-Tier	25"	66 1/4"	4.94 lbs.	\$318.00
739FO	7-Tier	25"	76 3/4"	5.73 lbs.	\$342.00
839FO	8-Tier	25"	87 1/4"	6.51 lbs.	\$385.00
Plus Size					
5393FO	5-Tier Plus	25"	60 7/8"	4.5 lbs.	\$298.00
6393FO	6-Tier Plus	25"	71 3/8"	5.5 lbs.	\$329.00
7394FO	7-Tier Plus	25"	83 3/4"	6.3 lbs.	\$363.00

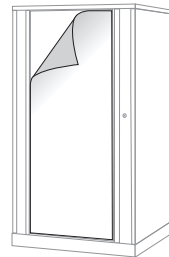

See fabric sell sheet for fabric selections.
Pricing per panel.

ADD-ON TO STARTER UNIT CONVERSION KITS

A kit consists of: 2-End Panels, 2-Posts, Starter Canopy Top, 1-Filler Base. All hardware is included with kit.

The color should be specified when ordering.

Part #	No. of Tiers	Weight	Price
12CK	2	45.5 lbs.	\$409.00
13CK	3	62.34 lbs.	\$417.00
141CK	4	63.52 lbs.	\$466.00
15CK	5	98.35 lbs.	\$516.00
16CK	6	108.62 lbs.	\$586.00
17CK	7	118.89 lbs.	\$642.00
18CK	8	129.2 lbs.	\$746.00
153CK	5 Plus	103.5 lbs.	\$550.00
163CK	6 Plus	114 lbs.	\$614.00
174CK	7 Plus	124 lbs.	\$696.00

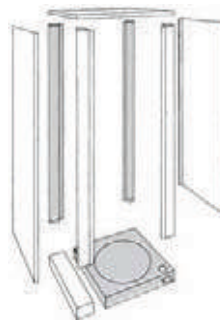

Items in bold print are also available on the Times-2 XPRESS Program.

= X·P·R·E·S·S

LETTER-SIZE QUIK-PANEL SLATWALL



Add a Quik-Panel to any new Times-2 unit or retrofit it in the field.
 Pricing below is per panel. Each panel comes with a hardware kit for mounting.
 Quik-Panel comes in full height panels to match the ten Times-2 unit heights from
 2-Tier to 8-Tier including Plus Sizes, or order panels in 2', 3' and 4' heights.

Quik-Panel is available in :

- Wood-Tek - Standard Woods & Stains
- Wood-Tek - Custom Stains on Cherry, Maple or Oak
- Wood-Tek - Custom Stains on Mahogany
- WilsonArt Laminate
- Aluminum or Black Vinyl slat inserts

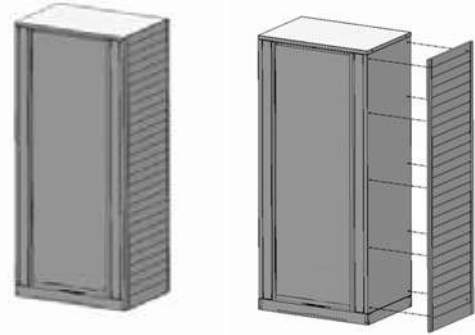

WOOD-TEK QUIK-PANEL WITH ALUMINUM INSERTS

Part #	Description	W	D	H	Stain	Weight	Price
121SW-41AP	2-Tier Panel	25"	3/4"	29 1/2"	Red Cherry	17 lbs.	\$1,485.00
121SW-42AP	2-Tier Panel	25"	3/4"	29 1/2"	Honey Cherry	17 lbs.	\$1,485.00
121SW-43AP	2-Tier Panel	25"	3/4"	29 1/2"	Chestnut Cherry	17 lbs.	\$1,485.00
121SW-61AP	2-Tier Panel	25"	3/4"	29 1/2"	Natural Maple	17 lbs.	\$1,485.00
121SW-SPL1AP	2-Tier Panel	25"	3/4"	29 1/2"	Custom Stain on Cherry, Maple or Oak	17 lbs.	\$1,635.00
121SW-SPL2AP	2-Tier Panel	25"	3/4"	29 1/2"	Custom Stain on Mahogany	17 lbs.	\$1,885.00
121SW-SPLAP	2-Tier Panel	25"	3/4"	29 1/2"	Custom Stains on other Wood Species	17 lbs.	**
131SW-41AP	3-Tier Panel	25"	3/4"	41 5/8"	Red Cherry	24 lbs.	\$1,510.00
131SW-42AP	3-Tier Panel	25"	3/4"	41 5/8"	Honey Cherry	24 lbs.	\$1,510.00
131SW-43AP	3-Tier Panel	25"	3/4"	41 5/8"	Chestnut Cherry	24 lbs.	\$1,510.00
131SW-61AP	3-Tier Panel	25"	3/4"	41 5/8"	Natural Maple	24 lbs.	\$1,510.00
131SW-SPL1AP	3-Tier Panel	25"	3/4"	41 5/8"	Custom Stain on Cherry, Maple or Oak	24 lbs.	\$1,660.00
131SW-SPL2AP	3-Tier Panel	25"	3/4"	41 5/8"	Custom Stain on Mahogany	24 lbs.	\$1,910.00
131SW-SPLAP	3-Tier Panel	25"	3/4"	41 5/8"	Custom Stains on other Wood Species	24 lbs.	**
141SW-41AP	4-Tier Panel	25"	3/4"	50 3/8"	Red Cherry	29 lbs.	\$1,600.00
141SW-42AP	4-Tier Panel	25"	3/4"	50 3/8"	Honey Cherry	29 lbs.	\$1,600.00
141SW-43AP	4-Tier Panel	25"	3/4"	50 3/8"	Chestnut Cherry	29 lbs.	\$1,600.00
141SW-61AP	4-Tier Panel	25"	3/4"	50 3/8"	Natural Maple	29 lbs.	\$1,600.00
141SW-SPL1AP	4-Tier Panel	25"	3/4"	50 3/8"	Custom Stain on Cherry, Maple or Oak	29 lbs.	\$1,755.00
141SW-SPL2AP	4-Tier Panel	25"	3/4"	50 3/8"	Custom Stain on Mahogany	29 lbs.	\$2,020.00
141SW-SPLAP	4-Tier Panel	25"	3/4"	50 3/8"	Custom Stains on other Wood Species	29 lbs.	**
151SW-41AP	5-Tier Panel	25"	3/4"	60 7/8"	Red Cherry	35 lbs.	\$1,620.00
151SW-42AP	5-Tier Panel	25"	3/4"	60 7/8"	Honey Cherry	35 lbs.	\$1,620.00
151SW-43AP	5-Tier Panel	25"	3/4"	60 7/8"	Chestnut Cherry	35 lbs.	\$1,620.00
151SW-61AP	5-Tier Panel	25"	3/4"	60 7/8"	Natural Maple	35 lbs.	\$1,620.00
151SW-SPL1AP	5-Tier Panel	25"	3/4"	60 7/8"	Custom Stain on Cherry, Maple or Oak	35 lbs.	\$1,775.00
151SW-SPL2AP	5-Tier Panel	25"	3/4"	60 7/8"	Custom Stain on Mahogany	35 lbs.	\$2,040.00
151SW-SPLAP	5-Tier Panel	25"	3/4"	60 7/8"	Custom Stains on other Wood Species	35 lbs.	**
1513SW-41AP	5-Tier Plus Panel	25"	3/4"	66 1/8"	Red Cherry	38 lbs.	\$1,635.00
1513SW-42AP	5-Tier Plus Panel	25"	3/4"	66 1/8"	Honey Cherry	38 lbs.	\$1,635.00
1513SW-43AP	5-Tier Plus Panel	25"	3/4"	66 1/8"	Chestnut Cherry	38 lbs.	\$1,635.00
1513SW-61AP	5-Tier Plus Panel	25"	3/4"	66 1/8"	Natural Maple	38 lbs.	\$1,635.00
1513SW-SPL1AP	5-Tier Plus Panel	25"	3/4"	66 1/8"	Custom Stain on Cherry, Maple or Oak	38 lbs.	\$1,790.00
1513SW-SPL2AP	5-Tier Plus Panel	25"	3/4"	66 1/8"	Custom Stain on Mahogany	38 lbs.	\$2,050.00
1513SW-SPLAP	5-Tier Plus Panel	25"	3/4"	66 1/8"	Custom Stains on other Wood Species	38 lbs.	**

** Call Customer Service for a quote.

LETTER-SIZE QUIK-PANEL SLATWALL

WOOD-TEK QUIK-PANEL WITH ALUMINUM INSERTS

Part #	Description	W	D	H	Stain	Weight	Price
161SW-41AP	6-Tier Panel	25" x	3/4" x	71 3/8"	Red Cherry	41 lbs.	\$1,655.00
161SW-42AP	6-Tier Panel	25" x	3/4" x	71 3/8"	Honey Cherry	41 lbs.	\$1,655.00
161SW-43AP	6-Tier Panel	25" x	3/4" x	71 3/8"	Chestnut Cherry	41 lbs.	\$1,655.00
161SW-61AP	6-Tier Panel	25" x	3/4" x	71 3/8"	Natural Maple	41 lbs.	\$1,655.00
161SW-SPL1AP	6-Tier Panel	25" x	3/4" x	71 3/8"	Custom Stain on Cherry, Maple or Oak	41 lbs.	\$1,810.00
161SW-SPL2AP	6-Tier Panel	25" x	3/4" x	71 3/8"	Custom Stain on Mahogany	41 lbs.	\$2,070.00
161SW-SPLAP	6-Tier Panel	25" x	3/4" x	71 3/8"	Custom Stains on other Wood Species	41 lbs.	**
1613SW-41AP	6-Tier Plus Panel	25" x	3/4" x	76 5/8"	Red Cherry	44 lbs.	\$1,670.00
1613SW-42AP	6-Tier Plus Panel	25" x	3/4" x	76 5/8"	Honey Cherry	44 lbs.	\$1,670.00
1613SW-43AP	6-Tier Plus Panel	25" x	3/4" x	76 5/8"	Chestnut Cherry	44 lbs.	\$1,670.00
1613SW-61AP	6-Tier Plus Panel	25" x	3/4" x	76 5/8"	Natural Maple	44 lbs.	\$1,670.00
1613SW-SPL1AP	6-Tier Plus Panel	25" x	3/4" x	76 5/8"	Custom Stain on Cherry, Maple or Oak	44 lbs.	\$1,825.00
1613SW-SPL2AP	6-Tier Plus Panel	25" x	3/4" x	76 5/8"	Custom Stain on Mahogany	44 lbs.	\$2,085.00
1613SW-SPLAP	6-Tier Plus Panel	25" x	3/4" x	76 5/8"	Custom Stains on other Wood Species	44 lbs.	**
171SW-41AP	7-Tier Panel	25" x	3/4" x	82"	Red Cherry	47 lbs.	\$1,710.00
171SW-42AP	7-Tier Panel	25" x	3/4" x	82"	Honey Cherry	47 lbs.	\$1,710.00
171SW-43AP	7-Tier Panel	25" x	3/4" x	82"	Chestnut Cherry	47 lbs.	\$1,710.00
171SW-61AP	7-Tier Panel	25" x	3/4" x	82"	Natural Maple	47 lbs.	\$1,710.00
171SW-SPL1AP	7-Tier Panel	25" x	3/4" x	82"	Custom Stain on Cherry, Maple or Oak	47 lbs.	\$1,835.00
171SW-SPL2AP	7-Tier Panel	25" x	3/4" x	82"	Custom Stain on Mahogany	47 lbs.	\$2,095.00
171SW-SPLAP	7-Tier Panel	25" x	3/4" x	82"	Custom Stains on other Wood Species	47 lbs.	**
1714SW-41AP	7-Tier Plus Panel	25" x	3/4" x	89"	Red Cherry	51 lbs.	\$1,735.00
1714SW-42AP	7-Tier Plus Panel	25" x	3/4" x	89"	Honey Cherry	51 lbs.	\$1,735.00
1714SW-43AP	7-Tier Plus Panel	25" x	3/4" x	89"	Chestnut Cherry	51 lbs.	\$1,735.00
1714SW-61AP	7-Tier Plus Panel	25" x	3/4" x	89"	Natural Maple	51 lbs.	\$1,735.00
1714SW-SPL1AP	7-Tier Plus Panel	25" x	3/4" x	89"	Custom Stain on Cherry, Maple or Oak	51 lbs.	\$1,855.00
1714SW-SPL2AP	7-Tier Plus Panel	25" x	3/4" x	89"	Custom Stain on Mahogany	51 lbs.	\$2,115.00
1714SW-SPLAP	7-Tier Plus Panel	25" x	3/4" x	89"	Custom Stains on other Wood Species	51 lbs.	**
181SW-41AP	8-Tier Panel	25" x	3/4" x	92 1/2"	Red Cherry	53 lbs.	\$1,745.00
181SW-42AP	8-Tier Panel	25" x	3/4" x	92 1/2"	Honey Cherry	53 lbs.	\$1,745.00
181SW-43AP	8-Tier Panel	25" x	3/4" x	92 1/2"	Chestnut Cherry	53 lbs.	\$1,745.00
181SW-61AP	8-Tier Panel	25" x	3/4" x	92 1/2"	Natural Maple	53 lbs.	\$1,745.00
181SW-SPL1AP	8-Tier Panel	25" x	3/4" x	92 1/2"	Custom Stain on Cherry, Maple or Oak	53 lbs.	\$1,865.00
181SW-SPL2AP	8-Tier Panel	25" x	3/4" x	92 1/2"	Custom Stain on Mahogany	53 lbs.	\$2,125.00
181SW-SPLAP	8-Tier Panel	25" x	3/4" x	92 1/2"	Custom Stains on other Wood Species	53 lbs.	**

** Call Customer Service for a quote.

WOOD-TEK QUIK-PANEL WITH BLACK VINYL INSERTS

Part #	Description	W	D	H	Stain	Weight	Price
121SW-41BP	2-Tier Panel	25"	3/4"	29 1/2"	Red Cherry	17 lbs.	\$1,450.00
121SW-42BP	2-Tier Panel	25"	3/4"	29 1/2"	Honey Cherry	17 lbs.	\$1,450.00
121SW-43BP	2-Tier Panel	25"	3/4"	29 1/2"	Chestnut Cherry	17 lbs.	\$1,450.00
121SW-61BP	2-Tier Panel	25"	3/4"	29 1/2"	Natural Maple	17 lbs.	\$1,450.00
121SW-SPL1BP	2-Tier Panel	25"	3/4"	29 1/2"	Custom Stain on Cherry, Maple or Oak	17 lbs.	\$1,600.00
121SW-SPL2BP	2-Tier Panel	25"	3/4"	29 1/2"	Custom Stain on Mahogany	17 lbs.	\$1,850.00
121SW-SPLBP	2-Tier Panel	25"	3/4"	29 1/2"	Custom Stains on other Wood Species	17 lbs.	**
131SW-41BP	3-Tier Panel	25"	3/4"	41 5/8"	Red Cherry	24 lbs.	\$1,475.00
131SW-42BP	3-Tier Panel	25"	3/4"	41 5/8"	Honey Cherry	24 lbs.	\$1,475.00
131SW-43BP	3-Tier Panel	25"	3/4"	41 5/8"	Chestnut Cherry	24 lbs.	\$1,475.00
131SW-61BP	3-Tier Panel	25"	3/4"	41 5/8"	Natural Maple	24 lbs.	\$1,475.00
131SW-SPL1BP	3-Tier Panel	25"	3/4"	41 5/8"	Custom Stain on Cherry, Maple or Oak	24 lbs.	\$1,625.00
131SW-SPL2BP	3-Tier Panel	25"	3/4"	41 5/8"	Custom Stain on Mahogany	24 lbs.	\$1,875.00
131SW-SPLBP	3-Tier Panel	25"	3/4"	41 5/8"	Custom Stains on other Wood Species	24 lbs.	**
141SW-41BP	4-Tier Panel	25"	3/4"	50 3/8"	Red Cherry	29 lbs.	\$1,565.00
141SW-42BP	4-Tier Panel	25"	3/4"	50 3/8"	Honey Cherry	29 lbs.	\$1,565.00
141SW-43BP	4-Tier Panel	25"	3/4"	50 3/8"	Chestnut Cherry	29 lbs.	\$1,565.00
141SW-61BP	4-Tier Panel	25"	3/4"	50 3/8"	Natural Maple	29 lbs.	\$1,565.00
141SW-SPL1BP	4-Tier Panel	25"	3/4"	50 3/8"	Custom Stain on Cherry, Maple or Oak	29 lbs.	\$1,720.00
141SW-SPL2BP	4-Tier Panel	25"	3/4"	50 3/8"	Custom Stain on Mahogany	29 lbs.	\$1,985.00
141SW-SPLBP	4-Tier Panel	25"	3/4"	50 3/8"	Custom Stains on other Wood Species	29 lbs.	**
151SW-41BP	5-Tier Panel	25"	3/4"	60 7/8"	Red Cherry	35 lbs.	\$1,585.00
151SW-42BP	5-Tier Panel	25"	3/4"	60 7/8"	Honey Cherry	35 lbs.	\$1,585.00
151SW-43BP	5-Tier Panel	25"	3/4"	60 7/8"	Chestnut Cherry	35 lbs.	\$1,585.00
151SW-61BP	5-Tier Panel	25"	3/4"	60 7/8"	Natural Maple	35 lbs.	\$1,585.00
151SW-SPL1BP	5-Tier Panel	25"	3/4"	60 7/8"	Custom Stain on Cherry, Maple or Oak	35 lbs.	\$1,740.00
151SW-SPL2BP	5-Tier Panel	25"	3/4"	60 7/8"	Custom Stain on Mahogany	35 lbs.	\$2,005.00
151SW-SPLBP	5-Tier Panel	25"	3/4"	60 7/8"	Custom Stains on other Wood Species	35 lbs.	**
1513SW-41BP	5-Tier Plus Panel	25"	3/4"	66 1/8"	Red Cherry	38 lbs.	\$1,600.00
1513SW-42BP	5-Tier Plus Panel	25"	3/4"	66 1/8"	Honey Cherry	38 lbs.	\$1,600.00
1513SW-43BP	5-Tier Plus Panel	25"	3/4"	66 1/8"	Chestnut Cherry	38 lbs.	\$1,600.00
1513SW-61BP	5-Tier Plus Panel	25"	3/4"	66 1/8"	Natural Maple	38 lbs.	\$1,600.00
1513SW-SPL1BP	5-Tier Plus Panel	25"	3/4"	66 1/8"	Custom Stain on Cherry, Maple or Oak	38 lbs.	\$1,755.00
1513SW-SPL2BP	5-Tier Plus Panel	25"	3/4"	66 1/8"	Custom Stain on Mahogany	38 lbs.	\$2,015.00
1513SW-SPLBP	5-Tier Plus Panel	25"	3/4"	66 1/8"	Custom Stains on other Wood Species	38 lbs.	**

** Call Customer Service for a quote.

LETTER-SIZE QUIK-PANEL SLATWALL

WOOD-TEK QUIK-PANEL WITH BLACK VINYL INSERTS

Part #	Description	W	D	H	Stain	Weight	Price
161SW-41BP	6-Tier Panel	25"	3/4"	71 3/8"	Red Cherry	41 lbs.	\$1,620.00
161SW-42BP	6-Tier Panel	25"	3/4"	71 3/8"	Honey Cherry	41 lbs.	\$1,620.00
161SW-43BP	6-Tier Panel	25"	3/4"	71 3/8"	Chestnut Cherry	41 lbs.	\$1,620.00
161SW-61BP	6-Tier Panel	25"	3/4"	71 3/8"	Natural Maple	41 lbs.	\$1,620.00
161SW-SPL1BP	6-Tier Panel	25"	3/4"	71 3/8"	Custom Stain on Cherry, Maple or Oak	41 lbs.	\$1,775.00
161SW-SPL2BP	6-Tier Panel	25"	3/4"	71 3/8"	Custom Stain on Mahogany	41 lbs.	\$2,035.00
161SW-SPLBP	6-Tier Panel	25"	3/4"	71 3/8"	Custom Stains on other Wood Species	41 lbs.	**
1613SW-41BP	6-Tier Plus Panel	25"	3/4"	76 5/8"	Red Cherry	44 lbs.	\$1,635.00
1613SW-42BP	6-Tier Plus Panel	25"	3/4"	76 5/8"	Honey Cherry	44 lbs.	\$1,635.00
1613SW-43BP	6-Tier Plus Panel	25"	3/4"	76 5/8"	Chestnut Cherry	44 lbs.	\$1,635.00
1613SW-61BP	6-Tier Plus Panel	25"	3/4"	76 5/8"	Natural Maple	44 lbs.	\$1,635.00
1613SW-SPL1BP	6-Tier Plus Panel	25"	3/4"	76 5/8"	Custom Stain on Cherry, Maple or Oak	44 lbs.	\$1,790.00
1613SW-SPL2BP	6-Tier Plus Panel	25"	3/4"	76 5/8"	Custom Stain on Mahogany	44 lbs.	\$2,050.00
1613SW-SPLBP	6-Tier Plus Panel	25"	3/4"	76 5/8"	Custom Stains on other Wood Species	44 lbs.	**
171SW-41BP	7-Tier Panel	25"	3/4"	82"	Red Cherry	47 lbs.	\$1,675.00
171SW-42BP	7-Tier Panel	25"	3/4"	82"	Honey Cherry	47 lbs.	\$1,675.00
171SW-43BP	7-Tier Panel	25"	3/4"	82"	Chestnut Cherry	47 lbs.	\$1,675.00
171SW-61BP	7-Tier Panel	25"	3/4"	82"	Natural Maple	47 lbs.	\$1,675.00
171SW-SPL1BP	7-Tier Panel	25"	3/4"	82"	Custom Stain on Cherry, Maple or Oak	47 lbs.	\$1,800.00
171SW-SPL2BP	7-Tier Panel	25"	3/4"	82"	Custom Stain on Mahogany	47 lbs.	\$2,060.00
171SW-SPLBP	7-Tier Panel	25"	3/4"	82"	Custom Stains on other Wood Species	47 lbs.	**
1714SW-41BP	7-Tier Plus Panel	25"	3/4"	89"	Red Cherry	51 lbs.	\$1,700.00
1714SW-42BP	7-Tier Plus Panel	25"	3/4"	89"	Honey Cherry	51 lbs.	\$1,700.00
1714SW-43BP	7-Tier Plus Panel	25"	3/4"	89"	Chestnut Cherry	51 lbs.	\$1,700.00
1714SW-61BP	7-Tier Plus Panel	25"	3/4"	89"	Natural Maple	51 lbs.	\$1,700.00
1714SW-SPL1BP	7-Tier Plus Panel	25"	3/4"	89"	Custom Stain on Cherry, Maple or Oak	51 lbs.	\$1,820.00
1714SW-SPL2BP	7-Tier Plus Panel	25"	3/4"	89"	Custom Stain on Mahogany	51 lbs.	\$2,080.00
1714SW-SPLBP	7-Tier Plus Panel	25"	3/4"	89"	Custom Stains on other Wood Species	51 lbs.	**
181SW-41BP	8-Tier Panel	25"	3/4"	92 1/2"	Red Cherry	53 lbs.	\$1,710.00
181SW-42BP	8-Tier Panel	25"	3/4"	92 1/2"	Honey Cherry	53 lbs.	\$1,710.00
181SW-43BP	8-Tier Panel	25"	3/4"	92 1/2"	Chestnut Cherry	53 lbs.	\$1,710.00
181SW-61BP	8-Tier Panel	25"	3/4"	92 1/2"	Natural Maple	53 lbs.	\$1,710.00
181SW-SPL1BP	8-Tier Panel	25"	3/4"	92 1/2"	Custom Stain on Cherry, Maple or Oak	53 lbs.	\$1,830.00
181SW-SPL2BP	8-Tier Panel	25"	3/4"	92 1/2"	Custom Stain on Mahogany	53 lbs.	\$2,090.00
181SW-SPLBP	8-Tier Panel	25"	3/4"	92 1/2"	Custom Stains on other Wood Species	53 lbs.	**

** Call Customer Service for a quote.

WOOD-TEK QUIK-PANEL WITH ALUMINUM INSERTS

Part #	Description	W	D	H	Stain	Weight	Price
24LTRSW-41AP	2' Panel	25" x	3/4" x	24"	Red Cherry	14 lbs.	\$1,430.00
24LTRSW-42AP	2' Panel	25" x	3/4" x	24"	Honey Cherry	14 lbs.	\$1,430.00
24LTRSW-43AP	2' Panel	25" x	3/4" x	24"	Chestnut Cherry	14 lbs.	\$1,430.00
24LTRSW-61AP	2' Panel	25" x	3/4" x	24"	Natural Maple	14 lbs.	\$1,430.00
24LTRSW-SPL1AP	2' Panel	25" x	3/4" x	24"	Custom Stain on Cherry, Maple or Oak	14 lbs.	\$1,570.00
24LTRSW-SPL2AP	2' Panel	25" x	3/4" x	24"	Custom Stain on Mahogany	14 lbs.	\$1,810.00
24LTRSW-SPLAP	2' Panel	25" x	3/4" x	24"	Custom Stains on other Wood Species	14 lbs.	**
36LTRSW-41AP	3' Panel	25" x	3/4" x	36"	Red Cherry	21 lbs.	\$1,485.00
36LTRSW-42AP	3' Panel	25" x	3/4" x	36"	Honey Cherry	21 lbs.	\$1,485.00
36LTRSW-43AP	3' Panel	25" x	3/4" x	36"	Chestnut Cherry	21 lbs.	\$1,485.00
36LTRSW-61AP	3' Panel	25" x	3/4" x	36"	Natural Maple	21 lbs.	\$1,485.00
36LTRSW-SPL1AP	3' Panel	25" x	3/4" x	36"	Custom Stain on Cherry, Maple or Oak	21 lbs.	\$1,635.00
36LTRSW-SPL2AP	3' Panel	25" x	3/4" x	36"	Custom Stain on Mahogany	21 lbs.	\$1,885.00
36LTRSW-SPLAP	3' Panel	25" x	3/4" x	36"	Custom Stains on other Wood Species	21 lbs.	**
48LTRSW-41AP	4' Panel	25" x	3/4" x	48"	Red Cherry	28 lbs.	\$1,510.00
48LTRSW-42AP	4' Panel	25" x	3/4" x	48"	Honey Cherry	28 lbs.	\$1,510.00
48LTRSW-43AP	4' Panel	25" x	3/4" x	48"	Chestnut Cherry	28 lbs.	\$1,510.00
48LTRSW-61AP	4' Panel	25" x	3/4" x	48"	Natural Maple	28 lbs.	\$1,510.00
48LTRSW-SPL1AP	4' Panel	25" x	3/4" x	48"	Custom Stain on Cherry, Maple or Oak	28 lbs.	\$1,660.00
48LTRSW-SPL2AP	4' Panel	25" x	3/4" x	48"	Custom Stain on Mahogany	28 lbs.	\$1,910.00
48LTRSW-SPLAP	4' Panel	25" x	3/4" x	48"	Custom Stains on other Wood Species	28 lbs.	**

WOOD-TEK QUIK-PANEL WITH BLACK VINYL INSERTS

Part #	Description	W	D	H	Stain	Weight	Price
24LTRSW-41BP	2' Panel	25" x	3/4" x	24"	Red Cherry	14 lbs.	\$1,395.00
24LTRSW-42BP	2' Panel	25" x	3/4" x	24"	Honey Cherry	14 lbs.	\$1,395.00
24LTRSW-43BP	2' Panel	25" x	3/4" x	24"	Chestnut Cherry	14 lbs.	\$1,395.00
24LTRSW-61BP	2' Panel	25" x	3/4" x	24"	Natural Maple	14 lbs.	\$1,395.00
24LTRSW-SPL1BP	2' Panel	25" x	3/4" x	24"	Custom Stain on Cherry, Maple or Oak	14 lbs.	\$1,535.00
24LTRSW-SPL2BP	2' Panel	25" x	3/4" x	24"	Custom Stain on Mahogany	14 lbs.	\$1,775.00
24LTRSW-SPLBP	2' Panel	25" x	3/4" x	24"	Custom Stains on other Wood Species	14 lbs.	**
36LTRSW-41BP	3' Panel	25" x	3/4" x	36"	Red Cherry	21 lbs.	\$1,450.00
36LTRSW-42BP	3' Panel	25" x	3/4" x	36"	Honey Cherry	21 lbs.	\$1,450.00
36LTRSW-43BP	3' Panel	25" x	3/4" x	36"	Chestnut Cherry	21 lbs.	\$1,450.00
36LTRSW-61BP	3' Panel	25" x	3/4" x	36"	Natural Maple	21 lbs.	\$1,450.00
36LTRSW-SPL1BP	3' Panel	25" x	3/4" x	36"	Custom Stain on Cherry, Maple or Oak	21 lbs.	\$1,600.00
36LTRSW-SPL2BP	3' Panel	25" x	3/4" x	36"	Custom Stain on Mahogany	21 lbs.	\$1,850.00
36LTRSW-SPLBP	3' Panel	25" x	3/4" x	36"	Custom Stains on other Wood Species	21 lbs.	**
48LTRSW-41BP	4' Panel	25" x	3/4" x	48"	Red Cherry	28 lbs.	\$1,475.00
48LTRSW-42BP	4' Panel	25" x	3/4" x	48"	Honey Cherry	28 lbs.	\$1,475.00
48LTRSW-43BP	4' Panel	25" x	3/4" x	48"	Chestnut Cherry	28 lbs.	\$1,475.00
48LTRSW-61BP	4' Panel	25" x	3/4" x	48"	Natural Maple	28 lbs.	\$1,475.00
48LTRSW-SPL1BP	4' Panel	25" x	3/4" x	48"	Custom Stain on Cherry, Maple or Oak	28 lbs.	\$1,625.00
48LTRSW-SPL2BP	4' Panel	25" x	3/4" x	48"	Custom Stain on Mahogany	28 lbs.	\$1,875.00
48LTRSW-SPLBP	4' Panel	25" x	3/4" x	48"	Custom Stains on other Wood Species	28 lbs.	**

** Call Customer Service for a quote.

LETTER-SIZE QUIK-PANEL SLATWALL

LAMINATE QUIK-PANEL WITH ALUMINUM INSERTS

Part #	Description	W	D	H	Laminate	Weight	Price
121SW-AP	2-Tier Panel	25"	3/4"	29 1/2"	Standard Wilsonart Laminates	17 lbs.	\$1,185.00
131SW-AP	3-Tier Panel	25"	3/4"	41 5/8"	Standard Wilsonart Laminates	24 lbs.	\$1,196.00
141SW-AP	4-Tier Panel	25"	3/4"	50 3/8"	Standard Wilsonart Laminates	29 lbs.	\$1,294.00
151SW-AP	5-Tier Panel	25"	3/4"	60 7/8"	Standard Wilsonart Laminates	35 lbs.	\$1,305.00
1513SW-AP	5-Tier Plus Panel	25"	3/4"	66 1/8"	Standard Wilsonart Laminates	38 lbs.	\$1,315.00
161SW-AP	6-Tier Panel	25"	3/4"	71 3/8"	Standard Wilsonart Laminates	41 lbs.	\$1,325.00
1613SW-AP	6-Tier Plus Panel	25"	3/4"	76 5/8"	Standard Wilsonart Laminates	44 lbs.	\$1,336.00
171SW-AP	7-Tier Panel	25"	3/4"	82"	Standard Wilsonart Laminates	47 lbs.	\$1,346.00
1714SW-AP	7-Tier Plus Panel	25"	3/4"	89"	Standard Wilsonart Laminates	51 lbs.	\$1,356.00
181SW-AP	8-Tier Panel	25"	3/4"	92 1/2"	Standard Wilsonart Laminates	53 lbs.	\$1,361.00

LAMINATE QUIK-PANEL WITH BLACK VINYL INSERTS

Part #	Description	W	D	H	Laminate	Weight	Price
121SW-BP	2-Tier Panel	25"	3/4"	29 1/2"	Standard Wilsonart Laminates	17 lbs.	\$1,149.00
131SW-BP	3-Tier Panel	25"	3/4"	41 5/8"	Standard Wilsonart Laminates	24 lbs.	\$1,160.00
141SW-BP	4-Tier Panel	25"	3/4"	50 3/8"	Standard Wilsonart Laminates	29 lbs.	\$1,258.00
151SW-BP	5-Tier Panel	25"	3/4"	60 7/8"	Standard Wilsonart Laminates	35 lbs.	\$1,268.00
1513SW-BP	5-Tier Plus Panel	25"	3/4"	66 1/8"	Standard Wilsonart Laminates	38 lbs.	\$1,278.00
161SW-BP	6-Tier Panel	25"	3/4"	71 3/8"	Standard Wilsonart Laminates	41 lbs.	\$1,289.00
1613SW-BP	6-Tier Plus Panel	25"	3/4"	76 5/8"	Standard Wilsonart Laminates	44 lbs.	\$1,300.00
171SW-BP	7-Tier Panel	25"	3/4"	82"	Standard Wilsonart Laminates	47 lbs.	\$1,310.00
1714SW-BP	7-Tier Plus Panel	25"	3/4"	89"	Standard Wilsonart Laminates	51 lbs.	\$1,320.00
181SW-BP	8-Tier Panel	25"	3/4"	92 1/2"	Standard Wilsonart Laminates	53 lbs.	\$1,325.00

LAMINATE QUIK-PANEL WITH ALUMINUM INSERTS

Part #	Description	W	D	H	Laminate	Weight	Price
24LTRSW-AP	2' Panel	25"	3/4"	24"	Standard Wilsonart Laminates	14 lbs.	\$1,123.00
36LTRSW-AP	3' Panel	25"	3/4"	36"	Standard Wilsonart Laminates	20 lbs.	\$1,165.00
48LTRSW-AP	4' Panel	25"	3/4"	48"	Standard Wilsonart Laminates	27 lbs.	\$1,207.00

LAMINATE QUIK-PANEL WITH BLACK VINYL INSERTS

Part #	Description	W	D	H	Laminate	Weight	Price
24LTRSW-BP	2' Panel	25"	3/4"	24"	Standard Wilsonart Laminates	14 lbs.	\$1,123.00
36LTRSW-BP	3' Panel	25"	3/4"	36"	Standard Wilsonart Laminates	20 lbs.	\$1,165.00
48LTRSW-BP	4' Panel	25"	3/4"	48"	Standard Wilsonart Laminates	27 lbs.	\$1,207.00

Prices reflect Standard Wilsonart Laminates.

Wilsonart Premium and High Definition Laminates are also available as a custom order. Call Customer Service for a quote.

LEGAL/A4- SIZE EMPTY UNITS

	Part #	Description	Dimensions* (WxDxH)	Capacity	Weight (lbs.)	Price
	221SE	2-Tier Starter	45¼"x31"x29½"	Empty unit can be configured to hold the equivalent of 4 file drawers, or 120 linear filing inches	240.52	\$2,241.00
	221AE	2-Tier Add-on	38⅞"x31"x29½"		193.85	\$1,893.00
	231SE	3-Tier Starter	45¼"x31"x41⅞"	Empty unit can be configured to hold the equivalent of 6 file drawers, or 180 linear filing inches	268.95	\$2,327.00
	231AE	3-Tier Add-on	38⅞"x31"x41⅞"		211.33	\$1,990.00
	241SE	4-Tier Starter	45¼"x31"x50⅞"	Empty unit can be configured to hold the equivalent of 8 file drawers, or 240 linear filing inches	293.39	\$2,371.00
	241AE	4-Tier Add-on	38⅞"x31"x50⅞"		225.65	\$2,039.00
	251SE	5-Tier Starter	45¼"x31"x60⅞"	Empty unit can be configured to hold the equivalent of 10 file drawers, or 300 linear filing inches	322.94	\$2,439.00
	251AE	5-Tier Add-on	38⅞"x31"x60⅞"		242.95	\$2,161.00
	261SE	6-Tier Starter	45¼"x31"x71⅞"	Empty unit can be configured to hold the equivalent of 12 file drawers, or 360 linear filing inches	352.44	\$2,632.00
	261AE	6-Tier Add-on	38⅞"x31"x71⅞"		260.22	\$2,322.00
	271SE	7-Tier Starter	45¼"x31"x82"	Empty unit can be configured to hold the equivalent of 14 file drawers, or 420 linear filing inches	381.72	\$2,952.00
	271AE	7-Tier Add-on	38⅞"x31"x82"		277.29	\$2,634.00
	281SE	8-Tier Starter	45¼"x31"x92½"	Empty unit can be configured to hold the equivalent of 16 file drawers, or 480 linear filing inches	411.4	\$3,142.00
	281AE	8-Tier Add-on	38⅞"x31"x92½"		294.73	\$2,769.00

LEGAL/A4 PLUS-SIZE EMPTY UNITS

Times-2 Plus-Size units at the 5, 6, 7-Tier height increase slightly in height to accommodate applications outside of the range of a regular unit. The extra louver space can be used for a rollout reference shelf or to create any configuration that is needed.

	Part #	Description	Dimensions* (WxDxH)	Capacity	Weight (lbs.)	Price
	2513SE	5-Tier Plus Starter	45¼"x31"x66⅞"	Empty unit can be configured to hold the equivalent of 10 file drawers, or 300 linear filing inches	337.74	\$2,439.00
	2513AE	5-Tier Plus Add-on	38⅞"x31"x66⅞"		251.58	\$2,161.00
	2613SE	6-Tier Plus Starter	45¼"x31"x76⅞"	Empty unit can be configured to hold the equivalent of 12 file drawers, or 360 linear filing inches	369.81	\$2,632.00
	2613AE	6-Tier Plus Add-on	38⅞"x31"x76⅞"		271.42	\$2,322.00
	2714SE	7-Tier Plus Starter	45¼"x31"x89"	Empty unit can be configured to hold the equivalent of 14 file drawers, or 420 linear filing inches	404.95	\$2,952.00
	2714AE	7-Tier Plus Add-on	38⅞"x31"x89"		292.33	\$2,634.00

*Allow additional 7-¼" depth clearance from wall to accommodate rotation of unit.

Items in bold print are also available on the Times-2 XPRESS Program.

Hand Release Option: Order part number and add "NF" suffix, example:151SENF.

= X·P·R·E·S·S

LEGAL/A4-SIZE STANDARD UNITS

	Part #	Description	Dimensions* (WxDxH)	Capacity/Configuration	Weight (lbs.)	Price
	221S	2-Tier Starter	45¼"x31"x29½"	• 120 linear filing inches	258.5	\$2,302.00
	221A	2-Tier Add-on	38⅞"x31"x29½"	Unit includes: • (2) 902 Adjustable, Reversible Shelves • (1) 461P Divider Pack • (1) 462P Divider Pack	211.5	\$1,971.00
	231S	3-Tier Starter	45¼"x31"x41⅝"	• 180 linear filing inches	315.34	\$2,503.00
	231A	3-Tier Add-on	38⅞"x31"x41⅝"	Unit includes: • (4) 902 Adjustable, Reversible Shelves • (1) 461P Divider Pack • (2) 462P Divider Pack	257.72	\$2,182.00
	241S	4-Tier Starter	45¼"x31"x50⅝"	• 240 linear filing inches	363.35	\$2,710.00
	241A	4-Tier Add-on	38⅞"x31"x50⅝"	Unit includes: • (6) 902 Adjustable, Reversible Shelves • (4) 461P Divider Pack • (1) 462P Divider Pack	295.61	\$2,393.00
	251S	5-Tier Starter	45¼"x31"x60⅝"	• 300 linear filing inches	412.61	\$2,899.00
	251A	5-Tier Add-on	38⅞"x31"x60⅝"	Unit includes: • (8) 902 Adjustable, Reversible Shelves • (5) 461P Divider Pack • (1) 462P Divider Pack	332.61	\$2,633.00
	261S	6-Tier Starter	45¼"x31"x71⅝"	• 360 linear filing inches	461.82	\$3,210.00
	261A	6-Tier Add-on	38⅞"x31"x71⅝"	Unit includes: • (10) 902 Adjustable, Reversible Shelves • (6) 461P Divider Pack • (1) 462P Divider Pack	369.6	\$2,910.00
	271S	7-Tier Starter	45¼"x31"x82"	• 420 linear filing inches	510.81	\$3,636.00
	271A	7-Tier Add-on	38⅞"x31"x82"	Unit includes: • (12) 902 Adjustable, Reversible Shelves • (7) 461P Divider Pack • (1) 462P Divider Pack	406.39	\$3,304.00
	281S	8-Tier Starter	45¼"x31"x92½"	• 480 linear filing inches	560.21	\$3,956.00
	281A	8-Tier Add-on	38⅞"x31"x92½"	Unit includes: • (14) 902 Adjustable, Reversible Shelves • (8) 461P Divider Pack • (1) 462P Divider Pack	443.53	\$3,585.00

*Allow additional 7-¼" depth clearance from wall to accommodate rotation of unit.

Items in bold print are also available on the Times-2 XPRESS Program.

Hand Release Option: Order part number and add "NF" suffix, example:151SENF.





FN unit comes with 992 Rollout Hanging Folder Frames.

	Part #	Description	Dimensions* (WxDxH)	Capacity/Configuration	Weight (lbs.)	Price
	221SFN	2-Tier Starter	45¼"x31"x29½"	• 120 linear filing inches	284	\$2,778.00
	221AFN	2-Tier Add-on	38⅞"x31"x29½"	Unit includes: • (4) 992 Rollout Hanging Folder Frame	237	\$2,447.00
	231SFN	3-Tier Starter	45¼"x31"x41⅞"	• 180 linear filing inches	333.51	\$3,128.00
	231AFN	3-Tier Add-on	38⅞"x31"x41⅞"	Unit includes: • (6) 992 Rollout Hanging Folder Frame	275.89	\$2,807.00
	241SFN	4-Tier Starter	45¼"x31"x50⅞"	• 240 linear filing inches	379.48	\$3,468.00
	241AFN	4-Tier Add-on	38⅞"x31"x50⅞"	Unit includes: • (8) 992 Rollout Hanging Folder Frame	311.74	\$3,159.00
	251SFN	5-Tier Starter	45¼"x31"x60⅞"	• 300 linear filing inches	430.55	\$3,846.00
	251AFN	5-Tier Add-on	38⅞"x31"x60⅞"	Unit includes: • (10) 992 Rollout Hanging Folder Frame	350.56	\$3,580.00
	261SFN	6-Tier Starter	45¼"x31"x71⅞"	• 360 linear filing inches	479.76	\$3,998.00
	261AFN	6-Tier Add-on	38⅞"x31"x71⅞"	Unit includes: • (10) 992 Rollout Hanging Folder Frame • (2) 902 Adjustable, Reversible Shelf • (1) 461P Package 10" Dividers	387.54	\$3,850.00
	271SFN	7-Tier Starter	45¼"x31"x82"	• 420 linear filing inches	528.76	\$4,583.00
	271AFN	7-Tier Add-on	38⅞"x31"x82"	Unit includes: • (10) 992 Rollout Hanging Folder Frame • (4) 902 Adjustable, Reversible Shelf • (2) 461P Package 10" Dividers	424.33	\$4,308.00
	281SFN	8-Tier Starter	45¼"x31"x92½"	• 480 linear filing inches	578.15	\$4,929.00
	281AFN	8-Tier Add-on	38⅞"x31"x92½"	Unit includes: • (10) 992 Rollout Hanging Folder Frame • (6) 902 Adjustable, Reversible Shelf • (3) 461P Package 10" Dividers	461.47	\$4,588.00

*Allow additional 7-¼" depth clearance from wall to accommodate rotation of unit.
When using Rollout Hanging Folder Frame, deduct 1-½" per frame from the LFI measurement.
Hand Release Option: Order part number and add "NF" suffix, example:151SENF.



LEGAL/A4-SIZE RN UNITS

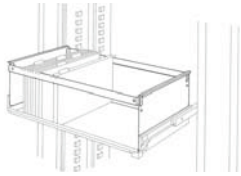

RN unit comes with 1996 Rollout Drawer with Hanging Folder Frames.

	Part #	Description	Dimensions* (WxDxH)	Capacity/Configuration	Weight (lbs.)	Price
	221SRN	2-Tier Starter	45¼"x31"x29½"	• 120 linear filing inches	341	\$3,138.00
	221ARN	2-Tier Add-on	38⅞"x31"x29½"	Unit includes: • (4) 1996 Rollout Drawer with Hanging Folder Frame	294	\$2,807.00
	231SRN	3-Tier Starter	45¼"x31"x41⅝"	• 180 linear filing inches	419.58	\$3,544.00
	231ARN	3-Tier Add-on	38⅞"x31"x41⅝"	Unit includes: • (6) 1996 Rollout Drawer with Hanging Folder Frame	361.96	\$3,223.00
	241SRN	4-Tier Starter	45¼"x31"x50⅝"	• 240 linear filing inches	494.24	\$4,019.00
	241ARN	4-Tier Add-on	38⅞"x31"x50⅝"	Unit includes: • (8) 1996 Rollout Drawer with Hanging Folder Frame	426.5	\$3,702.00
	251SRN	5-Tier Starter	45¼"x31"x60⅞"	• 300 linear filing inches	574	\$4,523.00
	251ARN	5-Tier Add-on	38⅞"x31"x60⅞"	Unit includes: • (10) 1996 Rollout Drawer with Hanging Folder Frame	494.01	\$4,259.00
	261SRN	6-Tier Starter	45¼"x31"x71⅜"	• 360 linear filing inches	623.21	\$4,676.00
	261ARN	6-Tier Add-on	38⅞"x31"x71⅜"	Unit includes: • (10) 1996 Rollout Drawer with Hanging Folder Frame • (2) 902 Adjustable, Reversible Shelf • (1) 461P Package 10" Dividers	530.99	\$4,528.00
	271SRN	7-Tier Starter	45¼"x31"x82"	• 420 linear filing inches	672.21	\$5,261.00
	271ARN	7-Tier Add-on	38⅞"x31"x82"	Unit includes: • (10) 1996 Rollout Drawer with Hanging Folder Frame • (4) 902 Adjustable, Reversible Shelf • (2) 461P Package 10" Dividers	567.78	\$4,987.00
	281SRN	8-Tier Starter	45¼"x31"x92½"	• 480 linear filing inches	721.6	\$5,607.00
	281ARN	8-Tier Add-on	38⅞"x31"x92½"	Unit includes: • (10) 1996 Rollout Drawer with Hanging Folder Frame • (6) 902 Adjustable, Reversible Shelf • (3) 461P Package 10" Dividers	604.92	\$5,266.00

*Allow additional 7-¼" depth clearance from wall to accommodate rotation of unit.
 When using Rollout Drawer with Hanging Folder Frame, deduct 1-½" per frame from the LFI measurement.
 Items in bold print are also available on the Times-2 XPRESS Program.
 Hand Release Option: Order part number and add "NF" suffix, example:151SENF.



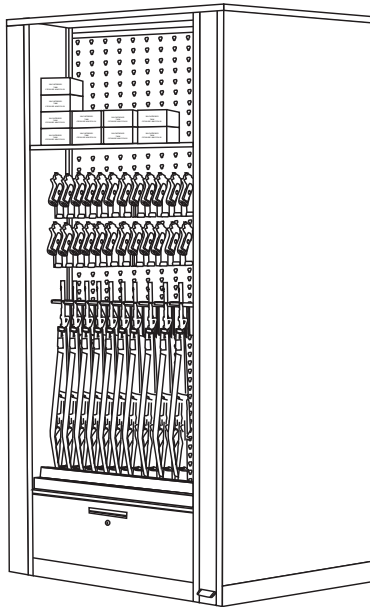

Aurora Weapons Storage Components are designed to mount in Empty Legal Size Times-2 Cabinets (5-Tier to 8-Tier recommended) to create flexible, space-efficient weapons storage for any rifle, shotgun, machine gun, or handgun.

Weapons Storage Components are interchangeable and feature separate stock and barrel holders, sloped stock shelves, hand-gun brackets with and without clip compartments, brackets for mounting rifles and swat weapons horizontally, steel storage boxes, and plastic totes for general storage.



5 1/2" BARREL SADDLE

- Holds top of Rifle
- Used with Stock Saddles
- 16 gauge steel with black rubber edging

Part #	D x H x L	Capacity	Weight	Price
X2WR1RBS5	5 1/2" x 6" x 3"	1	1.00 lbs.	\$25.00
X2WR4RBS5	5 1/2" x 6" x 12"	4	2.75 lbs.	\$91.00
X2WR5RBS5	5 1/2" x 6" x 15"	5	3.25 lbs.	\$114.00
X2WR6RBS5	5 1/2" x 6" x 18"	6	3.75 lbs.	\$126.00
X2WR7RBS5	5 1/2" x 6" x 21"	7	4.25 lbs.	\$137.00
X2WR8RBS5	5 1/2" x 6" x 24"	8	4.75 lbs.	\$149.00
X2WR10RBS5	5 1/2" x 6" x 30"	10	5.50 lbs.	\$172.00



7" BARREL SADDLE

- Holds top of Rifle
- Used with Stock Saddles
- 16 gauge steel with black rubber edging

Part #	D x H x L	Capacity	Weight	Price
X2WR1RBS7	7" x 6" x 3"	1	1.50 lbs.	\$25.00
X2WR4RBS7	7" x 6" x 12"	4	3.50 lbs.	\$91.00
X2WR5RBS7	7" x 6" x 15"	5	4.25 lbs.	\$114.00
X2WR6RBS7	7" x 6" x 18"	6	5.00 lbs.	\$126.00
X2WR7RBS7	7" x 6" x 21"	7	5.75 lbs.	\$137.00
X2WR8RBS7	7" x 6" x 24"	8	6.50 lbs.	\$149.00
X2WR10RBS7	7" x 6" x 30"	10	7.50 lbs.	\$172.00

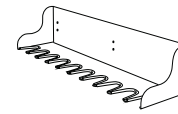

STOCK SADDLE

- Holds bottom of Rifle
- Used with Barrel Saddles
- 16 gauge steel with black rubber edging

Part #	D x H x L	Capacity	Weight	Price
X2WR1RSS	7" x 6" x 3"	1	2.25 lbs.	\$32.00
X2WR4RSS	7" x 6" x 12"	4	4.00 lbs.	\$114.00
X2WR5RSS	7" x 6" x 15"	5	4.50 lbs.	\$134.00
X2WR6RSS	7" x 6" x 18"	6	5.00 lbs.	\$146.00
X2WR7RSS	7" x 6" x 21"	7	5.55 lbs.	\$166.00
X2WR8RSS	7" x 6" x 24"	8	6.00 lbs.	\$182.00
X2WR10RSS	7" x 6" x 30"	10	7.25 lbs.	\$195.00

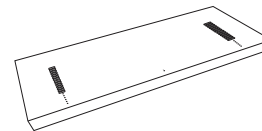

SLOPED BOTTOM SHELF

- Used to hold Rifle Stocks

Part #	W x H x D	Weight	Price
X2WRBS	30" x 2" x 14"	7.75 lbs.	\$41.00

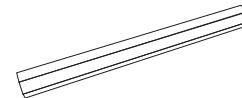

SLOPED BOTTOM SHELF STOP

- Stop for front of Sloped Bottom Shelf
- 18 gauge steel

Part #	W x H x D	Weight	Price
X2WRBSS	30" x 2" x 2"	2.75 lbs.	\$25.00

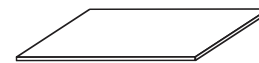

RUBBER MAT FOR SLOPED BOTTOM SHELF

Part #	W x H x L	Weight	Price
WRMAT	24" x 1/8" x 48"	.5 lbs.	\$43.75

- Black mat for lining sloped bottom shelf
- Protects weapon stocks
- Trim to size with scissors

WEAPONS STORAGE

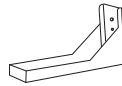

SLOPED STOCK SHELF

- Holds bottom of all types of large weapons
- 16 gauge steel

Part #	D x H x L	Capacity	Weight	Price
X2WR1RSSHF	11" x 6" x 3"	1	1.75 lbs.	\$23.95
X2WR4RSSHF	11" x 6" x 12"	4	4.50 lbs.	\$40.00
X2WR5RSSHF	11" x 6" x 15"	5	5.50 lbs.	\$50.00
X2WR6RSSHF	11" x 6" x 18"	6	6.50 lbs.	\$55.00
X2WR7RSSHF	11" x 6" x 21"	7	7.50 lbs.	\$63.00
X2WR8RSSHF	11" x 6" x 24"	8	8.50 lbs.	\$68.00
X2WR10RSSHF	11" x 6" x 30"	10	9.25 lbs.	\$83.00



HORIZONTAL BRACKET

- Holds weapon horizontally
- Two brackets per set
- 16 gauge steel, with black rubber edging
- Two (2) or three (3) weapon capacities

Part #	D	Capacity	Weight	Price
X2WR2RHB	9½"	2	2.25 lbs.	\$114.00
X2WR3RHB	13½"	3	3.25 lbs.	\$114.00

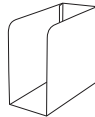

STEEL STORAGE BOX

- Ammunition and general storage
- 16 gauge steel

Part #	W x H x D	Weight	Price
X2WRSB3	3" x 7.5" x 6"	2.25 lbs.	\$41.00
X2WRSB6	6" x 7.5" x 6"	3.00 lbs.	\$50.00

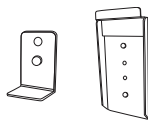

PLASTIC TOTE ACCESSORY

- Brackets and Clips, 16 gauge steel
- Formed to accept plastic totes (from others)
- Totes mounted on brackets with integrated clips (1" x 1")
- Clip secures tote to unit

Part #	DESCRIPTION	Weight	Price
X2WRTB	Tote Bracket	.50 lbs.	\$16.30
X2WRTC	Tote Clip	.25 lbs.	\$7.65

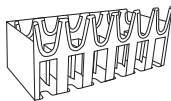

HAND GUN BRACKET WITH CLIP COMPARTMENT

- Bracket back, 11 gauge steel
- Gun saddle, 16 gauge steel, black rubber edging

Part #	D x H x L	Capacity	Weight	Price
X2WR1PWC	7¼" x 6¾" x 3"	1	3.50 lbs.	\$73.00
X2WR5PWC	7¼" x 6¾" x 12"	5	7.75 lbs.	\$188.00
X2WR6PWC	7¼" x 6¾" x 15"	6	8.75 lbs.	\$211.00
X2WR7PWC	7¼" x 6¾" x 17½"	7	10.00 lbs.	\$235.00
X2WR8PWC	7¼" x 6¾" x 20"	8	11.25 lbs.	\$256.00
X2WR9PWC	7¼" x 6¾" x 22½"	9	12.25 lbs.	\$279.00
X2WR11PWC	7¼" x 6¾" x 27½"	11	14.75 lbs.	\$360.00

Patent Pending

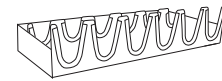

HAND GUN BRACKET WITHOUT CLIP COMPARTMENT

- Bracket back, 11 gauge steel
- Gun saddle, 16 gauge steel, black rubber edging

Part #	D x H x L	Capacity	Weight	Price
X2WR1P	7¼" x 4¼" x 3"	1	2.25 lbs.	\$68.00
X2WR5P	7¼" x 4¼" x 12"	5	4.50 lbs.	\$172.00
X2WR6P	7¼" x 4¼" x 15"	6	5.25 lbs.	\$195.00
X2WR7P	7¼" x 4¼" x 17½"	7	5.75 lbs.	\$212.00
X2WR8P	7¼" x 4¼" x 20"	8	6.50 lbs.	\$229.00
X2WR9P	7¼" x 4¼" x 22½"	9	7.25 lbs.	\$245.00
X2WR11P	7¼" x 4¼" x 27½"	11	9.75 lbs.	\$302.00

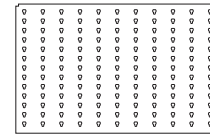

WEAPONS UNIT BACK PANEL

- Keyhole slots accept brackets and accessories
- 16 gauge steel

Part #	W x H	Weight	Price
X2WRBP10.50	30" X 10½"	8.00 lbs.	\$48.00
X2WRBP21.00	30" X 21"	12.75 lbs.	\$81.00
X2WRBP31.50	30" X 31½"	17.50 lbs.	\$143.00

WEAPONS RACK SHELF

Part #	W x H x D	Weight	Price
902WR	30" x 1" x 14"	8.25 lbs.	\$51.00



ROLLOUT DRAWER & ACCESSORY

Part #	Description	Weight	Price
608	Security Drawer	32.11 lbs.	\$411.00



Shelf above Security Drawer is an additional option.

Not designed for hanging file folders.
(28½"L x 15"D x 10¼"H)

Part #	Description	Weight	Price
489	Rollout Accessory Drawer	21.07 lbs.	\$266.00



Capacity @ 200 CD's
4 Dividers Included.
(28½"L x 15"D x 3¼"H)

Part #	Description	Weight	Price
902	Adjustable, Reversible Shelf	7 lbs.	\$47.00

(30"L x 15¼"D)
110 lbs. Capacity per shelf.



WEAPONS STORAGE BACK PANEL LAYOUT

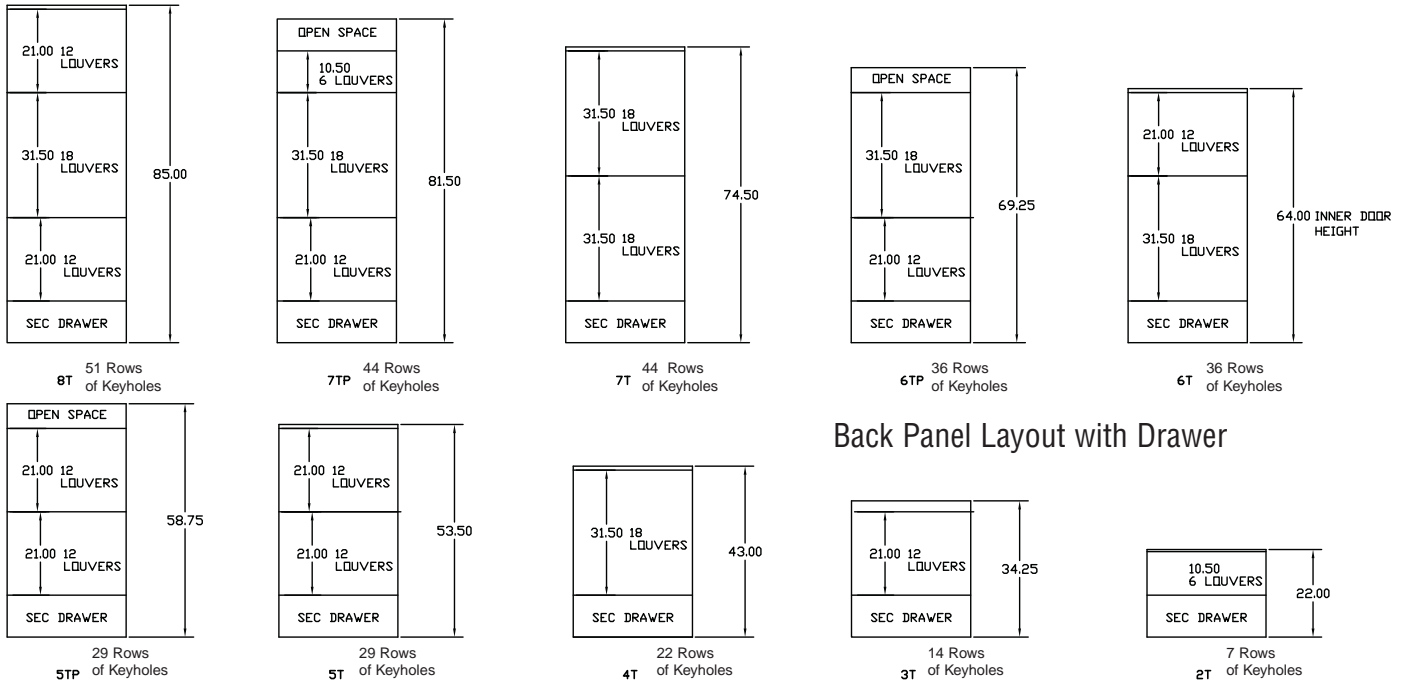

Back Panel Layout with Drawer

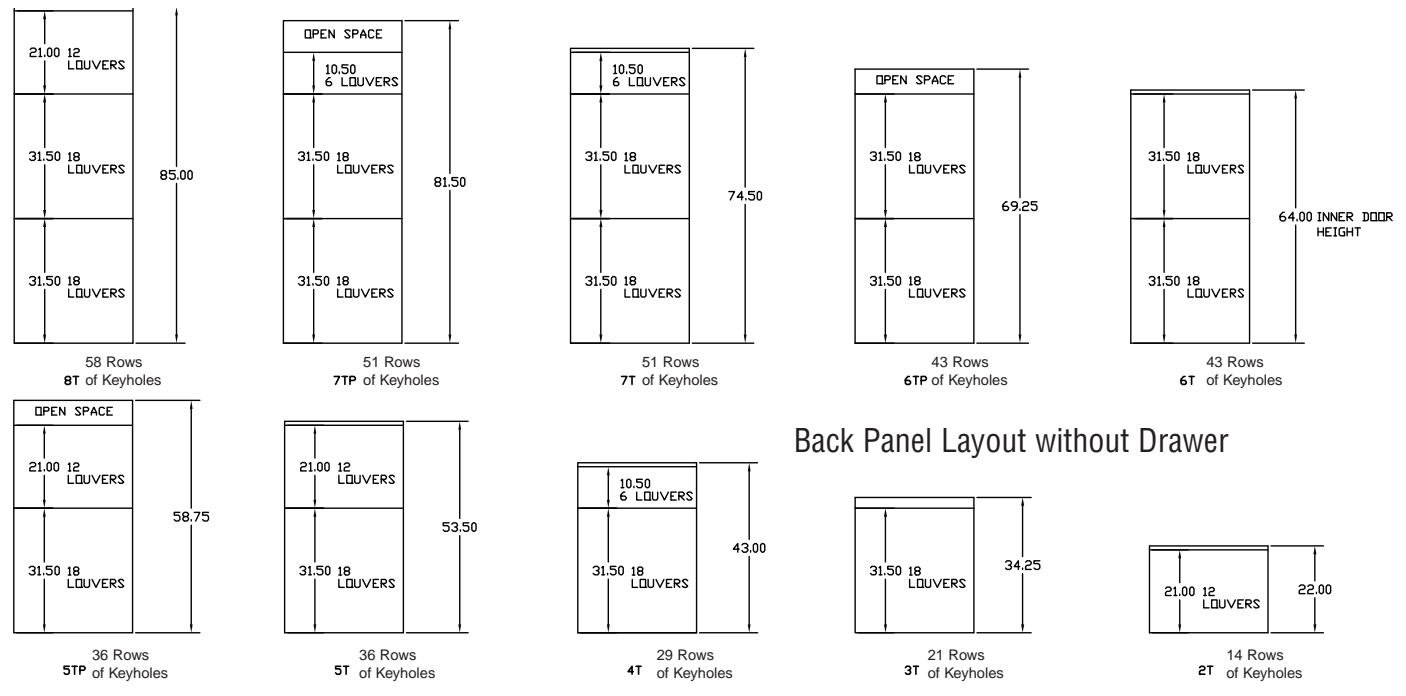

Back Panel Layout without Drawer

Horizontal Rifle Capacity:
 Back Panel Number of Keyhole Columns: 10 Columns
 Rifle Capacity: 10
 Bracket Required: 2 or 1
 Capacity of Bracket: 5 or 10

Horizontal Handgun Capacity:
 Back Panel Number of Keyhole Columns: 10 Columns
 Handgun Capacity: 11
 Bracket Required: 2 or 1
 Capacity of Bracket: 5 + 6 or 11

Vertical Clearance Requirements:	Accessory	Height	Vertical Keyholes Used
	Barrel Holder Bracket	6"	5
	Sloped Shelf	2"	3
	Optional Shelf Stop	2"	3
	Handgun Bracket	4"***	5
	Handgun Bracket with Clip Compartment	6"***	6

**It is recommended that 2" of clearance be allowed at the top of the handgun bracket for adequate room to store and remove weapons.

LEGAL/A4-SIZE ACCESSORIES

SHELVES, RACKS & ACCESSORIES MAGNETIC FOLLOWERS

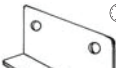
Part #	Description	Weight	Price
 041	Standard Magnetic Follower (7½"H x 7"W x ¼"Foot)	1.63 lbs.	\$27.20

Part #	Description	Weight	Price
854	4" MINI-MAG Follower (4⅜"H; 4"W; ¾"Foot)	.46 lbs.	\$17.40
855	5" MINI-MAG Follower (4⅜"H; 5"W; ¾"Foot)	.52 lbs.	\$20.65
856	6" MINI-MAG Follower (4⅜"H; 6"W; ¾"Foot)	.69 lbs.	\$21.75
857	7" MINI-MAG Follower (4⅜"H; 7⅜"W; ¾"Foot)	.78 lbs.	\$23.95

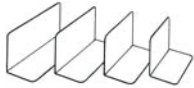

Part #	Description	Weight	Price
075	Documate Rack	4 lbs.	\$101.00





Part #	Description	Weight	Price
077	Fasthook Rack	3.73 lbs.	\$104.00

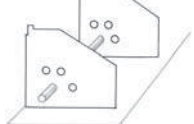

Part #	Description	Weight	Price
396	Short Stop Spacer	.5 lbs.	\$78.00



Part #	Description	Weight	Price
459P	Pkg. (5) 6½" Ht. Dividers	5.05 lbs.	\$41.00
460P	Pkg. (5) 8¼" Ht. Dividers	4.87 lbs.	\$41.00
 461P	Pkg. (5) 10" Ht. Dividers	5.85 lbs.	\$41.00
 462P	Pkg. (5) 11¼" Ht. Dividers	6.82 lbs.	\$41.00
463P	Pkg. (5) 13½" Ht. Dividers	7.80 lbs.	\$41.00
464P	Pkg. (5) 15¼" Ht. Dividers	8.78 lbs.	\$106.00
465P	Pkg. (5) 17" Ht. Dividers	9.76 lbs.	\$106.00
466P	Pkg. (5) 18¼" Ht. Dividers	10.73 lbs.	\$106.00

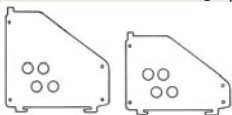



Part #	Description	Weight	Price
457P	Pkg. (5) 3" Ht. Dividers	1.94 lbs.	\$41.00
458P	Pkg. (5) 4¾" Ht. Dividers	2.20 lbs.	\$41.00

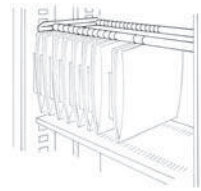

SHELVES, RACKS & ACCESSORIES

Part #	Description	Weight	Price
614	Oblique Rack	4 lbs.	\$78.00



Part #	Description	Weight	Price
 902	Adjustable, Reversible Shelf (30"L x 15¼"D) 110 lbs. Capacity per shelf.	7 lbs.	\$47.00



Part #	Description	Weight	Price
902R	Recessed, Adjustable Shelf (30"L x 13¼"D) 110 lbs. Capacity per shelf.	5.71 lbs.	\$47.00



Part #	Description	Weight	Price
902E	Legal European Fixed Filing Shelf (Special Rotor Top 249E required.)	8.38 lbs.	\$63.00



Part #	Description	Weight	Price
170	European Fixed Filing Frame	4.36 lbs.	\$93.00



Items in bold print are also available on the Times-2 XPRESS Program.

 = X·P·R·E·S·S

ROLLOUT DRAWERS & ACCESSORIES

Part #	Description	Weight	Price
481	Rollout Accessory Drawer End Support and Magnetic Follower are additional options. (28½"L x 15"D x 3¼"H)	15.17 lbs.	\$143.00



Part #	Description	Weight	Price
483	End Support Plugs into side of drawer.	.26 lbs.	\$8.20 (each)



Part #	Description	Weight	Price
156	Rollout Drawer Insert for 2 rows letter top tab (Requires #481) 2 Sections @ 12.5"	9.09 lbs.	\$238.00

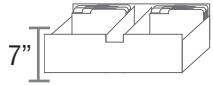

Part #	Description	Weight	Price
156P	Rollout Drawer Insert for parking tickets (Requires #481) 6 Sections @ 4.75"	9.09 lbs.	\$238.00

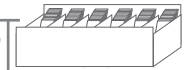

Part #	Description	Weight	Price
156F	Rollout Drawer Insert for finger print cards (Requires #481) 3 Sections @ 8.25"	9.09 lbs.	\$238.00

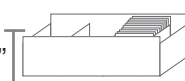

Part #	Description	Weight	Price
883	Rollout Reference Shelf Includes (1) #461P, Package of 10" Dividers.	15.53 lbs.	\$223.00



Part #	Description	Weight	Price
881	Rollout File Drawer (28.58"L x 14.92"D x 9.55"H)	13.01 lbs.	\$195.00



Part #	Description	Weight	Price
816	File Divider, 10" x 6" for use with #881.	.49 lbs.	\$4.35

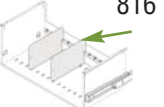

Part #	Description	Weight	Price
1996	Rollout Drawer with Hanging Folder Frame	25.11 lbs.	\$264.00



ROLLOUT DRAWERS & ACCESSORIES

Part #	Description	Weight	Price
575	Hanging Folder Frame For use with #481 Rollout Drawer.	9.94 lbs.	\$101.00

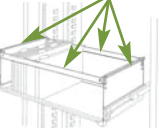

Part #	Description	Weight	Price
649P	Hanging Folder Rail Package of 2 Rails for #881, #575 & #1996	2.64 lbs.	\$41.00



Part #	Description	Weight	Price
649	Hanging Folder Rail for #575, #881 & #1996	1.32 lbs.	\$33.00 (each)



Part #	Description	Weight	Price
640	Frame End Plate for #575 & #1996	2 lbs.	\$50.00 (each)



Part #	Description	Weight	Price
992	Rollout Hanging Folder Frame	10.76 lbs.	\$169.00



Part #	Description	Weight	Price
1002	Hanging Folder Rail for use with #992	1.56 lbs.	\$58.00 (each)



Part #	Description	Weight	Price
995	Left Hand End Plate for use with #992	1.45 lbs.	\$75.00 (each)



Part #	Description	Weight	Price
996	Right Hand End Plate for use with #992	1.45 lbs.	\$75.00 (each)



Items in bold print are also available on the Times-2 XPRESS Program.



LEGAL/A4-SIZE ACCESSORIES

ROLLOUT DRAWERS & ACCESSORIES

SHELF DIVIDER SUPPORT

Used under Rollout Reference Shelf

Part #	Description	Weight	Price
313	Magnetic Shelf Divider Support	1 lbs.	\$42.00



Part #	Description	Weight	Price
481	Rollout Drawer End Support and Magnetic Follower are additional options. (28½" L x 15" D x 3¼" H)	15.17 lbs.	\$143.00



Part #	Description	Weight	Price
489	Rollout Accessory Drawer Capacity @ 200 CD's 4 Dividers Included. (28½" L x 15" D x 3¼" H)	21.07 lbs.	\$266.00



Part #	Description	Weight	Price
914	Drawer Front Slides over drawer lip to provide 3⅝" high bin front.	2.55 lbs.	\$62.00 (each)



Part #	Description	Weight	Price
916	Non-Slotted Drawer Divider Drops into slotted drawer front & back for adjustable compartmentation.	.49 lbs.	\$34.00 (each)

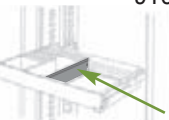

Part #	Description	Weight	Price
372	Slotted Drawer Back Clips over regular drawer back. Provides slots every ½" for use with #481.	1.38 lbs.	\$34.00 (each)

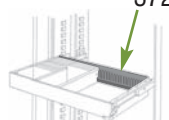

Part #	Description	Weight	Price
661	Slotted Drawer Side for use with #489.	1.38 lbs.	\$29.95 (each)

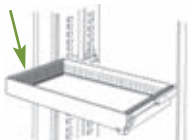

Part #	Description	Weight	Price
662	Front to Back Slotted Partition for use with #489	1.38 lbs.	\$37.00 (each)

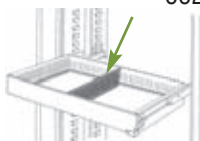

ROLLOUT DRAWERS & ACCESSORIES

Part #	Description	Weight	Price
363.03	Drawer Divider 13½" Clear Space. Divides Drawer in two.	.8 lbs.	\$28.85 (each)



Part #	Description	Weight	Price
363.04	Drawer Divider 6½" Clear Space. Divides Drawer in four.	.3 lbs.	\$22.85 (each)



Part #	Description	Weight	Price
608	Security Drawer Shelf above Security Drawer is an additional option. Not designed for hanging file folders. (28½" L x 15" D x 10¼" H)	32.11 lbs.	\$411.00



Part #	Description	Weight	Price
674RO	Tub Drawer Shelf above Tub Drawer is an additional option. Can accommodate hanging file folders. (28½" L x 15" D x 9¾" H)	26 lbs.	\$238.00



SLIDES

Part #	Description	Weight	Price
491	Suspension Slides (Pair) with Thumb Latch	4.93 lbs.	\$89.00
96610.00	Security Drawer Slides (Pair)	4.93 lbs.	\$89.00

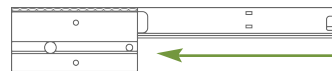

If current slides are in a tandem configuration you will need to specify our Modified Slide

96600.00MOD*	Times-2 Modified Legal Size Drawer Slide	4.93 lbs.	\$90.00
--------------	--	-----------	---------

96610.00MOD*	Times-2 Modified Legal Size Security Drawer Slide	4.93 lbs.	\$100.00
--------------	---	-----------	----------

*Please contact Design Support to make sure Modified Slides will fit on your older drawer accessory.

CASTER KIT

Part #	Description	Weight	Price
698C	Caster Kit The Times-2 Caster Kit can be added to Times-2 units from 2-Tier through 5-Tier. Kit comes with 2 brackets, 2 locking casters, 2 free spinning casters and hardware.	10 lbs.	\$388.00



Items in bold print are also available on the Times-2 XPRESS Program.

LEGAL/A4-SIZE ACCESSORIES



INTERCONNECT

Interconnect varying height Times-2 units to make the most of wasted space under low windows, hallways, and other unusual spaces. \$265.00 for each change up or down. There are endless combinations. Aurora engineering review required.



Part#	Price
X2INT	\$265.00 per change

WARDROBE KIT

Part #	Description	Weight	Price
--------	-------------	--------	-------

685WK Legal Size Wardrobe Kit for 5, 6, 7, and 8-Tier Times-2



Kit includes:

- A vertical panel with louvers on both sides
- Four half-shelves
- One coat hook with three prongs
- Vertical panel adapter

Does not include Security Drawer, Rollout Drawer or additional shelf depicted.

Part #	Description	Weight	Price
--------	-------------	--------	-------

385WCH Coat Hook .46 lbs. \$89.00

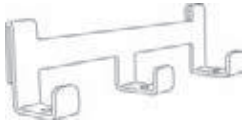

Part #	Description	Weight	Price
--------	-------------	--------	-------

685WSH Half Shelf 2.19 lbs. \$58.00



PASS-THROUGH CENTER PANEL

The Pass Through Center Panel creates a convenient large shelf area or pass through, providing a standard 2-tier opening at the top of the unit.

Part #	Description	Weight	Price
--------	-------------	--------	-------

256PT 6-Tier Pass Through 18.9 lbs. \$219.00

257PT 7-Tier Pass Through 19.9 lbs. \$213.00

258PT 8-Tier Pass Through 20.9 lbs. \$237.00

Plus Size

2563PT 6-Tier Plus Pass Through 20.9 lbs. \$225.00

2574PT 7-Tier Plus Pass Through 21.9 lbs. \$236.00

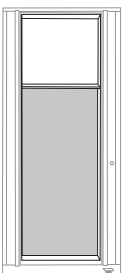

WALL CLOSING STRIPS – SINGLE DEPTH

Full-length closure between Times-2 units and wall.

Part #	Description	Weight	Price
--------	-------------	--------	-------

932 2-Tier Closing Strip (Each) 2.4 lbs. \$135.00

933 3-Tier Closing Strip (Each) 3.36 lbs. \$137.00

9341 4-Tier Closing Strip (Each) 4.04 lbs. \$139.00

935 5-Tier Closing Strip (Each) 4.87 lbs. \$142.00

936 6-Tier Closing Strip (Each) 5.69 lbs. \$144.00

937 7-Tier Closing Strip (Each) 6.52 lbs. \$146.00

938 8-Tier Closing Strip (Each) 7.34 lbs. \$149.00

Plus Size

9353 5-Tier Plus Closing Strip (Each) 5.28 lbs. \$143.00

9363 6-Tier Plus Closing Strip (Each) 6.11 lbs. \$145.00

9374 7-Tier Plus Closing Strip (Each) 7.07 lbs. \$147.00



The prefix "1" should be used in front of the part # above when using wall strips with extended canopy tops.

WALL CLOSING STRIPS – DOUBLE DEPTH

Full-length closure for back-to-back Times-2 units.

Part #	Description	Weight	Price
--------	-------------	--------	-------

952 2-Tier Closing Strip (Each) 4.23 lbs. \$175.00

953 3-Tier Closing Strip (Each) 5.93 lbs. \$176.00

9541 4-Tier Closing Strip (Each) 7.15 lbs. \$182.00

955 5-Tier Closing Strip (Each) 8.61 lbs. \$188.00

956 6-Tier Closing Strip (Each) 10.06 lbs. \$196.00

957 7-Tier Closing Strip (Each) 11.52 lbs. \$202.00

958 8-Tier Closing Strip (Each) 12.98 lbs. \$209.00

Plus Size

9553 5-Tier Plus Closing Strip (Each) 9.34 lbs. \$193.00

9563 6-Tier Plus Closing Strip (Each) 10.79 lbs. \$199.00

9574 7-Tier Plus Closing Strip (Each) 12.49 lbs. \$207.00



The prefix "1" should be used in front of the part # above when using wall strips with extended canopy tops. For extended canopy top applications consult factory

CLOSED BACK KITS

Part #	Description	Weight	Price
--------	-------------	--------	-------

1222 2-Tier Closed Back Starter 63.5 lbs. \$747.00

1223 3-Tier Closed Back Starter 71.64 lbs. \$753.00

12241 4-Tier Closed Back Starter 82.43 lbs. \$774.00

1225 5-Tier Closed Back Starter 88.64 lbs. \$801.00

1226 6-Tier Closed Back Starter 97.92 lbs. \$835.00

1227 7-Tier Closed Back Starter 107.19 lbs. \$860.00

1228 8-Tier Closed Back Starter 116.46 lbs. \$875.00

Plus Size

12253 5-Tier Plus Closed Back Starter 93 lbs. \$819.00

12263 6-Tier Plus Closed Back Starter 103.92 lbs. \$848.00

12274 7-Tier Plus Closed Back Starter 112.19 lbs. \$867.00

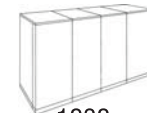

Extended Canopy Top is included.

1232 2-Tier Closed Back Add-on 47 lbs. \$562.00

1233 3-Tier Closed Back Add-on 54.77 lbs. \$567.00

12341 4-Tier Closed Back Add-on 59.89 lbs. \$576.00

1235 5-Tier Closed Back Add-on 66.11 lbs. \$593.00

1236 6-Tier Closed Back Add-on 72.29 lbs. \$601.00

1237 7-Tier Closed Back Add-on 78.47 lbs. \$608.00

1238 8-Tier Closed Back Add-on 84.66 lbs. \$616.00

Plus Size

12353 5-Tier Plus Closed Back Add-on 69 lbs. \$596.00

12363 6-Tier Plus Closed Back Add-on 75.29 lbs. \$605.00

12374 7-Tier Plus Closed Back Add-on 83.47 lbs. \$612.00

Items in bold print are also available on the Times-2 XPRESS Program.



LEGAL/A4-SIZE ACCESSORIES

LOCKING ACCESSORIES

Part #	Description	Weight	Price
424	All Times-2 Locks	.5 lbs.	\$20.65
424B	Replacement key part # for all Times-2 units with 1353 key code.	.2 lbs.	\$10.90
423M	All Times-2 locks when requested to be keyed different than 1353.	.5 lbs.	\$20.65
426	Dual locks option	.5 lbs.	\$20.65
968	Security Drawer for use with #607 #608.	.25 lbs.	\$21.25
1118	Medeco Lock, Keyed in Groups.	.5 lbs.	\$166.00
1118M	Medeco Lock, special order Keyed different with master.	.5 lbs.	\$166.00
XX424B.1	Replacement key for all Times-2 locks keyed different than 1353.	.2 lbs.	\$16.20

ELECTRONIC KEYPAD LOCK

The Vertical Electronic Keypad Lock replaces the Key Assembly on the Aurora Times-2 Unit Lock Post. Available in Black or Chrome color with an optional Key-Fob for remote access. Lock has a 10 Year Lithium Battery. Electronic Lock cannot be used on Times-2 Security Drawers.

Dimensions: 5"L x 1"W x 2"D, Weight: < 1 Lb.

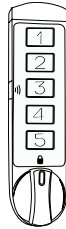

ELECTRONIC KEYPAD LOCK

TIMES-2 FOOT PEDAL UNITS PART NUMBER	TIMES-2 HAND RELEASE UNITS PART NUMBER	WT.	PRICE
422C1 Chrome	421C1 Chrome	<1 lb.	\$388.00
422B1 Black	421B1 Black	<1 lb.	\$388.00

ELECTRONIC KEYPAD LOCK W/ KEY-FOB

TIMES-2 FOOT PEDAL UNITS PART NUMBER	TIMES-2 HAND RELEASE UNITS PART NUMBER	WT.	PRICE
422C2 Chrome	421C2 Chrome	<1 lb.	\$776.00
422B2 Black	421B2 Black	<1 lb.	\$776.00

MISCELLANEOUS ACCESSORIES

Part #	Description	Weight	Price
006	Under Base Dolly For moving Legal-Size Times-2 Speed Files.	23 lbs.	\$286.00

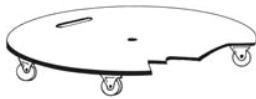

Part #	Description	Weight	Price
025I	Dual Foot Pedal Factory installed	4 lbs.	\$82.00
025K	Dual Foot Pedal Kit Field installation	4 lbs.	\$82.00

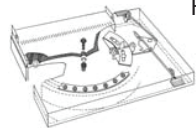

HAND RELEASE

Any Times-2 unit can be ordered with factory installed hand release instead of a foot pedal at no additional charge. Order standard part number and add "NF" suffix Example: 151SENF = 5 Tier empty starter with hand release.



Part #	Description	Weight	Price
152	Converter Bars Set of 3 for conversion from legal to two rows of letter size folders per drawer.	1 lbs.	\$81.00

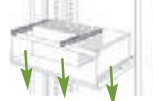

Part #	Description	Weight	Price
579	Floor Anchors for seismic and special applications. Order 4 per unit. Hardware to be determined by independent seismic engineer. Hardware not included.	1 lbs.	\$37.00 (each)



MISCELLANEOUS ACCESSORIES

Part #	Description	Weight	Price
839H	Horizontal Rangefinder Holds two 3" x 5" index cards, attaches magnetically to the post.	1 lbs.	\$47.00

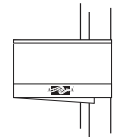

Part #	Description	Weight	Price
839V	Vertical Rangefinder Holds two 5" x 3" index cards, attaches magnetically to the post.	1 lbs.	\$47.00

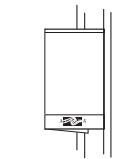

Part #	Description	Weight	Price
LABH99	Horizontal Card Holder 3" x 5" Doubleface tape and adhesive magnetic tape included. Attaches to door.	.14 lbs	\$14.80



Part #	Description	Weight	Price
LABV99	Vertical Card Holder 5" x 3" Doubleface tape and adhesive magnetic tape included. Attaches to post.	.14 lbs	\$16.70

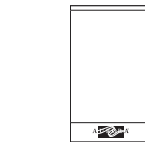

Part #	Description	Weight	Price
TUP.XX	Touch-up Paint Jars XX = Gloss-Tek Color Code	.7 oz.	\$11.45

SPECIAL ROTOR TOPS & ACCESSORIES

Part #	Description	Weight	Price
249E	European Rotor Top Fixed Filing	25.28 lbs.	\$229.00

Part #	Description	Weight	Price
542	T-Bar Rotor Top Binder channel suspended directly from top.	10 lbs.	\$172.00

Part #	Description	Weight	Price
920	T-Bar Channel for Rotor Top Holds nylon T-bars.	.5 lbs.	\$45.00



= X-P-R-E-S-S

Items in bold print are also available on the Times-2 XPRESS Program.

LEGAL/A4-SIZE COMPONENT PRICING

END PANELS

Part #	Description	Weight	Price
352	2-Tier End Panel	14 lbs.	\$167.00
353	3-Tier End Panel	19.27 lbs.	\$171.00
3541	4-Tier End Panel	23.53 lbs.	\$200.00
355	5-Tier End Panel	28.65 lbs.	\$220.00
356	6-Tier End Panel	33.77 lbs.	\$245.00
357	7-Tier End Panel	38.89 lbs.	\$272.00
358	8-Tier End Panel	44.01 lbs.	\$294.00
Plus Size			
3553	5-Tier Plus End Panel	31.25 lbs.	\$232.00
3563	6-Tier Plus End Panel	36.25 lbs.	\$260.00
3574	7-Tier Plus End Panel	41.5 lbs.	\$287.00

POSTS (VINYL AND LOCKS EXTRA)

Specify with or without lock hole

Part #	Description	Weight	Price
292	2-Tier Plain Post	5.50 lbs.	\$83.00
293	3-Tier Plain Post	6.06 lbs.	\$84.00
2941	4-Tier Plain Post	6.82 lbs.	\$90.00
295	5-Tier Plain Post	7.42 lbs.	\$92.00
296	6-Tier Plain Post	8 lbs.	\$95.00
297	7-Tier Plain Post	9 lbs.	\$107.00
298	8-Tier Plain Post	9.88 lbs.	\$115.00
Plus Size			
2953	5-Tier Plus Plain Post	7.75 lbs.	\$93.00
2963	6-Tier Plus Plain Post	8.5 lbs.	\$102.00
2974	7-Tier Plus Plain Post	9.5 lbs.	\$111.00

Specify .01 after part # if you need post with lock hole.

CENTER PANELS

Part #	Description	Weight	Price
252	2-Tier Center Panel	5 lbs.	\$145.00
253	3-Tier Center Panel	9.73 lbs.	\$149.00
2541	4-Tier Center Panel	12.14 lbs.	\$165.00
255	5-Tier Center Panel	15.02 lbs.	\$178.00
256	6-Tier Center Panel	17.9 lbs.	\$194.00
257	7-Tier Center Panel	20.77 lbs.	\$220.00
258	8-Tier Center Panel	23.65 lbs.	\$261.00
Plus Size			
2553	5-Tier Plus Center Panel	16.5 lbs.	\$188.00
2563	6-Tier Plus Center Panel	19.25 lbs.	\$207.00
2574	7-Tier Plus Center Panel	22.25 lbs.	\$242.00

DOORS

Part #	Description	Weight	Price
222	2-Tier Door	13 lbs.	\$230.00
223	3-Tier Door	19.27 lbs.	\$235.00
2241	4-Tier Door	24.75 lbs.	\$261.00
225	5-Tier Door	30.3 lbs.	\$301.00
226	6-Tier Door	35.76 lbs.	\$307.00
227	7-Tier Door	41.45 lbs.	\$356.00
228	8-Tier Door	47.14 lbs.	\$407.00
Plus Size			
2253	5-Tier Plus Door	33 lbs.	\$305.00
2263	6-Tier Plus Door	38.5 lbs.	\$332.00
2274	7-Tier Plus Door	44.25 lbs.	\$383.00

COMPLETE BASE ASSEMBLIES

Includes Rotor Bottom, Bearings, and Ball Cage

Part #	Description	Weight	Price
125	Base Starter Complete	153.43 lbs.	\$1,088.00
126	Base Add-on Complete	146.38 lbs.	\$997.00

CANOPY TOPS

Part #	Description	Weight	Price
271	Canopy Top, Starter*	18.04 lbs.	\$166.00
273	Canopy Top, Add-on*	15.84 lbs.	\$155.00
1086	Ext. Canopy Top, Starter*	18.04 lbs.	\$277.00
1088	Ext. Canopy Top, Add-on*	19.47 lbs.	\$269.00

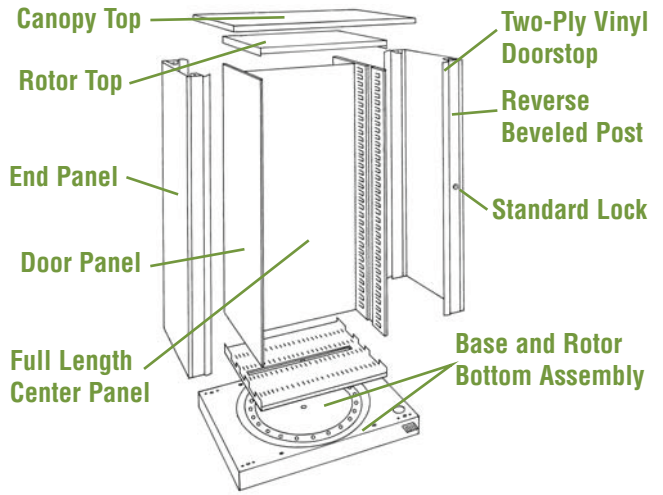

ROTOR TOP

Part #	Description	Weight	Price
249	Rotor Top	8.98 lbs.	\$134.00
249E	European Rotor Top Fixed Filing	25.28 lbs.	\$229.00



FILLER BASE (FOR CONVERSION KITS)

Part #	Description	Weight	Price
248	Filler Base	11.73 lbs.	\$256.00

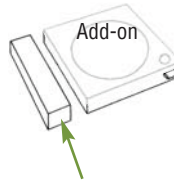

Use filler base to add to the left. Use with Add-on to create a Starter.
31" x 7-1/8" x 3-3/8"

*Extended Tops require special length wall closing strips, See page 29.

LEGAL/A4-SIZE COMPONENT PRICING

COMMON COMPONENTS

Part #	Description	Weight	Price
018	Levelers	.5 lbs.	\$1.25
020	Base Lock Nut	0.10 lbs.	\$1.25
034	5/8" Diameter Bearing (Legal 44)	.05 lbs.	\$1.25
056M	Bronze Base Washer	.25 lbs.	\$4.75
066	"U" Clamps	.25 lbs.	\$3.60
162	2-Tier Vinyl Strip	.25 lbs.	\$15.25
163	3-Tier Vinyl Strip	.38 lbs.	\$16.30
1641	4-Tier Vinyl Strip	.5 lbs.	\$17.40
165	5-Tier Vinyl Strip	.63 lbs.	\$18.50
166	6-Tier Vinyl Strip	.75 lbs.	\$22.30
167	7-Tier Vinyl Strip	.88 lbs.	\$24.50
168	8-Tier Vinyl Strip	1 lbs.	\$26.95
Plus Size			
1653	5-Tier Plus Vinyl Strip	.75 lbs.	\$21.25
1663	6-Tier Plus Vinyl Strip	1.05 lbs.	\$23.40
1674	7-Tier Plus Vinyl Strip	1.08 lbs.	\$24.50
316	Wire Folder Guard	.25 lbs.	\$2.20
424	Lock Cylinders, Cams & Keys	0.5 lbs.	\$20.65
428	Vertical Lock Rod**	0.5 lbs.	\$16.30
440	Floor Protectors	0.5 lbs.	\$8.20
513	Lock Access Hole Cover	0.10 lbs.	\$1.10
527	Bolts (5/16" - 18")	0.5 lbs.	\$1.10
529	Tinnerman Nuts	0.10 lbs.	\$1.10
531	Plug Buttons - 3/8"	0.10 lbs.	\$1.10
532P	Aluminum Drive Rivets For Pre-1997 Units. (Bag of 38)	1.91 lbs.	\$16.30
968	Security Drawer Lock	.25 lbs.	\$21.25
1000	Tie Strap	1.02 lbs.	\$29.25
TUP.XX	Touch-up Paint (Jar)	0.7 lbs.	\$11.45

XX= Variable color Code

** Not for 2-Tier Units.

MAGNETIC DRY ERASE OVERLAYS

Part #	Description	Width	Length	Weight	Price
269DE.X	2-Tier	31"	24 1/4"	3.37 lbs.	\$259.00
369DE.X	3-Tier	31"	36 1/2"	3.37 lbs.	\$287.00
469DE.X	4-Tier	31"	45 1/4"	4.18 lbs.	\$329.00
569DE.X	5-Tier	31"	55 3/4"	5.16 lbs.	\$366.00
669DE.X	6-Tier	31"	66 1/4"	6.13 lbs.	\$416.00
769DE.X	7-Tier	31"	76 3/4"	7.11 lbs.	\$453.00
869DE.X	8-Tier	31"	87 1/4"	8.08 lbs.	\$509.00
Plus Size					
5693DE.X	5-Tier Plus	31"	60 7/8"	5.5 lbs.	\$391.00
6693DE.X	6-Tier Plus	31"	71 3/8"	6.6 lbs.	\$435.00
7694DE.X	7-Tier Plus	31"	83 3/4"	7.5 lbs.	\$481.00
005DE	Board Eraser	2"	5"	.12 lbs.	\$29.35

X = G (Greystone), W (White),
or S (Sandstone).

Pricing per panel.



MAGNETIC FABRIC OVERLAYS

Part #	Description	Width	Length	Weight	Price
269FO	2-Tier	31"	24 1/4"	3.37 lbs.	\$259.00
369FO	3-Tier	31"	36 1/2"	3.37 lbs.	\$287.00
469FO	4-Tier	31"	45 1/4"	4.18 lbs.	\$329.00
569FO	5-Tier	31"	55 3/4"	5.16 lbs.	\$366.00
669FO	6-Tier	31"	66 1/4"	6.13 lbs.	\$416.00
769FO	7-Tier	31"	76 3/4"	7.11 lbs.	\$453.00
869FO	8-Tier	31"	87 1/4"	8.08 lbs.	\$509.00
Plus Size					
5693FO	5-Tier Plus	31"	60 7/8"	5.5 lbs.	\$391.00
6693FO	6-Tier Plus	31"	71 3/8"	6.6 lbs.	\$435.00
7694FO	7-Tier Plus	31"	83 3/4"	7.5 lbs.	\$494.00

See fabric sell sheet for fabric selections.

Pricing per panel.

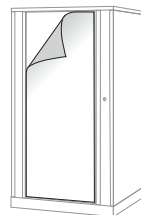

ADD-ON TO STARTER UNIT CONVERSION KITS

A kit consists of: 2-End Panels, 2-Posts, Starter Canopy Top, 1-Filler Base. All hardware is included with kit.

The color should be specified when ordering.

Part #	No. of Tiers	Weight	Price
22CK	2	49.5 lbs.	\$583.00
23CK	3	66.25 lbs.	\$590.00
241CK	4	90.76 lbs.	\$667.00
⊙25CK	5	124.85 lbs.	\$737.00
⊙26CK	6	137.88 lbs.	\$798.00
⊙27CK	7	150.91 lbs.	\$935.00
⊙28CK	8	163.94 lbs.	\$1040.00
Plus Size			
253CK	5 Plus	131.5 lbs.	\$766.00
263CK	6 Plus	144.5 lbs.	\$866.00
274CK	7 Plus	157.5 lbs.	\$986.00



⊙ = X·P·R·E·S·S

LEGAL-SIZE QUIK-PANEL SLATWALL



Add a Quik-Panel to any new Times-2 unit or retrofit it in the field.
 Pricing below is per panel. Each panel comes with a hardware kit for mounting.
 Quik-Panel comes in full height panels to match the ten Times-2 unit heights from
 2-Tier to 8-Tier including Plus Sizes, or order panels in 2', 3' and 4' heights.

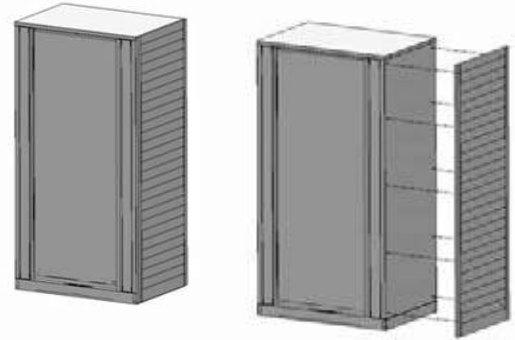

Quik-Panel is available in :

- Wood-Tek - Standard Woods & Stains
- Wood-Tek - Custom Stains on Cherry, Maple or Oak
- Wood-Tek - Custom Stains on Mahogany
- WilsonArt Laminate
- Aluminum or Black Vinyl slat inserts

WOOD-TEK QUIK-PANEL WITH ALUMINUM INSERTS

Part #	Description	W	D	H	Stain	Weight	Price
221SW-41AP	2-Tier Panel	31"	x 3/4"	x 29 1/2"	Red Cherry	21 lbs.	\$1,600.00
221SW-42AP	2-Tier Panel	31"	x 3/4"	x 29 1/2"	Honey Cherry	21 lbs.	\$1,600.00
221SW-43AP	2-Tier Panel	31"	x 3/4"	x 29 1/2"	Chestnut Cherry	21 lbs.	\$1,600.00
221SW-61AP	2-Tier Panel	31"	x 3/4"	x 29 1/2"	Natural Maple	21 lbs.	\$1,600.00
221SW-SPL1AP	2-Tier Panel	31"	x 3/4"	x 29 1/2"	Custom Stain on Cherry, Maple or Oak	21 lbs.	\$1,755.00
221SW-SPL2AP	2-Tier Panel	31"	x 3/4"	x 29 1/2"	Custom Stain on Mahogany	21 lbs.	\$2,020.00
221SW-SPLAP	2-Tier Panel	31"	x 3/4"	x 29 1/2"	Custom Stains on other Wood Species	21 lbs.	**
231SW-41AP	3-Tier Panel	31"	x 3/4"	x 41 5/8"	Red Cherry	30 lbs.	\$1,610.00
231SW-42AP	3-Tier Panel	31"	x 3/4"	x 41 5/8"	Honey Cherry	30 lbs.	\$1,610.00
231SW-43AP	3-Tier Panel	31"	x 3/4"	x 41 5/8"	Chestnut Cherry	30 lbs.	\$1,610.00
231SW-61AP	3-Tier Panel	31"	x 3/4"	x 41 5/8"	Natural Maple	30 lbs.	\$1,610.00
231SW-SPL1AP	3-Tier Panel	31"	x 3/4"	x 41 5/8"	Custom Stain on Cherry, Maple or Oak	30 lbs.	\$1,770.00
231SW-SPL2AP	3-Tier Panel	31"	x 3/4"	x 41 5/8"	Custom Stain on Mahogany	30 lbs.	\$2,035.00
231SW-SPLAP	3-Tier Panel	31"	x 3/4"	x 41 5/8"	Custom Stains on other Wood Species	30 lbs.	**
241SW-41AP	4-Tier Panel	31"	x 3/4"	x 50 3/8"	Red Cherry	36 lbs.	\$2,480.00
241SW-42AP	4-Tier Panel	31"	x 3/4"	x 50 3/8"	Honey Cherry	36 lbs.	\$2,480.00
241SW-43AP	4-Tier Panel	31"	x 3/4"	x 50 3/8"	Chestnut Cherry	36 lbs.	\$2,480.00
241SW-61AP	4-Tier Panel	31"	x 3/4"	x 50 3/8"	Natural Maple	36 lbs.	\$2,480.00
241SW-SPL1AP	4-Tier Panel	31"	x 3/4"	x 50 3/8"	Custom Stain on Cherry, Maple or Oak	36 lbs.	\$2,725.00
241SW-SPL2AP	4-Tier Panel	31"	x 3/4"	x 50 3/8"	Custom Stain on Mahogany	36 lbs.	\$3,140.00
241SW-SPLAP	4-Tier Panel	31"	x 3/4"	x 50 3/8"	Custom Stains on other Wood Species	36 lbs.	**
251SW-41AP	5-Tier Panel	31"	x 3/4"	x 60 7/8"	Red Cherry	43 lbs.	\$2,495.00
251SW-42AP	5-Tier Panel	31"	x 3/4"	x 60 7/8"	Honey Cherry	43 lbs.	\$2,495.00
251SW-43AP	5-Tier Panel	31"	x 3/4"	x 60 7/8"	Chestnut Cherry	43 lbs.	\$2,495.00
251SW-61AP	5-Tier Panel	31"	x 3/4"	x 60 7/8"	Natural Maple	43 lbs.	\$2,495.00
251SW-SPL1AP	5-Tier Panel	31"	x 3/4"	x 60 7/8"	Custom Stain on Cherry, Maple or Oak	43 lbs.	\$2,740.00
251SW-SPL2AP	5-Tier Panel	31"	x 3/4"	x 60 7/8"	Custom Stain on Mahogany	43 lbs.	\$3,155.00
251SW-SPLAP	5-Tier Panel	31"	x 3/4"	x 60 7/8"	Custom Stains on other Wood Species	43 lbs.	**
2513SW-41AP	5-Tier Plus Panel	31"	x 3/4"	x 66 1/8"	Red Cherry	47 lbs.	\$2,510.00
2513SW-42AP	5-Tier Plus Panel	31"	x 3/4"	x 66 1/8"	Honey Cherry	47 lbs.	\$2,510.00
2513SW-43AP	5-Tier Plus Panel	31"	x 3/4"	x 66 1/8"	Chestnut Cherry	47 lbs.	\$2,510.00
2513SW-61AP	5-Tier Plus Panel	31"	x 3/4"	x 66 1/8"	Natural Maple	47 lbs.	\$2,510.00
2513SW-SPL1AP	5-Tier Plus Panel	31"	x 3/4"	x 66 1/8"	Custom Stain on Cherry, Maple or Oak	47 lbs.	\$2,755.00
2513SW-SPL2AP	5-Tier Plus Panel	31"	x 3/4"	x 66 1/8"	Custom Stain on Mahogany	47 lbs.	\$3,175.00
2513SW-SPLAP	5-Tier Plus Panel	31"	x 3/4"	x 66 1/8"	Custom Stains on other Wood Species	47 lbs.	**

** Call Customer Service for a quote.

LEGAL-SIZE QUIK-PANEL SLATWALL

WOOD-TEK QUIK-PANEL WITH ALUMINUM INSERTS

Part #	Description	W	D	H	Stain	Weight	Price
261SW-41AP	6-Tier Panel	31"	3/4"	71 3/8"	Red Cherry	51 lbs.	\$2,525.00
261SW-42AP	6-Tier Panel	31"	3/4"	71 3/8"	Honey Cherry	51 lbs.	\$2,525.00
261SW-43AP	6-Tier Panel	31"	3/4"	71 3/8"	Chestnut Cherry	51 lbs.	\$2,525.00
261SW-61AP	6-Tier Panel	31"	3/4"	71 3/8"	Natural Maple	51 lbs.	\$2,525.00
261SW-SPL1AP	6-Tier Panel	31"	3/4"	71 3/8"	Custom Stain on Cherry, Maple or Oak	51 lbs.	\$2,775.00
261SW-SPL2AP	6-Tier Panel	31"	3/4"	71 3/8"	Custom Stain on Mahogany	51 lbs.	\$3,195.00
261SW-SPLAP	6-Tier Panel	31"	3/4"	71 3/8"	Custom Stains on other Wood Species	51 lbs.	**
2613SW-41AP	6-Tier Plus Panel	31"	3/4"	76 5/8"	Red Cherry	54 lbs.	\$2,540.00
2613SW-42AP	6-Tier Plus Panel	31"	3/4"	76 5/8"	Honey Cherry	54 lbs.	\$2,540.00
2613SW-43AP	6-Tier Plus Panel	31"	3/4"	76 5/8"	Chestnut Cherry	54 lbs.	\$2,540.00
2613SW-61AP	6-Tier Plus Panel	31"	3/4"	76 5/8"	Natural Maple	54 lbs.	\$2,540.00
2613SW-SPL1AP	6-Tier Plus Panel	31"	3/4"	76 5/8"	Custom Stain on Cherry, Maple or Oak	54 lbs.	\$2,790.00
2613SW-SPL2AP	6-Tier Plus Panel	31"	3/4"	76 5/8"	Custom Stain on Mahogany	54 lbs.	\$3,210.00
2613SW-SPLAP	6-Tier Plus Panel	31"	3/4"	76 5/8"	Custom Stains on other Wood Species	54 lbs.	**
271SW-41AP	7-Tier Panel	31"	3/4"	82"	Red Cherry	58 lbs.	\$2,555.00
271SW-42AP	7-Tier Panel	31"	3/4"	82"	Honey Cherry	58 lbs.	\$2,555.00
271SW-43AP	7-Tier Panel	31"	3/4"	82"	Chestnut Cherry	58 lbs.	\$2,555.00
271SW-61AP	7-Tier Panel	31"	3/4"	82"	Natural Maple	58 lbs.	\$2,555.00
271SW-SPL1AP	7-Tier Panel	31"	3/4"	82"	Custom Stain on Cherry, Maple or Oak	58 lbs.	\$2,810.00
271SW-SPL2AP	7-Tier Panel	31"	3/4"	82"	Custom Stain on Mahogany	58 lbs.	\$3,230.00
271SW-SPLAP	7-Tier Panel	31"	3/4"	82"	Custom Stains on other Wood Species	58 lbs.	**
2714SW-41AP	7-Tier Plus Panel	31"	3/4"	89"	Red Cherry	63 lbs.	\$2,580.00
2714SW-42AP	7-Tier Plus Panel	31"	3/4"	89"	Honey Cherry	63 lbs.	\$2,580.00
2714SW-43AP	7-Tier Plus Panel	31"	3/4"	89"	Chestnut Cherry	63 lbs.	\$2,580.00
2714SW-61AP	7-Tier Plus Panel	31"	3/4"	89"	Natural Maple	63 lbs.	\$2,580.00
2714SW-SPL1AP	7-Tier Plus Panel	31"	3/4"	89"	Custom Stain on Cherry, Maple or Oak	63 lbs.	\$3,035.00
2714SW-SPL2AP	7-Tier Plus Panel	31"	3/4"	89"	Custom Stain on Mahogany	63 lbs.	\$3,245.00
2714SW-SPLAP	7-Tier Plus Panel	31"	3/4"	89"	Custom Stains on other Wood Species	63 lbs.	**
281SW-41AP	8-Tier Panel	31"	3/4"	92 1/2"	Red Cherry	65 lbs.	\$2,595.00
281SW-42AP	8-Tier Panel	31"	3/4"	92 1/2"	Honey Cherry	65 lbs.	\$2,595.00
281SW-43AP	8-Tier Panel	31"	3/4"	92 1/2"	Chestnut Cherry	65 lbs.	\$2,595.00
281SW-61AP	8-Tier Panel	31"	3/4"	92 1/2"	Natural Maple	65 lbs.	\$2,595.00
281SW-SPL1AP	8-Tier Panel	31"	3/4"	92 1/2"	Custom Stain on Cherry, Maple or Oak	65 lbs.	\$3,050.00
281SW-SPL2AP	8-Tier Panel	31"	3/4"	92 1/2"	Custom Stain on Mahogany	65 lbs.	\$3,260.00
281SW-SPLAP	8-Tier Panel	31"	3/4"	92 1/2"	Custom Stains on other Wood Species	65 lbs.	**

** Call Customer Service for a quote.

LEGAL-SIZE QUIK-PANEL SLATWALL

WOOD-TEK QUIK-PANEL WITH BLACK VINYL INSERTS

Part #	Description	W	D	H	Stain	Weight	Price
221SW-41BP	2-Tier Panel	31"	3/4"	x 29 1/2"	Red Cherry	21 lbs.	\$1,565.00
221SW-42BP	2-Tier Panel	31"	3/4"	x 29 1/2"	Honey Cherry	21 lbs.	\$1,565.00
221SW-43BP	2-Tier Panel	31"	3/4"	x 29 1/2"	Chestnut Cherry	21 lbs.	\$1,565.00
221SW-61BP	2-Tier Panel	31"	3/4"	x 29 1/2"	Natural Maple	21 lbs.	\$1,565.00
221SW-SPL1BP	2-Tier Panel	31"	3/4"	x 29 1/2"	Custom Stain on Cherry, Maple or Oak	21 lbs.	\$1,720.00
221SW-SPL2BP	2-Tier Panel	31"	3/4"	x 29 1/2"	Custom Stain on Mahogany	21 lbs.	\$1,985.00
221SW-SPLBP	2-Tier Panel	31"	3/4"	x 29 1/2"	Custom Stains on other Wood Species	21 lbs.	**
231SW-41BP	3-Tier Panel	31"	3/4"	x 41 5/8"	Red Cherry	30 lbs.	\$1,575.00
231SW-42BP	3-Tier Panel	31"	3/4"	x 41 5/8"	Honey Cherry	30 lbs.	\$1,575.00
231SW-43BP	3-Tier Panel	31"	3/4"	x 41 5/8"	Chestnut Cherry	30 lbs.	\$1,575.00
231SW-61BP	3-Tier Panel	31"	3/4"	x 41 5/8"	Natural Maple	30 lbs.	\$1,575.00
231SW-SPL1BP	3-Tier Panel	31"	3/4"	x 41 5/8"	Custom Stain on Cherry, Maple or Oak	30 lbs.	\$1,735.00
231SW-SPL2BP	3-Tier Panel	31"	3/4"	x 41 5/8"	Custom Stain on Mahogany	30 lbs.	\$2,000.00
231SW-SPLBP	3-Tier Panel	31"	3/4"	x 41 5/8"	Custom Stains on other Wood Species	30 lbs.	**
241SW-41BP	4-Tier Panel	31"	3/4"	x 50 3/8"	Red Cherry	36 lbs.	\$2,445.00
241SW-42BP	4-Tier Panel	31"	3/4"	x 50 3/8"	Honey Cherry	36 lbs.	\$2,445.00
241SW-43BP	4-Tier Panel	31"	3/4"	x 50 3/8"	Chestnut Cherry	36 lbs.	\$2,445.00
241SW-61BP	4-Tier Panel	31"	3/4"	x 50 3/8"	Natural Maple	36 lbs.	\$2,445.00
241SW-SPL1BP	4-Tier Panel	31"	3/4"	x 50 3/8"	Custom Stain on Cherry, Maple or Oak	36 lbs.	\$2,690.00
241SW-SPL2BP	4-Tier Panel	31"	3/4"	x 50 3/8"	Custom Stain on Mahogany	36 lbs.	\$3,105.00
241SW-SPLBP	4-Tier Panel	31"	3/4"	x 50 3/8"	Custom Stains on other Wood Species	36 lbs.	**
251SW-41BP	5-Tier Panel	31"	3/4"	x 60 7/8"	Red Cherry	43 lbs.	\$2,460.00
251SW-42BP	5-Tier Panel	31"	3/4"	x 60 7/8"	Honey Cherry	43 lbs.	\$2,460.00
251SW-43BP	5-Tier Panel	31"	3/4"	x 60 7/8"	Chestnut Cherry	43 lbs.	\$2,460.00
251SW-61BP	5-Tier Panel	31"	3/4"	x 60 7/8"	Natural Maple	43 lbs.	\$2,460.00
251SW-SPL1BP	5-Tier Panel	31"	3/4"	x 60 7/8"	Custom Stain on Cherry, Maple or Oak	43 lbs.	\$2,705.00
251SW-SPL2BP	5-Tier Panel	31"	3/4"	x 60 7/8"	Custom Stain on Mahogany	43 lbs.	\$3,120.00
251SW-SPLBP	5-Tier Panel	31"	3/4"	x 60 7/8"	Custom Stains on other Wood Species	43 lbs.	**
2513SW-41BP	5-Tier Plus Panel	31"	3/4"	x 66 1/8"	Red Cherry	47 lbs.	\$2,475.00
2513SW-42BP	5-Tier Plus Panel	31"	3/4"	x 66 1/8"	Honey Cherry	47 lbs.	\$2,475.00
2513SW-43BP	5-Tier Plus Panel	31"	3/4"	x 66 1/8"	Chestnut Cherry	47 lbs.	\$2,475.00
2513SW-61BP	5-Tier Plus Panel	31"	3/4"	x 66 1/8"	Natural Maple	47 lbs.	\$2,475.00
2513SW-SPL1BP	5-Tier Plus Panel	31"	3/4"	x 66 1/8"	Custom Stain on Cherry, Maple or Oak	47 lbs.	\$2,720.00
2513SW-SPL2BP	5-Tier Plus Panel	31"	3/4"	x 66 1/8"	Custom Stain on Mahogany	47 lbs.	\$3,140.00
2513SW-SPLBP	5-Tier Plus Panel	31"	3/4"	x 66 1/8"	Custom Stains on other Wood Species	47 lbs.	**

** Call Customer Service for a quote.

WOOD-TEK QUIK-PANEL WITH BLACK VINYL INSERTS

Part #	Description	W	D	H	Stain	Weight	Price
261SW-41BP	6-Tier Panel	31"	3/4"	71 3/8"	Red Cherry	51 lbs.	\$2,490.00
261SW-42BP	6-Tier Panel	31"	3/4"	71 3/8"	Honey Cherry	51 lbs.	\$2,490.00
261SW-43BP	6-Tier Panel	31"	3/4"	71 3/8"	Chestnut Cherry	51 lbs.	\$2,490.00
261SW-61BP	6-Tier Panel	31"	3/4"	71 3/8"	Natural Maple	51 lbs.	\$2,490.00
261SW-SPL1BP	6-Tier Panel	31"	3/4"	71 3/8"	Custom Stain on Cherry, Maple or Oak	51 lbs.	\$2,740.00
261SW-SPL2BP	6-Tier Panel	31"	3/4"	71 3/8"	Custom Stain on Mahogany	51 lbs.	\$3,160.00
261SW-SPLBP	6-Tier Panel	31"	3/4"	71 3/8"	Custom Stains on other Wood Species	51 lbs.	**
2613SW-41BP	6-Tier Plus Panel	31"	3/4"	76 5/8"	Red Cherry	54 lbs.	\$2,505.00
2613SW-42BP	6-Tier Plus Panel	31"	3/4"	76 5/8"	Honey Cherry	54 lbs.	\$2,505.00
2613SW-43BP	6-Tier Plus Panel	31"	3/4"	76 5/8"	Chestnut Cherry	54 lbs.	\$2,505.00
2613SW-61BP	6-Tier Plus Panel	31"	3/4"	76 5/8"	Natural Maple	54 lbs.	\$2,505.00
2613SW-SPL1BP	6-Tier Plus Panel	31"	3/4"	76 5/8"	Custom Stain on Cherry, Maple or Oak	54 lbs.	\$2,755.00
2613SW-SPL2BP	6-Tier Plus Panel	31"	3/4"	76 5/8"	Custom Stain on Mahogany	54 lbs.	\$3,175.00
2613SW-SPLBP	6-Tier Plus Panel	31"	3/4"	76 5/8"	Custom Stains on other Wood Species	54 lbs.	**
271SW-41BP	7-Tier Panel	31"	3/4"	82"	Red Cherry	58 lbs.	\$2,520.00
271SW-42BP	7-Tier Panel	31"	3/4"	82"	Honey Cherry	58 lbs.	\$2,520.00
271SW-43BP	7-Tier Panel	31"	3/4"	82"	Chestnut Cherry	58 lbs.	\$2,520.00
271SW-61BP	7-Tier Panel	31"	3/4"	82"	Natural Maple	58 lbs.	\$2,520.00
271SW-SPL1BP	7-Tier Panel	31"	3/4"	82"	Custom Stain on Cherry, Maple or Oak	58 lbs.	\$2,775.00
271SW-SPL2BP	7-Tier Panel	31"	3/4"	82"	Custom Stain on Mahogany	58 lbs.	\$3,195.00
271SW-SPLBP	7-Tier Panel	31"	3/4"	82"	Custom Stains on other Wood Species	58 lbs.	**
2714SW-41BP	7-Tier Plus Panel	31"	3/4"	89"	Red Cherry	63 lbs.	\$2,545.00
2714SW-42BP	7-Tier Plus Panel	31"	3/4"	89"	Honey Cherry	63 lbs.	\$2,545.00
2714SW-43BP	7-Tier Plus Panel	31"	3/4"	89"	Chestnut Cherry	63 lbs.	\$2,545.00
2714SW-61BP	7-Tier Plus Panel	31"	3/4"	89"	Natural Maple	63 lbs.	\$2,545.00
2714SW-SPL1BP	7-Tier Plus Panel	31"	3/4"	89"	Custom Stain on Cherry, Maple or Oak	63 lbs.	\$3,000.00
2714SW-SPL2BP	7-Tier Plus Panel	31"	3/4"	89"	Custom Stain on Mahogany	63 lbs.	\$3,210.00
2714SW-SPLBP	7-Tier Plus Panel	31"	3/4"	89"	Custom Stains on other Wood Species	63 lbs.	**
281SW-41BP	8-Tier Panel	31"	3/4"	92 1/2"	Red Cherry	65 lbs.	\$2,560.00
281SW-42BP	8-Tier Panel	31"	3/4"	92 1/2"	Honey Cherry	65 lbs.	\$2,560.00
281SW-43BP	8-Tier Panel	31"	3/4"	92 1/2"	Chestnut Cherry	65 lbs.	\$2,560.00
281SW-61BP	8-Tier Panel	31"	3/4"	92 1/2"	Natural Maple	65 lbs.	\$2,560.00
281SW-SPL1BP	8-Tier Panel	31"	3/4"	92 1/2"	Custom Stain on Cherry, Maple or Oak	65 lbs.	\$3,015.00
281SW-SPL2BP	8-Tier Panel	31"	3/4"	92 1/2"	Custom Stain on Mahogany	65 lbs.	\$3,225.00
281SW-SPLBP	8-Tier Panel	31"	3/4"	92 1/2"	Custom Stains on other Wood Species	65 lbs.	**

** Call Customer Service for a quote.

LEGAL-SIZE QUIK-PANEL SLATWALL

WOOD-TEK QUIK-PANEL WITH ALUMINUM INSERTS

Part #	Description	W	D	H	Stain	Weight	Price
24LGLSW-41AP	2' Panel	31" x	3/4" x	24"	Red Cherry	17 lbs.	\$1,485.00
24LGLSW-42AP	2' Panel	31" x	3/4" x	24"	Honey Cherry	17 lbs.	\$1,485.00
24LGLSW-43AP	2' Panel	31" x	3/4" x	24"	Chestnut Cherry	17 lbs.	\$1,485.00
24LGLSW-61AP	2' Panel	31" x	3/4" x	24"	Natural Maple	17 lbs.	\$1,485.00
24LGLSW-SPL1AP	2' Panel	31" x	3/4" x	24"	Custom Stain on Cherry, Maple or Oak	17 lbs.	\$1,635.00
24LGLSW-SPL2AP	2' Panel	31" x	3/4" x	24"	Custom Stain on Mahogany	17 lbs.	\$1,885.00
24LGLSW-SPLAP	2' Panel	31" x	3/4" x	24"	Custom Stains on other Wood Species	17 lbs.	**
36LGLSW-41AP	3' Panel	31" x	3/4" x	36"	Red Cherry	26 lbs.	\$1,600.00
36LGLSW-42AP	3' Panel	31" x	3/4" x	36"	Honey Cherry	26 lbs.	\$1,600.00
36LGLSW-43AP	3' Panel	31" x	3/4" x	36"	Chestnut Cherry	26 lbs.	\$1,600.00
36LGLSW-61AP	3' Panel	31" x	3/4" x	36"	Natural Maple	26 lbs.	\$1,600.00
36LGLSW-SPL1AP	3' Panel	31" x	3/4" x	36"	Custom Stain on Cherry, Maple or Oak	26 lbs.	\$1,755.00
36LGLSW-SPL2AP	3' Panel	31" x	3/4" x	36"	Custom Stain on Mahogany	26 lbs.	\$2,020.00
36LGLSW-SPLAP	3' Panel	31" x	3/4" x	36"	Custom Stains on other Wood Species	26 lbs.	**
48LGLSW-41AP	4' Panel	31" x	3/4" x	48"	Red Cherry	34 lbs.	\$1,620.00
48LGLSW-42AP	4' Panel	31" x	3/4" x	48"	Honey Cherry	34 lbs.	\$1,620.00
48LGLSW-43AP	4' Panel	31" x	3/4" x	48"	Chestnut Cherry	34 lbs.	\$1,620.00
48LGLSW-61AP	4' Panel	31" x	3/4" x	48"	Natural Maple	34 lbs.	\$1,620.00
48LGLSW-SPL1AP	4' Panel	31" x	3/4" x	48"	Custom Stain on Cherry, Maple or Oak	34 lbs.	\$1,775.00
48LGLSW-SPL2AP	4' Panel	31" x	3/4" x	48"	Custom Stain on Mahogany	34 lbs.	\$2,040.00
48LGLSW-SPLAP	4' Panel	31" x	3/4" x	48"	Custom Stains on other Wood Species	34 lbs.	**

WOOD-TEK QUIK-PANEL WITH BLACK VINYL INSERTS

Part #	Description	W	D	H	Stain	Weight	Price
24LGLSW-41BP	2' Panel	31" x	3/4" x	24"	Red Cherry	17 lbs.	\$1,450.00
24LGLSW-42BP	2' Panel	31" x	3/4" x	24"	Honey Cherry	17 lbs.	\$1,450.00
24LGLSW-43BP	2' Panel	31" x	3/4" x	24"	Chestnut Cherry	17 lbs.	\$1,450.00
24LGLSW-61BP	2' Panel	31" x	3/4" x	24"	Natural Maple	17 lbs.	\$1,450.00
24LGLSW-SPL1BP	2' Panel	31" x	3/4" x	24"	Custom Stain on Cherry, Maple or Oak	17 lbs.	\$1,600.00
24LGLSW-SPL2BP	2' Panel	31" x	3/4" x	24"	Custom Stain on Mahogany	17 lbs.	\$1,850.00
24LGLSW-SPLBP	2' Panel	31" x	3/4" x	24"	Custom Stains on other Wood Species	17 lbs.	**
36LGLSW-41BP	3' Panel	31" x	3/4" x	36"	Red Cherry	26 lbs.	\$1,565.00
36LGLSW-42BP	3' Panel	31" x	3/4" x	36"	Honey Cherry	26 lbs.	\$1,565.00
36LGLSW-43BP	3' Panel	31" x	3/4" x	36"	Chestnut Cherry	26 lbs.	\$1,565.00
36LGLSW-61BP	3' Panel	31" x	3/4" x	36"	Natural Maple	26 lbs.	\$1,565.00
36LGLSW-SPL1BP	3' Panel	31" x	3/4" x	36"	Custom Stain on Cherry, Maple or Oak	26 lbs.	\$1,720.00
36LGLSW-SPL2BP	3' Panel	31" x	3/4" x	36"	Custom Stain on Mahogany	26 lbs.	\$1,985.00
36LGLSW-SPLBP	3' Panel	31" x	3/4" x	36"	Custom Stains on other Wood Species	26 lbs.	**
48LGLSW-41BP	4' Panel	31" x	3/4" x	48"	Red Cherry	34 lbs.	\$1,585.00
48LGLSW-42BP	4' Panel	31" x	3/4" x	48"	Honey Cherry	34 lbs.	\$1,585.00
48LGLSW-43BP	4' Panel	31" x	3/4" x	48"	Chestnut Cherry	34 lbs.	\$1,585.00
48LGLSW-61BP	4' Panel	31" x	3/4" x	48"	Natural Maple	34 lbs.	\$1,585.00
48LGLSW-SPL1BP	4' Panel	31" x	3/4" x	48"	Custom Stain on Cherry, Maple or Oak	34 lbs.	\$1,740.00
48LGLSW-SPL2BP	4' Panel	31" x	3/4" x	48"	Custom Stain on Mahogany	34 lbs.	\$2,005.00
48LGLSW-SPLBP	4' Panel	31" x	3/4" x	48"	Custom Stains on other Wood Species	34 lbs.	**

LEGAL-SIZE QUIK-PANEL SLATWALL

LAMINATE QUIK-PANEL WITH ALUMINUM INSERTS

Part #	Description	W	D	H	Laminate	Weight	Price
221SW-AP	2-Tier Panel	31"	x 3/4"	x 29 1/2"	Standard Wilsonart Laminates	21 lbs.	\$1,330.00
231SW-AP	3-Tier Panel	31"	x 3/4"	x 41 5/8"	Standard Wilsonart Laminates	30 lbs.	\$1,346.00
241SW-AP	4-Tier Panel	31"	x 3/4"	x 50 3/8"	Standard Wilsonart Laminates	36 lbs.	\$2,029.00
251SW-AP	5-Tier Panel	31"	x 3/4"	x 60 7/8"	Standard Wilsonart Laminates	43 lbs.	\$2,117.00
2513SW-AP	5-Tier Plus Panel	31"	x 3/4"	x 66 1/8"	Standard Wilsonart Laminates	47 lbs.	\$2,127.00
261SW-AP	6-Tier Panel	31"	x 3/4"	x 71 3/8"	Standard Wilsonart Laminates	51 lbs.	\$2,142.00
2613SW-AP	6-Tier Plus Panel	31"	x 3/4"	x 76 5/8"	Standard Wilsonart Laminates	54 lbs.	\$2,148.00
271SW-AP	7-Tier Panel	31"	x 3/4"	x 82"	Standard Wilsonart Laminates	58 lbs.	\$2,153.00
2714SW-AP	7-Tier Plus Panel	31"	x 3/4"	x 89"	Standard Wilsonart Laminates	63 lbs.	\$2,163.00
281SW-AP	8-Tier Panel	31"	x 3/4"	x 92 1/2"	Standard Wilsonart Laminates	65 lbs.	\$2,168.00

LAMINATE QUIK-PANEL WITH BLACK VINYL INSERTS

Part #	Description	W	D	H	Laminate	Weight	Price
221SW-BP	2-Tier Panel	31"	x 3/4"	x 29 1/2"	Standard Wilsonart Laminates	21 lbs.	\$1,294.00
231SW-BP	3-Tier Panel	31"	x 3/4"	x 41 5/8"	Standard Wilsonart Laminates	30 lbs.	\$1,310.00
241SW-BP	4-Tier Panel	31"	x 3/4"	x 50 3/8"	Standard Wilsonart Laminates	36 lbs.	\$1,992.00
251SW-BP	5-Tier Panel	31"	x 3/4"	x 60 7/8"	Standard Wilsonart Laminates	43 lbs.	\$2,080.00
2513SW-BP	5-Tier Plus Panel	31"	x 3/4"	x 66 1/8"	Standard Wilsonart Laminates	47 lbs.	\$2,091.00
261SW-BP	6-Tier Panel	31"	x 3/4"	x 71 3/8"	Standard Wilsonart Laminates	51 lbs.	\$2,106.00
2613SW-BP	6-Tier Plus Panel	31"	x 3/4"	x 76 5/8"	Standard Wilsonart Laminates	54 lbs.	\$2,111.00
271SW-BP	7-Tier Panel	31"	x 3/4"	x 82"	Standard Wilsonart Laminates	58 lbs.	\$2,117.00
2714SW-BP	7-Tier Plus Panel	31"	x 3/4"	x 89"	Standard Wilsonart Laminates	63 lbs.	\$2,127.00
281SW-BP	8-Tier Panel	31"	x 3/4"	x 92 1/2"	Standard Wilsonart Laminates	65 lbs.	\$2,132.00

LAMINATE QUIK-PANEL WITH ALUMINUM INSERTS

Part #	Description	W	D	H	Laminate	Weight	Price
24LGLSW-AP	2' Panel	31"	x 3/4"	x 24"	Standard Wilsonart Laminates	17 lbs.	\$1,247.00
36LGLSW-AP	3' Panel	31"	x 3/4"	x 36"	Standard Wilsonart Laminates	26 lbs.	\$1,294.00
48LGLSW-AP	4' Panel	31"	x 3/4"	x 48"	Standard Wilsonart Laminates	34 lbs.	\$1,340.00

LAMINATE QUIK-PANEL WITH BLACK VINYL INSERTS

Part #	Description	W	D	H	Laminate	Weight	Price
24LGLSW-BP	2' Panel	31"	x 3/4"	x 24"	Standard Wilsonart Laminates	17 lbs.	\$1,211.00
36LGLSW-BP	3' Panel	31"	x 3/4"	x 36"	Standard Wilsonart Laminates	26 lbs.	\$1,258.50
48LGLSW-BP	4' Panel	31"	x 3/4"	x 48"	Standard Wilsonart Laminates	34 lbs.	\$1,304.00

Prices reflect Standard Wilsonart Laminates.

Wilsonart Premium and High Definition Laminates are also available as a custom order. Call Customer Service for a quote.



TABLE #1

Louvers inside the Times-2 Speed Files are spaced every 1.75". The shelf takes up some of that space, so the "clear" openings as marked below are somewhat smaller. The number of louvers and useable space needed for each size opening are:

Louver	Useable Space	Application
1 Louver =	1.75"	Reference Shelf
2 Louvers =	3"	Flat forms
3 Louvers =	4.75"	Microfilm/fiche/trays
4 Louvers =	6.5"	Accessory Drawer for CD/DVD & Small Media
5 Louvers =	8.25"	Reduced documents, e.g. Parking Tickets, Voter Registration, Fingerprint Cards
6 Louvers =	10"	Standard file folder/hanging folders/security drawer
7 Louvers =	11.75"	3-ring binders/tape seals/ expanded hanging folders
8 Louvers =	13.5"	Printouts/oblique folders/ computer printouts
9 Louvers =	15.25"	Ledger binders
10 Louvers =	17"	Jumbo sized documents

Rollout Drawers with Hanging Folder Frames:

This product usually requires 6 louvers clearance but the top most drawer always requires 7 louvers to clear tabs on top tabbed folders.

TABLE #2

Each height Times-2 has a defined number of useable louvers:

- 2-Tier (letter or legal) 13 louvers
- 3-Tier (letter or legal) 20 louvers
- 4-Tier (letter or legal) 25 louvers
- 5-Tier (letter or legal) 31 louvers
- 6-Tier (letter or legal) 37 louvers
- 7-Tier (letter or legal) 43 louvers
- 8-Tier (letter or legal) 49 louvers

Times-2 Plus Sizes (Letter or Legal)	Total Louvers	Total Height
5-Tier Adds 3 Extra Louvers	34	66.125"
6-Tier Adds 3 Extra Louvers	40	76.625"
7-Tier Adds 4 Extra Louvers	47	89"

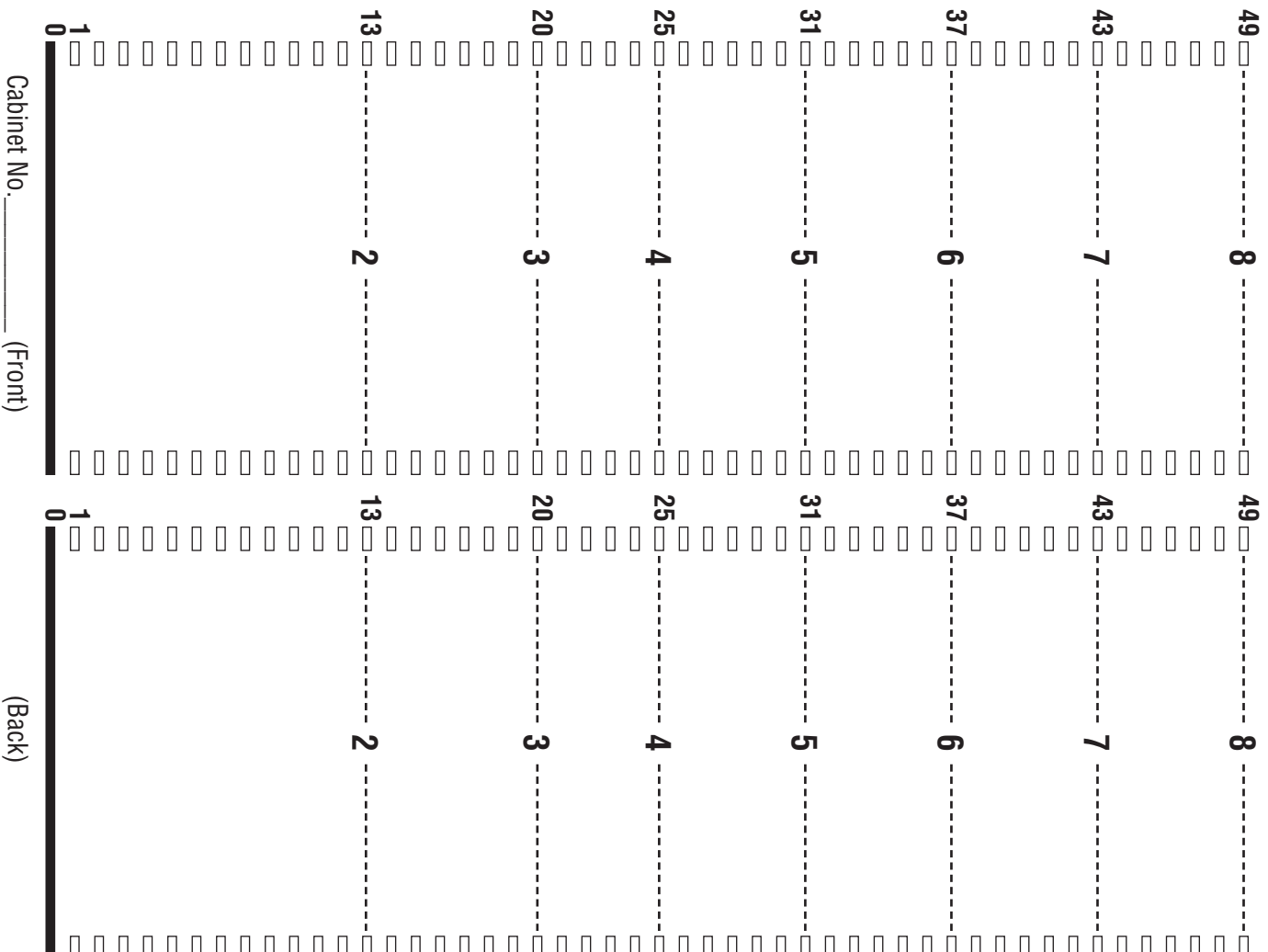



Rifle Brackets



Handgun Brackets



Countertops



Accessory Drawer



Converter Bars



Security Drawer



Tub Drawer



Hanging Folder Frame



Filing Drawer



Aurora Storage Products, Inc.
600 South Lake Street • Aurora, IL 60506
Ph: 630-897-6951 • Fax: 630-897-6994
Toll Free: 800-277-1699

www.aurorastorage.com

All Rights Reserved Copyright © 2017
T2P 1-17



For more information go to:
<http://www.aurorastorage.com/>

For design assistance:
designsupport@aurorastorage.com