



PDF Updated
March 26, 2015

FRÍANT

SYSTEM 2

PRICE BOOK
effective October 2013



Table of Contents

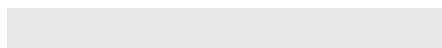

Terms and Conditions	2-3
Standard Fabrics	4
Standard Finishes	5

SYSTEM 2

PANELS	6-20
Hard Surface Panel:	6-8
Non-Electrical	6
Electrical	8
Hard Surface Partial-Glazed Panel:	10-11
Non-Electrical	10
Electrical	11
Fabric-Covered Panel:	12-15
Non-Electrical	12
Electrical	14
Acoustical Panel:	16-19
Non-Electrical	16
Electrical	18
Partial-Glazed Panel:	20-21
Non-Electrical	20
Electrical	21
Door Panel	22
PANEL HARDWARE	23-26
Draw Rod	23
Connectors	26-24
ELECTRICAL DISTRIBUTION	27-29

SYSTEM WORKSURFACES	30-56
Rectangular Worksurface	30
90° Notched and Curved Corner Worksurface	31
Square Edge Half Circle Worksurface	32
Square Edge D-Shaped Worksurface	33
90° Extended Notched Corner Worksurface	34-36
90° Extended Curved Corner Worksurface	37-39
90° Extended Notched Corner Peninsula Worksurface	40-43
Extended Curved Corner Peninsula Worksurface	44-47
Extended Curved Corner P-Shape Peninsula Worksurface	48
Elipse End Peninsula Worksurface	50
Rectangular Asymmetrical Worksurface	51
120° Rectangular Worksurface	52
120° Corner Worksurface, 90° Ends	53
120° Corner Worksurface, 120° Ends	54
135° Corner Worksurface	55
135° Double Corner Worksurface	56
TRANSACTION WORKSURFACES	57-59
Transaction Surface Rectangular	57
Corner Transaction Surface	68
Flat Bracket	59

SYSTEM 1 & 2

WORKSURFACE SUPPORT	60-67
Supports	60
Components / Storage	62
Frameless Glass	65
Tackboards	66
Markerboards	67
STORAGE	68-70
Pedestals	68
Lateral Files	70
ACCESSORIES	71-72
Accessories	71
Keyed-Alike Information	72

SYSTEM 1

PANELS	74-83
Hard-Surface Panel	74
Fabric Covered Panel	76
Acoustical Panel	78
Glazed Panel	80
PANEL HARDWARE	81-83

Terms and Conditions

PRICES

All Prices are F.O.B. factory. We reserve the right to change prices without prior notice.

ORDERING

Purchase Orders should be sent to Friant & Associates, LLC at orders@friant.com, or faxed to (510) 535-6895. If your specifications were created with CAP, GIZA, or Project Matrix please send the worksheet (SP4) with your Purchase Order.

TERMS

Net 30 days from date of invoice. Invoices are delinquent if not paid 30 days from date of invoice. In the event timely payment is not made, interest will be charged at the rate of 1.5% per month on delinquent accounts. Buyers will also be liable for normal collection costs and attorney's fee. 50% deposit is required with every order, unless prior arrangements have been made.

ORDERS

Orders are only accepted by issuance of our formal acknowledgment, and are subject to the terms set forth herein and on our order acknowledgment. It is the responsibility of the buyer to review our acknowledgment for its accuracy, and to notify Friant within 48 hours from the date of the acknowledgment of any discrepancies.

LEAD TIMES

Lead times are subject to availability.

SHIPPING

Friant generally palletizes, boxes and/or shrink-wraps its products. If buyer requests additional packaging or special shipping, then it is responsible for any extra costs that result. Buyer obtains title to products and assumes the risk of loss for them upon shipment from Friant's plant.

CLAIMS

We are not responsible for damage suffered in transit. Merchandise should be inspected for possible freight damage upon delivery. The consignee should file for damage or shortages with the carrier within 5 days of delivery. You are also protected for "concealed damage" if you file claim with the carrier within 5 days of delivery. Buyer must make all claims against Friant for defects, errors or shortages in writing within 10 days after delivery. Failure to make such a claim shall constitute full acceptance.

RETURNS

No merchandise may be returned without our written consent and shipping instructions. Unauthorized returns will not be accepted and will be returned freight collect.

PARTIAL SHIPMENTS

We will make every attempt to ship orders complete and on schedule. However, we reserve the right to make partial shipments, as merchandise is ready. Invoices covering these shipments are to be paid as they become due.

ORDER CHANGE — CANCELLATIONS

Our order confirmation is final and binding. Any order change or cancellation is subject to our ability to conform. Such requests are to be made in writing to our office.

SHIPMENT AND PREPAID FREIGHT

Unless otherwise instructed, we reserve the option to ship by what is, in our opinion, the best possible way. Upon request, we will prepay and add freight for accounts with established credit.

DELIVERY

We are not liable for delay or failure of delivery due to strikes and/or differences with workmen, war, riot, fire, compliance with government regulations, acts of nature, failure or delays of sources of supply, or any other causes beyond our control.

STORAGE

If buyer cannot accept delivery when merchandise is ready, we reserve the right to transfer goods to storage. Costs of transfer and storage will be charged to the buyer's account, and we will deem such transfer as constituting shipment for all purposes, including invoicing, as of the date the transfer is made.

Terms and Conditions

CONSTRUCTION – SPECIFICATIONS

All items are produced to price list specifications unless otherwise advised. All dimensions shown are approximate. Manufacturer reserves the right to make modifications and/or improvements without prior notice.

FABRIC APPLICATION

Standard fabric application for panels 67" and below is horizontal application. Panels taller than 67" are only available in vertical application. When ordering panels 67" and below to match a panel taller than 67", specify vertical application.

Friant & Associates is not responsible for charges associated with replacement of products due to incorrect specifications.

CUSTOMER'S OWN MATERIAL

Yardage requirement is based on 66" wide plain covering material, and must be increased if less than 66" wide. Special instructions for handling material (pattern, directional fabric, right side of reversible fabric, etc.) must be submitted in writing before fabric is delivered. In the absence of special instructions, we reserve the right to use our own judgment. We reserve the right to reject any covering, which in our opinion, is unsuitable for our upholstery purposes. However, in no instance shall we be held responsible for unsatisfactory results due to use of covering unsuitable for our upholstery methods.

We will not be responsible for errors caused by buyers not supplying us with sample cuttings attached to their order giving full identification of covering material, (name of supplier, covering name, number and color) for identification purposes and advising us of model number and quantity to which each cover is to be applied.

Customer's own material that is shipped freight collect will be refused. A service charge will be applied for the return of unusable C.O.M. Contact factory.

RIGHTS AND WARRANTIES – LIMITED LIFETIME WARRANTY

This warranty is given to the initial purchaser and is valid from the date of purchase, for as long as the initial purchaser owns the product. This warranty covers defects in material and craftsmanship found during normal usage of the product during the warranty period. If the product is defective, and if written notice of the defect is given to Friant & Associates within the applicable warranty period, Friant & Associates, at its option, will either repair or replace the defective product with a comparable component or product. This warranty applies to all products except as noted below.

High wear parts, such as wood veneer, fabrics, and other covering material/finishes, foam, glides, etc. are warranted for one (1) year. This warranty does not apply to damage caused by a carrier, alteration to the product not expressly authorized by Friant & Associates, nor to product considered to be of a consumable nature such as bulbs, light ballasts, etc. It also does not apply to "Customer's Own Material" (i.e. material specified by the customer that is not a standard Friant & Associates offering) used in the manufacture of Friant & Associates products.

Friant & Associates does not warrant the matching of colors, grain or texture, except to within commercially acceptable standards.

A product will not be considered defective, and Friant & Associates will not be obligated to replace it, if it is not installed in a proper manner (i.e. product not leveled, not secured properly, etc.).

Except as noted above, Friant & Associates makes no express or implied warranties to any product, and in particular makes no warranty of fitness for any particular use. At Friant & Associates' option, product repair and replacement is the customer's exclusive remedy for any and all product defects.

Friant & Associates shall not be liable for consequential, economic, or incidental damages arising from any product defect.

CALIFORNIA PROP 65 WARNING

Products in this catalog may contain a chemical known to the state of California to cause cancer, or birth defects or other reproductive harm.

Standard Fabrics

PASSAGE		TERRAIN		SLIDE	
PF601-1	Gull	PF701-1	Cloud	PF101-1	Caramel
PF601-2	Grove	PF701-2	Dusk	PF101-2	Slate
PF601-3	Wing	PF701-3	Wave	PF101-3	Pewter
PF601-4	Quartz	PF701-4	Earth	PF101-4	Verde
PF601-5	Leaf			PF101-5	Twilight
PF601-6	Brook			PF101-6	Vintage
PF601-7	Trail			PF101-7	Java
PF601-8	Amber			PF101-8	Latte
				PF101-9	Sterling
				PF101-10	Crema
				PF101-11	Breeze
				PF101-12	Stem

NOTE: Fabric direction as per Friant's fabric card only.

Standard fabric application for panels 67" and below is horizontal application. 85"H panels are only available in vertical application. When ordering panels 67" and below to match an 85"H panel, specify vertical application.

All textiles listed are 66" wide.

Additional fabric cards can be ordered directly from Burch Fabrics and Guilford of Maine.

Order fabric cards online at www.friant.com/samples.

SKY		SILKY		STICKS	
PF301-1	Terra	PF401-1	Natural	PF501-1	Smoke
PF301-2	Birch	PF401-2	Parids	PF501-2	Almond
PF301-3	Moss	PF401-3	Overcast	PF501-3	Sage
		PF401-4	Field	PF501-4	Straw
		PF401-5	Graphite		

Colors may vary slightly between dye lots.

Please consult your Friant sales consultant for:

- Panels taller than 66" high
- Other colors not listed above
- C.O.M. fabric

Standard Finishes

For other worksurface finish colors, please consult your Friant sales consultant.

NOTE: System 2 is MAS Green Certified. For more information on LEED or environmental information about our products, contact the factory at spec@friant.com or visit our website at www.friant.com/environment.

WORKSURFACE FINISHES

M1	Light Maple
M2	Light Cherry
M3	Medium Cherry
M4	Mahogany
M5	Light Mahogany
M6	Light Gray
M7	White
M8	Gray Specks

EDGE FINISHES (3MM PVC)

E1	Light Maple
E2	Light Cherry
E3	Medium Cherry
E4	Mahogany
E5	Light Mahogany
E6	Light Gray
E7	White
E11	MT Medium Tone
E12	DT Dark Tone

PAINT TRIM

DT	Dark Tone
MT	Medium Tone
LG	Light Gray

END PANEL

DT	Dark Tone
MT	Medium Tone
LG	Light Gray

HARDSURFACE FINISHES

Below are the standard Wilsonart laminates offered for hardsurface panels.

7909-60	Fusion Maple
7054-60	Wild Cherry
7924K-70	Biltmore Cherry
7040K-60	Figured Mahogany
7039K-78	Windsor Mahogany
D327-60	Pepperdust
1572-60	Antique White
4621-60	White Nebula
1573-60	Frosty White
7933K-07	Cafelle

PANEL GLAZING

TR	Clear
FR	Frosted (XLT option)

Hard-Surface Panel | Non-Electrical

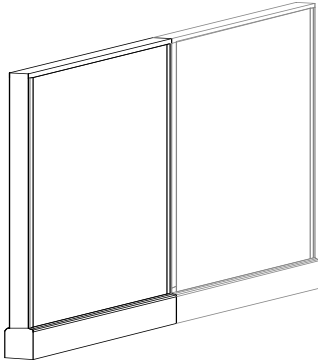

DESCRIPTION

Structural panel with laminate surfaces, painted top caps and trim, leveling glides, and cable management side covers.

NOTES

- Order connectors and finished ends separately
- Add an additional 2 weeks to the standard lead time for laminate panels

SPECIFICATION OPTIONS

product #: see charts below
trim and top cap finish: LG Light Gray, MT Medium Tone, DT Dark Tone
base finish: MT Medium Tone, DT Dark Tone, LG Light Gray
laminate finish (side 1): see page 5 (standard Wilsonart laminates)
laminate finish (side 2, if applicable): see page 5 (standard Wilsonart laminates)

ORDER EXAMPLE

product #: F2HSPA.3212N
trim and top cap finish: LG
base finish: DT
laminate finish (side 1): 7909-60 Fusion Maple
laminate finish (side 2): 7054-60 Wild Cherry

32" HIGH

PART #	HEIGHT	WIDTH	DEPTH	WT. (LBS)	PRICE
F2HSPA. 3212N	32"	12"	3.5"	18	\$315
F2HSPA. 3218N	32"	18"	3.5"	20	\$315
F2HSPA. 3224N	32"	24"	3.5"	21	\$369
F2HSPA. 3230N	32"	30"	3.5"	24	\$445
F2HSPA. 3236N	32"	36"	3.5"	27	\$521
F2HSPA. 3242N	32"	42"	3.5"	30	\$570
F2HSPA. 3248N	32"	48"	3.5"	34	\$591
F2HSPA. 3260N	32"	60"	3.5"	40	\$712

39" HIGH

PART #	HEIGHT	WIDTH	DEPTH	WT. (LBS)	PRICE
F2HSPA. 3912N	39"	12"	3.5"	22	\$298
F2HSPA. 3918N	39"	18"	3.5"	24	\$426
F2HSPA. 3924N	39"	24"	3.5"	26	\$504
F2HSPA. 3930N	39"	30"	3.5"	27	\$612
F2HSPA. 3936N	39"	36"	3.5"	31	\$714
F2HSPA. 3942N	39"	42"	3.5"	36	\$783
F2HSPA. 3948N	39"	48"	3.5"	39	\$807
F2HSPA. 3960N	39"	60"	3.5"	46	\$982

47" HIGH

PART #	HEIGHT	WIDTH	DEPTH	WT. (LBS)	PRICE
F2HSPA. 4712N	47"	12"	3.5"	25	\$320
F2HSPA. 4718N	47"	18"	3.5"	26	\$452
F2HSPA. 4724N	47"	24"	3.5"	29	\$538
F2HSPA. 4730N	47"	30"	3.5"	33	\$649
F2HSPA. 4736N	47"	36"	3.5"	38	\$754
F2HSPA. 4742N	47"	42"	3.5"	41	\$799
F2HSPA. 4748N	47"	48"	3.5"	47	\$828
F2HSPA. 4760N	47"	60"	3.5"	53	\$995

53" HIGH

PART #	HEIGHT	WIDTH	DEPTH	WT. (LBS)	PRICE
F2HSPA.5312N	53"	12"	3.5"	26	\$328
F2HSPA.5318N	53"	18"	3.5"	30	\$464
F2HSPA.5324N	53"	24"	3.5"	32	\$550
F2HSPA.5330N	53"	30"	3.5"	38	\$662
F2HSPA.5336N	53"	36"	3.5"	41	\$774
F2HSPA.5342N	53"	42"	3.5"	44	\$844
F2HSPA.5348N	53"	48"	3.5"	51	\$870
F2HSPA.5360N	53"	60"	3.5"	57	\$1,060

62" HIGH

PART #	HEIGHT	WIDTH	DEPTH	WT. (LBS)	PRICE
F2HSPA.6212N	62"	12"	3.5"	28	\$386
F2HSPA.6218N	62"	18"	3.5"	32	\$550
F2HSPA.6224N	62"	24"	3.5"	36	\$651
F2HSPA.6230N	62"	30"	3.5"	42	\$757
F2HSPA.6236N	62"	36"	3.5"	47	\$913
F2HSPA.6242N	62"	42"	3.5"	51	\$999
F2HSPA.6248N	62"	48"	3.5"	58	\$1,037
F2HSPA.6260N	62"	60"	3.5"	66	\$1,267

67" HIGH

PART #	HEIGHT	WIDTH	DEPTH	WT. (LBS)	PRICE
F2HSPA.6712N	67"	12"	3.5"	30	\$441
F2HSPA.6718N	67"	18"	3.5"	34	\$636
F2HSPA.6724N	67"	24"	3.5"	40	\$744
F2HSPA.6730N	67"	30"	3.5"	46	\$872
F2HSPA.6736N	67"	36"	3.5"	51	\$1,018
F2HSPA.6742N	67"	42"	3.5"	57	\$1,132
F2HSPA.6748N	67"	48"	3.5"	64	\$1,162
F2HSPA.6760N	67"	60"	3.5"	74	\$1,459

85" HIGH

PART #	HEIGHT	WIDTH	DEPTH	WT. (LBS)	PRICE
F2HSPA.8512N	85"	12"	3.5"	25	\$549
F2HSPA.8518N	85"	18"	3.5"	26	\$798
F2HSPA.8524N	85"	24"	3.5"	29	\$946
F2HSPA.8530N	85"	30"	3.5"	33	\$1,148
F2HSPA.8536N	85"	36"	3.5"	38	\$1,341
F2HSPA.8542N	85"	42"	3.5"	41	\$1,481
F2HSPA.8548N	85"	48"	3.5"	47	\$1,528
F2HSPA.8560N	85"	60"	3.5"	86	\$1,866

Hard-Surface Panel | Electrical

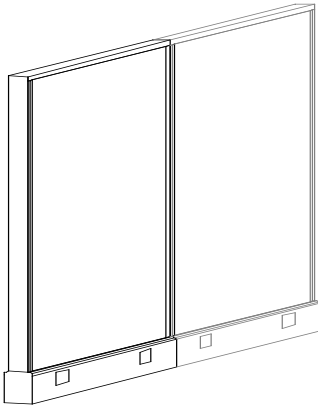

DESCRIPTION

Structural panel with laminate surfaces, painted top caps and trim, leveling glides, 4-circuit power installed in cable management raceway covers.

NOTES

- 12" and 18" wide panels have no receptacle. 24" wide panels have one receptacle per side.
- 30"- 60" wide panels have two receptacle locations per side.
- 12" and 18" wide panels have a panel pass-through power jumper.
- Order receptacles, connectors, connector power kit and finished ends separately.
- Add an additional 2 weeks to the standard lead time for laminate panels

SPECIFICATION OPTIONS

product #: see charts below
trim and top cap finish: LG Light Gray, MT Medium Tone, DT Dark Tone
base finish: MT Medium Tone, DT Dark Tone, LG Light Gray
laminate finish (side 1): see page 5 (standard Wilsonart laminates)
laminate finish (side 2, if applicable): see page 5 (standard Wilsonart laminates)

ORDER EXAMPLE

product #: F2HSPA.3212E
trim and top cap finish: LG
base finish: DT
laminate finish (side 1): 7909-60 Fusion Maple
laminate finish (side 2): 7054-60 Wild Cherry

32" HIGH

PART #	HEIGHT	WIDTH	DEPTH	WT. (LBS)	PRICE
F2HSPA.3212E	32"	12"	3.5"	19	\$428
F2HSPA.3218E	32"	18"	3.5"	21	\$428
F2HSPA.3224E	32"	24"	3.5"	22	\$483
F2HSPA.3230E	32"	30"	3.5"	25	\$578
F2HSPA.3236E	32"	36"	3.5"	29	\$669
F2HSPA.3242E	32"	42"	3.5"	32	\$736
F2HSPA.3248E	32"	48"	3.5"	37	\$775
F2HSPA.3260E	32"	60"	3.5"	45	\$931

39" HIGH

PART #	HEIGHT	WIDTH	DEPTH	WT. (LBS)	PRICE
F2HSPA.3912E	39"	12"	3.5"	23	\$412
F2HSPA.3918E	39"	18"	3.5"	25	\$540
F2HSPA.3924E	39"	24"	3.5"	27	\$618
F2HSPA.3930E	39"	30"	3.5"	29	\$745
F2HSPA.3936E	39"	36"	3.5"	33	\$861
F2HSPA.3942E	39"	42"	3.5"	38	\$949
F2HSPA.3948E	39"	48"	3.5"	42	\$991
F2HSPA.3960E	39"	60"	3.5"	51	\$1,202

47" HIGH

PART #	HEIGHT	WIDTH	DEPTH	WT. (LBS)	PRICE
F2HSPA.4712E	47"	12"	3.5"	25	\$434
F2HSPA.4718E	47"	18"	3.5"	27	\$566
F2HSPA.4724E	47"	24"	3.5"	30	\$652
F2HSPA.4730E	47"	30"	3.5"	35	\$783
F2HSPA.4736E	47"	36"	3.5"	40	\$902
F2HSPA.4742E	47"	42"	3.5"	43	\$965
F2HSPA.4748E	47"	48"	3.5"	50	\$1,012
F2HSPA.4760E	47"	60"	3.5"	58	\$1,215

53" HIGH

PART #	HEIGHT	WIDTH	DEPTH	WT. (LBS)	PRICE
F2HSPA.5312E	53"	12"	3.5"	27	\$442
F2HSPA.5318E	53"	18"	3.5"	31	\$578
F2HSPA.5324E	53"	24"	3.5"	33	\$665
F2HSPA.5330E	53"	30"	3.5"	40	\$795
F2HSPA.5336E	53"	36"	3.5"	43	\$921
F2HSPA.5342E	53"	42"	3.5"	47	\$1,010
F2HSPA.5348E	53"	48"	3.5"	53	\$1,053
F2HSPA.5360E	53"	60"	3.5"	62	\$1,280

62" HIGH

PART #	HEIGHT	WIDTH	DEPTH	WT. (LBS)	PRICE
F2HSPA.6212E	62"	12"	3.5"	29	\$500
F2HSPA.6218E	62"	18"	3.5"	33	\$663
F2HSPA.6224E	62"	24"	3.5"	36	\$765
F2HSPA.6230E	62"	30"	3.5"	44	\$891
F2HSPA.6236E	62"	36"	3.5"	49	\$1,060
F2HSPA.6242E	62"	42"	3.5"	54	\$1,165
F2HSPA.6248E	62"	48"	3.5"	61	\$1,221
F2HSPA.6260E	62"	60"	3.5"	71	\$1,487

67" HIGH

PART #	HEIGHT	WIDTH	DEPTH	WT. (LBS)	PRICE
F2HSPA.6712E	67"	12"	3.5"	31	\$555
F2HSPA.6718E	67"	18"	3.5"	35	\$749
F2HSPA.6724E	67"	24"	3.5"	41	\$859
F2HSPA.6730E	67"	30"	3.5"	47	\$1,006
F2HSPA.6736E	67"	36"	3.5"	53	\$1,165
F2HSPA.6742E	67"	42"	3.5"	59	\$1,298
F2HSPA.6748E	67"	48"	3.5"	67	\$1,346
F2HSPA.6760E	67"	60"	3.5"	79	\$1,679

85" HIGH

PART #	HEIGHT	WIDTH	DEPTH	WT. (LBS)	PRICE
F2HSPA.8512E	85"	12"	3.5"	39	\$662
F2HSPA.8518E	85"	18"	3.5"	42	\$911
F2HSPA.8524E	85"	24"	3.5"	50	\$1,061
F2HSPA.8530E	85"	30"	3.5"	59	\$1,282
F2HSPA.8536E	85"	36"	3.5"	67	\$1,488
F2HSPA.8542E	85"	42"	3.5"	75	\$1,647
F2HSPA.8548E	85"	48"	3.5"	84	\$1,711
F2HSPA.8560E	85"	60"	3.5"	91	\$2,086

Hard-Surface Partial Glazed Panel | Non-Electrical

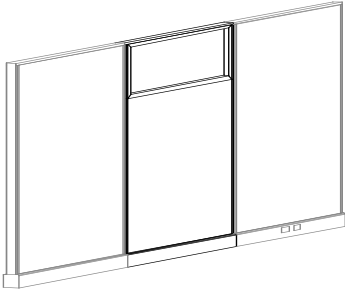

DESCRIPTION

Structural panel with laminate lower surfaces and 14" high tempered glass top section, painted top caps and trim, leveling glides, and cable management side covers.

NOTES

- Order connectors and finished ends separately
- Add an additional 2 weeks to the standard lead time for laminate panels

SPECIFICATION OPTIONS

product #: see charts below
trim and top cap finish: LG Light Gray, MT Medium Tone, DT Dark Tone
base finish: MT Medium Tone, DT Dark Tone, LG Light Gray
panel glazing: TR Clear, FR Frosted
laminate finish (side 1): see page 5 (standard Wilsonart laminates)
laminate finish (side 2, if applicable): see page 5 (standard Wilsonart laminates)

ORDER EXAMPLE

product #: F2PGHSPA.5312N
trim and top cap finish: LG
base finish: DT
panel glazing: TR Clear
laminate finish (side 1): 7909-60 Fusion Maple
laminate finish (side 2): 7054-60 Wild Cherry

53" HIGH

PART #	HEIGHT	WIDTH	DEPTH	WT. (LBS)	PRICE
F2PGHSPA.5324N	53"	24"	3.5"	32	\$800
F2PGHSPA.5330N	53"	30"	3.5"	38	\$912
F2PGHSPA.5336N	53"	36"	3.5"	41	\$1024
F2PGHSPA.5342N	53"	42"	3.5"	44	\$1094
F2PGHSPA.5348N	53"	48"	3.5"	51	\$1120
F2PGHSPA.5360N	53"	60"	3.5"	57	\$1310

67" HIGH

PART #	HEIGHT	WIDTH	DEPTH	WT. (LBS)	PRICE
F2PGHSPA.6724N	67"	24"	3.5"	40	\$994
F2PGHSPA.6730N	67"	30"	3.5"	46	\$1122
F2PGHSPA.6736N	67"	36"	3.5"	51	\$1268
F2PGHSPA.6742N	67"	42"	3.5"	57	\$1382
F2PGHSPA.6748N	67"	48"	3.5"	64	\$1412
F2PGHSPA.6760N	67"	60"	3.5"	74	\$1709

85" HIGH

PART #	HEIGHT	WIDTH	DEPTH	WT. (LBS)	PRICE
F2PGHSPA.8524N	85"	24"	3.5"	29	\$1196
F2PGHSPA.8530N	85"	30"	3.5"	33	\$1398
F2PGHSPA.8536N	85"	36"	3.5"	38	\$1591
F2PGHSPA.8542N	85"	42"	3.5"	41	\$1731
F2PGHSPA.8548N	85"	48"	3.5"	47	\$1778
F2PGHSPA.8560N	85"	60"	3.5"	86	\$2116

Hard-Surface Partial Glazed Panel | Electrical

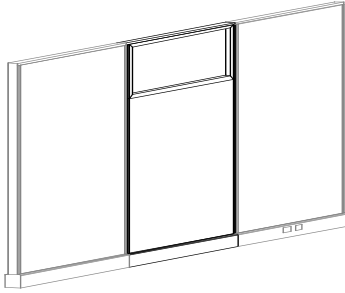

DESCRIPTION

Structural panel with laminate lower surfaces and 14" high tempered glass top section, painted top caps and trim, leveling glides, 4-circuit power installed in cable management raceway covers.

NOTES

- 24" wide panels have one receptacle per side.
- 30" and 60" wide panels have two receptacle locations per side.
- Order receptacles separately.
- Order connectors and finished ends separately.
- Order connector power kit separately.
- Add an additional 2 weeks to the standard lead time for laminate panels

SPECIFICATION OPTIONS

product #: see charts below
trim and top cap finish: LG Light Gray, MT Medium Tone, DT Dark Tone
base finish: MT Medium Tone, DT Dark Tone, LG Light Gray
panel glazing: TR Clear, FR Frosted
laminare finish (side 1): see page 5 (standard Wilsonart laminates)
laminare finish (side 2, if applicable): see page 5 (standard Wilsonart laminates)

ORDER EXAMPLE

product #: F2PGHSPA.5312E
trim and top cap finish: LG
base finish: DT
panel glazing: TR Clear
laminare finish (side 1): 7909-60 Fusion Maple
laminare finish (side 2): 7054-60 Wild Cherry

53" HIGH

PART #	HEIGHT	WIDTH	DEPTH	WT. (LBS)	PRICE
F2PGHSPA.5324E	53"	24"	3.5"	33	\$915
F2PGHSPA.5330E	53"	30"	3.5"	40	\$1045
F2PGHSPA.5336E	53"	36"	3.5"	43	\$1171
F2PGHSPA.5342E	53"	42"	3.5"	47	\$1260
F2PGHSPA.5348E	53"	48"	3.5"	53	\$1303
F2PGHSPA.5360E	53"	60"	3.5"	62	\$1530

67" HIGH

PART #	HEIGHT	WIDTH	DEPTH	WT. (LBS)	PRICE
F2PGHSPA.6724E	67"	24"	3.5"	41	\$1109
F2PGHSPA.6730E	67"	30"	3.5"	47	\$1256
F2PGHSPA.6736E	67"	36"	3.5"	53	\$1415
F2PGHSPA.6742E	67"	42"	3.5"	59	\$1548
F2PGHSPA.6748E	67"	48"	3.5"	67	\$1596
F2PGHSPA.6760E	67"	60"	3.5"	79	\$1929

85" HIGH

PART #	HEIGHT	WIDTH	DEPTH	WT. (LBS)	PRICE
F2PGHSPA.8524E	85"	24"	3.5"	50	\$1311
F2PGHSPA.8530E	85"	30"	3.5"	59	\$1532
F2PGHSPA.8536E	85"	36"	3.5"	67	\$1738
F2PGHSPA.8542E	85"	42"	3.5"	75	\$1897
F2PGHSPA.8548E	85"	48"	3.5"	84	\$1961
F2PGHSPA.8560E	85"	60"	3.5"	91	\$2336

Fabric-Covered Panel | Non-Electrical

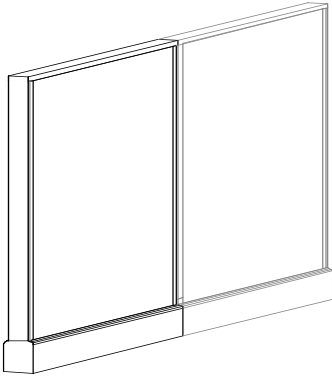

DESCRIPTION

Structural panel with fabric surfaces, painted top caps and trim, leveling glides, and cable management side covers.

NOTES

- Order connectors and finished ends separately.
- Standard fabric application for panels 67" and below is horizontal application. Panels taller than 67" are only available in vertical application. When ordering panels 67" and below to match a panel taller than 67", specify vertical application.

SPECIFICATION OPTIONS

product #: see charts below

trim and top cap finish: LG Light Gray, MT Medium Tone, DT Dark Tone

base finish: MT Medium Tone, DT Dark Tone, LG Light Gray

fabric (side 1): see page 4

fabric (side 2, if applicable): see page 4

ORDER EXAMPLE

product #: F2FAPA.3212N

trim and top cap finish: LG

base finish: DT

fabric (side 1): PF401-1 Silky - Natural

fabric (side 2): PF401-2 Silky - Parids

32" HIGH

PART #	HEIGHT	WIDTH	DEPTH	WT. (LBS)	PRICE
F2FAPA.3212N	32"	12"	3.5"	18	\$287
F2FAPA.3218N	32"	18"	3.5"	20	\$305
F2FAPA.3224N	32"	24"	3.5"	21	\$308
F2FAPA.3230N	32"	30"	3.5"	24	\$338
F2FAPA.3236N	32"	36"	3.5"	27	\$382
F2FAPA.3242N	32"	42"	3.5"	30	\$403
F2FAPA.3248N	32"	48"	3.5"	34	\$424
F2FAPA.3260N	32"	60"	3.5"	40	\$526

39" HIGH

PART #	HEIGHT	WIDTH	DEPTH	WT. (LBS)	PRICE
F2FAPA.3912N	39"	12"	3.5"	22	\$299
F2FAPA.3918N	39"	18"	3.5"	24	\$318
F2FAPA.3924N	39"	24"	3.5"	26	\$321
F2FAPA.3930N	39"	30"	3.5"	27	\$352
F2FAPA.3936N	39"	36"	3.5"	31	\$398
F2FAPA.3942N	39"	42"	3.5"	36	\$420
F2FAPA.3948N	39"	48"	3.5"	39	\$441
F2FAPA.3960N	39"	60"	3.5"	46	\$547

47" HIGH

PART #	HEIGHT	WIDTH	DEPTH	WT. (LBS)	PRICE
F2FAPA.4712N	47"	12"	3.5"	25	\$317
F2FAPA.4718N	47"	18"	3.5"	26	\$335
F2FAPA.4724N	47"	24"	3.5"	29	\$340
F2FAPA.4730N	47"	30"	3.5"	33	\$381
F2FAPA.4736N	47"	36"	3.5"	38	\$436
F2FAPA.4742N	47"	42"	3.5"	41	\$483
F2FAPA.4748N	47"	48"	3.5"	47	\$498
F2FAPA.4760N	47"	60"	3.5"	53	\$615

53" HIGH

PART #	HEIGHT	WIDTH	DEPTH	WT. (LBS)	PRICE
F2FAPA.5312N	53"	12"	3.5"	26	\$324
F2FAPA.5318N	53"	18"	3.5"	30	\$345
F2FAPA.5324N	53"	24"	3.5"	32	\$348
F2FAPA.5330N	53"	30"	3.5"	38	\$395
F2FAPA.5336N	53"	36"	3.5"	41	\$463
F2FAPA.5342N	53"	42"	3.5"	44	\$500
F2FAPA.5348N	53"	48"	3.5"	51	\$533
F2FAPA.5360N	53"	60"	3.5"	57	\$657

62" HIGH

PART #	HEIGHT	WIDTH	DEPTH	WT. (LBS)	PRICE
F2FAPA.6212N	62"	12"	3.5"	28	\$337
F2FAPA.6218N	62"	18"	3.5"	32	\$387
F2FAPA.6224N	62"	24"	3.5"	36	\$398
F2FAPA.6230N	62"	30"	3.5"	42	\$447
F2FAPA.6236N	62"	36"	3.5"	47	\$520
F2FAPA.6242N	62"	42"	3.5"	51	\$554
F2FAPA.6248N	62"	48"	3.5"	58	\$594
F2FAPA.6260N	62"	60"	3.5"	66	\$737

67" HIGH

PART #	HEIGHT	WIDTH	DEPTH	WT. (LBS)	PRICE
F2FAPA.6712N	67"	12"	3.5"	30	\$346
F2FAPA.6718N	67"	18"	3.5"	34	\$394
F2FAPA.6724N	67"	24"	3.5"	40	\$405
F2FAPA.6730N	67"	30"	3.5"	46	\$455
F2FAPA.6736N	67"	36"	3.5"	51	\$527
F2FAPA.6742N	67"	42"	3.5"	57	\$562
F2FAPA.6748N	67"	48"	3.5"	64	\$599
F2FAPA.6760N	67"	60"	3.5"	74	\$740

85" HIGH

PART #	HEIGHT	WIDTH	DEPTH	WT. (LBS)	PRICE
F2FAPA.8512N	85"	12"	3.5"	38	\$395
F2FAPA.8518N	85"	18"	3.5"	41	\$469
F2FAPA.8524N	85"	24"	3.5"	50	\$479
F2FAPA.8530N	85"	30"	3.5"	58	\$532
F2FAPA.8536N	85"	36"	3.5"	65	\$616
F2FAPA.8542N	85"	42"	3.5"	73	\$655
F2FAPA.8548N	85"	48"	3.5"	81	\$696
F2FAPA.8560N	85"	60"	3.5"	86	\$862

NOTES

Standard fabric application for panels 67" and below is horizontal application. Panels taller than 67" are only available in vertical application. When ordering panels 67" and below to match a panel taller than 67", specify vertical application.

Fabric-Covered Panel | Electrical

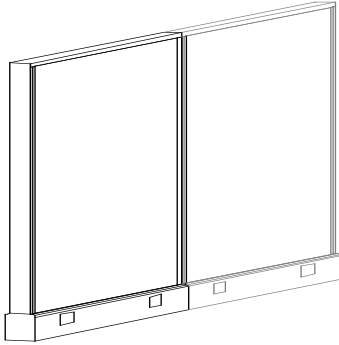

DESCRIPTION

Structural panel with fabric surfaces, painted top caps and trim, leveling glides, 4-circuit power installed in cable management raceway covers.

NOTES

- 12" and 18" wide panels have no receptacle.
- 24" wide panels have one receptacle per side.
- 30" - 60" wide panels have two receptacle locations per side.
- 12" and 18" wide panels have a panel pass-through power jumper.
- Order receptacles separately.
- Order connectors and finished ends separately.
- Order Pass-Through Festoon separately.
- Standard fabric application for panels 67" and below is horizontal application. Panels taller than 67" are only available in vertical application. When ordering panels 67" and below to match a panel taller than 67", specify vertical application.

SPECIFICATION OPTIONS

product #: see charts below
trim and top cap finish: LG Light Gray, MT Medium Tone, DT Dark Tone
base finish: MT Medium Tone, DT Dark Tone, LG Light Gray
fabric (side 1): see page 4
fabric (side 2, if applicable): see page 4

ORDER EXAMPLE

product #: F2FAPA.3212E
trim and top cap finish: LG
base finish: DT
fabric (side 1): PF401-1 Silky - Natural
fabric (side 2): PF401-2 Silky - Parids

32" HIGH

PART #	HEIGHT	WIDTH	DEPTH	WT. (LBS)	PRICE
F2FAPA.3212E	32"	12"	3.5"	19	\$418
F2FAPA.3218E	32"	18"	3.5"	21	\$428
F2FAPA.3224E	32"	24"	3.5"	22	\$439
F2FAPA.3230E	32"	30"	3.5"	25	\$469
F2FAPA.3236E	32"	36"	3.5"	29	\$512
F2FAPA.3242E	32"	42"	3.5"	32	\$533
F2FAPA.3248E	32"	48"	3.5"	37	\$554
F2FAPA.3260E	32"	60"	3.5"	45	\$656

39" HIGH

PART #	HEIGHT	WIDTH	DEPTH	WT. (LBS)	PRICE
F2FAPA.3912E	39"	12"	3.5"	23	\$429
F2FAPA.3918E	39"	18"	3.5"	25	\$441
F2FAPA.3924E	39"	24"	3.5"	27	\$452
F2FAPA.3930E	39"	30"	3.5"	29	\$482
F2FAPA.3936E	39"	36"	3.5"	33	\$528
F2FAPA.3942E	39"	42"	3.5"	38	\$550
F2FAPA.3948E	39"	48"	3.5"	42	\$571
F2FAPA.3960E	39"	60"	3.5"	51	\$677

47" HIGH

PART #	HEIGHT	WIDTH	DEPTH	WT. (LBS)	PRICE
F2FAPA.4712E	47"	12"	3.5"	25	\$447
F2FAPA.4718E	47"	18"	3.5"	27	\$460
F2FAPA.4724E	47"	24"	3.5"	30	\$471
F2FAPA.4730E	47"	30"	3.5"	35	\$511
F2FAPA.4736E	47"	36"	3.5"	40	\$566
F2FAPA.4742E	47"	42"	3.5"	43	\$614
F2FAPA.4748E	47"	48"	3.5"	50	\$629
F2FAPA.4760E	47"	60"	3.5"	58	\$745

53" HIGH

PART #	HEIGHT	WIDTH	DEPTH	WT. (LBS)	PRICE
F2FAPA.5312E	53"	12"	3.5"	27	\$455
F2FAPA.5318E	53"	18"	3.5"	31	\$467
F2FAPA.5324E	53"	24"	3.5"	33	\$478
F2FAPA.5330E	53"	30"	3.5"	40	\$526
F2FAPA.5336E	53"	36"	3.5"	43	\$594
F2FAPA.5342E	53"	42"	3.5"	47	\$631
F2FAPA.5348E	53"	48"	3.5"	53	\$664
F2FAPA.5360E	53"	60"	3.5"	62	\$788

62" HIGH

PART #	HEIGHT	WIDTH	DEPTH	WT. (LBS)	PRICE
F2FAPA.6212E	62"	12"	3.5"	29	\$467
F2FAPA.6218E	62"	18"	3.5"	33	\$517
F2FAPA.6224E	62"	24"	3.5"	36	\$528
F2FAPA.6230E	62"	30"	3.5"	44	\$578
F2FAPA.6236E	62"	36"	3.5"	49	\$651
F2FAPA.6242E	62"	42"	3.5"	54	\$685
F2FAPA.6248E	62"	48"	3.5"	61	\$724
F2FAPA.6260E	62"	60"	3.5"	71	\$867

67" HIGH

PART #	HEIGHT	WIDTH	DEPTH	WT. (LBS)	PRICE
F2FAPA.6712E	67"	12"	3.5"	31	\$476
F2FAPA.6718E	67"	18"	3.5"	35	\$525
F2FAPA.6724E	67"	24"	3.5"	41	\$535
F2FAPA.6730E	67"	30"	3.5"	47	\$585
F2FAPA.6736E	67"	36"	3.5"	53	\$657
F2FAPA.6742E	67"	42"	3.5"	59	\$692
F2FAPA.6748E	67"	48"	3.5"	67	\$729
F2FAPA.6760E	67"	60"	3.5"	79	\$870

85" HIGH

PART #	HEIGHT	WIDTH	DEPTH	WT. (LBS)	PRICE
F2FAPA.8512E	85"	12"	3.5"	39	\$526
F2FAPA.8518E	85"	18"	3.5"	42	\$599
F2FAPA.8524E	85"	24"	3.5"	50	\$610
F2FAPA.8530E	85"	30"	3.5"	59	\$663
F2FAPA.8536E	85"	36"	3.5"	67	\$746
F2FAPA.8542E	85"	42"	3.5"	75	\$785
F2FAPA.8548E	85"	48"	3.5"	84	\$827
F2FAPA.8560E	85"	60"	3.5"	91	\$992

NOTES

Standard fabric application for panels 67" and below is horizontal application. Panels taller than 67" are only available in vertical application. When ordering panels 67" and below to match a panel taller than 67", specify vertical application.

Acoustical Panel | Non-Electrical

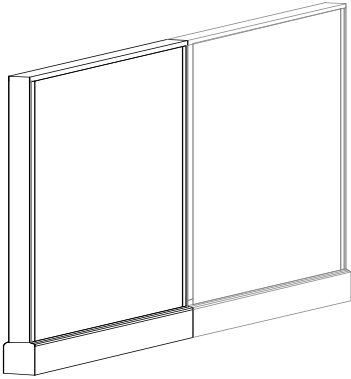

DESCRIPTION

Sound reducing, structural panel with fabric surfaces, painted top cap and trim, leveling glides and cable management side covers.

NOTES

- Order connectors and finished ends separately.
- Standard fabric application for panels 67" and below is horizontal application. Panels taller than 67" are only available in vertical application. When ordering panels 67" and below to match a panel taller than 67", specify vertical application.

SPECIFICATION OPTIONS

product #: see charts below
trim and top cap finish: LG Light Gray, MT Medium Tone, DT Dark Tone
base finish: MT Medium Tone, DT Dark Tone, LG Light Gray
fabric (side 1): see page 4
fabric (side 2, if applicable): see page 4

ORDER EXAMPLE

product #: F2ACPA.5312N
trim and top cap finish: LG
base finish: DT
fabric (side 1): PF401-1 Silky - Natural
fabric (side 2): PF401-2 Silky - Parids

53" HIGH

PART #	HEIGHT	WIDTH	DEPTH	WT. (LBS)	PRICE
F2ACPA.5312N	53"	12"	3.5"	26	\$442
F2ACPA.5318N	53"	18"	3.5"	30	\$497
F2ACPA.5324N	53"	24"	3.5"	32	\$500
F2ACPA.5330N	53"	30"	3.5"	38	\$544
F2ACPA.5336N	53"	36"	3.5"	41	\$606
F2ACPA.5342N	53"	42"	3.5"	44	\$637
F2ACPA.5348N	53"	48"	3.5"	51	\$672
F2ACPA.5360N	53"	60"	3.5"	57	\$824

62" HIGH

PART #	HEIGHT	WIDTH	DEPTH	WT. (LBS)	PRICE
F2ACPA.6212N	62"	12"	3.5"	28	\$460
F2ACPA.6218N	62"	18"	3.5"	32	\$497
F2ACPA.6224N	62"	24"	3.5"	36	\$504
F2ACPA.6230N	62"	30"	3.5"	42	\$547
F2ACPA.6236N	62"	36"	3.5"	47	\$615
F2ACPA.6242N	62"	42"	3.5"	51	\$643
F2ACPA.6248N	62"	48"	3.5"	58	\$679
F2ACPA.6260N	62"	60"	3.5"	66	\$830

67" HIGH

PART #	HEIGHT	WIDTH	DEPTH	WT. (LBS)	PRICE
F2ACPA.6712N	67"	12"	3.5"	30	\$472
F2ACPA.6718N	67"	18"	3.5"	34	\$515
F2ACPA.6724N	67"	24"	3.5"	40	\$520
F2ACPA.6730N	67"	30"	3.5"	46	\$564
F2ACPA.6736N	67"	36"	3.5"	51	\$632
F2ACPA.6742N	67"	42"	3.5"	57	\$660
F2ACPA.6748N	67"	48"	3.5"	64	\$699
F2ACPA.6760N	67"	60"	3.5"	74	\$841

85" HIGH

PART #	HEIGHT	WIDTH	DEPTH	WT. (LBS)	PRICE
F2ACPA.8512N	85"	12"	3.5"	38	\$542
F2ACPA.8518N	85"	18"	3.5"	41	\$593
F2ACPA.8524N	85"	24"	3.5"	50	\$594
F2ACPA.8530N	85"	30"	3.5"	58	\$649
F2ACPA.8536N	85"	36"	3.5"	65	\$732
F2ACPA.8542N	85"	42"	3.5"	73	\$773
F2ACPA.8548N	85"	48"	3.5"	81	\$824
F2ACPA.8560N	85"	60"	3.5"	86	\$1009

NOTES

Standard fabric application for panels 67" and below is horizontal application. Panels taller than 67" are only available in vertical application. When ordering panels 67" and below to match a panel taller than 67", specify vertical application.

Acoustical Panel | Electrical

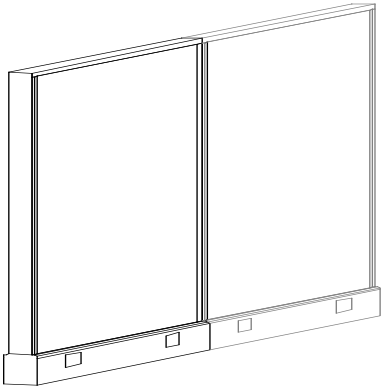

DESCRIPTION

Sound reducing, structural panel with fabric surfaces, painted top cap and trim, leveling glides, 4-circuit power installed in cable management raceway covers.

NOTES

- 12" and 18" wide panels have no receptacle.
- 24" wide panels have one receptacle per side.
- 30" - 60" wide panels have two receptacle locations per side.
- 12" and 18" wide panels have a panel pass-through power jumper.
- Order receptacles separately.
- Order connectors and finished ends separately.
- Order Pass-Through Festoon separately.
- Standard fabric application for panels 67" and below is horizontal application. Panels taller than 67" are only available in vertical application. When ordering panels 67" and below to match a panel taller than 67", specify vertical application.

SPECIFICATION OPTIONS

product #: see charts below

trim and top cap finish: LG Light Gray, MT Medium Tone, DT Dark Tone

base finish: MT Medium Tone, DT Dark Tone, LG Light Gray

fabric (side 1): see page 4

fabric (side 2, if applicable): see page 4

ORDER EXAMPLE

product #: F2ACPA.5312E

trim and top cap finish: LG

base finish: DT

fabric (side 1): PF401-1 Silky - Natural

fabric (side 2): PF401-2 Silky - Parids

53" HIGH

PART #	HEIGHT	WIDTH	DEPTH	WT. (LBS)	PRICE
F2ACPA.5312E	53"	12"	3.5"	27	\$572
F2ACPA.5318E	53"	18"	3.5"	31	\$628
F2ACPA.5324E	53"	24"	3.5"	33	\$631
F2ACPA.5330E	53"	30"	3.5"	40	\$674
F2ACPA.5336E	53"	36"	3.5"	43	\$737
F2ACPA.5342E	53"	42"	3.5"	47	\$767
F2ACPA.5348E	53"	48"	3.5"	53	\$802
F2ACPA.5360E	53"	60"	3.5"	62	\$954

62" HIGH

PART #	HEIGHT	WIDTH	DEPTH	WT. (LBS)	PRICE
F2ACPA.6212E	62"	12"	3.5"	29	\$590
F2ACPA.6218E	62"	18"	3.5"	33	\$628
F2ACPA.6224E	62"	24"	3.5"	36	\$634
F2ACPA.6230E	62"	30"	3.5"	44	\$677
F2ACPA.6236E	62"	36"	3.5"	49	\$745
F2ACPA.6242E	62"	42"	3.5"	54	\$774
F2ACPA.6248E	62"	48"	3.5"	61	\$810
F2ACPA.6260E	62"	60"	3.5"	71	\$960

67" HIGH

PART #	HEIGHT	WIDTH	DEPTH	WT. (LBS)	PRICE
F2ACPA.6712E	67"	12"	3.5"	31	\$602
F2ACPA.6718E	67"	18"	3.5"	35	\$646
F2ACPA.6724E	67"	24"	3.5"	41	\$651
F2ACPA.6730E	67"	30"	3.5"	47	\$694
F2ACPA.6736E	67"	36"	3.5"	53	\$762
F2ACPA.6742E	67"	42"	3.5"	59	\$791
F2ACPA.6748E	67"	48"	3.5"	67	\$829
F2ACPA.6760E	67"	60"	3.5"	79	\$971

85" HIGH

PART #	HEIGHT	WIDTH	DEPTH	WT. (LBS)	PRICE
F2ACPA.8512E	85"	12"	3.5"	39	\$672
F2ACPA.8518E	85"	18"	3.5"	42	\$723
F2ACPA.8524E	85"	24"	3.5"	50	\$724
F2ACPA.8530E	85"	30"	3.5"	59	\$779
F2ACPA.8536E	85"	36"	3.5"	67	\$863
F2ACPA.8542E	85"	42"	3.5"	75	\$903
F2ACPA.8548E	85"	48"	3.5"	84	\$954
F2ACPA.8560E	85"	60"	3.5"	91	\$1,140

NOTES

Standard fabric application for panels 67" and below is horizontal application. Panels taller than 67" are only available in vertical application. When ordering panels 67" and below to match a panel taller than 67", specify vertical application.

Partial-Glazed Panel | Non-Electrical

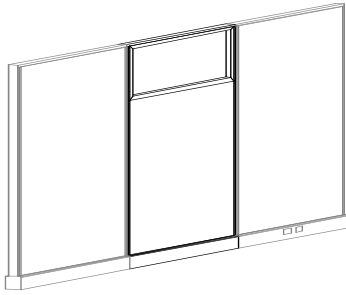

DESCRIPTION

Structural panel with fabric covered lower surfaces and 14" high tempered glass top section, painted top cap and cable management side covers.

NOTES

- Order connectors and finished ends separately.

SPECIFICATION OPTIONS

product #: see charts below
trim and top cap finish: LG Light Gray, MT Medium Tone, DT Dark Tone
panel glazing: TR Clear, FR Frosted
base finish: MT Medium Tone, DT Dark Tone, LG Light Gray
fabric (side 1): see page 4
fabric (side 2, if applicable): see page 4

ORDER EXAMPLE

product #: F2 PGPA.5324N
trim and top cap finish: LG
panel glazing: TR
base finish: DT
fabric (side 1): PF401-1 Silky - Natural
fabric (side 2): PF401-2 Silky - Parids

53" HIGH

PART #	HEIGHT	WIDTH	DEPTH	WT. (LBS)	PRICE
F2 PGPA.5324N	53"	24"	3.5"	37	\$533
F2 PGPA.5330N	53"	30"	3.5"	41	\$581
F2 PGPA.5336N	53"	36"	3.5"	47	\$702
F2 PGPA.5342N	53"	42"	3.5"	54	\$739
F2 PGPA.5348N	53"	48"	3.5"	61	\$809
F2 PGPA.5360N	53"	60"	3.5"	73	\$933

67" HIGH

PART #	HEIGHT	WIDTH	DEPTH	WT. (LBS)	PRICE
F2 PGPA.6724N	67"	24"	3.5"	42	\$590
F2 PGPA.6730N	67"	30"	3.5"	50	\$640
F2 PGPA.6736N	67"	36"	3.5"	56	\$765
F2 PGPA.6742N	67"	42"	3.5"	62	\$800
F2 PGPA.6748N	67"	48"	3.5"	71	\$875
F2 PGPA.6760N	67"	60"	3.5"	82	\$1,015

85" HIGH

PART #	HEIGHT	WIDTH	DEPTH	WT. (LBS)	PRICE
F2 PGPA.8524N	85"	24"	3.5"	49	\$665
F2 PGPA.8530N	85"	30"	3.5"	57	\$718
F2 PGPA.8536N	85"	36"	3.5"	65	\$854
F2 PGPA.8542N	85"	42"	3.5"	73	\$894
F2 PGPA.8548N	85"	48"	3.5"	83	\$972
F2 PGPA.8560N	85"	60"	3.5"	97	\$1,137

Partial-Glazed Panel | Electrical

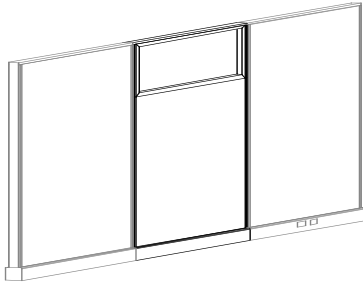

DESCRIPTION

Structural panel with fabric covered lower surfaces and 14" high tempered glass top section, painted top cap and leveling glides, 4-circuit power installed in cable management raceway covers.

NOTES

- 12" and 18" wide panels have no receptacle.
- 24" wide panels have one receptacle per side.
- 30" - 60" wide panels have two receptacle locations per side.
- Order connectors and finished ends separately.
- Order Pass-Through Festoon separately.

SPECIFICATION OPTIONS

product #: see charts below
trim and top cap finish: LG Light Gray, MT Medium Tone, DT Dark Tone
panel glazing: TR Clear, FR Frosted
base finish: MT Medium Tone, DT Dark Tone, LG Light Gray
fabric (side 1): see page 4
fabric (side 2, if applicable): see page 4

ORDER EXAMPLE

product #: F2PGPA.5324E
trim and top cap finish: LG
panel glazing: TR
base finish: DT
fabric (side 1): PF101-1 Slide - Caramel
fabric (side 2, if applicable): PF101-6 Slide - Vintage

53" HIGH

PART #	HEIGHT	WIDTH	DEPTH	WT. (LBS)	PRICE
F2 PGPA.5324E	53"	24"	3.5"	38	\$664
F2 PGPA.5330E	53"	30"	3.5"	42	\$711
F2 PGPA.5336E	53"	36"	3.5"	49	\$832
F2 PGPA.5342E	53"	42"	3.5"	56	\$869
F2 PGPA.5348E	53"	48"	3.5"	63	\$939
F2 PGPA.5360E	53"	60"	3.5"	77	\$1,063

67" HIGH

PART #	HEIGHT	WIDTH	DEPTH	WT. (LBS)	PRICE
F2 PGPA.6724E	67"	24"	3.5"	43	\$721
F2 PGPA.6730E	67"	30"	3.5"	52	\$771
F2 PGPA.6736E	67"	36"	3.5"	57	\$896
F2 PGPA.6742E	67"	42"	3.5"	64	\$931
F2 PGPA.6748E	67"	48"	3.5"	74	\$1,005
F2 PGPA.6760E	67"	60"	3.5"	86	\$1,146

85" HIGH

PART #	HEIGHT	WIDTH	DEPTH	WT. (LBS)	PRICE
F2 PGPA.8524E	85"	24"	3.5"	50	\$795
F2 PGPA.8530E	85"	30"	3.5"	58	\$848
F2 PGPA.8536E	85"	36"	3.5"	67	\$985
F2 PGPA.8542E	85"	42"	3.5"	75	\$1,024
F2 PGPA.8548E	85"	48"	3.5"	85	\$1,102
F2 PGPA.8560E	85"	60"	3.5"	101	\$1,268

Door Panel

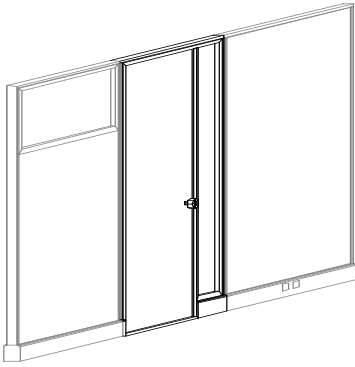

DESCRIPTION

Painted frame with 36" wide lockable laminate door and 6" wide glazed side panel, painted top cap and leveling glides.

NOTES

- Door hangs left or right, swings in or out.
- Available in cable management base only.
- Order connectors and finished ends separately.
- When connecting a Door Panel to a 2- or 3-Way Post, there will be a small gap at the base, between the trim and the door.

SPECIFICATION OPTIONS

product #: see charts below
trim, top cap & door finish: LG Light Gray, MT Medium Tone, DT Dark Tone
base finish: MT Medium Tone, DT Dark Tone, LG Light Gray
panel glazing: TR Clear, FR Frosted

ORDER EXAMPLE

product #: F2DOPA.8548
trim, top cap & door finish: LG
base finish: MT
panel glazing: TR

85" HIGH

PART #	HEIGHT	WIDTH	DEPTH	WT. (LBS)	PRICE
F2DOPA.8548	85"	48"	3.5"	111	\$3,180

Draw Rod



DESCRIPTION

Panel hardware to connect two panels in a straight line.

SPECIFICATION OPTIONS

product #: see charts below

NOTES

- When connecting panels of different heights to each other, order Draw Rod Change of Height.
- Draw Rods are 5" shorter than the panel height.

ORDER EXAMPLE

product #: FDR.27

DRAW ROD



PART #	HEIGHT	WIDTH	DEPTH	WT. (LBS)	PRICE
FDR.27	27"	—	—	1	\$15
FDR.34	34"	—	—	1	\$16
FDR.42	42"	—	—	1	\$16
FDR.48	48"	—	—	1	\$17
FDR.57	57"	—	—	1	\$17
FDR.62	62"	—	—	1	\$17
FDR.80	80"	—	—	2	\$18

NOTES

Rod and block assembly connects two panels at 180° (straight line)

Color: DT Dark Tone

DRAW ROD CHANGE OF HEIGHT



PART #	HEIGHT	WIDTH	DEPTH	WT. (LBS)	PRICE
FDRCH.27	27"	—	—	1	\$32
FDRCH.34	34"	—	—	1	\$32
FDRCH.42	42"	—	—	1	\$32
FDRCH.48	48"	—	—	1	\$37
FDRCH.57	57"	—	—	1	\$37
FDRCH.62	62"	—	—	1	\$37

NOTES

Rod and block assembly connects two panels at 180° (straight line) when the panels are of different height.

Order the height of the shorter panel.

Includes Hanger Rail to match the height of the shorter panel
Remove Hanger Rail from taller panel and replace with the shorter Hanger Rail.

Color: DT Dark Tone.

Connectors

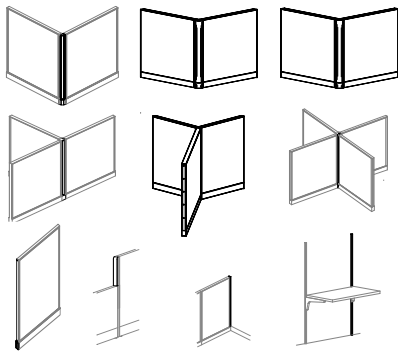

DESCRIPTION

Panel hardware to connect 2, 3 or 4 panels at 90°, 120° or 135°.

NOTES

SPECIFICATION OPTIONS

product #: see charts below
finish: LG Light Gray, MT Medium Tone, DT Dark Tone
base finish: MT Medium Tone, DT Dark Tone, LG Light Gray

ORDER EXAMPLE

product #: F22W.32
finish: DT
base finish: DT

2-WAY 90° CONNECTOR POST HARD SURFACE

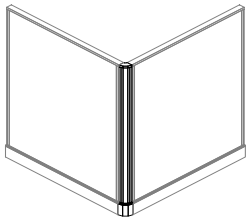

PART #	HEIGHT	WIDTH	DEPTH	WT. (LBS)	PRICE
F22W.32	32"	3.5"	3.5"	3	\$103
F22W.39	39"	3.5"	3.5"	4	\$103
F22W.47	47"	3.5"	3.5"	5	\$113
F22W.53	53"	3.5"	3.5"	6	\$120
F22W.62	62"	3.5"	3.5"	7	\$128
F22W.67	67"	3.5"	3.5"	7	\$130
F22W.85	85"	3.5"	3.5"	8	\$147

NOTES

Connects 2 panels at 90°.

Includes cable management trim cover.

2-WAY 120° CONNECTOR POST HARD SURFACE

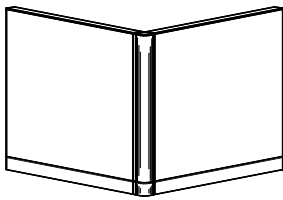

PART #	HEIGHT	WIDTH	DEPTH	WT. (LBS)	PRICE
F22W-120.32	32"	3.5"	3.5"	3	\$103
F22W-120.39	39"	3.5"	3.5"	4	\$103
F22W-120.47	47"	3.5"	3.5"	5	\$113
F22W-120.53	53"	3.5"	3.5"	6	\$120
F22W-120.62	62"	3.5"	3.5"	7	\$128
F22W-120.67	67"	3.5"	3.5"	7	\$130
F22W-120.85	85"	3.5"	3.5"	8	\$147

NOTES

Connects 2 panels at 120°.

Includes cable management trim cover.

Check for availability.

2-WAY 135° CONNECTOR POST HARD SURFACE

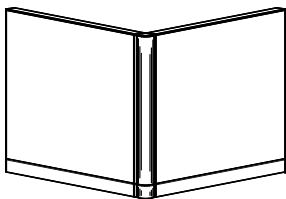

PART #	HEIGHT	WIDTH	DEPTH	WT. (LBS)	PRICE
F22W-135.32	32"	3.5"	3.5"	3	\$156
F22W-135.39	39"	3.5"	3.5"	4	\$162
F22W-135.47	47"	3.5"	3.5"	5	\$174
F22W-135.53	53"	3.5"	3.5"	6	\$184
F22W-135.62	62"	3.5"	3.5"	7	\$200
F22W-135.67	67"	3.5"	3.5"	7	\$202
F22W-135.85	85"	3.5"	3.5"	8	\$230

NOTES

Connects 2 panels at 135°.

Includes cable management trim cover.

Check for availability.

**3-WAY 90°
CONNECTOR POST
HARD SURFACE**

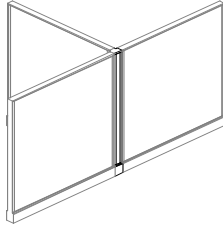

PART #	HEIGHT	WIDTH	DEPTH	WT. (LBS)	PRICE
F23W.32	32"	3.5"	3.5"	5	\$156
F23W.39	39"	3.5"	3.5"	5	\$162
F23W.47	47"	3.5"	3.5"	6	\$174
F23W.53	53"	3.5"	3.5"	7	\$184
F23W.62	62"	3.5"	3.5"	8	\$200
F23W.67	67"	3.5"	3.5"	8	\$202
F23W.85	85"	3.5"	3.5"	9	\$230

NOTES
Connects 3 panels at 90°. Includes cable management trim cover.

**3-WAY 120°
CONNECTOR POST
HARD SURFACE**

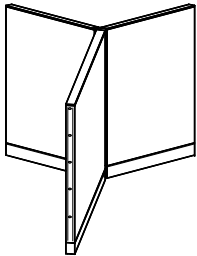

PART #	HEIGHT	WIDTH	DEPTH	WT. (LBS)	PRICE
F23W-120.32	32"	3.5"	3.5"	5	\$156
F23W-120.39	39"	3.5"	3.5"	5	\$162
F23W-120.47	47"	3.5"	3.5"	6	\$174
F23W-120.53	53"	3.5"	3.5"	7	\$184
F23W-120.62	62"	3.5"	3.5"	8	\$200
F23W-120.67	67"	3.5"	3.5"	8	\$202
F23W-120.85	85"	3.5"	3.5"	9	\$230

NOTES
Connects 3 panels at 120°. Check for availability.

**4-WAY 90°
CONNECTOR POST
HARD SURFACE**

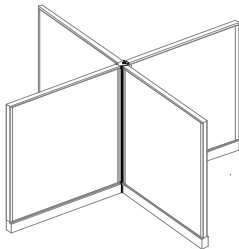

PART #	HEIGHT	WIDTH	DEPTH	WT. (LBS)	PRICE
F24W.32	32"	3.5"	3.5"	5	\$196
F24W.39	39"	3.5"	3.5"	6	\$204
F24W.47	47"	3.5"	3.5"	7	\$217
F24W.53	53"	3.5"	3.5"	8	\$237
F24W.62	62"	3.5"	3.5"	9	\$260
F24W.67	67"	3.5"	3.5"	10	\$262
F24W.85	85"	3.5"	3.5"	10	\$293

NOTES
Connects 4 panels at 90°.

Connectors | (cont'd)

FINISHED END

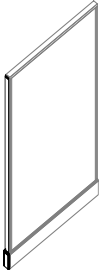

PART #	HEIGHT	WIDTH	DEPTH	WT. (LBS)	PRICE
F2FE.32	32"	3.5"	1"	1	\$48
F2FE.39	39"	3.5"	1"	2	\$48
F2FE.47	47"	3.5"	1"	2	\$53
F2FE.53	53"	3.5"	1"	2	\$53
F2FE.62	62"	3.5"	1"	2	\$53
F2FE.67	67"	3.5"	1"	2	\$58
F2FE.85	85"	3.5"	1"	3	\$64

NOTES

Finishes the vertical end of a panel at the end of a panel run.

Includes cable management trim cover.

FINISHED END, CHANGE OF HEIGHT

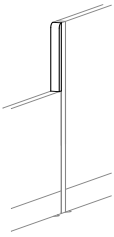

PART #	HEIGHT	WIDTH	DEPTH	WT. (LBS)	PRICE
FFECH	48"	1.75"	.25"	1	\$18

NOTES

Finishes the exposed end of a panel or connector at a change of height location.

Includes finished end trim and mounting hardware.

May be cut to the appropriate length.

WALL START

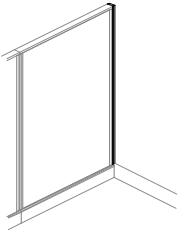

PART #	HEIGHT	WIDTH	DEPTH	WT. (LBS)	PRICE
FWSTA.27	27"	1.75"	1"	1	\$48
FWSTA.34	34"	1.75"	1"	2	\$51
FWSTA.42	42"	1.75"	1"	3	\$51
FWSTA.48	48"	1.75"	1"	3	\$51
FWSTA.57	57"	1.75"	1"	3	\$53
FWSTA.62	62"	1.75"	1"	3	\$53
FWSTA.80	80"	1.75"	1"	4	\$58

NOTES

Connects panel to structural wall or column.

Can also connect equal height panels at a 90° angle at any point along the panel width.

May be field cut to the appropriate length.

Order one additional Draw Rod of the same height.

WALL STRIP

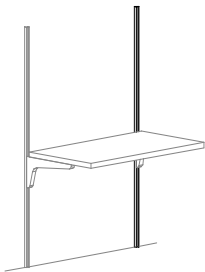

PART #	HEIGHT	WIDTH	DEPTH	WT. (LBS)	PRICE
FWSST.60	60"	—	—	3	\$58
FWSST.72	72"	—	—	3	\$66
FWSST.84	84"	—	—	4	\$66

NOTES

Attaches to structural wall to hang worksurfaces and/or components.

Includes one wall strip.

Aluminum finish only.

Electrical Distribution

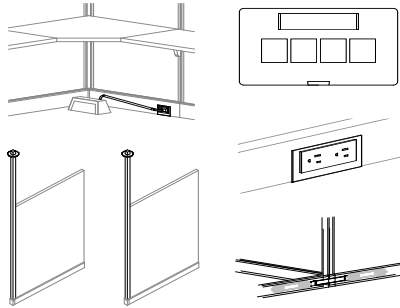

DESCRIPTION

Parts for distributing power through your system. Distributes up to four 20-amp circuits.

NOTES

- 4-circuit

SPECIFICATION OPTIONS

product #: see charts below
pole finish: LG Light Gray, MT Medium Tone, DT Dark Tone
base finish: MT Medium Tone, DT Dark Tone, LG Light Gray

ORDER EXAMPLE

product #: F2CPE4.39
pole finish: DT
base finish: DT

BASE POWER ENTRY DIRECT CONNECT, 4-CIRCUIT

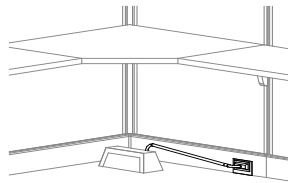

PART #	HEIGHT	WIDTH	DEPTH	WT. (LBS)	PRICE
F2BPE	left angle elbow	—	—	5	\$276

NOTES

Connects building power from a wall, floor or column to the base of a panel.

Plugs directly into the panel's electrical harness at receptacle location.

Distributes up to four 20-amp circuits.

Includes a cable that can be field-cut to the appropriate length.

MUST BE WIRED BY A LICENSED ELECTRICIAN.

RECEPTACLE 4-CIRCUIT

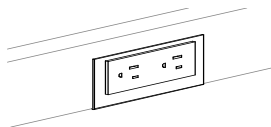

PART #	HEIGHT	WIDTH	DEPTH	WT. (LBS)	PRICE
F2RECP4.I	circuit a			0.25	\$28
F2RECP4.II	circuit b			0.25	\$28
F2RECP4.III	circuit c			0.25	\$28
F2RECP4.IIII	circuit d, dedicated			0.25	\$28

NOTES

Locks into panel base power harness.

Provides access to I, II, III, or IIII circuit.

Provides dedicated circuit with "IIII" receptacle.

Electrical Distribution | (cont'd)

CEILING POWER ENTRY INTERNAL DIRECT CONNECT 4-CIRCUIT

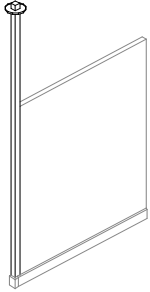

PART #	HEIGHT	WIDTH	DEPTH	WT. (LBS)	PRICE
F2CPE4.39	39"	3.5"	3.5"	13	\$477
F2CPE4.47	47"	3.5"	3.5"	13	\$477
F2CPE4.53	53"	3.5"	3.5"	13	\$477
F2CPE4.62	62"	3.5"	3.5"	13	\$477
F2CPE4.67	67"	3.5"	3.5"	13	\$477
F2CPE4.85	85"	3.5"	3.5"	13	\$477

NOTES

Connects a ceiling electrical supply to the base of a powered panel.

Distributes up to four 20-amp circuits.

Attaches to the end of a panel run, or to a 3 or 4-way 90° connector.

To attach the Power Pole at the end of a panel run, order a Draw Rod separately.

To attach at a:

- 2-Way connection point, order a 3-Way connector
- 3-Way connection point, order a 4-Way connector

Includes a rigid conduit and conduit connector, factory installed power harness, 12' pole, bezel and end cap trim cover.

Available in LG, MT, DT only.

MUST BE WIRED BY A LICENSED ELECTRICIAN.

CEILING DATA ENTRY NON-POWERED

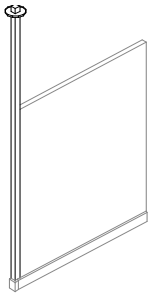

PART #	HEIGHT	WIDTH	DEPTH	WT. (LBS)	PRICE
F2CDE.39	39"	3.5"	3.5"	8	\$212
F2CDE.47	47"	3.5"	3.5"	8	\$212
F2CDE.53	53"	3.5"	3.5"	8	\$212
F2CDE.62	62"	3.5"	3.5"	8	\$212
F2CDE.67	67"	3.5"	3.5"	8	\$212
F2CDE.85	85"	3.5"	3.5"	8	\$212

NOTES

Routes data/telecommunication cables from the ceiling to the base of a panel.

Attaches to the end of a panel run, to a 3 or 4-Way 90° connector.

To attach the Power Pole at the end of a panel run, order a Draw Rod separately.

To attach at a:

- 2-Way connection point, order a 3-Way connector
- 3-Way connection point, order a 4-Way connector

Includes a 12' pole, bezel, and end cap trim cover.

Available in LG, MT, DT only.

PASS-THROUGH FESTOON 23" LONG, 4-CIRCUIT

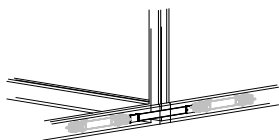

PART #	HEIGHT	WIDTH	DEPTH	WT. (LBS)	PRICE
F2CPK.1	23"	—	—	1	\$71

NOTES

Extends power when connecting power in a straight line through a 3-Way, 4-Way or Spacer Connector Post.

DATA PORT PLATE

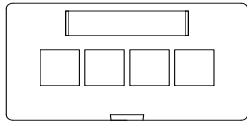

PART #	HEIGHT	WIDTH	DEPTH	WT. (LBS)	PRICE	NOTES
F2DPP	2.125"	3.625"	0.250"	0.10	\$32	<p>This Data Port plate is used at the base of a panel to connect computers and/or communication equipment.</p> <p>4 port locations and comes with 1 blank insert.</p>

POWER PANEL CONVERSION KIT

PART #	HEIGHT	WIDTH	DEPTH	WT. (LBS)	PRICE	NOTES
F2PPCK.12	—	12"	—	1	\$114	<p>Includes:</p> <ul style="list-style-type: none"> • Power Retro— Pass Through • Base cover with power cutouts • Panel to Panel Festoon <p>Order the 23" Pass-Through Festoon, if you are converting a non electrical panel with any of the following:</p> <ul style="list-style-type: none"> • 3-Way connection • 4 Way connection • Spacer Connector
F2PPCK.18	—	18"	—	1	\$114	

PART #	HEIGHT	WIDTH	DEPTH	WT. (LBS)	PRICE	NOTES
F2PPCK.24	—	24"	—	1	\$123	<p>Includes:</p> <ul style="list-style-type: none"> • Power Retro • Base Cover with Power Cutouts • Panel to Panel Festoon <p>Order duplex outlets separately.</p> <p>Order the 23" Pass-Through Festoon, if you are converting a non electrical panel with any of the following:</p> <ul style="list-style-type: none"> • 3-Way connection • 4 Way connection • Spacer Connector
F2PPCK.30	—	30"	—	2	\$139	
F2PPCK.36	—	36"	—	2	\$161	
F2PPCK.42	—	42"	—	2	\$181	
F2PPCK.48	—	48"	—	3	\$201	
F2PPCK.60	—	60"	—	5	\$241	

Rectangular Worksurface

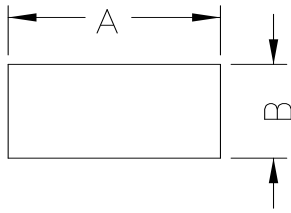
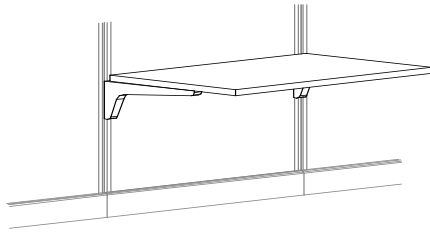

DESCRIPTION

Worksurface hangs from a panel or Wall Strips. It has a laminate top and a PVC edge. There is a 1" gap at the back of the worksurface for plug and cord passage. 60" to 84" worksurfaces have a center support. Includes cantilever brackets, and attachment hardware.

NOTES

When ordering a worksurface spanning a panel and a 3-Way or Spacer Connector, or two panels with a 3-Way or Spacer Connector in between the panels, you will need to:

- add 3.5" to the length of the worksurface
- add "-3W" to the part number
- add \$80 to the list price

example:
Two 30"W Frames with one 3-Way Connector equals to 63.5". In this case, order FSERWS.2460L-3W. (\$414 + \$80 = \$494)

SPECIFICATION OPTIONS

product #: see charts below
top, edge finish: see page 5
support finish: LG Light Gray, MT Medium Tone, DT Dark Tone
worksurface finish: see page 5

ORDER EXAMPLE

product #: FSERWS.2424L
top, edge finish: LG
support finish: DT
worksurface finish: 7909-60 Light Maple

24" D WORKSURFACES

PART #	HEIGHT	A	B	C	D	WT. (LBS)	PRICE
FSERWS.2424L	1.25"	24"	24"	—	—	30	\$210
FSERWS.2430L	1.25"	30"	24"	—	—	36	\$247
FSERWS.2436L	1.25"	36"	24"	—	—	41	\$253
FSERWS.2442L	1.25"	42"	24"	—	—	47	\$325
FSERWS.2448L	1.25"	48"	24"	—	—	53	\$333
FSERWS.2454L	1.25"	54"	24"	—	—	58	\$389
FSERWS.2460L	1.25"	60"	24"	—	—	64	\$414
FSERWS.2466L	1.25"	66"	24"	—	—	70	\$471
FSERWS.2472L	1.25"	72"	24"	—	—	76	\$480
FSERWS.2478L	1.25"	78"	24"	—	—	81	\$582
FSERWS.2484L	1.25"	84"	24"	—	—	87	\$585

30" D WORKSURFACES

PART #	HEIGHT	A	B	C	D	WT. (LBS)	PRICE
FSERWS.3024L	1.25"	24"	30"	—	—	38	\$276
FSERWS.3030L	1.25"	30"	30"	—	—	45	\$325
FSERWS.3036L	1.25"	36"	30"	—	—	53	\$332
FSERWS.3042L	1.25"	42"	30"	—	—	60	\$417
FSERWS.3048L	1.25"	48"	30"	—	—	66	\$424
FSERWS.3054L	1.25"	54"	30"	—	—	74	\$493
FSERWS.3060L	1.25"	60"	30"	—	—	81	\$518
FSERWS.3066L	1.25"	66"	30"	—	—	88	\$589
FSERWS.3072L	1.25"	72"	30"	—	—	95	\$599
FSERWS.3078L	1.25"	78"	30"	—	—	103	\$725
FSERWS.3084L	1.25"	84"	30"	—	—	111	\$728

90° Notched and Curved Corner | Worksurface

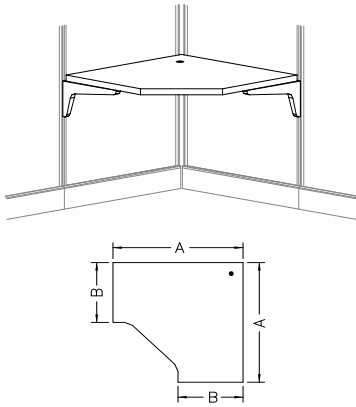

DESCRIPTION

Worksurface hangs from a panel or Wall Strips. It has a laminate top and a PVC edge. There is a 1" gap at the back of the worksurface for plug and cord passage. It has 24" D or 30" D connecting sides. Includes cantilever brackets, and attachment hardware.

NOTES

- Includes one wire grommet, cantilever brackets, one corner bracket, and attachment hardware.
- * Corners are angled (not available with notched front edge)

SPECIFICATION OPTIONS

product #: see charts below
top, edge finish: see page 5
support finish: LG Light Gray, MT Medium Tone, DT Dark Tone
worksurface finish: see page 5

ORDER EXAMPLE

product #: FSECCWS.2436L
top, edge finish: LG
support finish: DT
worksurface finish: 7909-60 Light Maple

90° NOTCHED CORNER

PART #	HEIGHT	A	B	C	D	WT. (LBS)	PRICE	NOTES
FSECWS.2436L	1.25"	36"*	24"	—	—	53	\$445	* Corners are angled (not available with notched front edge)
FSECWS.2442L	1.25"	42"	24"	—	—	72	\$562	
FSECWS.2448L	1.25"	48"	24"	—	—	83	\$585	
FSECWS.3036L	1.25"	36"*	30"	—	—	60	\$481	
FSECWS.3042L	1.25"	42"*	30"	—	—	74	\$598	
FSECWS.3048L	1.25"	48"	30"	—	—	85	\$621	

90° CURVED CORNER

PART #	HEIGHT	A	B	C	D	WT. (LBS)	PRICE
FSECCWS.2436L	1.25"	36"	24"	—	—	54	\$445
FSECCWS.2442L	1.25"	42"	24"	—	—	68	\$562
FSECCWS.2448L	1.25"	48"	24"	—	—	72	\$585
FSECCWS.3036L	1.25"	36"	30"	—	—	60	\$481
FSECCWS.3042L	1.25"	42"	30"	—	—	76	\$598
FSECCWS.3048L	1.25"	48"	30"	—	—	78	\$621

Square Edge Half Circle | Worksurface

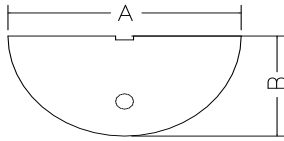
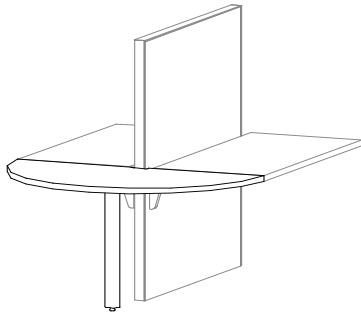

DESCRIPTION

This Half Circle Worksurface has a notch, and attaches to the end of two back to back Rectangular or Extended Corner Worksurfaces, and includes one Support Column Leg. It has a laminate top and a PVC edge.

NOTES

- Support Column Leg has a leveling glide and attaching hardware.
- Ships knocked down.
- Column leg finish: DT Dark Tone

SPECIFICATION OPTIONS

product #: see charts below
top, edge finish: see page 5
support finish: LG Light Gray, MT Medium Tone, DT Dark Tone
worksurface finish: see page 5

ORDER EXAMPLE

product #: FSEHCWS.50L
top, edge finish: LG
support finish: DT
worksurface finish: 7040A-60 Mahogany

SQUARE EDGE HALF CIRCLE

PART #	HEIGHT	A	B	C	D	WT. (LBS)	PRICE
FSEHCWS.50L	29"	52"	26"	—	—	55	\$657
FSEHCWS.60L	29"	64"	32"	—	—	67	\$742

Square Edge D-Shaped | Worksurface

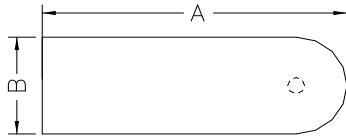
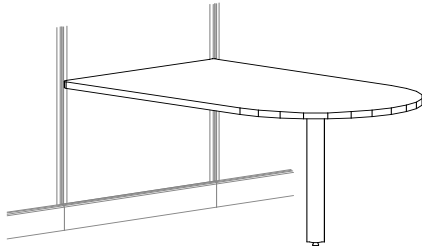

DESCRIPTION

Worksurface hangs from a panel or Wall Strips. It has a laminate top and a PVC edge. There is a 1" gap at the back of the worksurface for plug and cord passage. Includes one Support Column Leg.

NOTES

- Support Column Leg has a leveling glide and attaching hardware.
- Ships knocked down.
- Column leg finish: DT Dark Tone

SPECIFICATION OPTIONS

product #: see charts below
top, edge finish: see page 5
support finish: LG Light Gray, MT Medium Tone, DT Dark Tone
worksurface finish: see page 5

ORDER EXAMPLE

product #: FSEDSP2448L
top, edge finish: LG
support finish: DT
worksurface finish: 7040A-60 Mahogany

SQUARE EDGE HALF CIRCLE

PART #	HEIGHT	A	B	C	D	WT. (LBS)	PRICE
FSEDSP.2448L	29"	48"	24"	—	—	62	\$450
FSEDSP.3048L	29"	48"	30"	—	—	72	\$506
FSEDSP.2460L	29"	60"	24"	—	—	73	\$513
FSEDSP.3060L	29"	60"	30"	—	—	87	\$573
FSEDSP.3072L	29"	72"	30"	—	—	101	\$641
FSEDSP.3672L	29"	72"	36"	—	—	117	\$720

90° Extended Notched Corner | Worksurface

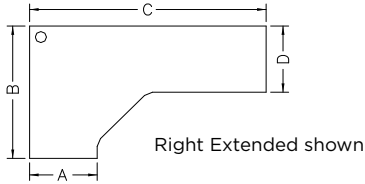
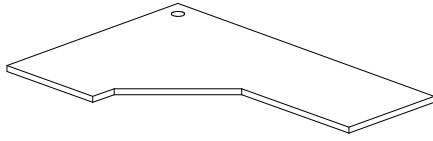

DESCRIPTION

Worksurface hangs from a panel or Wall Strips. It has a laminate top and a PVC edge. There is a 1" gap at the back of the worksurface for plug and cord passage. 60" to 84" worksurfaces have a center support.

NOTES

- Includes one wire grommet, cantilever brackets, one corner bracket, and attachment hardware.
- Specify L for left extended, and R for right extended.

When ordering a worksurface spanning a panel and a 3-Way or Spacer Connector, or two panels with a 3-Way or Spacer Connector in between the panels, you will need to:

- add 3.5" to the length of the worksurface
- add "-3W" to the part number
- add \$80 to the list price

example:

Two 30" Frames with one 3-Way Connector equals to 63.5". In this case, order FSENCWS.24366024L-3W (\$563 + \$80 = \$643)

SPECIFICATION OPTIONS

product #: see charts below
top, edge finish: see page 5
support finish: LG Light Gray, MT Medium Tone, DT Dark Tone
worksurface finish: see page 5
left or right extended: L for Left, R for Right

ORDER EXAMPLE

product #: FSENCWS.24366024R
top, edge finish: LG
support finish: DT
worksurface finish: 7040A-60 Mahogany
left or right extended: R

24" D CONNECTING SIDE 24" D EXTENSION 36" D

PART #	HEIGHT	A	B	C	D	WT. (LBS)	PRICE
FSENCWS.24366024L	1.25"	24"	36"	60"	24"	74	\$563
FSENCWS.24366024R	1.25"	24"	36"	60"	24"	74	\$563
FSENCWS.24366624L	1.25"	24"	36"	66"	24"	81	\$640
FSENCWS.24366624R	1.25"	24"	36"	66"	24"	81	\$640
FSENCWS.24367224L	1.25"	24"	36"	72"	24"	87	\$648
FSENCWS.24367224R	1.25"	24"	36"	72"	24"	87	\$648
FSENCWS.24367824L	1.25"	24"	36"	78"	24"	93	\$799
FSENCWS.24367824R	1.25"	24"	36"	78"	24"	93	\$799
FSENCWS.24368424L	1.25"	24"	36"	84"	24"	99	\$806
FSENCWS.24368424R	1.25"	24"	36"	84"	24"	99	\$806

**30" D CONNECTING SIDE
30" D EXTENSION
36" D**

PART #	HEIGHT	A	B	C	D	WT. (LBS)	PRICE
FSENCWS.30366030L	1.25"	30"	36"	60"	30"	88	\$602
FSENCWS.30366030R	1.25"	30"	36"	60"	30"	88	\$602
FSENCWS.30366630L	1.25"	30"	36"	66"	30"	95	\$679
FSENCWS.30366630R	1.25"	30"	36"	66"	30"	95	\$679
FSENCWS.30367230L	1.25"	30"	36"	72"	30"	102	\$687
FSENCWS.30367230R	1.25"	30"	36"	72"	30"	102	\$687
FSENCWS.30367830L	1.25"	30"	36"	78"	30"	110	\$838
FSENCWS.30367830R	1.25"	30"	36"	78"	30"	110	\$838
FSENCWS.30368430L	1.25"	30"	36"	84"	30"	117	\$845
FSENCWS.30368430R	1.25"	30"	36"	84"	30"	117	\$845

**24" D CONNECTING SIDE
24" D EXTENSION
42" D**

PART #	HEIGHT	A	B	C	D	WT. (LBS)	PRICE
FSENCWS.24426024L	1.25"	24"	42"	60"	24"	84	\$696
FSENCWS.24426024R	1.25"	24"	42"	60"	24"	84	\$696
FSENCWS.24426624L	1.25"	24"	42"	66"	24"	91	\$798
FSENCWS.24426624R	1.25"	24"	42"	66"	24"	91	\$798
FSENCWS.24427224L	1.25"	24"	42"	72"	24"	97	\$806
FSENCWS.24427224R	1.25"	24"	42"	72"	24"	97	\$806
FSENCWS.24427824L	1.25"	24"	42"	78"	24"	103	\$1,005
FSENCWS.24427824R	1.25"	24"	42"	78"	24"	103	\$1,005
FSENCWS.24428424L	1.25"	24"	42"	84"	24"	109	\$1,013
FSENCWS.24428424R	1.25"	24"	42"	84"	24"	109	\$1,013

**30" D CONNECTING SIDE
30" D EXTENSION
42" D**

PART #	HEIGHT	A	B	C	D	WT. (LBS)	PRICE
FSENCWS.30426030L	1.25"	30"	42"	60"	30"	98	\$736
FSENCWS.30426030R	1.25"	30"	42"	60"	30"	98	\$736
FSENCWS.30426630L	1.25"	30"	42"	66"	30"	106	\$837
FSENCWS.30426630R	1.25"	30"	42"	66"	30"	106	\$837
FSENCWS.30427230L	1.25"	30"	42"	72"	30"	112	\$845
FSENCWS.30427230R	1.25"	30"	42"	72"	30"	112	\$845
FSENCWS.30427830L	1.25"	30"	42"	78"	30"	122	\$1,044
FSENCWS.30427830R	1.25"	30"	42"	78"	30"	122	\$1,044
FSENCWS.30428430L	1.25"	30"	42"	84"	30"	127	\$1,053
FSENCWS.30428430R	1.25"	30"	42"	84"	30"	127	\$1,053

90° Extended Notched Corner | Worksurface (cont'd)

24" D CONNECTING SIDE 24" D EXTENSION 48" D

PART #	HEIGHT	A	B	C	D	WT. (LBS)	PRICE
FSENCWS.24486024L	1.25"	24"	48"	60"	24"	93	\$704
FSENCWS.24486024R	1.25"	24"	48"	60"	24"	93	\$704
FSENCWS.24486624L	1.25"	24"	48"	66"	24"	99	\$806
FSENCWS.24486624R	1.25"	24"	48"	66"	24"	99	\$806
FSENCWS.24487224L	1.25"	24"	48"	72"	24"	104	\$819
FSENCWS.24487224R	1.25"	24"	48"	72"	24"	104	\$819
FSENCWS.24487824L	1.25"	24"	48"	78"	24"	110	\$1,025
FSENCWS.24487824R	1.25"	24"	48"	78"	24"	110	\$1,025
FSENCWS.24488424L	1.25"	24"	48"	84"	24"	116	\$1,028
FSENCWS.24488424R	1.25"	24"	48"	84"	24"	116	\$1,028

30" D CONNECTING SIDE 30" D EXTENSION 48" D

PART #	HEIGHT	A	B	C	D	WT. (LBS)	PRICE
FSENCWS.30486030L	1.25"	30"	48"	60"	30"	108	\$743
FSENCWS.30486030R	1.25"	30"	48"	60"	30"	108	\$743
FSENCWS.30486630L	1.25"	30"	48"	66"	30"	116	\$845
FSENCWS.30486630R	1.25"	30"	48"	66"	30"	116	\$845
FSENCWS.30487230L	1.25"	30"	48"	72"	30"	123	\$859
FSENCWS.30487230R	1.25"	30"	48"	72"	30"	123	\$859
FSENCWS.30487830L	1.25"	30"	48"	78"	30"	134	\$1,064
FSENCWS.30487830R	1.25"	30"	48"	78"	30"	134	\$1,064
FSENCWS.30488430L	1.25"	30"	48"	84"	30"	146	\$1,067
FSENCWS.30488430R	1.25"	30"	48"	84"	30"	146	\$1,067

90° Extended Curved Corner | Worksurface

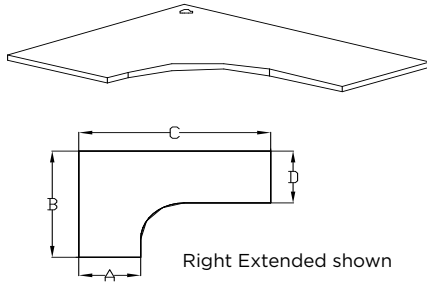

DESCRIPTION

Worksurface hangs from a panel or Wall Strips. It has a laminate top and a PVC edge. There is a 1" gap at the back of the worksurface for plug and cord passage. 60" to 84" worksurfaces have a center support.

NOTES

- Includes one wire grommet, cantilever brackets, one corner bracket, and attachment hardware.
- Specify L for left extended, and R for right extended.

When ordering a worksurface spanning a panel and a 3-Way or Spacer Connector, or two panels with a 3-Way or Spacer Connector in between the panels, you will need to:

- add 3.5" to the length of the worksurface
- add "-3W" to the part number
- add \$80 to the list price

example:

Two 30" Frames with one 3-Way Connector equals to 63.5". In this case, order FSECCWS.24366024L-3W (\$563 + \$80 = \$643)

SPECIFICATION OPTIONS

product #: see charts below
top, edge finish: see page 5
support finish: LG Light Gray, MT Medium Tone, DT Dark Tone
worksurface finish: see page 5
left or right extended: L for Left, R for Right

ORDER EXAMPLE

product #: FSECCWS.24366024R
top, edge finish: LG
support finish: DT
worksurface finish: 7040A-60 Mahogany
left or right extended: R

24" D CONNECTING SIDE
24" D EXTENSION
36" D

PART #	HEIGHT	A	B	C	D	WT. (LBS)	PRICE
FSECCWS.24366024L	1.25"	24"	36"	60"	24"	76	\$563
FSECCWS.24366024R	1.25"	24"	36"	60"	24"	76	\$563
FSECCWS.24366624L	1.25"	24"	36"	66"	24"	82	\$640
FSECCWS.24366624R	1.25"	24"	36"	66"	24"	82	\$640
FSECCWS.24367224L	1.25"	24"	36"	72"	24"	88	\$648
FSECCWS.24367224R	1.25"	24"	36"	72"	24"	88	\$648
FSECCWS.24367824L	1.25"	24"	36"	78"	24"	94	\$799
FSECCWS.24367824R	1.25"	24"	36"	78"	24"	94	\$799
FSECCWS.24368424L	1.25"	24"	36"	84"	24"	100	\$806
FSECCWS.24368424R	1.25"	24"	36"	84"	24"	100	\$806

90° Extended Curved Corner | Worksurface (cont'd)

30" D CONNECTING SIDE 30" D EXTENSION 36" D

PART #	HEIGHT	A	B	C	D	WT. (LBS)	PRICE
FSECCWS.30366030L	1.25"	30"	36"	60"	30"	87	\$602
FSECCWS.30366030R	1.25"	30"	36"	60"	30"	87	\$602
FSECCWS.30366630L	1.25"	30"	36"	66"	30"	95	\$679
FSECCWS.30366630R	1.25"	30"	36"	66"	30"	95	\$679
FSECCWS.30367230L	1.25"	30"	36"	72"	30"	102	\$687
FSECCWS.30367230R	1.25"	30"	36"	72"	30"	102	\$687
FSECCWS.30367830L	1.25"	30"	36"	78"	30"	110	\$838
FSECCWS.30367830R	1.25"	30"	36"	78"	30"	110	\$838
FSECCWS.30368430L	1.25"	30"	36"	84"	30"	117	\$845
FSECCWS.30368430R	1.25"	30"	36"	84"	30"	117	\$845

24" D CONNECTING SIDE 24" D EXTENSION 42" D

PART #	HEIGHT	A	B	C	D	WT. (LBS)	PRICE
FSECCWS.24426024L	1.25"	24"	42"	60"	24"	83	\$696
FSECCWS.24426024R	1.25"	24"	42"	60"	24"	83	\$696
FSECCWS.24426624L	1.25"	24"	42"	66"	24"	89	\$798
FSECCWS.24426624R	1.25"	24"	42"	66"	24"	89	\$798
FSECCWS.24427224L	1.25"	24"	42"	72"	24"	95	\$806
FSECCWS.24427224R	1.25"	24"	42"	72"	24"	95	\$806
FSECCWS.24427824L	1.25"	24"	42"	78"	24"	101	\$1,005
FSECCWS.24427824R	1.25"	24"	42"	78"	24"	101	\$1,005
FSECCWS.24428424L	1.25"	24"	42"	84"	24"	106	\$1,013
FSECCWS.24428424R	1.25"	24"	42"	84"	24"	106	\$1,013

30" D CONNECTING SIDE 30" D EXTENSION 42" D

PART #	HEIGHT	A	B	C	D	WT. (LBS)	PRICE
FSECCWS.30426030L	1.25"	30"	42"	60"	30"	95	\$736
FSECCWS.30426030R	1.25"	30"	42"	60"	30"	95	\$736
FSECCWS.30426630L	1.25"	30"	42"	66"	30"	103	\$837
FSECCWS.30426630R	1.25"	30"	42"	66"	30"	103	\$837
FSECCWS.30427230L	1.25"	30"	42"	72"	30"	110	\$845
FSECCWS.30427230R	1.25"	30"	42"	72"	30"	110	\$845
FSECCWS.30427830L	1.25"	30"	42"	78"	30"	118	\$1,044
FSECCWS.30427830R	1.25"	30"	42"	78"	30"	118	\$1,044
FSECCWS.30428430L	1.25"	30"	42"	84"	30"	125	\$1,053
FSECCWS.30428430R	1.25"	30"	42"	84"	30"	125	\$1,053

**24" D CONNECTING SIDE
24" D EXTENSION
48" D**

PART #	HEIGHT	A	B	C	D	WT. (LBS)	PRICE
FSECCWS.24486024L	1.25"	24"	48"	60"	24"	89	\$704
FSECCWS.24486024R	1.25"	24"	48"	60"	24"	89	\$704
FSECCWS.24486624L	1.25"	24"	48"	66"	24"	95	\$806
FSECCWS.24486624R	1.25"	24"	48"	66"	24"	95	\$806
FSECCWS.24487224L	1.25"	24"	48"	72"	24"	101	\$819
FSECCWS.24487224R	1.25"	24"	48"	72"	24"	101	\$819
FSECCWS.24487824L	1.25"	24"	48"	78"	24"	107	\$1,025
FSECCWS.24487824R	1.25"	24"	48"	78"	24"	107	\$1,025
FSECCWS.24488424L	1.25"	24"	48"	84"	24"	112	\$1,028
FSECCWS.24488424R	1.25"	24"	48"	84"	24"	112	\$1,028

**30" D CONNECTING SIDE
30" D EXTENSION
48" D**

PART #	HEIGHT	A	B	C	D	WT. (LBS)	PRICE
FSECCWS.30486030L	1.25"	30"	48"	60"	30"	104	\$743
FSECCWS.30486030R	1.25"	30"	48"	60"	30"	104	\$743
FSECCWS.30486630L	1.25"	30"	48"	66"	30"	112	\$845
FSECCWS.30486630R	1.25"	30"	48"	66"	30"	112	\$845
FSECCWS.30487230L	1.25"	30"	48"	72"	30"	119	\$859
FSECCWS.30487230R	1.25"	30"	48"	72"	30"	119	\$859
FSECCWS.30487830L	1.25"	30"	48"	78"	30"	126	\$1,064
FSECCWS.30487830R	1.25"	30"	48"	78"	30"	126	\$1,064
FSECCWS.30488430L	1.25"	30"	48"	84"	30"	133	\$1,067
FSECCWS.30488430R	1.25"	30"	48"	84"	30"	133	\$1,067

90° Extended Notched Corner | Peninsula Worksurface

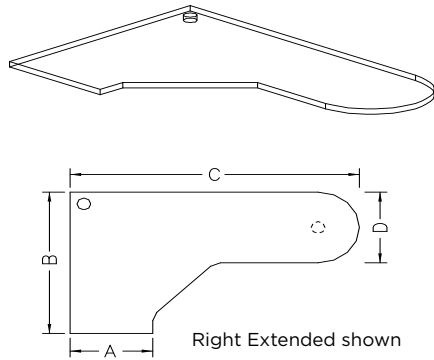

DESCRIPTION

Worksurface hangs from a panel or Wall Strips. It has a laminate top and a PVC edge. There is a 1" gap at the back of the worksurface for plug and cord passage.

NOTES

- Includes one wire grommet, cantilever brackets, one corner bracket, and attachment hardware.
- Specify L for left extended, and R for right extended.
- Includes one Support Column Leg.
- Column Leg Finish: DT Dark Tone.

SPECIFICATION OPTIONS

product #: see charts below
top, edge finish: see page 5
support finish: LG Light Gray, MT Medium Tone, DT Dark Tone
worksurface finish: see page 5
left or right extended: L for Left, R for Right

ORDER EXAMPLE

product #: FSENC PWS.24366024R
top, edge finish: LG
support finish: DT
worksurface finish: 7040A-60 Mahogany
left or right extended: R

**24" D CONNECTING SIDE
 24" D EXTENSION
 36" D**

PART #	HEIGHT	A	B	C	D	WT. (LBS)	PRICE
FSENC PWS.24366024L	1.25"	24"	36"	60"	24"	89	\$719
FSENC PWS.24366024R	1.25"	24"	36"	60"	24"	89	\$719
FSENC PWS.24366624L	1.25"	24"	36"	66"	24"	95	\$803
FSENC PWS.24366624R	1.25"	24"	36"	66"	24"	95	\$803
FSENC PWS.24367224L	1.25"	24"	36"	72"	24"	101	\$817
FSENC PWS.24367224R	1.25"	24"	36"	72"	24"	101	\$817
FSENC PWS.24367824L	1.25"	24"	36"	78"	24"	107	\$978
FSENC PWS.24367824R	1.25"	24"	36"	78"	24"	107	\$978
FSENC PWS.24368424L	1.25"	24"	36"	84"	24"	112	\$993
FSENC PWS.24368424R	1.25"	24"	36"	84"	24"	112	\$993

**24" D CONNECTING SIDE
 24" D EXTENSION
 42" D**

PART #	HEIGHT	A	B	C	D	WT. (LBS)	PRICE
FSENC PWS.24426024L	1.25"	24"	42"	60"	24"	97	\$845
FSENC PWS.24426024R	1.25"	24"	42"	60"	24"	97	\$845
FSENC PWS.24426624L	1.25"	24"	42"	66"	24"	103	\$954
FSENC PWS.24426624R	1.25"	24"	42"	66"	24"	103	\$954
FSENC PWS.24427224L	1.25"	24"	42"	72"	24"	109	\$968
FSENC PWS.24427224R	1.25"	24"	42"	72"	24"	109	\$968
FSENC PWS.24427824L	1.25"	24"	42"	78"	24"	114	\$1,202
FSENC PWS.24427824R	1.25"	24"	42"	78"	24"	114	\$1,202
FSENC PWS.24428424L	1.25"	24"	42"	84"	24"	120	\$1,206
FSENC PWS.24428424R	1.25"	24"	42"	84"	24"	120	\$1,206

**24" D CONNECTING SIDE
24" D EXTENSION
48" D**

PART #	HEIGHT	A	B	C	D	WT. (LBS)	PRICE
FSENC PWS.24486024L	1.25"	24"	48"	60"	24"	104	\$848
FSENC PWS.24486024R	1.25"	24"	48"	60"	24"	104	\$848
FSENC PWS.24486624L	1.25"	24"	48"	66"	24"	110	\$958
FSENC PWS.24486624R	1.25"	24"	48"	66"	24"	110	\$958
FSENC PWS.24487224L	1.25"	24"	48"	72"	24"	116	\$971
FSENC PWS.24487224R	1.25"	24"	48"	72"	24"	116	\$971
FSENC PWS.24487824L	1.25"	24"	48"	78"	24"	121	\$1,206
FSENC PWS.24487824R	1.25"	24"	48"	78"	24"	121	\$1,206
FSENC PWS.24488424L	1.25"	24"	48"	84"	24"	127	\$1,209
FSENC PWS.24488424R	1.25"	24"	48"	84"	24"	127	\$1,209

**24" D CONNECTING SIDE
30" D EXTENSION
36" D**

PART #	HEIGHT	A	B	C	D	WT. (LBS)	PRICE
FSENC PWS.24366030L	1.25"	24"	36"	60"	30"	94	\$719
FSENC PWS.24366030R	1.25"	24"	36"	60"	30"	94	\$719
FSENC PWS.24366630L	1.25"	24"	36"	66"	30"	102	\$803
FSENC PWS.24366630R	1.25"	24"	36"	66"	30"	102	\$803
FSENC PWS.24367230L	1.25"	24"	36"	72"	30"	109	\$817
FSENC PWS.24367230R	1.25"	24"	36"	72"	30"	109	\$817
FSENC PWS.24367830L	1.25"	24"	36"	78"	30"	116	\$978
FSENC PWS.24367830R	1.25"	24"	36"	78"	30"	116	\$978
FSENC PWS.24368430L	1.25"	24"	36"	84"	30"	123	\$993
FSENC PWS.24368430R	1.25"	24"	36"	84"	30"	123	\$993

90° Extended Notched Corner | Peninsula Worksurface (cont'd)

24" D CONNECTING SIDE 30" D EXTENSION 42" D

PART #	HEIGHT	A	B	C	D	WT. (LBS)	PRICE
FSENC PWS.24426030L	1.25"	24"	42"	60"	30"	102	\$845
FSENC PWS.24426030R	1.25"	24"	42"	60"	30"	102	\$845
FSENC PWS.24426630L	1.25"	24"	42"	66"	30"	110	\$954
FSENC PWS.24426630R	1.25"	24"	42"	66"	30"	110	\$954
FSENC PWS.24427230L	1.25"	24"	42"	72"	30"	117	\$968
FSENC PWS.24427230R	1.25"	24"	42"	72"	30"	117	\$968
FSENC PWS.24427830L	1.25"	24"	42"	78"	30"	124	\$1,202
FSENC PWS.24427830R	1.25"	24"	42"	78"	30"	124	\$1,202
FSENC PWS.24428430L	1.25"	24"	42"	84"	30"	131	\$1,206
FSENC PWS.24428430R	1.25"	24"	42"	84"	30"	131	\$1,206

24" D CONNECTING SIDE 30" D EXTENSION 48" D

PART #	HEIGHT	A	B	C	D	WT. (LBS)	PRICE
FSENC PWS.24486030L	1.25"	24"	48"	60"	30"	111	\$848
FSENC PWS.24486030R	1.25"	24"	48"	60"	30"	111	\$848
FSENC PWS.24486630L	1.25"	24"	48"	66"	30"	119	\$958
FSENC PWS.24486630R	1.25"	24"	48"	66"	30"	119	\$958
FSENC PWS.24487230L	1.25"	24"	48"	72"	30"	126	\$971
FSENC PWS.24487230R	1.25"	24"	48"	72"	30"	126	\$971
FSENC PWS.24487830L	1.25"	24"	48"	78"	30"	133	\$1,206
FSENC PWS.24487830R	1.25"	24"	48"	78"	30"	133	\$1,206
FSENC PWS.24488430L	1.25"	24"	48"	84"	30"	140	\$1,209
FSENC PWS.24488430R	1.25"	24"	48"	84"	30"	140	\$1,209

30" D CONNECTING SIDE 30" D EXTENSION 36" D

PART #	HEIGHT	A	B	C	D	WT. (LBS)	PRICE
FSENC PWS.30366030L	1.25"	30"	36"	60"	30"	95	\$758
FSENC PWS.30366030R	1.25"	30"	36"	60"	30"	95	\$758
FSENC PWS.30366630L	1.25"	30"	36"	66"	30"	103	\$843
FSENC PWS.30366630R	1.25"	30"	36"	66"	30"	103	\$843
FSENC PWS.30367230L	1.25"	30"	36"	72"	30"	110	\$856
FSENC PWS.30367230R	1.25"	30"	36"	72"	30"	110	\$856
FSENC PWS.30367830L	1.25"	30"	36"	78"	30"	118	\$1,018
FSENC PWS.30367830R	1.25"	30"	36"	78"	30"	118	\$1,018
FSENC PWS.30368430L	1.25"	30"	36"	84"	30"	125	\$1,032
FSENC PWS.30368430R	1.25"	30"	36"	84"	30"	125	\$1,032

**30" D CONNECTING SIDE
30" D EXTENSION
42" D**

PART #	HEIGHT	A	B	C	D	WT. (LBS)	PRICE
FSENCPWS.30426030L	1.25"	30"	42"	60"	30"	106	\$884
FSENCPWS.30426030R	1.25"	30"	42"	60"	30"	106	\$884
FSENCPWS.30426630L	1.25"	30"	42"	66"	30"	114	\$993
FSENCPWS.30426630R	1.25"	30"	42"	66"	30"	114	\$993
FSENCPWS.30427230L	1.25"	30"	42"	72"	30"	121	\$1,007
FSENCPWS.30427230R	1.25"	30"	42"	72"	30"	121	\$1,007
FSENCPWS.30427830L	1.25"	30"	42"	78"	30"	128	\$1,217
FSENCPWS.30427830R	1.25"	30"	42"	78"	30"	128	\$1,217
FSENCPWS.30428430L	1.25"	30"	42"	84"	30"	135	\$1,232
FSENCPWS.30428430R	1.25"	30"	42"	84"	30"	135	\$1,232

**30" D CONNECTING SIDE
30" D EXTENSION
48" D**

PART #	HEIGHT	A	B	C	D	WT. (LBS)	PRICE
FSENCPWS.30486030L	1.25"	30"	48"	60"	30"	116	\$887
FSENCPWS.30486030R	1.25"	30"	48"	60"	30"	116	\$887
FSENCPWS.30486630L	1.25"	30"	48"	66"	30"	124	\$997
FSENCPWS.30486630R	1.25"	30"	48"	66"	30"	124	\$997
FSENCPWS.30487230L	1.25"	30"	48"	72"	30"	131	\$1,010
FSENCPWS.30487230R	1.25"	30"	48"	72"	30"	131	\$1,010
FSENCPWS.30487830L	1.25"	30"	48"	78"	30"	138	\$1,220
FSENCPWS.30487830R	1.25"	30"	48"	78"	30"	138	\$1,220
FSENCPWS.30488430L	1.25"	30"	48"	84"	30"	144	\$1,236
FSENCPWS.30488430R	1.25"	30"	48"	84"	30"	144	\$1,236

Extended Curved Corner | Peninsula Worksurface

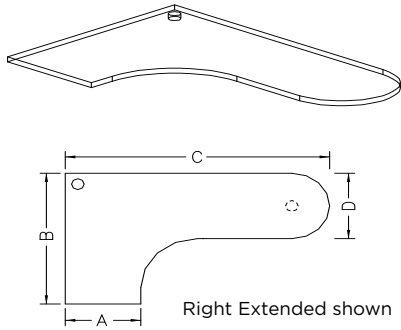

DESCRIPTION

Worksurface hangs from a panel or Wall Strips. It has a laminate top and a PVC edge. There is a 1" gap at the back of the worksurface for plug and cord passage.

NOTES

- Includes one wire grommet, cantilever brackets, one corner bracket, and attachment hardware.
- Specify L for left extended, and R for right extended.
- Includes one Support Column Leg.
- Column Leg Finish: DT Dark Tone.

SPECIFICATION OPTIONS

product #: see charts below
top, edge finish: see page 5
support finish: LG Light Gray, MT Medium Tone, DT Dark Tone
worksurface finish: see page 5
left or right extended: L for Left, R for Right

ORDER EXAMPLE

product #: FSECCPWS.24366024L
top, edge finish: LG
support finish: DT
worksurface finish: 7040A-60 Mahogany
left or right extended: L

**24" D CONNECTING SIDE
 24" D EXTENSION
 36" D**

PART #	HEIGHT	A	B	C	D	WT. (LBS)	PRICE
FSECCPWS.24366024L	1.25"	24"	36"	60"	24"	87	\$719
FSECCPWS.24366024R	1.25"	24"	36"	60"	24"	87	\$719
FSECCPWS.24366624L	1.25"	24"	36"	66"	24"	93	\$803
FSECCPWS.24366624R	1.25"	24"	36"	66"	24"	93	\$803
FSECCPWS.24367224L	1.25"	24"	36"	72"	24"	99	\$817
FSECCPWS.24367224R	1.25"	24"	36"	72"	24"	99	\$817
FSECCPWS.24367824L	1.25"	24"	36"	78"	24"	105	\$978
FSECCPWS.24367824R	1.25"	24"	36"	78"	24"	105	\$978
FSECCPWS.24368424L	1.25"	24"	36"	84"	24"	110	\$993
FSECCPWS.24368424R	1.25"	24"	36"	84"	24"	110	\$993

**24" D CONNECTING SIDE
 24" D EXTENSION
 42" D**

PART #	HEIGHT	A	B	C	D	WT. (LBS)	PRICE
FSECCPWS.24426024L	1.25"	24"	42"	60"	24"	94	\$845
FSECCPWS.24426024R	1.25"	24"	42"	60"	24"	94	\$845
FSECCPWS.24426624L	1.25"	24"	42"	66"	24"	100	\$954
FSECCPWS.24426624R	1.25"	24"	42"	66"	24"	100	\$954
FSECCPWS.24427224L	1.25"	24"	42"	72"	24"	106	\$968
FSECCPWS.24427224R	1.25"	24"	42"	72"	24"	106	\$968
FSECCPWS.24427824L	1.25"	24"	42"	78"	24"	111	\$1,202
FSECCPWS.24427824R	1.25"	24"	42"	78"	24"	111	\$1,202
FSECCPWS.24428424L	1.25"	24"	42"	84"	24"	116	\$1,206
FSECCPWS.24428424R	1.25"	24"	42"	84"	24"	116	\$1,206

**24" D CONNECTING SIDE
24" D EXTENSION
48" D**

PART #	HEIGHT	A	B	C	D	WT. (LBS)	PRICE
FSECCPWS.24486024L	1.25"	24"	48"	60"	24"	101	\$848
FSECCPWS.24486024R	1.25"	24"	48"	60"	24"	101	\$848
FSECCPWS.24486624L	1.25"	24"	48"	66"	24"	107	\$958
FSECCPWS.24486624R	1.25"	24"	48"	66"	24"	107	\$958
FSECCPWS.24487224L	1.25"	24"	48"	72"	24"	112	\$971
FSECCPWS.24487224R	1.25"	24"	48"	72"	24"	112	\$971
FSECCPWS.24487824L	1.25"	24"	48"	78"	24"	118	\$1,206
FSECCPWS.24487824R	1.25"	24"	48"	78"	24"	118	\$1,206
FSECCPWS.24488424L	1.25"	24"	48"	84"	24"	124	\$1,209
FSECCPWS.24488424R	1.25"	24"	48"	84"	24"	124	\$1,209

**24" D CONNECTING SIDE
30" D EXTENSION
36" D**

PART #	HEIGHT	A	B	C	D	WT. (LBS)	PRICE
FSECCPWS.24366030L	1.25"	24"	36"	60"	30"	94	\$719
FSECCPWS.24366030R	1.25"	24"	36"	60"	30"	94	\$719
FSECCPWS.24366630L	1.25"	24"	36"	66"	30"	101	\$803
FSECCPWS.24366630R	1.25"	24"	36"	66"	30"	101	\$803
FSECCPWS.24367230L	1.25"	24"	36"	72"	30"	108	\$817
FSECCPWS.24367230R	1.25"	24"	36"	72"	30"	108	\$817
FSECCPWS.24367830L	1.25"	24"	36"	78"	30"	115	\$978
FSECCPWS.24367830R	1.25"	24"	36"	78"	30"	115	\$978
FSECCPWS.24368430L	1.25"	24"	36"	84"	30"	123	\$993
FSECCPWS.24368430R	1.25"	24"	36"	84"	30"	123	\$993

Extended Curved Corner | Peninsula Worksurface (cont'd)

24" D CONNECTING SIDE 30" D EXTENSION 42" D

PART #	HEIGHT	A	B	C	D	WT. (LBS)	PRICE
FSECCPWS.24426030L	1.25"	24"	42"	60"	30"	100	\$845
FSECCPWS.24426030R	1.25"	24"	42"	60"	30"	100	\$845
FSECCPWS.24426630L	1.25"	24"	42"	66"	30"	107	\$954
FSECCPWS.24426630R	1.25"	24"	42"	66"	30"	107	\$954
FSECCPWS.24427230L	1.25"	24"	42"	72"	30"	113	\$968
FSECCPWS.24427230R	1.25"	24"	42"	72"	30"	113	\$968
FSECCPWS.24427830L	1.25"	24"	42"	78"	30"	120	\$1,202
FSECCPWS.24427830R	1.25"	24"	42"	78"	30"	120	\$1,202
FSECCPWS.24428430L	1.25"	24"	42"	84"	30"	126	\$1,206
FSECCPWS.24428430R	1.25"	24"	42"	84"	30"	126	\$1,206

24" D CONNECTING SIDE 30" D EXTENSION 48" D

PART #	HEIGHT	A	B	C	D	WT. (LBS)	PRICE
FSECCPWS.24486030L	1.25"	24"	48"	60"	30"	107	\$848
FSECCPWS.24486030R	1.25"	24"	48"	60"	30"	107	\$848
FSECCPWS.24486630L	1.25"	24"	48"	66"	30"	113	\$958
FSECCPWS.24486630R	1.25"	24"	48"	66"	30"	113	\$958
FSECCPWS.24487230L	1.25"	24"	48"	72"	30"	118	\$971
FSECCPWS.24487230R	1.25"	24"	48"	72"	30"	118	\$971
FSECCPWS.24487830L	1.25"	24"	48"	78"	30"	124	\$1,206
FSECCPWS.24487830R	1.25"	24"	48"	78"	30"	124	\$1,206
FSECCPWS.24488430L	1.25"	24"	48"	84"	30"	129	\$1,209
FSECCPWS.24488430R	1.25"	24"	48"	84"	30"	129	\$1,209

30" D CONNECTING SIDE 30" D EXTENSION 36" D

PART #	HEIGHT	A	B	C	D	WT. (LBS)	PRICE
FSECCPWS.30366030L	1.25"	30"	36"	60"	30"	95	\$758
FSECCPWS.30366030R	1.25"	30"	36"	60"	30"	95	\$758
FSECCPWS.30366630L	1.25"	30"	36"	66"	30"	103	\$843
FSECCPWS.30366630R	1.25"	30"	36"	66"	30"	103	\$843
FSECCPWS.30367230L	1.25"	30"	36"	72"	30"	110	\$856
FSECCPWS.30367230R	1.25"	30"	36"	72"	30"	110	\$856
FSECCPWS.30367830L	1.25"	30"	36"	78"	30"	117	\$1,018
FSECCPWS.30367830R	1.25"	30"	36"	78"	30"	117	\$1,018
FSECCPWS.30368430L	1.25"	30"	36"	84"	30"	124	\$1,032
FSECCPWS.30368430R	1.25"	30"	36"	84"	30"	124	\$1,032

**30" D CONNECTING SIDE
30" D EXTENSION
42" D**

PART #	HEIGHT	A	B	C	D	WT. (LBS)	PRICE
FSECCPWS.30426030L	1.25"	30"	42"	60"	30"	101	\$884
FSECCPWS.30426030R	1.25"	30"	42"	60"	30"	101	\$884
FSECCPWS.30426630L	1.25"	30"	42"	66"	30"	108	\$993
FSECCPWS.30426630R	1.25"	30"	42"	66"	30"	108	\$993
FSECCPWS.30427230L	1.25"	30"	42"	72"	30"	114	\$1,007
FSECCPWS.30427230R	1.25"	30"	42"	72"	30"	114	\$1,007
FSECCPWS.30427830L	1.25"	30"	42"	78"	30"	120	\$1,217
FSECCPWS.30427830R	1.25"	30"	42"	78"	30"	120	\$1,217
FSECCPWS.30428430L	1.25"	30"	42"	84"	30"	127	\$1,232
FSECCPWS.30428430R	1.25"	30"	42"	84"	30"	127	\$1,232

**30" D CONNECTING SIDE
30" D EXTENSION
48" D**

PART #	HEIGHT	A	B	C	D	WT. (LBS)	PRICE
FSECCPWS.30486030L	1.25"	30"	48"	60"	30"	107	\$887
FSECCPWS.30486030R	1.25"	30"	48"	60"	30"	107	\$887
FSECCPWS.30486630L	1.25"	30"	48"	66"	30"	113	\$997
FSECCPWS.30486630R	1.25"	30"	48"	66"	30"	113	\$997
FSECCPWS.30487230L	1.25"	30"	48"	72"	30"	118	\$1,010
FSECCPWS.30487230R	1.25"	30"	48"	72"	30"	118	\$1,010
FSECCPWS.30487830L	1.25"	30"	48"	78"	30"	124	\$1,220
FSECCPWS.30487830R	1.25"	30"	48"	78"	30"	124	\$1,220
FSECCPWS.30488430L	1.25"	30"	48"	84"	30"	129	\$1,236
FSECCPWS.30488430R	1.25"	30"	48"	84"	30"	129	\$1,236

Extended Curved Corner | P-Shape Peninsula Worksurface

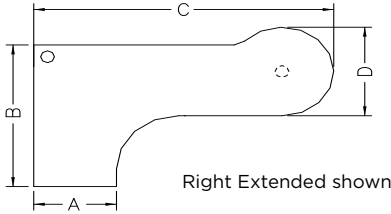
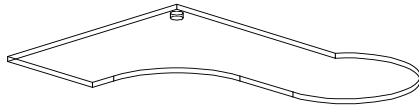

DESCRIPTION

Worksurface hangs from a panel or Wall Strips. It has a laminate top and a PVC edge. There is a 1" gap at the back of the worksurface for plug and cord passage.

NOTES

- Includes one wire grommet, cantilever brackets, one corner bracket, and attachment hardware.
- Specify L for left extended, and R for right extended.
- Includes one Support Column Leg.
- Column Leg Finish: DT Dark Tone.

SPECIFICATION OPTIONS

product #: see charts below
top, edge finish: see page 5
support finish: LG Light Gray, MT Medium Tone, DT Dark Tone
worksurface finish: see page 5
left or right extended: L for Left, R for Right

ORDER EXAMPLE

product #: FSECCPPWS.24426024R
top, edge finish: LG
support finish: DT
worksurface finish: 7040A-60 Mahogany
left or right extended: R

24" D CONNECTING SIDES
42" D

PART #	HEIGHT	A	B	C	D	WT. (LBS)	PRICE
FSECCPPWS.24426024L	1.25"	24"	42"	60"	36"	105	\$897
FSECCPPWS.24426024R	1.25"	24"	42"	60"	36"	105	\$897
FSECCPPWS.24426624L	1.25"	24"	42"	66"	36"	112	\$1,010
FSECCPPWS.24426624R	1.25"	24"	42"	66"	36"	112	\$1,010
FSECCPPWS.24427224L	1.25"	24"	42"	72"	36"	119	\$1,027
FSECCPPWS.24427224R	1.25"	24"	42"	72"	36"	119	\$1,027
FSECCPPWS.24427824L	1.25"	24"	42"	78"	36"	126	\$1,242
FSECCPPWS.24427824R	1.25"	24"	42"	78"	36"	126	\$1,242
FSECCPPWS.24428424L	1.25"	24"	42"	84"	36"	134	\$1,264
FSECCPPWS.24428424R	1.25"	24"	42"	84"	36"	134	\$1,264

24" D CONNECTING SIDES
48" D

PART #	HEIGHT	A	B	C	D	WT. (LBS)	PRICE
FSECCPPWS.24486024L	1.25"	24"	48"	60"	36"	113	\$1,023
FSECCPPWS.24486024R	1.25"	24"	48"	60"	36"	113	\$1,023
FSECCPPWS.24486624L	1.25"	24"	48"	66"	36"	120	\$1,161
FSECCPPWS.24486624R	1.25"	24"	48"	66"	36"	120	\$1,161
FSECCPPWS.24487224L	1.25"	24"	48"	72"	36"	127	\$1,178
FSECCPPWS.24487224R	1.25"	24"	48"	72"	36"	127	\$1,178
FSECCPPWS.24487824L	1.25"	24"	48"	78"	36"	134	\$1,442
FSECCPPWS.24487824R	1.25"	24"	48"	78"	36"	134	\$1,442
FSECCPPWS.24488424L	1.25"	24"	48"	84"	36"	141	\$1,463
FSECCPPWS.24488424R	1.25"	24"	48"	84"	36"	141	\$1,463

30" D CONNECTING SIDES
42" D

PART #	HEIGHT	A	B	C	D	WT. (LBS)	PRICE
FSECCPPWS.30426030L	1.25"	30"	42"	60"	36"	109	\$936
FSECCPPWS.30426030R	1.25"	30"	42"	60"	36"	109	\$936
FSECCPPWS.30426630L	1.25"	30"	42"	66"	36"	116	\$1,049
FSECCPPWS.30426630R	1.25"	30"	42"	66"	36"	116	\$1,049
FSECCPPWS.30427230L	1.25"	30"	42"	72"	36"	123	\$1,066
FSECCPPWS.30427230R	1.25"	30"	42"	72"	36"	123	\$1,066
FSECCPPWS.30427830L	1.25"	30"	42"	78"	36"	131	\$1,282
FSECCPPWS.30427830R	1.25"	30"	42"	78"	36"	131	\$1,282
FSECCPPWS.30428430L	1.25"	30"	42"	84"	36"	138	\$1,303
FSECCPPWS.30428430R	1.25"	30"	42"	84"	36"	138	\$1,303

30" D CONNECTING SIDES
48" D

PART #	HEIGHT	A	B	C	D	WT. (LBS)	PRICE
FSECCPPWS.30486030L	1.25"	30"	48"	60"	36"	116	\$1,062
FSECCPPWS.30486030R	1.25"	30"	48"	60"	36"	116	\$1,062
FSECCPPWS.30486630L	1.25"	30"	48"	66"	36"	123	\$1,200
FSECCPPWS.30486630R	1.25"	30"	48"	66"	36"	123	\$1,200
FSECCPPWS.30487230L	1.25"	30"	48"	72"	36"	132	\$1,217
FSECCPPWS.30487230R	1.25"	30"	48"	72"	36"	132	\$1,217
FSECCPPWS.30487830L	1.25"	30"	48"	78"	36"	139	\$1,481
FSECCPPWS.30487830R	1.25"	30"	48"	78"	36"	139	\$1,481
FSECCPPWS.30488430L	1.25"	30"	48"	84"	36"	146	\$1,502
FSECCPPWS.30488430R	1.25"	30"	48"	84"	36"	146	\$1,502

Ellipse End Peninsula | Worksurface

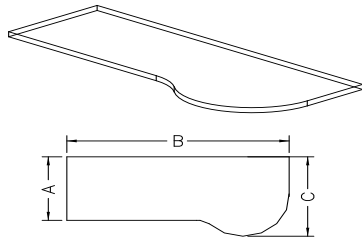

Right Extended shown

DESCRIPTION

Worksurface hangs from a panel or Wall Strips. It has a laminate top and a PVC edge. There is a 1" gap at the back of the worksurface for plug and cord passage. 60" to 84" worksurfaces have center support.

NOTES

- Includes cantilever brackets and attachment hardware.

SPECIFICATION OPTIONS

product #: see charts below
top, edge finish: see page 5
support finish: LG Light Gray, MT Medium Tone, DT Dark Tone
worksurface finish: see page 5

ORDER EXAMPLE

product #: FSEEPWS.246030
top, edge finish: LG
support finish: LG
worksurface finish: 7040A-60 Mahogany

**24" D LEFT
30" D RIGHT**

PART #	HEIGHT	A	B	C	D	WT. (LBS)	PRICE
FSEEPWS.246030	1.25"	24"	60"	30"	—	52	\$573
FSEEPWS.246630	1.25"	24"	66"	30"	—	59	\$647
FSEEPWS.247230	1.25"	24"	72"	30"	—	66	\$658
FSEEPWS.247830	1.25"	24"	78"	30"	—	74	\$794
FSEEPWS.248430	1.25"	24"	84"	30"	—	81	\$808

**30" D LEFT
24" D RIGHT**

PART #	HEIGHT	A	B	C	D	WT. (LBS)	PRICE
FSEEPWS.306024	1.25"	30"	60"	24"	—	52	\$573
FSEEPWS.306624	1.25"	30"	66"	24"	—	59	\$647
FSEEPWS.307224	1.25"	30"	72"	24"	—	66	\$658
FSEEPWS.307824	1.25"	30"	78"	24"	—	74	\$794
FSEEPWS.308424	1.25"	30"	84"	24"	—	81	\$808

**30" D LEFT
36" D RIGHT**

PART #	HEIGHT	A	B	C	D	WT. (LBS)	PRICE
FSEEPWS.306036	1.25"	30"	60"	36"	—	57	\$674
FSEEPWS.306636	1.25"	30"	66"	36"	—	64	\$759
FSEEPWS.307236	1.25"	30"	72"	36"	—	71	\$771
FSEEPWS.307836	1.25"	30"	78"	36"	—	79	\$931
FSEEPWS.308436	1.25"	30"	84"	36"	—	86	\$944

**36" D LEFT
30" D RIGHT**

PART #	HEIGHT	A	B	C	D	WT. (LBS)	PRICE
FSEEPWS.366030	1.25"	36"	60"	30"	—	57	\$674
FSEEPWS.366630	1.25"	36"	66"	30"	—	64	\$759
FSEEPWS.367230	1.25"	36"	72"	30"	—	71	\$771
FSEEPWS.367830	1.25"	36"	78"	30"	—	79	\$931
FSEEPWS.368430	1.25"	36"	84"	30"	—	86	\$944

Rectangular Asymmetrical | Worksurface

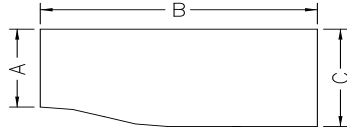
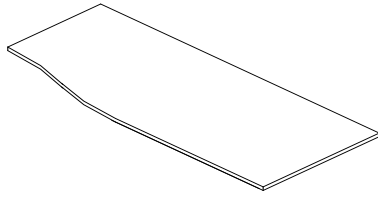

Right Extended shown

DESCRIPTION

Worksurface hangs from a panel or Wall Strips. It has a laminate top and a PVC edge. There is a 1" gap at the back of the worksurface for plug and cord passage. 60" to 84" worksurfaces have center support.

NOTES

- Includes cantilever brackets and attachment hardware.
- 78"W and 84"W worksurfaces will accept a 42"W or 36"W lateral file.
- 72"W worksurface will accept a 36"W lateral file.
- 66"W worksurface will accept a 30"W lateral file.
- Worksurfaces shorter than 48"W will not accept a pedestal.
- Includes cantilever brackets and attachment hardware.

SPECIFICATION OPTIONS

product #: see charts below
top, edge finish: see page 5
support finish: LG Light Gray, MT Medium Tone, DT Dark Tone
worksurface finish: see page 5

ORDER EXAMPLE

product #: FSRWWS.243030
top, edge finish: LG
support finish: DT
worksurface finish: 7054-60 Light Cherry

**24" D LEFT
 30" D RIGHT**

PART #	HEIGHT	A	B	C	D	WT. (LBS)	PRICE
FSRWWS.243030	1.25"	24"	30"	30"	—	40	\$276
FSRWWS.243630	1.25"	24"	36"	30"	—	46	\$325
FSRWWS.244230	1.25"	24"	42"	30"	—	53	\$331
FSRWWS.244830	1.25"	24"	48"	30"	—	60	\$416
FSRWWS.245430	1.25"	24"	54"	30"	—	66	\$421
FSRWWS.246030	1.25"	24"	60"	30"	—	74	\$506
FSRWWS.246630	1.25"	24"	66"	30"	—	81	\$512
FSRWWS.247230	1.25"	24"	72"	30"	—	88	\$579
FSRWWS.247830	1.25"	24"	78"	30"	—	95	\$708
FSRWWS.248430	1.25"	24"	84"	30"	—	102	\$711

**30" D LEFT
 24" D RIGHT**

PART #	HEIGHT	A	B	C	D	WT. (LBS)	PRICE
FSRWWS.303024	1.25"	30"	30"	24"	—	40	\$276
FSRWWS.303624	1.25"	30"	36"	24"	—	46	\$325
FSRWWS.304224	1.25"	30"	42"	24"	—	53	\$331
FSRWWS.304824	1.25"	30"	48"	24"	—	60	\$416
FSRWWS.305424	1.25"	30"	54"	24"	—	66	\$421
FSRWWS.306024	1.25"	30"	60"	24"	—	74	\$506
FSRWWS.306624	1.25"	30"	66"	24"	—	81	\$512
FSRWWS.307224	1.25"	30"	72"	24"	—	88	\$579
FSRWWS.307824	1.25"	30"	78"	24"	—	95	\$708
FSRWWS.308424	1.25"	30"	84"	24"	—	102	\$711

120° Rectangular | Worksurface

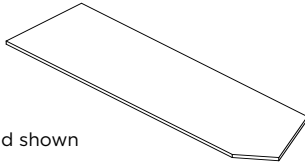
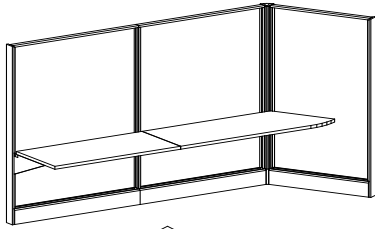

Right End shown

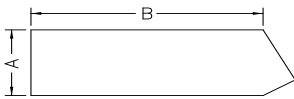

DESCRIPTION

Worksurface hangs from a panel and has a 120° End, either left or right. The end fits against a panel connected by a 120° Connector. It has a PVC edge. There is a 1" gap at the back of the worksurface for plug and cord passage.

NOTES

- Specify L for left end angle, and R for right end angle.
- Includes cantilever brackets, and attachment hardware.

SPECIFICATION OPTIONS

product #: see charts below
top, edge finish: see page 5
support finish: LG Light Gray, MT Medium Tone, DT Dark Tone
worksurface finish: see page 5
left or right extended: L for Left, R for Right

ORDER EXAMPLE

product #: FS120WS.2424L
top, edge finish: LG
support finish: DT
worksurface finish: 7040A-60 Mahogany
left or right extended: L

120° RECTANGULAR

PART #	HEIGHT	A	B	C	D	WT. (LBS)	PRICE
FS120WS.2424L	1.25"	24"	24"	—	—	33	\$343
FS120WS.2424R	1.25"	24"	24"	—	—	33	\$343
FS120WS.2430L	1.25"	24"	30"	—	—	40	\$376
FS120WS.2430R	1.25"	24"	30"	—	—	40	\$376
FS120WS.2436L	1.25"	24"	36"	—	—	45	\$408
FS120WS.2436R	1.25"	24"	36"	—	—	45	\$408
FS120WS.2442L	1.25"	24"	42"	—	—	52	\$466
FS120WS.2442R	1.25"	24"	42"	—	—	52	\$466
FS120WS.2448L	1.25"	24"	48"	—	—	57	\$475
FS120WS.2448R	1.25"	24"	48"	—	—	57	\$475
FS120WS.2460L	1.25"	24"	60"	—	—	64	\$555
FS120WS.2460R	1.25"	24"	60"	—	—	64	\$555

120° Corner Worksurface | 90° Ends

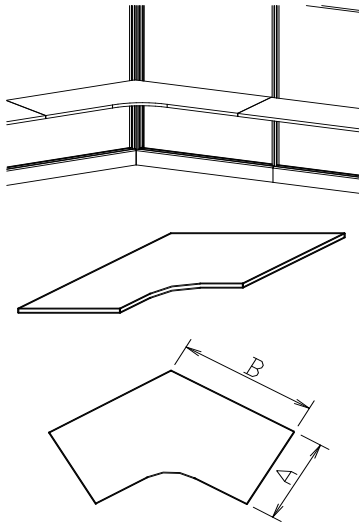

DESCRIPTION

Worksurface hangs from a panels. It has a laminate top and a PVC edge. There is a 1" gap at the back of the worksurface for plug and cord passage. Worksurface is 24" deep.

NOTES

- Includes cantilever brackets, corner bracket and attachment hardware.

SPECIFICATION OPTIONS

product #: see charts below
top, edge finish: see page 5
support finish: LG Light Gray, MT Medium Tone, DT Dark Tone
worksurface finish: see page 5

ORDER EXAMPLE

product #: FS12090WS.2424
top, edge finish: LG
support finish: DT
worksurface finish: 7040A-60 Mahogany

120° CORNER
90° ENDS

PART #	HEIGHT	A	B	C	D	WT. (LBS)	PRICE
FS120/90WS.2424	1.25"	24"	24"	—	—	30	\$458
FS120/90WS.2430	1.25"	24"	30"	—	—	41	\$528
FS120/90WS.2436	1.25"	24"	36"	—	—	50	\$671
FS120/90WS.2442	1.25"	24"	42"	—	—	62	\$828
FS120/90WS.2448	1.25"	24"	48"	—	—	80	\$1,034

120° Corner Worksurface | 120° Ends

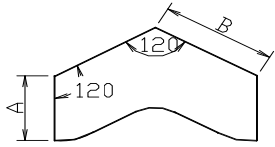
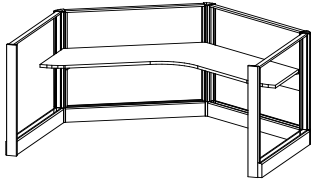

DESCRIPTION

Worksurface hangs from panels. It has a PVC edge. There is a 1" gap at the back of the worksurface for plug and cord passage. Worksurface is 24" deep.

NOTES

- Includes cantilever brackets, corner bracket, and attachment hardware.

SPECIFICATION OPTIONS

product #: see charts below
top, edge finish: see page 5
support finish: LG Light Gray, MT Medium Tone, DT Dark Tone
worksurface finish: see page 5

ORDER EXAMPLE

product #: FS120120WS.2436
top, edge finish: LG
support finish: DT
worksurface finish: 7054-60 Light Cherry

120° CORNER 120° ENDS

PART #	HEIGHT	A	B	C	D	WT. (LBS)	PRICE
FS120/120WS.2436	1.25"	24"	36"	—	—	50	\$677
FS120/120WS.2442	1.25"	24"	42"	—	—	62	\$834
FS120/120WS.2448	1.25"	24"	48"	—	—	80	\$1,040

135° Corner | Worksurface

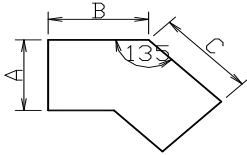
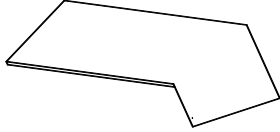
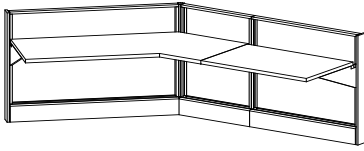

DESCRIPTION

Worksurface hangs from two panels, connected by a 135° 2-Way Connector. It has a laminate top and a PVC edge. There is a 1" gap at the back of the worksurface for plug and cord passage.

NOTES

- The width of each side of the worksurface must match the width of the adjacent panels.
- Includes cantilever brackets, corner bracket, and attachment hardware.

SPECIFICATION OPTIONS

product #: see charts below
top, edge finish: see page 5
support finish: LG Light Gray, MT Medium Tone, DT Dark Tone
worksurface finish: see page 5

ORDER EXAMPLE

product #: FS135CWS24.2424
top, edge finish: LG
support finish: DT
worksurface finish: 7054-60 Light Cherry

24" D

PART #	HEIGHT	A	B	C	D	WT. (LBS)	PRICE
FS135CWS24.2424	1.25"	24"	24"	24"	—	50	\$604
FS135CWS24.3030	1.25"	24"	30"	30"	—	54	\$714
FS135CWS24.4824	1.25"	24"	48"	24"	—	70	\$678
FS135CWS24.2448	1.25"	24"	24"	48"	—	70	\$831

30" D

PART #	HEIGHT	A	B	C	D	WT. (LBS)	PRICE
FS135CWS30.2424	1.25"	30"	24"	24"	—	55	\$630
FS135CWS30.3030	1.25"	30"	30"	30"	—	59	\$743
FS135CWS30.4824	1.25"	30"	48"	24"	—	74	\$845
FS135CWS30.2448	1.25"	30"	24"	48"	—	74	\$852

135° Double Corner | Worksurface

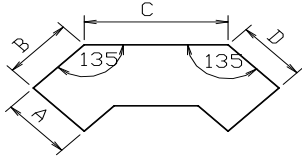
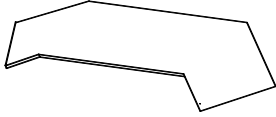
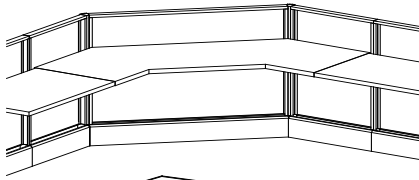

DESCRIPTION

Worksurface hangs from three panels connected by two 135° 2-Way Connectors. It has a PVC edge. There is a 1" gap at the back of the worksurface for plug and cord passage.

NOTES

- The width of each side of the worksurface must match the width of the adjacent panels.
- Includes cantilever brackets, corner bracket, and attachment hardware.

SPECIFICATION OPTIONS

product #: see charts below
top, edge finish: see page 5
support finish: LG Light Gray, MT Medium Tone, DT Dark Tone
worksurface finish: see page 5

ORDER EXAMPLE

product #: FS235DCWS24.244824
top, edge finish: LG
support finish: DT
worksurface finish: 7054-60 Light Cherry

24" D

PART #	HEIGHT	A	B	C	D	WT. (LBS)	PRICE
FS135DCWS24.244824	1.25"	24"	24"	48"	24"	80	\$1,165

30" D

PART #	HEIGHT	A	B	C	D	WT. (LBS)	PRICE
FS135DCWS30.244824	1.25"	30"	24"	48"	24"	84	\$1,168

Transaction Surface | Rectangular

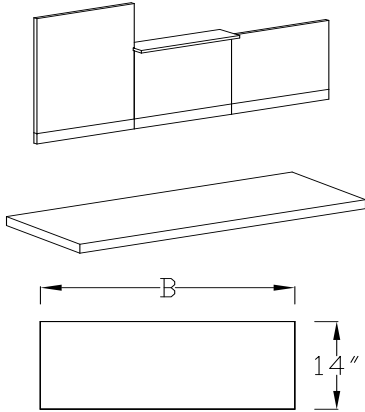

DESCRIPTION

14" D Rectangular Transaction Worksurface attaches to the top of a panel. Ends are flush with the panel. It has a PVC edge.

NOTES

- Attaches to the top of a panel for counter or display area.
- Order transaction surface supports separately.

SPECIFICATION OPTIONS

product #: see charts below
top, edge finish: see page 5
support finish: LG Light Gray, MT Medium Tone, DT Dark Tone
worksurface finish: see page 5

ORDER EXAMPLE

product #: FSERTS.1424L
top, edge finish: LG
support finish: DT
worksurface finish: 7054-60 Light Cherry

TRANSACTION SURFACE

PART #	HEIGHT	A	B	C	D	WT. (LBS)	PRICE
FSERTS.1424L	1.25"	14"	24"	—	—	17	\$153
FSERTS.1430L	1.25"	14"	30"	—	—	21	\$180
FSERTS.1436L	1.25"	14"	36"	—	—	24	\$196
FSERTS.1442L	1.25"	14"	42"	—	—	27	\$241
FSERTS.1448L	1.25"	14"	48"	—	—	31	\$245
FSERTS.1460L	1.25"	14"	60"	—	—	38	\$288
FSERTS.1472L	1.25"	14"	72"	—	—	43	\$333

Corner Transaction | Surface

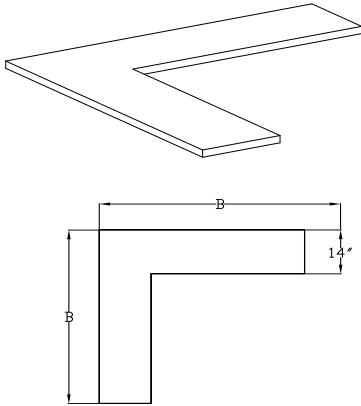

DESCRIPTION

14" D Corner Transaction Worksurface attaches to the top of two panels. Ends are flush with the panel. It has a PVC edge.

NOTES

- Attaches to the top of two 24", 30", 36", 42", or 48"W.
- Panels connected at a 90° angle for corner counter or display area.
- Order transaction surface supports separately.

SPECIFICATION OPTIONS

product #: see charts below
top, edge finish: see page 5
support finish: LG Light Gray, MT Medium Tone, DT Dark Tone
worksurface finish: see page 5

ORDER EXAMPLE

product #: FSECTS.24
top, edge finish: LG
support finish: DT
worksurface finish: 7054-60 Light Cherry

CORNER TRANSACTION

PART #	HEIGHT	A	B	C	D	WT. (LBS)	PRICE
FSECTS.24	1.25"	14"	32"	—	—	40	\$321
FSECTS.30	1.25"	14"	38"	—	—	48	\$447
FSECTS.36	1.25"	14"	44"	—	—	55	\$500
FSECTS.42	1.25"	14"	50"	—	—	62	\$728
FSECTS.48	1.25"	14"	56"	—	—	71	\$732

Flat Bracket

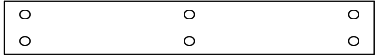
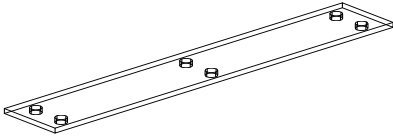

DESCRIPTION

This Flat Bracket is used to support two worksurfaces when a support leg or panel leg is inappropriate.

NOTES

- Flat Bracket finish: Black Umber.

SPECIFICATION OPTIONS

product #: see chart below

ORDER EXAMPLE

product #: F2FB.18

FLAT BRACKET

PART #	HEIGHT	A	B	C	D	WT. (LBS)	PRICE
F2FB.18	3"	18"	—	—	—	1	\$30

Supports

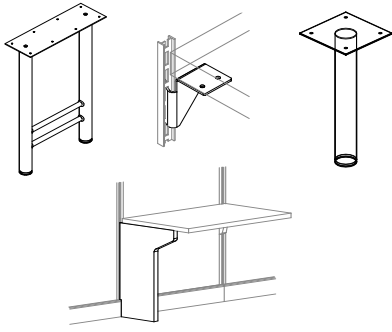

DESCRIPTION

Provide support to the worksurface.

NOTES

- Nonhanded Thermally Fused laminate panel supports left or right side of worksurface.
- It has a 3mm PVC edge.
- Attaches to worksurface.
- Includes leveling glides and attachment hardware.

SPECIFICATION OPTIONS

product #: see charts below
edge finish: see page 5
support finish: DT Dark Tone, MT Medium Tone

ORDER EXAMPLE

product #: FWSSEP.24-MEL
edge finish: LG
support finish: MT

WORKSURFACE SUPPORT END PANEL

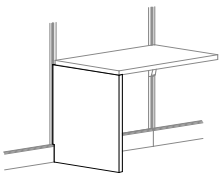

PART #	HEIGHT	WIDTH	DEPTH	WT. (LBS)	PRICE
FWSSEP.24-MEL	27.75"	1.25"	24"	26	\$212
FWSSEP.30-MEL	27.75"	1.25"	30"	32	\$244

WORKSURFACE SUPPORT P-LEG

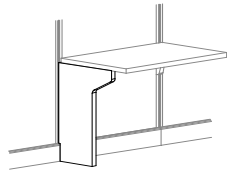

PART #	HEIGHT	WIDTH	DEPTH	WT. (LBS)	PRICE
FWSSPL.24-MEL	27.75"	1.25"	24"	17	\$212
FWSSPL.30-MEL	27.75"	1.25"	30"	20	\$244

WORKSURFACE SUPPORT END PANEL

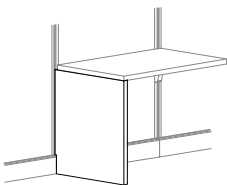

PART #	HEIGHT	WIDTH	DEPTH	WT. (LBS)	PRICE
FWSSEP.24-LAM	27.75"	1.25"	24"	26	\$318
FWSSEP.30-LAM	27.75"	1.25"	30"	32	\$365

WORKSURFACE SUPPORT P-LEG

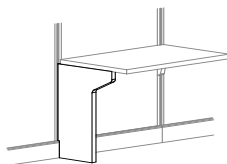

PART #	HEIGHT	WIDTH	DEPTH	WT. (LBS)	PRICE
FWSSPL.24-LAM	27.75"	1.25"	24"	17	\$319
FWSSPL.30-LAM	27.75"	1.25"	30"	20	\$347

WORKSURFACE BRACKET

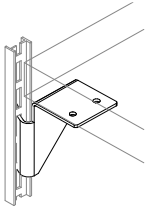

PART #	HEIGHT	WIDTH	DEPTH	WT. (LBS)	PRICE
FWSB.L	2.75"	—	2.5"	0.25	\$11
FWSB.R	2.75"	—	2.5"	0.25	\$11

NOTES

Attaches to the front corner of a hanging worksurface to provide additional support when the return panel matches the worksurface depth.

Also used as support for the back corner of a corner worksurface.

Specify left or right.

Color: Black

DUAL COLUMN LEG

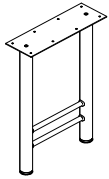

PART #	HEIGHT	WIDTH	DEPTH	WT. (LBS)	PRICE
F2DCL	27.75"	18"		25	\$138

NOTES

Attaches to the underside of a worksurface.

Has adjustable glides.

Finish: DT Dark Tone.

COLUMN LEG

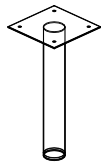

PART #	HEIGHT	WIDTH	DEPTH	WT. (LBS)	PRICE
F2CL.3	27.75"	3" Dia	—	12	\$90
F2CL.4	27.75"	4" Dia	—	16	\$111

NOTES

Attaches to the underside of a worksurface.

Has an adjustable glide.

Finish: DT Dark Tone.

TRANSACTION SURFACE SUPPORT, END

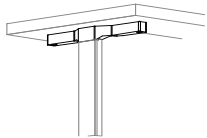

PART #	HEIGHT	WIDTH	DEPTH	WT. (LBS)	PRICE
FTSSE	2.5"	1"	10"	1	\$29

NOTES

Placed above the last panel in a run.

TRANSACTION SURFACE SUPPORT, MID-END

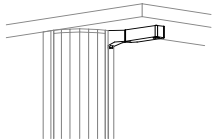

PART #	HEIGHT	WIDTH	DEPTH	WT. (LBS)	PRICE
FTSSM/E	2"	1"	10"	1	\$29

NOTES

Supports a transaction surface in a 180° application.

Placed above a straight-line connector, in a 2-Way 180° connector, or a 2-, 3- or 4-Way 90° connector.

TRANSACTION SURFACE SUPPORT, CENTER

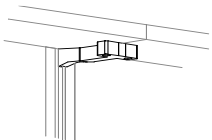

PART #	HEIGHT	WIDTH	DEPTH	WT. (LBS)	PRICE
FTSSC	2"	1"	10"	1	\$30

NOTES

Supports two transaction surfaces in a 180° application.

Components / Storage

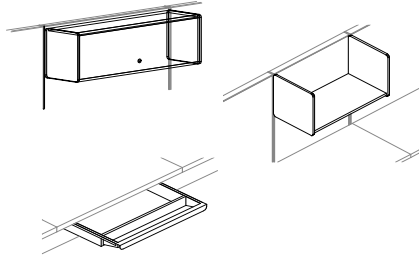

DESCRIPTION

Storage and components for the workstation.

NOTES

- For "A" style components, call factory for availability.

SPECIFICATION OPTIONS

product #: see charts below
finish: LG Light Gray, MT Medium Tone, DT Dark Tone
fabric (flipper door and unit only): see page 4

ORDER EXAMPLE

product #: F1HSH.1324
finish: LG
fabric: PF101-1 Slide - Caramel

**"A" STYLE SHELF
 HALF HEIGHT**

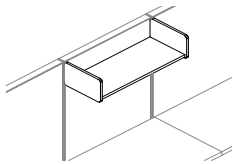

PART #	HEIGHT	WIDTH	DEPTH	WT. (LBS)	PRICE
F1HSH.1324	7.5"	24"	12.5"	12	\$127
F1HSH.1330	7.5"	30"	12.5"	13	\$135
F1HSH.1336	7.5"	36"	12.5"	13	\$145
F1HSH.1342	7.5"	42"	12.5"	14	\$156
F1HSH.1348	7.5"	48"	12.5"	15	\$164
F1HSH.1360	7.5"	60"	12.5"	18	\$186

NOTES

Hangs from panel or wall strips.
 Includes attachment hardware.

**"A" STYLE SHELF
 FULL HEIGHT**

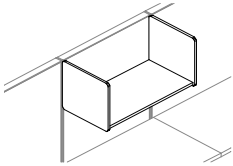

PART #	HEIGHT	WIDTH	DEPTH	WT. (LBS)	PRICE
F1FSH.1324	15.5"	24"	12.5"	16	\$152
F1FSH.1330	15.5"	30"	12.5"	17	\$157
F1FSH.1336	15.5"	36"	12.5"	17	\$165
F1FSH.1342	15.5"	42"	12.5"	18	\$175
F1FSH.1348	15.5"	48"	12.5"	19	\$177
F1FSH.1360	15.5"	60"	12.5"	22	\$195

NOTES

Hangs from panel or wall strips.
 Includes attachment hardware.

**"B" STYLE SHELF
 HALF HEIGHT**

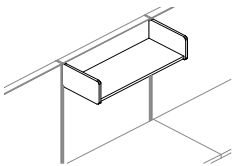

PART #	HEIGHT	WIDTH	DEPTH	WT. (LBS)	PRICE
F2HSH.1324	7.5"	24"	12.5"	12	\$127
F2HSH.1330	7.5"	30"	12.5"	13	\$135
F2HSH.1336	7.5"	36"	12.5"	13	\$145
F2HSH.1342	7.5"	42"	12.5"	14	\$156
F2HSH.1348	7.5"	48"	12.5"	15	\$164
F2HSH.1360	7.5"	60"	12.5"	18	\$186

NOTES

Hangs from panel or wall strips.
 Includes attachment hardware.

**"B" STYLE SHELF
 FULL HEIGHT**

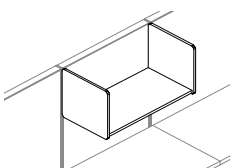

PART #	HEIGHT	WIDTH	DEPTH	WT. (LBS)	PRICE
F2FSH.1324	15.5"	24"	12.5"	16	\$152
F2FSH.1330	15.5"	30"	12.5"	17	\$157
F2FSH.1336	15.5"	36"	12.5"	17	\$165
F2FSH.1342	15.5"	42"	12.5"	18	\$175
F2FSH.1348	15.5"	48"	12.5"	19	\$177
F2FSH.1360	15.5"	60"	12.5"	22	\$195

NOTES

Hangs from panel or wall strips.
 Includes attachment hardware.

**“B” STYLE LOCKING
PAINTED FLIPPER DOOR**



PART #	HEIGHT	WIDTH	DEPTH	WT. (LBS)	PRICE
F2PFLD.1324L	15.5"	24"	12.5"	11	\$196
F2PFLD.1330L	15.5"	30"	12.5"	14	\$217
F2PFLD.1336L	15.5"	36"	12.5"	16	\$233
F2PFLD.1342L	15.5"	42"	12.5"	18	\$249
F2PFLD.1348L	15.5"	48"	12.5"	20	\$260
F2PFLD.1360L	15.5"	60"	12.5"	25	\$323

NOTES

Attaches to 15.5" high shelf to create a locking storage unit.

Includes a painted front, a lock and attaching hardware.

Lock Finish: Black

Order shelf separately.

**“B” STYLE LOCKING
PAINTED FLIPPER UNIT**

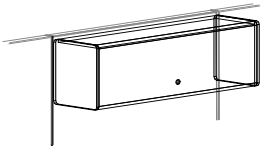

PART #	HEIGHT	WIDTH	DEPTH	WT. (LBS)	PRICE
F2PFLU.1324L	15.5"	24"	12.5"	27	\$307
F2PFLU.1330L	15.5"	30"	12.5"	31	\$329
F2PFLU.1336L	15.5"	36"	12.5"	33	\$366
F2PFLU.1342L	15.5"	42"	12.5"	36	\$382
F2PFLU.1348L	15.5"	48"	12.5"	39	\$408
F2PFLU.1360L	15.5"	60"	12.5"	47	\$498

NOTES

Lockable storage unit, hangs from panel or wall strips.

Includes a painted front, a lock and attaching hardware.

Lock Finish: Black.

**“B” STYLE LOCKING
FABRIC FLIPPER DOOR**



PART #	HEIGHT	WIDTH	DEPTH	WT. (LBS)	PRICE
F2FFLD.1324L	15.5"	24"	12.5"	11	\$339
F2FFLD.1330L	15.5"	30"	12.5"	14	\$357
F2FFLD.1336L	15.5"	36"	12.5"	16	\$378
F2FFLD.1342L	15.5"	42"	12.5"	18	\$400
F2FFLD.1348L	15.5"	48"	12.5"	20	\$420
F2FFLD.1360L	15.5"	60"	12.5"	25	\$498

NOTES

Attaches to 15.5" high shelf to create a locking storage unit.

Includes fabric front, a lock and attaching hardware.

Lock Finish: Black

Order shelf separately.

**“B” STYLE LOCKING
FABRIC FLIPPER UNIT**

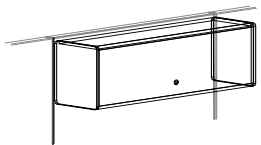

PART #	HEIGHT	WIDTH	DEPTH	WT. (LBS)	PRICE
F2FFLU.1324L	15.5"	24"	12.5"	27	\$470
F2FFLU.1330L	15.5"	30"	12.5"	31	\$490
F2FFLU.1336L	15.5"	36"	12.5"	33	\$519
F2FFLU.1342L	15.5"	42"	12.5"	36	\$550
F2FFLU.1348L	15.5"	48"	12.5"	39	\$575
F2FFLU.1360L	15.5"	60"	12.5"	47	\$676

NOTES

Lockable storage unit, hangs from panel or wall strips.

Includes fabric front, a lock and attaching hardware.

Lock Finish: Black.

Components / Storage | (cont'd)

LED TASKLIGHT



PART #	HEIGHT	WIDTH	DEPTH	WT. (LBS)	PRICE
FLED.20	0.75"	20"	1"	1	\$192
FLED.38	0.75"	38"	1"	2	\$243

NOTES

Attaches beneath shelf or flipper unit.

Includes an LED light, power cord motion sensor, and installation hardware.

Has a pivot range of +/-15°.

For overheads 24"-36" use FLED.20

For overheads 42" or wider use FLED.38

Finish: Silver

WIRE MANAGER

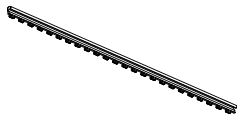

PART #	HEIGHT	WIDTH	DEPTH	WT. (LBS)	PRICE
F2WM.24	24"	.5"	—	1	\$16

NOTES

This Wire Manager is used to manage electrical cords vertically. It fits between side-by-side panels, or between a panel and a connector.

Finish: Black.

PENCIL DRAWER

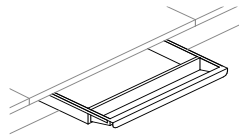

PART #	HEIGHT	WIDTH	DEPTH	WT. (LBS)	PRICE
FPD	1.875"	21.125"	16.25"	5	\$143

NOTES

Stores small items.

Attaches under worksurface.

Includes attachment hardware.

Finish: DT Dark Tone, MT Medium Tone.

Frameless Glass

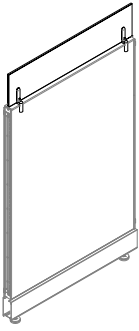

DESCRIPTION

SPECIFICATION OPTIONS

product #: see charts below

NOTES

- Frameless Glass screens are attached to the top of a single frame with included hardware.
- Matches width of the frame.
- Package contains 2.

ORDER EXAMPLE

product #: F2FG.0824-CL

FRAMELESS GLASS 8" CLEAR

PART #	HEIGHT	WIDTH	DEPTH	WT. (LBS)	PRICE	NOTES
F2FG.0824-CL	8"	23-1/4"	—	—	\$252	Includes attachment hardware, brushed finish.
F2FG.0830-CL	8"	29-1/4"	—	—	\$272	
F2FG.0836-CL	8"	35-1/4"	—	—	\$292	Package contains 2.
F2FG.0842-CL	8"	41-1/4"	—	—	\$312	
F2FG.0848-CL	8"	47-1/4"	—	—	\$332	

FRAMELESS GLASS 14" CLEAR

PART #	HEIGHT	WIDTH	DEPTH	WT. (LBS)	PRICE	NOTES
F2FG.1424-CL	14"	23-1/4"	—	—	\$312	Includes attachment hardware, brushed finish.
F2FG.1430-CL	14"	29-1/4"	—	—	\$346	
F2FG.1436-CL	14"	35-1/4"	—	—	\$378	Package contains 2.
F2FG.1442-CL	14"	41-1/4"	—	—	\$410	
F2FG.1448-CL	14"	47-1/4"	—	—	\$446	

FRAMELESS GLASS 8" FROSTED

PART #	HEIGHT	WIDTH	DEPTH	WT. (LBS)	PRICE	NOTES
F2FG.0824-FR	8"	23-1/4"	—	—	\$290	Includes attachment hardware, brushed finish.
F2FG.0830-FR	8"	29-1/4"	—	—	\$328	
F2FG.0836-FR	8"	35-1/4"	—	—	\$366	Package contains 2.
F2FG.0842-FR	8"	41-1/4"	—	—	\$404	
F2FG.0848-FR	8"	47-1/4"	—	—	\$442	

FRAMELESS GLASS 14" FROSTED

PART #	HEIGHT	WIDTH	DEPTH	WT. (LBS)	PRICE	NOTES
F2FG.1424-FR	14"	23-1/4"	—	—	\$404	Includes attachment hardware, brushed finish.
F2FG.1430-FR	14"	29-1/4"	—	—	\$468	
F2FG.1436-FR	14"	35-1/4"	—	—	\$532	Package contains 2.
F2FG.1442-FR	14"	41-1/4"	—	—	\$594	
F2FG.1448-FR	14"	47-1/4"	—	—	\$662	

Tackboards

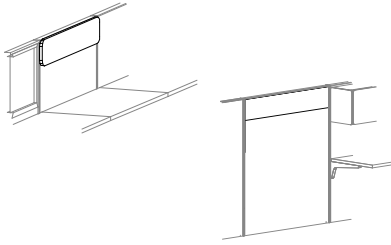

DESCRIPTION

Fabric covered tackable surface that attaches to panel or Wall Strips.

SPECIFICATION OPTIONS

product #: see charts below
fabric: see page 4

NOTES

- Includes attachment hardware.
- For "A" style components, call factory for availability.

ORDER EXAMPLE

product #: FITAKBR.0924
fabric: PF301-1 Sky - Terra

"A" STYLE TACKBOARD ROUNDED CORNERS 8.5" HIGH

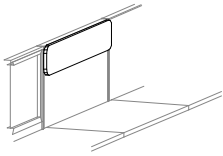

PART #	HEIGHT	WIDTH	DEPTH	WT. (LBS)	PRICE
FITAKBR.0924	8.5"	24"	—	3	\$77
FITAKBR.0930	8.5"	30"	—	4	\$83
FITAKBR.0936	8.5"	36"	—	4	\$93
FITAKBR.0942	8.5"	42"	—	5	\$101
FITAKBR.0948	8.5"	48"	—	6	\$106
FITAKBR.0960	8.5"	60"	—	7	\$117

"A" STYLE TACKBOARD ROUNDED CORNERS 15.5" HIGH

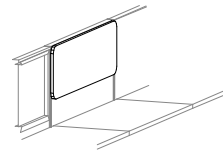

PART #	HEIGHT	WIDTH	DEPTH	WT. (LBS)	PRICE
FITAKBR.1624	15.5"	24"	—	6	\$144
FITAKBR.1630	15.5"	30"	—	7	\$153
FITAKBR.1636	15.5"	36"	—	9	\$160
FITAKBR.1642	15.5"	42"	—	10	\$167
FITAKBR.1648	15.5"	48"	—	11	\$178
FITAKBR.1660	15.5"	60"	—	13	\$202

"B" STYLE TACKBOARD SQUARE CORNERS CURVED TOP & BOTTOM 8.5" HIGH

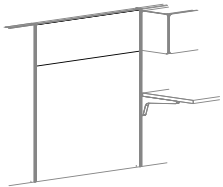

PART #	HEIGHT	WIDTH	DEPTH	WT. (LBS)	PRICE
F2TAKBS.0924	8.5"	24"	—	3	\$77
F2TAKBS.0930	8.5"	30"	—	4	\$83
F2TAKBS.0936	8.5"	36"	—	4	\$93
F2TAKBS.0942	8.5"	42"	—	5	\$101
F2TAKBS.0948	8.5"	48"	—	6	\$106
F2TAKBS.0960	8.5"	60"	—	7	\$117

"B" STYLE TACKBOARD SQUARE CORNERS CURVED TOP & BOTTOM 15.5" HIGH

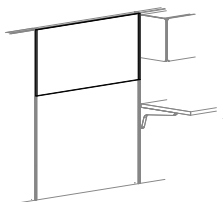

PART #	HEIGHT	WIDTH	DEPTH	WT. (LBS)	PRICE
F2TAKBS.1624	15.5"	24"	—	6	\$144
F2TAKBS.1630	15.5"	30"	—	7	\$153
F2TAKBS.1636	15.5"	36"	—	9	\$160
F2TAKBS.1642	15.5"	42"	—	10	\$167
F2TAKBS.1648	15.5"	48"	—	11	\$178
F2TAKBS.1660	15.5"	60"	—	13	\$202

Markerboards

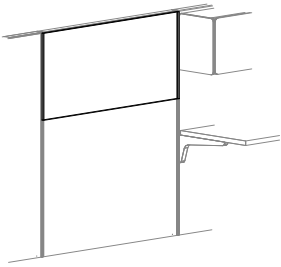

DESCRIPTION
Markerboard surface.

SPECIFICATION OPTIONS
product #: see charts below

NOTES

ORDER EXAMPLE
product #: F2MARBS.2424

“B” STYLE MARKERBOARD SQUARE CORNERS 24” HIGH

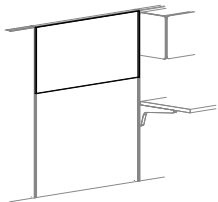

PART #	HEIGHT	WIDTH	DEPTH	WT. (LBS)	PRICE
F2MARBS.2424	24"	24"	—	3	\$244
F2MARBS.2430	24"	30"	—	4	\$267
F2MARBS.2436	24"	36"	—	4	\$278
F2MARBS.2442	24"	42"	—	5	\$292
F2MARBS.2448	24"	48"	—	6	\$302
F2MARBS.2460	24"	60"	—	7	\$344

“B” STYLE MARKERBOARD SQUARE CORNERS 48” HIGH

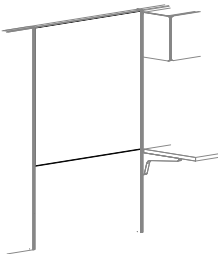

PART #	HEIGHT	WIDTH	DEPTH	WT. (LBS)	PRICE
F2MARBS.4824	48"	24"	—	20	\$302
F2MARBS.4830	48"	30"	—	24	\$339
F2MARBS.4836	48"	36"	—	30	\$382
F2MARBS.4842	48"	42"	—	32	\$430
F2MARBS.4848	48"	48"	—	36	\$487
F2MARBS.4860	48"	60"	—	40	\$551

Pedestals

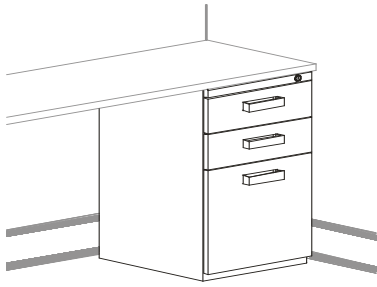

DESCRIPTION

Storage with drawers.

NOTES

- Square drawer front.
- Order side-to-side file bars.

SPECIFICATION OPTIONS

product #: see charts below
finish: LG Light Gray, MT Medium Tone, DT Dark Tone

ORDER EXAMPLE

product #: FPEDSQP.BBF-MET
finish: LG

BOX / BOX / FILE PEDESTAL

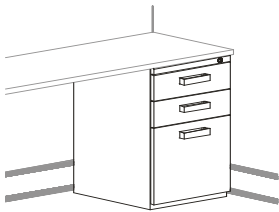

PART #	HEIGHT	WIDTH	DEPTH	WT. (LBS)	PRICE
FPEDSQP.BBF-MET	27"	15"	20"	56	\$530

NOTES

Supporting metal pedestal with lock, without top cap. Attaches to the underside of a worksurface.
 Order side to side file bars.

FILE / FILE PEDESTAL

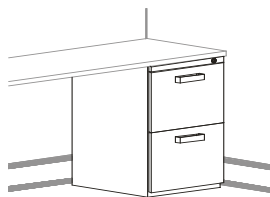

PART #	HEIGHT	WIDTH	DEPTH	WT. (LBS)	PRICE
FPEDSQP.FF-MET	27"	15"	20"	53	\$530

NOTES

Supporting metal pedestal with lock, without top cap. Attaches to the underside of a worksurface.
 Order side to side file bars.

BOX / FILE PEDESTAL MOBILE

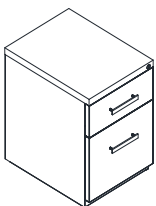

PART #	HEIGHT	WIDTH	DEPTH	WT. (LBS)	PRICE
FPEDSQP.BF-MOB-MET	22"	15"	20"	85	\$581

NOTES

Free-standing mobile pedestal with lock and with top cap.
 Order side to side file bars.

**BOX / BOX / FILE
PEDESTAL MOBILE**

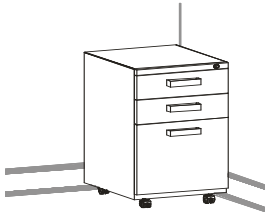

PART #	HEIGHT	WIDTH	DEPTH	WT. (LBS)	PRICE
FPEDSQP.BBF-MOB-MET	27.25"	15"	20"	85	\$689

NOTES
Free-standing mobile pedestal with lock and with top cap. Order side to side file bars.

**FILE / FILE
PEDESTAL MOBILE**

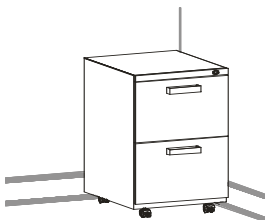

PART #	HEIGHT	WIDTH	DEPTH	WT. (LBS)	PRICE
FPEDSQP.FF-MOB-MET	27.25"	15"	20"	76	\$689

NOTES
Free-standing mobile pedestal with lock and with top cap. Order side to side file bars.

**BOX / FILE PEDESTAL
MOBILE CUSHION**

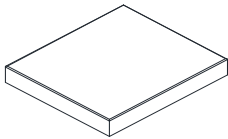

PART #	HEIGHT	WIDTH	DEPTH	WT. (LBS)	PRICE
FPEDSQ.CUSH	1.75"	15"	20"	—	\$265

NOTES
For Box/File mobile pedestal only. If cushion is placed on a full height mobile pedestal, it will not fit under a worksurface.

**SIDE-TO-SIDE
FILE BARS**

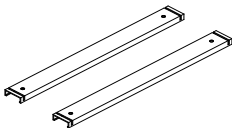

PART #	HEIGHT	WIDTH	DEPTH	WT. (LBS)	PRICE
FSSB	—	—	—	1	\$16

NOTES
Side-to-side File Bars for filing letter or legal size folders. Order one per file drawer. Finish: Black.

Lateral Files

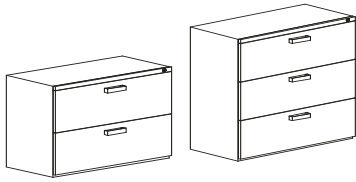

DESCRIPTION

Storage with drawers.

NOTES

- Free-standing 3- and 4-Drawer lateral files must be bolted together or bolted to a wall.

SPECIFICATION OPTIONS

product #: see charts below
finish: LG Light Gray, MT Medium Tone, DT Dark Tone (metal, painted finish)

ORDER EXAMPLE

product #: FLFSQP-2-30-MET
finish: LG

2 DRAWER LATERAL FILES

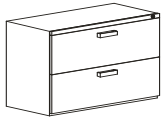

PART #	HEIGHT	WIDTH	DEPTH	WT. (LBS)	PRICE
FLFSQP-2-30-MET	27.5"	30"	20"	103	\$950
FLFSQP-2-36-MET	27.5"	36"	20"	123	\$1,152
FLFSQP-2-42-MET	27.5"	42"	20"	151	\$1,180

NOTES

Supporting lateral file with lock and finished top cap.
 Order front to back file bars.
 Order counterweight to convert to free-standing lateral file.

FREE-STANDING 3-DRAWER LATERAL FILES WITH TOP CAP

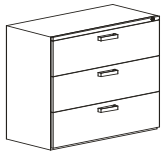

PART #	HEIGHT	WIDTH	DEPTH	WT. (LBS)	PRICE
FLFSQP-3-30-MET	40"	30"	20"	121	\$1,230
FLFSQP-3-36-MET	40"	36"	20"	151	\$1,389
FLFSQP-3-42-MET	40"	42"	20"	181	\$1,511

NOTES

Supporting lateral file with lock and finished top cap.
 Order front to back file bars.
 Free-standing lateral files must be bolted to a wall or bolted together.

FREE-STANDING 4-DRAWER LATERAL FILES WITH TOP CAP



PART #	HEIGHT	WIDTH	DEPTH	WT. (LBS)	PRICE
FLFSQP-4-30-MET	51.5"	30"	20"	173	\$1,558
FLFSQP-4-36-MET	51.5"	36"	20"	196	\$1,712
FLFSQP-4-42-MET	51.5"	42"	20"	241	\$1,871

NOTES

Supporting lateral file with lock and finished top cap.
 Order front to back file bars.
 Free-standing lateral files must be bolted to a wall or bolted together.

LATERAL FILE COUNTERWEIGHT

PART #	USAGE	WT. (LBS)	PRICE
FLFCW-30	use with 30" W lateral file *	23	\$53
FLFCW-36	use with 36" W lateral file **	46	\$80
FLFCW-42	use with 42" W lateral file **	46	\$80

NOTES

Attaches securely to the inside back of the lateral file.
 For use with 2-Drawer lateral files only.
 * Includes one 20 lb counterweight
 ** Includes two 20 lb counterweights, for a total of 40 lbs of counterweight

FRONT-TO-BACK FILE BARS

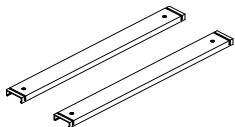

PART #	HEIGHT	WIDTH	DEPTH	WT. (LBS)	PRICE
FFB	3/8"	1 3/16"	15 11/16"	1	\$21

NOTES

Front to back file bars.
 Package of two.
 Order one package of two per drawer.
 Color: Black.

Accessories

DESCRIPTION

Workstation accessories.

NOTES

SPECIFICATION OPTIONS

product #: see charts below

finish: LG Light Gray, MT Medium Tone, DT Dark Tone (metal, painted finish)

ORDER EXAMPLE

product #: FTB.24

finish: MT

TOOL BARS



PART #	HEIGHT	WIDTH	DEPTH	WT. (LBS)	PRICE	NOTES
FTB.24	3.5"	24"	0.75"	2	\$80	Attaches to a panel of same width.
FTB.30	3.5"	30"	0.75"	2	\$85	
FTB.36	3.5"	36"	0.75"	3	\$90	Mounting hardware included.
FTB.42	3.5"	42"	0.75"	3	\$95	
FTB.48	3.5"	48"	0.75"	4	\$101	
FTB.60	3.5"	60"	0.75"	5	\$117	

FLAT PAPER TRAY

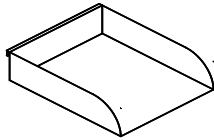

PART #	HEIGHT	WIDTH	DEPTH	WT. (LBS)	PRICE	NOTES
FFPT	3"	10"	12"	2	\$74	Order tool bar separately.

VERTICAL SINGLE TRAY

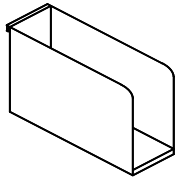

PART #	HEIGHT	WIDTH	DEPTH	WT. (LBS)	PRICE	NOTES
FVST	8"	4"	12"	2	\$74	Order tool bar separately.

VERTICAL TRIPLE TRAY

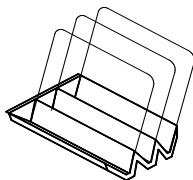

PART #	HEIGHT	WIDTH	DEPTH	WT. (LBS)	PRICE	NOTES
FVTT	11"	12"	12"	4	\$90	Order tool bar separately.

CARPET GRIPPER

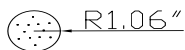

PART #	HEIGHT	WIDTH	DEPTH	WT. (LBS)	PRICE	NOTES
F2CG	—	2.125"	—	0.25	\$5	Plastic Gripper fits onto the adjustable glides of panel. Finish: Black Do not use on hard surface flooring.

Keyed-Alike Information

DESCRIPTION

All Friant Pedestals, Lateral Files, and Overhead Cabinets can be keyed-alike.

SPECIFICATION OPTIONS

product #: see charts below

NOTES

- Keyed-Alike Lock Cores are sold in sets of 4.
- Each set includes four Lock Cores, each with two keys, all with the same lock number.
- One Lock Core Removal Key is shipped with every order.
- Additional Lock Core Removal Keys and Master Keys are also available.

ORDER EXAMPLE

product #: FLCKA

KEYED-ALIKE LOCKS

PART #	DESCRIPTION	PRICE
FLCKA	Lock Core Keyed-Alike (set of 4)	\$100
FCK	Lock Core Removal Key	\$15
FMK	Lock Core Master Key	\$15

SYSTEM I

Hard-Surface Panel

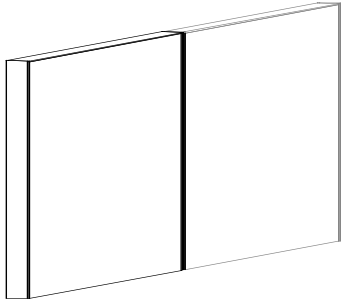

DESCRIPTION

Structural panel with laminate surfaces, painted top caps and trim, leveling glides.

NOTES

- Order connectors and finished ends separately.

SPECIFICATION OPTIONS

product #: see charts below
trim and top cap finish: LG Light Gray, MT Medium Tone, DT Dark Tone
laminate finish (side 1): see page 4
laminate finish (side 2, if applicable): see page 4

ORDER EXAMPLE

product #: F2 PGPA.5324N
trim and top cap finish: LG
laminate finish (side 1): 7909-60 Light Maple
laminate finish (side 2): 7040A-60 Mahogany

27" HIGH

PART #	HEIGHT	WIDTH	DEPTH	WT. (LBS)	PRICE
F1HSPA.2712N	27"	12"	2"	18	\$302
F1HSPA.2718N	27"	18"	2"	20	\$311
F1HSPA.2724N	27"	24"	2"	21	\$319
F1HSPA.2730N	27"	30"	2"	24	\$348
F1HSPA.2736N	27"	36"	2"	27	\$377
F1HSPA.2742N	27"	42"	2"	30	\$408
F1HSPA.2748N	27"	48"	2"	34	\$439
F1HSPA.2760N	27"	60"	2"	40	\$552

34" HIGH

PART #	HEIGHT	WIDTH	DEPTH	WT. (LBS)	PRICE
F1HSPA.3412N	34"	12"	2"	22	\$315
F1HSPA.3418N	34"	18"	2"	24	\$323
F1HSPA.3424N	34"	24"	2"	26	\$332
F1HSPA.3430N	34"	30"	2"	27	\$363
F1HSPA.3436N	34"	36"	2"	31	\$393
F1HSPA.3442N	34"	42"	2"	36	\$425
F1HSPA.3448N	34"	48"	2"	39	\$458
F1HSPA.3460N	34"	60"	2"	46	\$576

42" HIGH

PART #	HEIGHT	WIDTH	DEPTH	WT. (LBS)	PRICE
F1HSPA.4212N	42"	12"	2"	25	\$324
F1HSPA.4218N	42"	18"	2"	26	\$335
F1HSPA.4224N	42"	24"	2"	29	\$347
F1HSPA.4230N	42"	30"	2"	33	\$391
F1HSPA.4236N	42"	36"	2"	38	\$437
F1HSPA.4242N	42"	42"	2"	41	\$482
F1HSPA.4248N	42"	48"	2"	47	\$530
F1HSPA.4260N	42"	60"	2"	53	\$664

48" HIGH

PART #	HEIGHT	WIDTH	DEPTH	WT. (LBS)	PRICE
F1HSPA.4812N	48"	12"	2"	26	\$351
F1HSPA.4818N	48"	18"	2"	30	\$358
F1HSPA.4824N	48"	24"	2"	32	\$367
F1HSPA.4830N	48"	30"	2"	38	\$412
F1HSPA.4836N	48"	36"	2"	41	\$465
F1HSPA.4842N	48"	42"	2"	44	\$514
F1HSPA.4848N	48"	48"	2"	51	\$563
F1HSPA.4860N	48"	60"	2"	57	\$706

57" HIGH

PART #	HEIGHT	WIDTH	DEPTH	WT. (LBS)	PRICE
F1HSPA.5712N	57"	12"	2"	28	\$359
F1HSPA.5718N	57"	18"	2"	32	\$379
F1HSPA.5724N	57"	24"	2"	36	\$416
F1HSPA.5730N	57"	30"	2"	42	\$458
F1HSPA.5736N	57"	36"	2"	47	\$510
F1HSPA.5742N	57"	42"	2"	51	\$559
F1HSPA.5748N	57"	48"	2"	58	\$606
F1HSPA.5760N	57"	60"	2"	66	\$747

62" HIGH

PART #	HEIGHT	WIDTH	DEPTH	WT. (LBS)	PRICE
F1HSPA.6212N	62"	12"	2"	30	\$367
F1HSPA.6218N	62"	18"	2"	34	\$401
F1HSPA.6224N	62"	24"	2"	40	\$437
F1HSPA.6230N	62"	30"	2"	46	\$488
F1HSPA.6236N	62"	36"	2"	51	\$540
F1HSPA.6242N	62"	42"	2"	57	\$593
F1HSPA.6248N	62"	48"	2"	64	\$646
F1HSPA.6260N	62"	60"	2"	74	\$810

80" HIGH

PART #	HEIGHT	WIDTH	DEPTH	WT. (LBS)	PRICE
F1HSPA.8012N	80"	12"	2"	38	\$421
F1HSPA.8018N	80"	18"	2"	41	\$463
F1HSPA.8024N	80"	24"	2"	50	\$507
F1HSPA.8030N	80"	30"	2"	58	\$571
F1HSPA.8036N	80"	36"	2"	65	\$629
F1HSPA.8042N	80"	42"	2"	73	\$687
F1HSPA.8048N	80"	48"	2"	81	\$747
F1HSPA.8060N	80"	60"	2"	86	\$936

Fabric Covered Panel

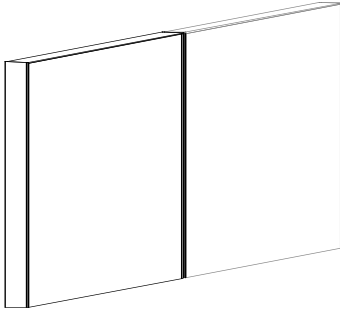

DESCRIPTION

Structural panel with fabric surfaces, painted top caps and trim, leveling glides.

NOTES

- Order connectors and finished ends separately.
- Standard fabric application for panels 67" and below is horizontal application. Panels taller than 67" are only available in vertical application. When ordering panels 67" and below to match a panel taller than 67", specify vertical application.

SPECIFICATION OPTIONS

product #: see charts below
trim and top cap finish: LG Light Gray, MT Medium Tone, DT Dark Tone
fabric (side 1): see page 4
fabric (side 2, if applicable): see page 4

ORDER EXAMPLE

product #: F1FAPA.2712N
trim and top cap finish: LG
fabric (side 1): PF501-1 Sticks - Smoke
fabric (side 2): PF501-2 Sticks - Almond

PANELS

27" HIGH

PART #	HEIGHT	WIDTH	DEPTH	WT. (LBS)	PRICE
F1FAPA.2712N	27"	12"	2"	18	\$257
F1FAPA.2718N	27"	18"	2"	20	\$264
F1FAPA.2724N	27"	24"	2"	21	\$272
F1FAPA.2730N	27"	30"	2"	24	\$300
F1FAPA.2736N	27"	36"	2"	27	\$324
F1FAPA.2742N	27"	42"	2"	30	\$349
F1FAPA.2748N	27"	48"	2"	34	\$374
F1FAPA.2760N	27"	60"	2"	40	\$459

34" HIGH

PART #	HEIGHT	WIDTH	DEPTH	WT. (LBS)	PRICE
F1FAPA.3412N	34"	12"	2"	22	\$267
F1FAPA.3418N	34"	18"	2"	24	\$276
F1FAPA.3424N	34"	24"	2"	26	\$284
F1FAPA.3430N	34"	30"	2"	27	\$313
F1FAPA.3436N	34"	36"	2"	31	\$338
F1FAPA.3442N	34"	42"	2"	36	\$364
F1FAPA.3448N	34"	48"	2"	39	\$390
F1FAPA.3460N	34"	60"	2"	46	\$478

42" HIGH

PART #	HEIGHT	WIDTH	DEPTH	WT. (LBS)	PRICE
F1FAPA.4212N	42"	12"	2"	25	\$275
F1FAPA.4218N	42"	18"	2"	26	\$282
F1FAPA.4224N	42"	24"	2"	29	\$290
F1FAPA.4230N	42"	30"	2"	33	\$328
F1FAPA.4236N	42"	36"	2"	38	\$366
F1FAPA.4242N	42"	42"	2"	41	\$404
F1FAPA.4248N	42"	48"	2"	47	\$443
F1FAPA.4260N	42"	60"	2"	53	\$542

48" HIGH

PART #	HEIGHT	WIDTH	DEPTH	WT. (LBS)	PRICE
F1FAPA.4812N	48"	12"	2"	26	\$290
F1FAPA.4818N	48"	18"	2"	30	\$300
F1FAPA.4824N	48"	24"	2"	32	\$310
F1FAPA.4830N	48"	30"	2"	38	\$351
F1FAPA.4836N	48"	36"	2"	41	\$392
F1FAPA.4842N	48"	42"	2"	44	\$435
F1FAPA.4848N	48"	48"	2"	51	\$477
F1FAPA.4860N	48"	60"	2"	57	\$582

57" HIGH

PART #	HEIGHT	WIDTH	DEPTH	WT. (LBS)	PRICE
F1FAPA.5712N	57"	12"	2"	28	\$300
F1FAPA.5718N	57"	18"	2"	32	\$314
F1FAPA.5724N	57"	24"	2"	36	\$338
F1FAPA.5730N	57"	30"	2"	42	\$381
F1FAPA.5736N	57"	36"	2"	47	\$423
F1FAPA.5742N	57"	42"	2"	51	\$466
F1FAPA.5748N	57"	48"	2"	58	\$509
F1FAPA.5760N	57"	60"	2"	66	\$622

62" HIGH

PART #	HEIGHT	WIDTH	DEPTH	WT. (LBS)	PRICE
F1FAPA.6212N	62"	12"	2"	30	\$308
F1FAPA.6218N	62"	18"	2"	34	\$337
F1FAPA.6224N	62"	24"	2"	40	\$366
F1FAPA.6230N	62"	30"	2"	46	\$410
F1FAPA.6236N	62"	36"	2"	51	\$454
F1FAPA.6242N	62"	42"	2"	57	\$497
F1FAPA.6248N	62"	48"	2"	64	\$541
F1FAPA.6260N	62"	60"	2"	74	\$661

80" HIGH

PART #	HEIGHT	WIDTH	DEPTH	WT. (LBS)	PRICE
F1FAPA.8012N	80"	12"	2"	38	\$349
F1FAPA.8018N	80"	18"	2"	41	\$387
F1FAPA.8024N	80"	24"	2"	50	\$425
F1FAPA.8030N	80"	30"	2"	58	\$475
F1FAPA.8036N	80"	36"	2"	65	\$527
F1FAPA.8042N	80"	42"	2"	73	\$576
F1FAPA.8048N	80"	48"	2"	81	\$625
F1FAPA.8060N	80"	60"	2"	86	\$774

NOTES

Standard fabric application for panels 67" and below is horizontal application. Panels taller than 67" are only available in vertical application. When ordering panels 67" and below to match a panel taller than 67", specify vertical application.

Acoustical Panel

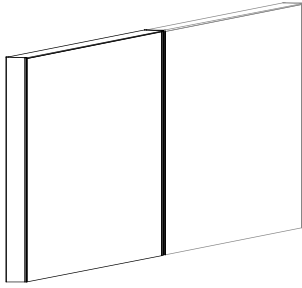

DESCRIPTION

Sound reducing, structural panel with fabric surfaces, painted top cap and trim, leveling glides.

NOTES

- Order connectors and finished ends separately.
- Standard fabric application for panels 67" and below is horizontal application. Panels taller than 67" are only available in vertical application. When ordering panels 67" and below to match a panel taller than 67", specify vertical application.

SPECIFICATION OPTIONS

product #: see charts below
trim and top cap finish: LG Light Gray, MT Medium Tone, DT Dark Tone
fabric (side 1): see page 4
fabric (side 2, if applicable): see page 4

ORDER EXAMPLE

product #: F2ACPA.4812N
trim and top cap finish: LG
fabric (side 1): PF401-1 Silky - Natural
fabric (side 2): PF401-2 Silky - Parids

48" HIGH

PART #	HEIGHT	WIDTH	DEPTH	WT. (LBS)	PRICE
F1ACPA.4812N	48"	12"	2"	26	\$393
F1ACPA.4818N	48"	18"	2"	30	\$417
F1ACPA.4824N	48"	24"	2"	32	\$441
F1ACPA.4830N	48"	30"	2"	38	\$480
F1ACPA.4836N	48"	36"	2"	41	\$520
F1ACPA.4842N	48"	42"	2"	44	\$557
F1ACPA.4848N	48"	48"	2"	51	\$595
F1ACPA.4860N	48"	60"	2"	57	\$714

57" HIGH

PART #	HEIGHT	WIDTH	DEPTH	WT. (LBS)	PRICE
F1ACPA.5712N	57"	12"	2"	28	\$405
F1ACPA.5718N	57"	18"	2"	32	\$426
F1ACPA.5724N	57"	24"	2"	36	\$447
F1ACPA.5730N	57"	30"	2"	42	\$487
F1ACPA.5736N	57"	36"	2"	47	\$525
F1ACPA.5742N	57"	42"	2"	51	\$563
F1ACPA.5748N	57"	48"	2"	58	\$602
F1ACPA.5760N	57"	60"	2"	66	\$722

62" HIGH

PART #	HEIGHT	WIDTH	DEPTH	WT. (LBS)	PRICE
F1ACPA.6212N	62"	12"	2"	30	\$417
F1ACPA.6218N	62"	18"	2"	34	\$436
F1ACPA.6224N	62"	24"	2"	40	\$455
F1ACPA.6230N	62"	30"	2"	46	\$491
F1ACPA.6236N	62"	36"	2"	51	\$529
F1ACPA.6242N	62"	42"	2"	57	\$569
F1ACPA.6248N	62"	48"	2"	64	\$610
F1ACPA.6260N	62"	60"	2"	74	\$728

80" HIGH

PART #	HEIGHT	WIDTH	DEPTH	WT. (LBS)	PRICE
F1ACPA.8012N	80"	12"	2"	38	\$478
F1ACPA.8018N	80"	18"	2"	41	\$500
F1ACPA.8024N	80"	24"	2"	50	\$522
F1ACPA.8030N	80"	30"	2"	58	\$571
F1ACPA.8036N	80"	36"	2"	65	\$633
F1ACPA.8042N	80"	42"	2"	73	\$675
F1ACPA.8048N	80"	48"	2"	81	\$720
F1ACPA.8060N	80"	60"	2"	86	\$875

NOTES

Standard fabric application for panels 67" and below is horizontal application. Panels taller than 67" are only available in vertical application. When ordering panels 67" and below to match a panel taller than 67", specify vertical application.

Glazed Panel

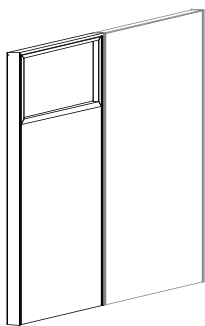

DESCRIPTION

Structural panel with fabric covered lower surfaces and 14" high acrylic top section, painted top cap and leveling glides.

NOTES

- Partial-glazed panel.
- Order connectors and finished ends separately.

SPECIFICATION OPTIONS

product #: see charts below
trim and top cap finish: LG Light Gray, MT Medium Tone, DT Dark Tone
side panel glazing: TR Clear, FR Frosted
fabric (side 1): see page 4
fabric (side 2, if applicable): see page 4

ORDER EXAMPLE

product #: F1PGPA.4824N
trim and top cap finish: LG
side panel glazing: TR
fabric (side 1): PF101-1 Slide - Caramel
fabric (side 2): PF101-6 Slide - Vintage

48" HIGH

PART #	HEIGHT	WIDTH	DEPTH	WT. (LBS)	PRICE
F1 PGPA.4824N	48"	24"	2"	37	\$533
F1 PGPA.4830N	48"	30"	2"	41	\$581
F1 PGPA.4836N	48"	36"	2"	47	\$702
F1 PGPA.4842N	48"	42"	2"	54	\$739
F1 PGPA.4848N	48"	48"	2"	61	\$809
F1 PGPA.4860N	48"	60"	2"	73	\$933

62" HIGH

PART #	HEIGHT	WIDTH	DEPTH	WT. (LBS)	PRICE
F1 PGPA.6224N	62"	24"	2"	42	\$590
F1 PGPA.6230N	62"	30"	2"	50	\$640
F1 PGPA.6236N	62"	36"	2"	56	\$765
F1 PGPA.6242N	62"	42"	2"	62	\$800
F1 PGPA.6248N	62"	48"	2"	71	\$875
F1 PGPA.6260N	62"	60"	2"	82	\$1,015

80" HIGH

PART #	HEIGHT	WIDTH	DEPTH	WT. (LBS)	PRICE
F1 PGPA.8024N	80"	24"	2"	49	\$665
F1 PGPA.8030N	80"	30"	2"	57	\$718
F1 PGPA.8036N	80"	36"	2"	65	\$854
F1 PGPA.8042N	80"	42"	2"	73	\$894
F1 PGPA.8048N	80"	48"	2"	83	\$972
F1 PGPA.8060N	80"	60"	2"	97	\$1,137

Panel Hardware

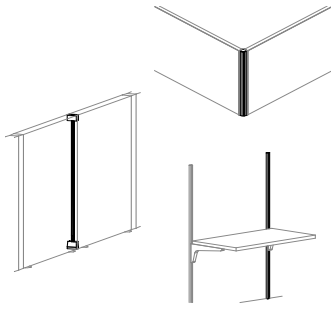

DESCRIPTION
Hardware for panels.

NOTES

SPECIFICATION OPTIONS

product #: see charts below
finish: LG Light Gray, MT Medium Tone, DT Dark Tone

ORDER EXAMPLE

product #: FDR.27
finish: LG

DRAW ROD

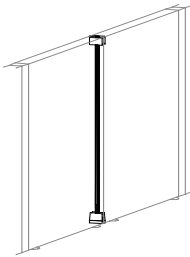

PART #	HEIGHT	WIDTH	DEPTH	WT. (LBS)	PRICE
FDR.27	27"	2"	—	1	\$15
FDR.34	34"	2"	—	1	\$16
FDR.42	42"	2"	—	1	\$16
FDR.48	48"	2"	—	1	\$17
FDR.57	57"	2"	—	1	\$17
FDR.62	62"	2"	—	1	\$17
FDR.80	80"	2"	—	2	\$18

NOTES

Rod and block assembly connects two panels at 180° (straight line).

Color: DT Dark Tone.

DRAW ROD CHANGE OF HEIGHT



PART #	HEIGHT	WIDTH	DEPTH	WT. (LBS)	PRICE
FDRCH.27	27"	2"	—	1	\$32
FDRCH.34	34"	2"	—	1	\$32
FDRCH.42	42"	2"	—	1	\$32
FDRCH.48	48"	2"	—	1	\$37
FDRCH.57	57"	2"	—	1	\$37
FDRCH.62	62"	2"	—	1	\$37

NOTES

Rod and block assembly connects two panels at 180° (straight line) when the panels are of different heights.

Order the height of the shorter panel.

Color: DT Dark Tone.

2-WAY 90° CONNECTOR POST HARD SURFACE

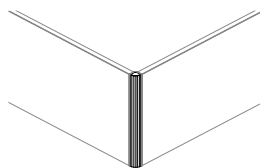

PART #	HEIGHT	WIDTH	DEPTH	WT. (LBS)	PRICE
F12W.27	27"	3.5"	—	3	\$103
F12W.34	34"	3.5"	—	4	\$103
F12W.42	42"	3.5"	—	5	\$113
F12W.48	48"	3.5"	—	6	\$120
F12W.57	57"	3.5"	—	7	\$128
F12W.62	62"	3.5"	—	7	\$130
F12W.80	80"	3.5"	—	8	\$147

NOTES

Connects two panels at 90°.

Panel Hardware | (cont'd)

PANEL HARDWARE

**3-WAY 90° CONNECTOR
POST HARD SURFACE**

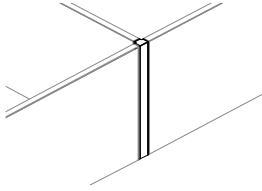

PART #	HEIGHT	WIDTH	DEPTH	WT. (LBS)	PRICE
F13W.27	27"	3.5"	—	5	\$156
F13W.34	34"	3.5"	—	5	\$162
F13W.42	42"	3.5"	—	6	\$174
F13W.48	48"	3.5"	—	7	\$184
F13W.57	57"	3.5"	—	8	\$200
F13W.62	62"	3.5"	—	8	\$202
F13W.80	80"	3.5"	—	9	\$230

NOTES

Connects three panels at 90°.

**4-WAY 90° CONNECTOR
POST HARD SURFACE**

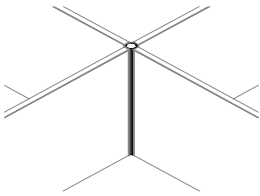

PART #	HEIGHT	WIDTH	DEPTH	WT. (LBS)	PRICE
F14W.27	27"	3.5"	—	5	\$196
F14W.34	34"	3.5"	—	6	\$204
F14W.42	42"	3.5"	—	7	\$217
F14W.48	48"	3.5"	—	8	\$237
F14W.57	57"	3.5"	—	9	\$260
F14W.62	62"	3.5"	—	10	\$262
F14W.80	80"	3.5"	—	10	\$293

NOTES

Connects four panels at 90°.

FINISHED END

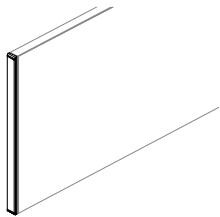

PART #	HEIGHT	WIDTH	DEPTH	WT. (LBS)	PRICE
F1FE.27	27"	2"	—	1	\$48
F1FE.34	34"	2"	—	2	\$48
F1FE.42	42"	2"	—	2	\$53
F1FE.48	48"	2"	—	2	\$53
F1FE.57	57"	2"	—	2	\$53
F1FE.62	62"	2"	—	2	\$58
F1FE.80	80"	2"	—	3	\$64

NOTES

Finishes the vertical end of a panel at the end of a panel run.

**FINISHED END,
CHANGE OF HEIGHT
PANEL TO PANEL**

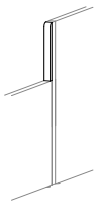

PART #	HEIGHT	WIDTH	DEPTH	WT. (LBS)	PRICE
FFECH	32"	2"	—	1	\$18

NOTES

Finishes the exposed end of a panel when two panels of different heights meet at 180°.

May be field cut to the appropriate length.

WALL START

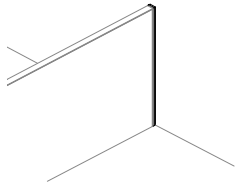

PART #	HEIGHT	WIDTH	DEPTH	WT. (LBS)	PRICE
FWSTA.27	27"	2"	1"	1	\$48
FWSTA.34	34"	2"	1"	2	\$51
FWSTA.42	42"	2"	1"	3	\$51
FWSTA.48	48"	2"	1"	3	\$51
FWSTA.57	57"	2"	1"	3	\$53
FWSTA.62	62"	2"	1"	3	\$53
FWSTA.80	80"	2"	1"	4	\$58

NOTES

Connects panel to structural wall or column.

Can also connect equal height panels at 180° panel width.

Order one additional Draw Rod of the same height.

WALL STRIP

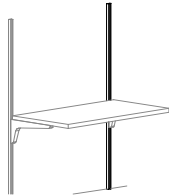

PART #	HEIGHT	WIDTH	DEPTH	WT. (LBS)	PRICE
FWSST.60	60"	—	—	3	\$58
FWSST.72	72"	—	—	3	\$66
FWSST.84	84"	—	—	4	\$66

NOTES

Attaches to structural wall to hang worksurfaces and/or components.

Includes one wall strip.



FRIANT DESIGN ^{MEETS} BUSINESS
SENSE SENSE

4901 EAST 12th St / Oakland / California 94601 / T: 510.535.5113 / F: 510.535.5237 / friant.com