

the modular & flexible

Everest

Specification & Pricing Guide

version 2.01

1/1/2017



Table of Contents

Ordering Information

Ordering Information Checklist.....	4
-------------------------------------	---

Specifications Guide

General Construction.....	6
Sizes.....	6
Top Specifications.....	6
Shelf Specifications.....	7
Panel Specifications.....	8
Filler Specifications.....	9
Base Specifications.....	10
Overall Size Specifications.....	10
Terminology and Tips.....	12
Height Adapters.....	13
Shelf Details.....	14
Shelf Details.....	15
LIAT Shipping Zones.....	16
Shipping Pricing Guide.....	16
Pricing Guide Tutorial.....	18
Shelving (Single Face) Build Guide.....	22
Shelving (Single Face) Pricing Guide.....	23
Shelving (Single Face) Build Guide.....	24
Shelving (Single Face) Pricing Guide.....	25
Shelving (Double Face) Build Guide.....	26
Shelving (Double Face) Pricing Guide.....	27
Shelving (Double Face) Build Guide.....	28
Shelving (Double Face) Pricing Guide.....	29
Continuous Tops Build Guide.....	30
Continuous Tops Pricing Guide.....	31
Doors Build Guide.....	32
Doors Pricing Guide.....	33
Face Fillers Build Guide.....	34
Face Fillers Pricing Guide.....	35
Top Fillers Build Guide.....	36
Top Fillers Pricing Guide.....	37
Shelving Popular Items.....	38
Display.....	42
Book Trucks Popular Items.....	46

Terms and Conditions

Everest Terms and Conditions.....	48
GSA Terms and Conditions	50

Ordering Information

Ordering Information Checklist

Use this checklist to be sure you have all of the necessary information to order your Everest unit.

Catalog Number

Use our build guides to create your Everest catalog number.

Wood Species

Oak
Maple

Wood Finish

Maple

Amber Cherry | ACM
Amber Maple | AMM
Carmel Maple | CMM
Dark Mahogany | DMM
Light Cherry | LCM
Medium Cherry | MCM
Medium Mahogany | MMM
Medium Walnut | MWM
Natural Maple | NMM
Montana Walnut | OWM
Versailles Anigre | VAM

Oak

Dark Mahogany | DMO
Golden Oak | GOO
Light Cherry | LCO
Medium Oak | MOO
Medium Cherry | MCO
Medium Walnut | MWO
Medium Mahogany | MMO
Natural Oak | NOO

Color Stain

Blue
Green
Orange
Red
Yellow

Continuous Top Edge Detail

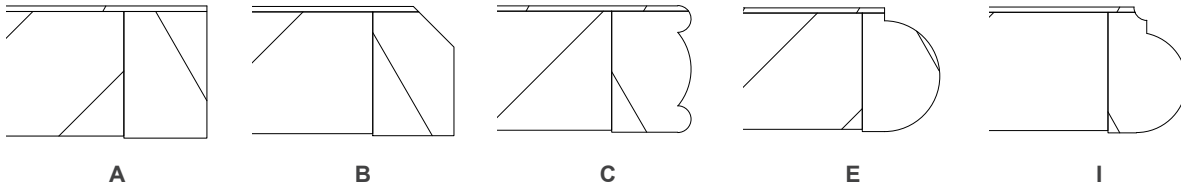

Laminate Selection

Standard Wilsonart, Formica, Nevamar or Pionite. Please specify manufacturer, color, and model number.

LIAT Finish Match Suggestions

LIAT Wood Finish	Laminate	PVC Edge
Amber Cherry on Maple ACM	Wilsonart Amber Cherry 7919K-60	Amber Cherry AC-PVC
Amber Maple on Maple AMM	Formica Natural Teak 8849-58	Natural Teak NT-PVC
Carmel Maple on Maple CMM	—	—
Dark Mahogany on Maple DMM	—	—
Light Cherry on Maple LCM	Wilsonart Huntington Maple 7929-60	Huntington Maple HM-PVC
Medium Cherry on Maple MCM	—	—
Medium Mahogany on Maple MMM	—	—
Medium Walnut on Maple MWM	—	—
Natural Maple on Maple NMM	Wilsonart Kensington Maple 10776-60	Kensington Maple KM-PVC
Montana Walnut on Maple OWM	Wilsonart Montana Walnut 7110K-60	Montana Walnut MW-PVC
Versailles Anigre on Maple VAM	Wilsonart Versailles Anigre 7923K-60**	Versailles Anigre VA-PVC
Dark Mahogany on Oak DMO	Wilsonart Cafelle 7933K-60**	Cafelle CA-PVC
Golden Oak on Oak GOO	Wilsonart Nepal Teak 7209K-60	Nepal Teak NP-PVC
Light Cherry on Oak LCO	—	—
Medium Oak on Oak MOO	—	—
Medium Cherry on Oak MCO	Wilsonart Windsor Mahogany 7039K-60	Windsor Mahogany WM-PVC
Medium Walnut on Oak MWO	Wilsonart Hampton Walnut 7959K-38**	Hampton Walnut HW-PVC
Medium Mahogany on Oak MMO	Pionite Jewel Mahogany WY351-N	—
Natural Oak on Oak NOO	Formica Natural Oak 346	Natural Oak NO-PVC
—	Wilsonart Black 1595-60	Black BK-PVC
—	Wilsonart Fashion Grey D381-60	Fashion Grey FG-PVC
—	Wilsonart Frosty White 1573-60	Frosty White FW-PVC
—	Wilsonart North Sea D90-60	North Sea NS-PVC
—	Wilsonart Slate Grey D91-60	Slate Grey SG-PVC

(—) a suggested match is not available.

**indicates premium pricing, please contact project management for more information.

Specifications Guide

General Construction

Everest shelving has a **modular island/starter/adder/end design**, which allows for easy re-configuration.

The standard species are Red Oak and Maple.

Sizes

Selected sizes are nominal and actual dimensions vary depending on the selected unit type. Adder and End units have a width equal to the nominal width whereas Island and Starter units having a width that is **1"** larger than the nominal width, creating a run of shelving that is the selected nominal width on centers.

Top Specifications

Modular Top

The modular top shall be constructed of **1" thick** veneer core with grade "A" plain sliced veneer faces. The front edge shall receive a **3/4" thick x 1 3/4" high** valance. The cornice frame is grooved to accept the back panel. Back rail and end cleats are machined **1 3/4" wide** from solid wood. Tenon joints shall attach the end cleats to the fascia rail and back rail, then glued and pinned into a rigid structural frame and attached to the cornice panel with blind fasteners and glue. Holes are drilled in the end cleats for a bolt attachment to the end and intermediate panels. On shelving **72"** and above, the fascia is above the cornice to conceal the cleats from below and a **1/4"** panel is provided to conceal the cleats from above. On shelving less than **72"** high, the fascia is located below the cornice top.

Add **"-MT"** to the model number for this option.

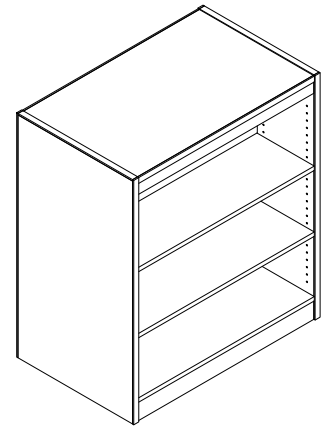

Continuous Tops

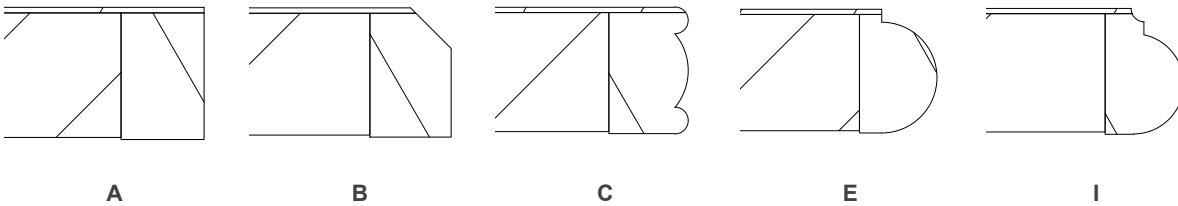

Continuous tops are available for all shelving units. The catalog numbers must be called out to indicate this selection. The HPL tops shall be 1-3/16" thick and come with a 3/4" eased internal edge band. If veneer tops are ordered they shall come with a 3/4" external edge band. Edge details **shall be specified at time of order** and are available in the "A", "B", "C", and "E" profiles.

Veneer tops over 108" long will have seams.

HPL tops over 96" long will have seams.

Continuous tops are ordered separately from the shelving unit.

Add **"-CT"** to the model number for this option.

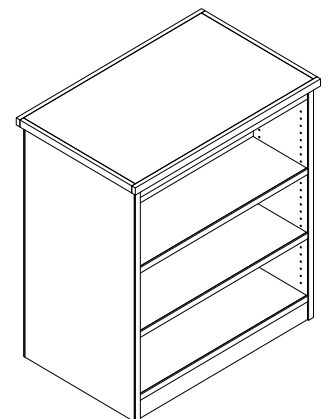

Shelf Specifications

Adjustable Shelf (Book Case)

The adjustable shelves shall be **1"** thick veneer core with grade "A" plain sliced veneer faces. Shelves shall have an eased external band on the front edge.

The underside of the shelf shall be routed to accept the shelf pins.

Add "**-BC**" to the model number for this option.

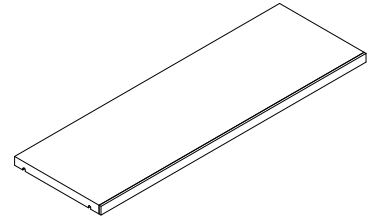

Solid Shelf

The solid wood adjustable shelves shall be **3/4"** thick and constructed of glued-up continuous trips of solid Red Oak or Maple that are no less than **1"** and no more than **4"** in width. Wood species other than Red Oak or Maple shall not be acceptable.

The underside of the shelf shall be routed to accept the shelf pins.

Add "**-SS**" to the model number for this option.

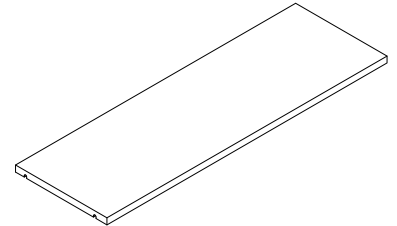

Adjustable Divider Shelf

The adjustable shelves shall be **1"** thick veneer core with grade "A" plain sliced veneer faces. Shelves shall have an eased external band on the front edge.

The underside of the shelf shall be routed to accept the shelf pins.

There shall be a **3/4" thick x 4-3/4" high** veneer core ply back rail routed and glued to the shelf to accept **1/4" thick x 7-3/8" high** hardboard adjustable dividers.

Add "**-AD**" to the model number for this option.

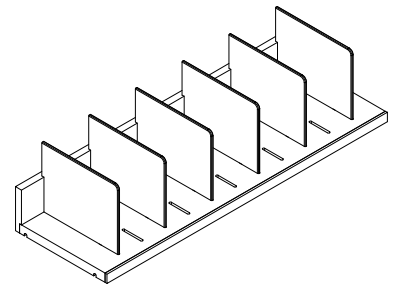

Fixed Divider Shelf

The adjustable shelves shall be **1"** thick veneer core with grade "A" plain sliced veneer faces. Shelves shall have an eased external band on the front edge.

The underside of the shelf shall be routed to accept the shelf pins.

There shall be a **3/4" thick x 4-3/4" high** veneer core ply back rail routed and glued to the shelf. There shall be three **1/2" thick x 7-1/4" high** veneer core ply dividers glued to routes in the shelf and back rail.

Add "**-FD**" to the model number for this option.

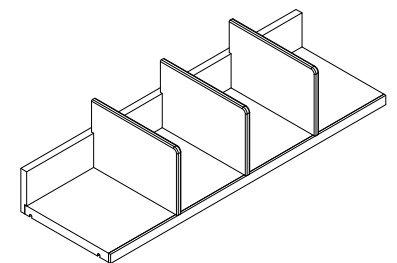

Picture Book Shelf

The adjustable shelves shall be **1" thick** veneer core with grade "A" plain sliced veneer faces. Shelves shall have an eased external band on the front edge.

The underside of the shelf shall be routed to accept the shelf pins.

The top of the shelf shall receive **(5)** evenly spaced black wire dividers which shall be inserted into **3/16" diameter** holes.

Add "**-PB**" to the model number for this option.

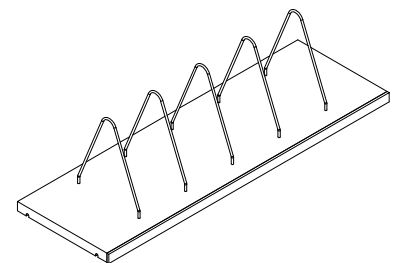

Triangular Divider Shelf

The adjustable shelves shall be **1" thick** veneer core with grade "A" plain sliced veneer faces. Shelves shall have an eased external band on the front edge.

The underside of the shelf shall be routed to accept the shelf pins.

There shall be an additional route on the bottom of the shelf through the middle to accept a metal triangular divider.

Add **"-TD"** to the model number for this option.

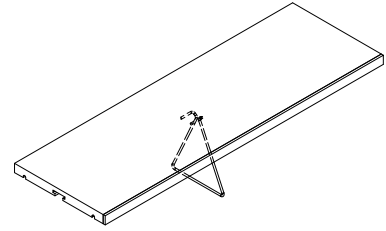

Magazine Shelf

The magazine shelves shall be constructed of **1" thick** veneer core with grade "A" plain sliced veneer faces. The shelf shall have a solid hardwood retaining edge to hold the magazines in their inclined, displayed position. The shelf rests on four adjustable shelf pins pivoting upward on the rear pins to access the flat "adjustable" storage shelf beneath.

Add **"-MG"** to the model number for this option.

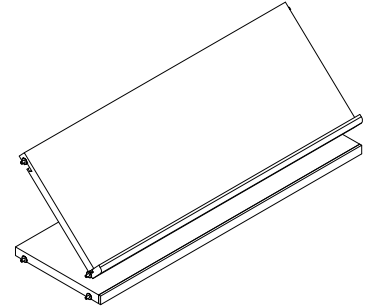

Metal Shelf

The adjustable metal shelf shall be constructed of **20 gauge** steel. The shelf shall be **3/4" high** with the front and rear edges being square formed. The ends of the shelves shall be notched to accept the shelf pins.

The shelves shall be powder coated.

Add **"-MS"** to the model number for this option.

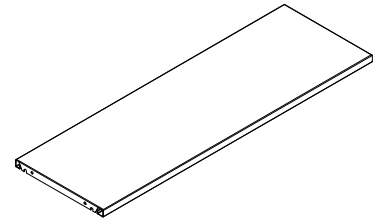

Fixed Shelf

All units **60" and higher** shall require a shelf to be attached to the end and or intermediate panels by means of (4) L-shaped brackets and pan head wood screws that will align with the shelf pin holes on vertical panels.

Panel Specifications

End and Intermediate Panel

The end and intermediate panels shall be constructed **1" thick** veneer core with grade "A" plain sliced veneer faces. All double-faced end panels shall be banded on two vertical edges and the top edge, when required, with an eased **1/4"** solid hardwood external band. Single-faced panels are banded on the top, when required, and front edges with an eased **1/4"** solid hardwood external band. The inside faces of the panels shall have two rows of holes per face bored to accept shelf pins, spaced **32mm** apart on center.

The panels shall be grooved to accept a **1/4" thick** back panel.

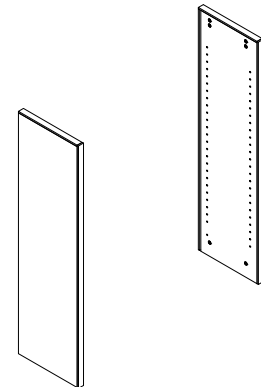

Veneer Back Panel

The optional veneer back panel shall be **1/4"** thick plywood with select rotary cut face veneer on exposed face(s).

Add **"-VB"** to the model number for this option.

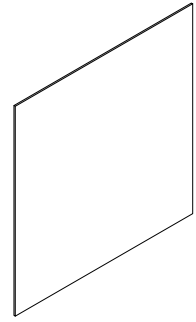

Sway Straps

Sway straps are required when double faced units **60"** or higher are ordered with no back panels. Straps are made of **12 gauge** steel and bent at angles to attach to the end and intermediate panels on a diagonal. The end units of each run shall have a strap. On runs greater than four (**4**) units long, every other unit in a run shall have a strap. Each strap shall be finished with a black powder coat and attached with **#10 x 5/8"** pan head wood screws.

Sway straps are only available for **36"** width units.

Sway straps must be ordered separately.

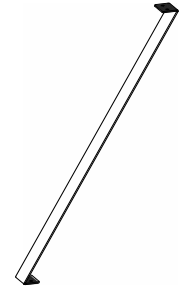

Filler Specifications

Corner Fillers

The corner fillers shall be constructed of **1"** thick plywood core with a Grade "A" veneer face. Solid hardwood cleats shall be provided for attachment to the shelving run and the wall.

The depth and width is to be specified at time of purchase order.

For a proper fit, corner fillers may require trimming on installation.

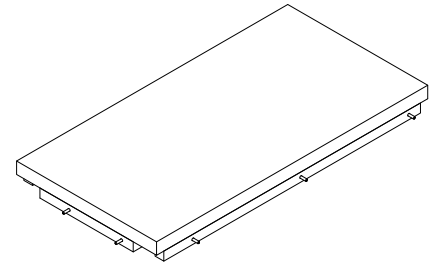

Face Fillers

The face fillers shall be constructed of **1"** thick plywood core with a Grade "A" veneer face. Solid hardwood cleats shall be provided for attachment to the shelving run and the wall.

The height and width is to be specified at time of purchase order.

For a proper fit, face fillers may require trimming on installation.

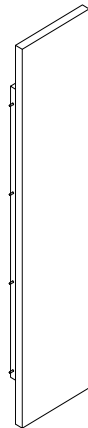

Base Specifications

Mobile Base

The mobile base upgrade is available on double face shelving units up to **60"** high. The swivel casters shall be bolted to the underside of the shelving unit by means of four metal corner brackets.

These brackets shall provide extra bracing by having four bends and attaching to the end panels and shelving base by means of wood screws.

Add **"-CA"** to the model number for this option.

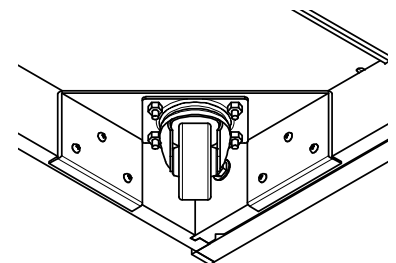

Base Frames

The base frames are manufactured of solid kiln dried hardwood, the toe kick being of solid plain sawn Red Oak or Maple. The toe kick shall be full height at **3 1/4"**. The back rail and two end cleats shall be **1 3/4" high**. The end cleats are tenoned into the toe kick and back rail and glued and pinned into a rigid structural frame assembly. Holes are positioned into the end cleats for bolt attachment to the end and intermediate panels. A groove in the back rail shall house the back panels.

The end cleats on a double face shelving unit shall receive the groove to capture the back panel.

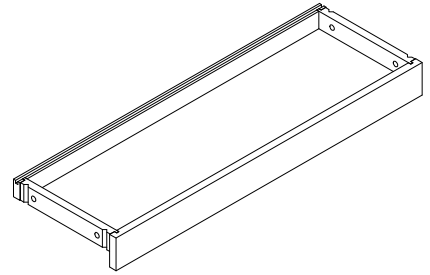

Overall Size Specifications

Height

See specific sections for available heights.

Height selection may vary from the actual overall footprint height.

Depth

See specific sections for available depths.

Depth selection may vary from the actual overall footprint depth.

Width

See specific sections for available widths.

Width selection may vary from the actual overall footprint width.

Each island and starter is 37" wide and each adder and end is 36" wide. This creates a run of shelving units that is 36" wide on centers.

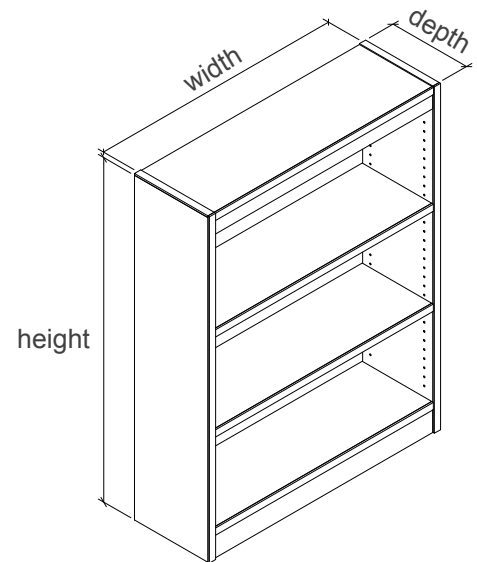

Everest

Terminology and Tips

The following guide is provided as a reference to some of LIAT's **Everest shelving terminology** along with tips to help with the planning process.

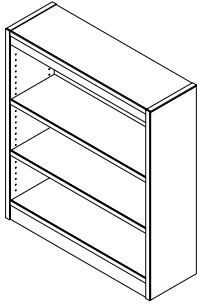

ISLAND

Island units are **stand-alone** or free-standing units.

Comes with 2 end panels

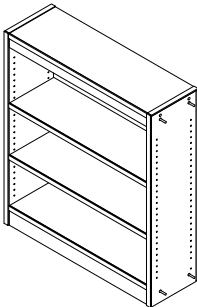

STARTER

Starter units act as a **starting point** for a run of shelving units.

All starters must be ordered with an end unit.

Comes with 1 end panel and 1 intermediate panel

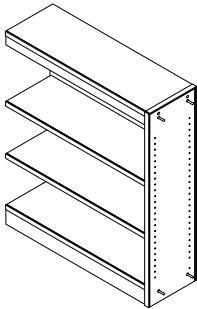

ADDER

Adder units act as an **extension** for a run of shelving units.

All adders must be ordered with both a starter and an end unit. There is no limit to the amount of adders allowed in a given run.

Comes with 1 intermediate panel

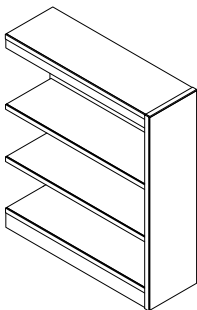

END

End units act as an **ending point** for a run of shelving units.

All ends must be ordered with a starter unit.

Comes with 1 end panel

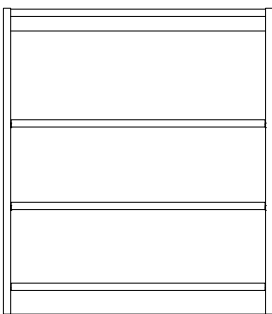

Island

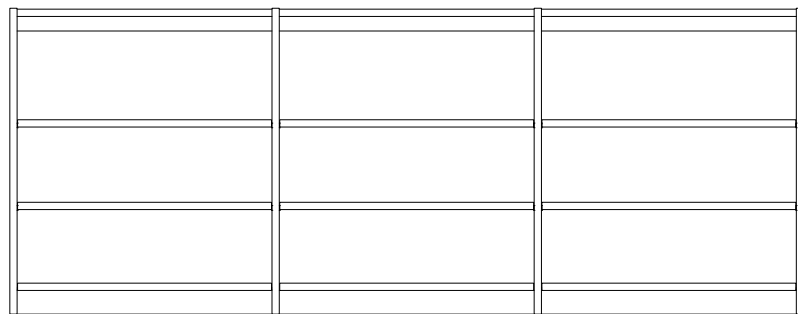

Starter

Adder

End

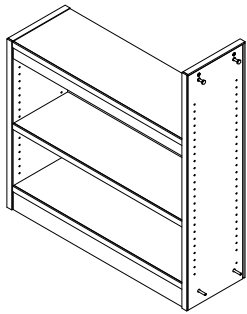

EV-SH-3012-36BC-VB-S-MT-HA42

Since this starter has a height of **30"** we will need to designate an adapter. This unit comes with a built in **height adapter** designated by **-HA42**.

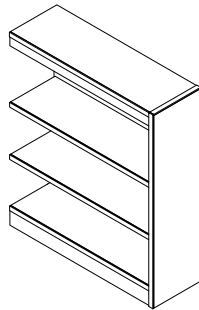

EV-SH-4212-36BC-VB-E-MT

This unit has a height of **42"**.

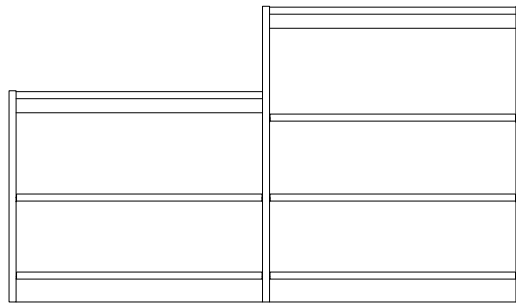

Everest

Shelf Details

The following images are provided as a reference to show the spacing/details and number of shelves for each of our standard heights to help with the planning process.

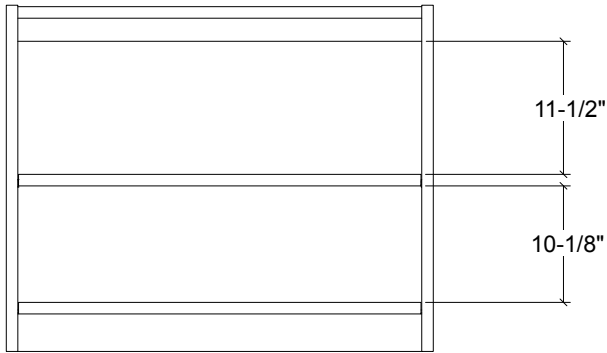

30" H Unit

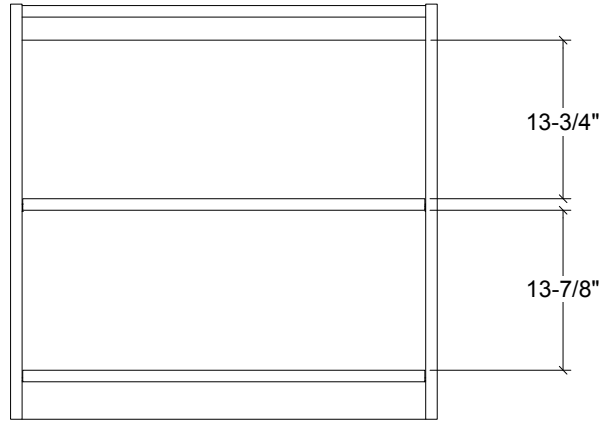

36" H Unit

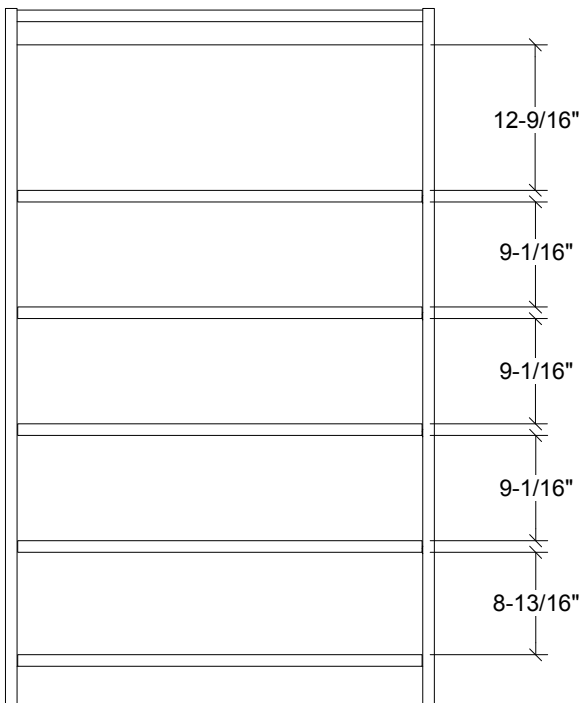

60" H Unit

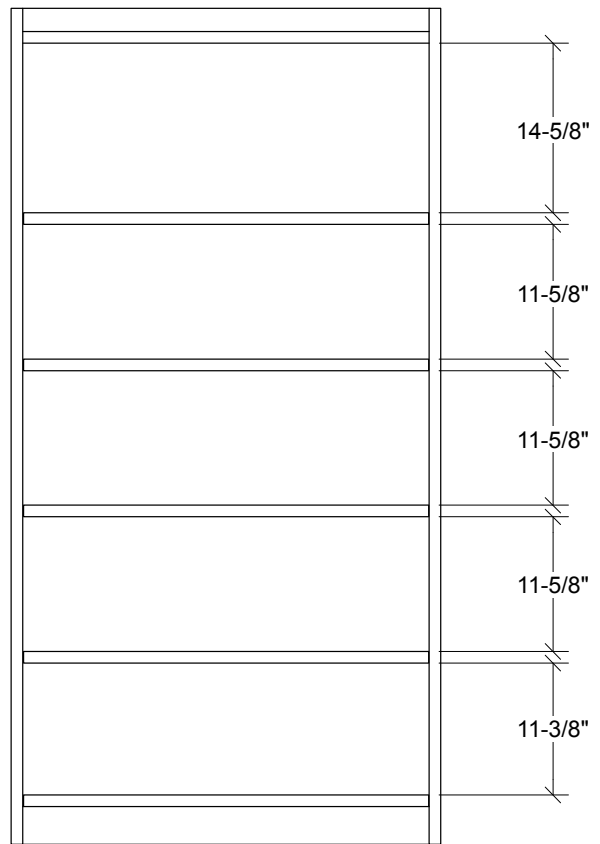

72" H Unit

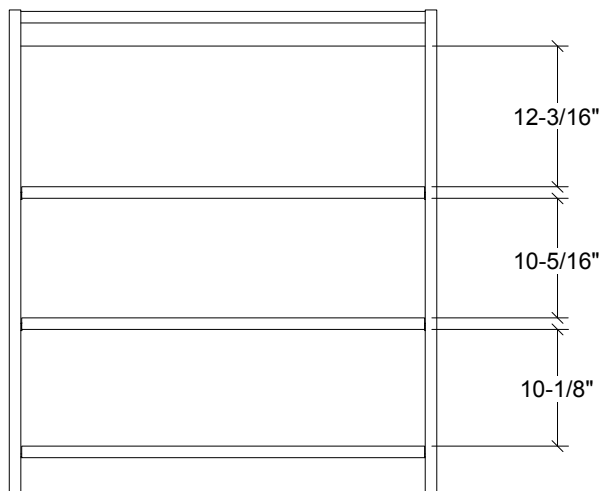

42" H Unit

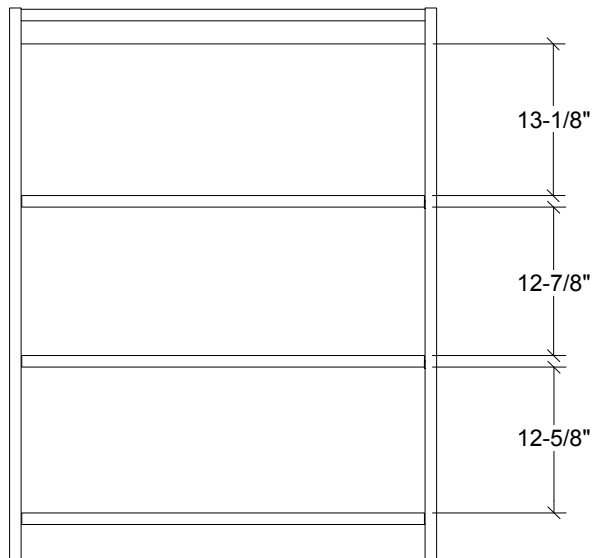

48" H Unit

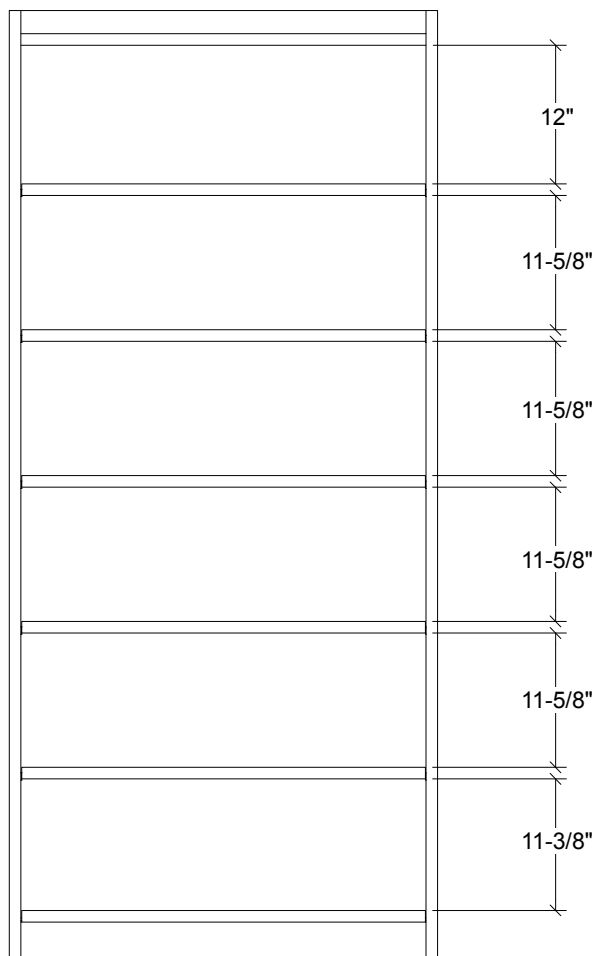

82" H Unit

LIAT Shipping Zones

Shipping | Pricing Guide

Use the following guide to **determine the delivered pricing** for your LIAT furniture product by **selecting your zone** from the map and reviewing the price changes for each zone. To **determine your list price**, add your prices from your selected furniture and then **add the shipping cost based on your designated zone**.

USA

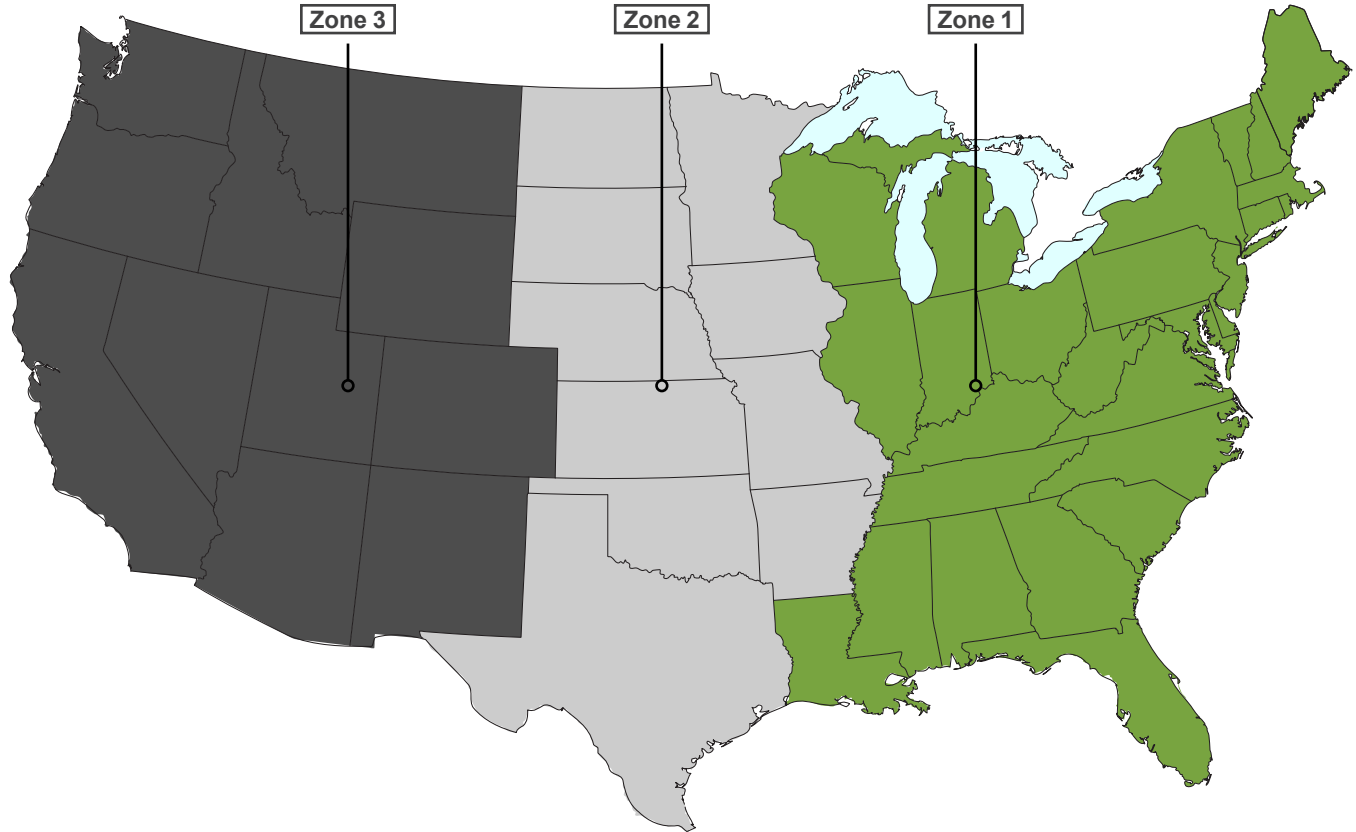

- Zone 1** No extra cost
- Zone 2** Add 4% to the list price
- Zone 3** Add 7% to the list price

Zone 1 orders less than \$5,000 list will have a freight minimum fee of **\$375** list.

Zone 2 orders less than \$5,000 list will have a freight minimum fee of **\$375** list, plus **4%** of list

Zone 3 orders less than \$5,000 list will have a freight minimum fee of **\$375** list, plus **7%** of list

Hawaii, Alaska, and International

Note. This system does not apply to our international customers or those living in Alaska and Hawaii, **freight must be quoted separately for these orders.**

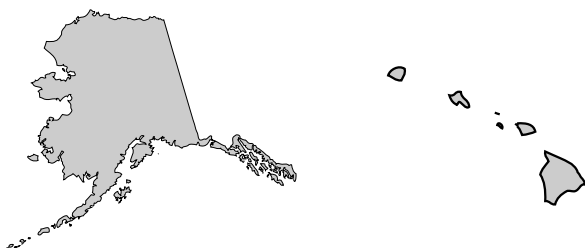

Example 1 Below \$5,000 list

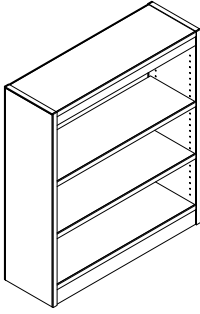

EV-SH-4212S-36BC-I-VB-MT

List Price - \$794

Nominal Size - 42" H x 12" D x 36" W

Actual Footprint - 42" H x 11-3/4" D x 37" W

Shelves - Book Case

Unit Type - Island

Top Style - Modular Top

Back Panel - Veneer Back

- **Zone 1** List Price: \$794 + \$375(flat fee) = **\$1,169**
- **Zone 2** List Price: \$794 + \$375(flat fee) + \$32(4% of list) = **\$1,201**
- **Zone 3** List Price: \$794 + \$375(flat fee) + \$55(7% of list) = **\$1,224**

Example 2 Above \$5,000 list

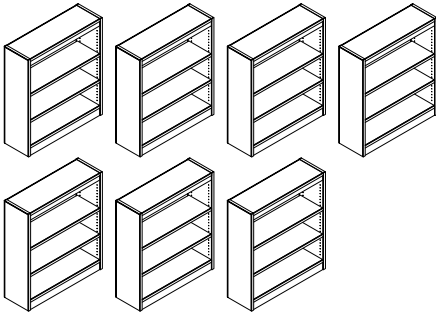

EV-SH-4212S-36BC-I-VB-MT

List Price - \$5,558

(more than one)

Nominal Size - 42" H x 12" D x 36" W

Actual Footprint - 42" H x 11-3/4" D x 37" W

Shelves - Book Case

Unit Type - Island

Top Style - Modular Top

Back Panel - Veneer Back

- **Zone 1** List Price: \$5,558 = **\$5,558**
- **Zone 2** List Price: \$5,558 + \$222(4% of list) = **\$5,780**
- **Zone 3** List Price: \$5,558 + \$389(7% of list) = **\$5,947**

*LIAT product is shipped knocked down (KD). Assembly in the field is required.

Pricing Guide Tutorial

How to use this pricing guide

These pages are a guide on how to build and customize your Everest table using this specification and pricing guide.

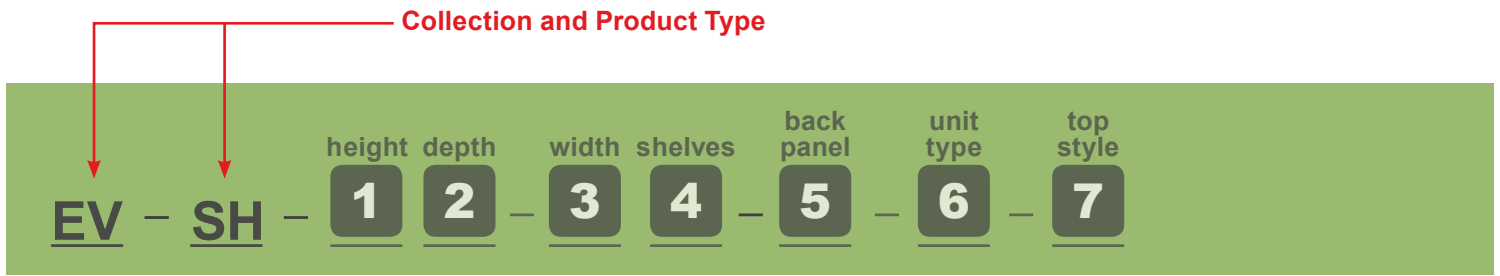

Required Selections ↑ ↑ ↑ ↑ ↑ ↑ ↑

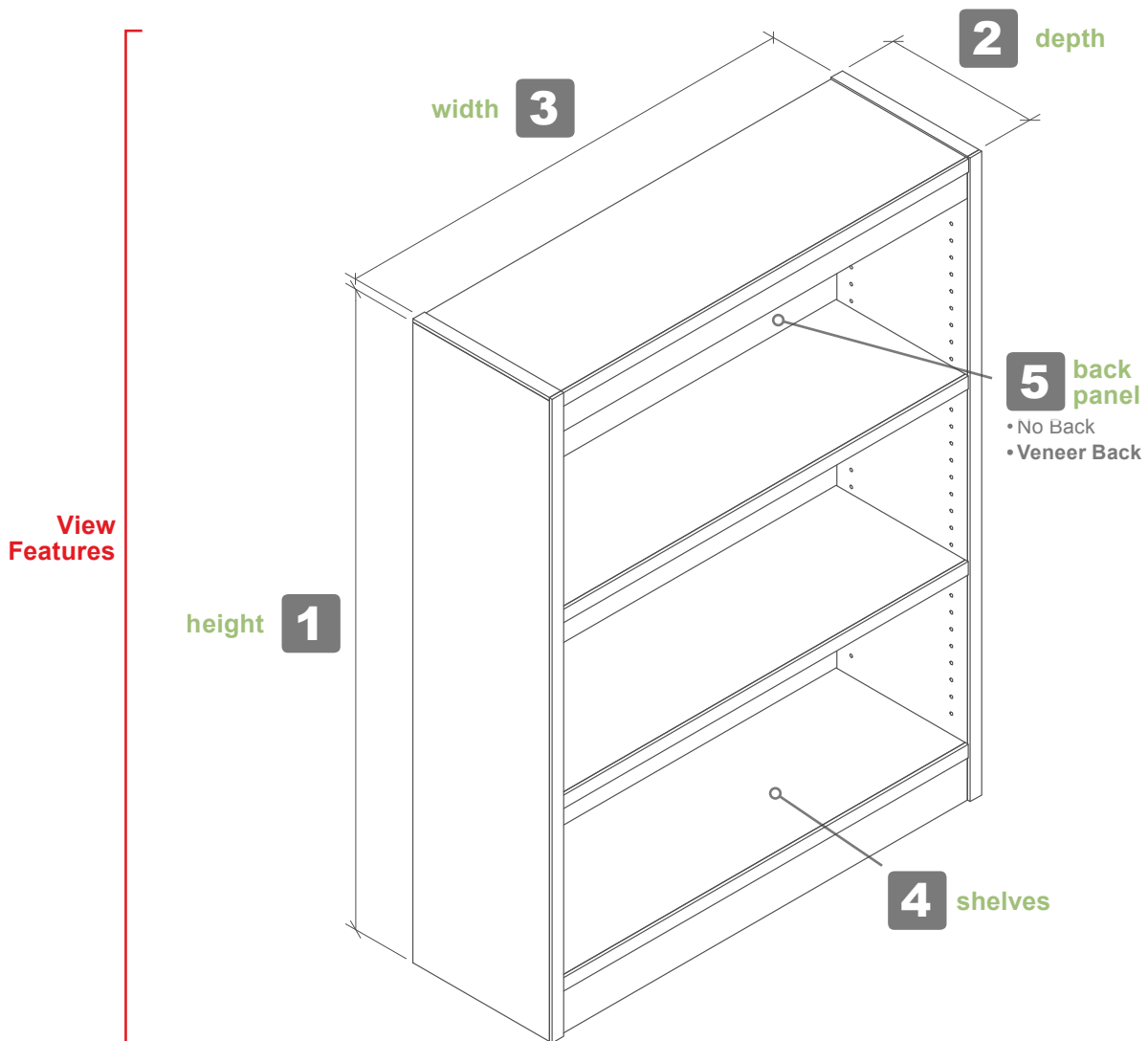

Unit Shown EV-SH-4812S-36BC-I-VB-MT

Shown options creating a unique product code

List Price: \$817

Price of unit shown

To compare various combinations, use price chart

Required Selections									
Component	Code	Description	30" High	36" High	42" High	48" High	60" High	72" High	82" High
1 Height	30	30" High Shelving	\$0	-	-	-	-	-	-
	36	36" High Shelving	-	\$0	-	-	-	-	-
	42	42" High Shelving	-	-	\$0	-	-	-	-
	48	48" High Shelving	-	-	-	\$0	-	-	-
	60	60" High Shelving	-	-	-	-	\$0	-	-
	72	72" High Shelving	-	-	-	-	-	\$0	-
	82	82" High Shelving	-	-	-	-	-	-	\$0
	2 Depth	10	10" Deep Shelving	\$345	\$357	\$449	\$460	\$645	\$668
12		12" Deep Shelving	\$373	\$386	\$481	\$495	\$684	\$711	\$815
3 Width	30	30" Wide Shelving	\$0	\$0	\$0	\$0	\$0	\$0	\$0
	31	31" Wide Shelving	\$0	\$0	\$0	\$0	\$0	\$0	\$0
	32	32" Wide Shelving	\$0	\$0	\$0	\$0	\$0	\$0	\$0
	33	33" Wide Shelving	\$0	\$0	\$0	\$0	\$0	\$0	\$0
	34	34" Wide Shelving	\$0	\$0	\$0	\$0	\$0	\$0	\$0
	35	35" Wide Shelving	\$0	\$0	\$0	\$0	\$0	\$0	\$0
	36	36" Wide Shelving	\$0	\$0	\$0	\$0	\$0	\$0	\$0
4 Shelves	BC	Book Case	\$0	\$0	\$0	\$0	\$0	\$0	\$0
	SS	Solid Shelves	\$66	\$66	\$99	\$99	\$165	\$165	\$198
	AD	Adjustable Dividers	\$130	\$130	\$195	\$195	\$325	\$325	\$390
	FD	Fixed Dividers	\$146	\$146	\$219	\$219	\$365	\$365	\$438
	PB	Picture Book	\$106	\$106	\$159	\$159	\$265	\$265	\$318
	TD	Triangular Dividers	\$106	\$106	\$159	\$159	\$265	\$265	\$318
	MG	Magazine	-	\$268	\$402	\$402	\$670	\$670	\$804
	MS	Metal	\$0	\$0	\$0	\$0	\$0	\$0	\$0
5 Back Panel	NB	No Back	\$0	\$0	\$0	\$0	\$0	\$0	\$0
	VB	Veneer Back	\$85	\$105	\$126	\$126	\$190	\$247	\$247
6 Unit Type	I	Island	\$69	\$82	\$96	\$110	\$137	\$164	\$187
	S	Starter	\$69	\$82	\$96	\$110	\$137	\$164	\$187
	A	Adder	\$0	\$0	\$0	\$0	\$0	\$0	\$0
	E	End	\$0	\$0	\$0	\$0	\$0	\$0	\$0
7 Top Style	CT	Continuous Top	\$0	\$0	\$0	\$0	\$0	\$0	\$0
	MT	Modular Top	\$86	\$86	\$86	\$86	\$86	\$86	\$86

EV-SH-4812S-36BC-I-VB-MT

\$817

Shelving

simple and modular



Everest

Shelving (Single Face) | Build Guide

Use the following guide to **determine the catalog number** for your Everest Shelving Unit by **selecting your choice** from the available options. To **determine your list price**, add all prices for your selected items from the table to the right.

EV - SH - **1** **2** - **3** **4** - **5** - **6** - **7**

height depth width shelves back panel unit type top style

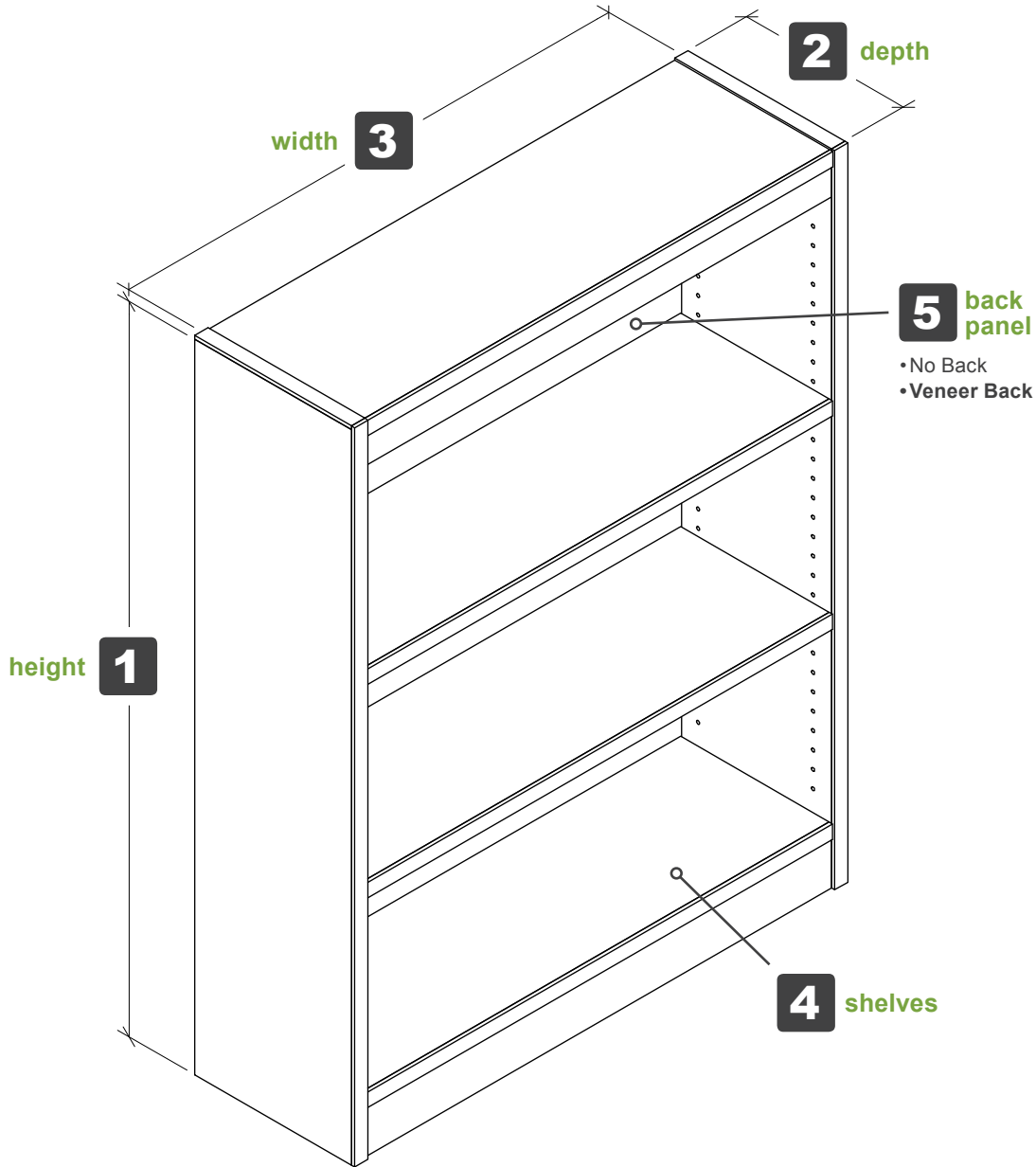

Unit Shown EV-SH-4812-36BC-VB-I-MT

List Price \$817

Required Selections										
Component	Code	Description	30" High	36" High	42" High	48" High	60" High	72" High	82" High	
1 Height	30	30" High Shelving	\$0	-	-	-	-	-	-	
	36	36" High Shelving	-	\$0	-	-	-	-	-	
	42	42" High Shelving	-	-	\$0	-	-	-	-	
	48	48" High Shelving	-	-	-	\$0	-	-	-	
	60	60" High Shelving	-	-	-	-	\$0	-	-	
	72	72" High Shelving	-	-	-	-	-	\$0	-	
	82	82" High Shelving	-	-	-	-	-	-	\$0	
2 Depth	10	10" Deep Shelving	\$345	\$357	\$449	\$460	\$645	\$668	\$768	
	12	12" Deep Shelving	\$373	\$386	\$481	\$495	\$684	\$711	\$815	
3 Width	30	30" Wide Shelving	\$0	\$0	\$0	\$0	\$0	\$0	\$0	
	31	31" Wide Shelving	\$0	\$0	\$0	\$0	\$0	\$0	\$0	
	32	32" Wide Shelving	\$0	\$0	\$0	\$0	\$0	\$0	\$0	
	33	33" Wide Shelving	\$0	\$0	\$0	\$0	\$0	\$0	\$0	
	34	34" Wide Shelving	\$0	\$0	\$0	\$0	\$0	\$0	\$0	
	35	35" Wide Shelving	\$0	\$0	\$0	\$0	\$0	\$0	\$0	
	36	36" Wide Shelving	\$0	\$0	\$0	\$0	\$0	\$0	\$0	
4 Shelves	BC	Book Case	\$0	\$0	\$0	\$0	\$0	\$0	\$0	
	SS	Solid Shelves	\$66	\$66	\$99	\$99	\$165	\$165	\$198	
	AD	Adjustable Dividers	\$130	\$130	\$195	\$195	\$325	\$325	\$390	
	FD	Fixed Dividers	\$146	\$146	\$219	\$219	\$365	\$365	\$438	
	PB	Picture Book	\$106	\$106	\$159	\$159	\$265	\$265	\$318	
	TD	Triangular Dividers	\$106	\$106	\$159	\$159	\$265	\$265	\$318	
	MG	Magazine	-	\$268	\$402	\$402	\$670	\$670	\$804	
	MS	Metal	\$0	\$0	\$0	\$0	\$0	\$0	\$0	
5 Back Panel	NB	No Back	\$0	\$0	\$0	\$0	\$0	\$0	\$0	
	VB	Veneer Back	\$85	\$105	\$126	\$126	\$190	\$247	\$247	
6 Unit Type	I	Island	\$69	\$82	\$96	\$110	\$137	\$164	\$187	
	S	Starter	\$69	\$82	\$96	\$110	\$137	\$164	\$187	
	A	Adder	\$0	\$0	\$0	\$0	\$0	\$0	\$0	
	E	End	\$0	\$0	\$0	\$0	\$0	\$0	\$0	
7 Top Style	CT	Continuous Top	\$0	\$0	\$0	\$0	\$0	\$0	\$0	
	-Continuous top ordered separately.									
	MT	Modular Top	\$86	\$86	\$86	\$86	\$86	\$86	\$86	

Continued

Available Upgrades									
Component	Code	Description	30" High	36" High	42" High	48" High	60" High	72" High	82" High
8	Fin Back	-Single Faced units not against a wall should be bolted to the ground.							
	No Back	-FB Finished Backs	\$154	\$154	\$154	\$154	\$154	\$154	\$154
	Veneer Back	-FB Finished Backs	\$195	\$211	\$222	\$222	\$255	\$291	\$291
9	Adapter	-HA30 Adapt to 30" High	-	\$0	\$0	\$0	\$0	\$0	\$0
		-HA36 Adapt to 36" High	\$13	-	\$0	\$0	\$0	\$0	\$0
		-HA42 Adapt to 42" High	\$27	\$14	-	\$0	\$0	\$0	\$0
		-HA48 Adapt to 48" High	\$41	\$28	\$14	-	\$0	\$0	\$0
		-HA60 Adapt to 60" High	\$68	\$55	\$41	\$27	-	\$0	\$0
		-HA72 Adapt to 72" High	\$95	\$82	\$68	\$54	\$27	-	\$0
		-HA82 Adapt to 82" High	\$118	\$105	\$91	\$77	\$50	\$23	-
-Height Adapters only available on Starter and Adder units.									

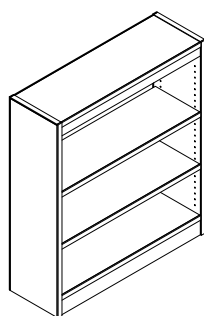

EV-SH-4212-36BC-VB-I-MT

List Price - \$789

Nominal Size - 42" H x 12" D x 36" W
Actual Footprint - 42" H x 11-3/4" D x 37" W
Shelves - Book Case
Unit Type - Island
Top Style - Modular Top
Back Panel - Veneer Back

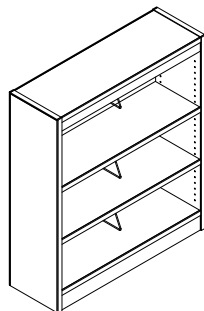

EV-SH-4212-36TD-VB-I-MT

List Price - \$948

Nominal Size - 42" H x 12" D x 36" W
Actual Footprint - 42" H x 11-3/4" D x 37" W
Shelves - Triangular Dividers
Unit Type - Island
Top Style - Modular Top
Back Panel - Veneer Back

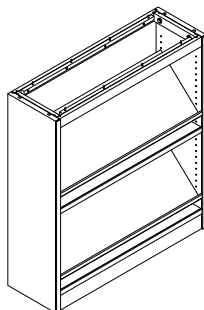

EV-SH-4212-36MG-VB-I-CT

List Price - \$1,105

Nominal Size - 42" H x 12" D x 36" W
Actual Footprint - 40-7/8" H x 11-3/4" D x 37" W
Shelves - Magazine
Unit Type - Island
Top Style - Continuous Top
Back Panel - Veneer Back

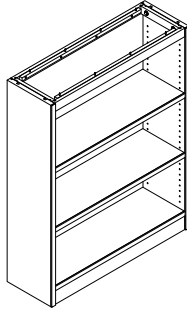

EV-SH-4812-36BC-VB-I-CT

List Price - \$731

Nominal Size - 48" H x 12" D x 36" W

Actual Footprint - 48" H x 11-3/4" D x 37" W

Shelves - Book Case

Unit Type - Island

Top Style - Continuous Top

Back Panel - Veneer Back

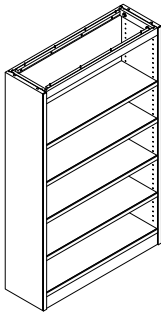

EV-SH-6012-36BC-VB-I-CT

List Price - \$1,011

Nominal Size - 60" H x 12" D x 36" W

Actual Footprint - 58-7/8" H x 11-3/4" D x 37" W

Shelves - Book Case

Unit Type - Island

Top Style - Continuous Top

Back Panel - Veneer Back

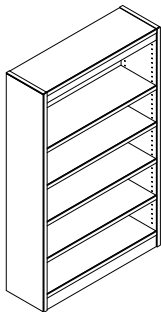

EV-SH-6012-36BC-VB-I-MT

List Price - \$1,097

Nominal Size - 60" H x 12" D x 36" W

Actual Footprint - 60" H x 11-3/4" D x 37" W

Shelves - Book Case

Unit Type - Island

Top Style - Modular Top

Back Panel - Veneer Back

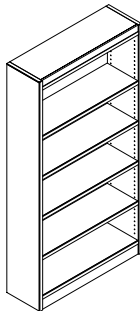

EV-SH-7212-36BC-VB-I-MT

List Price - \$1,208

Nominal Size - 72" H x 12" D x 36" W

Actual Footprint - 72" H x 11-3/4" D x 37" W

Shelves - Book Case

Unit Type - Island

Top Style - Modular Top

Back Panel - Veneer Back

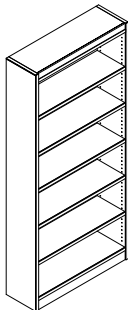

EV-SH-8212-36BC-VB-I-MT

List Price - \$1,335

Nominal Size - 82" H x 12" D x 36" W

Actual Footprint - 82" H x 11-3/4" D x 37" W

Shelves - Book Case

Unit Type - Island

Top Style - Modular Top

Back Panel - Veneer Back

Everest

Shelving (Double Face) | Build Guide

Use the following guide to **determine the catalog number** for your Everest Shelving Unit by **selecting your choice** from the available options. To **determine your list price**, add all prices for your selected items from the table to the right.

EV - SH - **1** **2** **3** - **4** - **5** - **6** - **7**

height depth width shelves back panel unit type top style

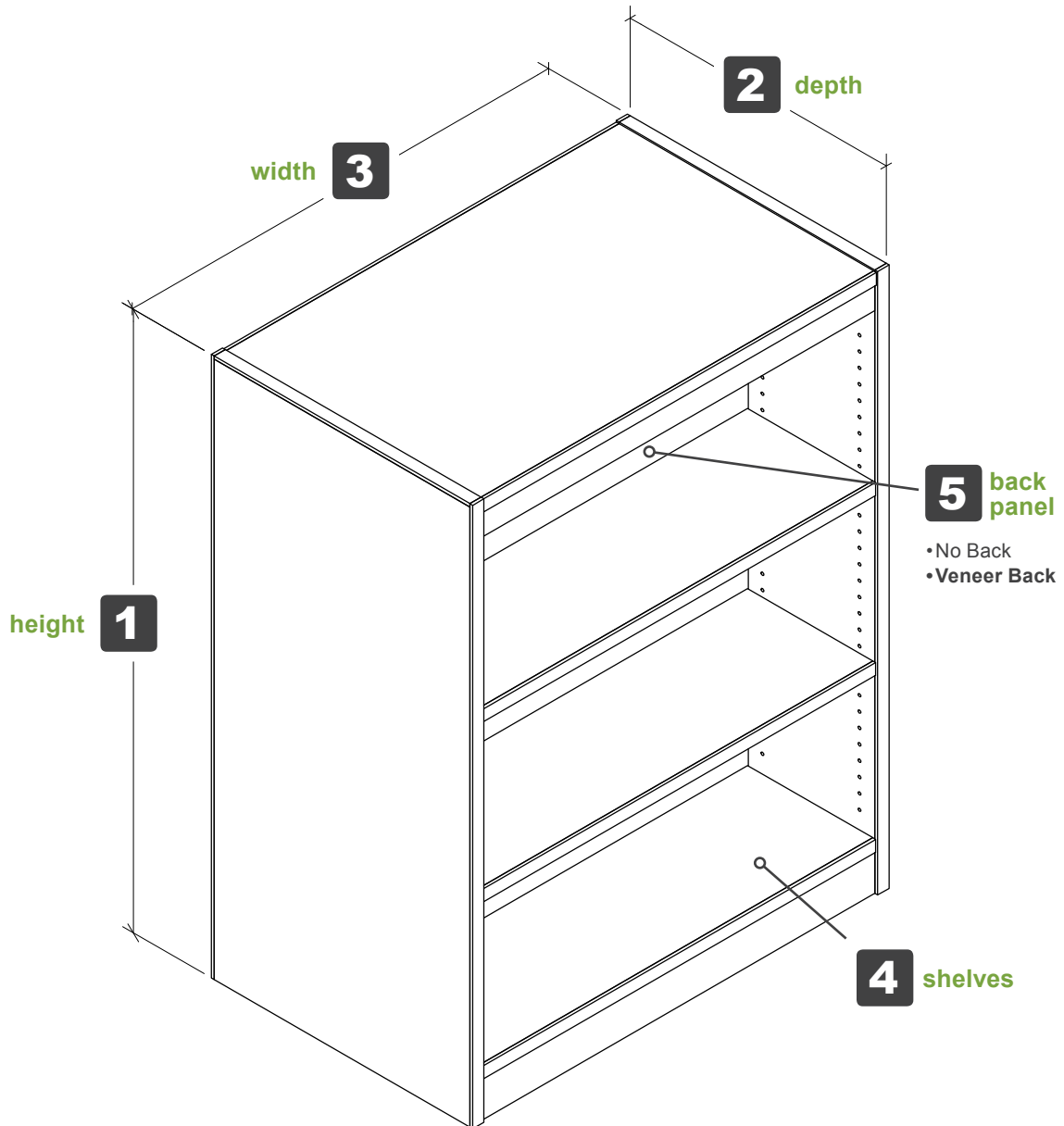

Unit Shown EV-SH-4824-36BC-VB-I-MT

List Price \$1,622

Required Selections										
Component	Code	Description	30" High	36" High	42" High	48" High	60" High	72" High	82" High	
1	Height	30	30" High Shelving	\$0	-	-	-	-	-	-
		36	36" High Shelving	-	\$0	-	-	-	-	-
		42	42" High Shelving	-	-	\$0	-	-	-	-
		48	48" High Shelving	-	-	-	\$0	-	-	-
		60	60" High Shelving	-	-	-	-	\$0	-	-
		72	72" High Shelving	-	-	-	-	-	\$0	-
		82	82" High Shelving	-	-	-	-	-	-	\$0
2	Depth	20	20" Deep Shelving	\$730	\$753	\$938	\$960	\$1,330	\$1,375	\$1,575
		24	24" Deep Shelving	\$793	\$820	\$1,009	\$1,037	\$1,415	\$1,470	\$1,677
3	Width	30	30" Wide Shelving	\$0	\$0	\$0	\$0	\$0	\$0	\$0
		31	31" Wide Shelving	\$0	\$0	\$0	\$0	\$0	\$0	\$0
		32	32" Wide Shelving	\$0	\$0	\$0	\$0	\$0	\$0	\$0
		33	33" Wide Shelving	\$0	\$0	\$0	\$0	\$0	\$0	\$0
		34	34" Wide Shelving	\$0	\$0	\$0	\$0	\$0	\$0	\$0
		35	35" Wide Shelving	\$0	\$0	\$0	\$0	\$0	\$0	\$0
		36	36" Wide Shelving	\$0	\$0	\$0	\$0	\$0	\$0	\$0
4	Shelves	BC	Book Case	\$0	\$0	\$0	\$0	\$0	\$0	\$0
		SS	Solid Shelves	\$132	\$132	\$198	\$198	\$330	\$330	\$396
		AD	Adjustable Dividers	\$260	\$260	\$390	\$390	\$650	\$650	\$780
		FD	Fixed Dividers	\$292	\$292	\$438	\$438	\$730	\$730	\$876
		PB	Picture Book	\$212	\$212	\$318	\$318	\$530	\$530	\$636
		TD	Triangular Dividers	\$212	\$212	\$318	\$318	\$530	\$530	\$636
		MG	Magazine	-	\$536	\$804	\$804	\$1,340	\$1,340	\$1,608
		MS	Metal	\$0	\$0	\$0	\$0	\$0	\$0	\$0
5	Back Panel	NB	No Back	\$0	\$0	\$0	\$0	\$0	\$0	\$0
		VB	Veneer Back	\$126	\$162	\$194	\$194	\$291	\$384	\$384
6	Unit Type	I	Island	\$137	\$164	\$191	\$219	\$273	\$328	\$373
		S	Starter	\$137	\$164	\$191	\$219	\$273	\$328	\$373
		A	Adder	\$0	\$0	\$0	\$0	\$0	\$0	\$0
		E	End	\$0	\$0	\$0	\$0	\$0	\$0	\$0
7	Top Style	CT	Continuous Top	\$0	\$0	\$0	\$0	\$0	\$0	\$0
		-Continuous top ordered separately.								
		MT	Modular Top	\$172	\$172	\$172	\$172	\$172	\$172	\$172

Continued

Available Upgrades									
Component	Code	Description	30" High	36" High	42" High	48" High	60" High	72" High	82" High
8	Casters	-CA Casters	\$212	\$212	\$212	\$212	\$212	-	-
-Includes (4) casters. Not available on units over 60" high.									
9	Adapter	-HA30 Adapt to 30" High	-	\$0	\$0	\$0	\$0	\$0	\$0
		-HA36 Adapt to 36" High	\$27	-	\$0	\$0	\$0	\$0	\$0
		-HA42 Adapt to 42" High	\$54	\$27	-	\$0	\$0	\$0	\$0
		-HA48 Adapt to 48" High	\$82	\$55	\$28	-	\$0	\$0	\$0
		-HA60 Adapt to 60" High	\$136	\$109	\$82	\$54	-	\$0	\$0
		-HA72 Adapt to 72" High	\$191	\$164	\$137	\$109	\$55	-	\$0
		-HA82 Adapt to 82" High	\$236	\$209	\$182	\$154	\$100	\$45	-
-Height Adapters only available on Starter and Adder units.									

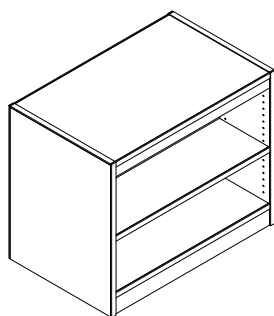

EV-SH-3024-36BC-VB-I-MT

List Price - \$1,228

Nominal Size - 30" H x 24" D x 36" W
Actual Footprint - 30" H x 23-1/4" D x 37" W
Shelves - Book Case
Unit Type - Island
Top Style - Modular Top
Back Panel - Veneer Back

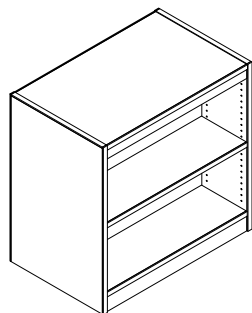

EV-SH-3624-36BC-VB-I-MT

List Price - \$1,318

Nominal Size - 36" H x 24" D x 36" W
Actual Footprint - 36" H x 23-1/4" D x 37" W
Shelves - Book Case
Unit Type - Island
Top Style - Modular Top
Back Panel - Veneer Back

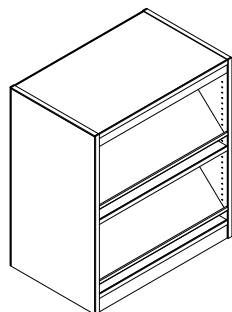

EV-SH-4224-36MG-VB-I-MT

List Price - \$2,370

Nominal Size - 42" H x 24" D x 36" W
Actual Footprint - 42" H x 23-1/4" D x 37" W
Shelves - Magazine
Unit Type - Island
Top Style - Modular Top
Back Panel - Veneer Back

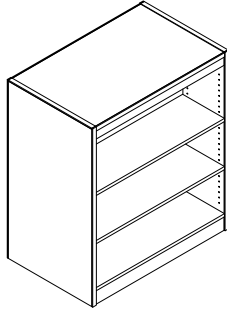

EV-SH-4224-36BC-VB-I-MT

List Price - \$1,566

Nominal Size - 42" H x 24" D x 36" W
Actual Footprint - 42" H x 23-1/4" D x 37" W
Shelves - Book Case
Unit Type - Island
Top Style - Modular Top
Back Panel - Veneer Back

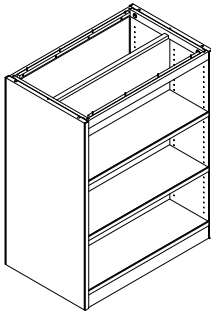

EV-SH-4824-36BC-VB-I-CT

List Price - \$1,450

Nominal Size - 48" H x 24" D x 36" W
Actual Footprint - 48" H x 23-1/4" D x 37" W
Shelves - Book Case
Unit Type - Island
Top Style - Continuous Top
Back Panel - Veneer Back

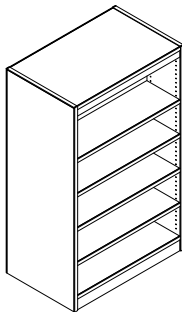

EV-SH-6024-36BC-VB-I-MT

List Price - \$2,151

Nominal Size - 60" H x 24" D x 36" W
Actual Footprint - 60" H x 23-1/4" D x 37" W
Shelves - Book Case
Unit Type - Island
Top Style - Modular Top
Back Panel - Veneer Back

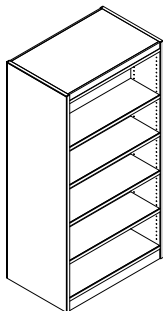

EV-SH-7224-36BC-VB-I-MT

List Price - \$2,354

Nominal Size - 72" H x 24" D x 36" W
Actual Footprint - 72" H x 23-1/4" D x 37" W
Shelves - Book Case
Unit Type - Island
Top Style - Modular Top
Back Panel - Veneer Back

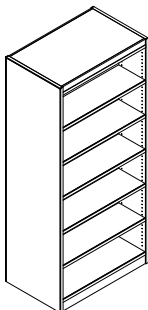

EV-SH-8224-36BC-VB-I-MT

List Price - \$2,606

Nominal Size - 82" H x 24" D x 36" W
Actual Footprint - 82" H x 23-1/4" D x 37" W
Shelves - Book Case
Unit Type - Island
Top Style - Modular Top
Back Panel - Veneer Back

Everest

Continuous Tops | Build Guide

Use the following guide to **determine the catalog number** for your Everest Storage Unit by **selecting your choice** from the available options. To **determine your list price**, add all prices for your selected items from the table to the right.

EV - **SH** - **1** - **2** - **3** - **4**

unit depth unit length top style top type

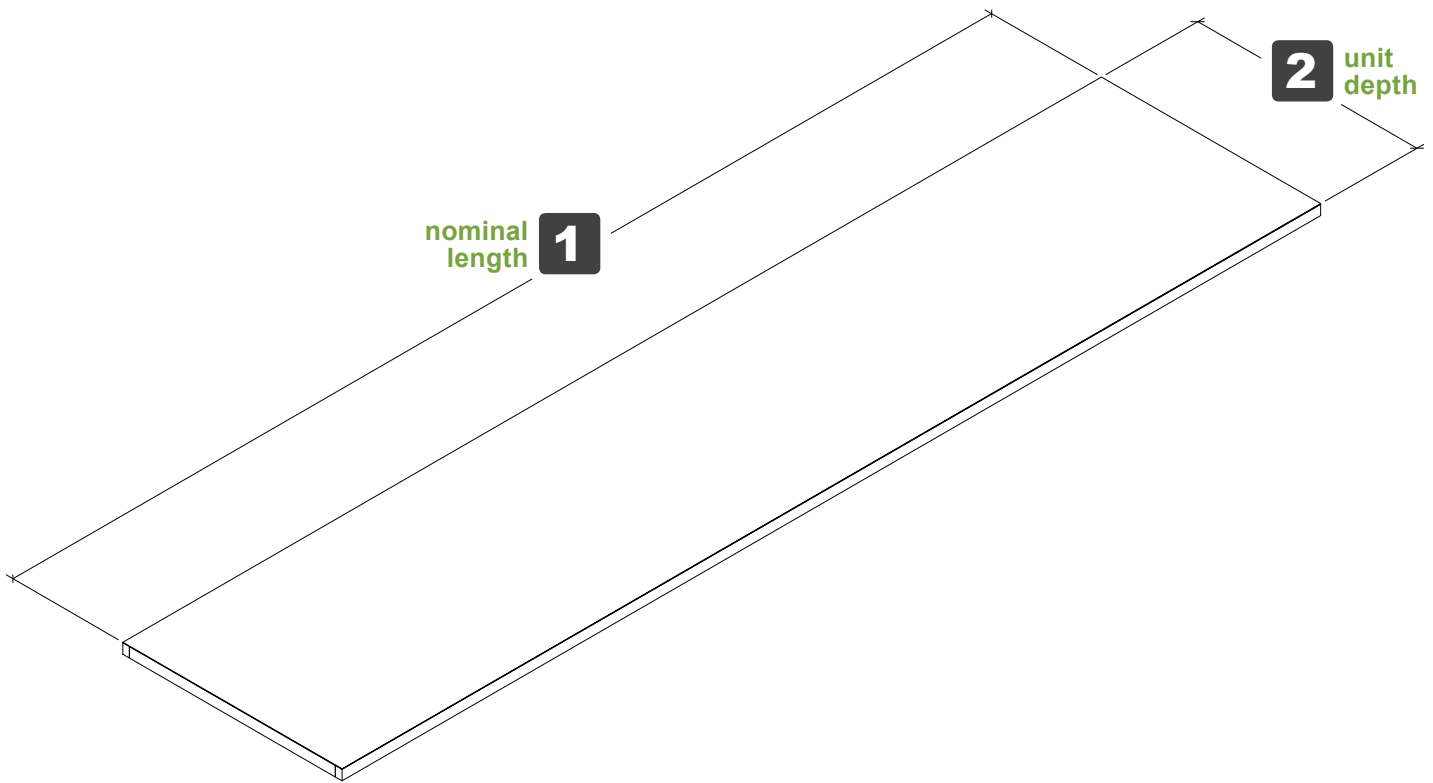

Unit Shown EV-SH-2496CT-I

List Price \$686

Required Selections						
Component	Code	Description	10" Deep	12" Deep	20" Deep	24" Deep
1 Unit Depth	10	10" Deep Shelving	\$0	-	-	-
	12	12" Deep Shelving	-	\$0	-	-
	20	20" Deep Shelving	-	-	\$0	-
	24	24" Deep Shelving	-	-	-	\$0
2 Nominal Length	30	30" Long Shelving	\$107	\$125	\$194	\$229
	31	31" Long Shelving	\$110	\$128	\$200	\$236
	32	32" Long Shelving	\$113	\$132	\$206	\$243
	33	33" Long Shelving	\$116	\$135	\$211	\$249
	34	34" Long Shelving	\$119	\$139	\$217	\$256
	35	35" Long Shelving	\$122	\$142	\$223	\$263
	36	36" Long Shelving	\$125	\$145	\$229	\$270
	60	60" Long Shelving	\$194	\$229	\$367	\$437
	62	62" Long Shelving	\$200	\$236	\$379	\$451
	64	64" Long Shelving	\$206	\$243	\$390	\$464
	66	66" Long Shelving	\$211	\$249	\$402	\$478
	68	68" Long Shelving	\$217	\$256	\$414	\$492
	70	70" Long Shelving	\$223	\$263	\$425	\$506
	72	72" Long Shelving	\$229	\$270	\$437	\$520
	90	90" Long Shelving	\$281	\$333	\$541	\$645
	93	93" Long Shelving	\$289	\$343	\$558	\$665
96	96" Long Shelving	\$298	\$353	\$575	\$686	
3 Top Style	CT	Continuous Top	\$0	\$0	\$0	\$0
4 Top Type	I	Island	\$0	\$0	\$0	\$0
	S	Starter	\$0	\$0	\$0	\$0
	A	Adder	\$0	\$0	\$0	\$0
	E	End	\$0	\$0	\$0	\$0
Available Upgrades						
Component	Code	Description	10" Deep	12" Deep	20" Deep	24" Deep
5 Surface	-VN	Veneer Top	\$0	\$0	\$0	\$0

Everest

Doors | Build Guide

Use the following guide to **determine the catalog number** for your Everest Doors by **selecting your choice** from the available options. To **determine your list price**, add all prices for your selected items from the table to the right. Locks come standard on right hand door. *All doors 60" H or more come with a lock located in the center, doors under 60" H have a lock located at the top.*

EV - **SH** - **1** - **2** - **3**

height door style width

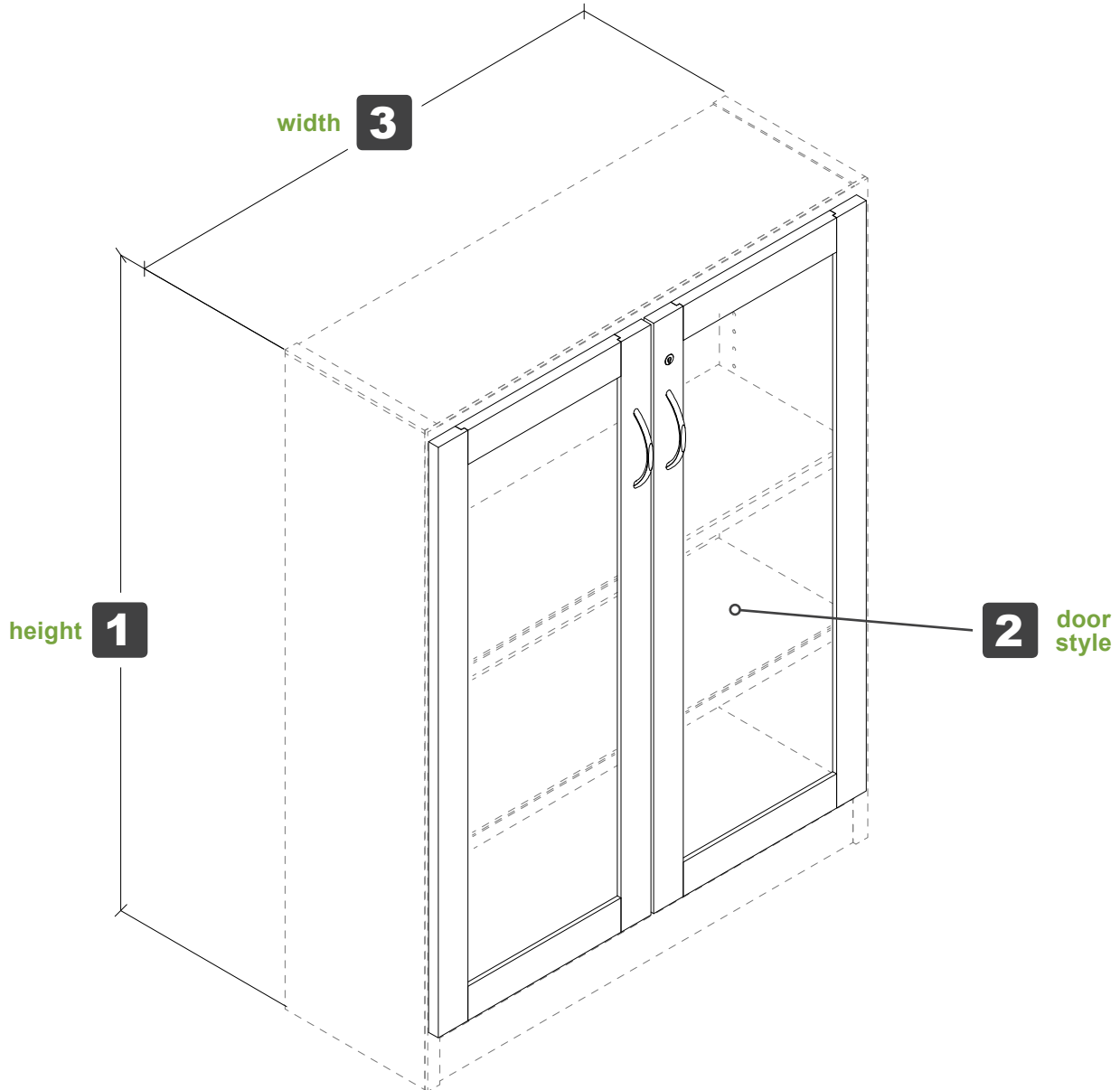

Unit Shown EV-SH-48GD-36

List Price \$649

Required Selections										
Component	Code	Description	30" High	36" High	42" High	48" High	60" High	72" High	82" High	
1	Height	30	30" High Shelving	\$0	-	-	-	-	-	-
		36	36" High Shelving	-	\$0	-	-	-	-	-
		42	42" High Shelving	-	-	\$0	-	-	-	-
		48	48" High Shelving	-	-	-	\$0	-	-	-
		60	60" High Shelving	-	-	-	-	\$0	-	-
		72	72" High Shelving	-	-	-	-	-	\$0	-
		82	82" High Shelving	-	-	-	-	-	-	\$0
2	Door Style	PD	Panel Doors	\$292	\$330	\$369	\$407	\$483	\$559	\$623
		GD	Framed Glass Doors	\$444	\$512	\$581	\$649	\$786	\$923	\$1,037
3	Width	30	30" Wide Shelving	\$0	\$0	\$0	\$0	\$0	\$0	\$0
		31	31" Wide Shelving	\$0	\$0	\$0	\$0	\$0	\$0	\$0
		32	32" Wide Shelving	\$0	\$0	\$0	\$0	\$0	\$0	\$0
		33	33" Wide Shelving	\$0	\$0	\$0	\$0	\$0	\$0	\$0
		34	34" Wide Shelving	\$0	\$0	\$0	\$0	\$0	\$0	\$0
		35	35" Wide Shelving	\$0	\$0	\$0	\$0	\$0	\$0	\$0
		36	36" Wide Shelving	\$0	\$0	\$0	\$0	\$0	\$0	\$0

Everest

Face Fillers | Build Guide

Use the following guide to **determine the catalog number** for your Everest Storage Unit by **selecting your choice** from the available options. To **determine your list price**, add all prices for your selected items from the table to the right.

EV - SH -

height	width	filler style
1	2	3

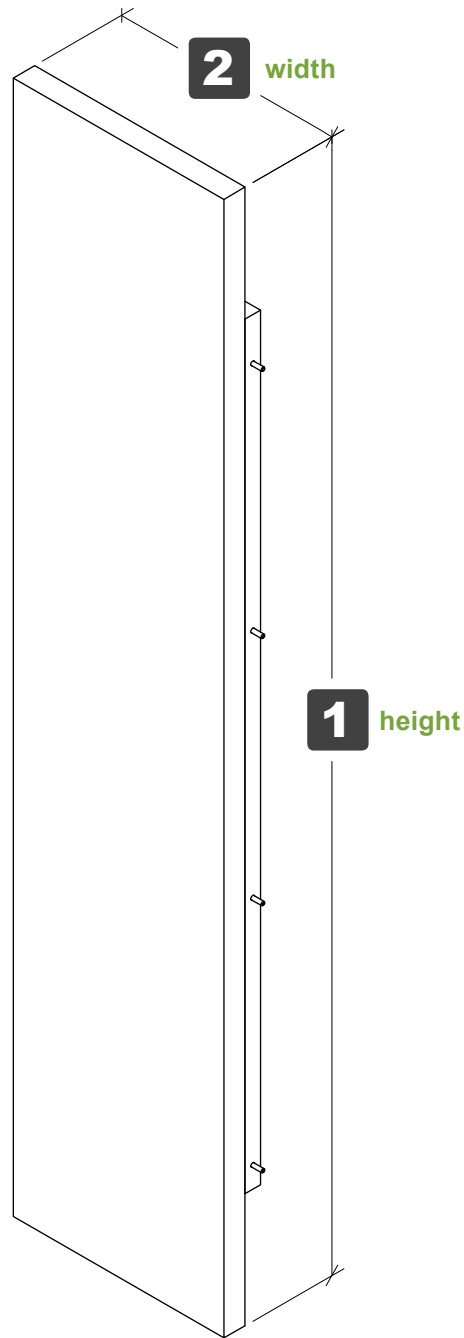

Unit Shown EV-SH-4810FF

List Price \$112

Required Selections										
Component	Code	Description	30" High	36" High	42" High	48" High	60" High	72" High	82" High	
1	Height	30	30" High Shelving	\$0	-	-	-	-	-	-
		36	36" High Shelving	-	\$0	-	-	-	-	-
		42	42" High Shelving	-	-	\$0	-	-	-	-
		48	48" High Shelving	-	-	-	\$0	-	-	-
		60	60" High Shelving	-	-	-	-	\$0	-	-
		72	72" High Shelving	-	-	-	-	-	\$0	-
		82	82" High Shelving	-	-	-	-	-	-	\$0
2	Width	10	10" Wide Filler	\$77	\$89	\$100	\$112	\$134	\$157	\$176
		12	12" Wide Filler	\$89	\$102	\$116	\$130	\$157	\$184	\$207
3	Filler Style	FF	Face Filler	\$0	\$0	\$0	\$0	\$0	\$0	\$0

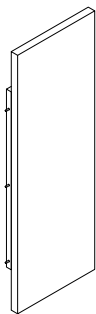

EV-SH-3612FF

List Price - \$102

Size - 36" H x 12" W

Style - Face Filler

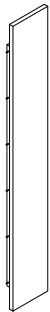

EV-SH-7210FF

List Price - \$157

Size - 72" H x 10" W

Style - Face Filler

Everest

Top Fillers | Build Guide

Use the following guide to **determine the catalog number** for your Everest Storage Unit by **selecting your choice** from the available options. To **determine your list price**, add all prices for your selected items from the table to the right.

EV - SH - 1 2 3

depth length filler style

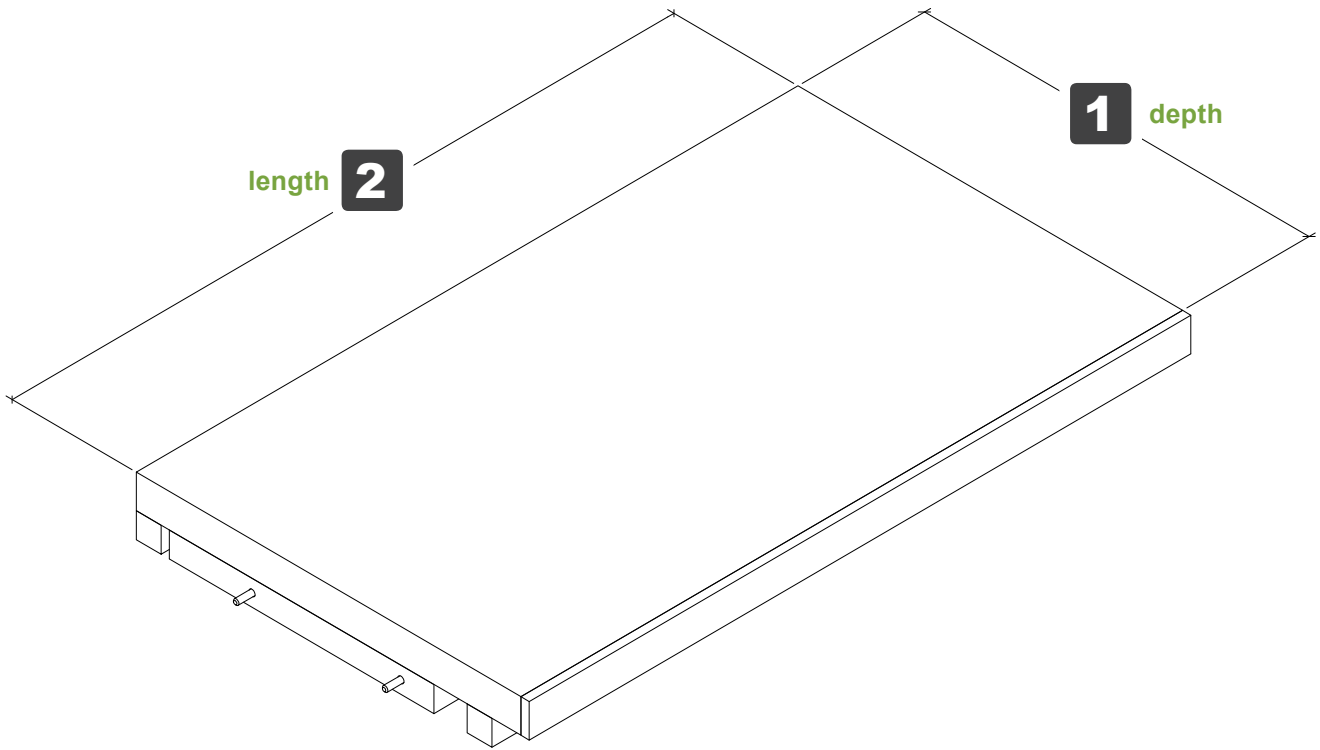

Unit Shown EV-SH-1220TF

List Price \$66

Required Selections				
Component	Code	Description	10" Deep	12" Deep
1 Filler Depth	10	10" Deep Filler	\$0	-
	12	12" Deep Filler	-	\$0
2 Filler Length	10	10" Long Filler	\$40	\$43
	12	12" Long Filler	\$43	\$48
	20	20" Long Filler	\$59	\$66
	24	24" Long Filler	\$66	\$75
3 Filler Style	TF	Top Filler	\$0	\$0
	CF	Corner Filler	\$0	\$0

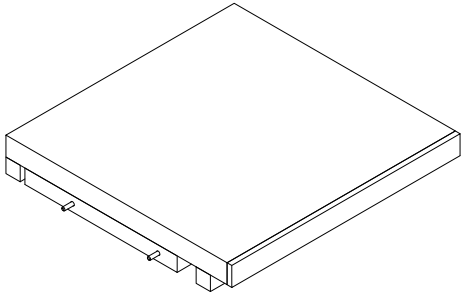

EV-SH-1212TF

Size - 11 7/8" D x 12" W x 1 3/4" H

Style - Top Filler

List Price - \$48

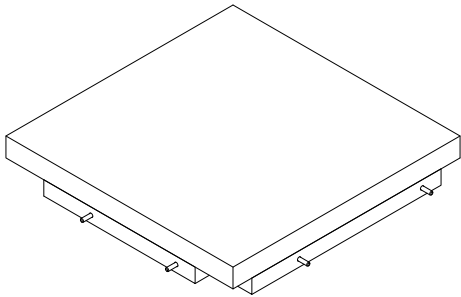

EV-SH-1212CF

Size - 12" D x 12" W x 1 3/4" H

Style - Corner Filler

List Price - \$48

Everest

Shelving | Popular Items

The following products are **popular and frequently ordered Everest Shelving items**. The catalog number, description, actual footprint, and list prices are all provided. The items can be used exactly as-is, as a starting point for budgetary purposes, or simply as examples. Contact project management for any further information.

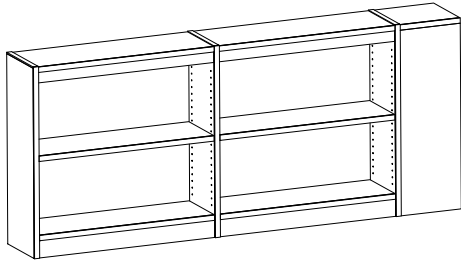

EV-SH-PC04-01

- (1) EV-SH-3612-36BC-VB-S-MT
 - (1) EV-SH-3612-36BC-VB-E-MT
 - (1) EV-SH-3612FF
 - (1) EV-SH-1212TF
- 4-Shelf combination*

List Price - \$1,386

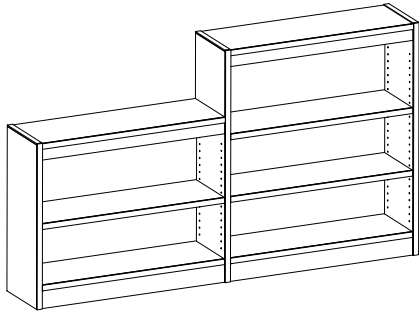

EV-SH-PC05-01

- (1) EV-SH-3012-36BC-VB-S-MT-HA42
 - (1) EV-SH-4212-36BC-VB-E-MT
- 5-Shelf combination*

List Price - \$1,333

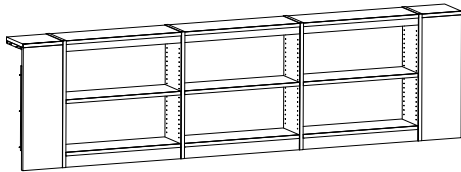

EV-SH-PC06-01

- (1) EV-SH-3612-36BC-VB-S-MT
 - (1) EV-SH-3612-36BC-VB-A-MT
 - (1) EV-SH-3612-36BC-VB-E-MT
 - (2) EV-SH-3612FF
 - (2) EV-SH-1212TF
- 6-Shelf combination*

List Price - \$2,113

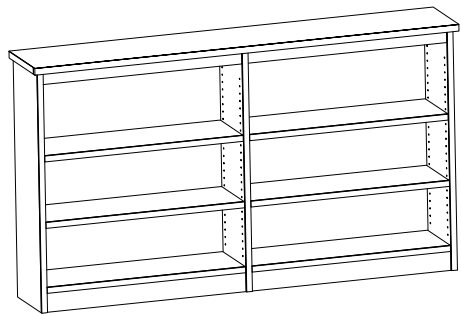

EV-SH-PC06-02

- (1) EV-SH-4212-36BC-VB-S-CT
 - (1) EV-SH-4212-36BC-VB-E-CT
 - (1) EV-SH-1272CT-I
- 6-Shelf combination*

List Price - \$1,580

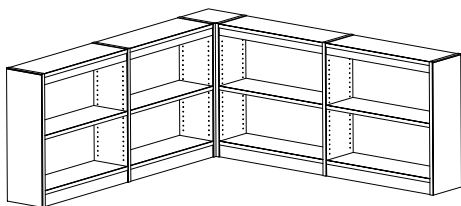

EV-SH-PC08-01

- (2) EV-SH-3612-36BC-VB-S-MT
 - (2) EV-SH-3612-36BC-VB-E-MT
 - (1) EV-SH-1212CF
- 8-Shelf combination*

List Price - \$2,520

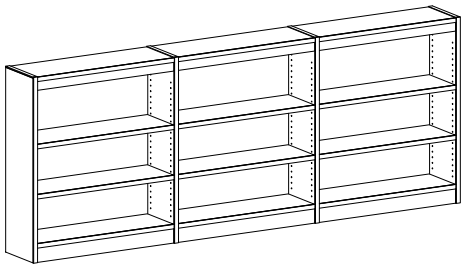

EV-SH-PC09-01

List Price - \$2,175

- (1) EV-SH-4212-36BC-VB-S-MT
 - (1) EV-SH-4212-36BC-VB-A-MT
 - (1) EV-SH-4212-36BC-VB-E-MT
- 9-Shelf combination

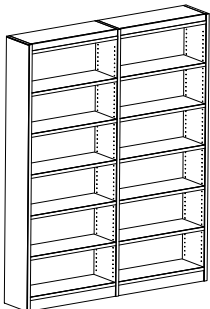

EV-SH-PC12-01

List Price - \$2,483

- (1) EV-SH-8212-36BC-VB-S-MT
 - (1) EV-SH-8212-36BC-VB-E-MT
- 12-Shelf combination

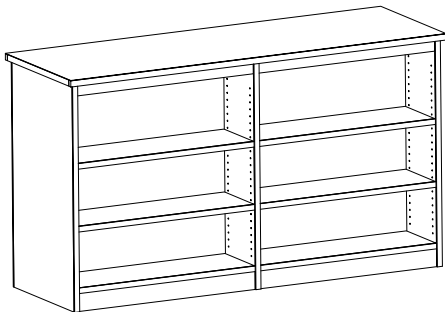

EV-SH-PC12-02

List Price - \$3,117

- (1) EV-SH-4224-36BC-VB-S-CT
 - (1) EV-SH-4224-36BC-VB-E-CT
 - (1) EV-SH-2472CT-I
- 12-Shelf combination

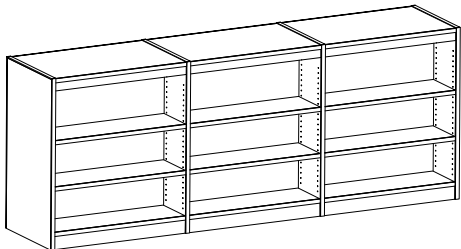

EV-SH-PC18-01

List Price - \$4,316

- (1) EV-SH-4224-36BC-VB-S-MT
 - (1) EV-SH-4224-36BC-VB-A-MT
 - (1) EV-SH-4224-36BC-VB-E-MT
- 18-Shelf combination

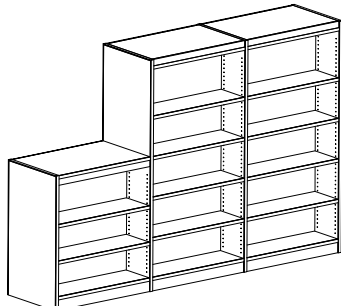

EV-SH-PC26-01

List Price - \$5,755

- (1) EV-SH-4224-36BC-VB-S-MT-HA72
 - (1) EV-SH-7224-36BC-VB-A-MT
 - (1) EV-SH-7224-36BC-VB-E-MT
- 26-Shelf combination

Display
elegant and aesthetically pleasing



Everest

Display

The following products are **popular and frequently display units**. The catalog number, description, actual footprint, and list prices are all provided. Contact project management for any further information.

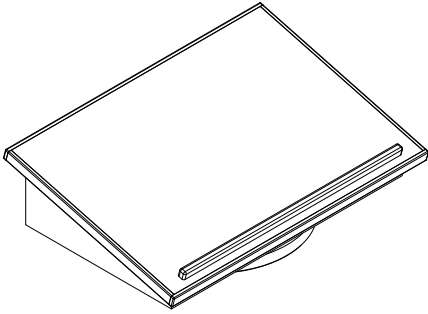

EV-DS-2107RDS

Revolving Dictionary Stand

List Price - \$524

Actual Footprint - 13 7/8" D x 20 7/8" W x 5 1/2" H

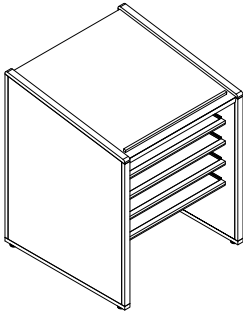

EV-DS-36AS

Atlas Stand; Juvenile Height

List Price - \$2,110

Actual Footprint - 28 7/8" D x 28 1/2" W x 36" H

Slide Color - Ivory (-IV); Brown (-BR)

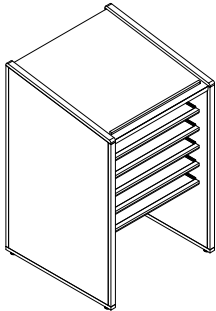

EV-DS-45AS

Atlas Stand; Standard Height

List Price - \$2,110

Actual Footprint - 28-7/8" D x 28-1/2" W x 45" H

Slide Color - Ivory (-IV); Brown (-BR)

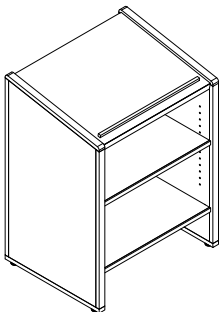

EV-DS-36DS

Dictionary Stand; Juvenile Height

List Price - \$1,400

Actual Footprint - 20-7/8" D x 26-1/2" W x 36" H

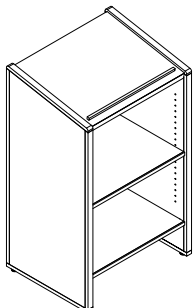

EV-DS-45DS

Dictionary Stand; Standard Height

List Price - \$1,400

Actual Footprint - 20-7/8" D x 26-1/2" W x 45" H

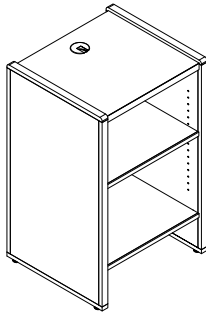

EV-DS-2023PAC-36

PAC Station; Juvenile Height

List Price - \$1,400

Nominal Size - 20" D x 23" W x 36" H

Actual Footprint - 20-7/8" D x 23" W x 36" H

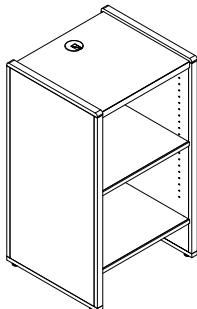

EV-DS-2023PAC-40

PAC Station; Standard Height

List Price - \$1,400

Nominal Size - 20" D x 23" W x 40" H

Actual Footprint - 20-7/8" D x 23" W x 40" H

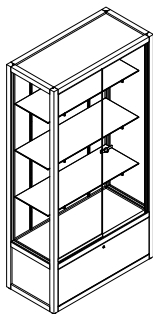

EV-DS-4882EC

Exhibit Case

List Price - \$4,398

Actual Footprint - 20" D x 48" W x 81 1/4" H

A glass back (-GB) may be added for \$944 list.

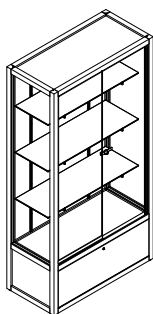

EV-DS-4882EC-LL

Exhibit Case; LED Lighting

List Price - \$4,750

Actual Footprint - 20" D x 48" W x 81 1/4" H

A glass back (-GB) may be added for \$944 list.

LED lighting (-LL) may be added for \$355 list

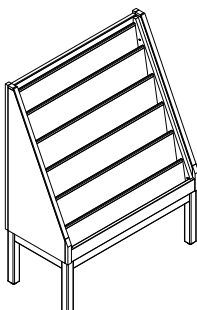

EV-DS-1836MR-48

Magazine Rack; Small

List Price - \$1,885

Nominal Size - 18" D x 37" W x 48" H

Actual Footprint - 17-7/16" D x 36-1/2" W x 48" H

Everest Display

The following products are **display units**. The catalog number, description, actual footprint, and list prices are all provided. Contact project management for any further information.

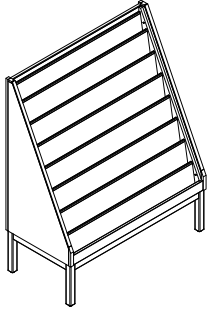

EV-DS-2448MR-60

Magazine Rack; Large

List Price - \$2,742

Actual Footprint - 23-1/4" D x 48-1/2" W x 60" H

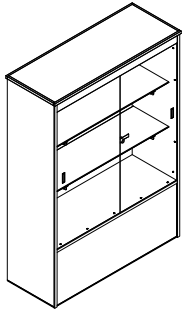

EV-DS-4260DC-LL

Display Case; LED Lighting

List Price - \$3,650

Actual Footprint - 16-1/2" D x 42-3/8" W x 59 3/4" H

LED lighting (-LL) may be added for \$355 list

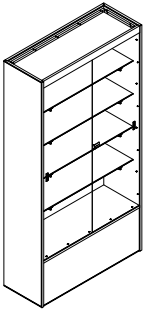

EV-DS-4282DC

Display Case

List Price - \$3,842

Actual Footprint - 16" D x 42" W x 82" H

LED lighting (-LL) may be added for \$355 list

Book Trucks
convenient transportation



LIAT

Everest

Book Trucks | Popular Items

The following products are **book trucks**. The catalog number, description, actual footprint, and list prices are all provided. Contact project management for any further information.

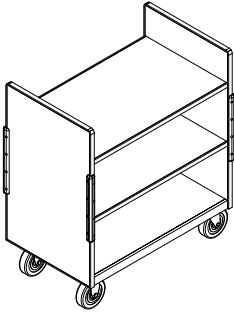

EV-BT-1830-35

List Price - \$1,070

Service Book Truck

Actual Footprint - 18" D x 30" W x 34 1/4" H

Rubber bumpers (-RB) may be added for an additional list price of \$342

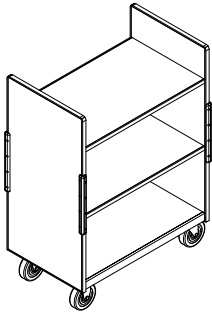

EV-BT-1830-42

List Price - \$1,147

Service Book Truck

Actual Footprint - 18" D x 30" W x 41" H

Rubber bumpers (-RB) may be added for an additional list price of \$342

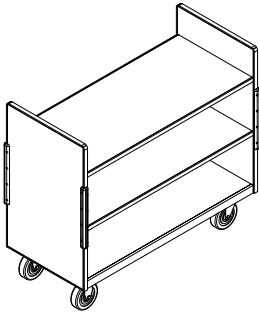

EV-BT-1840-35

List Price - \$1,129

Service Book Truck

Actual Footprint - 18" D x 40" W x 34 1/4" H

Rubber bumpers (-RB) may be added for an additional list price of \$342

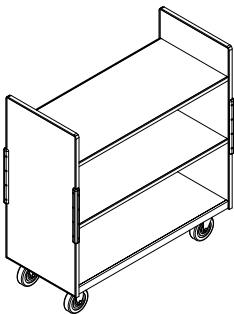

EV-BT-1840-42

List Price - \$1,184

Service Book Truck

Actual Footprint - 18" D x 40" W x 41" H

Rubber bumpers (-RB) may be added for an additional list price of \$342

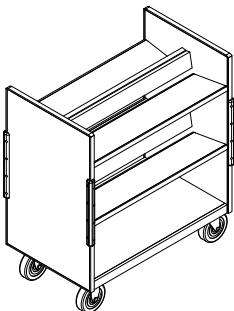

EV-BT-1830-35D

List Price - \$1,377

Display Book Truck

Actual Footprint - 18" D x 30" W x 34 1/4" H

Rubber bumpers (-RB) may be added for an additional list price of \$342

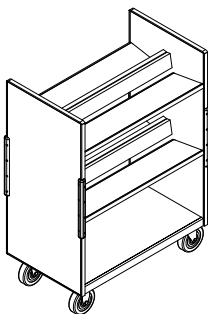

EV-BT-1830-42D

List Price - \$1,399

Display Book Truck

Actual Footprint - 18" D x 30" W x 41 1/4" H

Rubber bumpers (-RB) may be added for an additional list price of \$342

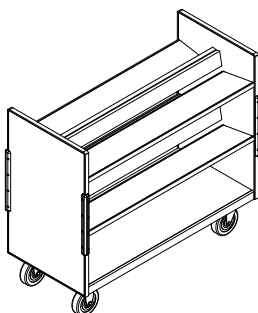

EV-BT-1840-35D

List Price - \$1,538

Display Book Truck

Actual Footprint - 18" D x 40" W x 34 1/4" H

Rubber bumpers (-RB) may be added for an additional list price of \$342

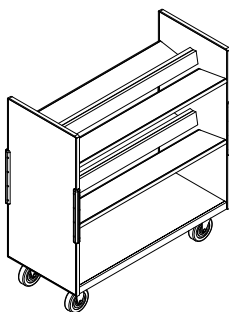

EV-BT-1840-42D

List Price - \$1,567

Display Book Truck

Actual Footprint - 18" D x 40" W x 41 1/4" H

Rubber bumpers (-RB) may be added for an additional list price of \$342

Terms and Conditions

Everest Terms and Conditions

The following terms & conditions apply to all LIAT, LLC products.

1. ACCEPTANCE, MODIFICATION, ASSIGNMENT: By placing this order for furniture, material or other products (sometimes collectively referred to as "Goods"), Customer agrees to these Terms and Conditions which shall prevail over inconsistent provisions in any other form or document of Customer. No change or modification shall be applicable unless set forth in writing and signed by Company. Neither this order nor any interest therein shall be assigned by Customer except with the prior written consent of Company.

2. PRICING: LIAT, LLC assumes no responsibility for the quantities or the interpretation of competitive product. Pricing is based on standard LIAT furniture including standard construction, materials, finishes and sizes. Unit prices shall prevail. Pricing subject to change without notice. Prices are those in effect at the time of order entry.

3. PAYMENT: Customer agrees to pay deposit or down payment as required by Company. Customer agrees to pay to Company the amount indicated on the Invoice, 1% 15 days, net 30 days from date of Invoice (U.S. Funds only), for Goods ordered. **INTEREST WILL BE CHARGED AFTER 30 DAYS FROM THE DATE OF INVOICE AT THE RATE OF ONE AND A HALF PERCENT (1.5%) PER MONTH.** International sales will require additional payment arrangements. No Goods shall be sold on consignment or conditional sales basis. Payment for the Goods delivered hereunder shall constitute acceptance thereof.

4. DELIVERY: The specific terms of delivery are as stated on the sales order acknowledgment. Goods which are delivered in advance of schedule are delivered at the risk of Customer. The Company is not liable for delays or failure to ship due to fire, strike, act of God, the public enemy or other causes beyond the control of the Company. With respect to LIAT, LLC, all shipments which are F.O.B. Factory or Delivered, LIAT, LLC reserves the right to select the appropriate carrier. Special requests including, but not limited to, inside delivery, installation, and call before delivery are not included in the price. Any charges arising from failure to meet shipment, rerouting while in transit, or carrier storage charges are the responsibility of the Customer.

*LIAT product is shipped knocked down. Assembly in the field is required.

5. CARE AND MAINTENANCE: To maintain your LIAT product for years of use, please follow these care and maintenance guidelines:

Wood Care and Maintenance: Use a damp, lint free cotton cloth for general dusting. Work with the grain of the wood.

Laminate Tops: Laminates may be cleaned using a damp cloth and mild soap.

Marmoleum Tops: Marmoleum can be maintained by dry or wet maintenance systems. For detailed product specifications or maintenance information, contact Forbo Industries Support Services at 1-800-842-7839 or visit their website www.forbo-industries.com.

Metal Finishes: Mix a solution of liquid soap and warm water. Saturate a clean cloth with this mixture. Wipe down metal then dry completely.

Acrylic Products: Use only products specifically recommended for cleaning acrylic, or a mild solution of dish detergent and warm water. Do **NOT** use any cleaner containing ammonia to clean your acrylic products. Do **NOT** use a dry cloth or your hand to clean the acrylic - this will rub the dirt and dust into the acrylic and can scratch the surface.

Fabric Care: The ability to be cleaned will vary based on the type of fabric. For best results, a professional service is recommended. Dirt and crumbs may be gently brushed or vacuumed off. Spill should be wiped up immediately with a cloth. If upholstery has been protected with Scotchgard or Zepel, the coating should be re-applied yearly. Vinyl textiles can be cleaned with warm soapy water and then wiped down with a warm damp cloth.

6. CLAIMS. All shipments are delivered to the carrier in good condition and Company's liability ceases after acceptance by carrier. If shipment arrives short or damaged, the Customer must file a claim immediately with the carrier. In the event of concealed damage, notify carrier and request an immediate inspection. Keep all cartons and packing material. Failure to file claim within 15 days after receipt of Goods constitutes acceptance and a waiver of any such claims

7. DISCLAIMER OF WARRANTIES: The express warranties below are the Company's sole warranties of its Goods, there are no understandings, agreements, representations, or warranties, express or implied (including any regarding the merchantability or fitness for a particular purpose), not specified herein, respecting the Goods. Except for those obligations of the Company identified in these Terms and Conditions, all risks related to the quality and performance of the Goods and responsibility for repair or service costs rests solely on the Customer. Company reserves the right to limit the applicable warranty to the Goods depending upon the division or catalogue through which said Goods were sold. Some states do not allow limitations on implied warranties, limitations on how long an implied warranty lasts, or the exclusion or limitation of incidental or consequential damages, so the above limitations may not apply to all Customers. This warranty gives the Customer specific legal rights, and each Customer may also have other rights which vary from state to state.

8. EXPRESS WARRANTIES: *The express warranties of the Company are as follows:*

LIAT, LLC

LIAT, LLC WARRANTS TO THE ORIGINAL PURCHASER THAT EACH CASEGOOD WILL BE FREE FROM DEFECTS IN WORKMANSHIP GIVEN NORMAL USE FOR A PERIOD OF TWENTY (20) YEARS OF SINGLE SHIFT SERVICE. LIAT WARRANTS THEIR SEATING PRODUCTS TO THE ORIGINAL PURCHASER THAT EACH PIECE OF FURNITURE WILL BE FREE FROM DEFECTS GIVEN NORMAL USE FOR FIVE (5) YEARS. LIAT, LLC WILL, AT ITS OPTION, REPAIR OR REPLACE ANY DEFECTIVE FURNITURE WITHIN THE TERMS OF THE WARRANTY. THIS WARRANTY DOES NOT APPLY TO DAMAGE RESULTING FROM ACCIDENT, ALTERATION, OR MISUSE. ALL LIAT ELECTRICAL COMPONENTS AND ACCESSORIES ARE WARRANTED TO THE EXTENT OF THE ORIGINAL MANUFACTURER.

Goods other than furniture are sold by Company to Customer without warranty.

9. ATTORNEYS' FEES: Customer shall be responsible for all expenses and costs in connection with the enforcement by Company of these Terms and Conditions and the costs of collection (including the fees of any collection agencies to whom the Customer's account may be referred), plus reasonable attorneys' fees (which attorneys' fees shall not be less than 25% of the amount due, unless a lower amount is specified by applicable law).

10. CANCELLATION: All cancellations must be made in writing. Administrative and/or labor charges may be incurred by the Customer depending upon the production stage of the order. Orders specifying special finish cannot be cancelled once finishing has begun. Cancellations cannot be accepted once final production has begun.

11. ORDER CHANGES: All changes to an order must be made in writing and are subject to Company's ability to conform. Administrative and/or labor charges may be incurred by the Customer depending upon the production stage of the order. Once final production has begun, no changes can be accepted.

12. REMEDIES: The remedies herein reserved shall be cumulative, and additional to any other or further remedies provided in law or equity. No waiver of a breach of any provision of these Terms and Conditions shall constitute waiver of any other breach or of such provision.

13. INSOLVENCY: Company may forthwith cancel this order in the event of the happening of any of the following or any other comparable event: insolvency of the Customer, the filing of a voluntary petition in bankruptcy, the filing of any involuntary petition to have Customer declared bankrupt provided it is not vacated within thirty (30) days from the date of filing, the appointment of a receiver or trustee for Customer provided such appointment is not vacated within thirty (30) days from the date of such appointment, or the execution by Customer of an assignment for the benefit of creditors.

14. LIMITATION OF LIABILITY: The Company shall not under any circumstances be liable to the Customer, owner of the Goods or any third party for special, indirect, incidental, or consequential damages, including, without limitation, loss of profits or revenues, loss or damage to other property or equipment, cost of capital or of purchased or replacement goods, or expense, delay or inconvenience caused by or arising from the purchase, sale, use, repair or inability to use the Goods or by any performance or non-performance under, or breach of, these Terms and Conditions. The Company's sole liability for any defective Goods shall be its repair or its replacement pursuant to the Express Warranties set forth above, or if amended, as applicable at the time of manufacture or repair of the Goods. Some states do not allow the exclusion or limitation of incidental or consequential damages, so the above limitations or exclusion may not apply to all Customers. Any action resulting from any breach on the part of Company as to the Goods or services delivered hereunder must be commenced within one year after the cause of action has occurred.

15. RETURNS AND ALLOWANCES: Reasonable touch-up and deluxing is the dealer's responsibility. The Company will not make allowances for trip or delivery charges, but will only make allowance for actual work performed to correct manufacturing defects. Allowances may be authorized only by a Company officer. It is the responsibility of the field sales representatives to inspect any defective merchandise and make suggestions and recommendations as to the proper disposition. Field personnel cannot obligate or bind the Company by definite agreement, without final authorization by a Company officer. Company will not accept automatic charge backs which do not have prior authorization. All defects must be called to the Company's attention upon arrival at the Customer's "Ship To" destination. To initiate any type of claim or request for parts, it is imperative to have the model number or fabric number, which may be located on the tag attached to the frame of the unit. Authorization for return to the Company for any reason must be issued by the Company via a Return Goods Authorization. Any authorized returns not due to damage or defect will be assessed a 30% restocking charge and all return freight charges must be prepaid. Company will not issue credit allowances for any repairs without Company's prior consent. Under no circumstances shall the Company accept COD (Cash on Delivery) returns, and any such shipment will be refused.

16. SECURITY AGREEMENT: The Company may require and Customer shall grant a security interest in Goods sold pursuant to any credit the Company may extend to the Customer.

17. GOVERNING LAW: All disputes between the parties, whether or not arising out of these Terms and Conditions, will be governed by the laws of the State of North Carolina. Customer agrees to submit to the jurisdiction of and agrees all lawsuits relating to any disputes between the Customer and the Company will be brought only in a state court located in Dubois County, North Carolina or the United States District Court for the Southern District of

North Carolina. THE CUSTOMER HEREBY WAIVES THE RIGHT TO A TRIAL BY JURY IN ANY ACTION, PROCEEDING, CLAIM, OR COUNTERCLAIM WHETHER IN CONTRACT OR TORT, AT LAW OR IN EQUITY, ARISING OUT OF OR RELATING IN ANY WAY TO THESE TERMS AND CONDITIONS AND ALL OTHER DISPUTES BETWEEN THE PARTIES.

18. MITIGATION: If the Company repossesses the Goods prior to payment by the Customer of all amounts due hereunder, the Company may sell the Goods, AS IS, WHERE IS, free and clear of all rights of the Customer at either public or private sale, and apply the net proceeds (after deducting expenses of repossession and sale) to the obligation of Customer hereunder. The Customer shall remain liable for any deficiency. THE COMPANY MAY DISPOSE OF THE GOODS IN ANY COMMERCIALY REASONABLE PLACE AND MANNER AND THE CUSTOMER WAIVES ANY NOTICE OF TIME, PLACE AND MANNER OF SALE.

19. INTEGRATION: This order for Goods, including these Terms and Conditions, along with any Credit Application, Invoice, Statement, Dealer Contract, Acknowledgment, Bill of Lading (and any exhibits, addenda or amendments thereto) of which this order may be a part, constitutes the sole and complete agreement between the Company and the Customer with respect to the purchase of the Goods.

20. DIMENSIONS/SPECIFICATIONS/FINISHES: All dimensions are approximate and may vary due to the upholstery technique of each craftsman. If exact dimensions are required, it is necessary for the Customer to state such specifications with the order. Detailed specification sheets are available for each series of Goods, and Customer should consult the Company's Customer Service Department for these specification sheets. Company reserves the right to make changes in dimensions, style, or specifications if Company believes these changes will improve the Goods' quality or appearance. Company reserves the right to substitute hardwoods due to availability at production. Due to the natural characteristics of wood, environmental effects, and material upgrades, the Company cannot guarantee exact finish matches on existing Goods previously ordered from Company. If an exact match to Customer's existing Goods are required, it must be specified so that the proper procedures can be followed to ensure an acceptable finish. Company will accept no liability for the finish if this procedure is not followed. Company reserves the right to make changes in a finish formula if Company believes the change will improve the quality or appearance of Company's Goods.

21. ACKNOWLEDGEMENT: All orders will be acknowledged promptly, showing how the order was entered, the approximate shipping time and other pertinent information. It is the Customer's obligation to examine this acknowledgment carefully and notify Company immediately of any discrepancies. Every reasonable effort is made to ship as acknowledged, however, the acknowledged ship date is approximate. Company will generally ship within five (5) working days of the acknowledged ship date. If a firm ship date is necessary, Customer must inform Company at time of order and Company will make all reasonable efforts to meet each Customer's request. Acknowledged shipping dates are contingent upon the force majeure conditions contained in these Terms and Conditions.

22. COMPANY'S PERFORMANCE OF ITS OBLIGATIONS: The production and delivery of the Goods to the extent delayed or hindered or prevented from the performance by reason of natural disasters, acts of God, strikes, lockouts, labor troubles, inability to procure materials, casualties, failure of power, restrictive governmental laws or regulations, riots, insurrection, acts of terrorism, war or other reason of a like nature not the fault of the Company shall excuse for the period of the delay the Company's performance and the period for the performance shall be extended for a period equivalent to the period of such delay.

GSA Terms and Conditions

Contractor: LIAT LLC, dba Jasper Library Furniture
Business Size: Small Business
Cage Code: 6BHB5
Contract Number: GS-28F-004AA
Contract Period: 10/10/12 thru 10/09/17

694 North Main Street
Troutman, NC 28166
Phone: 888.440.8205
Fax: 704.528.6519
Web Site: www.liatfurniture.com
E-mail: blish@liatfurniture.com
Contract Administration: Brian Lish

- 1a. Item Description: Furniture Systems and Workstation Clusters Special Item Numbers (SIN) Awarded: SIN 71-305 Library Furniture
2. Maximum Order: \$100,000.00 net
3. Minimum Order: \$100.00 net
4. Geographic Coverage: 48 Contiguous States, including the District of Columbia, Alaska, Hawaii, and Puerto Rico.
5. Point of Production: Same as company address
6. Discount: 58.5% off of list price (inclusive of IFF)
7. Quantity Discounts: None
8. Prompt Payment Terms: 1% discount for payments received in less than 20 days.
- 9a. Government Commercial Credit Card: Government commercial credit cards (Visa & MC) are not accepted.
- 9b. Discount for Government Credit Card: N/A
10. Foreign Items: None
- 11a. Time of Delivery: 6 to 8 weeks.
- 11b. Expedited Delivery: Negotiated on an order by order basis.
- 11c. Overnight and 2-Day Delivery: Contact contractor for availability and additional shipping charges.
- 11d. Urgent Requirements: Available upon request.
12. F.O.B Point: Destination

- 13a. Ordering Address: Same as Contractor
- 14. Payment Address: Same as company address.
- 15. Warranty Provisions: LIAT warrants their casegoods to the original purchaser that each piece of furniture will be free from defects in workmanship given normal use for a period of twenty years. LIAT will, at its option, repair or replace any defective merchandise within the terms of the warranty. LIAT warrants their seating products to the original purchaser that each piece of furniture will be free from defects in workmanship given normal use for five years. The casegoods and seating warranties do not apply to damage resulting from accident, alteration, or misuse. All LIAT electrical components and accessories are warranted to the extent of the original manufacturer.
- 16. Export Packing Charges: N/A
- 17. Terms and Conditions of Government Commercial Credit Card Acceptance: N/A
- 18. Terms and Conditions of rental, maintenance, and repair: N/A
- 19. Terms and Conditions of Installation: Negotiated on a case by case basis with the participating dealer.
- 20. Terms and Conditions of Repair Parts: N/A
- 21. List of Service and Distribution Points: N/A
- 22. Participating Dealer: Contact LIAT for a list of participants.
- 23. Preventative Maintenance: N/A
- 24a. Environmental Attributes: N/A
- 25. Data Universal Numbering System (DUNS) number: 038281451
- 26: Notification regarding registration in Central Registration (CCR) database: Registered



design the furniture. *innovate* the space. *engage* the users.

liatfurniture.com

694 North Main Street · Troutman, NC 28166
TF 888 440 8205 · F 704 528 6519