

January 3, 2011

Updated January 2, 2017

800-424-2432





WorkZone® General Information	
Basic Worksurfaces	2
WorkZone® with power	4
WorkZone® Shared Leg & Laptop Garage®	6
WorkZone® Worksurfaces	
Basic Workstation Typical	8
Basic	10
Mobile	26
Transitional	28
Accessories and Worksurface Connectors	40
WorkZone® Components	
General information	42
Universal Overhead Storage	44
Universal Tasklights	54
Balance® Overhead Storage	56
Balance® Task Lights	62
Privacy Screens	64
WorkZone® Accessories	
General information	66
Tool Rail	70
Paper Management	72
Center Drawer	76
WorkZone® with Power	
Electrical	82
Activ8® System	
	86
WorkZone® Shared Leg	
	88
WorkZone® Shared Leg with Laptop Garage®	
	92
Index	102

WorkZone® General Information

Basic Worksurfaces



Basic Worksurfaces (WBW)



Adjustable Keyboard Pad Worksurfaces (WAK)

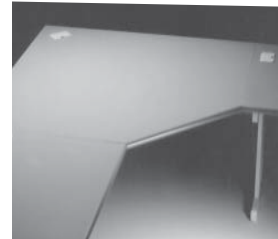

Transitional Worksurfaces (WCT)

Features

Solid core top	•	•	•
Plastic laminate surface	•	•	•
Flat vinyl T-edge	•	•	•
Postformed edge	•	•	•
74P edge	•	•	•
Elliptical postformed edge	•	•	•
Powder-coated legs	•	•	•
Seam-welded tubular steel frame	•	•	•
Chrome plated glides	•	•	•

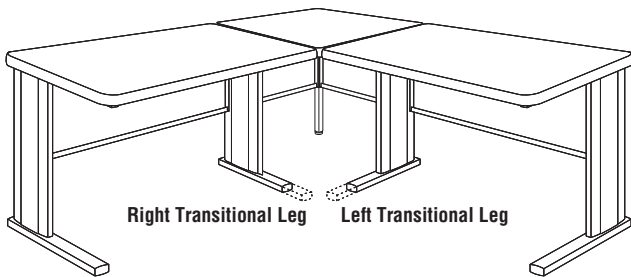

Transitional Leg

Transitional leg bases are 6 inches shorter than standard leg bases for greater leg room and chair clearance when two surfaces are joined. When seated at the worksurface, "right" or "left" refers to the individual worksurface, not the assembled workstation. Cannot be ordered for an individual, free-standing worksurface.

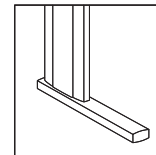

Streamline Leg

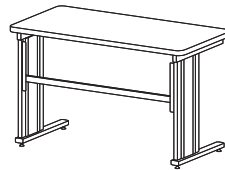

Beam Frame

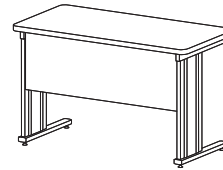

Modesty Panel Frame

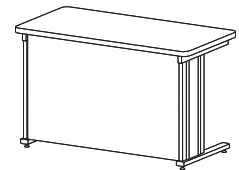

Full Modesty Panel Frame

SPECIFICATIONS

Worksurface Frames

Heavy-gauge seam-welded tubular steel. Horizontal tabletop support tube, 16-ga., 1"x 1" steel. Floor support member, 16-ga., 1-1/8" x 1-3/4" belly rectangular steel tube. Top and floor support tubes are welded with 2 steel tube vertical leg members. The rear vertical support is 16-ga., 1"x2" steel tube. The front vertical support is 16-ga., 1"x2-1/8" bullet oval steel tube. Leg inserts enclose the space between the (2) vertical leg members and provide concealed management of wire from floor to worksurface. Leg inserts are extruded Polypropylene with sprayed clear acrylic scuff-resistant coating. Adjustable chrome-plated glides. Powder-coat finish on legs. There are three frame style options. The receptacle clearance beam option (WB) is a 16-ga., 1/2" x 1-1/2" steel tube cross brace, welded to two 14-ga., L-brackets for support. The modesty panel (WM) is 19-ga. steel. It is located 1-1/2" from the rear of the

worksurface. The modesty panel is 15.31" on the 29" tables and 13.31" on 27" tables. The full height modesty panel (WF) is 19-ga. steel. It is located 1-1/2" from the rear of the worksurface. The full modesty panel spans the space between the underside of the worksurface and the floor. It is only available on 29" height desks.

Worksurface Top

1-1/4" thick top, .030" high-pressure laminate top surface with .028" phenolic backing sheet. Available with flat-vinyl T-edge, 74P edge or 180° postformed and elliptical postformed front edge with .030" high pressure laminate and .028 phenolic backing sheet. Side and rear edges of postformed tops are finished with either .024" Polypropylene or .030" high-pressure laminate.

Surface Splice Plates

Die-formed steel splice plates attach to underside of units with screws. Two splice plates are provided with all surfaces. Standard connector plate provided when surfaces are of common height. Worksurface

height change connector provided for connecting 29" to 27" high surfaces. Specify worksurface height change connector for connecting non-transitional worksurfaces of two different heights except when using T6 option..

Adjustable Keyboard Pad Worksurface

Die-formed L-brackets attach to table and keyboard pad with screws. Threaded hand knobs lock keyboard pad in position. Available with flat vinyl T-edge and 74P edge.

Weight Capacity

All WorkZone tables meet or exceed BIFMA 5.5 Standards. Please contact KI Customer Service for additional information.

Horizontal Wire Management Trough

Horizontal wire management trough (WW) connects below the worksurface top and is constructed of rigid Polypropylene with 1" deep by 1-1/2" high openings for cables.

Base Options

There are two options for the base, standard

chrome-plated adjustable glides (NC) or four swivel casters (WC). The caster option comes with two casters with locks and two non-locking and it raises worksurface height 2". Caster option not available on Workzone with Power, Shared leg, or Laptop Garage units. Overheads cannot be mounted on tables with caster option.

Guest Modesty Panel

The Guest Modesty Panel for P Shaped, Piano, and Square Shoe, peninsula worksurfaces is constructed of 19-ga. steel. It is located 4.5" from the guest side of the peninsula worksurface and is attached using 6, #10-1" screws. It is 9" high and comes in lengths to fit 60" through 84" peninsula tops. Not for use with peninsula end and side mount worksurfaces.

Fabric

Fabric will be applied as swatched by the fabric manufacturer. Fabric that is required to be applied differently than is swatched will need a Special Cost Request written specifying the direction the fabric is to be applied.



The posted standard lead time will apply to the Special Cost Request.

INFORMATION

Warranty

Refer to KI Terms & Conditions document or visit ki.com

WorkZone® General Information

WorkZone® with power

SPECIFICATIONS

PowerUp® Power/Data Module

The power/data module is inserted into a rectangular hole in the worksurface. The module has a flip-up cover and is 6-1/4" long x 3" wide x 2-1/2" high. It has one duplex receptacle (110 volts), dual data access and a power cord with a 3-prong plug. The cord is 108" long when used without 10-wire (NP) system and 22" long when used with 10-wire (T6) tables. Connections for phones, modems, printers and networks can be incorporated into the system, but must be ordered separately by the customer through a third party source. Communications wiring is completed in the field by the customer. Each unit ships with a data plate tree which provides holders for common jacks produced by AT&T, Panduit, and others. Contact KI Customer Service for more information. The single module is located at the rear right, rear left or center position of the worksurface widths 30" through 54". Two modules are available on 60", 66" and 72" wide rectangular surfaces and are located at the rear left and rear right position of the worksurface.

Data Door

The data door (WT) is constructed of rigid Polypropylene .06 wall thickness with a radius of 2-1/2". The door is 8" deep and 4-1/2" high. It attaches to the underside of the table top. The hanging bracket uses the same hole as the modesty panel and can also be used with WB option. Power and data cables are separated from each other by a 24-gauge steel divider that is 2" high by 2-3/4" deep. There is also space allowed for cord management. Available in black only.

Table-To-Table Wireway

The table-to-table wireway trough is a 16-gauge steel trough that attaches to the underside of the adjoining worksurface. The wireway is 3-3/4" deep by 4-1/4" wide. The wireway routes the 10-wire table-to-table connector and data wires between tables. The wire management trough also includes a splice plate that attaches the front of the adjoining tops together to prevent separation.

10-Wire 6-Circuit Pre-Wired Harness

Single sided, rigid 10-wire harness that holds two duplex receptacles (60", 66" and 72" wide tables provide access for up to four duplex receptacles). Harness contains

6 hot wire, 2 neutral wires and 2 ground wires and is commonly referred to as (6-2-2). The harness has mounting brackets to attach to the underside of the worksurface top with screws. The harness is 2-1/2" wide and the length of the harness varies with the size of the top. Power is obtained by use of the 10-wire Power Infeed Kit. Duplex receptacles located under the worksurface are specified separately.

10-Wire Table-To-Table Connector

10-wire table-to-table connector consists of flexible mesh conduit which provides power connections from adjoining tables. The jumper is 17-3/4" long and is routed through the table-to-table wireway.

10-Wire Power Infeed Kit

The 10-wire infeed kit provides power from fixed, floor, or wall sources to the 10-wire harness. It includes six feet of plastic covered flexible conduit, and 3/4" waterproof 90° connector. Also included are two steel covers which replace the existing plastic vertical wireway.

UL Listed

The WorkZone® with PowerUp® System is listed to applicable UL standards and requirements by Underwriters Laboratories, Inc.

Two of the standards used to evaluate WorkZone® are UL/286 Office Furnishings and UL/723 Standard for Test for Surface Burning Characteristics of Building Materials.

The standard used to evaluate PowerUp® is UL 1363 Relocatable Power Taps.

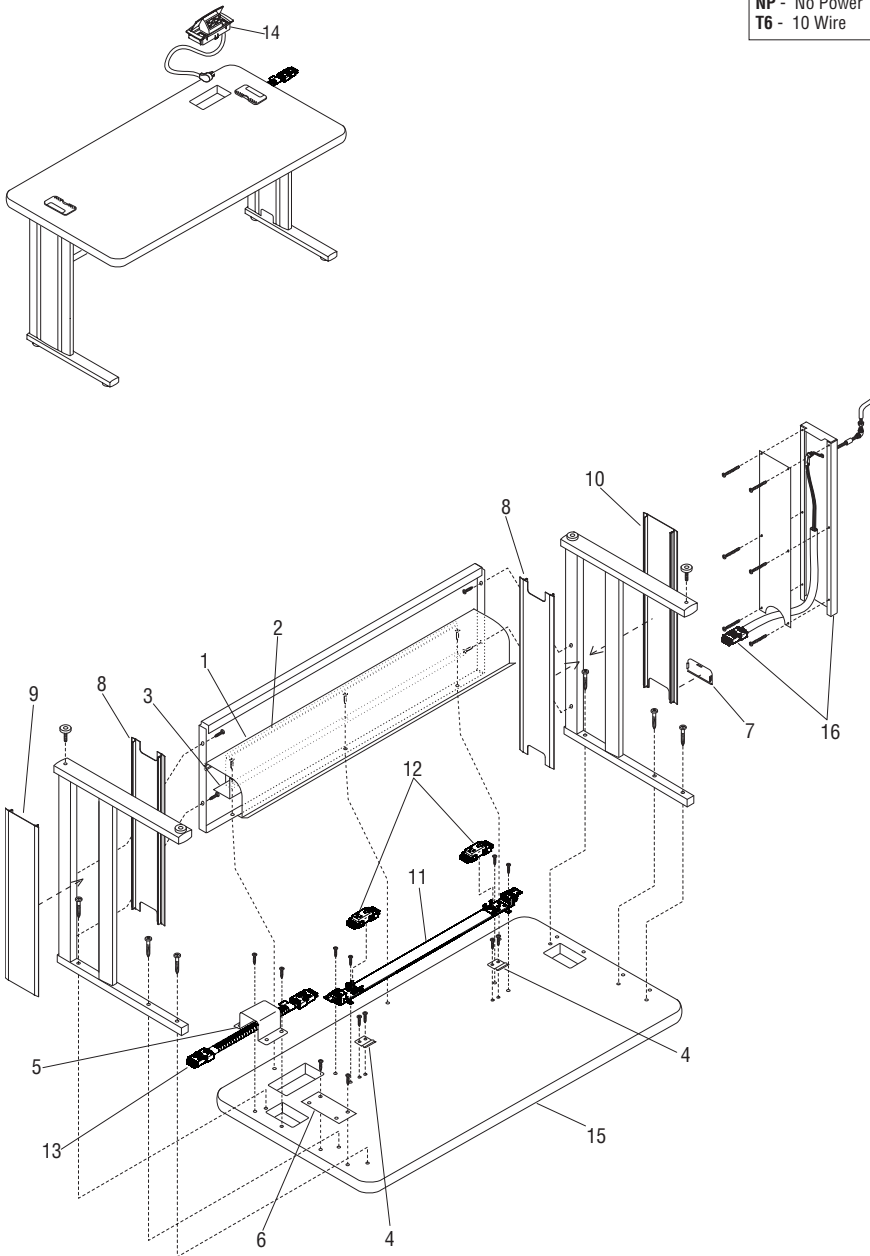

PowerUp Parts Listing

Legend

- NT** - No Trough
- WT** - With Trough
- NP** - No Power
- T6** - 10 Wire

Item No.	Item Description	NT	WT	NP	T6
1	Data Door 30"		•		
	Data Door 36"		•		
	Data Door 42"		•		
	Data Door 48"		•		
	Data Door 54"		•		
	Data Door 60"		•		
	Data Door 66"		•		
	Data Door 72"		•		
2	Door Mounting Bracket 30"		•		
	Door Mounting Bracket 36"		•		
	Door Mounting Bracket 42"		•		
	Door Mounting Bracket 48"		•		
	Door Mounting Bracket 54"		•		
	Door Mounting Bracket 60"		•		
	Door Mounting Bracket 66"		•		
	Door Mounting Bracket 72"		•		
3	Steel Power/Data Divider 30"		•		
	Steel Power/Data Divider 36"		•		
	Steel Power/Data Divider 42"		•		
	Steel Power/Data Divider 48"		•		
	Steel Power/Data Divider 54"		•		
	Steel Power/Data Divider 60"		•		
	Steel Power/Data Divider 66"		•		
	Steel Power/Data Divider 72"		•		
4	Clips for Door		•		
5	Table-To-Table Wireway		•		•
6	Splice Plate	•	•	•	•
7	Cap for Vertical Wireway		•		•
8	Vertical Wireway - Inner	•	•	•	•
9	Vertical Wireway - Outer, End-Of-Run	•			
10	Vertical Wireway - Outer		•		•
11	10-Wire Harness 30"				•
	10-Wire Harness 36"				•
	10-Wire Harness 42"				•
	10-Wire Harness 48"				•
	10-Wire Harness 54"				•
	10-Wire Harness 60"				•
	10-Wire Harness 66"				•
	10-Wire Harness 72"				•
12	Duplex Receptacles (optional - must be ordered separately)				
13	10-Wire Table-To-Table Connector (optional - must be ordered separately)				
14	Power Data Module				
15	WorkZone Top only with cut-outs				
16	Steel Infeed 27" Cover Plate Assembly				
	Steel Infeed 29" Cover Plate Assembly				
	Steel Infeed 42" Cover Plate Assembly				
	(optional - must be ordered separately)				

WorkZone® General Information

WorkZone® Shared Leg & Laptop Garage®



Starter Unit



Adder Unit



Finisher Unit

Starter Unit - Each shared leg workplace requires a starter unit to be placed at one end of the table string. The starter unit is comprised of a worksurface, modesty panel, standard leg and transitional leg. Only one starter unit is required in a single table string.

Adder Unit - When three or more tables make up a table string, an adder unit is used to make up the middle portion of the table string. The adder unit is comprised of a worksurface, modesty panel and transitional leg.

Finisher Unit - The final table specified in a table string is the finisher unit. This unit is comprised of a worksurface, modesty panel and a standard leg.

All three units are joined together by the transitional legs, which are centered between the two worksurfaces and attach accordingly. When specifying the shared leg option, it is possible to specify tables with the Laptop Garage® in the same table string as other tables without Laptop Garages.

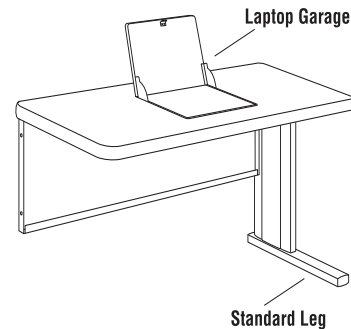
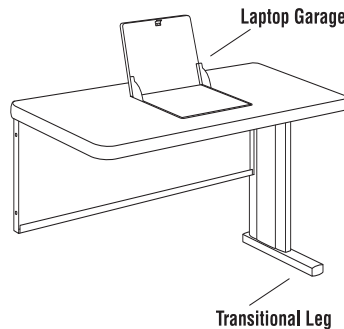
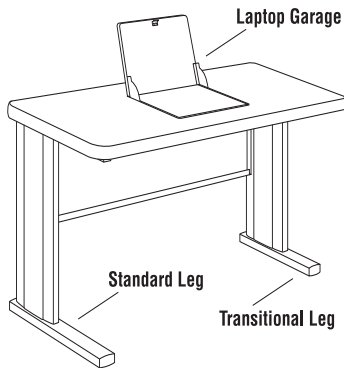

SPECIFICATIONS

LAPTOP GARAGE

Garage Construction

The two-piece Laptop Garage enclosure and shelf shall be fabricated from 16-gauge steel and have a black powder-coated finish. The door shall be constructed from 5/8" thick MDF board and be covered with .040" thick high-pressure laminate on both sides. The edges shall be painted black. The door when opened by pressing a steel latch and catch assembly shall automatically rise by the force stored in two gas cylinders. These cylinders shall also provide the variable length linkage used to raise the pivot rod which shall activate dual scissors mechanisms hidden beneath a shelf. Each scissors mechanism shall be made from two 14-gauge x 5/8" wide straps, which are punched to accept plastic wear bushings. Upon reaching the maximum open position the cover shall automatically be fixed in that position by an 11-gauge steel gravity-activated lock

bracket. The unit shall allow access to the underside of the shelf if necessary due to the spillage of liquid or for cleaning or retrieval of a lost item in this position only. This shall be accomplished by lifting the shelf.

Garage Operation

The Laptop Garage unit shall be accessed by a simple push of a steel latch located on the front panel of the unit. Two gas cylinders shall raise the cover approximately 20 degrees. Manually lifting the cover to 14 degrees past vertical will automatically engage the gravity lock bar. This motion shall be assisted by (2) compression springs. Closing the unit shall be accomplished by pressing the gravity lever away from the user to release the cover, then pulling it down to the closed position. A rotary motion damper shall dampen the cover's movement. Final latching shall happen when the cover becomes flush with the primary worksurface.

Optional Lock Mechanism

Locking units shall be equipped with an

110/120v keyless operated solenoid. The solenoid shall allow the locking sequence to begin with the unit's cover in any position. Locks shall be programmable to lock and unlock all units within a room at the same time or individually. Keyless remotes ordered separately.



INFORMATION

Warranty

Refer to KI Terms & Conditions document
or visit ki.com

WorkZone® Worksurfaces

Basic Workstation Typical

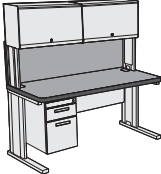
MODEL NUMBER												Approx. Packaged Weight
Basic Model	WWay	Paint Color	Insert Color	Laminate Color	Edge Color	Fabric Color	Worksurface Grommet	Pack	Key Option	Grommet Color		
	WKBS30481	<input type="checkbox"/>	<input type="checkbox"/>	<input type="checkbox"/>	<input type="checkbox"/>	<input type="checkbox"/>		<input type="checkbox"/>	<input type="checkbox"/>		<input type="checkbox"/>	170.0#
	WKBS30601	<input type="checkbox"/>	<input type="checkbox"/>	<input type="checkbox"/>	<input type="checkbox"/>	<input type="checkbox"/>		<input type="checkbox"/>	<input type="checkbox"/>		<input type="checkbox"/>	185.0#
	WKBS30721	<input type="checkbox"/>	<input type="checkbox"/>	<input type="checkbox"/>	<input type="checkbox"/>	<input type="checkbox"/>		<input type="checkbox"/>	<input type="checkbox"/>		<input type="checkbox"/>	200.0#
WKBS Basic Desk <ul style="list-style-type: none"> • 29" high Basic Worksurface • 24" 700 Series Hanging Pedestal, box/file • Available in only Flat Vinyl T-Edge • Packing option pertains to pedestal only 												
	WKBS30482	<input type="checkbox"/>	<input type="checkbox"/>	<input type="checkbox"/>	<input type="checkbox"/>	<input type="checkbox"/>	<input type="checkbox"/>	<input type="checkbox"/>	<input type="checkbox"/>	<input type="checkbox"/>	<input type="checkbox"/>	290.0#
	WKBS30602	<input type="checkbox"/>	<input type="checkbox"/>	<input type="checkbox"/>	<input type="checkbox"/>	<input type="checkbox"/>	<input type="checkbox"/>	<input type="checkbox"/>	<input type="checkbox"/>	<input type="checkbox"/>	<input type="checkbox"/>	340.0#
	WKBS30722	<input type="checkbox"/>	<input type="checkbox"/>	<input type="checkbox"/>	<input type="checkbox"/>	<input type="checkbox"/>	<input type="checkbox"/>	<input type="checkbox"/>	<input type="checkbox"/>	<input type="checkbox"/>	<input type="checkbox"/>	365.0#
WKBS Basic Desk with Overhead <ul style="list-style-type: none"> • 29" high Basic Worksurface • 24" 700 Series Hanging Pedestal, box/file • Painted steel overhead cabinet • Task light • Privacy screen (two screens included in 60" and 72" wide surfaces) • Available in only Flat Vinyl T-Edge • 48" and 60" stations include one 36" light • 72" station includes 2-24" lights • Packing option pertains to pedestal only 												
A	B	C	D	E	F	G	H	I	J	K		

HOW TO ORDER

Indicate the following information on order form:

1. Quantity of each item.
2. Model number, including options. See "How To Build a Model Number".
3. Any special service required.

Note: • The indicates that a choice is required.
 • The absence of the indicates that no choice is required.
 • Alpha-numeric characters in place of indicate that no other alternatives are available.

HOW TO BUILD A MODEL NUMBER

- A** Select basic model.
- B** Select horizontal wireway.
 Add upcharge to unit price for WW option.
NW - No horizontal wireway
WW - Wireway
- C** Select paint color.
 Refer to color addendum at ki.com or KI Fabrics & Finishes binder.
 Paint color includes pedestal.
- D** Select insert color.
 Refer to color addendum at ki.com or KI Fabrics & Finishes binder.
 Insert color also includes horizontal wireway (WW) if selected.
- E** Select laminate surface.
 Refer to color addendum at ki.com or KI Fabrics & Finishes binder.
- F** Select edge color.
- Refer to color addendum at ki.com or KI Fabrics & Finishes binder.
 Edge color offerings are based on edge style selections.
- G** Select fabric for privacy screen.
 Refer to color addendum at ki.com or in KI Fabrics & Finishes binder.
- H** Select grommet option.
 Grommets are required for overhead cabinet.
OGN - No worksurface grommet
OGY - Yes worksurface grommet
 Grommets can be used for wire pass-through.
- I** Select pack option.
BP - Blanket pack
CP - Commercial pack
- J** Select key option.
KA - Key alike
KS - Key standard
NLC - No lock core

The key option is for the overhead. The pedestal is keyed as standard.

- K** Select grommet color.
 Refer to color addendum at ki.com or KI Fabrics & Finishes binder.



Delivered Pricing	Delivered Pricing Fabric Grade 1 & C.O.M.	Delivered Pricing Fabric Grade 2	Delivered Pricing Fabric Grade 3 & Pallas Vertical Fabric Grade PV	Delivered Pricing Pallas Vertical Fabric Grade PV1	Delivered Pricing Pallas Vertical Fabric Grade PV2	Wireway add to list price
\$ 1344						\$ 49
1395						64
1440						68
N/A	\$ 2923	\$ 2938	\$ 2946	\$ 2972	\$ 2997	\$ 49
N/A	3788	3812	3824	3861	3898	64
N/A	3935	3956	3972	4009	4048	68

FINISH INFORMATION

Additional Laminate Offering

Additional laminates beyond KI standard offering, are available with two weeks extended leadtime. To specify additional laminates, use these designators followed by the supplier's color/pattern code:

- Formica - LF/supplier's color pattern code
- Nevamar - LN/supplier's color pattern code
- Wilsonart - LW/supplier's color pattern code

KI's standard finish is the supplier's recommended finish for that color/pattern.

Note: Nonstandard laminates from these suppliers (example: textured laminates), require an upcharge and additional leadtime. Contact KI.

SPECIAL SERVICES

Special Carton Marking

With specially marked information N/C

Shipping

Shipped k.d. freight prepaid f.o.b. Manitowoc, Wisconsin 54220 factory. Freight class #70.

Specifications and prices are subject to change without prior notice.

WorkZone® Worksurfaces

Basic

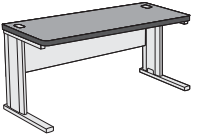
	D x W	MODEL NUMBER												
		Basic Model	Edge Style	Hgt.	WWay	Frame Style	Trans. Legs	Worksurface Grommet	Paint Color	Insert Color	Base	Lam. Color	Edge Color	Grommet Color
 <p>WBW Basic Worksurface</p> <ul style="list-style-type: none"> Adjustable glides or casters 66" and 72" wide overhead are not available on WorkZone® frames with beams 	24 x 30"	WBW2430	<input type="checkbox"/> <input type="checkbox"/> <input type="checkbox"/>	<input type="checkbox"/>	<input type="checkbox"/> <input type="checkbox"/>	<input type="checkbox"/> <input type="checkbox"/>	<input type="checkbox"/> <input type="checkbox"/>	<input type="checkbox"/> <input type="checkbox"/>	<input type="checkbox"/> <input type="checkbox"/>	<input type="checkbox"/> <input type="checkbox"/>	<input type="checkbox"/> <input type="checkbox"/>	<input type="checkbox"/> <input type="checkbox"/>	<input type="checkbox"/> <input type="checkbox"/>	<input type="checkbox"/> <input type="checkbox"/>
	24 x 36"	WBW2436	<input type="checkbox"/> <input type="checkbox"/> <input type="checkbox"/>	<input type="checkbox"/>	<input type="checkbox"/> <input type="checkbox"/>	<input type="checkbox"/> <input type="checkbox"/>	<input type="checkbox"/> <input type="checkbox"/>	<input type="checkbox"/> <input type="checkbox"/>	<input type="checkbox"/> <input type="checkbox"/>	<input type="checkbox"/> <input type="checkbox"/>	<input type="checkbox"/> <input type="checkbox"/>	<input type="checkbox"/> <input type="checkbox"/>	<input type="checkbox"/> <input type="checkbox"/>	<input type="checkbox"/> <input type="checkbox"/>
	24 x 42"	WBW2442	<input type="checkbox"/> <input type="checkbox"/> <input type="checkbox"/>	<input type="checkbox"/>	<input type="checkbox"/> <input type="checkbox"/>	<input type="checkbox"/> <input type="checkbox"/>	<input type="checkbox"/> <input type="checkbox"/>	<input type="checkbox"/> <input type="checkbox"/>	<input type="checkbox"/> <input type="checkbox"/>	<input type="checkbox"/> <input type="checkbox"/>	<input type="checkbox"/> <input type="checkbox"/>	<input type="checkbox"/> <input type="checkbox"/>	<input type="checkbox"/> <input type="checkbox"/>	<input type="checkbox"/> <input type="checkbox"/>
	24 x 48"	WBW2448	<input type="checkbox"/> <input type="checkbox"/> <input type="checkbox"/>	<input type="checkbox"/>	<input type="checkbox"/> <input type="checkbox"/>	<input type="checkbox"/> <input type="checkbox"/>	<input type="checkbox"/> <input type="checkbox"/>	<input type="checkbox"/> <input type="checkbox"/>	<input type="checkbox"/> <input type="checkbox"/>	<input type="checkbox"/> <input type="checkbox"/>	<input type="checkbox"/> <input type="checkbox"/>	<input type="checkbox"/> <input type="checkbox"/>	<input type="checkbox"/> <input type="checkbox"/>	<input type="checkbox"/> <input type="checkbox"/>
	24 x 54"	WBW2454	<input type="checkbox"/> <input type="checkbox"/> <input type="checkbox"/>	<input type="checkbox"/>	<input type="checkbox"/> <input type="checkbox"/>	<input type="checkbox"/> <input type="checkbox"/>	<input type="checkbox"/> <input type="checkbox"/>	<input type="checkbox"/> <input type="checkbox"/>	<input type="checkbox"/> <input type="checkbox"/>	<input type="checkbox"/> <input type="checkbox"/>	<input type="checkbox"/> <input type="checkbox"/>	<input type="checkbox"/> <input type="checkbox"/>	<input type="checkbox"/> <input type="checkbox"/>	<input type="checkbox"/> <input type="checkbox"/>
	24 x 60"	WBW2460	<input type="checkbox"/> <input type="checkbox"/> <input type="checkbox"/>	<input type="checkbox"/>	<input type="checkbox"/> <input type="checkbox"/>	<input type="checkbox"/> <input type="checkbox"/>	<input type="checkbox"/> <input type="checkbox"/>	<input type="checkbox"/> <input type="checkbox"/>	<input type="checkbox"/> <input type="checkbox"/>	<input type="checkbox"/> <input type="checkbox"/>	<input type="checkbox"/> <input type="checkbox"/>	<input type="checkbox"/> <input type="checkbox"/>	<input type="checkbox"/> <input type="checkbox"/>	<input type="checkbox"/> <input type="checkbox"/>
	24 x 66"	WBW2466	<input type="checkbox"/> <input type="checkbox"/> <input type="checkbox"/>	<input type="checkbox"/>	<input type="checkbox"/> <input type="checkbox"/>	<input type="checkbox"/> <input type="checkbox"/>	<input type="checkbox"/> <input type="checkbox"/>	<input type="checkbox"/> <input type="checkbox"/>	<input type="checkbox"/> <input type="checkbox"/>	<input type="checkbox"/> <input type="checkbox"/>	<input type="checkbox"/> <input type="checkbox"/>	<input type="checkbox"/> <input type="checkbox"/>	<input type="checkbox"/> <input type="checkbox"/>	<input type="checkbox"/> <input type="checkbox"/>
	24 x 72"	WBW2472	<input type="checkbox"/> <input type="checkbox"/> <input type="checkbox"/>	<input type="checkbox"/>	<input type="checkbox"/> <input type="checkbox"/>	<input type="checkbox"/> <input type="checkbox"/>	<input type="checkbox"/> <input type="checkbox"/>	<input type="checkbox"/> <input type="checkbox"/>	<input type="checkbox"/> <input type="checkbox"/>	<input type="checkbox"/> <input type="checkbox"/>	<input type="checkbox"/> <input type="checkbox"/>	<input type="checkbox"/> <input type="checkbox"/>	<input type="checkbox"/> <input type="checkbox"/>	<input type="checkbox"/> <input type="checkbox"/>
	30 x 30"	WBW3030	<input type="checkbox"/> <input type="checkbox"/> <input type="checkbox"/>	<input type="checkbox"/>	<input type="checkbox"/> <input type="checkbox"/>	<input type="checkbox"/> <input type="checkbox"/>	<input type="checkbox"/> <input type="checkbox"/>	<input type="checkbox"/> <input type="checkbox"/>	<input type="checkbox"/> <input type="checkbox"/>	<input type="checkbox"/> <input type="checkbox"/>	<input type="checkbox"/> <input type="checkbox"/>	<input type="checkbox"/> <input type="checkbox"/>	<input type="checkbox"/> <input type="checkbox"/>	<input type="checkbox"/> <input type="checkbox"/>
	30 x 36"	WBW3036	<input type="checkbox"/> <input type="checkbox"/> <input type="checkbox"/>	<input type="checkbox"/>	<input type="checkbox"/> <input type="checkbox"/>	<input type="checkbox"/> <input type="checkbox"/>	<input type="checkbox"/> <input type="checkbox"/>	<input type="checkbox"/> <input type="checkbox"/>	<input type="checkbox"/> <input type="checkbox"/>	<input type="checkbox"/> <input type="checkbox"/>	<input type="checkbox"/> <input type="checkbox"/>	<input type="checkbox"/> <input type="checkbox"/>	<input type="checkbox"/> <input type="checkbox"/>	<input type="checkbox"/> <input type="checkbox"/>
	30 x 42"	WBW3042	<input type="checkbox"/> <input type="checkbox"/> <input type="checkbox"/>	<input type="checkbox"/>	<input type="checkbox"/> <input type="checkbox"/>	<input type="checkbox"/> <input type="checkbox"/>	<input type="checkbox"/> <input type="checkbox"/>	<input type="checkbox"/> <input type="checkbox"/>	<input type="checkbox"/> <input type="checkbox"/>	<input type="checkbox"/> <input type="checkbox"/>	<input type="checkbox"/> <input type="checkbox"/>	<input type="checkbox"/> <input type="checkbox"/>	<input type="checkbox"/> <input type="checkbox"/>	<input type="checkbox"/> <input type="checkbox"/>
	30 x 48"	WBW3048	<input type="checkbox"/> <input type="checkbox"/> <input type="checkbox"/>	<input type="checkbox"/>	<input type="checkbox"/> <input type="checkbox"/>	<input type="checkbox"/> <input type="checkbox"/>	<input type="checkbox"/> <input type="checkbox"/>	<input type="checkbox"/> <input type="checkbox"/>	<input type="checkbox"/> <input type="checkbox"/>	<input type="checkbox"/> <input type="checkbox"/>	<input type="checkbox"/> <input type="checkbox"/>	<input type="checkbox"/> <input type="checkbox"/>	<input type="checkbox"/> <input type="checkbox"/>	<input type="checkbox"/> <input type="checkbox"/>
	30 x 54"	WBW3054	<input type="checkbox"/> <input type="checkbox"/> <input type="checkbox"/>	<input type="checkbox"/>	<input type="checkbox"/> <input type="checkbox"/>	<input type="checkbox"/> <input type="checkbox"/>	<input type="checkbox"/> <input type="checkbox"/>	<input type="checkbox"/> <input type="checkbox"/>	<input type="checkbox"/> <input type="checkbox"/>	<input type="checkbox"/> <input type="checkbox"/>	<input type="checkbox"/> <input type="checkbox"/>	<input type="checkbox"/> <input type="checkbox"/>	<input type="checkbox"/> <input type="checkbox"/>	<input type="checkbox"/> <input type="checkbox"/>
	30 x 60"	WBW3060	<input type="checkbox"/> <input type="checkbox"/> <input type="checkbox"/>	<input type="checkbox"/>	<input type="checkbox"/> <input type="checkbox"/>	<input type="checkbox"/> <input type="checkbox"/>	<input type="checkbox"/> <input type="checkbox"/>	<input type="checkbox"/> <input type="checkbox"/>	<input type="checkbox"/> <input type="checkbox"/>	<input type="checkbox"/> <input type="checkbox"/>	<input type="checkbox"/> <input type="checkbox"/>	<input type="checkbox"/> <input type="checkbox"/>	<input type="checkbox"/> <input type="checkbox"/>	<input type="checkbox"/> <input type="checkbox"/>
	30 x 66"	WBW3066	<input type="checkbox"/> <input type="checkbox"/> <input type="checkbox"/>	<input type="checkbox"/>	<input type="checkbox"/> <input type="checkbox"/>	<input type="checkbox"/> <input type="checkbox"/>	<input type="checkbox"/> <input type="checkbox"/>	<input type="checkbox"/> <input type="checkbox"/>	<input type="checkbox"/> <input type="checkbox"/>	<input type="checkbox"/> <input type="checkbox"/>	<input type="checkbox"/> <input type="checkbox"/>	<input type="checkbox"/> <input type="checkbox"/>	<input type="checkbox"/> <input type="checkbox"/>	<input type="checkbox"/> <input type="checkbox"/>
	30 x 72"	WBW3072	<input type="checkbox"/> <input type="checkbox"/> <input type="checkbox"/>	<input type="checkbox"/>	<input type="checkbox"/> <input type="checkbox"/>	<input type="checkbox"/> <input type="checkbox"/>	<input type="checkbox"/> <input type="checkbox"/>	<input type="checkbox"/> <input type="checkbox"/>	<input type="checkbox"/> <input type="checkbox"/>	<input type="checkbox"/> <input type="checkbox"/>	<input type="checkbox"/> <input type="checkbox"/>	<input type="checkbox"/> <input type="checkbox"/>	<input type="checkbox"/> <input type="checkbox"/>	<input type="checkbox"/> <input type="checkbox"/>

A

B

C

D

E

F

G

H

I

J

K

L

M

HOW TO ORDER

Indicate the following information on order form:

- Quantity of each item.
- Model number, including options. See "How To Build a Model Number".
- Any special service required.

Note: • The indicates that a choice is required.

- The absence of the indicates that no choice is required.
- Alpha-numeric characters in place of indicate that no other alternatives are available.

HOW TO BUILD A MODEL NUMBER

A Select basic model.

B Select edge style.

BN - Flat vinyl T-edge

74P - 74P edge

EP - Elliptical postformed edge

PF - Postformed edge

C Select height.

7 - 27" high

9 - 29" High

D Select horizontal wireway.

Add upcharge to unit price for WW option.

NW - No horizontal wireway

WW - Wireway

E Select frame style.

Add upcharge to unit price for WF option.

WB - w/ Beam

WM - w/ Modesty panel

WF - w/ Full modesty panel

w/ Full modesty panel (available on 29"

high only)

F Select location and type of leg.

TS - Standard legs

TL - Transition leg (left)

TR - Transition leg (right)

TB - Transition leg (both)

Note: If ordering Basic Worksurface as a freestanding unit, or if only one side connects to a transitional worksurface, the "TB" option for both transitional legs is not available.

G Select grommet option.

Grommets are required for overhead cabinet.

OGN - No worksurface grommet

OGY - Yes worksurface grommet

Grommets can be used for wire pass-through.

H Select paint color.

Refer to color addendum at ki.com or KI Fabrics & Finishes binder.

I Select insert color.

Refer to color addendum at ki.com or KI Fabrics & Finishes binder. Insert color also includes horizontal wireway (WW) if selected.

J Select base option.

NC - With glides (standard)

WC - With casters; add \$50

K Select laminate surface.

Refer to color addendum at ki.com or KI Fabrics & Finishes binder.



L Select edge color.

Refer to color addendum at ki.com or KI Fabrics & Finishes binder. Edge color offerings are based on edge style selections.

M Select grommet color.

Refer to color addendum at ki.com or KI Fabrics & Finishes binder.

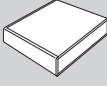

Approx. Packaged Weight	   				Wireway add to list price	Full Modesty Panel add to list price
	Flat Vinyl T-Edge (BN)	74P Edge (74P)	Elliptical Postformed Edge (EP)	Postformed Edge (PF)		
69.0#	\$ 633	\$ 664	\$ 698	\$ 731	\$ 36	\$ 47
76.0#	657	691	723	757	38	57
83.0#	685	719	754	790	44	67
89.0#	706	745	778	818	49	77
96.0#	729	768	804	846	57	83
102.0#	756	796	833	877	64	94
110.0#	781	819	858	900	64	122
116.0#	803	845	883	927	68	131
76.0#	644	674	708	746	36	47
83.0#	672	723	742	777	38	57
92.0#	698	731	763	802	44	67
100.0#	719	754	790	830	49	77
106.0#	745	781	819	860	57	83
113.0#	770	809	846	888	64	94
120.0#	796	833	871	918	64	122
126.0#	816	858	898	946	68	131

FINISH INFORMATION

Additional Laminate Offering

Additional laminates beyond KI standard offering, are available with two weeks extended leadtime. To specify additional laminates, use these designators followed by the supplier's color/pattern code:

Formica - LF/supplier's color pattern code
 Nevamar - LN/supplier's color pattern code
 Wilsonart - LW/supplier's color pattern code

KI's standard finish is the supplier's recommended finish for that color/pattern.

Note: Nonstandard laminates from these suppliers (example: textured laminates), require an upcharge and additional leadtime. Contact KI.

SPECIAL SERVICES

Special Carton Marking

With specially marked information N/C

Shipping

Shipped k.d. freight prepaid f.o.b. Manitowoc, Wisconsin 54220 factory. Freight class #70.

Specifications and prices are subject to change without prior notice.

WorkZone® Worksurfaces

Basic

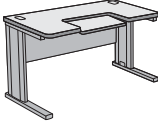
		MODEL NUMBER													
		Basic Model	Edge Style	Key-pad Loc.	Hgt.	WWay	Frame Style	Trans. Legs	Work-Surface Grom.	Paint Color	Insert Color	Base	Lam. Color	Edge Color	Grom. Color
D x W															
 <p>WAK</p> <p>Adjustable Keyboard Pad Worksurface</p> <ul style="list-style-type: none"> Adjustable keyboard pad right, centered (shown) or left 10" x 24"; 3" height adjustments: 1" forward extension adjustment: 15° maximum downward tilt Adjustable glides or casters When adding a pedestal, pad must be RH or LH and worksurface must be at least 60" long Keyboard is located 5-3/4" from edge of worksurface on left and right locations 66" and 72" wide overhead not available on WorkZone frames with beams 	24 x 36"	WAK2436	<input type="checkbox"/> <input type="checkbox"/> <input type="checkbox"/>	C	<input type="checkbox"/>	<input type="checkbox"/> <input type="checkbox"/>	<input type="checkbox"/> <input type="checkbox"/>	<input type="checkbox"/> <input type="checkbox"/>	<input type="checkbox"/> <input type="checkbox"/> <input type="checkbox"/>	<input type="checkbox"/> <input type="checkbox"/>	<input type="checkbox"/> <input type="checkbox"/> <input type="checkbox"/>	<input type="checkbox"/> <input type="checkbox"/>	<input type="checkbox"/> <input type="checkbox"/> <input type="checkbox"/>	<input type="checkbox"/> <input type="checkbox"/> <input type="checkbox"/>	<input type="checkbox"/> <input type="checkbox"/> <input type="checkbox"/>
	24 x 42"	WAK2442	<input type="checkbox"/> <input type="checkbox"/> <input type="checkbox"/>	C	<input type="checkbox"/>	<input type="checkbox"/> <input type="checkbox"/>	<input type="checkbox"/> <input type="checkbox"/>	<input type="checkbox"/> <input type="checkbox"/>	<input type="checkbox"/> <input type="checkbox"/> <input type="checkbox"/>	<input type="checkbox"/> <input type="checkbox"/>	<input type="checkbox"/> <input type="checkbox"/> <input type="checkbox"/>	<input type="checkbox"/> <input type="checkbox"/>	<input type="checkbox"/> <input type="checkbox"/> <input type="checkbox"/>	<input type="checkbox"/> <input type="checkbox"/> <input type="checkbox"/>	<input type="checkbox"/> <input type="checkbox"/> <input type="checkbox"/>
	24 x 48"	WAK2448	<input type="checkbox"/> <input type="checkbox"/> <input type="checkbox"/>		<input type="checkbox"/>	<input type="checkbox"/> <input type="checkbox"/>	<input type="checkbox"/> <input type="checkbox"/>	<input type="checkbox"/> <input type="checkbox"/>	<input type="checkbox"/> <input type="checkbox"/> <input type="checkbox"/>	<input type="checkbox"/> <input type="checkbox"/>	<input type="checkbox"/> <input type="checkbox"/> <input type="checkbox"/>	<input type="checkbox"/> <input type="checkbox"/>	<input type="checkbox"/> <input type="checkbox"/> <input type="checkbox"/>	<input type="checkbox"/> <input type="checkbox"/> <input type="checkbox"/>	<input type="checkbox"/> <input type="checkbox"/> <input type="checkbox"/>
	24 x 54"	WAK2454	<input type="checkbox"/> <input type="checkbox"/> <input type="checkbox"/>		<input type="checkbox"/>	<input type="checkbox"/> <input type="checkbox"/>	<input type="checkbox"/> <input type="checkbox"/>	<input type="checkbox"/> <input type="checkbox"/>	<input type="checkbox"/> <input type="checkbox"/> <input type="checkbox"/>	<input type="checkbox"/> <input type="checkbox"/>	<input type="checkbox"/> <input type="checkbox"/> <input type="checkbox"/>	<input type="checkbox"/> <input type="checkbox"/>	<input type="checkbox"/> <input type="checkbox"/> <input type="checkbox"/>	<input type="checkbox"/> <input type="checkbox"/> <input type="checkbox"/>	<input type="checkbox"/> <input type="checkbox"/> <input type="checkbox"/>
	24 x 60"	WAK2460	<input type="checkbox"/> <input type="checkbox"/> <input type="checkbox"/>		<input type="checkbox"/>	<input type="checkbox"/> <input type="checkbox"/>	<input type="checkbox"/> <input type="checkbox"/>	<input type="checkbox"/> <input type="checkbox"/>	<input type="checkbox"/> <input type="checkbox"/> <input type="checkbox"/>	<input type="checkbox"/> <input type="checkbox"/>	<input type="checkbox"/> <input type="checkbox"/> <input type="checkbox"/>	<input type="checkbox"/> <input type="checkbox"/>	<input type="checkbox"/> <input type="checkbox"/> <input type="checkbox"/>	<input type="checkbox"/> <input type="checkbox"/> <input type="checkbox"/>	<input type="checkbox"/> <input type="checkbox"/> <input type="checkbox"/>
	24 x 66"	WAK2466	<input type="checkbox"/> <input type="checkbox"/> <input type="checkbox"/>		<input type="checkbox"/>	<input type="checkbox"/> <input type="checkbox"/>	<input type="checkbox"/> <input type="checkbox"/>	<input type="checkbox"/> <input type="checkbox"/>	<input type="checkbox"/> <input type="checkbox"/> <input type="checkbox"/>	<input type="checkbox"/> <input type="checkbox"/>	<input type="checkbox"/> <input type="checkbox"/> <input type="checkbox"/>	<input type="checkbox"/> <input type="checkbox"/>	<input type="checkbox"/> <input type="checkbox"/> <input type="checkbox"/>	<input type="checkbox"/> <input type="checkbox"/> <input type="checkbox"/>	<input type="checkbox"/> <input type="checkbox"/> <input type="checkbox"/>
	24 x 72"	WAK2472	<input type="checkbox"/> <input type="checkbox"/> <input type="checkbox"/>		<input type="checkbox"/>	<input type="checkbox"/> <input type="checkbox"/>	<input type="checkbox"/> <input type="checkbox"/>	<input type="checkbox"/> <input type="checkbox"/>	<input type="checkbox"/> <input type="checkbox"/> <input type="checkbox"/>	<input type="checkbox"/> <input type="checkbox"/>	<input type="checkbox"/> <input type="checkbox"/> <input type="checkbox"/>	<input type="checkbox"/> <input type="checkbox"/>	<input type="checkbox"/> <input type="checkbox"/> <input type="checkbox"/>	<input type="checkbox"/> <input type="checkbox"/> <input type="checkbox"/>	<input type="checkbox"/> <input type="checkbox"/> <input type="checkbox"/>
	30 x 36"	WAK3036	<input type="checkbox"/> <input type="checkbox"/> <input type="checkbox"/>	C	<input type="checkbox"/>	<input type="checkbox"/> <input type="checkbox"/>	<input type="checkbox"/> <input type="checkbox"/>	<input type="checkbox"/> <input type="checkbox"/>	<input type="checkbox"/> <input type="checkbox"/> <input type="checkbox"/>	<input type="checkbox"/> <input type="checkbox"/>	<input type="checkbox"/> <input type="checkbox"/> <input type="checkbox"/>	<input type="checkbox"/> <input type="checkbox"/>	<input type="checkbox"/> <input type="checkbox"/> <input type="checkbox"/>	<input type="checkbox"/> <input type="checkbox"/> <input type="checkbox"/>	<input type="checkbox"/> <input type="checkbox"/> <input type="checkbox"/>
	30 x 42"	WAK3042	<input type="checkbox"/> <input type="checkbox"/> <input type="checkbox"/>	C	<input type="checkbox"/>	<input type="checkbox"/> <input type="checkbox"/>	<input type="checkbox"/> <input type="checkbox"/>	<input type="checkbox"/> <input type="checkbox"/>	<input type="checkbox"/> <input type="checkbox"/> <input type="checkbox"/>	<input type="checkbox"/> <input type="checkbox"/>	<input type="checkbox"/> <input type="checkbox"/> <input type="checkbox"/>	<input type="checkbox"/> <input type="checkbox"/>	<input type="checkbox"/> <input type="checkbox"/> <input type="checkbox"/>	<input type="checkbox"/> <input type="checkbox"/> <input type="checkbox"/>	<input type="checkbox"/> <input type="checkbox"/> <input type="checkbox"/>
	30 x 48"	WAK3048	<input type="checkbox"/> <input type="checkbox"/> <input type="checkbox"/>		<input type="checkbox"/>	<input type="checkbox"/> <input type="checkbox"/>	<input type="checkbox"/> <input type="checkbox"/>	<input type="checkbox"/> <input type="checkbox"/>	<input type="checkbox"/> <input type="checkbox"/> <input type="checkbox"/>	<input type="checkbox"/> <input type="checkbox"/>	<input type="checkbox"/> <input type="checkbox"/> <input type="checkbox"/>	<input type="checkbox"/> <input type="checkbox"/>	<input type="checkbox"/> <input type="checkbox"/> <input type="checkbox"/>	<input type="checkbox"/> <input type="checkbox"/> <input type="checkbox"/>	<input type="checkbox"/> <input type="checkbox"/> <input type="checkbox"/>
	30 x 54"	WAK3054	<input type="checkbox"/> <input type="checkbox"/> <input type="checkbox"/>		<input type="checkbox"/>	<input type="checkbox"/> <input type="checkbox"/>	<input type="checkbox"/> <input type="checkbox"/>	<input type="checkbox"/> <input type="checkbox"/>	<input type="checkbox"/> <input type="checkbox"/> <input type="checkbox"/>	<input type="checkbox"/> <input type="checkbox"/>	<input type="checkbox"/> <input type="checkbox"/> <input type="checkbox"/>	<input type="checkbox"/> <input type="checkbox"/>	<input type="checkbox"/> <input type="checkbox"/> <input type="checkbox"/>	<input type="checkbox"/> <input type="checkbox"/> <input type="checkbox"/>	<input type="checkbox"/> <input type="checkbox"/> <input type="checkbox"/>
	30 x 60"	WAK3060	<input type="checkbox"/> <input type="checkbox"/> <input type="checkbox"/>		<input type="checkbox"/>	<input type="checkbox"/> <input type="checkbox"/>	<input type="checkbox"/> <input type="checkbox"/>	<input type="checkbox"/> <input type="checkbox"/>	<input type="checkbox"/> <input type="checkbox"/> <input type="checkbox"/>	<input type="checkbox"/> <input type="checkbox"/>	<input type="checkbox"/> <input type="checkbox"/> <input type="checkbox"/>	<input type="checkbox"/> <input type="checkbox"/>	<input type="checkbox"/> <input type="checkbox"/> <input type="checkbox"/>	<input type="checkbox"/> <input type="checkbox"/> <input type="checkbox"/>	<input type="checkbox"/> <input type="checkbox"/> <input type="checkbox"/>
	30 x 66"	WAK3066	<input type="checkbox"/> <input type="checkbox"/> <input type="checkbox"/>		<input type="checkbox"/>	<input type="checkbox"/> <input type="checkbox"/>	<input type="checkbox"/> <input type="checkbox"/>	<input type="checkbox"/> <input type="checkbox"/>	<input type="checkbox"/> <input type="checkbox"/> <input type="checkbox"/>	<input type="checkbox"/> <input type="checkbox"/>	<input type="checkbox"/> <input type="checkbox"/> <input type="checkbox"/>	<input type="checkbox"/> <input type="checkbox"/>	<input type="checkbox"/> <input type="checkbox"/> <input type="checkbox"/>	<input type="checkbox"/> <input type="checkbox"/> <input type="checkbox"/>	<input type="checkbox"/> <input type="checkbox"/> <input type="checkbox"/>
	30 x 72"	WAK3072	<input type="checkbox"/> <input type="checkbox"/> <input type="checkbox"/>		<input type="checkbox"/>	<input type="checkbox"/> <input type="checkbox"/>	<input type="checkbox"/> <input type="checkbox"/>	<input type="checkbox"/> <input type="checkbox"/>	<input type="checkbox"/> <input type="checkbox"/> <input type="checkbox"/>	<input type="checkbox"/> <input type="checkbox"/>	<input type="checkbox"/> <input type="checkbox"/> <input type="checkbox"/>	<input type="checkbox"/> <input type="checkbox"/>	<input type="checkbox"/> <input type="checkbox"/> <input type="checkbox"/>	<input type="checkbox"/> <input type="checkbox"/> <input type="checkbox"/>	<input type="checkbox"/> <input type="checkbox"/> <input type="checkbox"/>

A B C D E F G H I J K L M N

HOW TO ORDER

Indicate the following information on order form:

- Quantity of each item.
- Model number, including options. See "How To Build a Model Number".
- Any special service required.

Note: • The indicates that a choice is required.

- The absence of the indicates that no choice is required.
- Alpha-numeric characters in place of indicate that no other alternatives are available.

HOW TO BUILD A MODEL NUMBER

- A** Select basic model.

- B** Select edge style.
BN - Flat vinyl T-edge
74P - 74P edge
- C** Select location of keypad.
C - Center
R - Right
L - Left
Note: On 36" and 42" wide worksurfaces, "C" is the only option available.
- D** Select height.
7 - 27" high
9 - 29" High
- E** Select horizontal wireway.
Add upcharge to unit price for WW option.
NW - No horizontal wireway
WW - Wireway
- F** Select frame style.

Add upcharge to unit price for WF option.

- WB** - w/ Beam
 - WM** - w/ Modesty panel
 - WF** - w/ Full modesty panel
- w/ Full modesty panel (available on 29" high only)

- G** Select location and type of leg.
TS - Standard legs
TL - Transition leg (left)
TR - Transition leg (right)
TB - Transition leg (both)

Note: If ordering Basic Worksurface as a freestanding unit, or if only one side connects to a transitional worksurface, the "TB" option for both transitional legs is not available.

- H** Select grommet option.
Grommets are required for overhead cabinet.
OGN - No worksurface grommet
OGY - Yes worksurface grommet
Grommets can be used for wire pass-through.

- I** Select paint color.
Refer to color addendum at ki.com or KI Fabrics & Finishes binder.

- J** Select insert color.
Refer to color addendum at ki.com or KI Fabrics & Finishes binder.
Insert color also includes horizontal wireway (WW) if selected.

- K** Select base option.
NC - With glides (standard)
WC - With casters; add \$50

- L** Select laminate surface.
Refer to color addendum at ki.com or KI Fabrics & Finishes binder.

- M** Select edge color.
Refer to color addendum at ki.com or KI Fabrics & Finishes binder.
Edge color offerings are based on edge style selections.

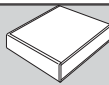
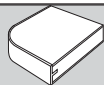

Approx. Packaged Weight	Flat Vinyl T-Edge (BN)	74P Edge (74P)	Wireway add to list price	Full Modesty Panel add to list price
77.0#	\$ 773	\$ 814	\$ 38	\$ 57
84.0#	798	836	44	67
90.0#	823	862	49	77
96.0#	845	886	57	83
103.0#	870	915	64	94
114.0#	890	934	64	122
126.0#	915	958	68	131
84.0#	803	845	38	57
93.0#	832	873	44	67
101.0#	859	900	49	77
110.0#	881	931	57	83
114.0#	900	949	64	94
122.0#	925	973	64	122
130.0#	951	996	68	131

NSelect grommet color.
Refer to color addendum at ki.com or
KI Fabrics & Finishes binder.

FINISH INFORMATION

Additional Laminate Offering

Additional laminates beyond KI standard offering, are available with two weeks extended leadtime. To specify additional laminates, use these designators followed by the supplier's color/pattern code:

- Formica - LF/supplier's color pattern code
- Nevamar - LN/supplier's color pattern code
- Wilsonart - LW/supplier's color pattern code

KI's standard finish is the supplier's recommended finish for that color/pattern.

Note: Nonstandard laminates from these suppliers (example: textured laminates), require an upcharge and additional leadtime. Contact KI.

SPECIAL SERVICES

Special Carton Marking

With specially marked information N/C

Shipping

Shipped **k.d. freight prepaid f.o.b. Manitowoc, Wisconsin 54220** factory. Freight class #70.

Specifications and prices are subject to change without prior notice.

WorkZone® Worksurfaces

Basic

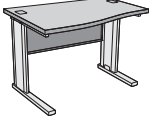
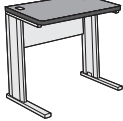
		MODEL NUMBER													
D x W x D		Basic Model	Edge Style	Height	WWay	Frame Style	Trans. Legs	Wrksrf. Grom.	Paint Color	Insert Color	Base	Lam. Color	Edge Color	Grom. Color	
 <p>WRC Curvilinear Worksurface</p> <ul style="list-style-type: none"> • Joins 24" deep worksurface to 30" deep worksurface • Available in 27" and 29" height only • Adjustable glides or casters 	24 x 42 x 30"	WRC244230	<input type="checkbox"/>	<input type="checkbox"/>	<input type="checkbox"/>	<input type="checkbox"/>	<input type="checkbox"/>	<input type="checkbox"/>	<input type="checkbox"/>	<input type="checkbox"/>	<input type="checkbox"/>	<input type="checkbox"/>	<input type="checkbox"/>	<input type="checkbox"/>	
	24 x 48 x 30"	WRC244830	<input type="checkbox"/>	<input type="checkbox"/>	<input type="checkbox"/>	<input type="checkbox"/>	<input type="checkbox"/>	<input type="checkbox"/>	<input type="checkbox"/>	<input type="checkbox"/>	<input type="checkbox"/>	<input type="checkbox"/>	<input type="checkbox"/>	<input type="checkbox"/>	
	24 x 54 x 30"	WRC245430	<input type="checkbox"/>	<input type="checkbox"/>	<input type="checkbox"/>	<input type="checkbox"/>	<input type="checkbox"/>	<input type="checkbox"/>	<input type="checkbox"/>	<input type="checkbox"/>	<input type="checkbox"/>	<input type="checkbox"/>	<input type="checkbox"/>	<input type="checkbox"/>	
	24 x 60 x 30"	WRC246030	<input type="checkbox"/>	<input type="checkbox"/>	<input type="checkbox"/>	<input type="checkbox"/>	<input type="checkbox"/>	<input type="checkbox"/>	<input type="checkbox"/>	<input type="checkbox"/>	<input type="checkbox"/>	<input type="checkbox"/>	<input type="checkbox"/>	<input type="checkbox"/>	
	24 x 66 x 30"	WRC246630	<input type="checkbox"/>	<input type="checkbox"/>	<input type="checkbox"/>	<input type="checkbox"/>	<input type="checkbox"/>	<input type="checkbox"/>	<input type="checkbox"/>	<input type="checkbox"/>	<input type="checkbox"/>	<input type="checkbox"/>	<input type="checkbox"/>	<input type="checkbox"/>	
	24 x 72 x 30"	WRC247230	<input type="checkbox"/>	<input type="checkbox"/>	<input type="checkbox"/>	<input type="checkbox"/>	<input type="checkbox"/>	<input type="checkbox"/>	<input type="checkbox"/>	<input type="checkbox"/>	<input type="checkbox"/>	<input type="checkbox"/>	<input type="checkbox"/>	<input type="checkbox"/>	
	30 x 42 x 24"	WRC304224	<input type="checkbox"/>	<input type="checkbox"/>	<input type="checkbox"/>	<input type="checkbox"/>	<input type="checkbox"/>	<input type="checkbox"/>	<input type="checkbox"/>	<input type="checkbox"/>	<input type="checkbox"/>	<input type="checkbox"/>	<input type="checkbox"/>	<input type="checkbox"/>	
	30 x 48 x 24"	WRC304824	<input type="checkbox"/>	<input type="checkbox"/>	<input type="checkbox"/>	<input type="checkbox"/>	<input type="checkbox"/>	<input type="checkbox"/>	<input type="checkbox"/>	<input type="checkbox"/>	<input type="checkbox"/>	<input type="checkbox"/>	<input type="checkbox"/>	<input type="checkbox"/>	
	30 x 54 x 24"	WRC305424	<input type="checkbox"/>	<input type="checkbox"/>	<input type="checkbox"/>	<input type="checkbox"/>	<input type="checkbox"/>	<input type="checkbox"/>	<input type="checkbox"/>	<input type="checkbox"/>	<input type="checkbox"/>	<input type="checkbox"/>	<input type="checkbox"/>	<input type="checkbox"/>	
	30 x 60 x 24"	WRC306024	<input type="checkbox"/>	<input type="checkbox"/>	<input type="checkbox"/>	<input type="checkbox"/>	<input type="checkbox"/>	<input type="checkbox"/>	<input type="checkbox"/>	<input type="checkbox"/>	<input type="checkbox"/>	<input type="checkbox"/>	<input type="checkbox"/>	<input type="checkbox"/>	
	30 x 66 x 24"	WRC306624	<input type="checkbox"/>	<input type="checkbox"/>	<input type="checkbox"/>	<input type="checkbox"/>	<input type="checkbox"/>	<input type="checkbox"/>	<input type="checkbox"/>	<input type="checkbox"/>	<input type="checkbox"/>	<input type="checkbox"/>	<input type="checkbox"/>	<input type="checkbox"/>	
30 x 72 x 24"	WRC307224	<input type="checkbox"/>	<input type="checkbox"/>	<input type="checkbox"/>	<input type="checkbox"/>	<input type="checkbox"/>	<input type="checkbox"/>	<input type="checkbox"/>	<input type="checkbox"/>	<input type="checkbox"/>	<input type="checkbox"/>	<input type="checkbox"/>	<input type="checkbox"/>		
 <p>WCS Stand-up Worksurface</p> <ul style="list-style-type: none"> • Available in 42" height only • Adjustable glides • Overheads cannot be mounted on any stand up worksurface 	30 x 36"	WSU3036	<input type="checkbox"/>	2	<input type="checkbox"/>	<input type="checkbox"/>	TS	<input type="checkbox"/>	<input type="checkbox"/>	<input type="checkbox"/>	NC	<input type="checkbox"/>	<input type="checkbox"/>	<input type="checkbox"/>	

A B C D E F G H I J K L M

HOW TO ORDER

Indicate the following information on order form:

- Quantity of each item.
- Model number, including options. See "How To Build a Model Number".
- Any special service required.

Note: • The indicates that a choice is required.

- The absence of the indicates that no choice is required.
- Alpha-numeric characters in place of indicate that no other alternatives are available.

HOW TO BUILD A MODEL NUMBER

- A** Select basic model.
- B** Select edge style.
 - BN** - Flat vinyl T-edge
 - 74P** - 74P edge
 - EP** - Elliptical postformed edge
 - PF** - Postformed edge
- C** Select height.
 - 7** - 27" high
 - 9** - 29" High
 - 2** - 42" high

42" height only available on Stand-up worksurface.
- D** Select horizontal wireway.
 - Add upcharge to unit price for WW option.
 - NW** - No horizontal wireway
 - WW** - Wireway
- E** Select frame style.
 - Add upcharge to unit price for WF option.
 - WB** - w/ Beam

- WM** - w/ Modesty panel
 - WF** - w/ Full modesty panel
- w/ Full modesty panel (available on 29" high only)

- F** Select location and type of leg.
 - TS** - Standard legs
 - TL** - Transition leg (left)
 - TR** - Transition leg (right)
 - TB** - Transition leg (both)

Note: If ordering Basic Worksurface as a freestanding unit, or if only one side connects to a transitional worksurface, the "TB" option for both transitional legs is not available.

- G** Select grommet option.
 - Grommets are required for overhead cabinet.
 - OGN** - No worksurface grommet
 - OGY** - Yes worksurface grommet

Grommets can be used for wire pass-through.

- H** Select paint color.

Refer to color addendum at ki.com or KI Fabrics & Finishes binder.

- I** Select insert color.
 - Refer to color addendum at ki.com or KI Fabrics & Finishes binder.
 - Insert color also includes horizontal wireway (WW) if selected.

- J** Select base option.
 - NC** - With glides (standard)
 - WC** - With casters; add \$50

- K** Select laminate surface.
 - Refer to color addendum at ki.com or KI Fabrics & Finishes binder.

- L** Select edge color.
 - Refer to color addendum at ki.com or KI Fabrics & Finishes binder.
 - Edge color offerings are based on edge style selections.

- M** Select grommet color.
 - Refer to color addendum at ki.com or KI Fabrics & Finishes binder.

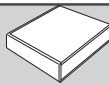
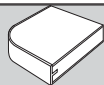

Approx. Packaged Weight	Flat Vinyl T-Edge (BN)	74P Edge (74P)	Elliptical Postformed Edge (EP)	Postformed Edge (PF)	Wireway add to list price	Full Modesty Panel add to list price
84.0#	\$ 672	\$ 723	N/A	N/A	\$ 44	\$ 67
91.0#	698	729	N/A	N/A	49	77
98.0#	753	789	N/A	N/A	57	83
103.0#	756	797	N/A	N/A	64	94
110.0#	785	824	N/A	N/A	64	122
117.0#	810	850	N/A	N/A	68	131
84.0#	672	723	N/A	N/A	44	67
91.0#	698	729	N/A	N/A	49	77
98.0#	753	789	N/A	N/A	57	83
103.0#	756	797	N/A	N/A	64	94
110.0#	785	824	N/A	N/A	64	122
117.0#	810	850	N/A	N/A	68	131
94.0#	\$ 711	\$ 749	\$ 783	\$ 823	\$ 38	N/A

KI Fabrics & Finishes binder.

FINISH INFORMATION

Additional Laminate Offering

Additional laminates beyond KI standard offering, are available with two weeks extended leadtime. To specify additional laminates, use these designators followed by the supplier's color/pattern code:

- Formica - LF/supplier's color pattern code
- Nevamar - LN/supplier's color pattern code
- Wilsonart - LW/supplier's color pattern code

KI's standard finish is the supplier's recommended finish for that color/pattern.

Note: Nonstandard laminates from these suppliers (example: textured laminates), require an upcharge and additional leadtime. Contact KI.

SPECIAL SERVICES

Special Carton Marking

With specially marked information N/C

Shipping

Shipped k.d. freight prepaid f.o.b. Manitowoc, Wisconsin 54220 factory. Freight class #70.

Specifications and prices are subject to change without prior notice.

WorkZone® Worksurfaces

Basic

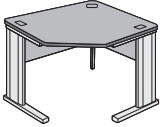
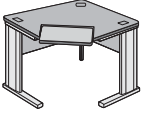
		MODEL NUMBER												
D x W-LEFT x W-RIGHT x D		Basic Model	Edge Style	Hgt.	WWay	Frame Style	Trans. Legs	Wrksrf. Grom.	Paint Color	Insert Color	Lam. Color	Edge Color	Grom. Color	
 <p>WCS Stand Alone Corner Worksurface</p> <ul style="list-style-type: none"> Adjustable glides Corner support leg is 7/8" sq. tubular steel Front edge dimension is 17" on 24x36" and 30x42"; 25-1/2" on 24x42" and 30x48"; 34" on 24x48" Not available with both (TB) transitional legs 	24 x 36 x 36 x 24"	WCS2436	□□□	□	□□	□□	□□	□□	□□	□□	□□	□□	□□	
	24 x 42 x 42 x 24"	WCS2442	□□□	□	□□	□□	□□	□□	□□	□□	□□	□□	□□	
	24 x 48 x 48 x 24"	WCS2448	□□□	□	□□	□□	□□	□□	□□	□□	□□	□□	□□	
	30 x 42 x 42 x 30"	WCS3042	□□□	□	□□	□□	□□	□□	□□	□□	□□	□□	□□	
	30 x 48 x 48 x 30"	WCS3048	□□□	□	□□	□□	□□	□□	□□	□□	□□	□□	□□	
 <p>WAK Stand Alone Corner Worksurface with Keyboard</p> <ul style="list-style-type: none"> Adjustable glides Keyboard pad: 10" x 24"; 3" height adjustments: 1" forward extension adjustment: 15° maximum downward tilt Corner support leg is 7/8" square tubular steel Not available with both (TB) transitional legs 	24 x 42 x 42 x 24"	WCSK2442	□□□	□	□□	□□	□□	□□	□□	□□	□□	□□	□□	
	24 x 48 x 48 x 24"	WCSK2448	□□□	□	□□	□□	□□	□□	□□	□□	□□	□□	□□	
	30 x 48 x 48 x 30"	WCSK3048	□□□	□	□□	□□	□□	□□	□□	□□	□□	□□	□□	
			A	B	C	D	E	F	G	H	I	J	K	L

HOW TO ORDER

Indicate the following information on order form:

- Quantity of each item.
- Model number, including options. See "How To Build a Model Number".
- Any special service required.

Note:

- The □ indicates that a choice is required.
- The absence of the □ indicates that no choice is required.
- Alpha-numeric characters in place of □ indicate that no other alternatives are available.

HOW TO BUILD A MODEL NUMBER

- A** Select basic model.
- B** Select edge style.
 - BN** - Flat vinyl T-edge
 - 74P** - 74P edge
 - EP** - Elliptical postformed edge
 - PF** - Postformed edge
- C** Select height.
 - 7** - 27" high
 - 9** - 29" High
- D** Select horizontal wireway. Add upcharge to unit price for WW option.
 - NW** - No horizontal wireway
 - WW** - Wireway
- E** Select frame style. Add upcharge to unit price for WF option.
 - WB** - w/ Beam
 - WM** - w/ Modesty panel
 - WF** - w/ Full modesty panel
 w/ Full modesty panel (available on 29"

high only)

- F** Select location and type of leg.
 - TS** - Standard legs
 - TL** - Transition leg (left)
 - TR** - Transition leg (right)
- G** Select grommet option. Grommets are required for overhead cabinet.
 - OGN** - No worksurface grommet
 - ÖGY** - Yes worksurface grommet
 Grommets can be used for wire pass-through.
- H** Select paint color. Refer to color addendum at ki.com or KI Fabrics & Finishes binder.
- I** Select insert color. Refer to color addendum at ki.com or KI Fabrics & Finishes binder. Insert color also includes horizontal wireway (WW) if selected.

- J** Select laminate surface. Refer to color addendum at ki.com or KI Fabrics & Finishes binder.
- K** Select edge color. Refer to color addendum at ki.com or KI Fabrics & Finishes binder. Edge color offerings are based on edge style selections.
- L** Select grommet color. Refer to color addendum at ki.com or KI Fabrics & Finishes binder.

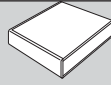

Approx. Packaged Weight	Flat Vinyl T-Edge (BN)	74P Edge (74P)	Elliptical Postformed Edge (EP)	Postformed Edge (PF)	Wireway add to list price	Full Modesty Panel add to list price
76.0#	\$ 949	\$ 991	\$ 1040	\$ 1093	\$ 74	\$ 114
96.0#	1006	1054	1104	1160	87	133
106.0#	1062	1115	1167	1228	100	153
108.0#	1122	1177	1232	1294	87	133
118.0#	1179	1236	1297	1360	104	153

99.0#	\$ 1103	\$ 1159	N/A	N/A	\$ 87	\$ 133
106.0#	1135	1191	N/A	N/A	100	153
118.0#	1314	1383	N/A	N/A	104	153

FINISH INFORMATION

Additional Laminate Offering

Additional laminates beyond KI standard offering, are available with two weeks extended leadtime. To specify additional laminates, use these designators followed by the supplier's color/pattern code:

Formica - LF/supplier's color pattern code
 Nevamar - LN/supplier's color pattern code
 Wilsonart - LW/supplier's color pattern code

KI's standard finish is the supplier's recommended finish for that color/pattern.

Note: Nonstandard laminates from these suppliers (example: textured laminates), require an upcharge and additional leadtime. Contact KI.

SPECIAL SERVICES

Special Carton Marking

With specially marked information N/C

Shipping

Shipped k.d. freight prepaid f.o.b. Manitowoc, Wisconsin 54220 factory. Freight class #70.

Specifications and prices are subject to change without prior notice.

WorkZone® Worksurfaces

Basic

D x W-LEFT x W-RIGHT x D	MODEL NUMBER											
	Basic Model	Edge Style	Ht	WWay	Frame Style	Trans. Legs	Grom	Paint Clr	Insrt Clr	Lam Clr	Edge Clr	Grm Clr
24 x 36 x 36 x 24"	WCC243624	<input type="checkbox"/>	<input type="checkbox"/>	<input type="checkbox"/>	<input type="checkbox"/>	<input type="checkbox"/>	<input type="checkbox"/>	<input type="checkbox"/>	<input type="checkbox"/>	<input type="checkbox"/>	<input type="checkbox"/>	<input type="checkbox"/>
24 x 42 x 42 x 24"	WCC244224	<input type="checkbox"/>	<input type="checkbox"/>	<input type="checkbox"/>	<input type="checkbox"/>	<input type="checkbox"/>	<input type="checkbox"/>	<input type="checkbox"/>	<input type="checkbox"/>	<input type="checkbox"/>	<input type="checkbox"/>	<input type="checkbox"/>
24 x 48 x 48 x 24"	WCC244824	<input type="checkbox"/>	<input type="checkbox"/>	<input type="checkbox"/>	<input type="checkbox"/>	<input type="checkbox"/>	<input type="checkbox"/>	<input type="checkbox"/>	<input type="checkbox"/>	<input type="checkbox"/>	<input type="checkbox"/>	<input type="checkbox"/>
30 x 42 x 42 x 30"	WCC304230	<input type="checkbox"/>	<input type="checkbox"/>	<input type="checkbox"/>	<input type="checkbox"/>	<input type="checkbox"/>	<input type="checkbox"/>	<input type="checkbox"/>	<input type="checkbox"/>	<input type="checkbox"/>	<input type="checkbox"/>	<input type="checkbox"/>
30 x 48 x 48 x 30"	WCC304830	<input type="checkbox"/>	<input type="checkbox"/>	<input type="checkbox"/>	<input type="checkbox"/>	<input type="checkbox"/>	<input type="checkbox"/>	<input type="checkbox"/>	<input type="checkbox"/>	<input type="checkbox"/>	<input type="checkbox"/>	<input type="checkbox"/>



WCS

Stand Alone Corner Curvilinear Worksurface

- Front edge is curved
- Adjustable glides
- Corner support leg is 7/8" sq. tubular steel
- Not available with both (TB) transitional legs

A B C D E F G H I J K L

HOW TO ORDER

Indicate the following information on order form:

1. Quantity of each item.
2. Model number, including options. See "How To Build a Model Number".
3. Any special service required.

Note: • The indicates that a choice is required.

- The absence of the indicates that no choice is required.
- Alpha-numeric characters in place of indicate that no other alternatives are available.

HOW TO BUILD A MODEL NUMBER

- A** Select basic model.
 - BN** - Flat vinyl T-edge
 - 74P** - 74P edge
- B** Select edge style.
- C** Select height.
 - 7** - 27" high
 - 9** - 29" High
- D** Select horizontal wireway.
 - Add upcharge to unit price for WW option.
 - NW** - No horizontal wireway
 - WW** - Wireway
- E** Select frame style.
 - Add upcharge to unit price for WF option.
 - WB** - w/ Beam
 - WM** - w/ Modesty panel
 - WF** - w/ Full modesty panel
 - w/ Full modesty panel (available on 29" high only)

- F** Select location and type of leg.
 - TS** - Standard legs
 - TL** - Transition leg (left)
 - TR** - Transition leg (right)
- G** Select grommet option.
 - Grommets are required for overhead cabinet.
 - OGN** - No worksurface grommet
 - OGY** - Yes worksurface grommet
 - Grommets can be used for wire pass-through.
- H** Select paint color.
 - Refer to color addendum at ki.com or KI Fabrics & Finishes binder.
- I** Select insert color.
 - Refer to color addendum at ki.com or KI Fabrics & Finishes binder.
 - Insert color also includes horizontal wireway (WW) if selected.
- J** Select laminate surface.
 - Refer to color addendum at ki.com or KI

- Fabrics & Finishes binder.
- K** Select edge color.
 - Refer to color addendum at ki.com or KI Fabrics & Finishes binder.
 - Edge color offerings are based on edge style selections.
- L** Select grommet color.
 - Refer to color addendum at ki.com or KI Fabrics & Finishes binder.

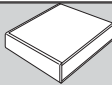
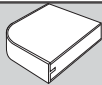

Approx. Packaged Weight	Flat Vinyl T-Edge (BN)	74P Edge (74P)	Wireway add to list price	Full Modesty Panel add to list price
76.0#	\$ 949	\$ 991	\$ 74	\$ 114
96.0#	1006	1054	87	133
106.0#	1062	1115	100	153
108.0#	1122	1177	87	133
118.0#	1179	1236	104	153

FINISH INFORMATION

Additional Laminate Offering

Additional laminates beyond KI standard offering, are available with two weeks extended leadtime. To specify additional laminates, use these designators followed by the supplier's color/pattern code:

- Formica - LF/supplier's color pattern code
- Nevamar - LN/supplier's color pattern code
- Wilsonart - LW/supplier's color pattern code

KI's standard finish is the supplier's recommended finish for that color/pattern.

Note: Nonstandard laminates from these suppliers (example: textured laminates), require an upcharge and additional leadtime. Contact KI.

SPECIAL SERVICES

Special Carton Marking

With specially marked information N/C

Shipping

Shipped k.d. freight prepaid f.o.b. Manitowoc, Wisconsin 54220 factory. Freight class #70.

Specifications and prices are subject to change without prior notice.

WorkZone® Worksurfaces

Basic

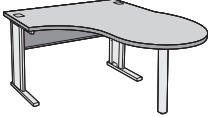
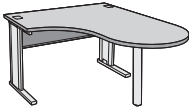
	D x W x L	MODEL NUMBER												
		Basic Model	Edge Style	Dir.	Hgt.	WWay	Frame Style	Trans. Legs	Wrksrf. Grom.	Paint Color	Insert Color	Lam. Color	Edge Color	Grom. Color
 <p>WZW "P" Shaped Peninsula Worksurface (Right Shown)</p> <ul style="list-style-type: none"> Long surface is supported by 3" diameter metal support leg with adjustable glide Connects to either 24" or 30" work surface Adjustable glides Available with 29" height only 	24 x 48 x 60"	WZPT244860	<input type="checkbox"/>	<input type="checkbox"/>	9	<input type="checkbox"/>	<input type="checkbox"/>	<input type="checkbox"/>	<input type="checkbox"/>	<input type="checkbox"/>	<input type="checkbox"/>	<input type="checkbox"/>	<input type="checkbox"/>	<input type="checkbox"/>
	24 x 48 x 66"	WZPT244866	<input type="checkbox"/>	<input type="checkbox"/>	9	<input type="checkbox"/>	<input type="checkbox"/>	<input type="checkbox"/>	<input type="checkbox"/>	<input type="checkbox"/>	<input type="checkbox"/>	<input type="checkbox"/>	<input type="checkbox"/>	<input type="checkbox"/>
	24 x 48 x 72"	WZPT244872	<input type="checkbox"/>	<input type="checkbox"/>	9	<input type="checkbox"/>	<input type="checkbox"/>	<input type="checkbox"/>	<input type="checkbox"/>	<input type="checkbox"/>	<input type="checkbox"/>	<input type="checkbox"/>	<input type="checkbox"/>	<input type="checkbox"/>
	30 x 48 x 66"	WZPT304866	<input type="checkbox"/>	<input type="checkbox"/>	9	<input type="checkbox"/>	<input type="checkbox"/>	<input type="checkbox"/>	<input type="checkbox"/>	<input type="checkbox"/>	<input type="checkbox"/>	<input type="checkbox"/>	<input type="checkbox"/>	<input type="checkbox"/>
	30 x 48 x 72"	WZPT304872	<input type="checkbox"/>	<input type="checkbox"/>	9	<input type="checkbox"/>	<input type="checkbox"/>	<input type="checkbox"/>	<input type="checkbox"/>	<input type="checkbox"/>	<input type="checkbox"/>	<input type="checkbox"/>	<input type="checkbox"/>	<input type="checkbox"/>
 <p>WZW Piano Peninsula Worksurface (Right Shown)</p> <ul style="list-style-type: none"> Long surface is supported by 3" diameter metal support leg with adjustable glide Connects to either 24" or 30" work surface Adjustable glides Available with 29" height only 	24 x 48 x 60"	WZPP244860	<input type="checkbox"/>	<input type="checkbox"/>	9	<input type="checkbox"/>	<input type="checkbox"/>	<input type="checkbox"/>	<input type="checkbox"/>	<input type="checkbox"/>	<input type="checkbox"/>	<input type="checkbox"/>	<input type="checkbox"/>	
	24 x 48 x 66"	WZPP244866	<input type="checkbox"/>	<input type="checkbox"/>	9	<input type="checkbox"/>	<input type="checkbox"/>	<input type="checkbox"/>	<input type="checkbox"/>	<input type="checkbox"/>	<input type="checkbox"/>	<input type="checkbox"/>	<input type="checkbox"/>	
	24 x 48 x 72"	WZPP244872	<input type="checkbox"/>	<input type="checkbox"/>	9	<input type="checkbox"/>	<input type="checkbox"/>	<input type="checkbox"/>	<input type="checkbox"/>	<input type="checkbox"/>	<input type="checkbox"/>	<input type="checkbox"/>	<input type="checkbox"/>	
	30 x 48 x 66"	WZPP304866	<input type="checkbox"/>	<input type="checkbox"/>	9	<input type="checkbox"/>	<input type="checkbox"/>	<input type="checkbox"/>	<input type="checkbox"/>	<input type="checkbox"/>	<input type="checkbox"/>	<input type="checkbox"/>	<input type="checkbox"/>	
	30 x 48 x 72"	WZPP304872	<input type="checkbox"/>	<input type="checkbox"/>	9	<input type="checkbox"/>	<input type="checkbox"/>	<input type="checkbox"/>	<input type="checkbox"/>	<input type="checkbox"/>	<input type="checkbox"/>	<input type="checkbox"/>	<input type="checkbox"/>	

A B C D E F G H I J K L M

HOW TO ORDER

Indicate the following information on order form:

- Quantity of each item.
- Model number, including options. See "How To Build a Model Number".
- Any special service required.

Note: • The indicates that a choice is required.

- The absence of the indicates that no choice is required.
- Alpha-numeric characters in place of indicate that no other alternatives are available.

HOW TO BUILD A MODEL NUMBER

- A** Select basic model.

- B** Select edge style.
BN - Flat vinyl T-edge
74P - 74P edge
- C** Select surface direction.
L - Left
R - Right
Direction is determined by the side of the worksurface that has the 3" diameter leg. Calculate side based on user's normal seated position.
- D** Select height.
9 - 29" high
- E** Select horizontal wireway.
Add upcharge to unit price for WW option.
NW - No horizontal wireway
WW - Wireway
- F** Select frame style.

Add upcharge to unit price for WF option.

- WB** - w/ Beam
- WM** - w/ Modesty panel
- WF** - w/ Full modesty panel
- w/ Full modesty panel (available on 29" high only)
- G** Select location and type of leg.
TS - Standard legs
TL - Transition leg (left)
TR - Transition leg (right)
TB - Transition leg (both)

Note: If ordering Basic Worksurface as a freestanding unit, or if only one side connects to a transitional worksurface, the "TB" option for both transitional legs is not available.

- H** Select grommet option.
Grommets are required for overhead cabinet.
OGN - No worksurface grommet
OGY - Yes worksurface grommet
Grommets can be used for wire pass-through.

- I** Select paint color.
Refer to color addendum at ki.com or KI Fabrics & Finishes binder.
- J** Select insert color.
Refer to color addendum at ki.com or KI Fabrics & Finishes binder. Insert color also includes horizontal wireway (WW) if selected.
- K** Select laminate surface.
Refer to color addendum at ki.com or KI Fabrics & Finishes binder.
- L** Select edge color.
Refer to color addendum at ki.com or KI Fabrics & Finishes binder. Edge color offerings are based on edge style selections.
- M** Select grommet color.
Refer to color addendum at ki.com or KI Fabrics & Finishes binder.

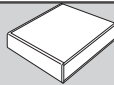
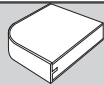

Approx. Packaged Weight	Flat Vinyl T-Edge (BN)	74P Edge (74P)	Wireway add to list price	Full Modesty Panel add to list price
134.0#	\$ 1413	\$ 1486	\$ 49	\$ 77
140.0#	1417	1491	49	77
146.0#	1424	1497	49	77
150.0#	1426	1498	49	77
154.0#	1431	1504	49	77

132.0#	\$ 1339	\$ 1406	\$ 49	\$ 77
138.0#	1343	1409	49	77
144.0#	1347	1412	49	77
146.0#	1353	1418	49	77
148.0#	1357	1424	49	77

FINISH INFORMATION

Additional Laminate Offering

Additional laminates beyond KI standard offering, are available with two weeks extended leadtime. To specify additional laminates, use these designators followed by the supplier's color/pattern code:

- Formica - LF/supplier's color pattern code
- Nevamar - LN/supplier's color pattern code
- Wilsonart - LW/supplier's color pattern code

KI's standard finish is the supplier's recommended finish for that color/pattern.

Note: Nonstandard laminates from these suppliers (example: textured laminates), require an upcharge and additional leadtime. Contact KI.

SPECIAL SERVICES

Special Carton Marking

With specially marked information N/C

Shipping

Shipped k.d. freight prepaid f.o.b. Manitowoc, Wisconsin 54220 factory. Freight class #70.

Specifications and prices are subject to change without prior notice.

WorkZone® Worksurfaces

Basic

	D x W x L	MODEL NUMBER												
		Basic Model	Edge Style	Dir.	Hgt.	WWay	Frame Style	Trans. Legs	Wrksrf. Grom.	Paint Color	Insert Color	Lam. Color	Edge Color	Grom. Color
 <p>WZW Square Shoe Worksurface (Right Shown)</p> <ul style="list-style-type: none"> • Long surface is supported by 3" diameter metal support leg with adjustable glide • Connects to either 24" or 30" worksurface • Adjustable glides • Available with 29" height only 	24 x 48 x 60"	WZSS244860	<input type="checkbox"/>	<input type="checkbox"/>	9	<input type="checkbox"/>	<input type="checkbox"/>	<input type="checkbox"/>	<input type="checkbox"/>	<input type="checkbox"/>	<input type="checkbox"/>	<input type="checkbox"/>	<input type="checkbox"/>	<input type="checkbox"/>
	24 x 48 x 66"	WZSS244866	<input type="checkbox"/>	<input type="checkbox"/>	9	<input type="checkbox"/>	<input type="checkbox"/>	<input type="checkbox"/>	<input type="checkbox"/>	<input type="checkbox"/>	<input type="checkbox"/>	<input type="checkbox"/>	<input type="checkbox"/>	<input type="checkbox"/>
	24 x 48 x 72"	WZSS244872	<input type="checkbox"/>	<input type="checkbox"/>	9	<input type="checkbox"/>	<input type="checkbox"/>	<input type="checkbox"/>	<input type="checkbox"/>	<input type="checkbox"/>	<input type="checkbox"/>	<input type="checkbox"/>	<input type="checkbox"/>	<input type="checkbox"/>
	24 x 48 x 84"	WZSS244884	<input type="checkbox"/>	<input type="checkbox"/>	9	<input type="checkbox"/>	<input type="checkbox"/>	<input type="checkbox"/>	<input type="checkbox"/>	<input type="checkbox"/>	<input type="checkbox"/>	<input type="checkbox"/>	<input type="checkbox"/>	<input type="checkbox"/>
	30 x 48 x 66"	WZSS304866	<input type="checkbox"/>	<input type="checkbox"/>	9	<input type="checkbox"/>	<input type="checkbox"/>	<input type="checkbox"/>	<input type="checkbox"/>	<input type="checkbox"/>	<input type="checkbox"/>	<input type="checkbox"/>	<input type="checkbox"/>	<input type="checkbox"/>
	30 x 48 x 72"	WZSS304872	<input type="checkbox"/>	<input type="checkbox"/>	9	<input type="checkbox"/>	<input type="checkbox"/>	<input type="checkbox"/>	<input type="checkbox"/>	<input type="checkbox"/>	<input type="checkbox"/>	<input type="checkbox"/>	<input type="checkbox"/>	<input type="checkbox"/>
	30 x 48 x 84"	WZSS304884	<input type="checkbox"/>	<input type="checkbox"/>	9	<input type="checkbox"/>	<input type="checkbox"/>	<input type="checkbox"/>	<input type="checkbox"/>	<input type="checkbox"/>	<input type="checkbox"/>	<input type="checkbox"/>	<input type="checkbox"/>	<input type="checkbox"/>

A B C D E F G H I J K L M

HOW TO ORDER

Indicate the following information on order form:

- Quantity of each item.
- Model number, including options. See "How To Build a Model Number".
- Any special service required.

Note: • The indicates that a choice is required.

- The absence of the indicates that no choice is required.
- Alpha-numeric characters in place of indicate that no other alternatives are available.

HOW TO BUILD A MODEL NUMBER

- A** Select basic model.

- B** Select edge style.

BN	- Flat vinyl T-edge
74P	- 74P edge
- C** Select surface direction.

R	- Right
L	- Left

Direction is determined by the side of the worksurface that has the 3" diameter leg. Calculate side based on user's normal seated position.
- D** Select height.

9	- 29" high
----------	------------
- E** Select horizontal wireway.

Add upcharge to unit price for WW option.	
NW	- No horizontal wireway
WW	- Wireway
- F** Select frame style.

Add upcharge to unit price for WF option.

- WB** - w/ Beam
 - WM** - w/ Modesty panel
 - WF** - w/ Full modesty panel
- w/ Full modesty panel (available on 29" high only)
- G** Select location and type of leg.

TS	- Standard legs
TL	- Transition leg (left)
TR	- Transition leg (right)
TB	- Transition leg (both)

Note: If ordering Basic Worksurface as a freestanding unit, or if only one side connects to a transitional worksurface, the "TB" option for both transitional legs is not available.
 - H** Select grommet option.

Grommets are required for overhead cabinet.	
OGN	- No worksurface grommet
OGY	- Yes worksurface grommet

Grommets can be used for wire pass-through.

- I** Select paint color.
Refer to color addendum at ki.com or KI Fabrics & Finishes binder.
- J** Select insert color.
Refer to color addendum at ki.com or KI Fabrics & Finishes binder. Insert color also includes horizontal wireway (WW) if selected.
- K** Select laminate surface.
Refer to color addendum at ki.com or KI Fabrics & Finishes binder.
- L** Select edge color.
Refer to color addendum at ki.com or KI Fabrics & Finishes binder. Edge color offerings are based on edge style selections.
- M** Select grommet color.
Refer to color addendum at ki.com or KI Fabrics & Finishes binder.

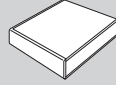
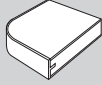

Approx. Packaged Weight	Flat Vinyl T-Edge (BN)	74P Edge (74P)	Wireway add to list price	Full Modesty Panel add to list price
133.0#	\$ 1297	\$ 1360	\$ 49	\$ 77
139.0#	1336	1403	49	77
145.0#	1347	1412	49	77
157.0#	1403	1472	49	77
144.0#	1336	1403	49	77
150.0#	1347	1412	49	77
172.0#	1403	1472	49	77

FINISH INFORMATION

Additional Laminate Offering

Additional laminates beyond KI standard offering, are available with two weeks extended leadtime. To specify additional laminates, use these designators followed by the supplier's color/pattern code:

- Formica - LF/supplier's color pattern code
- Nevamar - LN/supplier's color pattern code
- Wilsonart - LW/supplier's color pattern code

KI's standard finish is the supplier's recommended finish for that color/pattern.

Note: Nonstandard laminates from these suppliers (example: textured laminates), require an upcharge and additional leadtime. Contact KI.

SPECIAL SERVICES

Special Carton Marking

With specially marked information N/C

Shipping

Shipped k.d. freight prepaid f.o.b. Manitowoc, Wisconsin 54220 factory. Freight class #70.

Specifications and prices are subject to change without prior notice.

WorkZone® Worksurfaces

Basic

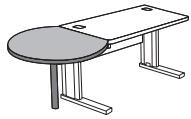

WPW

MODEL

Conference End Worksurface

- WCE36 has a 36" diameter and connects to 24" deep worksurface
- WCE42 has a 42" diameter and connects to 30" deep worksurface
- 3" diameter metal support leg with adjustable glide

MODEL NUMBER	MODEL NUMBER						Approx. Packaged Weight
	Basic Model	Edge Style	Height	Paint Color	Laminate Color	Edge Color	
WCE36	<input type="checkbox"/> <input type="checkbox"/> <input type="checkbox"/>	<input type="checkbox"/> <input type="checkbox"/> <input type="checkbox"/>	9	<input type="checkbox"/> <input type="checkbox"/>	<input type="checkbox"/> <input type="checkbox"/> <input type="checkbox"/>	<input type="checkbox"/> <input type="checkbox"/> <input type="checkbox"/>	75.0#
WCE42	<input type="checkbox"/> <input type="checkbox"/> <input type="checkbox"/>	<input type="checkbox"/> <input type="checkbox"/> <input type="checkbox"/>	9	<input type="checkbox"/> <input type="checkbox"/>	<input type="checkbox"/> <input type="checkbox"/> <input type="checkbox"/>	<input type="checkbox"/> <input type="checkbox"/> <input type="checkbox"/>	85.0#

A **B** **C** **D** **E** **F**

HOW TO ORDER

Indicate the following information on order form:

1. Quantity of each item.
2. Model number, including options. See "How To Build a Model Number".
3. Any special service required.

Note: • The indicates that a choice is required.

- The absence of the indicates that no choice is required.
- Alpha-numeric characters in place of indicate that no other alternatives are available.

HOW TO BUILD A MODEL NUMBER

- A** Select basic model.

- B** Select edge style.

BN	- Flat vinyl T-edge
74P	- 74P edge
- C** Select height.

9	- 29" high
----------	------------
- D** Select paint color.
Refer to color addendum at ki.com or KI Fabrics & Finishes binder.
- E** Select laminate surface.
Refer to color addendum at ki.com or KI Fabrics & Finishes binder.
- F** Select edge color.
Refer to color addendum at ki.com or KI Fabrics & Finishes binder.
Edge color offerings are based on edge style selections.

FINISH INFORMATION

Additional Laminate Offering
Additional laminates beyond KI standard offering, are available with two weeks extended leadtime. To specify additional laminates, use these designators followed by the supplier's color/pattern code:

Formica - LF/supplier's color pattern code
Nevamar - LN/supplier's color pattern code
Wilsonart - LW/supplier's color pattern code

KI's standard finish is the supplier's recommended finish for that color/pattern.
Note: Nonstandard laminates from these suppliers (example: textured laminates), require an upcharge and additional leadtime. Contact KI.

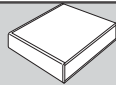
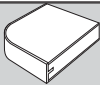

Flat Vinyl T-Edge
(BN)

74P Edge
(74P)

\$ 479

\$ 500

510

535

SPECIAL SERVICES

Special Carton Marking

With specially marked information N/C



Shipping

Shipped k.d. freight prepaid f.o.b. Manitowoc, Wisconsin 54220 factory. Freight class #70.

Specifications and prices are subject to change without prior notice.

WorkZone® Worksurfaces

Mobile

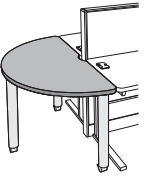
	MODEL	Features	D x DIA	MODEL NUMBER						
				Basic Model	Edge Style	Height	Paint Color	Base	Laminate Color	Edge Color
	Mobile Teardrop Worksurface	<ul style="list-style-type: none"> Base consists of 3" diameter metal support leg with adjustable chrome-plated glide 3" casters are optional; two are locking Connects to end of 24" or 30" worksurface Wireway option not available 29" height only with or without casters 	24 x 40"	WMT2440	<input type="checkbox"/> <input type="checkbox"/> <input type="checkbox"/>	9	<input type="checkbox"/> <input type="checkbox"/>	<input type="checkbox"/>	<input type="checkbox"/> <input type="checkbox"/> <input type="checkbox"/>	<input type="checkbox"/> <input type="checkbox"/>
			30 x 50"	WMT3050	<input type="checkbox"/> <input type="checkbox"/> <input type="checkbox"/>	9	<input type="checkbox"/> <input type="checkbox"/>	<input type="checkbox"/>	<input type="checkbox"/> <input type="checkbox"/> <input type="checkbox"/>	<input type="checkbox"/> <input type="checkbox"/>
	Mobile Semi-Circle Worksurface	<ul style="list-style-type: none"> Base consists of 3" diameter metal support leg with adjustable chrome-plated glide Aligns with end of 24" or 30" worksurface Notched in center for wire management Wireway option not available 29" height only with or without casters 3" casters are optional; two are locking 	24 x 48"	WMSC48	<input type="checkbox"/> <input type="checkbox"/> <input type="checkbox"/>	9	<input type="checkbox"/> <input type="checkbox"/>	<input type="checkbox"/>	<input type="checkbox"/> <input type="checkbox"/> <input type="checkbox"/>	<input type="checkbox"/> <input type="checkbox"/>
			30 x 60"	WMSC60	<input type="checkbox"/> <input type="checkbox"/> <input type="checkbox"/>	9	<input type="checkbox"/> <input type="checkbox"/>	<input type="checkbox"/>	<input type="checkbox"/> <input type="checkbox"/> <input type="checkbox"/>	<input type="checkbox"/> <input type="checkbox"/>
	Mobile Semi-Circle Worksurface w/notch	<ul style="list-style-type: none"> Use with WireWorks panels Notch enables surface to wrap around end cap of WireWorks panel 51-1/2" diameter accommodates two 24" deep worksurfaces separated by a WireWorks panel 63-1/2" diameter accommodates two 30" deep worksurfaces separated by a WireWorks panel Std. for use with radius WireWorks end caps Flat for use with WireWorks & Unite flat metal trim 	Std. 24 X 51-1/2"	WMSCPW52	<input type="checkbox"/> <input type="checkbox"/> <input type="checkbox"/>	9	<input type="checkbox"/> <input type="checkbox"/>	<input type="checkbox"/>	<input type="checkbox"/> <input type="checkbox"/> <input type="checkbox"/>	<input type="checkbox"/> <input type="checkbox"/>
			Std. 30 X 63-1/2"	WMSCPW64	<input type="checkbox"/> <input type="checkbox"/> <input type="checkbox"/>	9	<input type="checkbox"/> <input type="checkbox"/>	<input type="checkbox"/>	<input type="checkbox"/> <input type="checkbox"/> <input type="checkbox"/>	<input type="checkbox"/> <input type="checkbox"/>
			Flat 24 X 51-1/2"	WMSCFW52	<input type="checkbox"/> <input type="checkbox"/> <input type="checkbox"/>	9	<input type="checkbox"/> <input type="checkbox"/>	<input type="checkbox"/>	<input type="checkbox"/> <input type="checkbox"/> <input type="checkbox"/>	<input type="checkbox"/> <input type="checkbox"/>
			Flat 30 X 63-1/2"	WMSCFW64	<input type="checkbox"/> <input type="checkbox"/> <input type="checkbox"/>	9	<input type="checkbox"/> <input type="checkbox"/>	<input type="checkbox"/>	<input type="checkbox"/> <input type="checkbox"/> <input type="checkbox"/>	<input type="checkbox"/> <input type="checkbox"/>
				A	B	C	D	E	F	G

HOW TO ORDER

Indicate the following information on order form:

- Quantity of each item.
- Model number, including options. See "How To Build a Model Number".
- Any special service required.

Note: • The indicates that a choice is required.

- The absence of the indicates that no choice is required.
- Alpha-numeric characters in place of indicate that no other alternatives are available.

HOW TO BUILD A MODEL NUMBER

- A** Select basic model.
- B** Select edge style.
BN - Flat vinyl T-edge
74P - 74P edge
- C** Select height.
9 - 29" high
- D** Select paint color.
Refer to color addendum at ki.com or KI Fabrics & Finishes binder.
- E** Select base option.
G - Glides (4 glides)
C - Casters; add \$40
- F** Select laminate surface.
Refer to color addendum at ki.com or KI Fabrics & Finishes binder.
- G** Select edge color.
Refer to color addendum at ki.com or KI

Fabrics & Finishes binder.
Edge color offerings are based on edge style selections.

FINISH INFORMATION

Additional Laminate Offering

Additional laminates beyond KI standard offering, are available with two weeks extended leadtime. To specify additional laminates, use these designators followed by the supplier's color/pattern code:

Formica - LF/supplier's color pattern code
Nevamar - LN/supplier's color pattern code
Wilsonart - LW/supplier's color pattern code

KI's standard finish is the supplier's recommended finish for that color/pattern.

Note: Nonstandard laminates from these suppliers (example: textured laminates), require an upcharge and additional leadtime. Contact KI.

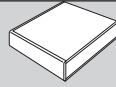

Approx. Packaged Weight	Flat Vinyl T-Edge (BN)	74P Edge (74P)
70.0#	\$ 845	\$ 886
104.0#	847	889

68.0#	\$ 883	\$ 928
86.0#	1015	1064

69.0#	\$ 1011	\$ 1061
88.0#	1030	1083
69.0#	1011	1061
88.0#	1030	1083

SPECIAL SERVICES

Special Carton Marking

With specially marked information N/C

Shipping

Shipped k.d. freight prepaid f.o.b. Manitowoc, Wisconsin 54220 factory. Freight class #70.

Specifications and prices are subject to change without prior notice.

WorkZone® Worksurfaces

Transitional

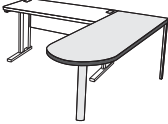
MODEL	D x W	MODEL NUMBER							Approx. Packaged Weight
		Basic Model	Edge Style	Height	Frame Style	Paint Color	Laminate Color	Edge Color	
 <p>Peninsula End Worksurface</p> <ul style="list-style-type: none"> • 3" diameter metal support leg • Wireway option not available • Available with 29" height only 	24 x 48"	WPW2448	<input type="checkbox"/> <input type="checkbox"/> <input type="checkbox"/>	9		<input type="checkbox"/> <input type="checkbox"/>	<input type="checkbox"/> <input type="checkbox"/> <input type="checkbox"/>	<input type="checkbox"/> <input type="checkbox"/> <input type="checkbox"/>	44.0#
	24 x 60"	WPW2460	<input type="checkbox"/> <input type="checkbox"/> <input type="checkbox"/>	9		<input type="checkbox"/> <input type="checkbox"/>	<input type="checkbox"/> <input type="checkbox"/> <input type="checkbox"/>	<input type="checkbox"/> <input type="checkbox"/> <input type="checkbox"/>	57.0#
	24 x 72"	WPW2472	<input type="checkbox"/> <input type="checkbox"/> <input type="checkbox"/>	9		<input type="checkbox"/> <input type="checkbox"/>	<input type="checkbox"/> <input type="checkbox"/> <input type="checkbox"/>	<input type="checkbox"/> <input type="checkbox"/> <input type="checkbox"/>	68.0#
	30 x 48"	WPW3048	<input type="checkbox"/> <input type="checkbox"/> <input type="checkbox"/>	9		<input type="checkbox"/> <input type="checkbox"/>	<input type="checkbox"/> <input type="checkbox"/> <input type="checkbox"/>	<input type="checkbox"/> <input type="checkbox"/> <input type="checkbox"/>	48.0#
	30 x 60"	WPW3060	<input type="checkbox"/> <input type="checkbox"/> <input type="checkbox"/>	9		<input type="checkbox"/> <input type="checkbox"/>	<input type="checkbox"/> <input type="checkbox"/> <input type="checkbox"/>	<input type="checkbox"/> <input type="checkbox"/> <input type="checkbox"/>	63.0#
	30 x 72"	WPW3072	<input type="checkbox"/> <input type="checkbox"/> <input type="checkbox"/>	9		<input type="checkbox"/> <input type="checkbox"/>	<input type="checkbox"/> <input type="checkbox"/> <input type="checkbox"/>	<input type="checkbox"/> <input type="checkbox"/> <input type="checkbox"/>	75.0#
 <p>Peninsula Side Mount Worksurface</p> <ul style="list-style-type: none"> • 3" diameter metal support leg • When specifying peninsula side mount worksurface a transitional leg must be ordered on the basic surface to which it will connect • Wireway option not available • Available with 29" height only • The selection of with Beam, modesty or full modesty is for the 24 or 30" depth • If a guest side modesty is desired that would need to be specified separately 	24 x 48"	WPW2448S	<input type="checkbox"/> <input type="checkbox"/> <input type="checkbox"/>	9	<input type="checkbox"/> <input type="checkbox"/>	<input type="checkbox"/> <input type="checkbox"/>	<input type="checkbox"/> <input type="checkbox"/> <input type="checkbox"/>	<input type="checkbox"/> <input type="checkbox"/> <input type="checkbox"/>	51.0#
	24 x 60"	WPW2460S	<input type="checkbox"/> <input type="checkbox"/> <input type="checkbox"/>	9	<input type="checkbox"/> <input type="checkbox"/>	<input type="checkbox"/> <input type="checkbox"/>	<input type="checkbox"/> <input type="checkbox"/> <input type="checkbox"/>	<input type="checkbox"/> <input type="checkbox"/> <input type="checkbox"/>	64.0#
	24 x 72"	WPW2472S	<input type="checkbox"/> <input type="checkbox"/> <input type="checkbox"/>	9	<input type="checkbox"/> <input type="checkbox"/>	<input type="checkbox"/> <input type="checkbox"/>	<input type="checkbox"/> <input type="checkbox"/> <input type="checkbox"/>	<input type="checkbox"/> <input type="checkbox"/> <input type="checkbox"/>	77.0#
	30 x 48"	WPW3048S	<input type="checkbox"/> <input type="checkbox"/> <input type="checkbox"/>	9	<input type="checkbox"/> <input type="checkbox"/>	<input type="checkbox"/> <input type="checkbox"/>	<input type="checkbox"/> <input type="checkbox"/> <input type="checkbox"/>	<input type="checkbox"/> <input type="checkbox"/> <input type="checkbox"/>	59.0#
	30 x 60"	WPW3060S	<input type="checkbox"/> <input type="checkbox"/> <input type="checkbox"/>	9	<input type="checkbox"/> <input type="checkbox"/>	<input type="checkbox"/> <input type="checkbox"/>	<input type="checkbox"/> <input type="checkbox"/> <input type="checkbox"/>	<input type="checkbox"/> <input type="checkbox"/> <input type="checkbox"/>	71.0#
	30 x 72"	WPW3072S	<input type="checkbox"/> <input type="checkbox"/> <input type="checkbox"/>	9	<input type="checkbox"/> <input type="checkbox"/>	<input type="checkbox"/> <input type="checkbox"/>	<input type="checkbox"/> <input type="checkbox"/> <input type="checkbox"/>	<input type="checkbox"/> <input type="checkbox"/> <input type="checkbox"/>	83.0#

A

B

C

D

E

F

G

HOW TO ORDER

Indicate the following information on order form:

1. Quantity of each item.
2. Model number, including options. See "How To Build a Model Number".
3. Any special service required.

Note: • The indicates that a choice is required.

- The absence of the indicates that no choice is required.
- Alpha-numeric characters in place of indicate that no other alternatives are available.

HOW TO BUILD A MODEL NUMBER

A Select basic model.

B Select edge style.

BN - Flat vinyl T-edge
74P - 74P edge

C Select height.

9 - 29" high

D Select frame style.

Add upcharge to unit price for WF option.

WB - w/ Beam
WM - w/ Modesty panel
WF - w/ Full modesty panel

E Select paint color.

Refer to color addendum at ki.com or KI Fabrics & Finishes binder.

F Select laminate surface.

Refer to color addendum at ki.com or KI Fabrics & Finishes binder.

G Select edge color.

Refer to color addendum at ki.com or KI Fabrics & Finishes binder. Edge color offerings are based on edge style selections.

FINISH INFORMATION

Additional Laminate Offering

Additional laminates beyond KI standard offering, are available with two weeks extended leadtime. To specify additional laminates, use these designators followed by the supplier's color/pattern code:

Formica - LF/supplier's color pattern code
Nevamar - LN/supplier's color pattern code
Wilsonart - LW/supplier's color pattern code

KI's standard finish is the supplier's recommended finish for that color/pattern.

Note: Nonstandard laminates from these suppliers (example: textured laminates), require an upcharge and additional leadtime. Contact KI.

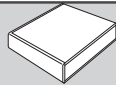
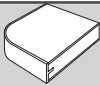

Flat Vinyl T-Edge
(BN)

74P Edge
(74P)

Full
Modesty
Panel
add to list
price

\$ 572	\$ 600	N/A
607	638	N/A
639	671	N/A
580	609	N/A
617	650	N/A
655	686	N/A

\$ 618	\$ 651	\$ 39
662	696	39
702	739	39
633	664	47
673	708	47
717	753	47

SPECIAL SERVICES

Special Carton Marking

With specially marked information N/C

Shipping

Shipped k.d. freight prepaid f.o.b. Manitowoc, Wisconsin 54220 factory. Freight class #70.

Specifications and prices are subject to change without prior notice.

WorkZone® Worksurfaces

Transitional

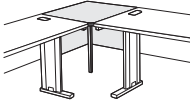
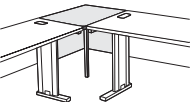
			MODEL NUMBER									
MODEL	D x W	Basic Model	Edge Style	Trans. Dir.	Trans. Height	WWay	Frame Style	Paint Color	Insert Color	Laminate Color	Edge Color	
 <p>Square Transitional Surface</p> <ul style="list-style-type: none"> • Full wrap modesty panel included • For use with fixed height workstations only • Corner support leg is 7/8" square tubular steel 	24 x 24"	WST2424	<input type="checkbox"/> <input type="checkbox"/> <input type="checkbox"/>	<input type="checkbox"/>	<input type="checkbox"/> <input type="checkbox"/>	<input type="checkbox"/> <input type="checkbox"/>	<input type="checkbox"/> <input type="checkbox"/>	<input type="checkbox"/> <input type="checkbox"/>	<input type="checkbox"/> <input type="checkbox"/> <input type="checkbox"/>	<input type="checkbox"/> <input type="checkbox"/> <input type="checkbox"/>	<input type="checkbox"/> <input type="checkbox"/> <input type="checkbox"/>	
	30 x 30"	WST3030	<input type="checkbox"/> <input type="checkbox"/> <input type="checkbox"/>	<input type="checkbox"/>	<input type="checkbox"/> <input type="checkbox"/>	<input type="checkbox"/> <input type="checkbox"/>	<input type="checkbox"/> <input type="checkbox"/>	<input type="checkbox"/> <input type="checkbox"/>	<input type="checkbox"/> <input type="checkbox"/> <input type="checkbox"/>	<input type="checkbox"/> <input type="checkbox"/> <input type="checkbox"/>	<input type="checkbox"/> <input type="checkbox"/> <input type="checkbox"/>	
 <p>Rectangle Transitional Surface</p> <ul style="list-style-type: none"> • Full wrap modesty panel included • For use with fixed height workstations only • Corner support leg is 7/8" square tubular steel 	24 x 30"	WRT2430	<input type="checkbox"/> <input type="checkbox"/> <input type="checkbox"/>	<input type="checkbox"/>	<input type="checkbox"/> <input type="checkbox"/>	<input type="checkbox"/> <input type="checkbox"/>	<input type="checkbox"/> <input type="checkbox"/>	<input type="checkbox"/> <input type="checkbox"/> <input type="checkbox"/>	<input type="checkbox"/> <input type="checkbox"/> <input type="checkbox"/>	<input type="checkbox"/> <input type="checkbox"/> <input type="checkbox"/>		
	30 x 24"	WRT3024	<input type="checkbox"/> <input type="checkbox"/> <input type="checkbox"/>	<input type="checkbox"/>	<input type="checkbox"/> <input type="checkbox"/>	<input type="checkbox"/> <input type="checkbox"/>	<input type="checkbox"/> <input type="checkbox"/>	<input type="checkbox"/> <input type="checkbox"/> <input type="checkbox"/>	<input type="checkbox"/> <input type="checkbox"/> <input type="checkbox"/>	<input type="checkbox"/> <input type="checkbox"/> <input type="checkbox"/>	<input type="checkbox"/> <input type="checkbox"/> <input type="checkbox"/>	

A B C D E F G H I J

WCT

WCT

HOW TO ORDER

Indicate the following information on order form:

1. Quantity of each item.
2. Model number, including options. See "How To Build a Model Number".
3. Any special service required.

Note:

- The indicates that a choice is required.
- The absence of the indicates that no choice is required.
- Alpha-numeric characters in place of indicate that no other alternatives are available.

HOW TO BUILD A MODEL NUMBER

- A** Select basic model.

<u> </u>

- B** Select edge style.

<u>BN</u> - Flat vinyl T-edge
<u>74P</u> - 74P edge
- C** Select transition direction.

<u>X</u> - None
<u>L</u> - Left
<u>R</u> - Right

Transition direction is determined from the originating 24" or 30" basic or keyboard pad worksurface. All square and rectangular transitional surfaces connected at the same height do not require Right (R) or Left (L) transition direction. Use "X" for transition direction. Transitional direction required for "97" transitional height.
- D** Select transition height.

<u>77</u> - 27" to 27" high
<u>97</u> - 29" to 27" high
<u>99</u> - 29" to 29" high

- E** Select horizontal wireway.
 Add upcharge to unit price for WW option.

<u>NW</u> - No horizontal wireway
<u>WW</u> - Wireway
- F** Select frame style.
 Add upcharge to unit price for WF option.

<u>WM</u> - w/ Modesty panel
<u>WF</u> - w/ Full modesty panel

 w/ Full modesty panel (available on 29" high only)
- G** Select paint color.
 Refer to color addendum at ki.com or KI Fabrics & Finishes binder.
- H** Select insert color.
 Refer to color addendum at ki.com or KI Fabrics & Finishes binder. Insert color also includes horizontal wireway (WW) if selected.
- I** Select laminate surface.
 Refer to color addendum at ki.com or KI

Fabrics & Finishes binder.

- J** Select edge color.
 Refer to color addendum at ki.com or KI Fabrics & Finishes binder. Edge color offerings are based on edge style selections.

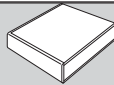
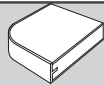

Approx. Packaged Weight	Flat Vinyl T-Edge (BN)	74P Edge (74P)	Full Modesty Panel add to list price	Wireway add to list price
34.0#	\$ 349	\$ 369	\$ 78	\$ 68
51.0#	438	462	94	71
38.0#	\$ 431	\$ 437	\$ 85	\$ 68
38.0#	431	437	85	68

FINISH INFORMATION

Additional Laminate Offering

Additional laminates beyond KI standard offering, are available with two weeks extended leadtime. To specify additional laminates, use these designators followed by the supplier's color/pattern code:

- Formica - LF/supplier's color pattern code
- Nevamar - LN/supplier's color pattern code
- Wilsonart - LW/supplier's color pattern code

KI's standard finish is the supplier's recommended finish for that color/pattern.

Note: Nonstandard laminates from these suppliers (example: textured laminates), require an upcharge and additional leadtime. Contact KI.

SPECIAL SERVICES

Special Carton Marking

With specially marked information N/C

Shipping

Shipped k.d. freight prepaid f.o.b. Manitowoc, Wisconsin 54220 factory. Freight class #70.

Specifications and prices are subject to change without prior notice.

WorkZone® Worksurfaces

Transitional

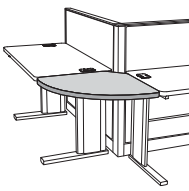
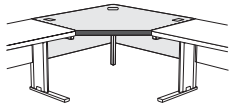
D x W-LEFT x W-RIGHT x D	MODEL NUMBER												
	Basic Model	Edge Style	Trans. Dir.	Trans. Height	WWay	Frame Style	Grom	Paint Clr	Insr Clr	Lam Clr	Edge Clr	Grm Clr	
 <p>24 X 24" Dia for Panel</p> <p>30 X 30" Dia for Panel</p>	WQRPW24	<input type="checkbox"/>								<input type="checkbox"/>	<input type="checkbox"/>		
	WQRPW30	<input type="checkbox"/>								<input type="checkbox"/>	<input type="checkbox"/>		
 <p>24 x 36 x 36 x 24"</p> <p>24 x 42 x 42 x 24"</p> <p>24 x 48 x 48 x 24"</p> <p>30 x 42 x 42 x 30"</p> <p>30 x 48 x 48 x 30"</p>	WCT2436	<input type="checkbox"/>	<input type="checkbox"/>	<input type="checkbox"/>	<input type="checkbox"/>	<input type="checkbox"/>	<input type="checkbox"/>	<input type="checkbox"/>	<input type="checkbox"/>	<input type="checkbox"/>	<input type="checkbox"/>	<input type="checkbox"/>	
	WCT2442	<input type="checkbox"/>	<input type="checkbox"/>	<input type="checkbox"/>	<input type="checkbox"/>	<input type="checkbox"/>	<input type="checkbox"/>	<input type="checkbox"/>	<input type="checkbox"/>	<input type="checkbox"/>	<input type="checkbox"/>	<input type="checkbox"/>	
	WCT2448	<input type="checkbox"/>	<input type="checkbox"/>	<input type="checkbox"/>	<input type="checkbox"/>	<input type="checkbox"/>	<input type="checkbox"/>	<input type="checkbox"/>	<input type="checkbox"/>	<input type="checkbox"/>	<input type="checkbox"/>	<input type="checkbox"/>	
	WCT3042	<input type="checkbox"/>	<input type="checkbox"/>	<input type="checkbox"/>	<input type="checkbox"/>	<input type="checkbox"/>	<input type="checkbox"/>	<input type="checkbox"/>	<input type="checkbox"/>	<input type="checkbox"/>	<input type="checkbox"/>	<input type="checkbox"/>	
	WCT3048	<input type="checkbox"/>	<input type="checkbox"/>	<input type="checkbox"/>	<input type="checkbox"/>	<input type="checkbox"/>	<input type="checkbox"/>	<input type="checkbox"/>	<input type="checkbox"/>	<input type="checkbox"/>	<input type="checkbox"/>	<input type="checkbox"/>	

WCT
Quarter Round Transitional Surface

- Two splice plates provided
- For use with fixed height workstations only
- Available with flat vinyl T-edge or 74P edge
- For use as conferencing corner
- Wireway option not available
- Modesty panel not required
- 24" surface has radius of 26 2/3" and 30" surface has a radius of 35"

WCT
Corner Transitional Surface

- For use with fixed height workstations only
- Corner support leg is 7/8" sq. tubular steel
- Front edge dimension is 17" on 24x36" and 30x42"; 25-1/2" on 24x42" and 30x48"; 34" on 24x48"
- Overheads may not be specified

A B C D E F G H I J K L

HOW TO ORDER

- Indicate the following information on order form:
1. Quantity of each item.
 2. Model number, including options. See "How To Build a Model Number".
 3. Any special service required.

Note: • The indicates that a choice is required.
 • The absence of the indicates that no choice is required.
 • Alpha-numeric characters in place of indicate that no other alternatives are available.

HOW TO BUILD A MODEL NUMBER

- A** Select basic model.
- B** Select edge style.
 - BN** - Flat vinyl T-edge
 - 74P** - 74P edge
 - EP** - Elliptical postformed edge
 - PF** - Postformed edge
- C** Select transition direction.
 - L** - Left
 - R** - Right
 - X** - None

Transition direction is determined from the originating 24" or 30" basic or keyboard pad worksurface. All corner transitional surfaces connected at the same height do not require right (R) or left (L) transition direction. Use "X" for transition direction. Transition height required for "97" transitional.
- D** Select transition height.
 - 77** - 27" to 27" high

- 97** - 29" to 27" high
- 99** - 29" to 29" high
- E** Select horizontal wireway. Add upcharge to unit price for WW option.
 - NW** - No horizontal wireway
 - WW** - Wireway
- F** Select frame style. Add upcharge to unit price for WF option.
 - WB** - w/ Beam
 - WM** - w/ Modesty panel
 - WF** - w/ Full modesty panel

w/ Full modesty panel (available on 29" high only)
- G** Select grommet option.
 - OGN** - No worksurface grommet
 - OGY** - Yes worksurface grommet

Grommets can be used for wire pass-through.
- H** Select paint color. Refer to color addendum at ki.com or KI Fabrics & Finishes binder.

- I** Select insert color. Refer to color addendum at ki.com or KI Fabrics & Finishes binder. Insert color also includes horizontal wireway (WW) if selected.
- J** Select laminate surface. Refer to color addendum at ki.com or KI Fabrics & Finishes binder.
- K** Select edge color. Refer to color addendum at ki.com or KI Fabrics & Finishes binder. Edge color offerings are based on edge style selections.
- L** Select grommet color. Refer to color addendum at ki.com or KI Fabrics & Finishes binder.

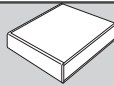
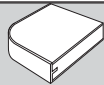

Approx. Packaged Weight	Flat Vinyl T-Edge (BN)	74P Edge (74P)	Elliptical Postformed Edge (EP)	Postformed Edge (PF)	Full Modesty Panel add to list price	Wireway add to list price
34.0#	\$ 430	\$ 454	N/A	N/A	N/A	N/A
51.0#	446	470	N/A	N/A	N/A	N/A

72.0#	\$ 754	\$ 790	\$ 830	\$ 871	\$ 114	\$ 74
80.0#	810	850	893	935	133	87
96.0#	865	911	953	999	153	100
98.0#	923	969	1015	1064	133	87
102.0#	980	1026	1076	1132	153	104

FINISH INFORMATION

Additional Laminate Offering

Additional laminates beyond KI standard offering, are available with two weeks extended leadtime. To specify additional laminates, use these designators followed by the supplier's color/pattern code:

- Formica - LF/supplier's color pattern code
- Nevamar - LN/supplier's color pattern code
- Wilsonart - LW/supplier's color pattern code

KI's standard finish is the supplier's recommended finish for that color/pattern.

Note: Nonstandard laminates from these suppliers (example: textured laminates), require an upcharge and additional leadtime. Contact KI.

SPECIAL SERVICES

Special Carton Marking

With specially marked information N/C

Shipping

Shipped k.d. freight prepaid f.o.b. Manitowoc, Wisconsin 54220 factory. Freight class #70.

Specifications and prices are subject to change without prior notice.

WorkZone® Worksurfaces

Transitional

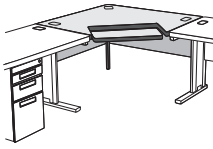
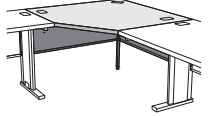
	D x W-LEFT x W-RIGHT x D	MODEL NUMBER											
		Basic Model	Edge Style	Trans. Dir.	Trans. Height	WWay	Frame Style	Grom	Paint Clr	Insrt Clr	Lam Clr	Edge Clr	Grm Clr
 <p>WCT Corner Transitional Surface with Keyboard Pad</p> <ul style="list-style-type: none"> • Keyboard pad: 10" x 24"; 3" height adjustments: 1" forward extension adjustment: 15° maximum downward tilt • For use with fixed height workstations only • Corner support leg is 7/8" sq. tubular steel • Overheads may not be specified 	24 x 42 x 42 x 24"	WCTK2442	<input type="checkbox"/>	<input type="checkbox"/>	<input type="checkbox"/>	<input type="checkbox"/>	<input type="checkbox"/>	<input type="checkbox"/>	<input type="checkbox"/>	<input type="checkbox"/>	<input type="checkbox"/>	<input type="checkbox"/>	<input type="checkbox"/>
	24 x 48 x 48 x 24"	WCTK2448	<input type="checkbox"/>	<input type="checkbox"/>	<input type="checkbox"/>	<input type="checkbox"/>	<input type="checkbox"/>	<input type="checkbox"/>	<input type="checkbox"/>	<input type="checkbox"/>	<input type="checkbox"/>	<input type="checkbox"/>	<input type="checkbox"/>
	30 x 48 x 48 x 30"	WCTK3048	<input type="checkbox"/>	<input type="checkbox"/>	<input type="checkbox"/>	<input type="checkbox"/>	<input type="checkbox"/>	<input type="checkbox"/>	<input type="checkbox"/>	<input type="checkbox"/>	<input type="checkbox"/>	<input type="checkbox"/>	<input type="checkbox"/>
 <p>WCT Corner Transitional Reduction Surface</p> <ul style="list-style-type: none"> • For use with fixed height workstations only • Corner support leg is 7/8" sq. tubular steel • Used to join 24" and 30" deep work-surfaces in corner • Overheads may not be specified 	24 x 42 x 42 x 30"	WCT244230	<input type="checkbox"/>	<input type="checkbox"/>	<input type="checkbox"/>	<input type="checkbox"/>	<input type="checkbox"/>	<input type="checkbox"/>	<input type="checkbox"/>	<input type="checkbox"/>	<input type="checkbox"/>	<input type="checkbox"/>	
	24 x 48 x 48 x 30"	WCT244830	<input type="checkbox"/>	<input type="checkbox"/>	<input type="checkbox"/>	<input type="checkbox"/>	<input type="checkbox"/>	<input type="checkbox"/>	<input type="checkbox"/>	<input type="checkbox"/>	<input type="checkbox"/>	<input type="checkbox"/>	
	30 x 42 x 42 x 24"	WCT304224	<input type="checkbox"/>	<input type="checkbox"/>	<input type="checkbox"/>	<input type="checkbox"/>	<input type="checkbox"/>	<input type="checkbox"/>	<input type="checkbox"/>	<input type="checkbox"/>	<input type="checkbox"/>	<input type="checkbox"/>	
	30 x 48 x 48 x 24"	WCT304824	<input type="checkbox"/>	<input type="checkbox"/>	<input type="checkbox"/>	<input type="checkbox"/>	<input type="checkbox"/>	<input type="checkbox"/>	<input type="checkbox"/>	<input type="checkbox"/>	<input type="checkbox"/>	<input type="checkbox"/>	

A B C D E F G H I J K L

HOW TO ORDER

Indicate the following information on order form:

1. Quantity of each item.
2. Model number, including options. See "How To Build a Model Number".
3. Any special service required.

Note: • The indicates that a choice is required.

- The absence of the indicates that no choice is required.
- Alpha-numeric characters in place of indicate that no other alternatives are available.

HOW TO BUILD A MODEL NUMBER

- A** Select basic model.

- B** Select edge style.
BN - Flat vinyl T-edge
74P - 74P edge

- C** Select transition direction.
L - Left
R - Right
X - None
Transition direction is determined from the originating 24" or 30" basic or keyboard pad worksurface. All corner transitional surfaces connected at the same height do not require right (R) or left (L) transition direction. Use "X" for transition direction. Transition height required for "97" transitional.

- D** Select transition height.
77 - 27" to 27" high
97 - 29" to 27" high
99 - 29" to 29" high

- E** Select horizontal wireway.
Add upcharge to unit price for WW option.
NW - No horizontal wireway
WW - Wireway

- F** Select frame style.
Add upcharge to unit price for WF option.
WB - w/ Beam
WM - w/ Modesty panel
WF - w/ Full modesty panel
w/ Full modesty panel (available on 29" high only)

- G** Select grommet option.
OGN - No worksurface grommet
OGY - Yes worksurface grommet
Grommets can be used for wire pass-through.

- H** Select paint color.
Refer to color addendum at ki.com or KI Fabrics & Finishes binder.

- I** Select insert color.

Refer to color addendum at ki.com or KI Fabrics & Finishes binder. Insert color also includes horizontal wireway (WW) if selected.

- J** Select laminate surface.
Refer to color addendum at ki.com or KI Fabrics & Finishes binder.
- K** Select edge color.
Refer to color addendum at ki.com or KI Fabrics & Finishes binder. Edge color offerings are based on edge style selections.
- L** Select grommet color.
Refer to color addendum at ki.com or KI Fabrics & Finishes binder.

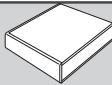
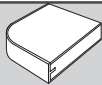

Approx. Packaged Weight	Flat Vinyl T-Edge (BN)	74P Edge (74P)	Full Modesty Panel add to list price	Wireway add to list price
80.0#	\$ 952	\$ 998	\$ 133	\$ 87
91.0#	1036	1088	153	100
102.0#	1122	1177	153	104
96.0#	\$ 1036	\$ 1088	\$ 133	\$ 87
102.0#	1122	1177	153	100
96.0#	1036	1088	133	87
102.0#	1122	1177	153	100

FINISH INFORMATION

Additional Laminate Offering

Additional laminates beyond KI standard offering, are available with two weeks extended leadtime. To specify additional laminates, use these designators followed by the supplier's color/pattern code:

- Formica - LF/supplier's color pattern code
- Nevamar - LN/supplier's color pattern code
- Wilsonart - LW/supplier's color pattern code

KI's standard finish is the supplier's recommended finish for that color/pattern.

Note: Nonstandard laminates from these suppliers (example: textured laminates), require an upcharge and additional leadtime. Contact KI.

SPECIAL SERVICES

Special Carton Marking

With specially marked information N/C

Shipping

Shipped k.d. freight prepaid f.o.b. Manitowoc, Wisconsin 54220 factory. Freight class #70.

Specifications and prices are subject to change without prior notice.

WorkZone® Worksurfaces

Transitional

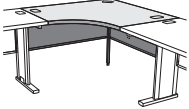
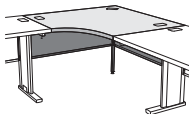
D x W-LEFT x W-RIGHT x D	MODEL NUMBER												
	Basic Model	Edge Style	Trans. Dir.	Trans. Height	WWay	Frame Style	Grom	Paint Color	Insrt Clr	Lam Clr	Edge Clr	Grm Clr	
 <p>WCT Corner Curvilinear Transitional Surface</p> <ul style="list-style-type: none"> • For use with fixed height workstations only • Corner support leg is 7/8" sq. tubular steel • Curved front surface • Overheads may not be specified 	24 x 36 x 36 x 24"	WCCT2436	<input type="checkbox"/>	<input type="checkbox"/>	<input type="checkbox"/>	<input type="checkbox"/>	<input type="checkbox"/>	<input type="checkbox"/>	<input type="checkbox"/>	<input type="checkbox"/>	<input type="checkbox"/>	<input type="checkbox"/>	<input type="checkbox"/>
	24 x 42 x 42 x 24"	WCCT2442	<input type="checkbox"/>	<input type="checkbox"/>	<input type="checkbox"/>	<input type="checkbox"/>	<input type="checkbox"/>	<input type="checkbox"/>	<input type="checkbox"/>	<input type="checkbox"/>	<input type="checkbox"/>	<input type="checkbox"/>	<input type="checkbox"/>
	24 x 48 x 48 x 24"	WCCT2448	<input type="checkbox"/>	<input type="checkbox"/>	<input type="checkbox"/>	<input type="checkbox"/>	<input type="checkbox"/>	<input type="checkbox"/>	<input type="checkbox"/>	<input type="checkbox"/>	<input type="checkbox"/>	<input type="checkbox"/>	<input type="checkbox"/>
	30 x 42 x 42 x 30"	WCCT3042	<input type="checkbox"/>	<input type="checkbox"/>	<input type="checkbox"/>	<input type="checkbox"/>	<input type="checkbox"/>	<input type="checkbox"/>	<input type="checkbox"/>	<input type="checkbox"/>	<input type="checkbox"/>	<input type="checkbox"/>	<input type="checkbox"/>
	30 x 48 x 48 x 30"	WCCT3048	<input type="checkbox"/>	<input type="checkbox"/>	<input type="checkbox"/>	<input type="checkbox"/>	<input type="checkbox"/>	<input type="checkbox"/>	<input type="checkbox"/>	<input type="checkbox"/>	<input type="checkbox"/>	<input type="checkbox"/>	<input type="checkbox"/>
 <p>WCT Corner Curvilinear Transitional Reduction Surface</p> <ul style="list-style-type: none"> • For use with fixed height workstations only • Corner support leg is 7/8" sq. tubular steel • Used to join 24" and 30" worksurfaces in corner • Curved front surface • Overheads may not be specified 	24 x 42 x 42 x 30"	WCCT244230	<input type="checkbox"/>	<input type="checkbox"/>	<input type="checkbox"/>	<input type="checkbox"/>	<input type="checkbox"/>	<input type="checkbox"/>	<input type="checkbox"/>	<input type="checkbox"/>	<input type="checkbox"/>	<input type="checkbox"/>	<input type="checkbox"/>
	24 x 48 x 48 x 30"	WCCT244830	<input type="checkbox"/>	<input type="checkbox"/>	<input type="checkbox"/>	<input type="checkbox"/>	<input type="checkbox"/>	<input type="checkbox"/>	<input type="checkbox"/>	<input type="checkbox"/>	<input type="checkbox"/>	<input type="checkbox"/>	<input type="checkbox"/>
	30 x 42 x 42 x 24"	WCCT304224	<input type="checkbox"/>	<input type="checkbox"/>	<input type="checkbox"/>	<input type="checkbox"/>	<input type="checkbox"/>	<input type="checkbox"/>	<input type="checkbox"/>	<input type="checkbox"/>	<input type="checkbox"/>	<input type="checkbox"/>	<input type="checkbox"/>
	30 x 48 x 48 x 24"	WCCT304824	<input type="checkbox"/>	<input type="checkbox"/>	<input type="checkbox"/>	<input type="checkbox"/>	<input type="checkbox"/>	<input type="checkbox"/>	<input type="checkbox"/>	<input type="checkbox"/>	<input type="checkbox"/>	<input type="checkbox"/>	<input type="checkbox"/>

A B C D E F G H I J K L

HOW TO ORDER

Indicate the following information on order form:

- Quantity of each item.
- Model number, including options. See "How To Build a Model Number".
- Any special service required.

Note: • The indicates that a choice is required.
 • The absence of the indicates that no choice is required.
 • Alpha-numeric characters in place of indicate that no other alternatives are available.

HOW TO BUILD A MODEL NUMBER

- A** Select basic model.

- B** Select edge style.
BN - Flat vinyl T-edge
74P - 74P edge

- C** Select transition direction.
L - Left
R - Right
X - None
 Transition direction is determined from the originating 24" or 30" basic or keyboard pad worksurface. All corner transitional surfaces connected at the same height do not require right (R) or left (L) transition direction. Use "X" for transition direction. Transition height required for "97" transitional.

- D** Select transition height.
77 - 27" to 27" high
97 - 29" to 27" high
99 - 29" to 29" high

- E** Select horizontal wireway.
 Add upcharge to unit price for WW option.
NW - No horizontal wireway
WW - Wireway

- F** Select frame style.
 Add upcharge to unit price for WF option.
WB - w/ Beam
WM - w/ Modesty panel
WF - w/ Full modesty panel
 w/ Full modesty panel (available on 29" high only)

- G** Select grommet option.
OGN - No worksurface grommet
OGY - Yes worksurface grommet
 Grommets can be used for wire pass-through.

- H** Select paint color.
 Refer to color addendum at ki.com or KI Fabrics & Finishes binder.

- I** Select insert color.

Refer to color addendum at ki.com or KI Fabrics & Finishes binder. Insert color also includes horizontal wireway (WW) if selected.

- J** Select laminate surface.
 Refer to color addendum at ki.com or KI Fabrics & Finishes binder.
- K** Select edge color.
 Refer to color addendum at ki.com or KI Fabrics & Finishes binder. Edge color offerings are based on edge style selections.
- L** Select grommet color.
 Refer to color addendum at ki.com or KI Fabrics & Finishes binder.

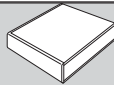
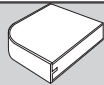

Approx. Packaged Weight	Flat Vinyl T-Edge (BN)	74P Edge (74P)	Full Modesty Panel add to list price	Wireway add to list price
72.0#	\$ 754	\$ 790	\$ 114	\$ 74
80.0#	810	850	133	87
102.0#	865	911	153	100
90.0#	923	969	133	87
102.0#	980	1026	153	104
96.0#	\$ 1036	\$ 1088	\$ 133	\$ 87
102.0#	1122	1177	153	100
96.0#	1036	1088	133	87
102.0#	1122	1177	153	100

FINISH INFORMATION

Additional Laminate Offering

Additional laminates beyond KI standard offering, are available with two weeks extended leadtime. To specify additional laminates, use these designators followed by the supplier's color/pattern code:

- Formica - LF/supplier's color pattern code
- Nevamar - LN/supplier's color pattern code
- Wilsonart - LW/supplier's color pattern code

KI's standard finish is the supplier's recommended finish for that color/pattern.

Note: Nonstandard laminates from these suppliers (example: textured laminates), require an upcharge and additional leadtime. Contact KI.

SPECIAL SERVICES

Special Carton Marking

With specially marked information N/C

Shipping

Shipped k.d. freight prepaid f.o.b. Manitowoc, Wisconsin 54220 factory. Freight class #70.

Specifications and prices are subject to change without prior notice.

WorkZone® Worksurfaces

Transitional

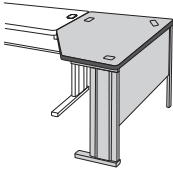
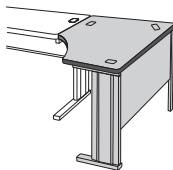
D x W-LEFT x W-RIGHT x D	MODEL NUMBER												
	Basic Model	Edge Style	Trans. Dir.	Hgt.	WWay	Frame Style	Wrksrf. Grom.	Paint Color	Insert Color	Lam. Color	Edge Color	Grom. Color	
	24 x 36 x 36 x 24"	WER2436	<input type="checkbox"/>	<input type="checkbox"/>	<input type="checkbox"/>	<input type="checkbox"/>	<input type="checkbox"/>	<input type="checkbox"/>	<input type="checkbox"/>	<input type="checkbox"/>	<input type="checkbox"/>	<input type="checkbox"/>	<input type="checkbox"/>
	24 x 42 x 42 x 24"	WER2442	<input type="checkbox"/>	<input type="checkbox"/>	<input type="checkbox"/>	<input type="checkbox"/>	<input type="checkbox"/>	<input type="checkbox"/>	<input type="checkbox"/>	<input type="checkbox"/>	<input type="checkbox"/>	<input type="checkbox"/>	<input type="checkbox"/>
	24 x 48 x 48 x 24"	WER2448	<input type="checkbox"/>	<input type="checkbox"/>	<input type="checkbox"/>	<input type="checkbox"/>	<input type="checkbox"/>	<input type="checkbox"/>	<input type="checkbox"/>	<input type="checkbox"/>	<input type="checkbox"/>	<input type="checkbox"/>	<input type="checkbox"/>
	30 x 42 x 42 x 30"	WER3042	<input type="checkbox"/>	<input type="checkbox"/>	<input type="checkbox"/>	<input type="checkbox"/>	<input type="checkbox"/>	<input type="checkbox"/>	<input type="checkbox"/>	<input type="checkbox"/>	<input type="checkbox"/>	<input type="checkbox"/>	<input type="checkbox"/>
	30 x 48 x 48 x 30"	WER3048	<input type="checkbox"/>	<input type="checkbox"/>	<input type="checkbox"/>	<input type="checkbox"/>	<input type="checkbox"/>	<input type="checkbox"/>	<input type="checkbox"/>	<input type="checkbox"/>	<input type="checkbox"/>	<input type="checkbox"/>	<input type="checkbox"/>
<p>WER</p> <p>End-of-Run Corner Surface</p> <ul style="list-style-type: none"> For use with fixed height workstations only Corner support leg is 7/8" square tubular steel Corner Overheads (Universal or Balance®) may only be specified on the full-leg side 													
	24 x 36 x 36 x 24"	WCCE2436	<input type="checkbox"/>	<input type="checkbox"/>	<input type="checkbox"/>	<input type="checkbox"/>	<input type="checkbox"/>	<input type="checkbox"/>	<input type="checkbox"/>	<input type="checkbox"/>	<input type="checkbox"/>	<input type="checkbox"/>	<input type="checkbox"/>
	24 x 42 x 42 x 24"	WCCE2442	<input type="checkbox"/>	<input type="checkbox"/>	<input type="checkbox"/>	<input type="checkbox"/>	<input type="checkbox"/>	<input type="checkbox"/>	<input type="checkbox"/>	<input type="checkbox"/>	<input type="checkbox"/>	<input type="checkbox"/>	<input type="checkbox"/>
	24 x 48 x 48 x 24"	WCCE2448	<input type="checkbox"/>	<input type="checkbox"/>	<input type="checkbox"/>	<input type="checkbox"/>	<input type="checkbox"/>	<input type="checkbox"/>	<input type="checkbox"/>	<input type="checkbox"/>	<input type="checkbox"/>	<input type="checkbox"/>	<input type="checkbox"/>
	30 x 42 x 42 x 30"	WCCE3042	<input type="checkbox"/>	<input type="checkbox"/>	<input type="checkbox"/>	<input type="checkbox"/>	<input type="checkbox"/>	<input type="checkbox"/>	<input type="checkbox"/>	<input type="checkbox"/>	<input type="checkbox"/>	<input type="checkbox"/>	<input type="checkbox"/>
	30 x 48 x 48 x 30"	WCCE3048	<input type="checkbox"/>	<input type="checkbox"/>	<input type="checkbox"/>	<input type="checkbox"/>	<input type="checkbox"/>	<input type="checkbox"/>	<input type="checkbox"/>	<input type="checkbox"/>	<input type="checkbox"/>	<input type="checkbox"/>	<input type="checkbox"/>
<p>WER</p> <p>End-of-Run Curvilinear Surface</p> <ul style="list-style-type: none"> For use with fixed height workstations only Corner support leg is 7/8" square tubular steel Corner Overheads (Universal or Balance®) may only be specified on the full-leg side 													

A B C D E F G H I J K L

HOW TO ORDER

Indicate the following information on order form:

- Quantity of each item.
- Model number, including options. See "How To Build a Model Number".
- Any special service required.

Note: • The indicates that a choice is required.
 • The absence of the indicates that no choice is required.
 • Alpha-numeric characters in place of indicate that no other alternatives are available.

HOW TO BUILD A MODEL NUMBER

- A** Select basic model.
- B** Select edge style.
 - BN** - Flat vinyl T-edge
 - 74P** - 74P edge
 - EP** - Elliptical postformed edge
 - PF** - Postformed edge
- C** Select transition direction.
 - L** - Left
 - R** - Right

Transition direction is determined from the originating 24" or 30" basic or keyboard pad work surface. When ordering an End-of-Run work surface, the adjoining work surface must have a transitional leg. Order a right or left transitional.
- D** Select height.
 - 7** - 27" high
 - 9** - 29" High
- E** Select horizontal wireway.

Add upcharge to unit price for WW option.
NW - No horizontal wireway
WW - Wireway

- F** Select frame style. Add upcharge to unit price for WF option.
 - WB** - w/ Beam
 - WM** - w/ Modesty panel
 - WF** - w/ Full modesty panel w/ Full modesty panel (available on 29" high only)

- G** Select grommet option. Grommets are required for overhead cabinet.
 - OGN** - No work surface grommet
 - OGY** - Yes work surface grommet

Grommets can be used for wire pass-through.

- H** Select paint color. Refer to color addendum at ki.com or KI Fabrics & Finishes binder.

- I** Select insert color.

Refer to color addendum at ki.com or KI Fabrics & Finishes binder. Insert color also includes horizontal wireway (WW) if selected.

- J** Select laminate surface. Refer to color addendum at ki.com or KI Fabrics & Finishes binder.
- K** Select edge color. Refer to color addendum at ki.com or KI Fabrics & Finishes binder. Edge color offerings are based on edge style selections.
- L** Select grommet color. Refer to color addendum at ki.com or KI Fabrics & Finishes binder.

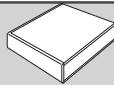
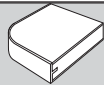

Approx. Packaged Weight	Flat Vinyl T-Edge (BN)	74P Edge (74P)	Elliptical Postformed Edge (EP)	Postformed Edge (PF)	Wireway add to list price	Full Modesty Panel add to list price
74.0#	\$ 850	\$ 893	\$ 934	\$ 984	\$ 172	\$ 114
78.0#	911	955	999	1050	192	133
82.0#	965	1015	1063	1117	192	153
96.0#	1022	1074	1127	1182	192	133
100.0#	1292	1357	1422	1492	192	153

76.0#	\$ 850	\$ 893	N/A	N/A	\$ 172	\$ 114
96.0#	911	955	N/A	N/A	192	133
106.0#	965	1128	N/A	N/A	192	153
108.0#	1022	1074	N/A	N/A	192	133
118.0#	1083	1135	N/A	N/A	192	153

FINISH INFORMATION

Additional Laminate Offering

Additional laminates beyond KI standard offering, are available with two weeks extended leadtime. To specify additional laminates, use these designators followed by the supplier's color/pattern code:

- Formica - LF/supplier's color pattern code
- Nevamar - LN/supplier's color pattern code
- Wilsonart - LW/supplier's color pattern code

KI's standard finish is the supplier's recommended finish for that color/pattern.

Note: Nonstandard laminates from these suppliers (example: textured laminates), require an upcharge and additional leadtime. Contact KI.

SPECIAL SERVICES

Special Carton Marking

With specially marked information N/C

Shipping

Shipped k.d. freight prepaid f.o.b. Manitowoc, Wisconsin 54220 factory. Freight class #70.

Specifications and prices are subject to change without prior notice.

WorkZone® Worksurfaces

Accessories and Worksurface Connectors

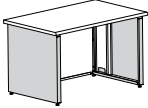
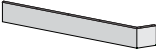
	MODEL	Size	D x W	MODEL NUMBER		Approx. Packaged Weight	
				Basic Model	Paint Color		
	Full Leg End Panel • Single end panel • Non-handed works as either left or right-handed • Attaches over existing desk leg		24 x 29"	WBW24FEP	<input type="checkbox"/>	3.0#	
			30 x 29"	WBW30FEP	<input type="checkbox"/>	4.0#	
WFEP							
	Guest Modesty Panel • Can be used on any peninsula or square shoe other than WorkZone® Instruct Desk • Non-handed works as either left or right-handed		For 60"	9 x 50"	WZMP60	<input type="checkbox"/>	3.0#
			66"	9 x 56"	WZMP66	<input type="checkbox"/>	3.5#
			72"	9 x 62"	WZMP72	<input type="checkbox"/>	4.0#
			84"	9 x 74"	WZMP84	<input type="checkbox"/>	4.5#
HRDPT							
HRDPT	Worksurface Height Change Connectors • Attaches 27" - 29" high worksurfaces • Can't be used with "T6" option			87.4624	<input type="checkbox"/>	2.0#	

A

B

HOW TO ORDER

Indicate the following information on order form:

- Quantity of each item.
- Model number, including options. See "How To Build a Model Number".
- Any special service required.

Note: • The indicates that a choice is required.

- The absence of the indicates that no choice is required.
- Alpha-numeric characters in place of indicate that no other alternatives are available.

HOW TO BUILD A MODEL NUMBER

- A** Select basic model.
- B** Select paint color.
Refer to color addendum at ki.com or KI Fabrics & Finishes binder.



Delivered
Pricing

\$ 97

103

\$ 92

105

115

118

\$ 21

SPECIAL SERVICES

Special Carton Marking

With specially marked information N/C

Shipping

Shipped k.d. freight prepaid f.o.b. Manitowoc, Wisconsin 54220 factory. Freight class #70.

Specifications and prices are subject to change without prior notice.

WorkZone® Components

General information



Universal Overhead Cabinet (WZUS)



Balance Overhead Cabinet (BLCs)



Privacy Screens (WZP)

Features

Solid color/translucent door	•
Fabric door	•
Laminate door	•
Steel Door	•
Fully assembled	•
Task light	•
Hanging tackboard	•
Hanging tool rail	•
Fabric covered screen	•
Field installable	

BLCs, BLCL, BLCF Models:

Overhead Width	Door Overhang In Open Position	No. Of Doors	Inside Width of Overhead	Dimension Between Side Sets at Worksurface
30"	3"	1	27 ³ / ₄ "	27"
36"	3"	1	33 ³ / ₄ "	33"
42"	3"	1	39 ³ / ₄ "	39"
48"	3"	1	45 ³ / ₄ "	45"
54"	3"	1	51 ³ / ₄ "	51"
60"	3"	1	57 ³ / ₄ "	57"
66"	3"	2	2 x 27 ³ / ₄ "	2 x 28"
72"	3"	2	2 x 33 ³ / ₄ "	2 x 34"

Overall height from worksurface to top of overhead is 36".

Overhead top slants upward 1" from the back to the door.

Overhead allow for 19¹/₂" clearance from worksurface to underside of shelf.

WZUS, WZUF, WZUL Models:

Overhead Width	Door Overhang In Open Position	No. Of Doors	Inside Width of Overhead	Dimension Between Side Sets at Worksurface
30"	4"	1	29 ¹ / ₂ "	27"
36"	4"	1	35 ¹ / ₂ "	33"
42"	4"	1	41 ¹ / ₂ "	39"
48"	4"	1	47 ¹ / ₂ "	45"
54"	4"	1	53 ¹ / ₂ "	51"
60"	4"	1	59 ¹ / ₂ "	57"
66"	4"	2	1 x 29 ¹ / ₂ " 1 x 35 ¹ / ₂ "	1 x 28" 1 x 34"
72"	4"	2	2 x 35 ¹ / ₂ "	2 x 34"

Overall height from worksurface to top of overhead is 36".

Overhead allows for 19¹/₂" clearance from worksurface to underside of shelf.

SPECIFICATIONS

Universal Overhead Cabinets

Overhead storage shall consist of overhead cabinet(s) and shelves. Overhead storage shall attach to worksurface with two overhead support stanchions for 30", 36", 42", 48", 54" and 60" sizes. Three overhead support stanchions for 66" and 72" sizes. 66" overheads shall consist of a 30" and 36" overhead combination. 72" overheads shall consist of a pair of 36" overheads.

Shelf dividers shall be powder-coated steel with installation and removal accomplished without the use of tools or fasteners.

Universal overheads and shelves shall be 17" high and shall have 19-1/2" clearance between the worksurface and the bottom of shelf. Overhead doors shall be available with painted steel, fabric, laminate, or veneer, with a Polypropylene extrusion handle. Locks shall be randomly assigned or keyed per customer requests. The end panels shall

be constructed of 14-gauge steel and have self-locking mounting tabs formed into the back edge. The shelf, back, and top shall be constructed from 18-gauge steel.

Balance® Overhead Cabinets

Overhead storage shall consist of overhead cabinet. Overhead storage shall attach to worksurface with two overhead support stanchions for 30", 36", 42", 48", 54", 60", 66" and 72" sizes.

Shelf dividers shall be powder-coated steel with installation and removal accomplished without the use of tools or fasteners.

Balance® overheads shall be 17" high and have 19-1/2" clearance between the worksurface and the bottom of shelf. The upper door shall be available in colored or translucent extruded rigid Polypropylene with spatter-coat finish, fabric, or laminate applied. The overall door thickness shall be 3/8". The lower door shall be an aluminum extrusion and be ergonomic in design. A center lock mechanism shall be utilized

between the upper and the lower doors for security. The overhead doors shall be effortlessly operated from either a seated or standing position through use of the upper or lower door. The upper door and lower door shall be synchronized in motion through the use of two 10-gauge linkages. The doors shall be assisted with two extension springs and require less than 5 pounds of force to operate. The upper door shall open over the outside of the case.

Privacy Screens (WZPR)

Two or three 1/8" cold rolled steel brackets, sandwiched between two 1/2" Gypsum boards joined together with industrial adhesive. The screens attach to the back of the worksurface with fasteners. Steel splice plates are used to align adjoining screens. Privacy screen is 19-1/2" high above worksurface.

Key Options

There are various key options available depending on the component model. The key alike option (KA) allows multiple

components of a workstation to be keyed alike. The lock number can be specified. The key standard option (KS) allows each component to have its own randomly selected key number shipped with the individual component. The no lock core option (NLC) provides more flexibility in keying workstations alike. All locks and keys for the individual components specified with no lock core will be packaged separately from the components. The location of the lock core and corresponding numbered key will be determined upon installation.

Fabric

Fabric will be applied as swatched by the fabric manufacturer. Fabric that is required to be applied differently than is swatched will need a Special Cost Request written specifying the direction the fabric is to be applied. The posted standard lead time will apply to the Special Cost Request.



WorkZone[®] Components

Universal Overhead Storage

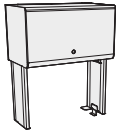
MODEL	W x H x D	MODEL NUMBER						Approx. Packaged Weight
		Basic Model	Assembly	Overhead Type	Paint Color	Insert Color	Key Option	
 <p>WZUS</p> <p>Universal Overhead Cabinet with Steel Door</p> <ul style="list-style-type: none"> The KI Universal Overhead allows users the option to interchange from a WorkZone[®] desk mount solution to a KI office panel system Steel end panels, bottom, top shelf, and door with powder-coated finish Double bit lock is included with key alike option Door stores recessed with handle exposed Shelf depth is 13-1/4" 66" overhead has one 30" door and one 36" door with a support offset 6" from the center of the worksurface 72" overhead has 36" doors and middle support upright For use with fixed height worksurfaces Concealed vertical wire management Secured to steel legs by concealed mounting brackets Accepts shelf divider Cannot be mounted on tables with casters 66" and 72" wide overhead are not available on WorkZone[®] frames with beams 	30 x 16-1/2 x 14-1/2"	WZUS30	<input type="checkbox"/>	<input type="checkbox"/>	<input type="checkbox"/>	<input type="checkbox"/>	<input type="checkbox"/>	72.0#
	36 x 16-1/2 x 14-1/2"	WZUS36	<input type="checkbox"/>	<input type="checkbox"/>	<input type="checkbox"/>	<input type="checkbox"/>	<input type="checkbox"/>	81.0#
	42 x 16-1/2 x 14-1/2"	WZUS42	<input type="checkbox"/>	<input type="checkbox"/>	<input type="checkbox"/>	<input type="checkbox"/>	<input type="checkbox"/>	88.0#
	48 x 16-1/2 x 14-1/2"	WZUS48	<input type="checkbox"/>	<input type="checkbox"/>	<input type="checkbox"/>	<input type="checkbox"/>	<input type="checkbox"/>	99.0#
	54 x 16-1/2 x 14-1/2"	WZUS54	<input type="checkbox"/>	<input type="checkbox"/>	<input type="checkbox"/>	<input type="checkbox"/>	<input type="checkbox"/>	106.0#
	60 x 16-1/2 x 14-1/2"	WZUS60	<input type="checkbox"/>	<input type="checkbox"/>	<input type="checkbox"/>	<input type="checkbox"/>	<input type="checkbox"/>	115.0#
	66 x 16-1/2 x 14-1/2"	WZUS66	<input type="checkbox"/>	<input type="checkbox"/>	<input type="checkbox"/>	<input type="checkbox"/>	<input type="checkbox"/>	135.0#
	72 x 16-1/2 x 14-1/2"	WZUS72	<input type="checkbox"/>	<input type="checkbox"/>	<input type="checkbox"/>	<input type="checkbox"/>	<input type="checkbox"/>	156.0#
<p>OCR-OCL</p> <ul style="list-style-type: none"> OCR = Overhead right OCL = Overhead left 								

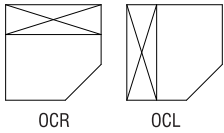

A B C D E F

HOW TO ORDER

Indicate the following information on order form:

- Quantity of each item.
- Model number, including options. See "How To Build a Model Number".
- Any special service required.

Note: • The indicates that a choice is required.
 • The absence of the indicates that no choice is required.
 • Alpha-numeric characters in place of indicate that no other alternatives are available.

HOW TO BUILD A MODEL NUMBER

- A** Select basic model.
- B** Select assembly.
 - U - Unassembled
 - F - Fully assembled; add \$129
- C** Select overhead type.
 - OCL - Corner overhead left
 - OCR - Corner overhead right
 - OS - Overhead standard
- D** Select paint color. Refer to color addendum at ki.com or KI Fabrics & Finishes binder.
- E** Select insert color. Refer to color addendum at ki.com or KI Fabrics & Finishes binder.
- F** Select key option. Grommets are required for overhead cabinet
 - KA - Key alike

KS - Key standard
NLC - No lock core



Delivered Pricing

\$ 819
840
862
881
992
1040
1486
1508

SPECIAL SERVICES

Special Carton Marking

With specially marked information N/C

Shipping

Shipped k.d. freight prepaid f.o.b. Manitowoc, Wisconsin 54220 factory. Freight class #70.

Specifications and prices are subject to change without prior notice.

WorkZone® Components

Universal Overhead Storage



WZUL

- MODEL** **W x H x D**
- Universal Overhead Cabinet with Laminate Door**
- The KI Universal Overhead allows users the option to interchange from a WorkZone® desk mount solution to a KI office panel system
 - Steel end panels, bottom and top shelf with powder-coated finish
 - High-pressure laminate on particleboard door
 - Double bit lock is included with key alike option
 - End panel bracket design prevents accidental dislodging of components
 - Shelf depth is 13-1/4"
 - Door stores recessed with handle exposed
 - 66" overhead has one 30" door and one 36" door with a support offset 6" from the center of the worksurface
 - 72" overhead has 36" doors and middle support upright
 - For use with fixed height worksurfaces
 - Concealed vertical wire management
 - Secured to steel legs by concealed mounting brackets
 - Cannot be mounted on tables with casters
 - 66" and 72" wide overhead are not available on WorkZone® frames with beams

- OCR-OCL**
- OCR = Overhead right OCL = Overhead left

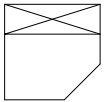

OCR

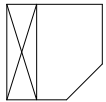

OCL

HOW TO ORDER

Indicate the following information on order form:

- Quantity of each item.
- Model number, including options. See "How To Build a Model Number".
- Any special service required.

Note: • The indicates that a choice is required.

- The absence of the indicates that no choice is required.
- Alpha-numeric characters in place of indicate that no other alternatives are available.

HOW TO BUILD A MODEL NUMBER

- A** Select basic model.
 U - Unassembled
 F - Fully assembled; add \$129
- B** Select assembly option.
- C** Select overhead type.
 OCL - Corner overhead left
 OCR - Corner overhead right
 OS - Overhead standard
- D** Select paint color.
 Refer to color addendum at ki.com or KI Fabrics & Finishes binder.
- E** Select insert color.
 Refer to color addendum at ki.com or KI Fabrics & Finishes binder.
- F** Select laminate surface.
 Refer to color addendum at ki.com or KI Fabrics & Finishes binder.

- G** Select key option.
 KA - Key alike
 KS - Key standard
 NLC - No lock core

FINISH INFORMATION

Additional Laminate Offering

Additional laminates beyond KI standard offering, are available with two weeks extended leadtime. To specify additional laminates, use these designators followed by the supplier's color/pattern code:

Formica - LF/supplier's color pattern code
 Nevamar - LN/supplier's color pattern code
 Wilsonart - LW/supplier's color pattern code

KI's standard finish is the supplier's recommended finish for that color/pattern.

Note: Nonstandard laminates from these suppliers (example: textured laminates), require an upcharge and additional leadtime. Contact KI.

MODEL	W x H x D	MODEL NUMBER						
		Basic Model	Assembly	Overhead Type	Paint Color	Insert Color	Laminate Color	Key Option
Universal Overhead Cabinet with Laminate Door	30 x 16-1/2 x 14-1/2"	WZUL30	<input type="checkbox"/>	<input type="checkbox"/>	<input type="checkbox"/>	<input type="checkbox"/>	<input type="checkbox"/>	<input type="checkbox"/>
	36 x 16-1/2 x 14-1/2"	WZUL36	<input type="checkbox"/>	<input type="checkbox"/>	<input type="checkbox"/>	<input type="checkbox"/>	<input type="checkbox"/>	<input type="checkbox"/>
	42 x 16-1/2 x 14-1/2"	WZUL42	<input type="checkbox"/>	<input type="checkbox"/>	<input type="checkbox"/>	<input type="checkbox"/>	<input type="checkbox"/>	<input type="checkbox"/>
	48 x 16-1/2 x 14-1/2"	WZUL48	<input type="checkbox"/>	<input type="checkbox"/>	<input type="checkbox"/>	<input type="checkbox"/>	<input type="checkbox"/>	<input type="checkbox"/>
	54 x 16-1/2 x 14-1/2"	WZUL54	<input type="checkbox"/>	<input type="checkbox"/>	<input type="checkbox"/>	<input type="checkbox"/>	<input type="checkbox"/>	<input type="checkbox"/>
	60 x 16-1/2 x 14-1/2"	WZUL60	<input type="checkbox"/>	<input type="checkbox"/>	<input type="checkbox"/>	<input type="checkbox"/>	<input type="checkbox"/>	<input type="checkbox"/>
	66 x 16-1/2 x 14-1/2"	WZUL66	<input type="checkbox"/>	<input type="checkbox"/>	<input type="checkbox"/>	<input type="checkbox"/>	<input type="checkbox"/>	<input type="checkbox"/>
	72 x 16-1/2 x 14-1/2"	WZUL72	<input type="checkbox"/>	<input type="checkbox"/>	<input type="checkbox"/>	<input type="checkbox"/>	<input type="checkbox"/>	<input type="checkbox"/>

A B C D E F G



Approx. Packaged Weight	Delivered Pricing
73.0#	\$ 882
81.0#	921
89.0#	957
99.0#	991
107.0#	1091
116.0#	1141
137.0#	1643
157.0#	1683

SPECIAL SERVICES

Special Carton Marking

With specially marked information N/C

Shipping

Shipped k.d. freight prepaid f.o.b. Manitowoc, Wisconsin 54220 factory. Freight class #70.

Specifications and prices are subject to change without prior notice.

WorkZone® Components

Universal Overhead Storage

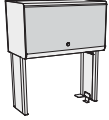

WZUF

MODEL

W x H x D

Universal Overhead Cabinet with Fabric Door

- The KI Universal Overhead allows users the option to interchange from a WorkZone® desk mount solution to a KI office panel system
- Steel end panels, bottom and top shelf with powder-coated finish
- Fabric-covered door
- Double bit lock is included with key alike option
- End panel bracket design prevents accidental dislodging of components
- Shelf depth is 13-1/4"
- Door stores recessed with handle exposed
- 66" overhead has one 30" door and one 36" door with a support offset 6" from the center of the worksurface
- 72" overhead has 36" doors and middle support upright
- For use with fixed height worksurfaces
- Concealed vertical wire management
- Secured to steel legs by concealed mounting brackets
- Accepts shelf divider
- Cannot be mounted on tables with casters
- 66" and 72" wide overhead are not available on WorkZone® frames with beams

OCR-OCL

- OCR = Overhead right OCL = Overhead left

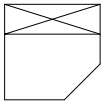

OCR

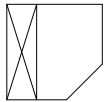

OCL

MODEL NUMBER

Basic Model	Assembly	Overhead Type	Paint Color	Insert Color	Fabric Color	Key Option
WZUF30	<input type="checkbox"/>	<input type="checkbox"/> <input type="checkbox"/> <input type="checkbox"/>	<input type="checkbox"/> <input type="checkbox"/> <input type="checkbox"/>	<input type="checkbox"/> <input type="checkbox"/> <input type="checkbox"/>	<input type="checkbox"/> <input type="checkbox"/> <input type="checkbox"/> <input type="checkbox"/> <input type="checkbox"/> <input type="checkbox"/>	<input type="checkbox"/> <input type="checkbox"/> <input type="checkbox"/> <input type="checkbox"/>
WZUF36	<input type="checkbox"/>	<input type="checkbox"/> <input type="checkbox"/> <input type="checkbox"/>	<input type="checkbox"/> <input type="checkbox"/> <input type="checkbox"/>	<input type="checkbox"/> <input type="checkbox"/> <input type="checkbox"/>	<input type="checkbox"/> <input type="checkbox"/> <input type="checkbox"/> <input type="checkbox"/> <input type="checkbox"/> <input type="checkbox"/>	<input type="checkbox"/> <input type="checkbox"/> <input type="checkbox"/> <input type="checkbox"/>
WZUF42	<input type="checkbox"/>	<input type="checkbox"/> <input type="checkbox"/> <input type="checkbox"/>	<input type="checkbox"/> <input type="checkbox"/> <input type="checkbox"/>	<input type="checkbox"/> <input type="checkbox"/> <input type="checkbox"/>	<input type="checkbox"/> <input type="checkbox"/> <input type="checkbox"/> <input type="checkbox"/> <input type="checkbox"/> <input type="checkbox"/>	<input type="checkbox"/> <input type="checkbox"/> <input type="checkbox"/> <input type="checkbox"/>
WZUF48	<input type="checkbox"/>	<input type="checkbox"/> <input type="checkbox"/> <input type="checkbox"/>	<input type="checkbox"/> <input type="checkbox"/> <input type="checkbox"/>	<input type="checkbox"/> <input type="checkbox"/> <input type="checkbox"/>	<input type="checkbox"/> <input type="checkbox"/> <input type="checkbox"/> <input type="checkbox"/> <input type="checkbox"/> <input type="checkbox"/>	<input type="checkbox"/> <input type="checkbox"/> <input type="checkbox"/> <input type="checkbox"/>
WZUF54	<input type="checkbox"/>	<input type="checkbox"/> <input type="checkbox"/> <input type="checkbox"/>	<input type="checkbox"/> <input type="checkbox"/> <input type="checkbox"/>	<input type="checkbox"/> <input type="checkbox"/> <input type="checkbox"/>	<input type="checkbox"/> <input type="checkbox"/> <input type="checkbox"/> <input type="checkbox"/> <input type="checkbox"/> <input type="checkbox"/>	<input type="checkbox"/> <input type="checkbox"/> <input type="checkbox"/> <input type="checkbox"/>
WZUF60	<input type="checkbox"/>	<input type="checkbox"/> <input type="checkbox"/> <input type="checkbox"/>	<input type="checkbox"/> <input type="checkbox"/> <input type="checkbox"/>	<input type="checkbox"/> <input type="checkbox"/> <input type="checkbox"/>	<input type="checkbox"/> <input type="checkbox"/> <input type="checkbox"/> <input type="checkbox"/> <input type="checkbox"/> <input type="checkbox"/>	<input type="checkbox"/> <input type="checkbox"/> <input type="checkbox"/> <input type="checkbox"/>
WZUF66	<input type="checkbox"/>	<input type="checkbox"/> <input type="checkbox"/> <input type="checkbox"/>	<input type="checkbox"/> <input type="checkbox"/> <input type="checkbox"/>	<input type="checkbox"/> <input type="checkbox"/> <input type="checkbox"/>	<input type="checkbox"/> <input type="checkbox"/> <input type="checkbox"/> <input type="checkbox"/> <input type="checkbox"/> <input type="checkbox"/>	<input type="checkbox"/> <input type="checkbox"/> <input type="checkbox"/> <input type="checkbox"/>
WZUF72	<input type="checkbox"/>	<input type="checkbox"/> <input type="checkbox"/> <input type="checkbox"/>	<input type="checkbox"/> <input type="checkbox"/> <input type="checkbox"/>	<input type="checkbox"/> <input type="checkbox"/> <input type="checkbox"/>	<input type="checkbox"/> <input type="checkbox"/> <input type="checkbox"/> <input type="checkbox"/> <input type="checkbox"/> <input type="checkbox"/>	<input type="checkbox"/> <input type="checkbox"/> <input type="checkbox"/> <input type="checkbox"/>

A B C D E F G

HOW TO ORDER

Indicate the following information on order form:

- Quantity of each item.
- Model number, including options. See "How To Build a Model Number".
- Any special service required.

Note: • The indicates that a choice is required.
 • The absence of the indicates that no choice is required.
 • Alpha-numeric characters in place of indicate that no other alternatives are available.

HOW TO BUILD A MODEL NUMBER

- A** Select basic model.
 U - Unassembled
 F - Fully assembled; add \$129
- B** Select assembly option.
- C** Select overhead type.
 OCL - Corner overhead left
 OCR - Corner overhead right
 OS - Overhead standard
- D** Select paint color.
 Refer to color addendum at ki.com or KI Fabrics & Finishes binder.
- E** Select insert color.
 Refer to color addendum at ki.com or KI Fabrics & Finishes binder.
- F** Select fabric.
 Refer to color addendum at ki.com or in KI Fabrics & Finishes binder.

- G** Select key option.
 KA - Key alike
 KS - Key standard
 NLC - No lock core



Approx. Packaged Weight	Delivered Pricing Fabric Grade 1 & C.O.M.	Delivered Pricing Fabric Grade 2	Delivered Pricing Fabric Grade 3 & Pallas Vertical Fabric Grade PV	Delivered Pricing Pallas Vertical Fabric Grade PV1	Delivered Pricing Pallas Vertical Fabric Grade PV2
73.0#	\$ 889	\$ 897	\$ 919	\$ 934	\$ 953
81.0#	918	925	942	961	981
89.0#	935	946	964	983	1003
99.0#	961	971	989	1010	1028
107.0#	1074	1088	1106	1129	1152
116.0#	1124	1133	1157	1179	1201
136.0#	1632	1647	1682	1713	1746
157.0#	1657	1675	1709	1740	1775

SPECIAL SERVICES

Special Carton Marking

With specially marked information N/C

Shipping

Shipped k.d. freight prepaid f.o.b. Manitowoc, Wisconsin 54220 factory. Freight class #70.

Specifications and prices are subject to change without prior notice.

WorkZone® Components

Universal Overhead Storage

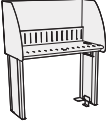
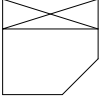
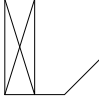
MODEL	W x H x D	MODEL NUMBER				Approx. Packaged Weight
		Basic Model	Overhead Type	Paint Color	Insert Color	
 <p>WUSS</p> <p>Universal Shelf</p> <ul style="list-style-type: none"> The KI Universal Shelf allows users the option to interchange from a WorkZone® desk mount solution to a KI office panel system Powder-coated steel end panels and bottom shelf Accepts shelf dividers End bracket design prevents accidental dislodging of components Shelf depth is 13-1/4" Concealed vertical wire management Secured to steel legs by concealed mounting brackets Field installable to compatible WorkZone surfaces 66" overhead has one 30" door and one 36" door with a support offset 6" from the center of the worksurface 72" shelf consists of two 36" shelves supported by middle upright Cannot be mounted on tables with casters 66" and 72" wide overhead are not available on WorkZone® frames with beams 	30 x 16-1/2 x 13-1/4"	WUSS30	<input type="checkbox"/> <input type="checkbox"/> <input type="checkbox"/>	<input type="checkbox"/> <input type="checkbox"/>	<input type="checkbox"/> <input type="checkbox"/>	63.0#
	36 x 16-1/2 x 13-1/4"	WUSS36	<input type="checkbox"/> <input type="checkbox"/> <input type="checkbox"/>	<input type="checkbox"/> <input type="checkbox"/>	<input type="checkbox"/> <input type="checkbox"/>	69.0#
	42 x 16-1/2 x 13-1/4"	WUSS42	<input type="checkbox"/> <input type="checkbox"/> <input type="checkbox"/>	<input type="checkbox"/> <input type="checkbox"/>	<input type="checkbox"/> <input type="checkbox"/>	76.0#
	48 x 16-1/2 x 13-1/4"	WUSS48	<input type="checkbox"/> <input type="checkbox"/> <input type="checkbox"/>	<input type="checkbox"/> <input type="checkbox"/>	<input type="checkbox"/> <input type="checkbox"/>	85.0#
	54 x 16-1/2 x 13-1/4"	WUSS54	<input type="checkbox"/> <input type="checkbox"/> <input type="checkbox"/>	<input type="checkbox"/> <input type="checkbox"/>	<input type="checkbox"/> <input type="checkbox"/>	90.0#
	60 x 16-1/2 x 13-1/4"	WUSS60	<input type="checkbox"/> <input type="checkbox"/> <input type="checkbox"/>	<input type="checkbox"/> <input type="checkbox"/>	<input type="checkbox"/> <input type="checkbox"/>	99.0#
	66 x 16-1/2 x 13-1/4"	WUSS66	<input type="checkbox"/> <input type="checkbox"/> <input type="checkbox"/>	<input type="checkbox"/> <input type="checkbox"/>	<input type="checkbox"/> <input type="checkbox"/>	116.0#
	72 x 16-1/2 x 13-1/4"	WUSS72	<input type="checkbox"/> <input type="checkbox"/> <input type="checkbox"/>	<input type="checkbox"/> <input type="checkbox"/>	<input type="checkbox"/> <input type="checkbox"/>	133.0#
<p>OCR-OCL</p> <ul style="list-style-type: none"> OCR = Overhead right OCL = Overhead left 						
 <p>OCR</p>  <p>OCL</p>						
			A	B	C	D

HOW TO ORDER

Indicate the following information on order form:

- Quantity of each item.
- Model number, including options. See "How To Build a Model Number".
- Any special service required.

- Note:
- The indicates that a choice is required.
 - The absence of the indicates that no choice is required.
 - Alpha-numeric characters in place of indicate that no other alternatives are available.

HOW TO BUILD A MODEL NUMBER

- A** Select basic model.
- B** Select overhead type.

OS	- Overhead standard
OCL	- Corner overhead left
OCR	- Corner overhead right
OS	- Overhead standard
- C** Select paint color. Refer to color addendum at ki.com or KI Fabrics & Finishes binder.
- D** Select insert color. Refer to color addendum at ki.com or KI Fabrics & Finishes binder.



Delivered
Pricing

\$ 584
595
607
617
646
663
998
1010

SPECIAL SERVICES

Special Carton Marking

With specially marked information N/C

Shipping

Shipped k.d. freight prepaid f.o.b. Manitowoc, Wisconsin 54220 factory. Freight class #70.

Specifications and prices are subject to change without prior notice.

WorkZone® Components

Universal Overhead Storage

	MODEL	W x H	MODEL NUMBER		Approx. Packaged Weight
			Basic Model	Paint Color	
 <p>HRDPT</p>	Universal Shelf <ul style="list-style-type: none"> Steel shelf dividers with powder-coated finish Fits shelves and cabinet: WUSS, WZUS, WZUF and WZUL 	7-1/4 x 11-1/2"	NSD	<input type="checkbox"/>	1.0#

A

B

HOW TO ORDER

Indicate the following information on order form:

- Quantity of each item.
- Model number, including options. See "How To Build a Model Number".
- Any special service required.

Note: • The indicates that a choice is required.

- The absence of the indicates that no choice is required.
- Alpha-numeric characters in place of indicate that no other alternatives are available.

HOW TO BUILD A MODEL NUMBER

- A** Select basic model.
- B** Select paint color.
Refer to color addendum at ki.com or KI Fabrics & Finishes binder.



Delivered
Pricing

\$ 26

SPECIAL SERVICES

Special Carton Marking

With specially marked information N/C

Shipping

Shipped k.d. freight prepaid f.o.b. Manitowoc, Wisconsin 54220 factory. Freight class #70.

Specifications and prices are subject to change without prior notice.

WorkZone® Components

Universal Tasklights

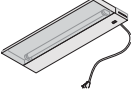
	MODEL	W	MODEL NUMBER	Approx. Packaged Weight
			Basic Model	
 HRDPT	Universal Overhead Task Light • Electronic ballast	24"	TLT5.24	3.9#
		36"	TLT5.36	5.3#
		48"	TLT5.48	6.7#

A

HOW TO ORDER

Indicate the following information on order form:

1. Quantity of each item.
2. Model number, including options. See "How To Build a Model Number".
3. Any special service required.

Note: • The indicates that a choice is required.

- The absence of the indicates that no choice is required.
- Alpha-numeric characters in place of indicate that no other alternatives are available.

HOW TO BUILD A MODEL NUMBER

- A** Select basic model.

INFORMATION

TASK LIGHT CABINET WIDTH

Cabinet Width	Light Width
24"	18"
30"	24"
36"	24"
42"	36"
48"	36"
54"	48"
60"	48"
66"	(2)24"
72"	(2)24"



Delivered
Pricing

\$ 76
83
91

SPECIAL SERVICES

Special Carton Marking

With specially marked information N/C



Shipping

Shipped k.d. freight prepaid f.o.b. Manitowoc, Wisconsin 54220 factory. Freight class #100.

Specifications and prices are subject to change without prior notice.

WorkZone® Components

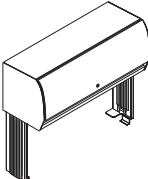
Balance® Overhead Storage

	MODEL	W	MODEL NUMBER						Approx. Packaged Weight
			Basic Model	Overhead Type	Cabinet Paint Color	Insert Color	Upper Door Solid Color	Key Option	
 <p>WZBO</p> <p>Balance® Overhead Cabinet with Solid Color Upper Door</p> <ul style="list-style-type: none"> Stanchions and mounting brackets included The KI Balance® Overhead allows users the option to interchange from a WorkZone® desk mount solution to a KI office panel system Colored or translucent extruded polypropylene door Painted cabinet and lower door Shelf dividers available separately Cabinet is fully assembled Door stores above top of cabinet 		30"	BLCS30/WZ	<input type="checkbox"/> <input type="checkbox"/> <input type="checkbox"/> <input type="checkbox"/>	<input type="checkbox"/> <input type="checkbox"/>	<input type="checkbox"/> <input type="checkbox"/>	<input type="checkbox"/> <input type="checkbox"/> <input type="checkbox"/> <input type="checkbox"/>	<input type="checkbox"/> <input type="checkbox"/>	52.0#
		36"	BLCS36/WZ	<input type="checkbox"/> <input type="checkbox"/> <input type="checkbox"/> <input type="checkbox"/>	<input type="checkbox"/> <input type="checkbox"/>	<input type="checkbox"/> <input type="checkbox"/>	<input type="checkbox"/> <input type="checkbox"/> <input type="checkbox"/> <input type="checkbox"/>	<input type="checkbox"/> <input type="checkbox"/>	52.0#
		42"	BLCS42/WZ	<input type="checkbox"/> <input type="checkbox"/> <input type="checkbox"/> <input type="checkbox"/>	<input type="checkbox"/> <input type="checkbox"/>	<input type="checkbox"/> <input type="checkbox"/>	<input type="checkbox"/> <input type="checkbox"/> <input type="checkbox"/> <input type="checkbox"/>	<input type="checkbox"/> <input type="checkbox"/>	58.0#
		48"	BLCS48/WZ	<input type="checkbox"/> <input type="checkbox"/> <input type="checkbox"/> <input type="checkbox"/>	<input type="checkbox"/> <input type="checkbox"/>	<input type="checkbox"/> <input type="checkbox"/>	<input type="checkbox"/> <input type="checkbox"/> <input type="checkbox"/> <input type="checkbox"/>	<input type="checkbox"/> <input type="checkbox"/>	64.0#
		54"	BLCS54/WZ	<input type="checkbox"/> <input type="checkbox"/> <input type="checkbox"/> <input type="checkbox"/>	<input type="checkbox"/> <input type="checkbox"/>	<input type="checkbox"/> <input type="checkbox"/>	<input type="checkbox"/> <input type="checkbox"/> <input type="checkbox"/> <input type="checkbox"/>	<input type="checkbox"/> <input type="checkbox"/>	70.0#
		60"	BLCS60/WZ	<input type="checkbox"/> <input type="checkbox"/> <input type="checkbox"/> <input type="checkbox"/>	<input type="checkbox"/> <input type="checkbox"/>	<input type="checkbox"/> <input type="checkbox"/>	<input type="checkbox"/> <input type="checkbox"/> <input type="checkbox"/> <input type="checkbox"/>	<input type="checkbox"/> <input type="checkbox"/>	78.0#
		66"	BLCS66D/WZ	<input type="checkbox"/> <input type="checkbox"/> <input type="checkbox"/> <input type="checkbox"/>	<input type="checkbox"/> <input type="checkbox"/>	<input type="checkbox"/> <input type="checkbox"/>	<input type="checkbox"/> <input type="checkbox"/> <input type="checkbox"/> <input type="checkbox"/>	<input type="checkbox"/> <input type="checkbox"/>	91.0#
		72"	BLCS72D/WZ	<input type="checkbox"/> <input type="checkbox"/> <input type="checkbox"/> <input type="checkbox"/>	<input type="checkbox"/> <input type="checkbox"/>	<input type="checkbox"/> <input type="checkbox"/>	<input type="checkbox"/> <input type="checkbox"/> <input type="checkbox"/> <input type="checkbox"/>	<input type="checkbox"/> <input type="checkbox"/>	104.0#
	OCR-OCL								
	<ul style="list-style-type: none"> OCR = Overhead right OCL = Overhead left 								
	  <p>OCR OCL</p>								
				A	B	C	D	E	F

HOW TO ORDER

Indicate the following information on order form:

- Quantity of each item.
- Model number, including options. See "How To Build a Model Number".
- Any special service required.

Note:

- The indicates that a choice is required.
- The absence of the indicates that no choice is required.
- Alpha-numeric characters in place of indicate that no other alternatives are available.

HOW TO BUILD A MODEL NUMBER

- A** Select basic model.
- B** Select overhead type.

OCL	- Corner overhead left
OCR	- Corner overhead right
OS	- Overhead standard
- C** Select cabinet paint color. Refer to color addendum at ki.com or KI Fabrics & Finishes binder.
- D** Select insert color. Refer to color addendum at ki.com or KI Fabrics & Finishes binder.
- E** Select upper door color. Refer to color addendum at ki.com or KI Fabrics & Finishes binder.
- F** Select key option. Grommets are required for overhead cabinet

KA	- Key alike
-----------	-------------

- | | |
|------------|----------------|
| KS | - Key standard |
| NLC | - No lock core |



Delivered Pricing

\$ 1234
1261
1289
1351
1435
1454
2311
2342

SPECIAL SERVICES

Special Carton Marking

With specially marked information N/C

Shipping

Shipped **assembled freight prepaid**
f.o.b. Manitowoc, Wisconsin 54220 factory.
Freight class #77.5

Specifications and prices are subject to
change without prior notice.



Delivered Pricing

\$ 1463
1516
1572
1646
1781
1809
2824
2879

SPECIAL SERVICES

Special Carton Marking

With specially marked information N/C



Shipping

Shipped **assembled freight prepaid**
f.o.b. Manitowoc, Wisconsin 54220 factory.
Freight class #77.5

Specifications and prices are subject to
change without prior notice.

WorkZone® Components

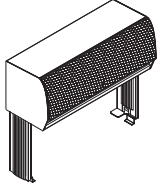
Balance® Overhead Storage

MODEL	W	MODEL NUMBER						Approx. Packaged Weight
		Basic Model	Overhead Type	Cabinet Paint Color	Insert Color	Fabric Color	Key Option	
 <p>WZBO</p> <p>Balance® Overhead Cabinet with Fabric Upper Door</p> <ul style="list-style-type: none"> Stanchions and mounting brackets included The KI Balance® Overhead allows users the option to interchange from a WorkZone® desk mount solution to a KI office panel system Fabric covered upper door Painted cabinet and lower door Shelf dividers available separately Cabinet is fully assembled Door stores above top of cabinet 66" and 72" wide overhead are not available on WorkZone® frames with beams 	30"	BLCF30/WZ	<input type="checkbox"/> <input type="checkbox"/> <input type="checkbox"/>	<input type="checkbox"/> <input type="checkbox"/>	<input type="checkbox"/> <input type="checkbox"/>	<input type="checkbox"/> <input type="checkbox"/> <input type="checkbox"/> <input type="checkbox"/>	<input type="checkbox"/> <input type="checkbox"/>	46.0#
	36"	BLCF36/WZ	<input type="checkbox"/> <input type="checkbox"/> <input type="checkbox"/>	<input type="checkbox"/> <input type="checkbox"/>	<input type="checkbox"/> <input type="checkbox"/>	<input type="checkbox"/> <input type="checkbox"/> <input type="checkbox"/> <input type="checkbox"/>	<input type="checkbox"/> <input type="checkbox"/>	52.0#
	42"	BLCF42/WZ	<input type="checkbox"/> <input type="checkbox"/> <input type="checkbox"/>	<input type="checkbox"/> <input type="checkbox"/>	<input type="checkbox"/> <input type="checkbox"/>	<input type="checkbox"/> <input type="checkbox"/> <input type="checkbox"/> <input type="checkbox"/>	<input type="checkbox"/> <input type="checkbox"/>	58.0#
	48"	BLCF48/WZ	<input type="checkbox"/> <input type="checkbox"/> <input type="checkbox"/>	<input type="checkbox"/> <input type="checkbox"/>	<input type="checkbox"/> <input type="checkbox"/>	<input type="checkbox"/> <input type="checkbox"/> <input type="checkbox"/> <input type="checkbox"/>	<input type="checkbox"/> <input type="checkbox"/>	64.0#
	54"	BLCF54/WZ	<input type="checkbox"/> <input type="checkbox"/> <input type="checkbox"/>	<input type="checkbox"/> <input type="checkbox"/>	<input type="checkbox"/> <input type="checkbox"/>	<input type="checkbox"/> <input type="checkbox"/> <input type="checkbox"/> <input type="checkbox"/>	<input type="checkbox"/> <input type="checkbox"/>	70.0#
	60"	BLCF60/WZ	<input type="checkbox"/> <input type="checkbox"/> <input type="checkbox"/>	<input type="checkbox"/> <input type="checkbox"/>	<input type="checkbox"/> <input type="checkbox"/>	<input type="checkbox"/> <input type="checkbox"/> <input type="checkbox"/> <input type="checkbox"/>	<input type="checkbox"/> <input type="checkbox"/>	78.0#
	66"	BLCF66D/WZ	<input type="checkbox"/> <input type="checkbox"/> <input type="checkbox"/>	<input type="checkbox"/> <input type="checkbox"/>	<input type="checkbox"/> <input type="checkbox"/>	<input type="checkbox"/> <input type="checkbox"/> <input type="checkbox"/> <input type="checkbox"/>	<input type="checkbox"/> <input type="checkbox"/>	91.0#
	72"	BLCF72D/WZ	<input type="checkbox"/> <input type="checkbox"/> <input type="checkbox"/>	<input type="checkbox"/> <input type="checkbox"/>	<input type="checkbox"/> <input type="checkbox"/>	<input type="checkbox"/> <input type="checkbox"/> <input type="checkbox"/> <input type="checkbox"/>	<input type="checkbox"/> <input type="checkbox"/>	104.0#
<p>OCR-OCL</p> <ul style="list-style-type: none"> OCR = Overhead right OCL = Overhead left 								
 <p>OCR</p>	 <p>OCL</p>							
		A	B	C	D	E	F	

HOW TO ORDER

Indicate the following information on order form:

- Quantity of each item.
- Model number, including options. See "How To Build a Model Number".
- Any special service required.

Note:

- The indicates that a choice is required.
- The absence of the indicates that no choice is required.
- Alpha-numeric characters in place of indicate that no other alternatives are available.

HOW TO BUILD A MODEL NUMBER

- A** Select basic model.
- B** Select overhead type.
 - OCL** - Corner overhead left
 - OCR** - Corner overhead right
 - OS** - Overhead standard
- C** Select cabinet paint color. Refer to color addendum at ki.com or KI Fabrics & Finishes binder.
- D** Select insert color. Refer to color addendum at ki.com or KI Fabrics & Finishes binder.
- E** Select upper door fabric color. Refer to color addendum at ki.com or in KI Fabrics & Finishes binder.
- F** Select key option. Grommets are required for overhead cabinet
 - KA** - Key alike

- KS** - Key standard
- NLC** - No lock core



Delivered Pricing Fabric Grade 1 & C.O.M.	Delivered Pricing Fabric Grade 2	Delivered Pricing Fabric Grade 3 & Pallas Vertical Fabric Grade PV	Delivered Pricing Pallas Vertical Fabric Grade PV1	Delivered Pricing Pallas Vertical Fabric Grade PV2
\$ 1324	\$ 1334	\$ 1350	\$ 1372	\$ 1391
1350	1359	1381	1402	1420
1380	1388	1411	1430	1452
1443	1454	1474	1498	1519
1543	1553	1579	1600	1626
1560	1570	1594	1621	1645
2488	2511	2546	2589	2629
2518	2539	2577	2619	2656

SPECIAL SERVICES

Special Carton Marking

With specially marked information N/C

Shipping

Shipped **assembled freight prepaid f.o.b. Manitowoc, Wisconsin 54220** factory. Freight class #77.5

Specifications and prices are subject to change without prior notice.

WorkZone® Components

Balance® Task Lights

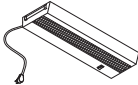
MODEL	W	MODEL NUMBER		Approx. Packaged Weight
			Basic Model	
 <p>Balance® Overhead Task Light • Electronic ballast</p>	24"		BTLT5.24	3.9#
	36"		BTLT5.36	5.3#
	48"		BTLT5.48	6.7#

HRDPT

A

HOW TO ORDER

Indicate the following information on order form:

1. Quantity of each item.
2. Model number, including options. See "How To Build a Model Number".
3. Any special service required.

Note: • The indicates that a choice is required.

- The absence of the indicates that no choice is required.
- Alpha-numeric characters in place of indicate that no other alternatives are available.

HOW TO BUILD A MODEL NUMBER

- A** Select basic model.

INFORMATION

TASK LIGHT CABINET WIDTH

Cabinet Width	Light Width
24"	18"
30"	24"
36"	24"
42"	36"
48"	36"
54"	48"
60"	48"
66"	(2)24"
72"	(2)24"



Delivered
Pricing

\$	102
	112
	117

SPECIAL SERVICES

Special Carton Marking

With specially marked information N/C

Shipping

Shipped k.d. freight prepaid f.o.b. Manitowoc, Wisconsin 54220 factory. Freight class #100.

Specifications and prices are subject to change without prior notice.

WorkZone® Components

Privacy Screens

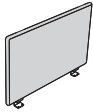
	MODEL	Features	W x H	MODEL NUMBER			Approx. Packaged Weight
				Basic Model	Trim Color	Fabric Color	
 WZPR	Basic Privacy Screen	Basic	24 x 19"	WZP24	<input type="checkbox"/>	<input type="checkbox"/> <input type="checkbox"/> <input type="checkbox"/> <input type="checkbox"/>	13.0#
	<ul style="list-style-type: none"> 1" thick screen upholstered with tackable fabric 	Basic	30 x 19"	WZP30	<input type="checkbox"/>	<input type="checkbox"/> <input type="checkbox"/> <input type="checkbox"/> <input type="checkbox"/>	15.0#
	<ul style="list-style-type: none"> Painted steel mounting brackets 	Basic	36 x 19"	WZP36	<input type="checkbox"/>	<input type="checkbox"/> <input type="checkbox"/> <input type="checkbox"/> <input type="checkbox"/>	17.0#
	<ul style="list-style-type: none"> Screens available for all worksurfaces and transitional surfaces 	Basic	42 x 19"	WZP42	<input type="checkbox"/>	<input type="checkbox"/> <input type="checkbox"/> <input type="checkbox"/> <input type="checkbox"/>	19.0#
	<ul style="list-style-type: none"> Field installable 	Basic	48 x 19"	WZP48	<input type="checkbox"/>	<input type="checkbox"/> <input type="checkbox"/> <input type="checkbox"/> <input type="checkbox"/>	21.0#
	<ul style="list-style-type: none"> Provides seated privacy 	Basic	54 x 19"	WZP54	<input type="checkbox"/>	<input type="checkbox"/> <input type="checkbox"/> <input type="checkbox"/> <input type="checkbox"/>	24.0#
	<ul style="list-style-type: none"> WZP60 has two 30" privacy screens with connector 	Basic	60 x 19"	WZP60	<input type="checkbox"/>	<input type="checkbox"/> <input type="checkbox"/> <input type="checkbox"/> <input type="checkbox"/>	30.0#
	<ul style="list-style-type: none"> WZP66 has a 30" and 36" privacy screens with connector 	Basic	66 x 19"	WZP66	<input type="checkbox"/>	<input type="checkbox"/> <input type="checkbox"/> <input type="checkbox"/> <input type="checkbox"/>	32.0#
	<ul style="list-style-type: none"> WZP72 has two 36" privacy screens with connector 	Basic	72 x 19"	WZP72	<input type="checkbox"/>	<input type="checkbox"/> <input type="checkbox"/> <input type="checkbox"/> <input type="checkbox"/>	34.0#
	<ul style="list-style-type: none"> Provides 3/4" space between screen and worksurface for cables 						
WZPR	Corner Privacy Screen	Corner (2 screens)	36 x 19"	WZPC2436	<input type="checkbox"/>	<input type="checkbox"/> <input type="checkbox"/> <input type="checkbox"/> <input type="checkbox"/>	45.0#
	<ul style="list-style-type: none"> Features the same as Basic Privacy Screen 	Corner (2 screens)	42 x 19"	WZPC2442	<input type="checkbox"/>	<input type="checkbox"/> <input type="checkbox"/> <input type="checkbox"/> <input type="checkbox"/>	34.0#
	<ul style="list-style-type: none"> Square and rectangle screens come as a set with splice plates 	Corner (2 screens)	48 x 19"	WZPC3048	<input type="checkbox"/>	<input type="checkbox"/> <input type="checkbox"/> <input type="checkbox"/> <input type="checkbox"/>	40.0#
	<ul style="list-style-type: none"> To be used with transitional and stand alone corner worksurfaces 						

A

B

C

HOW TO ORDER

Indicate the following information on order form:

- Quantity of each item.
- Model number, including options. See "How To Build a Model Number".
- Any special service required.

Note: • The indicates that a choice is required.

- The absence of the indicates that no choice is required.
- Alpha-numeric characters in place of indicate that no other alternatives are available.

HOW TO BUILD A MODEL NUMBER

- A** Select basic model.
- B** Select trim color.
Refer to color addendum at ki.com or KI Fabrics & Finishes binder.
- C** Select fabric.
Refer to color addendum at ki.com or in KI Fabrics & Finishes binder.



Delivered Pricing Fabric Grade 1 & C.O.M.	Delivered Pricing Fabric Grade 2	Delivered Pricing Fabric Grade 3 & Pallas Vertical Fabric Grade PV	Delivered Pricing Pallas Vertical Fabric Grade PV1	Delivered Pricing Pallas Vertical Fabric Grade PV2
\$ 376	\$ 386	\$ 394	\$ 412	\$ 432
386	396	406	425	443
400	410	422	438	460
423	433	445	465	486
448	458	471	491	516
458	471	483	506	528
697	717	729	766	801
705	727	741	774	813
713	739	751	786	823
\$ 935	\$ 965	\$ 985	\$ 1031	\$ 1077
969	999	1018	1067	1117
986	1016	1036	1084	1134

SPECIAL SERVICES

Special Carton Marking

With specially marked information N/C

Shipping

Shipped k.d. freight prepaid f.o.b. Manitowoc, Wisconsin 54220 factory. Freight class #70.

Specifications and prices are subject to change without prior notice.

WorkZone® Accessories

General information



Tool Rail (PMTR)

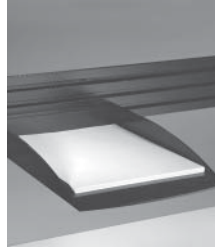

Paper Tray (PLL)



Vertical Storage (PVS)



Pencil Cup (PPC)

Features

Painted aluminum	•			
Plastic construction		•	•	•
Suspends from tool rail		•	•	•
Field installable	•	•	•	•

SPECIFICATIONS

Tool Rail

Aluminum extrusion tool rail, powder-coated finish. Attaches between overhead uprights. Consists of four slots to accept paper management components. To be used on WZUS, WZUF, WZUL, WUSS, BLCS, BLCL and BLCF models.

Paper Tray

Constructed of injection molded plastic. Tray measures 9-1/2" wide by 2" high by 14" deep and accommodates both letter and legal size documents. Includes three hooks to mount on tool rail.

Vertical Storage

Constructed of injection molded plastic. Holder measures 5" wide by 9" high and 10-1/2" deep. Includes two hooks to mount on tool rail.

Pencil Cup

Constructed of injection molded plastic. Cup

measures 4" wide by 3" high by 3-1/2" deep for storage of pens, pencils and highlighters. Includes one hook to mount on tool rail.

Diagonal Storage

Constructed of injection molded plastic. Storage tray consists of three diagonal slats with black dividers to sort files or papers. Tray measures 7" wide by 2-1/2" high by 12-1/2" deep and includes three hooks to mount on tool rail.

Telephone Caddy

Constructed of injection molded plastic. Caddy measures 8-1/2" wide by 2" high by 9-1/2" deep. Includes adjustable rail to accommodate a phone up to 10-3/4" deep. Includes three hooks to mount on tool rail.

Accessory Tray

Constructed of injection molded plastic. Holder measures 9-1/2" wide by 2" high by 10" deep and includes three hooks to mount to tool rail. Tray includes six compartments for storage of supplies.

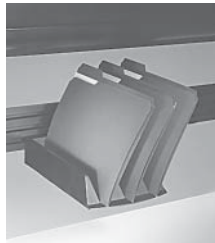

Diagonal Storage (PDS)

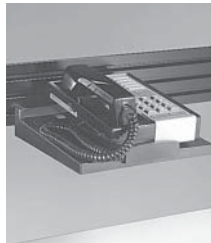

Telephone Caddy (PTC)

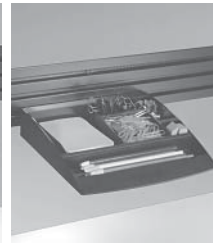

Accessory Tray (PAT)

Features

Plastic construction	•	•	•
Suspends from tool rail	•	•	•
Field installable	•		

INFORMATION

Warranty

Refer to KI Terms & Conditions document or visit ki.com

WorkZone® Accessories

General information



Center Drawer (3CMN)

Features

Plastic/metal construction

•

Powder-coated finish

•

Field installable

•

SPECIFICATIONS

Letter Tray

20-ga. epoxy powder-coated steel, and plastic molded in color, then painted to assure color match. Steel and plastic joined permanently by sonic welding. Roll formed steel clip for component attachment to tool rail. ID clips included with tray.

Binder Bin

20-ga. epoxy powder-coated steel, and plastic molded in color, then painted to assure color match. Steel and plastic joined permanently by sonic welding. Roll formed steel clip for component attachment to tool rail. ID clips included with tray.

Slanted Storage

24-ga. epoxy powder-coated-steel, and plastic molded in color, then painted to assure color match. Steel and plastic joined permanently by sonic welding. Roll formed steel clip for component attachment to tool rail.

Key Options

There are various key options available depending on the component model. The key alike option (KA) allows multiple components of a workstation to be keyed alike. The lock number can be specified. The key standard option (KS) allows each component to have its own randomly selected key number shipped with the individual component. The no lock core option (NLC) provides more flexibility in keying workstations alike. All locks and keys for the individual components specified with no lock core will be packaged separately from the components. The location of the lock core and corresponding numbered key will be determined upon installation. Keys are P-Series.



INFORMATION

Warranty
Refer to KI Terms & Conditions document
or visit ki.com

WorkZone® Accessories

Tool Rail

	MODEL	H x W	MODEL NUMBER		Approx. Packaged Weight
			Basic Model	Trim Color	
 HRDPT	Tool Rail	4-1/2 x 30"	PMTR30	<input type="checkbox"/>	4.0#
	• Accommodates paper management components	4-1/2 x 36"	PMTR36	<input type="checkbox"/>	5.0#
	• Attaches between overhead uprights. To be used on WZUS, WZUL, WZUF, WUSS, BLCS, BLCL, and BLCF models	4-1/2 x 42"	PMTR42	<input type="checkbox"/>	6.0#
	• Field installable	4-1/2 x 48"	PMTR48	<input type="checkbox"/>	6.0#
	• Painted aluminum construction	4-1/2 x 54"	PMTR54	<input type="checkbox"/>	7.0#
	• 66" rail consists of one 30" and one 36" rails with middle support	4-1/2 x 60"	PMTR60	<input type="checkbox"/>	7.0#
	• 72" rail consists of two 36" rails with middle support	4-1/2 x 66"	PMTR66	<input type="checkbox"/>	7.0#
	• Consists of four slots to accept components	4-1/2 x 72"	PMTR72	<input type="checkbox"/>	8.0#

A

B

HOW TO ORDER

Indicate the following information on order form:

- Quantity of each item.
- Model number, including options. See "How To Build a Model Number".
- Any special service required.

Note: • The indicates that a choice is required.

- The absence of the indicates that no choice is required.
- Alpha-numeric characters in place of indicate that no other alternatives are available.

HOW TO BUILD A MODEL NUMBER

- A** Select basic model.
- B** Select trim color.
Refer to color addendum at ki.com or KI Fabrics & Finishes binder.



Delivered
Pricing

\$ 121
126
133
141
162
178
184
197

SPECIAL SERVICES

Special Carton Marking

With specially marked information N/C

Shipping

Shipped k.d. freight prepaid f.o.b. Manitowoc, Wisconsin 54220 factory. Freight class #70.

Specifications and prices are subject to change without prior notice.

WorkZone® Accessories

Paper Management

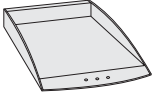
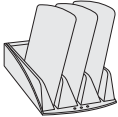
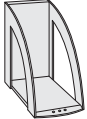
	MODEL	H x W x D	MODEL NUMBER		Approx. Packaged Weight
			Basic Model	Trim Color	
 HRDPT	Paper Tray <ul style="list-style-type: none"> • Plastic construction • Stores letter or legal size documents • Suspends from tool rail • Suitable for free-standing worksurface or overhead location 	2 x 9-1/2 x 14"	PLL	<input type="checkbox"/> <input type="checkbox"/>	1.0#
 HRDPT	Diagonal Storage <ul style="list-style-type: none"> • Plastic construction • Suspends only from tool rail • Suitable for free-standing worksurface or overhead location • Three slanted partitions per unit • Dividers in black only 	2-1/2 x 7 x 12-1/2"	PDS	<input type="checkbox"/> <input type="checkbox"/>	4.0#
 HRDPT	Vertical Storage <ul style="list-style-type: none"> • Injection molded plastic construction • Suspends only from tool rail • Suitable for free-standing worksurface or overhead location • Stores binders, phone books or periodicals 	9 x 5 x 10-1/2"	PVS	<input type="checkbox"/> <input type="checkbox"/>	1.0#
			A	B	

HOW TO ORDER

Indicate the following information on order form:

1. Quantity of each item.
2. Model number, including options. See "How To Build a Model Number".
3. Any special service required.

Note: • The indicates that a choice is required.

- The absence of the indicates that no choice is required.
- Alpha-numeric characters in place of indicate that no other alternatives are available.

HOW TO BUILD A MODEL NUMBER

- A** Select basic model.
- B** Select trim color.
Refer to color addendum at ki.com or KI Fabrics & Finishes binder.



Delivered

Pricing

\$ 38

\$ 38

\$ 36

SPECIAL SERVICES

Special Carton Marking

With specially marked information N/C



Shipping

Shipped k.d. freight prepaid f.o.b. Manitowoc, Wisconsin 54220 factory. Freight class #70.

Specifications and prices are subject to change without prior notice.

WorkZone® Accessories

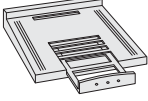
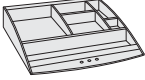
Paper Management

	MODEL	H x W x D	MODEL NUMBER		Approx. Packaged Weight	
			Basic Model	Trim Color		
 HRDPT	Telephone Caddy • Plastic construction • Holds telephone up to 8-1/2" wide and 9-1/2" deep • Suspends from tool rail	2 x 8-1/2 x 9-1/2"	PTC	<input type="checkbox"/>	1.0#	
 HRDPT	Accessory Tray • Injection molded plastic • Stores stamps, tape dispenser, post-it pads and paper clips • Suspends from tool rail	2 x 9-1/2 x 10"	PAT	<input type="checkbox"/>	6.0#	
 HRDPT	Pencil Cup • Injection molded plastic • Suspends from tool rail	4 x 4 x 3-1/2"	PPC	<input type="checkbox"/>	1.0#	

A

B

HOW TO ORDER

Indicate the following information on order form:

1. Quantity of each item.
2. Model number, including options. See "How To Build a Model Number".
3. Any special service required.

Note: • The indicates that a choice is required.

- The absence of the indicates that no choice is required.
- Alpha-numeric characters in place of indicate that no other alternatives are available.

HOW TO BUILD A MODEL NUMBER

- A** Select basic model.
- B** Select trim color.
Refer to color addendum at ki.com or KI Fabrics & Finishes binder.



Delivered

Pricing

\$ 46

\$ 32

\$ 32

SPECIAL SERVICES

Special Carton Marking

With specially marked information N/C

Shipping

Shipped k.d. freight prepaid f.o.b. Manitowoc, Wisconsin 54220 factory. Freight class #70.

Specifications and prices are subject to change without prior notice.

WorkZone® Accessories

Center Drawer

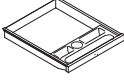
	MODEL	W x D x H	MODEL NUMBER			Approx. Packaged Weight
			Basic Model	Trim Color	Key Option	
 3CMN	Center Drawer • Molded plastic construction with compartment trays • Available with key alike	18 x 18 x 2-3/4"	3CMN	<input type="checkbox"/>	<input type="checkbox"/>	11.0#

A **B** **C**

HOW TO ORDER

Indicate the following information on order form:

- Quantity of each item.
- Model number, including options. See "How To Build a Model Number".
- Any special service required.

Note: • The indicates that a choice is required.

- The absence of the indicates that no choice is required.
- Alpha-numeric characters in place of indicate that no other alternatives are available.

HOW TO BUILD A MODEL NUMBER

- A** Select basic model.
- B** Select trim color.
Refer to color addendum at ki.com or KI Fabrics & Finishes binder.
- C** Select key option.

KA	- Key alike
KS	- Key standard
NLC	- No lock core



Delivered
Pricing

\$ 152

SPECIAL SERVICES

Special Carton Marking

With specially marked information N/C

Shipping

Shipped k.d. freight prepaid f.o.b. Manitowoc, Wisconsin 54220 factory. Freight class #70.

Specifications and prices are subject to change without prior notice.

WorkZone® with Power

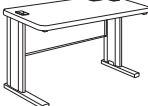
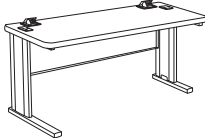
	D x W	MODEL NUMBER														
		Basic Model	Edge Style	P-Up Mod	Ht	W-Trgh	Elct Opt	Frame Style	Trans. Legs	Grom	Paint Clr	Insrt Clr	Lam Clr	Edge Clr	Grm Clr	
 WBWP WorkZone® w/Power Worksurface	24 x 30"	WBWD2430	<input type="checkbox"/>	<input type="checkbox"/>	<input type="checkbox"/>	<input type="checkbox"/>	<input type="checkbox"/>	<input type="checkbox"/>	<input type="checkbox"/>	<input type="checkbox"/>						
	24 x 36"	WBWD2436	<input type="checkbox"/>	<input type="checkbox"/>	<input type="checkbox"/>	<input type="checkbox"/>	<input type="checkbox"/>	<input type="checkbox"/>	<input type="checkbox"/>	<input type="checkbox"/>						
	24 x 42"	WBWD2442	<input type="checkbox"/>	<input type="checkbox"/>	<input type="checkbox"/>	<input type="checkbox"/>	<input type="checkbox"/>	<input type="checkbox"/>	<input type="checkbox"/>	<input type="checkbox"/>						
	24 x 48"	WBWD2448	<input type="checkbox"/>	<input type="checkbox"/>	<input type="checkbox"/>	<input type="checkbox"/>	<input type="checkbox"/>	<input type="checkbox"/>	<input type="checkbox"/>	<input type="checkbox"/>						
	24 x 54"	WBWD2454	<input type="checkbox"/>	<input type="checkbox"/>	<input type="checkbox"/>	<input type="checkbox"/>	<input type="checkbox"/>	<input type="checkbox"/>	<input type="checkbox"/>	<input type="checkbox"/>						
	30 x 30"	WBWD3030	<input type="checkbox"/>	<input type="checkbox"/>	<input type="checkbox"/>	<input type="checkbox"/>	<input type="checkbox"/>	<input type="checkbox"/>	<input type="checkbox"/>	<input type="checkbox"/>						
	30 x 36"	WBWD3036	<input type="checkbox"/>	<input type="checkbox"/>	<input type="checkbox"/>	<input type="checkbox"/>	<input type="checkbox"/>	<input type="checkbox"/>	<input type="checkbox"/>	<input type="checkbox"/>						
	30 x 42"	WBWD3042	<input type="checkbox"/>	<input type="checkbox"/>	<input type="checkbox"/>	<input type="checkbox"/>	<input type="checkbox"/>	<input type="checkbox"/>	<input type="checkbox"/>	<input type="checkbox"/>						
	30 x 48"	WBWD3048	<input type="checkbox"/>	<input type="checkbox"/>	<input type="checkbox"/>	<input type="checkbox"/>	<input type="checkbox"/>	<input type="checkbox"/>	<input type="checkbox"/>	<input type="checkbox"/>						
	30 x 54"	WBWD3054	<input type="checkbox"/>	<input type="checkbox"/>	<input type="checkbox"/>	<input type="checkbox"/>	<input type="checkbox"/>	<input type="checkbox"/>	<input type="checkbox"/>	<input type="checkbox"/>						
 WBWP WorkZone® w/Power Worksurface	24 x 60"	WBWD2460	<input type="checkbox"/>	<input type="checkbox"/>	<input type="checkbox"/>	<input type="checkbox"/>	<input type="checkbox"/>	<input type="checkbox"/>	<input type="checkbox"/>	<input type="checkbox"/>						
	24 x 66"	WBWD2466	<input type="checkbox"/>	<input type="checkbox"/>	<input type="checkbox"/>	<input type="checkbox"/>	<input type="checkbox"/>	<input type="checkbox"/>	<input type="checkbox"/>	<input type="checkbox"/>						
	24 x 72"	WBWD2472	<input type="checkbox"/>	<input type="checkbox"/>	<input type="checkbox"/>	<input type="checkbox"/>	<input type="checkbox"/>	<input type="checkbox"/>	<input type="checkbox"/>	<input type="checkbox"/>						
	30 x 60"	WBWD3060	<input type="checkbox"/>	<input type="checkbox"/>	<input type="checkbox"/>	<input type="checkbox"/>	<input type="checkbox"/>	<input type="checkbox"/>	<input type="checkbox"/>	<input type="checkbox"/>						
	30 x 66"	WBWD3066	<input type="checkbox"/>	<input type="checkbox"/>	<input type="checkbox"/>	<input type="checkbox"/>	<input type="checkbox"/>	<input type="checkbox"/>	<input type="checkbox"/>	<input type="checkbox"/>						
	30 x 72"	WBWD3072	<input type="checkbox"/>	<input type="checkbox"/>	<input type="checkbox"/>	<input type="checkbox"/>	<input type="checkbox"/>	<input type="checkbox"/>	<input type="checkbox"/>	<input type="checkbox"/>						

A **B** **C** **D** **E** **F** **G** **H** **I** **J** **K** **L** **M** **N** **O**

HOW TO ORDER

Indicate the following information on order form:

- Quantity of each item.
- Model number, including options. See "How To Build a Model Number".
- Any special service required.

Note: • The indicates that a choice is required.

- The absence of the indicates that no choice is required.
- Alpha-numeric characters in place of indicate that no other alternatives are available.

HOW TO BUILD A MODEL NUMBER

A Select basic model.

B Select edge style.

BN - Flat vinyl T-edge
74P - 74P edge
EP - Elliptical postformed edge
PF - Postformed edge

C Select PowerUp® module location.

PUN - No module
PUL - Left module; add \$108
PUR - Right module; add \$108
PUC - Center module; add \$108
PUB - Both left and right modules; add \$217

PUB option only available on 60", 66" and 72" wide worksurfaces. PUC option: Overhead storage is not available on 66" or 72" basic WorkZone worksurfaces with center location PowerUp modules.

D Select height.

7 - 27" high

9 - 29" High

E Select wire trough.

Add upcharge to unit price for WT option.

NT - No wire trough

WT - Wire trough

Available in black only.

F Select electrical option.

Add upcharge to unit price for T6 option.

NP - No power

T6 - T6 power

If T6 power is specified, receptacles, jumpers and infeeds are to be specified separately

G Select frame style.

Add upcharge to unit price for WF option.

WB - w/ Beam

WM - w/ Modesty panel

WF - w/ Full modesty panel

w/ Full modesty panel (available on 29" high only)

H Select location and type of leg.

TS - Standard legs

TB - Transition leg (both)

TL - Transition leg (left)

TR - Transition leg (right)

I Select grommet option.

Grommets are required for overhead cabinet.

OGN - No worksurface grommet

OGY - Yes worksurface grommet

Grommets can be used for wire pass-through.

J Select paint color.

Refer to color addendum at ki.com or KI Fabrics & Finishes binder.

K Select insert color.

Refer to color addendum at ki.com or KI Fabrics & Finishes binder. Insert color also includes wire trough (WT) if selected.

L Select laminate surface.

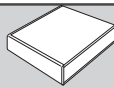
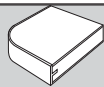

Approx. Packaged Weight	Flat Vinyl T-Edge (BN)	74P Edge (74P)	Elliptical Postformed Edge (EP)	Postformed Edge (PF)	Wire Trough add to list price	T6 add to list price	Full Modesty Panel add to list price
76.0#	\$ 609	\$ 637	\$ 666	\$ 698	\$ 203	\$ 146	\$ 47
83.0#	630	662	693	724	218	150	57
90.0#	656	688	720	755	231	161	67
96.0#	679	709	743	779	237	167	77
103.0#	698	734	767	805	252	173	83
83.0#	620	649	681	711	203	146	47
90.0#	647	679	708	743	218	150	57
99.0#	667	699	734	767	231	161	67
107.0#	688	721	755	790	237	167	77
113.0#	709	744	780	815	252	173	83
109.0#	\$ 723	\$ 758	\$ 793	\$ 833	\$ 264	\$ 385	\$ 94
116.0#	746	782	816	856	271	399	122
123.0#	767	805	843	882	275	411	131
120.0#	737	770	808	846	264	385	94
127.0#	756	792	829	869	271	399	122
133.0#	779	814	853	895	275	411	131

Refer to color addendum at ki.com or KI Fabrics & Finishes binder.

M Select edge color.
Refer to color addendum at ki.com or KI Fabrics & Finishes binder.
Edge color offerings are based on edge style selections.

N Select grommet color.
Refer to color addendum at ki.com or KI Fabrics & Finishes binder.

O Select PowerUp® module color.
Refer to color addendum at ki.com or KI Fabrics & Finishes binder.

FINISH INFORMATION

Additional Laminate Offering
Additional laminates beyond KI standard offering, are available with two weeks extended leadtime. To specify additional laminates, use these designators followed by the supplier's color/pattern code:

Formica - LF/supplier's color pattern code
Nevamar - LN/supplier's color pattern code
Wilsonart - LW/supplier's color pattern code

KI's standard finish is the supplier's recommended finish for that color/pattern.
Note: Nonstandard laminates from these suppliers (example: textured laminates), require an upcharge and additional leadtime. Contact KI.

SPECIAL SERVICES

Special Carton Marking

With specially marked information N/C

Shipping

Shipped **k.d. freight prepaid f.o.b. Manitowoc, Wisconsin 54220** factory. Freight class #70.

Specifications and prices are subject to change without prior notice.

WorkZone® with Power

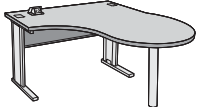
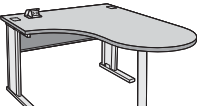
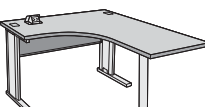
		MODEL NUMBER																
D x W x L		Basic Model	Edge Style	Dr	P-Up Mod	Ht	W-Trgh	Elet Opt	Frame Style	Leg	Grom	Paint Clr	Insrt Clr	Lam Clr	Edge Clr	Grm Clr	P-Up Mod Clr	
 <p>WZWP "P" Shaped Peninsula Worksurface</p> <ul style="list-style-type: none"> • Guest modesty panel (WZMP) may be ordered 	24 x 48 x 60"	WZPTD244860	<input type="checkbox"/>	<input type="checkbox"/>	<input type="checkbox"/>	9	<input type="checkbox"/>	<input type="checkbox"/>	<input type="checkbox"/>	<input type="checkbox"/>	<input type="checkbox"/>	<input type="checkbox"/>	<input type="checkbox"/>	<input type="checkbox"/>	<input type="checkbox"/>	<input type="checkbox"/>	<input type="checkbox"/>	
	24 x 48 x 72"	WZPTD244872	<input type="checkbox"/>	<input type="checkbox"/>	<input type="checkbox"/>	9	<input type="checkbox"/>	<input type="checkbox"/>	<input type="checkbox"/>	<input type="checkbox"/>	<input type="checkbox"/>	<input type="checkbox"/>	<input type="checkbox"/>	<input type="checkbox"/>	<input type="checkbox"/>	<input type="checkbox"/>	<input type="checkbox"/>	
	30 x 48 x 72"	WZPTD304872	<input type="checkbox"/>	<input type="checkbox"/>	<input type="checkbox"/>	9	<input type="checkbox"/>	<input type="checkbox"/>	<input type="checkbox"/>	<input type="checkbox"/>	<input type="checkbox"/>	<input type="checkbox"/>	<input type="checkbox"/>	<input type="checkbox"/>	<input type="checkbox"/>	<input type="checkbox"/>	<input type="checkbox"/>	
 <p>WZWP Piano Peninsula Worksurface</p> <ul style="list-style-type: none"> • Guest modesty panel (WZMP) may be ordered 	24 x 48 x 60"	WZPPD244860	<input type="checkbox"/>	<input type="checkbox"/>	<input type="checkbox"/>	9	<input type="checkbox"/>	<input type="checkbox"/>	<input type="checkbox"/>	<input type="checkbox"/>	<input type="checkbox"/>	<input type="checkbox"/>	<input type="checkbox"/>	<input type="checkbox"/>	<input type="checkbox"/>	<input type="checkbox"/>	<input type="checkbox"/>	
	24 x 48 x 72"	WZPPD244872	<input type="checkbox"/>	<input type="checkbox"/>	<input type="checkbox"/>	9	<input type="checkbox"/>	<input type="checkbox"/>	<input type="checkbox"/>	<input type="checkbox"/>	<input type="checkbox"/>	<input type="checkbox"/>	<input type="checkbox"/>	<input type="checkbox"/>	<input type="checkbox"/>	<input type="checkbox"/>	<input type="checkbox"/>	
	30 x 48 x 72"	WZPPD304872	<input type="checkbox"/>	<input type="checkbox"/>	<input type="checkbox"/>	9	<input type="checkbox"/>	<input type="checkbox"/>	<input type="checkbox"/>	<input type="checkbox"/>	<input type="checkbox"/>	<input type="checkbox"/>	<input type="checkbox"/>	<input type="checkbox"/>	<input type="checkbox"/>	<input type="checkbox"/>	<input type="checkbox"/>	
 <p>WZWP Square Shoe Worksurface</p> <ul style="list-style-type: none"> • Guest modesty panel (WZMP) may be ordered 	24 x 48 x 60"	WZSSD244860	<input type="checkbox"/>	<input type="checkbox"/>	<input type="checkbox"/>	9	<input type="checkbox"/>	<input type="checkbox"/>	<input type="checkbox"/>	<input type="checkbox"/>	<input type="checkbox"/>	<input type="checkbox"/>	<input type="checkbox"/>	<input type="checkbox"/>	<input type="checkbox"/>	<input type="checkbox"/>	<input type="checkbox"/>	
	24 x 48 x 66"	WZSSD244866	<input type="checkbox"/>	<input type="checkbox"/>	<input type="checkbox"/>	9	<input type="checkbox"/>	<input type="checkbox"/>	<input type="checkbox"/>	<input type="checkbox"/>	<input type="checkbox"/>	<input type="checkbox"/>	<input type="checkbox"/>	<input type="checkbox"/>	<input type="checkbox"/>	<input type="checkbox"/>	<input type="checkbox"/>	
	24 x 48 x 72"	WZSSD244872	<input type="checkbox"/>	<input type="checkbox"/>	<input type="checkbox"/>	9	<input type="checkbox"/>	<input type="checkbox"/>	<input type="checkbox"/>	<input type="checkbox"/>	<input type="checkbox"/>	<input type="checkbox"/>	<input type="checkbox"/>	<input type="checkbox"/>	<input type="checkbox"/>	<input type="checkbox"/>	<input type="checkbox"/>	
	24 x 48 x 84"	WZSSD244884	<input type="checkbox"/>	<input type="checkbox"/>	<input type="checkbox"/>	9	<input type="checkbox"/>	<input type="checkbox"/>	<input type="checkbox"/>	<input type="checkbox"/>	<input type="checkbox"/>	<input type="checkbox"/>	<input type="checkbox"/>	<input type="checkbox"/>	<input type="checkbox"/>	<input type="checkbox"/>	<input type="checkbox"/>	
	30 x 48 x 66"	WZSSD304866	<input type="checkbox"/>	<input type="checkbox"/>	<input type="checkbox"/>	9	<input type="checkbox"/>	<input type="checkbox"/>	<input type="checkbox"/>	<input type="checkbox"/>	<input type="checkbox"/>	<input type="checkbox"/>	<input type="checkbox"/>	<input type="checkbox"/>	<input type="checkbox"/>	<input type="checkbox"/>	<input type="checkbox"/>	
	30 x 48 x 72"	WZSSD304872	<input type="checkbox"/>	<input type="checkbox"/>	<input type="checkbox"/>	9	<input type="checkbox"/>	<input type="checkbox"/>	<input type="checkbox"/>	<input type="checkbox"/>	<input type="checkbox"/>	<input type="checkbox"/>	<input type="checkbox"/>	<input type="checkbox"/>	<input type="checkbox"/>	<input type="checkbox"/>	<input type="checkbox"/>	
	30 x 48 x 84"	WZSSD304884	<input type="checkbox"/>	<input type="checkbox"/>	<input type="checkbox"/>	9	<input type="checkbox"/>	<input type="checkbox"/>	<input type="checkbox"/>	<input type="checkbox"/>	<input type="checkbox"/>	<input type="checkbox"/>	<input type="checkbox"/>	<input type="checkbox"/>	<input type="checkbox"/>	<input type="checkbox"/>	<input type="checkbox"/>	
			A	B	C	D	E	F	G	H	I	J	K	L	M	N	O	P

HOW TO ORDER

Indicate the following information on order form:

- Quantity of each item.
- Model number, including options. See "How To Build a Model Number".
- Any special service required.

Note: • The indicates that a choice is required.

- The absence of the indicates that no choice is required.
- Alpha-numeric characters in place of indicate that no other alternatives are available.

HOW TO BUILD A MODEL NUMBER

- A** Select basic model.
- B** Select edge style.
BN - Flat vinyl T-edge
74P - 74P edge
- C** Select surface direction.
L - Left
R - Right
- D** Select PowerUp® module location.
PUN - No module
PUL - Left module; add \$108
PUR - Right module; add \$108
PUC - Center module; add \$108
- E** Select height.
9 - 29" high
- F** Select wire trough.
 Add upcharge to unit price for WT option.
NT - No wire trough
WT - Wire trough

Available in black only.

- G** Select electrical option.
 Add upcharge to unit price for T6 option.
NP - No power
T6 - T6 power
- H** Select frame style.
 Add upcharge to unit price for WF option.
WM - w/ Modesty panel
WF - w/ Full modesty panel
 w/ Full modesty panel (available on 29" high only)
- I** Select location and type of leg.
TS - Standard legs
TB - Transition leg (both)
TL - Transition leg (left)
TR - Transition leg (right)
- J** Select grommet option.
 Grommets are required for overhead cabinet.
OGN - No worksurface grommet
OGY - Yes worksurface grommet

Grommets can be used for wire pass-through.

- K** Select paint color.
 Refer to color addendum at ki.com or KI Fabrics & Finishes binder.
- L** Select insert color.
 Refer to color addendum at ki.com or KI Fabrics & Finishes binder.
 Insert color also includes wire trough (WT) if selected.
- M** Select laminate surface.
 Refer to color addendum at ki.com or KI Fabrics & Finishes binder.
- N** Select edge color.
 Refer to color addendum at ki.com or KI Fabrics & Finishes binder.
 Edge color offerings are based on edge style selections.
- O** Select grommet color.
 Refer to color addendum at ki.com or

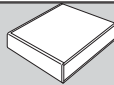
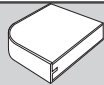

Approx. Packaged Weight	Flat Vinyl T-Edge (BN)	74P Edge (74P)	Wire Trough add to list price	T6 add to list price	Full Modesty Panel add to list price
144.0#	\$ 1334	\$ 1399	\$ 237	\$ 167	\$ 77
156.0#	1340	1406	237	167	77
160.0#	1347	1413	237	167	77
142.0#	\$ 1263	\$ 1323	\$ 237	\$ 167	\$ 77
154.0#	1270	1334	237	167	77
158.0#	1277	1340	237	167	77
143.0#	\$ 1225	\$ 1281	\$ 237	\$ 167	\$ 77
149.0#	1257	1318	237	167	77
155.0#	1270	1333	237	167	77
167.0#	1318	1383	237	167	77
154.0#	1257	1318	237	167	77
160.0#	1270	1333	237	167	77
182.0#	1318	1383	237	167	77

KI Fabrics & Finishes binder.

P Select PowerUp® module color. Refer to color addendum at ki.com or KI Fabrics & Finishes binder.

FINISH INFORMATION

Additional Laminate Offering

Additional laminates beyond KI standard offering, are available with two weeks extended leadtime. To specify additional laminates, use these designators followed by the supplier's color/pattern code:

- Formica - LF/supplier's color pattern code
- Nevamar - LN/supplier's color pattern code
- Wilsonart - LW/supplier's color pattern code

KI's standard finish is the supplier's recommended finish for that color/pattern.

Note: Nonstandard laminates from these suppliers (example: textured laminates), require an upcharge and additional leadtime. Contact KI.

SPECIAL SERVICES

Special Carton Marking

With specially marked information N/C



Shipping

Shipped k.d. freight prepaid f.o.b. Manitowoc, Wisconsin 54220 factory. Freight class #70.

Specifications and prices are subject to change without prior notice.

WorkZone® with Power

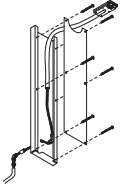
Electrical

	MODEL	MODEL NUMBER		Approx. Packaged Weight
		Basic Model	Trim Color	
	Floor Infeed (6-Circuit Pre-wired) 6-2-2 <ul style="list-style-type: none"> Provides power from fixed floor or wall sources to table distribution system Select height to match leg height. Example: 27", 29" or 42" Infeed distributes power in one direction only. Specify two infeeds for middle of row applications so power travels in both directions Electrical does not support back-to-back layouts 	WZ.T6PI.27	<input type="checkbox"/>	5.0#
		WZ.T6PI.29	<input type="checkbox"/>	5.0#
		WZ.T6PI.42	<input type="checkbox"/>	6.0#
HRDPT				
	Duplex Receptacle -10-Wire System 6-2-2 <ul style="list-style-type: none"> Convenience circuits share a neutral and ground wire The 1, 2 or 3 in the basic model number denotes the circuit Black only 	WZ.T6RECP.1		0.2#
		WZ.T6RECP.2		0.2#
		WZ.T6RECP.3		0.2#
HRDPT				
	Isolated Receptacle - 10-Wire System 6-2-2 <ul style="list-style-type: none"> Dedicated circuit has its own neutral and ground wire Orange only 	WZ.T6RECP.4I		0.2#
		WZ.T6RECP.5I		0.2#
		WZ.T6RECP.6I		0.2#
HRDPT				

A

B

HOW TO ORDER

Indicate the following information on order form:

- Quantity of each item.
- Model number, including options. See "How To Build a Model Number".
- Any special service required.

Note: • The indicates that a choice is required.

- The absence of the indicates that no choice is required.
- Alpha-numeric characters in place of indicate that no other alternatives are available.

HOW TO BUILD A MODEL NUMBER

- A** Select basic model.
- B** Select trim color.
Refer to color addendum at ki.com or KI Fabrics & Finishes binder.



Delivered
Pricing

\$ 340

340

365

\$ 26

26

26

\$ 26

26

26

SPECIAL SERVICES

Special Carton Marking

With specially marked information N/C

Shipping

Shipped k.d. freight prepaid f.o.b. Manitowoc, Wisconsin 54220 factory. Freight class #70.

Specifications and prices are subject to change without prior notice.

WorkZone® with Power

Electrical

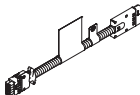
	MODEL	MODEL NUMBER	
		Basic Model	Approx. Packaged Weight
 <p>HRDPT</p>	<p>10-Wire Table-to-Table Connector 6-2-2</p> <ul style="list-style-type: none"> • Connects the 10-wire power system of two adjoining tables • 17-3/4" long • Includes steel wireway and splice plate • Black only 	WZ.T6SC18	0.5#
 <p>HRDPT</p>	<p>8-Wire to 10-Wire Adaptor</p> <ul style="list-style-type: none"> • 30" long 	47.0709.30	1.0#

A

HOW TO ORDER

Indicate the following information on order form:

1. Quantity of each item.
2. Model number, including options. See "How To Build a Model Number".
3. Any special service required.

- Note:
- The indicates that a choice is required.
 - The absence of the indicates that no choice is required.
 - Alpha-numeric characters in place of indicate that no other alternatives are available.

HOW TO BUILD A MODEL NUMBER

- A** Select basic model.



Delivered
Pricing
\$ 122

\$ 149

SPECIAL SERVICES

Special Carton Marking

With specially marked information N/C

Shipping

Shipped k.d. freight prepaid f.o.b. Manitowoc, Wisconsin 54220 factory. Freight class #70.

Specifications and prices are subject to change without prior notice.

Activ8® System

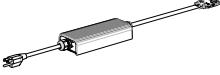
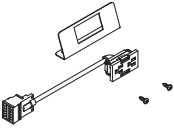
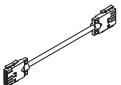
	MODEL	L	MODEL NUMBER		Approx. Packaged Weight
				Basic Model	
 HRDPT	Activ8® Infeed <ul style="list-style-type: none"> • 108" cord plugs into standard 15 amp outlet • Control module is located 6" from table connection • Diagnostic LED indicator shows power status (see details below) • Controller automatically limits number of connections to 8 • 40 Ft maximum string, not including infeed cord • Wire Trough (WT) and No Power (NP) are required to use Activ8 		AC8IF.108		2.0#
 HRDPT	Activ8® Module and Attachment Bracket <ul style="list-style-type: none"> • Duplex receptacles provide 2 outlets • Power module provides 15 amp power • Up to 8 modules may be used per infeed per UL Standard 962 • Modules may be connected (reconnected in any order without sequential keying) • Modules snap into brackets that are attached to the InTandem® Table System, WorkZone® and DataLink® Training Table • Jumpers ordered separately • Module will snap directly into KI Genesis® troughs and KI True® Desking stanchions • No data cord management is provided • Attached cord is approximately 9" • Wire Trough (WT) and No Power (NP) are required to use Activ8 		AC8RPTWZ.12		1.0#
 HRDPT	Activ8® Jumper <ul style="list-style-type: none"> • Jumper lengths include 29", 53" and 77" • Jumpers are all keyed alike • Wire Trough (WT) and No Power (NP) are required to use Activ8 	29"	AC8JP.29		1.0#
		53"	AC8JP.53		1.0#
		77"	AC8JP.77		1.0#

A

HOW TO ORDER

Indicate the following information on order form:

1. Quantity of each item.
2. Model number, including options. See "How To Build a Model Number".
3. Any special service required.

Note: • The indicates that a choice is required.

- The absence of the indicates that no choice is required.
- Alpha-numeric characters in place of indicate that no other alternatives are available.

HOW TO BUILD A MODEL NUMBER

- A** Select basic model.



Delivered Pricing

\$ 202

\$ 128

\$ 64

74

85

SPECIAL SERVICES

Special Carton Marking



With specially marked information N/C

Shipping

Shipped k.d. freight prepaid f.o.b. Manitowoc, Wisconsin 54220 factory. Freight class #70.

Specifications and prices are subject to change without prior notice.

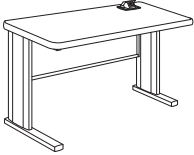
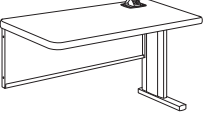
WorkZone® Shared Leg

		MODEL NUMBER													
		Basic Model	Edge Style	PowerUp Module	W-Trgh	Elct Opt	Frame Style	Wrksrf. Grom.	Paint Color	Insert Color	Lam. Color	Edge Color	Grom. Color	PowerUp Module Color	
		D x W													
 WZSL 24" Starter	24 x 30"	WBSL2430S	<input type="checkbox"/>	<input type="checkbox"/>	<input type="checkbox"/>	<input type="checkbox"/>	<input type="checkbox"/>	<input type="checkbox"/>	<input type="checkbox"/>	<input type="checkbox"/>	<input type="checkbox"/>	<input type="checkbox"/>	<input type="checkbox"/>	<input type="checkbox"/>	
	24 x 36"	WBSL2436S	<input type="checkbox"/>	<input type="checkbox"/>	<input type="checkbox"/>	<input type="checkbox"/>	<input type="checkbox"/>	<input type="checkbox"/>	<input type="checkbox"/>	<input type="checkbox"/>	<input type="checkbox"/>	<input type="checkbox"/>	<input type="checkbox"/>	<input type="checkbox"/>	
	24 x 42"	WBSL2442S	<input type="checkbox"/>	<input type="checkbox"/>	<input type="checkbox"/>	<input type="checkbox"/>	<input type="checkbox"/>	<input type="checkbox"/>	<input type="checkbox"/>	<input type="checkbox"/>	<input type="checkbox"/>	<input type="checkbox"/>	<input type="checkbox"/>	<input type="checkbox"/>	
	24 x 48"	WBSL2448S	<input type="checkbox"/>	<input type="checkbox"/>	<input type="checkbox"/>	<input type="checkbox"/>	<input type="checkbox"/>	<input type="checkbox"/>	<input type="checkbox"/>	<input type="checkbox"/>	<input type="checkbox"/>	<input type="checkbox"/>	<input type="checkbox"/>	<input type="checkbox"/>	
	24 x 54"	WBSL2454S	<input type="checkbox"/>	<input type="checkbox"/>	<input type="checkbox"/>	<input type="checkbox"/>	<input type="checkbox"/>	<input type="checkbox"/>	<input type="checkbox"/>	<input type="checkbox"/>	<input type="checkbox"/>	<input type="checkbox"/>	<input type="checkbox"/>	<input type="checkbox"/>	
	24 x 60"	WBSL2460S	<input type="checkbox"/>	<input type="checkbox"/>	<input type="checkbox"/>	<input type="checkbox"/>	<input type="checkbox"/>	<input type="checkbox"/>	<input type="checkbox"/>	<input type="checkbox"/>	<input type="checkbox"/>	<input type="checkbox"/>	<input type="checkbox"/>	<input type="checkbox"/>	
	24 x 66"	WBSL2466S	<input type="checkbox"/>	<input type="checkbox"/>	<input type="checkbox"/>	<input type="checkbox"/>	<input type="checkbox"/>	<input type="checkbox"/>	<input type="checkbox"/>	<input type="checkbox"/>	<input type="checkbox"/>	<input type="checkbox"/>	<input type="checkbox"/>	<input type="checkbox"/>	
	24 x 72"	WBSL2472S	<input type="checkbox"/>	<input type="checkbox"/>	<input type="checkbox"/>	<input type="checkbox"/>	<input type="checkbox"/>	<input type="checkbox"/>	<input type="checkbox"/>	<input type="checkbox"/>	<input type="checkbox"/>	<input type="checkbox"/>	<input type="checkbox"/>	<input type="checkbox"/>	
 WZSL 24" Adder	24 x 30"	WBSL2430A	<input type="checkbox"/>	<input type="checkbox"/>	<input type="checkbox"/>	<input type="checkbox"/>	<input type="checkbox"/>	<input type="checkbox"/>	<input type="checkbox"/>	<input type="checkbox"/>	<input type="checkbox"/>	<input type="checkbox"/>	<input type="checkbox"/>	<input type="checkbox"/>	
	24 x 36"	WBSL2436A	<input type="checkbox"/>	<input type="checkbox"/>	<input type="checkbox"/>	<input type="checkbox"/>	<input type="checkbox"/>	<input type="checkbox"/>	<input type="checkbox"/>	<input type="checkbox"/>	<input type="checkbox"/>	<input type="checkbox"/>	<input type="checkbox"/>	<input type="checkbox"/>	
	24 x 42"	WBSL2442A	<input type="checkbox"/>	<input type="checkbox"/>	<input type="checkbox"/>	<input type="checkbox"/>	<input type="checkbox"/>	<input type="checkbox"/>	<input type="checkbox"/>	<input type="checkbox"/>	<input type="checkbox"/>	<input type="checkbox"/>	<input type="checkbox"/>	<input type="checkbox"/>	
	24 x 48"	WBSL2448A	<input type="checkbox"/>	<input type="checkbox"/>	<input type="checkbox"/>	<input type="checkbox"/>	<input type="checkbox"/>	<input type="checkbox"/>	<input type="checkbox"/>	<input type="checkbox"/>	<input type="checkbox"/>	<input type="checkbox"/>	<input type="checkbox"/>	<input type="checkbox"/>	
	24 x 54"	WBSL2454A	<input type="checkbox"/>	<input type="checkbox"/>	<input type="checkbox"/>	<input type="checkbox"/>	<input type="checkbox"/>	<input type="checkbox"/>	<input type="checkbox"/>	<input type="checkbox"/>	<input type="checkbox"/>	<input type="checkbox"/>	<input type="checkbox"/>	<input type="checkbox"/>	
	24 x 60"	WBSL2460A	<input type="checkbox"/>	<input type="checkbox"/>	<input type="checkbox"/>	<input type="checkbox"/>	<input type="checkbox"/>	<input type="checkbox"/>	<input type="checkbox"/>	<input type="checkbox"/>	<input type="checkbox"/>	<input type="checkbox"/>	<input type="checkbox"/>	<input type="checkbox"/>	
	24 x 66"	WBSL2466A	<input type="checkbox"/>	<input type="checkbox"/>	<input type="checkbox"/>	<input type="checkbox"/>	<input type="checkbox"/>	<input type="checkbox"/>	<input type="checkbox"/>	<input type="checkbox"/>	<input type="checkbox"/>	<input type="checkbox"/>	<input type="checkbox"/>	<input type="checkbox"/>	
	24 x 72"	WBSL2472A	<input type="checkbox"/>	<input type="checkbox"/>	<input type="checkbox"/>	<input type="checkbox"/>	<input type="checkbox"/>	<input type="checkbox"/>	<input type="checkbox"/>	<input type="checkbox"/>	<input type="checkbox"/>	<input type="checkbox"/>	<input type="checkbox"/>	<input type="checkbox"/>	
 WZSL 24" Finisher	24 x 30"	WBSL2430F	<input type="checkbox"/>	<input type="checkbox"/>	<input type="checkbox"/>	<input type="checkbox"/>	<input type="checkbox"/>	<input type="checkbox"/>	<input type="checkbox"/>	<input type="checkbox"/>	<input type="checkbox"/>	<input type="checkbox"/>	<input type="checkbox"/>	<input type="checkbox"/>	
	24 x 36"	WBSL2436F	<input type="checkbox"/>	<input type="checkbox"/>	<input type="checkbox"/>	<input type="checkbox"/>	<input type="checkbox"/>	<input type="checkbox"/>	<input type="checkbox"/>	<input type="checkbox"/>	<input type="checkbox"/>	<input type="checkbox"/>	<input type="checkbox"/>	<input type="checkbox"/>	
	24 x 42"	WBSL2442F	<input type="checkbox"/>	<input type="checkbox"/>	<input type="checkbox"/>	<input type="checkbox"/>	<input type="checkbox"/>	<input type="checkbox"/>	<input type="checkbox"/>	<input type="checkbox"/>	<input type="checkbox"/>	<input type="checkbox"/>	<input type="checkbox"/>	<input type="checkbox"/>	
	24 x 48"	WBSL2448F	<input type="checkbox"/>	<input type="checkbox"/>	<input type="checkbox"/>	<input type="checkbox"/>	<input type="checkbox"/>	<input type="checkbox"/>	<input type="checkbox"/>	<input type="checkbox"/>	<input type="checkbox"/>	<input type="checkbox"/>	<input type="checkbox"/>	<input type="checkbox"/>	
	24 x 54"	WBSL2454F	<input type="checkbox"/>	<input type="checkbox"/>	<input type="checkbox"/>	<input type="checkbox"/>	<input type="checkbox"/>	<input type="checkbox"/>	<input type="checkbox"/>	<input type="checkbox"/>	<input type="checkbox"/>	<input type="checkbox"/>	<input type="checkbox"/>	<input type="checkbox"/>	
	24 x 60"	WBSL2460F	<input type="checkbox"/>	<input type="checkbox"/>	<input type="checkbox"/>	<input type="checkbox"/>	<input type="checkbox"/>	<input type="checkbox"/>	<input type="checkbox"/>	<input type="checkbox"/>	<input type="checkbox"/>	<input type="checkbox"/>	<input type="checkbox"/>	<input type="checkbox"/>	
	24 x 66"	WBSL2466F	<input type="checkbox"/>	<input type="checkbox"/>	<input type="checkbox"/>	<input type="checkbox"/>	<input type="checkbox"/>	<input type="checkbox"/>	<input type="checkbox"/>	<input type="checkbox"/>	<input type="checkbox"/>	<input type="checkbox"/>	<input type="checkbox"/>	<input type="checkbox"/>	
	24 x 72"	WBSL2472F	<input type="checkbox"/>	<input type="checkbox"/>	<input type="checkbox"/>	<input type="checkbox"/>	<input type="checkbox"/>	<input type="checkbox"/>	<input type="checkbox"/>	<input type="checkbox"/>	<input type="checkbox"/>	<input type="checkbox"/>	<input type="checkbox"/>	<input type="checkbox"/>	
			A	B	C	D	E	F	G	H	I	J	K	L	M

HOW TO ORDER

Indicate the following information on order form:

- Quantity of each item.
- Model number, including options. See "How To Build a Model Number".
- Any special service required.

Note:

- The indicates that a choice is required.
- The absence of the indicates that no choice is required.
- Alpha-numeric characters in place of indicate that no other alternatives are available.

HOW TO BUILD A MODEL NUMBER

A Select basic model.

B Select edge style.

74P - 74P edge
EP - Elliptical postformed edge
PF - Postformed edge

C Select PowerUp® module location.

PUN - No module
PUL - Left module; add \$108
PUR - Right module; add \$108
PUC - Center module; add \$108
PUB - Both left and right modules; add \$217
 PUB option only available on 60", 66" and 72" wide worksurfaces.

D Select wire trough.

Add upcharge to unit price for WT option.
NT - No wire trough
WT - Wire trough
 Available in black only.

E Select electrical option.

Add upcharge to unit price for T6 option.

NP - No power
T6 - T6 power

If T6 power is specified, receptacles, jumpers and infeeds are to be specified separately

F Select frame style.

Add upcharge to unit price for WF option.

WM - w/ Modesty panel
WF - w/ Full modesty panel

G Select grommet option.

Overhead cabinet can NOT be ordered.

OGN - No worksurface grommet

OGY - Yes worksurface grommet

Grommets can be used for wire pass-through.

H Select paint color.

Refer to color addendum at ki.com or KI Fabrics & Finishes binder.

I Select insert color.

Refer to color addendum at ki.com or KI Fabrics & Finishes binder.

J Select laminate surface.

Refer to color addendum at ki.com or KI Fabrics & Finishes binder.

K Select edge color.

Refer to color addendum at ki.com or KI Fabrics & Finishes binder. Edge color offerings are based on edge style selections.

L Select grommet color.

Refer to color addendum at ki.com or KI Fabrics & Finishes binder.

M Select PowerUp® module color.

Refer to color addendum at ki.com or KI Fabrics & Finishes binder.

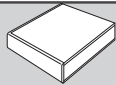

Approx. Packaged Weight	74P Edge (74P)	Elliptical Postformed Edge (EP)	Postformed Edge (PF)	Wire Trough add to list price	T6 add to list price	Full Modesty Panel add to list price
72.0#	\$ 538	\$ 563	\$ 592	\$ 203	\$ 146	\$ 47
79.0#	560	588	616	218	150	57
86.0#	577	606	634	231	161	67
92.0#	596	626	659	237	167	77
99.0#	621	653	688	252	173	83
105.0#	646	679	711	264	385	94
113.0#	663	697	729	271	399	122
119.0#	688	721	758	275	411	131
62.0#	\$ 538	\$ 563	\$ 592	\$ 203	\$ 146	\$ 47
69.0#	560	588	616	218	150	57
76.0#	577	606	634	231	161	67
82.0#	596	626	659	237	167	77
89.0#	621	653	688	252	173	83
95.0#	646	679	711	264	385	94
103.0#	663	697	729	271	399	122
109.0#	688	721	758	275	411	131
61.0#	\$ 538	\$ 563	\$ 592	\$ 203	\$ 146	\$ 47
68.0#	560	588	616	218	150	57
75.0#	577	606	634	231	161	67
81.0#	596	626	659	237	167	77
88.0#	621	653	688	252	173	83
94.0#	646	679	711	264	385	94
102.0#	663	697	729	271	399	122
108.0#	688	721	758	275	411	131

FINISH INFORMATION

Additional Laminate Offering

Additional laminates beyond KI standard offering, are available with two weeks extended leadtime. To specify additional laminates, use these designators followed by the supplier's color/pattern code:

- Formica - LF/supplier's color pattern code
- Nevamar - LN/supplier's color pattern code
- Wilsonart - LW/supplier's color pattern code

KI's standard finish is the supplier's recommended finish for that color/pattern.

Note: Nonstandard laminates from these suppliers (example: textured laminates), require an upcharge and additional leadtime. Contact KI.

SPECIAL SERVICES

Special Carton Marking

With specially marked information N/C

Shipping

Shipped k.d. freight prepaid f.o.b. Manitowoc, Wisconsin 54220 factory. Freight class #70.

Specifications and prices are subject to change without prior notice.

WorkZone® Shared Leg

		MODEL NUMBER												
		Basic Model	Edge Style	PowerUp Module	W-Trgh	Power Option	Frame Style	Wrksrf. Grom.	Paint Color	Insert Color	Lam. Color	Edge Color	Grom. Color	PowerUp Module Color
D x W														
	30 x 30"	WBSL3030S	<input type="checkbox"/>	<input type="checkbox"/>	<input type="checkbox"/>	<input type="checkbox"/>	<input type="checkbox"/>	<input type="checkbox"/>	<input type="checkbox"/>	<input type="checkbox"/>	<input type="checkbox"/>	<input type="checkbox"/>	<input type="checkbox"/>	<input type="checkbox"/>
	30 x 36"	WBSL3036S	<input type="checkbox"/>	<input type="checkbox"/>	<input type="checkbox"/>	<input type="checkbox"/>	<input type="checkbox"/>	<input type="checkbox"/>	<input type="checkbox"/>	<input type="checkbox"/>	<input type="checkbox"/>	<input type="checkbox"/>	<input type="checkbox"/>	<input type="checkbox"/>
	30 x 42"	WBSL3042S	<input type="checkbox"/>	<input type="checkbox"/>	<input type="checkbox"/>	<input type="checkbox"/>	<input type="checkbox"/>	<input type="checkbox"/>	<input type="checkbox"/>	<input type="checkbox"/>	<input type="checkbox"/>	<input type="checkbox"/>	<input type="checkbox"/>	<input type="checkbox"/>
	30 x 48"	WBSL3048S	<input type="checkbox"/>	<input type="checkbox"/>	<input type="checkbox"/>	<input type="checkbox"/>	<input type="checkbox"/>	<input type="checkbox"/>	<input type="checkbox"/>	<input type="checkbox"/>	<input type="checkbox"/>	<input type="checkbox"/>	<input type="checkbox"/>	<input type="checkbox"/>
	30 x 54"	WBSL3054S	<input type="checkbox"/>	<input type="checkbox"/>	<input type="checkbox"/>	<input type="checkbox"/>	<input type="checkbox"/>	<input type="checkbox"/>	<input type="checkbox"/>	<input type="checkbox"/>	<input type="checkbox"/>	<input type="checkbox"/>	<input type="checkbox"/>	<input type="checkbox"/>
	30 x 60"	WBSL3060S	<input type="checkbox"/>	<input type="checkbox"/>	<input type="checkbox"/>	<input type="checkbox"/>	<input type="checkbox"/>	<input type="checkbox"/>	<input type="checkbox"/>	<input type="checkbox"/>	<input type="checkbox"/>	<input type="checkbox"/>	<input type="checkbox"/>	<input type="checkbox"/>
	30 x 66"	WBSL3066S	<input type="checkbox"/>	<input type="checkbox"/>	<input type="checkbox"/>	<input type="checkbox"/>	<input type="checkbox"/>	<input type="checkbox"/>	<input type="checkbox"/>	<input type="checkbox"/>	<input type="checkbox"/>	<input type="checkbox"/>	<input type="checkbox"/>	<input type="checkbox"/>
	30 x 72"	WBSL3072S	<input type="checkbox"/>	<input type="checkbox"/>	<input type="checkbox"/>	<input type="checkbox"/>	<input type="checkbox"/>	<input type="checkbox"/>	<input type="checkbox"/>	<input type="checkbox"/>	<input type="checkbox"/>	<input type="checkbox"/>	<input type="checkbox"/>	<input type="checkbox"/>
	30 x 30"	WBSL3030A	<input type="checkbox"/>	<input type="checkbox"/>	<input type="checkbox"/>	<input type="checkbox"/>	<input type="checkbox"/>	<input type="checkbox"/>	<input type="checkbox"/>	<input type="checkbox"/>	<input type="checkbox"/>	<input type="checkbox"/>	<input type="checkbox"/>	<input type="checkbox"/>
	30 x 36"	WBSL3036A	<input type="checkbox"/>	<input type="checkbox"/>	<input type="checkbox"/>	<input type="checkbox"/>	<input type="checkbox"/>	<input type="checkbox"/>	<input type="checkbox"/>	<input type="checkbox"/>	<input type="checkbox"/>	<input type="checkbox"/>	<input type="checkbox"/>	<input type="checkbox"/>
	30 x 42"	WBSL3042A	<input type="checkbox"/>	<input type="checkbox"/>	<input type="checkbox"/>	<input type="checkbox"/>	<input type="checkbox"/>	<input type="checkbox"/>	<input type="checkbox"/>	<input type="checkbox"/>	<input type="checkbox"/>	<input type="checkbox"/>	<input type="checkbox"/>	<input type="checkbox"/>
	30 x 48"	WBSL3048A	<input type="checkbox"/>	<input type="checkbox"/>	<input type="checkbox"/>	<input type="checkbox"/>	<input type="checkbox"/>	<input type="checkbox"/>	<input type="checkbox"/>	<input type="checkbox"/>	<input type="checkbox"/>	<input type="checkbox"/>	<input type="checkbox"/>	<input type="checkbox"/>
	30 x 54"	WBSL3054A	<input type="checkbox"/>	<input type="checkbox"/>	<input type="checkbox"/>	<input type="checkbox"/>	<input type="checkbox"/>	<input type="checkbox"/>	<input type="checkbox"/>	<input type="checkbox"/>	<input type="checkbox"/>	<input type="checkbox"/>	<input type="checkbox"/>	<input type="checkbox"/>
	30 x 60"	WBSL3060A	<input type="checkbox"/>	<input type="checkbox"/>	<input type="checkbox"/>	<input type="checkbox"/>	<input type="checkbox"/>	<input type="checkbox"/>	<input type="checkbox"/>	<input type="checkbox"/>	<input type="checkbox"/>	<input type="checkbox"/>	<input type="checkbox"/>	<input type="checkbox"/>
	30 x 66"	WBSL3066A	<input type="checkbox"/>	<input type="checkbox"/>	<input type="checkbox"/>	<input type="checkbox"/>	<input type="checkbox"/>	<input type="checkbox"/>	<input type="checkbox"/>	<input type="checkbox"/>	<input type="checkbox"/>	<input type="checkbox"/>	<input type="checkbox"/>	<input type="checkbox"/>
	30 x 72"	WBSL3072A	<input type="checkbox"/>	<input type="checkbox"/>	<input type="checkbox"/>	<input type="checkbox"/>	<input type="checkbox"/>	<input type="checkbox"/>	<input type="checkbox"/>	<input type="checkbox"/>	<input type="checkbox"/>	<input type="checkbox"/>	<input type="checkbox"/>	<input type="checkbox"/>
	30 x 30"	WBSL3030F	<input type="checkbox"/>	<input type="checkbox"/>	<input type="checkbox"/>	<input type="checkbox"/>	<input type="checkbox"/>	<input type="checkbox"/>	<input type="checkbox"/>	<input type="checkbox"/>	<input type="checkbox"/>	<input type="checkbox"/>	<input type="checkbox"/>	<input type="checkbox"/>
	30 x 36"	WBSL3036F	<input type="checkbox"/>	<input type="checkbox"/>	<input type="checkbox"/>	<input type="checkbox"/>	<input type="checkbox"/>	<input type="checkbox"/>	<input type="checkbox"/>	<input type="checkbox"/>	<input type="checkbox"/>	<input type="checkbox"/>	<input type="checkbox"/>	<input type="checkbox"/>
	30 x 42"	WBSL3042F	<input type="checkbox"/>	<input type="checkbox"/>	<input type="checkbox"/>	<input type="checkbox"/>	<input type="checkbox"/>	<input type="checkbox"/>	<input type="checkbox"/>	<input type="checkbox"/>	<input type="checkbox"/>	<input type="checkbox"/>	<input type="checkbox"/>	<input type="checkbox"/>
	30 x 48"	WBSL3048F	<input type="checkbox"/>	<input type="checkbox"/>	<input type="checkbox"/>	<input type="checkbox"/>	<input type="checkbox"/>	<input type="checkbox"/>	<input type="checkbox"/>	<input type="checkbox"/>	<input type="checkbox"/>	<input type="checkbox"/>	<input type="checkbox"/>	<input type="checkbox"/>
	30 x 54"	WBSL3054F	<input type="checkbox"/>	<input type="checkbox"/>	<input type="checkbox"/>	<input type="checkbox"/>	<input type="checkbox"/>	<input type="checkbox"/>	<input type="checkbox"/>	<input type="checkbox"/>	<input type="checkbox"/>	<input type="checkbox"/>	<input type="checkbox"/>	<input type="checkbox"/>
	30 x 60"	WBSL3060F	<input type="checkbox"/>	<input type="checkbox"/>	<input type="checkbox"/>	<input type="checkbox"/>	<input type="checkbox"/>	<input type="checkbox"/>	<input type="checkbox"/>	<input type="checkbox"/>	<input type="checkbox"/>	<input type="checkbox"/>	<input type="checkbox"/>	<input type="checkbox"/>
	30 x 66"	WBSL3066F	<input type="checkbox"/>	<input type="checkbox"/>	<input type="checkbox"/>	<input type="checkbox"/>	<input type="checkbox"/>	<input type="checkbox"/>	<input type="checkbox"/>	<input type="checkbox"/>	<input type="checkbox"/>	<input type="checkbox"/>	<input type="checkbox"/>	<input type="checkbox"/>
	30 x 72"	WBSL3072F	<input type="checkbox"/>	<input type="checkbox"/>	<input type="checkbox"/>	<input type="checkbox"/>	<input type="checkbox"/>	<input type="checkbox"/>	<input type="checkbox"/>	<input type="checkbox"/>	<input type="checkbox"/>	<input type="checkbox"/>	<input type="checkbox"/>	<input type="checkbox"/>
		A	B	C	D	E	F	G	H	I	J	K	L	M

HOW TO ORDER

Indicate the following information on order form:

- Quantity of each item.
- Model number, including options. See "How To Build a Model Number".
- Any special service required.

Note:

- The indicates that a choice is required.
- The absence of the indicates that no choice is required.
- Alpha-numeric characters in place of indicate that no other alternatives are available.

HOW TO BUILD A MODEL NUMBER

- A** Select basic model.
- B** Select edge style.
 - 74P** - 74P edge
 - EP** - Elliptical postformed edge
 - PF** - Postformed edge
- C** Select PowerUp® module location.
 - PUN** - No module
 - PUL** - Left module; add \$108
 - PUR** - Right module; add \$108
 - PUC** - Center module; add \$108
 - PUB** - Both left and right modules; add \$217
 PUB option only available on 60", 66" and 72" wide worksurfaces.
- D** Select wire trough.
 - Add upcharge to unit price for WT option.
 - NT** - No wire trough
 - WT** - Wire trough
 Available in black only.

- E** Select electrical option.
 - Add upcharge to unit price for T6 option.
 - NP** - No power
 - T6** - T6 power
 If T6 power is specified, receptacles, jumpers and infeeds are to be specified separately.
- F** Select frame style.
 - Add upcharge to unit price for WF option.
 - WM** - w/ Modesty panel
 - WF** - w/ Full modesty panel
- G** Select grommet option.
 - Overhead cabinet can NOT be ordered.
 - OGN** - No worksurface grommet
 - OGY** - Yes worksurface grommet
 Grommets can be used for wire pass-through.
- H** Select paint color.
 - Refer to color addendum at ki.com or KI Fabrics & Finishes binder.
- I** Select insert color.

- Refer to color addendum at ki.com or KI Fabrics & Finishes binder.
- J** Select laminate surface.
 - Refer to color addendum at ki.com or KI Fabrics & Finishes binder.
- K** Select edge color.
 - Refer to color addendum at ki.com or KI Fabrics & Finishes binder.
 - Edge color offerings are based on edge style selections.
- L** Select grommet color.
 - Refer to color addendum at ki.com or KI Fabrics & Finishes binder.
- M** Select PowerUp® module color.
 - Refer to color addendum at ki.com or KI Fabrics & Finishes binder.

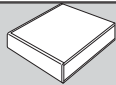

Approx. Packaged Weight	74P Edge (74P)	Elliptical Postformed Edge (EP)	Postformed Edge (PF)	Wire Trough add to list price	T6 add to list price	Full Modesty Panel add to list price
79.0#	\$ 549	\$ 577	\$ 606	\$ 203	\$ 146	\$ 47
86.0#	569	596	626	218	150	57
95.0#	588	616	650	231	161	67
103.0#	610	646	679	237	167	77
109.0#	630	663	697	252	173	83
116.0#	653	688	721	264	385	94
123.0#	679	711	749	271	399	122
129.0#	700	742	779	275	411	131
69.0#	\$ 549	\$ 577	\$ 606	\$ 203	\$ 146	\$ 47
76.0#	569	596	626	218	150	57
85.0#	588	616	650	231	161	67
93.0#	610	646	679	237	167	77
99.0#	630	663	697	252	173	83
106.0#	653	688	721	264	385	94
113.0#	679	711	749	271	399	122
119.0#	700	742	779	275	411	131
68.0#	\$ 549	\$ 577	\$ 606	\$ 203	\$ 146	\$ 47
75.0#	569	596	626	218	150	57
84.0#	588	616	650	231	161	67
92.0#	610	646	679	237	167	77
98.0#	630	663	697	252	173	83
105.0#	653	688	721	264	385	94
112.0#	679	711	749	271	399	122
118.0#	700	742	779	275	411	131

FINISH INFORMATION

Additional Laminate Offering

Additional laminates beyond KI standard offering, are available with two weeks extended leadtime. To specify additional laminates, use these designators followed by the supplier's color/pattern code:

- Formica - LF/supplier's color pattern code
- Nevamar - LN/supplier's color pattern code
- Wilsonart - LW/supplier's color pattern code

KI's standard finish is the supplier's recommended finish for that color/pattern.

Note: Nonstandard laminates from these suppliers (example: textured laminates), require an upcharge and additional leadtime. Contact KI.

SPECIAL SERVICES

Special Carton Marking

With specially marked information N/C

Shipping

Shipped k.d. freight prepaid f.o.b. Manitowoc, Wisconsin 54220 factory. Freight class #70.

Specifications and prices are subject to change without prior notice.

WorkZone® Shared Leg with Laptop Garage®

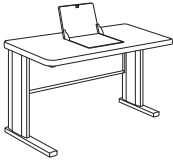
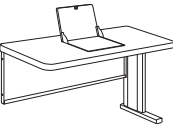
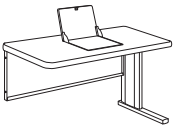
	D x W	MODEL NUMBER												
		Basic Model	Edge Style	PowerUp Module	W-Trgh	Laptop Option	Lock Opt	Frame Style	Grom	Paint Clr	Insr Clr	Lam Clr	Edge Clr	Grm Clr
 WZLG 24" Starter - One Laptop Garage®	24 x 30"	WBLG2430S	<input type="checkbox"/>	PUN	NT	<input type="checkbox"/>	<input type="checkbox"/>	<input type="checkbox"/>	<input type="checkbox"/>	<input type="checkbox"/>	<input type="checkbox"/>	<input type="checkbox"/>	<input type="checkbox"/>	<input type="checkbox"/>
	24 x 36"	WBLG2436S	<input type="checkbox"/>	PUN	NT	<input type="checkbox"/>	<input type="checkbox"/>	<input type="checkbox"/>	<input type="checkbox"/>	<input type="checkbox"/>	<input type="checkbox"/>	<input type="checkbox"/>	<input type="checkbox"/>	<input type="checkbox"/>
	24 x 42"	WBLG2442S	<input type="checkbox"/>	PUN	NT	<input type="checkbox"/>	<input type="checkbox"/>	<input type="checkbox"/>	<input type="checkbox"/>	<input type="checkbox"/>	<input type="checkbox"/>	<input type="checkbox"/>	<input type="checkbox"/>	<input type="checkbox"/>
	24 x 48"	WBLG2448S	<input type="checkbox"/>	PUN	NT	<input type="checkbox"/>	<input type="checkbox"/>	<input type="checkbox"/>	<input type="checkbox"/>	<input type="checkbox"/>	<input type="checkbox"/>	<input type="checkbox"/>	<input type="checkbox"/>	<input type="checkbox"/>
	24 x 54"	WBLG2454S	<input type="checkbox"/>	PUN	NT	<input type="checkbox"/>	<input type="checkbox"/>	<input type="checkbox"/>	<input type="checkbox"/>	<input type="checkbox"/>	<input type="checkbox"/>	<input type="checkbox"/>	<input type="checkbox"/>	<input type="checkbox"/>
 WZLG 24" Adder - One Laptop Garage®	24 x 30"	WBLG2430A	<input type="checkbox"/>	PUN	NT	<input type="checkbox"/>	<input type="checkbox"/>	<input type="checkbox"/>	<input type="checkbox"/>	<input type="checkbox"/>	<input type="checkbox"/>	<input type="checkbox"/>	<input type="checkbox"/>	<input type="checkbox"/>
	24 x 36"	WBLG2436A	<input type="checkbox"/>	PUN	NT	<input type="checkbox"/>	<input type="checkbox"/>	<input type="checkbox"/>	<input type="checkbox"/>	<input type="checkbox"/>	<input type="checkbox"/>	<input type="checkbox"/>	<input type="checkbox"/>	<input type="checkbox"/>
	24 x 42"	WBLG2442A	<input type="checkbox"/>	PUN	NT	<input type="checkbox"/>	<input type="checkbox"/>	<input type="checkbox"/>	<input type="checkbox"/>	<input type="checkbox"/>	<input type="checkbox"/>	<input type="checkbox"/>	<input type="checkbox"/>	<input type="checkbox"/>
	24 x 48"	WBLG2448A	<input type="checkbox"/>	PUN	NT	<input type="checkbox"/>	<input type="checkbox"/>	<input type="checkbox"/>	<input type="checkbox"/>	<input type="checkbox"/>	<input type="checkbox"/>	<input type="checkbox"/>	<input type="checkbox"/>	<input type="checkbox"/>
	24 x 54"	WBLG2454A	<input type="checkbox"/>	PUN	NT	<input type="checkbox"/>	<input type="checkbox"/>	<input type="checkbox"/>	<input type="checkbox"/>	<input type="checkbox"/>	<input type="checkbox"/>	<input type="checkbox"/>	<input type="checkbox"/>	<input type="checkbox"/>
 WZLG 24" Finisher - One Laptop Garage®	24 x 30"	WBLG2430F	<input type="checkbox"/>	PUN	NT	<input type="checkbox"/>	<input type="checkbox"/>	<input type="checkbox"/>	<input type="checkbox"/>	<input type="checkbox"/>	<input type="checkbox"/>	<input type="checkbox"/>	<input type="checkbox"/>	<input type="checkbox"/>
	24 x 36"	WBLG2436F	<input type="checkbox"/>	PUN	NT	<input type="checkbox"/>	<input type="checkbox"/>	<input type="checkbox"/>	<input type="checkbox"/>	<input type="checkbox"/>	<input type="checkbox"/>	<input type="checkbox"/>	<input type="checkbox"/>	<input type="checkbox"/>
	24 x 42"	WBLG2442F	<input type="checkbox"/>	PUN	NT	<input type="checkbox"/>	<input type="checkbox"/>	<input type="checkbox"/>	<input type="checkbox"/>	<input type="checkbox"/>	<input type="checkbox"/>	<input type="checkbox"/>	<input type="checkbox"/>	<input type="checkbox"/>
	24 x 48"	WBLG2448F	<input type="checkbox"/>	PUN	NT	<input type="checkbox"/>	<input type="checkbox"/>	<input type="checkbox"/>	<input type="checkbox"/>	<input type="checkbox"/>	<input type="checkbox"/>	<input type="checkbox"/>	<input type="checkbox"/>	<input type="checkbox"/>
	24 x 54"	WBLG2454F	<input type="checkbox"/>	PUN	NT	<input type="checkbox"/>	<input type="checkbox"/>	<input type="checkbox"/>	<input type="checkbox"/>	<input type="checkbox"/>	<input type="checkbox"/>	<input type="checkbox"/>	<input type="checkbox"/>	<input type="checkbox"/>

A B C D E F G H I J K L M

HOW TO ORDER

Indicate the following information on order form:

- Quantity of each item.
- Model number, including options. See "How To Build a Model Number".
- Any special service required.

Note: • The indicates that a choice is required.

- The absence of the indicates that no choice is required.
- Alpha-numeric characters in place of indicate that no other alternatives are available.

HOW TO BUILD A MODEL NUMBER

- A** Select basic model.
- B** Select edge style.
 - 74P - 74P edge
 - EP - Elliptical postformed edge
 - PF - Postformed edge
- C** Select PowerUp® module location.
 - PUN - No module
- D** Select wire trough.
 - NT - No wire trough
- E** Select Laptop Garage quantity/size.
 - 115 - One 15" Laptop Garage
 - 117 - One 17" Laptop Garage; add \$26
- F** Select lock option.
 - Add upcharge to unit price for (LK) option.
 - NL - No lock (standard)
 - LK - With lock

- G** Select frame style.
 - Add upcharge to unit price for WF option.
 - WM - w/ Modesty panel
 - WF - w/ Full modesty panel
- H** Select grommet option.
 - Overhead cabinet can NOT be ordered.
 - OGN - No worksurface grommet
 - OGY - Yes worksurface grommet
 - Grommets can be used for wire pass-through.
- I** Select paint color.
 - Refer to color addendum at ki.com or KI Fabrics & Finishes binder.
- J** Select insert color.
 - Refer to color addendum at ki.com or KI Fabrics & Finishes binder.
- K** Select laminate surface.
 - Refer to color addendum at ki.com or KI Fabrics & Finishes binder.
- L** Select edge color.

Refer to color addendum at ki.com or KI Fabrics & Finishes binder. Edge color offerings are based on edge style selections.

- M** Select grommet color.
 - Refer to color addendum at ki.com or KI Fabrics & Finishes binder.



WorkZone® Shared Leg with Laptop Garage®

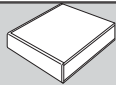

Approx. Packaged Weight

74P Edge (74P)

Elliptical Postformed Edge (EP)

Postformed Edge (PF)

Full Modesty Panel add to list price

Lock Option Add to list price

85.0#	\$ 1251	\$ 1278	\$ 1307	\$ 47	\$ 193
92.0#	1274	1303	1333	57	193
99.0#	1294	1321	1353	67	193
105.0#	1311	1343	1377	77	193
112.0#	1338	1372	1407	83	193

75.0#	\$ 1251	\$ 1278	\$ 1307	\$ 47	\$ 193
82.0#	1274	1303	1333	57	193
89.0#	1294	1321	1353	67	193
95.0#	1311	1343	1377	77	193
102.0#	1338	1372	1407	83	193

74.0#	\$ 1251	\$ 1278	\$ 1307	\$ 47	\$ 193
81.0#	1274	1303	1333	57	193
88.0#	1294	1321	1353	67	193
94.0#	1311	1343	1377	77	193
101.0#	1338	1372	1407	83	193

FINISH INFORMATION

Additional Laminate Offering

Additional laminates beyond KI standard offering, are available with two weeks extended leadtime. To specify additional laminates, use these designators followed by the supplier's color/pattern code:

- Formica - LF/supplier's color pattern code
- Nevamar - LN/supplier's color pattern code
- Wilsonart - LW/supplier's color pattern code

KI's standard finish is the supplier's recommended finish for that color/pattern.

Note: Nonstandard laminates from these suppliers (example: textured laminates), require an upcharge and additional leadtime. Contact KI.

SPECIAL SERVICES

Special Carton Marking

With specially marked information N/C

Shipping

Shipped k.d. freight prepaid f.o.b. Manitowoc, Wisconsin 54220 factory. Freight class #70.

Specifications and prices are subject to change without prior notice.

WorkZone® Shared Leg with Laptop Garage®

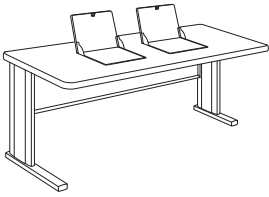
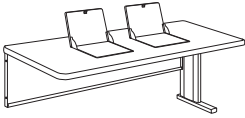
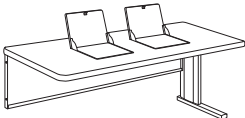
		MODEL NUMBER													
		Basic Model	Edge Style	PowerUp Module	W-Trgh	Laptop Option	Lock Opt	Frame Style	Grom	Paint Clr	Insrt Clr	Lam Clr	Edge Clr	Grm Clr	
 <p>WZLG 24" Starter - Two Laptop Garage® Units</p>	24 x 60"	WBLG2460S	<input type="checkbox"/>	PUN	NT	<input type="checkbox"/>	<input type="checkbox"/>	<input type="checkbox"/>	<input type="checkbox"/>	<input type="checkbox"/>	<input type="checkbox"/>	<input type="checkbox"/>	<input type="checkbox"/>	<input type="checkbox"/>	
	24 x 66"	WBLG2466S	<input type="checkbox"/>	PUN	NT	<input type="checkbox"/>	<input type="checkbox"/>	<input type="checkbox"/>	<input type="checkbox"/>	<input type="checkbox"/>	<input type="checkbox"/>	<input type="checkbox"/>	<input type="checkbox"/>	<input type="checkbox"/>	
	24 x 72"	WBLG2472S	<input type="checkbox"/>	PUN	NT	<input type="checkbox"/>	<input type="checkbox"/>	<input type="checkbox"/>	<input type="checkbox"/>	<input type="checkbox"/>	<input type="checkbox"/>	<input type="checkbox"/>	<input type="checkbox"/>	<input type="checkbox"/>	
 <p>WZLG 24" Adder - Two Laptop Garage® Units</p>	24 x 60"	WBLG2460A	<input type="checkbox"/>	PUN	NT	<input type="checkbox"/>	<input type="checkbox"/>	<input type="checkbox"/>	<input type="checkbox"/>	<input type="checkbox"/>	<input type="checkbox"/>	<input type="checkbox"/>	<input type="checkbox"/>	<input type="checkbox"/>	
	24 x 66"	WBLG2466A	<input type="checkbox"/>	PUN	NT	<input type="checkbox"/>	<input type="checkbox"/>	<input type="checkbox"/>	<input type="checkbox"/>	<input type="checkbox"/>	<input type="checkbox"/>	<input type="checkbox"/>	<input type="checkbox"/>	<input type="checkbox"/>	
	24 x 72"	WBLG2472A	<input type="checkbox"/>	PUN	NT	<input type="checkbox"/>	<input type="checkbox"/>	<input type="checkbox"/>	<input type="checkbox"/>	<input type="checkbox"/>	<input type="checkbox"/>	<input type="checkbox"/>	<input type="checkbox"/>	<input type="checkbox"/>	
 <p>WZLG 24" Finisher - Two Laptop Garage® Units</p>	24 x 60"	WBLG2460F	<input type="checkbox"/>	PUN	NT	<input type="checkbox"/>	<input type="checkbox"/>	<input type="checkbox"/>	<input type="checkbox"/>	<input type="checkbox"/>	<input type="checkbox"/>	<input type="checkbox"/>	<input type="checkbox"/>	<input type="checkbox"/>	
	24 x 66"	WBLG2466F	<input type="checkbox"/>	PUN	NT	<input type="checkbox"/>	<input type="checkbox"/>	<input type="checkbox"/>	<input type="checkbox"/>	<input type="checkbox"/>	<input type="checkbox"/>	<input type="checkbox"/>	<input type="checkbox"/>	<input type="checkbox"/>	
	24 x 72"	WBLG2472F	<input type="checkbox"/>	PUN	NT	<input type="checkbox"/>	<input type="checkbox"/>	<input type="checkbox"/>	<input type="checkbox"/>	<input type="checkbox"/>	<input type="checkbox"/>	<input type="checkbox"/>	<input type="checkbox"/>	<input type="checkbox"/>	
			A	B	C	D	E	F	G	H	I	J	K	L	M

HOW TO ORDER

Indicate the following information on order form:

- Quantity of each item.
- Model number, including options. See "How To Build a Model Number".
- Any special service required.

Note: • The indicates that a choice is required.

- The absence of the indicates that no choice is required.
- Alpha-numeric characters in place of indicate that no other alternatives are available.

HOW TO BUILD A MODEL NUMBER

- A** Select basic model.
- B** Select edge style.
 - 74P - 74P edge
 - EP - Elliptical postformed edge
 - PF - Postformed edge
- C** Select PowerUp® module location.
 - PUN - No module
- D** Select wire trough.
 - NT - No wire trough
- E** Select Laptop Garage quantity/size.
 - 215 - Two 15" Laptop Garages
 - 217 - Two 17" Laptop Garages; add \$50
- F** Select lock option.
 - Add upcharge to unit price for (LK) option.
 - NL - No lock (standard)
 - LK - With lock

- G** Select frame style.
 - Add upcharge to unit price for WF option.
 - WM - w/ Modesty panel
 - WF - w/ Full modesty panel
- H** Select grommet option.
 - Overhead cabinet can NOT be ordered.
 - OGN - No worksurface grommet
 - OGY - Yes worksurface grommet
 - Grommets can be used for wire pass-through.
- I** Select paint color.
 - Refer to color addendum at ki.com or KI Fabrics & Finishes binder.
- J** Select insert color.
 - Refer to color addendum at ki.com or KI Fabrics & Finishes binder.
- K** Select laminate surface.
 - Refer to color addendum at ki.com or KI Fabrics & Finishes binder.
- L** Select edge color.

Refer to color addendum at ki.com or KI Fabrics & Finishes binder. Edge color offerings are based on edge style selections.

- M** Select grommet color.
 - Refer to color addendum at ki.com or KI Fabrics & Finishes binder.



WorkZone® Shared Leg with Laptop Garage®

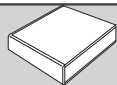

Approx. Packaged Weight

74P Edge (74P)

Elliptical Postformed Edge (EP)

Postformed Edge (PF)

Full Modesty Panel add to list price

Lock Option Add to list price

133.0#	\$ 2049	\$ 2082	\$ 2118	\$ 94	\$ 259
141.0#	2069	2102	2137	122	259
147.0#	2094	2128	2168	131	259

123.0#	\$ 2049	\$ 2082	\$ 2118	\$ 94	\$ 259
131.0#	2069	2102	2137	122	259
137.0#	2094	2128	2168	131	259

122.0#	\$ 2049	\$ 2082	\$ 2118	\$ 94	\$ 259
130.0#	2069	2102	2137	122	259
136.0#	2094	2128	2168	131	259

FINISH INFORMATION

Additional Laminate Offering

Additional laminates beyond KI standard offering, are available with two weeks extended leadtime. To specify additional laminates, use these designators followed by the supplier's color/pattern code:

- Formica - LF/supplier's color pattern code
- Nevamar - LN/supplier's color pattern code
- Wilsonart - LW/supplier's color pattern code

KI's standard finish is the supplier's recommended finish for that color/pattern.

Note: Nonstandard laminates from these suppliers (example: textured laminates), require an upcharge and additional leadtime. Contact KI.

SPECIAL SERVICES

Special Carton Marking



With specially marked information N/C

Shipping

Shipped k.d. freight prepaid f.o.b. Manitowoc, Wisconsin 54220 factory. Freight class #70.

Specifications and prices are subject to change without prior notice.

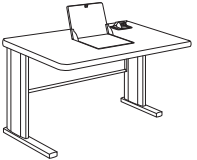
WorkZone® Shared Leg with Laptop Garage®

		MODEL NUMBER														
		Basic Model	Edge Style	P-Up Mod	W-Trgh	Elct Opt	Laptop Option	Lock Opt	Frame Style	Grom	Paint Clr	Insrt Clr	Lam Clr	Edge Clr	Grm Clr	PowerUp Module Color
D x W																
	30 x 30"	WBLG3030S	<input type="checkbox"/>	<input type="checkbox"/>	<input type="checkbox"/>	<input type="checkbox"/>	<input type="checkbox"/>	<input type="checkbox"/>	<input type="checkbox"/>	<input type="checkbox"/>						
	30 x 36"	WBLG3036S	<input type="checkbox"/>	<input type="checkbox"/>	<input type="checkbox"/>	<input type="checkbox"/>	<input type="checkbox"/>	<input type="checkbox"/>	<input type="checkbox"/>	<input type="checkbox"/>						
	30 x 42"	WBLG3042S	<input type="checkbox"/>	<input type="checkbox"/>	<input type="checkbox"/>	<input type="checkbox"/>	<input type="checkbox"/>	<input type="checkbox"/>	<input type="checkbox"/>	<input type="checkbox"/>						
	30 x 48"	WBLG3048S	<input type="checkbox"/>	<input type="checkbox"/>	<input type="checkbox"/>	<input type="checkbox"/>	<input type="checkbox"/>	<input type="checkbox"/>	<input type="checkbox"/>	<input type="checkbox"/>						
	30 x 54"	WBLG3054S	<input type="checkbox"/>	<input type="checkbox"/>	<input type="checkbox"/>	<input type="checkbox"/>	<input type="checkbox"/>	<input type="checkbox"/>	<input type="checkbox"/>	<input type="checkbox"/>						
WZLG 30" Starter - One Laptop Garage® • Remote must be specified separately if lock is selected																
	30 x 30"	WBLG3030A	<input type="checkbox"/>	<input type="checkbox"/>	<input type="checkbox"/>	<input type="checkbox"/>	<input type="checkbox"/>	<input type="checkbox"/>	<input type="checkbox"/>	<input type="checkbox"/>						
	30 x 36"	WBLG3036A	<input type="checkbox"/>	<input type="checkbox"/>	<input type="checkbox"/>	<input type="checkbox"/>	<input type="checkbox"/>	<input type="checkbox"/>	<input type="checkbox"/>	<input type="checkbox"/>						
	30 x 42"	WBLG3042A	<input type="checkbox"/>	<input type="checkbox"/>	<input type="checkbox"/>	<input type="checkbox"/>	<input type="checkbox"/>	<input type="checkbox"/>	<input type="checkbox"/>	<input type="checkbox"/>						
	30 x 48"	WBLG3048A	<input type="checkbox"/>	<input type="checkbox"/>	<input type="checkbox"/>	<input type="checkbox"/>	<input type="checkbox"/>	<input type="checkbox"/>	<input type="checkbox"/>	<input type="checkbox"/>						
	30 x 54"	WBLG3054A	<input type="checkbox"/>	<input type="checkbox"/>	<input type="checkbox"/>	<input type="checkbox"/>	<input type="checkbox"/>	<input type="checkbox"/>	<input type="checkbox"/>	<input type="checkbox"/>						
WZLG 30" Adder - One Laptop Garage® • Remote must be specified separately if lock is selected																
	30 x 30"	WBLG3030F	<input type="checkbox"/>	<input type="checkbox"/>	<input type="checkbox"/>	<input type="checkbox"/>	<input type="checkbox"/>	<input type="checkbox"/>	<input type="checkbox"/>	<input type="checkbox"/>						
	30 x 36"	WBLG3036F	<input type="checkbox"/>	<input type="checkbox"/>	<input type="checkbox"/>	<input type="checkbox"/>	<input type="checkbox"/>	<input type="checkbox"/>	<input type="checkbox"/>	<input type="checkbox"/>						
	30 x 42"	WBLG3042F	<input type="checkbox"/>	<input type="checkbox"/>	<input type="checkbox"/>	<input type="checkbox"/>	<input type="checkbox"/>	<input type="checkbox"/>	<input type="checkbox"/>	<input type="checkbox"/>						
	30 x 48"	WBLG3048F	<input type="checkbox"/>	<input type="checkbox"/>	<input type="checkbox"/>	<input type="checkbox"/>	<input type="checkbox"/>	<input type="checkbox"/>	<input type="checkbox"/>	<input type="checkbox"/>						
	30 x 54"	WBLG3054F	<input type="checkbox"/>	<input type="checkbox"/>	<input type="checkbox"/>	<input type="checkbox"/>	<input type="checkbox"/>	<input type="checkbox"/>	<input type="checkbox"/>	<input type="checkbox"/>						
WZLG 30" Finisher - One Laptop Garage® • Remote must be specified separately if lock is selected																
		A	B	C	D	E	F	G	H	I	J	K	L	M	N	O

HOW TO ORDER

Indicate the following information on order form:

- Quantity of each item.
- Model number, including options. See "How To Build a Model Number".
- Any special service required.

Note: • The indicates that a choice is required.
 • The absence of the indicates that no choice is required.
 • Alpha-numeric characters in place of indicate that no other alternatives are available.

HOW TO BUILD A MODEL NUMBER

- A** Select basic model.
- B** Select edge style.
74P - 74P edge
EP - Elliptical postformed edge
PF - Postformed edge
- C** Select PowerUp® module location.
PUN - No module
PUL - Left module; add \$108
PUR - Right module; add \$108
PUC - Center module; add \$108
 PUB option only available on 60", 66" and 72" wide worksurfaces.
- D** Select wire trough.
 Add upcharge to unit price for WT option.
NT - No wire trough
WT - Wire trough
 Available in black only.
- E** Select electrical option.
 Add upcharge to unit price for T6 option.

- NP** - No power
T6 - T6 power
 If T6 power is specified, receptacles, jumpers and infeeds are to be specified separately
- F** Select Laptop Garage quantity/size.
115 - One 15" Laptop Garage
117 - One 17" Laptop Garage; add \$26
- G** Select lock option.
 Add upcharge to unit price for (LK) option.
NL - No lock (standard)
LK - With lock
- H** Select frame style.
 Add upcharge to unit price for WF option.
WM - w/ Modesty panel
WF - w/ Full modesty panel
- I** Select grommet option.
 Overhead cabinet can NOT be ordered.
OGN - No worksurface grommet
OGY - Yes worksurface grommet

Grommets can be used for wire pass-through.

- J** Select paint color.
 Refer to color addendum at ki.com or KI Fabrics & Finishes binder.
- K** Select insert color.
 Refer to color addendum at ki.com or KI Fabrics & Finishes binder.
- L** Select laminate surface.
 Refer to color addendum at ki.com or KI Fabrics & Finishes binder.
- M** Select edge color.
 Refer to color addendum at ki.com or KI Fabrics & Finishes binder.
 Edge color offerings are based on edge style selections.
- N** Select grommet color.
 Refer to color addendum at ki.com or KI Fabrics & Finishes binder.



WorkZone® Shared Leg with Laptop Garage®

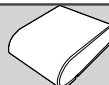
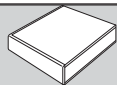

Approx. Packaged Weight	74P Edge (74P)	Elliptical Postformed Edge (EP)	Postformed Edge (PF)	Wire Trough add to list price	T6 add to list price	Full Modesty Panel add to list price	Lock Option Add to list price
94.0#	\$ 1207	\$ 1238	\$ 1267	\$ 203	\$ 146	\$ 47	\$ 193
101.0#	1230	1255	1284	218	150	57	193
110.0#	1246	1275	1309	231	161	67	193
118.0#	1272	1304	1338	237	167	77	193
124.0#	1290	1323	1358	252	173	83	193

84.0#	\$ 1207	\$ 1238	\$ 1267	\$ 203	\$ 146	\$ 47	\$ 193
91.0#	1230	1255	1284	218	150	57	193
100.0#	1246	1275	1309	231	161	67	193
108.0#	1272	1304	1338	237	167	77	193
114.0#	1290	1323	1358	252	173	83	193

83.0#	\$ 1207	\$ 1238	\$ 1267	\$ 203	\$ 146	\$ 47	\$ 193
90.0#	1230	1255	1284	218	150	57	193
99.0#	1246	1275	1309	231	161	67	193
107.0#	1272	1304	1338	237	167	77	193
113.0#	1290	1323	1358	252	173	83	193

① Select PowerUp® module color. Refer to color addendum at ki.com or KI Fabrics & Finishes binder.

FINISH INFORMATION

Additional Laminate Offering

Additional laminates beyond KI standard offering, are available with two weeks extended leadtime. To specify additional laminates, use these designators followed by the supplier's color/pattern code:

Formica - LF/supplier's color pattern code
Nevamar - LN/supplier's color pattern code
Wilsonart - LW/supplier's color pattern code

KI's standard finish is the supplier's recommended finish for that color/pattern.

Note: Nonstandard laminates from these suppliers (example: textured laminates), require an upcharge and additional leadtime. Contact KI.

SPECIAL SERVICES

Special Carton Marking

With specially marked information N/C

Shipping

Shipped k.d. freight prepaid f.o.b. Manitowoc, Wisconsin 54220 factory. Freight class #70.

Specifications and prices are subject to change without prior notice.

WorkZone® Shared Leg with Laptop Garage®

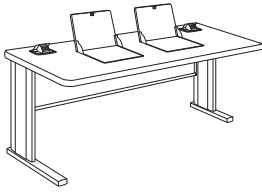
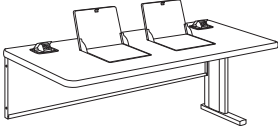
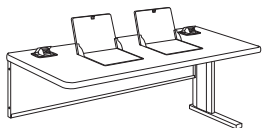
	D x W	MODEL NUMBER														PowerUp Module Color	
		Basic Model	Edge Style	P-Up Mod	W-Trgh	Elct Opt	Laptop Option	Lock Opt	Frame Style	Grom	Paint Clr	Insrt Clr	Lam Clr	Edge Clr	Grm Clr		
 <p>WZLG 30" Starter - Two Laptop Garage® Units</p> <p>• Remote must be specified separately if lock is selected</p>	30 x 60"	WBLG3060S	<input type="checkbox"/>	<input type="checkbox"/>	<input type="checkbox"/>	<input type="checkbox"/>	<input type="checkbox"/>	<input type="checkbox"/>	<input type="checkbox"/>	<input type="checkbox"/>							
	30 x 66"	WBLG3066S	<input type="checkbox"/>	<input type="checkbox"/>	<input type="checkbox"/>	<input type="checkbox"/>	<input type="checkbox"/>	<input type="checkbox"/>	<input type="checkbox"/>	<input type="checkbox"/>							
	30 x 72"	WBLG3072S	<input type="checkbox"/>	<input type="checkbox"/>	<input type="checkbox"/>	<input type="checkbox"/>	<input type="checkbox"/>	<input type="checkbox"/>	<input type="checkbox"/>	<input type="checkbox"/>							
 <p>WZLG 30" Adder - Two Laptop Garage® Units</p> <p>• Remote must be specified separately if lock is selected</p>	30 x 60"	WBLG3060A	<input type="checkbox"/>	<input type="checkbox"/>	<input type="checkbox"/>	<input type="checkbox"/>	<input type="checkbox"/>	<input type="checkbox"/>	<input type="checkbox"/>	<input type="checkbox"/>							
	30 x 66"	WBLG3066A	<input type="checkbox"/>	<input type="checkbox"/>	<input type="checkbox"/>	<input type="checkbox"/>	<input type="checkbox"/>	<input type="checkbox"/>	<input type="checkbox"/>	<input type="checkbox"/>							
	30 x 72"	WBLG3072A	<input type="checkbox"/>	<input type="checkbox"/>	<input type="checkbox"/>	<input type="checkbox"/>	<input type="checkbox"/>	<input type="checkbox"/>	<input type="checkbox"/>	<input type="checkbox"/>							
 <p>WZLG 30" Finisher - Two Laptop Garage® Units</p> <p>• Remote must be specified separately if lock is selected</p>	30 x 60"	WBLG3060F	<input type="checkbox"/>	<input type="checkbox"/>	<input type="checkbox"/>	<input type="checkbox"/>	<input type="checkbox"/>	<input type="checkbox"/>	<input type="checkbox"/>	<input type="checkbox"/>							
	30 x 66"	WBLG3066F	<input type="checkbox"/>	<input type="checkbox"/>	<input type="checkbox"/>	<input type="checkbox"/>	<input type="checkbox"/>	<input type="checkbox"/>	<input type="checkbox"/>	<input type="checkbox"/>							
	30 x 72"	WBLG3072F	<input type="checkbox"/>	<input type="checkbox"/>	<input type="checkbox"/>	<input type="checkbox"/>	<input type="checkbox"/>	<input type="checkbox"/>	<input type="checkbox"/>	<input type="checkbox"/>							
			A	B	C	D	E	F	G	H	I	J	K	L	M	N	O

HOW TO ORDER

Indicate the following information on order form:

- Quantity of each item.
- Model number, including options. See "How To Build a Model Number".
- Any special service required.

Note: • The indicates that a choice is required.
 • The absence of the indicates that no choice is required.
 • Alpha-numeric characters in place of indicate that no other alternatives are available.

HOW TO BUILD A MODEL NUMBER

- A** Select basic model.
- B** Select edge style.
74P - 74P edge
EP - Elliptical postformed edge
PF - Postformed edge
- C** Select PowerUp® module location.
PUN - No module
PUL - Left module; add \$108
PUR - Right module; add \$108
PUC - Center module; add \$108
PUB - Both left and right modules; add \$217
 PUB option only available on 60", 66" and 72" wide worksurfaces.
- D** Select wire trough.
 Add upcharge to unit price for WT option.
NT - No wire trough
WT - Wire trough
 Available in black only.

- E** Select electrical option.
 Add upcharge to unit price for T6 option.
NP - No power
T6 - T6 power
 If T6 power is specified, receptacles, jumpers and infeeds are to be specified separately
- F** Select Laptop Garage quantity/size.
215 - Two 15" Laptop Garages
217 - Two 17" Laptop Garages; add \$50
- G** Select lock option.
 Add upcharge to unit price for (LK) option.
NL - No lock (standard)
LK - With lock
- H** Select frame style.
 Add upcharge to unit price for WF option.
WM - w/ Modesty panel
WF - w/ Full modesty panel
- I** Select grommet option.
 Overhead cabinet can NOT be ordered.

- OGN** - No worksurface grommet
OGY - Yes worksurface grommet
 Grommets can be used for wire pass-through.
- J** Select paint color.
 Refer to color addendum at ki.com or KI Fabrics & Finishes binder.
- K** Select insert color.
 Refer to color addendum at ki.com or KI Fabrics & Finishes binder.
- L** Select laminate surface.
 Refer to color addendum at ki.com or KI Fabrics & Finishes binder.
- M** Select edge color.
 Refer to color addendum at ki.com or KI Fabrics & Finishes binder.
 Edge color offerings are based on edge style selections.
- N** Select grommet color.



WorkZone® Shared Leg with Laptop Garage®

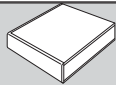

Approx. Packaged Weight	74P Edge (74P)	Elliptical Postformed Edge (EP)	Postformed Edge (PF)	Wire Trough add to list price	T6 add to list price	Full Modesty Panel add to list price	Lock Option Add to list price
146.0#	\$ 1976	\$ 2006	\$ 2040	\$ 264	\$ 385	\$ 94	\$ 259
153.0#	1997	2032	2069	271	399	122	259
159.0#	2022	2060	2097	275	411	131	259

136.0#	\$ 1976	\$ 2006	\$ 2040	\$ 264	\$ 385	\$ 94	\$ 259
143.0#	1997	2032	2069	271	399	122	259
149.0#	2022	2060	2097	275	411	131	259

135.0#	\$ 1976	\$ 2006	\$ 2040	\$ 264	\$ 385	\$ 94	\$ 259
142.0#	1997	2032	2069	271	399	122	259
148.0#	2022	2060	2097	275	411	131	259

Refer to color addendum at ki.com or KI Fabrics & Finishes binder.

O Select PowerUp® module color. Refer to color addendum at ki.com or KI Fabrics & Finishes binder.

FINISH INFORMATION

Additional Laminate Offering

Additional laminates beyond KI standard offering, are available with two weeks extended leadtime. To specify additional laminates, use these designators followed by the supplier's color/pattern code:

Formica - LF/supplier's color pattern code
 Nevamar - LN/supplier's color pattern code
 Wilsonart - LW/supplier's color pattern code

KI's standard finish is the supplier's recommended finish for that color/pattern.

Note: Nonstandard laminates from these suppliers (example: textured laminates), require an upcharge and additional leadtime. Contact KI.

SPECIAL SERVICES

Special Carton Marking

With specially marked information N/C

Shipping

Shipped **k.d. freight prepaid f.o.b. Manitowoc, Wisconsin 54220** factory. Freight class #70.

Specifications and prices are subject to change without prior notice.

WorkZone® Shared Leg with Laptop Garage®

	MODEL	MODEL NUMBER	
		Basic Model	Approx. Packaged Weight
HRDPT	Laptop Lock 1 Unit Control • Locks a single garage • For retrofit onto non-locking units • Remote not included	LTLOCK115	2.0#
		LTLOCK117	2.0#
HRDPT	Laptop Lock 2 Unit Control • Locks two garages • For retrofit onto non-locking units • Remote not included	LTLOCK215	4.0#
		LTLOCK217	4.0#
HRDPT	Laptop Lock Remote • Can order one per room or one per control box • Only five remotes can be programmed per controller box	LTREMOTE	0.1#
HRDPT	Laptop Cable/Lock Keyed Alike	LTSK.L.KA	2.0#

A

HOW TO ORDER

Indicate the following information on order form:

1. Quantity of each item.
2. Model number, including options. See "How To Build a Model Number".
3. Any special service required.

Note: • The indicates that a choice is required.

- The absence of the indicates that no choice is required.
- Alpha-numeric characters in place of indicate that no other alternatives are available.

HOW TO BUILD A MODEL NUMBER

A Select basic model.

INFORMATION

Keyless Remote Locking System
 Not intended to be used with Connect™ System



WorkZone[®] Shared Leg with Laptop Garage[®]

Delivered
Pricing

\$ 217

217

\$ 307

307

\$ 40

\$ 157

SPECIAL SERVICES

Special Carton Marking

With specially marked information N/C

Shipping

Shipped **assembled freight prepaid f.o.b. Bonduel, Wisconsin 54107** factory. Freight class #70.

Specifications and prices are subject to change without prior notice.

Index

Model No.	Description	Page	Model No.	Description	Page
3CMN	Center Drawer: Center Drawer	76	WKBS30481	Basic Workstation Typical: Basic Desk	8
47.0709.30	Electrical: 8-Wire to 10-Wire Adaptor	84	WKBS30482	Basic Workstation Typical: Basic Desk with Overhead	8
87.4624	Accessories and Worksurface Connectors: Worksurface Height Change Connectors	40	WMSC48	Mobile: Mobile Semi-Circle Worksurface	26
AC8IF.108	Activ8® Infeed	86	WMSCPW52	Mobile: Mobile Semi-Circle Worksurface w/notch	26
AC8JP.29	Activ8® Jumper	86	WMT2440	Mobile: Mobile Teardrop Worksurface	26
AC8RPTWZ.12	Activ8® Module and Attachment Bracket	86	WPW2448	Transitional: Peninsula End Worksurface	28
BLCF30/WZ	Balance® Overhead Storage: Balance® Overhead Cabinet with Fabric Upper Door	60	WPW2448S	Transitional: Peninsula Side Mount Worksurface	28
BLCL30/WZ	Balance® Overhead Storage: Balance® Overhead Cabinet with Laminate Upper Door	58	WQRPW24	Transitional: Quarter Round Transitional Surface	32
BLCS30/WZ	Balance® Overhead Storage: Balance® Overhead Cabinet with Solid Color Upper Door	56	WRC244230	Basic: Curvilinear Worksurface	14
BTLT5.24	Balance® Task Lights: Balance® Overhead Task Light	62	WRT2430	Transitional: Rectangle Transitional Surface	30
LTLOCK115	Laptop Lock 1 Unit Control	100	WST2424	Transitional: Square Transitional Surface	30
LTLOCK215	Laptop Lock 2 Unit Control	100	WSU3036	Basic: Stand-up Worksurface	14
LTREMOTE	Laptop Lock Remote	100	WUSS30	Universal Overhead Storage: Universal Shelf	50
LTSK.L.KA	Laptop Cable/Lock Keyed Alike	100	WZ.T6PI.27	Electrical: Floor Infeed (6-Circuit Pre-wired) 6-2-2	82
NSD	Universal Overhead Storage: Universal Shelf	52	WZ.T6RECP.1	Electrical: Duplex Receptacle -10-Wire System 6-2-2	82
PAT	Paper Management: Accessory Tray	74	WZ.T6RECP.4I	Electrical: Isolated Receptacle - 10-Wire System 6-2-2	82
PDS	Paper Management: Diagonal Storage	72	WZ.T6SC18	Electrical: 10-Wire Table-to-Table Connector 6-2-2	84
PLL	Paper Management: Paper Tray	72	WZMP60	Accessories and Worksurface Connectors: Guest Modesty Panel	40
PMTR30	Tool Rail: Tool Rail	70	WZP24	Privacy Screens: Basic Privacy Screen	64
PPC	Paper Management: Pencil Cup	74	WZPC2436	Privacy Screens: Corner Privacy Screen	64
PTC	Paper Management: Telephone Caddy	74	WZPP244860	Basic: Piano Peninsula Worksurface (Right Shown)	20
PVS	Paper Management: Vertical Storage	72	WZPPD244860	Piano Peninsula Worksurface	80
TLT5.24	Universal Tasklights: Universal Overhead Task Light	54	WZPT244860	Basic: "P" Shaped Peninsula Worksurface (Right Shown)	20
WAK2436	Basic: Adjustable Keyboard Pad Worksurface	12	WZPTD244860	"P" Shaped Peninsula Worksurface	80
WBLG2430A	24" Adder - One Laptop Garage®	92	WZSS244860	Basic: Square Shoe Worksurface (Right Shown)	22
WBLG2430F	24" Finisher - One Laptop Garage®	92	WZSSD244860	Square Shoe Worksurface	80
WBLG2430S	24" Starter - One Laptop Garage®	92	WZUF30	Universal Overhead Storage: Universal Overhead Cabinet with Fabric Door	48
WBLG2460A	24" Adder - Two Laptop Garage® Units	94	WZUL30	Universal Overhead Storage: Universal Overhead Cabinet with Laminate Door	46
WBLG2460F	24" Finisher - Two Laptop Garage® Units	94	WZUS30	Universal Overhead Storage: Universal Overhead Cabinet with Steel Door	44
WBLG2460S	24" Starter - Two Laptop Garage® Units	94			
WBLG3030A	30" Adder - One Laptop Garage®	96			
WBLG3030F	30" Finisher - One Laptop Garage®	96			
WBLG3030S	30" Starter - One Laptop Garage®	96			
WBLG3060A	30" Adder - Two Laptop Garage® Units	98			
WBLG3060F	30" Finisher - Two Laptop Garage® Units	98			
WBLG3060S	30" Starter - Two Laptop Garage® Units	98			
WBSL2430A	24" Adder	88			
WBSL2430F	24" Finisher	88			
WBSL2430S	24" Starter	88			
WBSL3030A	30" Adder	90			
WBSL3030F	30" Finisher	90			
WBSL3030S	30" Starter	90			
WBW2430	Basic: Basic Worksurface	10			
WBW24FEP	Accessories and Worksurface Connectors: Full Leg End Panel	40			
WBWD2430	WorkZone® w/Power Worksurface	78			
WBWD2460	WorkZone® w/Power Worksurface	78			
WCC243624	Basic: Stand Alone Corner Curvilinear Worksurface	18			
WCCE2436	Transitional: End-of-Run Curvilinear Surface	38			
WCCT2436	Transitional: Corner Curvilinear Transitional Surface	36			
WCCT244230	Transitional: Corner Curvilinear Transitional Reduction Surface	36			
WCE36	Basic: Conference End Worksurface	24			
WCS2436	Basic: Stand Alone Corner Worksurface	16			
WCSK2442	Basic: Stand Alone Corner Worksurface with Keyboard	16			
WCT2436	Transitional: Corner Transitional Surface	32			
WCT244230	Transitional: Corner Transitional Reduction Surface	34			
WCTK2442	Transitional: Corner Transitional Surface with Keyboard Pad	34			
WER2436	Transitional: End-of-Run Corner Surface	38			





KI
1330 Bellevue Street
P.O. Box 8100
Green Bay, Wisconsin 54308-8100
1-800-424-2432
www.ki.com

KI and Furnishing Knowledge
are registered trademarks
of Krueger International, Inc.

© 2011 KI
All Rights Reserved.
Litho in USA.
Code KI-11490R1/KI/VL/211

Printed using only water-based inks,
including metallics. Please recycle.