

January 3, 2011

Updated February 15, 2017

800-424-2432



Ordering C.O.M., C.O.L., and C.O.V.	
Shipping Location	2
700 Series® Lateral Files and Storage	
General Information	4
700 Series® Curve Lateral Files and Storage	6
700 Series® OF Lateral Files/Storage Cabinets	8
Preconfigured Lateral Files	
700 Series® Drawer Units	12
700 Series® Curve Drawer Units	20
700 Series® Receding Door Units	26
700 Series® End Tab Shelving Units	30
700 Series® Credenza Files	34
700 Series® OF Flush Top No Fronts	36
700 Series® OF Extended Top No Fronts	38
700 Series® OF Flush Top Wood Fronts	40
700 Series® OF Extended Top Laminate Front	42
Preconfigured Multimedia Storage	
700 Series® Cupboard/Lateral	44
700 Series® Curve Cupboard/Lateral	46
700 Series® Bookcase/File	54
700 Series® Curve Bookcase/Lateral File	58
700 Series® Wardrobe Cabinets	62
Preconfigured Locker Units	
700 Series® Cupboard/Bookcase/Markerboard	64
700 Series® Curve Cupboard/Bookcase/Markerboard	72
Preconfigured Storage	
700 Series® Multimedia Storage Cabinets	88
700 Series® Curve Multimedia Storage Cabinets	100
700 Series® OF Flush Top No Fronts	102
700 Series® OF Flush Top Veneer Fronts	104
700 Series® OF Extended Top Laminate Fronts	106
700 Series® Overfile Cabinets	108
Lateral File Accessories	112
Computer Media Accessories	118
Cupboard Accessories	122
700 Series® Custom-Built Lateral Files	
General Information	126
Custom-Built Lateral Files	
700 Series® Shells	130
700 Series® Drawers	146
700 Series® Receding Doors and Shelves	152
700 Series® Shelves	156
Accessories	160
Custom-Built Laminate Tops	
700 Series® Lateral Files	170
700 Series® OF Storage Cabinet	172
700 Series® Bookcases	
General Information	174
700 Series® Curve Bookcases	176
Bookcases	
700 Series® 12" Deep	178
700 Series® Curve 12" Deep	180
700 Series® 15" Deep	184
700 Series® Curve 15" Deep	188
Bookcase Accessories	192
Bookcase Laminate Tops	194
700 Series® Pedestals	
General Information	196
700 Series® Curve Pedestals	198
700 Series® OF Pedestals	200
Pedestals - Mobile and Freestanding	
700 Series®	204
700 Series® Curve	208
700 Series® OF Flush Top No Front	212
700 Series® OF Extended Top No Front	214
700 Series® OF Flush Top Wood Front	216
700 Series® OF Extended Top Laminate Front	218
Pedestals - Hanging	
700 Series®	220
700 Series® Curve	222
700 Series® OF Flush Top No Front	224
700 Series® OF Extended Top No Front	226
700 Series® OF Flush Top Wood Front	228
700 Series® OF Extended Top Laminate Front	230
Pedestals - Worksurface Supporting	
700 Series®	232
700 Series® Curve	234
Pedestal Accessories	236
Pedestal Laminate Tops	242
700 Series® Vertical Files	
General Information	244
Vertical Files	
700 Series® Letter Size Documents	246
700 Series® Legal Size Documents	248
Vertical File Accessories	250
Index	252

Ordering C.O.M., C.O.L., and C.O.V.

Shipping Location

C.O.M. SHIPPING LOCATION



Architectural Walls

Genius Walls MN

Casegoods

Dante Benches AG
Darwin Tackboards MN
Aristotle Tackboards MN

Classroom Furniture

360° Classroom Furniture BW
Dorsal 1090 Chairs GB
Intellect Wave Chairs GB
Learn2 GB

Desking

700 Series Desking KP
Balance Overheads MN
Genesis Desking MN
True Desking KP
Universal Overheads MN
WorkZone Desking MN

Files & Storage

700 Series Pedestal Cushion GB
Connection Zone Pads BW
U-Series Pedestal Cushion GB

Fixed Seating

Concerto Auditorium Seating BW
Single Pedestal Seating GB
Jury Base Seating GB
Hi5 GB
Lancaster Auditorium Seating BW
Sequence Seating GB
University Seating GB

Panel Systems

All Terrain KP
Balance Overheads MN

System 3000 MN
Universal Overheads MN
Wireworks MN
Unite MN

Residence Hall Furniture

RoomScape Furniture MN

Screens

All Terrain KP
Connection Zone BW
True/Volition KP
Genesis KP

Seating

100 Series Folding Chairs BW
300 Series Folding Chairs BW
600 Series Stools BW
700 Series Folding Chairs BW
1000 Series GB
1100 Series Folding Chairs BW
Aerdyn Guest Seating HN
Affina Collection HN
Arissa Lounge HN
Altus Task Chairs TM
Apply Stack Chairs GB
Auditorium Folding Chairs BW
Avail Task Chairs OM
Bantam Guest Seating HN
Boss Design Chairs HN
Cinturon Lounge & Professional Seating HN
Cody Lounge Seating HN
Connection Zone Privacy Booths HN
Doni Collection GB
Dorsal Stack & Tandem Seating GB
Engage Task Chairs & Stools GB
Front Row Seats (Silk Screening) BW
GateOne Public Seating BW
Grazie Seating GB

Hub Modular Lounge Seating HN
Impress Task Chairs OM
Impress Ultra Task Chairs OM
Jessa Lounge Seating HN
Jubi Guest Chair GB
Kismet Task/Guest Chairs & Stools OM
Kurv Benches HN
LaResta Day Beds HN
Lyra Lounge Seating HN
Maestro Stack Chairs GB
Matrix Stack Chairs GB
Medical & Laboratory Stools OM
Mesa Lounge & Task Seating HN
MyWay Seating HN
Neena Benches HN
Opt4 GB
Perry Stack Chairs GB
Perth Multiple & Healthcare Seating HN
Perth II Healthcare Seating HN
Pilot Task Chairs OM
Piretti Stack Chairs GB
Promenade Seating System BW
Rapture Stack Chairs & Stools GB
Ruckus GB
Rose Healthcare BW
Sela Lounge Seating HN
Sift Task Chairs TM
Silhouette Stack Chairs & Stools BW
Soltice Metal Collection HN
Soltice Multiple, Healthcare & Guest HN
Soltice II Healthcare Seating HN
Strive Multiple, Stack & Task GB
Sway BW
Tea Cup Lounge Seating HN
Torsion-on-the-Go! Nesting Chairs GB
Torsion Air Stack and Task Seating GB
Torsion Stack and Task Seating GB
Versa Stack Chairs & Stools GB

KI Manufacturing Sites - Customer's Own Material Shipment Manufacturing Site Addresses

AG
Contact KI at
1-800-424-2432

GB
KI Green Bay
Attn: COM Storage
1687 Westminster Drive - Gate 3
Green Bay, WI 54302

KP
KI Pembroke
Attn: COM Storage
1000 Olympic Dr.
Pembroke, Ontario K8A6X7

MN
KI Manitowoc
Attn: COM Storage
1400 S. 41st St.
Manitowoc, WI 54220

BW
KI Bonduel
Attn: COM Storage
204 West South St.
Bonduel, WI 54107

HN
KI-HN
Attn: COM Storage
217 Feld Avenue
High Point, NC 27263

OM
KI
Attn: COM Storage
1110 S. Mildred Ave.
Ontario, CA 91761

TM
KI Tupelo
2112 South Green St.
Tupelo, MS 38804



Ordering C.O.M., C.O.L., and C.O.V.
Shipping Location



700 Series® Lateral Files and Storage

General Information

GENERAL INFORMATION

KI 700 Series lateral files are designed on a 1 1/2" module to provide an unparalleled degree of internal flexibility. Interior components are available 3", 6", 7 1/2", 9", 10 1/2", 12", 13 1/2" and 15" high. These components are designed to efficiently accommodate virtually any filing and storage requirement.

To assure KI files are compatible with panel systems, desks or custom architectural details, cabinets are available in 18 different heights.

Preconfigured Units

To simplify the specification process, KI offers preconfigured files and storage cabinets in the most popular sizes with the most popular internal components. These units are assembled using standard components. Lateral files and storage cabinets can be field-retrofitted and updated by specifying componentry from the Custom-Built section of this price list. This does not include current series units.

Height

Lateral files and storage cabinets are available in 40 standard heights. Heights include 1/8" allowance for leveling glides fully recessed.

Depth

All lateral files and storage cabinets are 18" deep.

Width

Lateral files and storage cabinets are available in three standard widths: 30", 36" and 42".

Drawer Dimensions

Refer to the illustrations for the range of drawer sizes and the height clearance of each.

CONSTRUCTION AND STANDARD FEATURES Basic Shell

Shell common to lateral file and storage cabinet units. Uprights punched to accept interior components on 1 1/2" centers. Uprights and top and bottom reinforcements are welded into rigid "boxframe." Constructed of 18- and 20-gauge steel.

Seamless back and top with reinforced corners.

Illustrated shell heights include 1/8" for adjustable glide in recessed position.

Doors/Drawers

Drawer fronts, 20-gauge steel with full-width flush inset pull and label holder or flat front with exterior pulls and no label holder. Fronts are screw-mounted to roll-out shelves to build drawers.

Roll-out shelf body, 22-gauge steel slotted on 1 1/2" centers to accept dividers. Leading edge formed to provide pull; center section offset for additional strength. Shelf ends, 19-gauge steel, notched to accept hanging folder bars. Each roll-out shelf equipped with two heavy-duty, three-section, ball-bearing suspensions.

Components have been tested to accept loads of 125 lbs. This exceeds ANSI/BIFMA X5.9-2004 standards for lateral files when recommended counterbalance weight is installed.

Hinged door, 20-gauge steel, double-wall construction. Door swing is limited to 110° to prevent contact with adjacent cabinet and full height vertical flush inset pull.

Shelves

Blank shelf, 22-gauge steel, formed 7/8" thick on front and back edges. End Tab Shelf, 22-gauge steel shelf and back, 18-gauge sides. Shelf offset along width to increase strength. Slotted on 1" increments to accept plate dividers

Preconfigured lateral files meet or exceed ANSI/BIFMA X5.9-2004 standards.

Receding Door

20-gauge steel with full-width flush inset pull and label holder. Equipped with sound absorber. Doors have guiding mechanism fitted with nylon glides to prevent metal-to-metal contact and ensure effortless operation. The diagrams on the following page identify various shelf and drawer combinations and related height clearances behind a receding door. The diagrams show typical use. Additional interior options can be installed behind a receding door.

Note: Dimensions have been taken from the front raised edge of the roll-out shelf

Accessories

Plate dividers, 18-gauge steel, notched to lock into shelf. Folder bars, 30" & 36" (14-gauge steel); 42" (12-gauge steel), offset to maximize strength.

Suspended binder frames are constructed of 14- to 18-gauge steel. Screw-mounted to cabinet. Can be used behind 13 1/2" and 15" receding doors and hinged storage cabinet doors.

Adjustable Glides

Lateral files and storage cabinets are supplied with four adjustable glides. The glides can be adjusted from inside the cabinet using a 1/4" hex socket wrench, or from outside the cabinet using a 7/8" wrench. Standard glides provide 3/4" adjustment; longer glides are also available. Overall cabinet heights include the glide in its recessed position.

Interlock

All cabinets are equipped with an interlock safety mechanism. This mechanism reduces the possibility of cabinet tipover by permitting only one drawer to be opened at a time. With some unique combinations an individual drawer may not be controlled by the interlock. In these instances a caution label will be affixed to the drawer body.

Locks

Locks are standard on all units. The lock is a high-security double-bit type. The double-bit lock offers superior security when compared to a single-bit lock. Units are standard with random keys in a range of 994 different numbers. Specific keying combinations are available at no additional charge. This information must be included with the order. Locks can be master keyed. Please see the accessories section of this price book for order information on master keys, extractor (core-removal) keys, key blanks, cut keys, and core and key sets.

All locks have removable and interchangeable plugs. This feature provides for onsite custom keying. Units can be supplied with the lock plugs installed or shipped separately. To install or remove lock plugs a unique key is required. This key is the extractor (core removal) key and can be found in the accessories section of this price book. Contact Customer Service to order lock accessories. To order plugs for field installation, specify "lock plugs not installed" on order. Order must specify total quantity of specific key-numbered locks.

Example: 30 plugs:
3 keyed alike
10 keyed alike
17 keyed alike

Commercial Pack

This is the standard pack that KI offers on all files and storage products. This consists of a plastic poly bag placed over the unit, corrugated top and bottom cap, corner blocking and stretch wrap to keep the packaging intact.

Standard Paint Finishes

All KI products are iron phosphate treated prior to painting. This process

enhances top coat bonding.

Powder coat application is a highbred epoxy. The paint is baked on to provide a scratch and stain resistant surface.

All inside and outside shell and front surfaces are painted with the same specified paint color. Interior components and accessories are painted a black finish. Mechanical components are black plated.

Powder coated/enamel finish colors shown in Color Addendums are standard and are available where specifications call for painted surfaces.

Special Paint Finishes

All special colors, including other manufacturers' standard finishes, are available subject to the following conditions.

- Two steel color chips (minimum 2.5" x 3.5") are requested for color matching purposes. Paper samples are acceptable, however, a reasonable tolerance must be allowed when comparing the two variations.
- All solid, single-pass nonstandard colors are available at no upcharge, but may be subject to extended lead-times. Colors that are deemed to be metallic, hi-chromatic, textured or require multiple passes, are subject to upcharges. Orders will not be processed until a color match is approve. Written confirmation must accompany the order.

INSTALLATION

Caution Labels

Caution- and safety-related information is contained on a peel-off label affixed to the front of the cabinet. This label is to be removed by the customer.

Caution: Information is also permanently affixed to the left side of the top drawer. Both labels contain important installation and loading information.

Installation Information

Complete instructions on the proper installation and use of KI files are provided in each file shipped. The instructions refer to correct methods of leveling, ganging and loading. Counterbalance weights should be installed in all single freestanding files.

Field Reconfiguration

As needs change, KI lateral files and storage cabinets can readily be field-changed; however, this process should be undertaken by a qualified service technician.

Model Numbering System

Each character in the basic model number corresponds to a specific unit feature.

How to Build a Model Number

Example: Preconfigured 700 Series Lateral Files & Multimedia Storage

S7L	36	480	4D	BL	CBW50	334FBK
S7L	Product name	700 Series Lateral File				
36	Width	36" wide				
480	Interior height (nominal)	48" high				
4D	Type of unit	4 high, 4 drawer				
BL	Color code	Black				
CBW50	Optional	50# Counterbalance weight				
334FBK	Optional	Front-to-back filing bars				

Each internal component has a corresponding character:

D	Drawer with side-to-side folder bars
R	Receding door, rollout shelf with side-to-side folder bars
E	End tab shelf with plate dividers
HD	Hinged door cabinet with blank shelves
HX	Hinged door cupboard without shelves
OVHD	Overfile storage cabinet

The 334 model number for accessories indicates the item may be used in all cabinet widths.

NOTE: The unit must SPECIFY optional CBW and accessories as INSTALLED or they will be shipped separately.



700 Series® Lateral Files and Storage

General Information

Inside Drawer and Shelf Dimensions*	30W x 18D Cabinet		36W x 18D Cabinet		42W x 18D Cabinet	
	W	D	W	D	W	D
10 1/2" Drawer	26 3/4"	15 7/8"	32 1/4"	15 7/8"	38 3/4"	15 7/8"
12" Single Rollout Shelf	26 3/4"	15 7/8"	32 1/4"	15 7/8"	38 3/4"	15 7/8"
Blank Shelf	26 3/4"	16 7/16"	32 1/4"	16 7/16"	38 3/4"	16 7/16"
Slotted Shelf	26 3/4"	15 1/2"	32 1/4"	15 1/2"	38 3/4"	15 1/2"
12" Drawer	26 3/4"	15 7/8"	32 1/4"	15 7/8"	38 3/4"	15 7/8"
13 1/2" Rollout Shelf	26 3/4"	15 7/8"	32 1/4"	15 7/8"	38 3/4"	15 7/8"
13 1/2" Drawer	26 3/4"	15 7/8"	32 1/4"	15 7/8"	38 3/4"	15 7/8"
End Tab Filing Shelf	26 3/4"	15 3/4"	32 1/4"	15 3/4"	38 3/4"	15 3/4"
Cupboard	28 1/2"	17"	34 1/2"	17"	40 1/2"	17"

* Dimensions have been taken from the front raised edge of rollout shelf. The inside clear dimension wide approximately 1/2" greater.

Hanging File Configurations		30W Cabinet	36W Cabinet	42W Cabinet
Letter	side-to-side	30FBA 26.7"	36FBA 32.7"	42FBA 38.5"
	front-to-back	30FBA w(2)334FBK 30.5"	36FBA w(2)334FBK 30.5"	42FBA w(3)334FBK 45.75"
Legal	side-to-side	30FBA 26.7"	36FBA 32.7"	42FBA 38.6"
	front-to-back	w(1)334FBK 26.5"	36FBA w(2)334FBK 30.5"	42FBA w(2)334FBK 37.87"

Inside Clear Dimensions of Shelf and Drawer Options

	12" Rollout Shelf Behind Receding Door	Blank/Slotted Shelf Behind Receding Door	End Tab Shelf Behind Receding Door	Tie Bar Shelf Below Receding Door	Drawer
3"					2 9/16"
6"					5 7/16"
7 1/2"					7 1/2"
9"					8 7/16"
10 1/2"					10 1/4"
12"					11 1/2"
13 1/2"					13 1/2"
15"					14 7/16"

700 Series® Curve Lateral Files and Storage

General Information

GENERAL INFORMATION

KI CURVE lateral files are designed on a 1½" module to provide an unparalleled degree of internal flexibility. Interior components are available in 3", 6", 7½", 9", 10½", 12", 13½" and 15" high. Clean stylish looks, flexible aesthetics and durability allow Curve to work in private offices and open plan environments. With a gentle curved frame and contoured drawer pulls Curve creates a timeless design element.

Flexible aesthetic and flexible format. Curve allows you to design from the inside out, fitting the media to the appropriate lateral, pedestal, cupboard, bookcase and combination File/Locker unit.

Heavy-gauge steel construction and welded internal box frame provide structural integrity. Multi-extension suspensions provide smooth operation. KI's unique patented interlock/anti-tilt mechanism, with automatic restaging, prevents the opening of more than one drawer at a time. Curve enhances security with its key possibilities.

Preconfigured Units

To simplify the specification process, KI offers preconfigured files and storage cabinets in the most popular sizes with the most popular internal components. These units are assembled using standard components.

Height

Lateral files and storage cabinets are available in 14 standard heights. Heights include ½" allowance for leveling glides fully recessed.

Depth

Lateral files and storage cabinets are 18" deep. Curve combination locker/file units are available in both 18" and 24" depths.

Width

Lateral files and storage cabinets are available in three standard widths: 30", 36" and 42".

Drawer Dimensions

Refer to the illustrations for the range of drawer sizes and the height clearance of each.

CONSTRUCTION AND STANDARD FEATURES

Basic Shell

Shell common to lateral file and storage cabinet units. Uprights punched to accept interior components on 1½" centers. Uprights and top and bottom reinforcements are welded to create a rigid box frame. Constructed of 18 -and 20-gauge steel. Seamless back and top.

Illustrated shell heights include ½" for adjustable glide in recessed position.

Doors/Drawers

Drawer fronts, 20-gauge steel with full-width contoured curved pull. Fronts are screw-mounted to roll-out shelves to build drawers. Roll-out shelf body, 20-gauge steel slotted on 1½" centers to accept dividers. Shelf ends, 18-gauge steel, notched to accept hanging folder bars. Each roll-out shelf equipped with two heavy-duty, three-section, ball-bearing suspensions.

Components have been tested to accept loads of 125 lbs. exceeding ANSI/BIFMA X5.9-2004 standards for lateral files.

Hinged door, 20-gauge steel, double-wall construction. Door swing is limited to 95° to prevent contact with adjacent cabinet.

Shelves

Blank shelf, 22-gauge steel, formed 1" thick on front and back edges. End Tab Shelf, 22-gauge steel shelf and back, 20-gauge sides. Shelf offset along width to increase strength. Slotted on 1" increments to accept plate dividers.

Preconfigured lateral files meet or exceed ANSI/BIFMA X5.9-2004 standards when recommended counterbalance weight is installed.

Receding Door

20-gauge steel with steel full-width contoured curve pull. Equipped with sound absorber. Doors have guiding mechanism fitted with nylon glides to prevent metal-to-metal contact and ensure effortless operation.

The diagrams on the following page identify various shelf and drawer combinations and related height clearances behind a receding door. The diagrams illustrate typical use. Additional interior options can be installed behind a receding door.

Note: Dimensions have been taken from the front raised edge of the roll-out shelf.

Accessories

Plate dividers, 18-gauge steel, notched to lock into shelf. Folder bars, 30" & 36" (14-gauge steel); 42" (12-gauge steel), offset to maximize strength.

Suspended binder frames are constructed of 1/2" to 18-gauge steel. Screw-mounted to cabinet uprights. Fit in multi-media cabinets and behind receding doors.

Adjustable Glides

Lateral files and storage cabinets are supplied with four adjustable glides. The glides can be adjusted from inside the cabinet using a ¼", hex socket wrench, or from outside the cabinet using a ⅞" wrench. Standard glides provide ¾" adjustment; longer glides are also available. Overall cabinet heights include the glide in its recessed position.

Interlock

All cabinets are equipped with an interlock safety mechanism. This mechanism reduces the possibility of cabinet tipover by permitting only one drawer to be opened at a time. With some unique combinations an individual drawer may not be controlled by the interlock. In these instances a caution label will be affixed to the drawer body.

Locks

Locks are standard on all units. The lock is a high-security double-bit type. The double-bit lock offers superior security when compared to a single-bit lock. Units are standard with random keys in a range of 994 different numbers. Specific keying combinations are available at no additional charge. This information must be included with the order. Locks can be master keyed. Please see the accessories section of this price book for order information on master keys, extractor (core-removal) keys, key blanks, cut keys, and core and key sets.

All locks have removable and interchangeable plugs. This feature provides for onsite custom keying. Units can be supplied with the lock plugs installed or shipped separately. To install or remove lock plugs a unique key is required. This key is the extractor (core removal) key and can be found in the accessories section of this price book. Contact Customer Service to order lock accessories. To order plugs for field installation, specify "lock plugs not installed" on order. Order must specify total quantity of specific key-numbered locks.

Example:

30 plugs:
3 keyed alike
10 keyed alike
17 keyed alike

Commercial Pack

This is the standard pack that KI offers on all files and storage products. This consists of a plastic poly bag placed over the unit, corrugated top and bottom cap, corner blocking and stretch wrap to keep the packaging intact.

Standard Paint Finishes

All KI products are iron phosphate treated prior to painting. This process enhances top coat bonding. The wet coat application is either alkyd or acrylic paint finish. The powder coat application is a highbred epoxy. The paint is baked on to provide a scratch and stain resistant surface.

All inside and outside shell and front surfaces are painted with the same specified paint color. Interior components and accessories are painted a black finish. Mechanical components are black plated.

Powder coated/enamel finish colors shown in Color Addendums are standard and are available where specifications call for painted surfaces.

Special Paint Finishes

All special colors, including other manufacturers' standard enamel finishes, are available subject to the following conditions.

1. Two steel color chips (minimum 2.5" x 3.5") are requested for color matching purposes. Paper samples are acceptable, however, a reasonable tolerance must be allowed when comparing the two variations.

2. All solid, single-pass nonstandard colors are available at no upcharge, but may be subject to extended leadtimes. Colors that are deemed to be metallic, hi-chromatic, textured or require multiple passes, are subject to upcharges. Orders will not be processed until a color match is approved.

Written confirmation must accompany the order.

INSTALLATION

Caution Labels

Caution- and safety-related information is contained on a peel-off label affixed to the front of the cabinet. This label is to be removed by the customer.

Caution: Information is also permanently affixed to the left side of the top drawer.

Both labels contain important installation and loading information.

Installation Information

Complete instructions on the proper installation and use of KI files are provided in each file shipped. The instructions refer to correct methods of leveling, ganging and loading. Counterbalance weights should be installed in all single freestanding files.

Field Reconfiguration

As needs change, KI lateral files and storage cabinets can readily be field-changed; however, this process should be undertaken by a qualified service technician.

Model Numbering System

Each character in the basic model number corresponds to a specific unit feature.

How to Build a Model Number

Example: Preconfigured 700 Series Curve Lateral Files & Multimedia Storage

S7CL	36	480	4D	BL	CBW50	334FBK
S7CL	Product name	700 Series Curve Lateral File				
36	Width	36" wide				
480	Interior height (nominal)	48" high				
4D	Type of unit	4 high, 4 drawer				
BL	Color code	Black				
CBW50	Optional	50# Counterbalance weight				
334FBK	Optional	Front-to-back filing bars				

Each internal component has a corresponding character:

D Drawer with side-to-side folder bars
R Receding door, rollout shelf with side-to-side folder bars
E End tab shelf with plate dividers
HD Hinged door cabinet with blank shelves
HX Hinged door cupboard without shelves
OVHD Overfile storage cabinet

The 334 model number for accessories indicates the item may be used in all cabinet widths.
NOTE: The unit must SPECIFY optional CBW and accessories as INSTALLED or they will be shipped separately.



700 Series[®] Curve Lateral Files and Storage

General Information

Inside Drawer and Shelf Dimensions*	30W x 18D Cabinet		36W x 18D Cabinet		42W x 18D Cabinet	
	W	D	W	D	W	D
10 1/2" Drawer	26 3/4"	15 1/8"	32 3/4"	15 7/8"	38 3/4"	15 7/8"
12" Single Rollout Shelf	26 3/4"	15 1/8"	32 3/4"	15 7/8"	38 3/4"	15 7/8"
Blank Shelf	26 3/4"	16 7/16"	32 3/4"	16 7/16"	38 3/4"	16 7/16"
12" End Tab Filing Shelf	26 3/4"	15 3/4"	32 3/4"	15 3/4"	38 3/4"	15 3/4"
Slotted Shelf	26 3/4"	15 1/2"	32 3/4"	15 1/2"	38 3/4"	15 1/2"
12" Drawer	26 3/4"	15 1/8"	32 3/4"	15 7/8"	38 3/4"	15 7/8"
13 1/2" Rollout Shelf	26 3/4"	15 1/8"	32 3/4"	15 7/8"	38 3/4"	15 7/8"
13 1/2" Drawer	26 3/4"	15 1/8"	32 3/4"	15 7/8"	38 3/4"	15 7/8"
15" End Tab Filing Shelf	26 3/4"	15 3/4"	32 3/4"	15 3/4"	38 3/4"	15 3/4"
Cupboard	28 1/2"	17"	34 1/2"	17"	40 1/2"	17"

* Dimensions have been taken from the front raised edge of rollout shelf. The inside clear dimension wide approximately 1/2" greater.

Hanging File Configurations		30W Cabinet	36W Cabinet	42W Cabinet
Letter	side-to-side	30FBA	36FBA	42FBA
	front-to-back	30FBA w(2)334FBK	36FBA w(2)334FBK	42FBA w(3)334FBK
Legal	side-to-side	30FBA	36FBA	42FBA
	front-to-back		36FBA w(2)334FBK	42FBA w(3)334FBK

Inside Clear Dimensions of Shelf and Drawer Options

	12" Rollout Shelf Behind Receding Door	Blank/Slotted Shelf Behind Receding Door	End Tab Shelf Behind Receding Door	Tie Bar Shelf Below Receding Door	Drawer
3"					
6"					
7 1/2"					
9"					
10 1/2"					
12"					
13 1/2"					
15"					

700 Series® OF Lateral Files/Storage Cabinets

General Information

GENERAL INFORMATION

KI 700 Series OF lateral files are designed on the same 1½" upright module as standard 700 Series products. Only 10½" and 12" drawer fronts are illustrated. Other drawer front options, including 6", 7½", 9", 13½" and 15" heights are available on a special order basis. Please contact KI Customer Service for details and pricing.

Only four cabinet heights are illustrated. A total of 40 cabinet heights are available to suit virtually any height requirement. Additional cabinet heights are available on a special order basis. Please contact KI Customer Service for details and pricing.

Height

Lateral files and storage cabinets are available in four standard heights. Heights include 7½" allowance for leveling glides fully recessed.

Depth

All lateral files and storage cabinets are 187/8" deep. This dimension includes the allowance for drawer front thickness.

Standard KI laminate and wood fronts plus the gap between the cabinet and the front equals 7/8". Cabinets with fronts are 187/8" deep.

Width

Lateral files and storage cabinets are available in three standard widths: 30", 36" and 42".

Drawer Dimensions

Refer to the illustrations for the range of drawer sizes and the height clearance of each.

CONSTRUCTION AND STANDARD FEATURES

Basic Shell

Shell common to lateral file and storage cabinet units. Uprights punched to accept interior components on 1½" centers. Uprights and top and bottom reinforcements are welded into rigid "boxframe." Constructed of 18- and 20-gauge steel. Seamless back and top with reinforced corners.

Illustrated shell heights include 1/8" for adjustable glide in recessed position.

Drawer Bodies

Rollout drawer body, 20-gauge steel slotted to accept hanging folder bars. Each drawer leading edge and center section offset to provide additional strength.

Drawer body ends, 18-gauge steel notched to accept hanging folder bars. Each drawer body is equipped with two heavy-duty, three section steel-ball bearing suspension arms. Components have been tested to accept loads of 125 lbs. This exceeds ANSI/BIFMA X5.9-2004 standards for lateral files when recommended counterbalance weights are installed.

Fronts: When specified without fronts, drawers come standard with hardware to mount fronts to drawer bodies. Mounting hardware can be specified for delivery prior to product delivery. Contact Customer Service for details. When specified with fronts, fronts are particleboard core with either wood veneer or plastic laminate finish. Fronts are nominally 3/4" thick.

Front Specifications: To assist in the manufacturing of custom fronts, refer to specification section. This section provides illustrations detailing recommended dimensions and hole locations.

Shelves

Blank shelf, 22-gauge steel, formed 1" thick on front and back edges. End Tab Shelf, 22-gauge steel shelf and back, 20-gauge sides. Shelf offset along width to increase strength. Slotted on 1" increments to accept plate dividers.

Lateral files meet or exceed ANSI/BIFMA X5.9-2004 standards.

Accessories

Plate dividers, 18-gauge steel, notched to lock into shelf. They are not designed to be installed in 10½" drawers.

Folder bars, 14-gauge steel, offset to maximize strength.

Adjustable Glides

Lateral files and storage cabinets are supplied with four adjustable glides. The glides can be adjusted from inside the cabinet using a 1/4" hex socket wrench, or from outside the cabinet using a 7/8" wrench. Standard glides provide 3/4" adjustment; longer glides are also available. Overall cabinet heights include 1/8" allowance for the glide in its recessed position.

Locks

Locks are standard on all units. The lock is a high-security double-bit type. The double-bit lock offers superior security when compared to a single-bit lock. Units are standard with random keys in a range of 994 different numbers. Specific keying combinations are available at no additional charge. This information must be included with the order. Locks can be master keyed. Please see the accessories section of this price book for order information on master keys, extractor (core-removal) keys, key blanks, cut keys, and core and key sets.

All locks have removable and interchangeable plugs. This feature provides for onsite custom keying. Units can be supplied with the lock plugs installed or shipped separately. To install or remove lock plugs a unique key is required. This key is the extractor (core removal) key and can be found in the accessories section of this price book. Contact Customer Service to order lock accessories. To order plugs for field installation, specify "lock plugs not installed" on order. Order must specify total quantity of specific key-numbered locks.

Example: 30 plugs:
3 keyed alike
10 keyed alike
17 keyed alike

Commercial Pack

This is the standard pack that KI offers on all files and storage products. This consists of a plastic poly bag placed over the unit, corrugated top and bottom cap, corner blocking and stretch wrap to keep the packaging intact.

Standard Paint Finishes

All KI products are iron phosphate treated prior to painting. This process enhances top coat bonding. The wet coat application is either alkyd or acrylic paint finish. The powder coat application is a highbred epoxy. The paint is baked on to provide a scratch and stain resistant surface.

All inside and outside shell and front surfaces are painted with the same specified paint color. Interior components and accessories are painted a black finish. Mechanical components are black plated.

Powder coated/enamel finish colors shown in Color Addendums are standard and are available where specifications call for painted surfaces.

Model Numbering System								
Each character in the basic model number corresponds to a specific unit feature.								
How to Build a Model Number								
Example: 700 Series Optional Front Lateral Files – Flush Top Optional Picks								
S7LF	30	240	2D	L1	BL	RCY	CBW50	334FBK
S7LF	Product name	700 Series Lateral File, Flush Top						
30	Width	30" wide						
240	Interior height (nominal)	24" high						
2D	Type of unit	2 high, 2 drawer						
W1	Drawer front style	Wood, center pull						
BL	Color code	Black						
RCY	Veneer finish	Cherry veneer finish						
CBW50	Optional	50# Counterbalance weight						
334FBK	Optional	Front-to-back filing bars						
Each internal component has a corresponding character:								
S7LF	Lateral flush top							
W1	Wood, center pull							
D	Drawer with side-to-side folder bars							
The 334 model number for accessories indicates the item may be used in all cabinet widths.								
NOTE: The unit must SPECIFY optional CBW and accessories as INSTALLED or they will be shipped separately.								

Model Numbering System								
Each character in the basic model number corresponds to a specific unit feature.								
How to Build a Model Number								
Example: 700 Series Optional Front Lateral Files – Extended Top Optional Picks								
S7LE	30	240	2D	L1	BL	LGE	CBW50	334FBK
S7LE	Product name	700 Series Lateral File, Extended Top						
30	Width	30" wide						
240	Interior height (nominal)	24" high						
2D	Type of unit	2 high, 2 drawer						
L1	Drawer front style	Laminate, center pull						
BL	Color code	Black						
LGE	Laminate finish	Grey laminate						
CBW50	Optional	50# Counterbalance weight						
334FBK	Optional	Front-to-back filing bars						
Each internal component has a corresponding character:								
S7LE	Lateral extended top							
L1	Laminate, center pull							
D	Drawer with side-to-side folder bars							
The 334 model number for accessories indicates the item may be used in all cabinet widths.								
NOTE: The unit must SPECIFY optional CBW and accessories as INSTALLED or they will be shipped separately.								



700 Series® OF Lateral Files/Storage Cabinets

General Information

Nonstock Plastic Laminate Surfaces

Additional laminates are available but may be subject to additional lead time. Other special laminates require an up-charge and additional lead time. Contact KI.

INSTALLATION

Drawer Fronts

Installed front units designed for the customer come fully assembled and ready to accept drawer fronts. Drawer fronts are mounted with six screws, two per side and two at the bottom. Complete custom drawer front dimensioning can be found on page 66.

Caution Labels

Caution - and safety - related information is contained on a peel-off label affixed to the front of the cabinet. This label is to be removed by the customer.

Caution information is also permanently affixed to the left side of the top drawer. Both labels contain important installation and loading information.

Installation Information

Complete instructions on the proper installation and use of KI files are provided in each file shipped.

The instructions refer to correct methods of leveling, ganging and loading.

Counterbalance weights should be installed in all single freestanding files.

Field Reconfiguration

As needs change, KI lateral files and storage cabinets can readily be field-changed; however, this process should be undertaken by a qualified service technician.

Inside Drawer and Shelf Dimensions*	30W x 18D Cabinet			36W x 18D Cabinet			42W x 18D Cabinet		
	W	D	H	W	D	H	W	D	H
10 1/2" Drawer	26 3/4"	15 7/8"	10 1/4"	32 3/4"	15 7/8"	10 1/4"	38 3/4"	15 7/8"	10 1/4"
12" Drawer	26 3/4"	15 7/8"	11 1/2"	32 3/4"	15 7/8"	11 1/2"	38 3/4"	15 7/8"	11 1/2"
Storage Cabinet	28 1/2"	17"		34 1/2"	17"		40 1/2"	17"	

Hanging File Configurations

		30W Cabinet		36W Cabinet		42W Cabinet	
Letter	side-to-side	30FBA		36FBA		42FBA	
	front-to-back	30FBA w(2)334FBK		36FBA w(2)334FBK		42FBA w(3)334FBK	
Legal	side-to-side	30FBA		36FBA		42FBA	
	front-to-back	w(1)334FBK		36FBA w(2)334FBK		42FBA w(2)334FBK	

Pull Options



Arch

Bowtie

Metric

Retro

700 Series® OF Lateral Files/Storage Cabinets

General Information

The information outlined below should be used to communicate critical dimensions for various drawer fronts. Larger drawings are available for specific size fronts. Contact Customer Service for availability.

On extended top product, the top rail is not required. It is integral to the shell construction, and is painted the color of the cabinet.

pulls. Drawings are available for fronts with an allowance for KI drawer pulls.

KI center pulls are available for installation on custom fronts. **Note:** the drawings on this page do not provide allowance for KI drawer

The hardware necessary for mounting the drawer fronts will vary depending on the material used. The parts supplied by KI are for use when mounting medium or high-density particle or fiberboard core fronts.

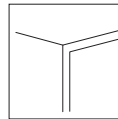
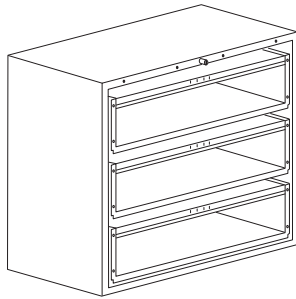

Flush Top

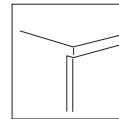

Extended Top

36" Lateral Fronts

Filler Rail

(For flush top applications only)

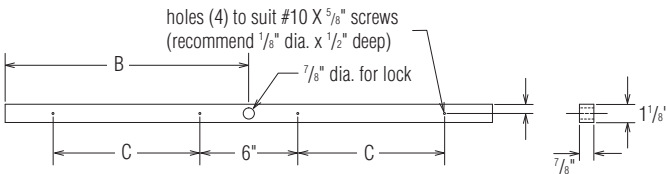
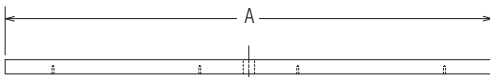

Part #	Dim.A	Dim.B	Dim.C
25522	41 7/8"	20 5/16"	15"
25521	35 7/8"	17 5/16"	12"
25520	29 7/8"	14 5/16"	9"

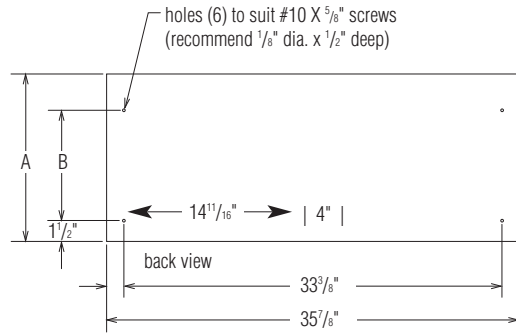

Part #	Front Size	Dim.A	Dim.B
25545	15"	15 3/16"	8"
25544	13 1/2"	13 21/32"	8"
25543	12"	12 1/8"	8"
25542	10 1/2"	10 19/32"	6 15/32"
25541	9"	9 1/16"	4 15/16"
25546	7 1/2"	7 17/32"	1 7/8"
25540	6"	6"	1 7/8"

30" Lateral Fronts

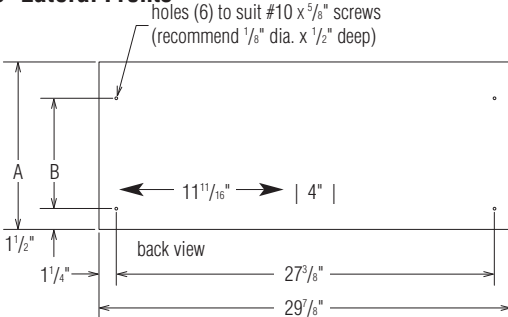

Part #	Front Size	Dim.A	Dim.B
25535	15"	15 3/16"	8"
25534	13 1/2"	13 21/32"	8"
25533	12"	12 1/8"	8"
25532	10 1/2"	10 19/32"	6 15/32"
25531	9"	9 1/16"	4 15/16"
25536	7 1/2"	7 17/32"	1 7/8"
25530	6"	6"	1 7/8"

42" Lateral Fronts

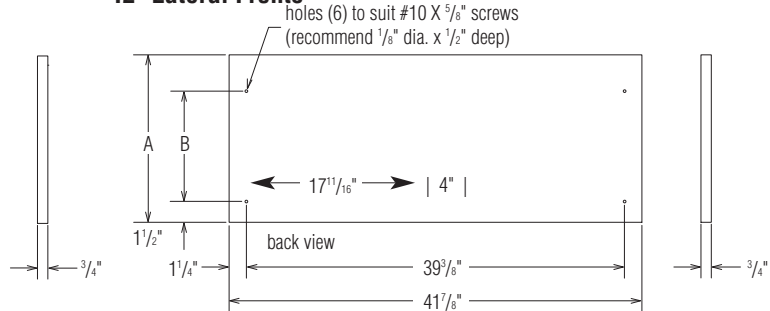

Part #	Front Size	Dim.A	Dim.B
25555	15"	15 3/16"	8"
25554	13 1/2"	13 21/32"	8"
25553	12"	12 1/8"	8"
25552	10 1/2"	10 19/32"	6 15/32"
25551	9"	9 1/16"	4 15/16"
25556	7 1/2"	7 17/32"	1 7/8"
25530	6"	6"	1 7/8"

The information outlined below should be used to communicate critical dimensions for various drawer fronts. Larger drawings are available for specific size fronts. Contact Customer Service for availability.

The KI product is designed for 3/4" thick fronts. Thinner or thicker file fronts can be

adapted to flush top product only. Please be aware that on fronts with thickness different from 3/4" the lock barrel will protrude from or be recessed into the filler rail by the dimension the fronts differ from 3/4".

On extended top product, the top rail is not required. It is integral to the shell construction,

and is painted the color of the cabinet. KI center pulls are available for installation on custom fronts. **Note:** the drawings on this page do not provide allowance for KI drawer pulls. Drawings are available for fronts with an allowance for KI drawer pulls.

The hardware necessary for mounting the drawer fronts will vary depending on the material used. The parts supplied by KI are for use when mounting medium or high-density particle or fiberboard core fronts.

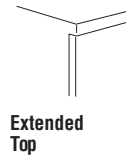
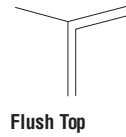
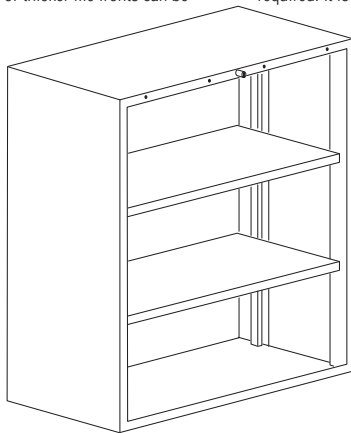

Cabinet Door - 3 Places

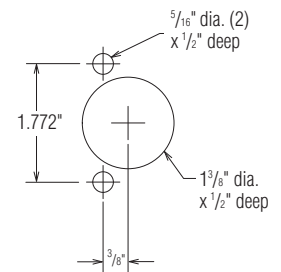
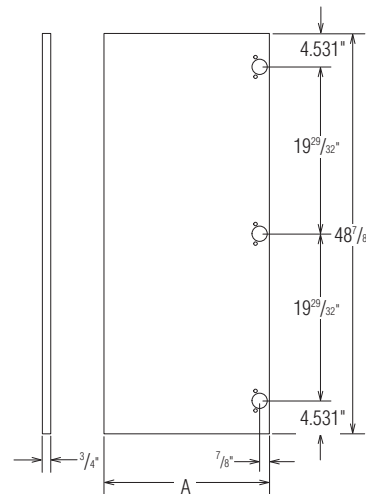

Part #	Dim. A
25722	20 7/8"
25672	17 7/8"
25622	14 7/8"

Filler Rail - see page 66
(For flush top applications only)

Cabinet Door - 2 Places

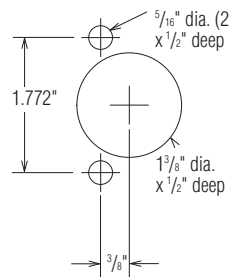
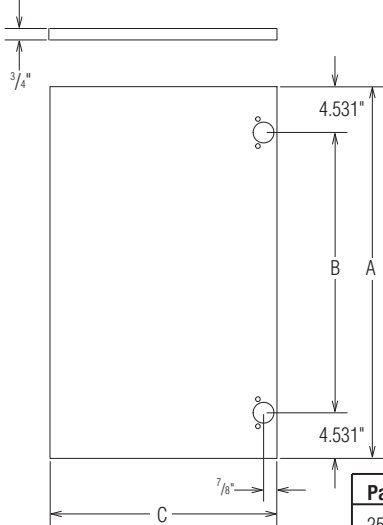

Part #	Dim. A	Dim. B	Dim. C
25714	36 5/8"	27.563"	20 7/8"
25710	30 1/2"	21.438"	20 7/8"
25706	24 3/8"	15.313"	20 7/8"
25664	36 5/8"	27.563"	17 7/8"
25660	30 1/2"	21.438"	17 7/8"
25656	24 3/8"	15.313"	17 7/8"
25614	36 5/8"	27.563"	14 7/8"
25610	30 1/2"	21.438"	14 7/8"
25606	24 3/8"	15.313"	14 7/8"

Cabinet Door - 4 Places

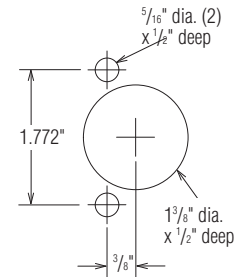
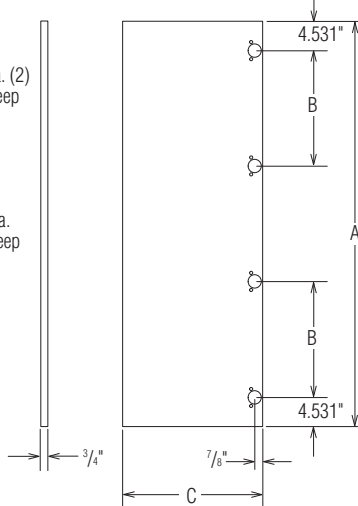

Part #	Dim A	Dim B	Dim C
25739	74 29/32"	16.844"	20 7/8"
25731	62 21/32"	21.438"	20 7/8"
25730	61 1/8"	21.438"	20 7/8"
25689	74 29/32"	21.438"	17 7/8"
25681	62 21/32"	16.844"	17 7/8"
25680	61 1/8"	16.844"	17 7/8"
25639	74 29/32"	21.438"	14 7/8"
25631	62 21/32"	16.844"	14 7/8"
25630	61 1/8"	16.844"	14 7/8"

Preconfigured Lateral Files

700 Series® Drawer Units

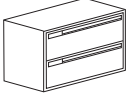
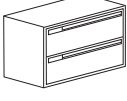
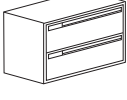
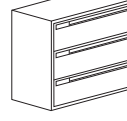
	MODEL	W x D x H	MODEL NUMBER					Approx. Packaged Weight
			Basic Model	Pull Option	Unit Color	Optional Counterbalance Weight	Key Option	
 S7LTU	23-15/16" File, 2 High • Two 10-1/2" drawers with FBA folder bars • Counterbalance weights are recommended for freestanding units	30 x 18 x 23-15/16"	S7L/302102D	<input type="checkbox"/> <input type="checkbox"/> <input type="checkbox"/> <input type="checkbox"/>	<input type="checkbox"/> <input type="checkbox"/>	<input type="checkbox"/> <input type="checkbox"/> <input type="checkbox"/> <input type="checkbox"/> <input type="checkbox"/> <input type="checkbox"/>	<input type="checkbox"/> <input type="checkbox"/>	110.0#
		36 x 18 x 23-15/16"	S7L/362102D	<input type="checkbox"/> <input type="checkbox"/> <input type="checkbox"/> <input type="checkbox"/>	<input type="checkbox"/> <input type="checkbox"/>	<input type="checkbox"/> <input type="checkbox"/> <input type="checkbox"/> <input type="checkbox"/> <input type="checkbox"/> <input type="checkbox"/>	<input type="checkbox"/> <input type="checkbox"/>	120.0#
		42 x 18 x 23-15/16"	S7L/422102D	<input type="checkbox"/> <input type="checkbox"/> <input type="checkbox"/> <input type="checkbox"/>	<input type="checkbox"/> <input type="checkbox"/>	<input type="checkbox"/> <input type="checkbox"/> <input type="checkbox"/> <input type="checkbox"/> <input type="checkbox"/> <input type="checkbox"/>	<input type="checkbox"/> <input type="checkbox"/>	130.0#
 S7LTU	27" File, 2 High • Two 12" drawers with FBA folder bars • Counterbalance weights are recommended for freestanding units	30 x 18 x 27"	S7L/302402D	<input type="checkbox"/> <input type="checkbox"/> <input type="checkbox"/> <input type="checkbox"/>	<input type="checkbox"/> <input type="checkbox"/>	<input type="checkbox"/> <input type="checkbox"/> <input type="checkbox"/> <input type="checkbox"/> <input type="checkbox"/> <input type="checkbox"/>	<input type="checkbox"/> <input type="checkbox"/>	110.0#
		36 x 18 x 27"	S7L/362402D	<input type="checkbox"/> <input type="checkbox"/> <input type="checkbox"/> <input type="checkbox"/>	<input type="checkbox"/> <input type="checkbox"/>	<input type="checkbox"/> <input type="checkbox"/> <input type="checkbox"/> <input type="checkbox"/> <input type="checkbox"/> <input type="checkbox"/>	<input type="checkbox"/> <input type="checkbox"/>	120.0#
		42 x 18 x 27"	S7L/422402D	<input type="checkbox"/> <input type="checkbox"/> <input type="checkbox"/> <input type="checkbox"/>	<input type="checkbox"/> <input type="checkbox"/>	<input type="checkbox"/> <input type="checkbox"/> <input type="checkbox"/> <input type="checkbox"/> <input type="checkbox"/> <input type="checkbox"/>	<input type="checkbox"/> <input type="checkbox"/>	130.0#
 S7LTU	30-1/16" File, 2 High • Two 13-1/2" drawers with FBA folder bars • Counterbalance weights are recommended for freestanding units	30 x 18 x 30-1/16"	S7L/302702D	<input type="checkbox"/> <input type="checkbox"/> <input type="checkbox"/> <input type="checkbox"/>	<input type="checkbox"/> <input type="checkbox"/>	<input type="checkbox"/> <input type="checkbox"/> <input type="checkbox"/> <input type="checkbox"/> <input type="checkbox"/> <input type="checkbox"/>	<input type="checkbox"/> <input type="checkbox"/>	115.0#
		36 x 18 x 30-1/16"	S7L/362702D	<input type="checkbox"/> <input type="checkbox"/> <input type="checkbox"/> <input type="checkbox"/>	<input type="checkbox"/> <input type="checkbox"/>	<input type="checkbox"/> <input type="checkbox"/> <input type="checkbox"/> <input type="checkbox"/> <input type="checkbox"/> <input type="checkbox"/>	<input type="checkbox"/> <input type="checkbox"/>	125.0#
		42 x 18 x 30-1/16"	S7L/422702D	<input type="checkbox"/> <input type="checkbox"/> <input type="checkbox"/> <input type="checkbox"/>	<input type="checkbox"/> <input type="checkbox"/>	<input type="checkbox"/> <input type="checkbox"/> <input type="checkbox"/> <input type="checkbox"/> <input type="checkbox"/> <input type="checkbox"/>	<input type="checkbox"/> <input type="checkbox"/>	135.0#
 S7LTU	39-1/4" File, 3 High • Three 12" drawers with FBA folder bars • Counterbalance weights are recommended for freestanding units	30 x 18 x 39-1/4"	S7L/303603D	<input type="checkbox"/> <input type="checkbox"/> <input type="checkbox"/> <input type="checkbox"/>	<input type="checkbox"/> <input type="checkbox"/>	<input type="checkbox"/> <input type="checkbox"/> <input type="checkbox"/> <input type="checkbox"/> <input type="checkbox"/> <input type="checkbox"/>	<input type="checkbox"/> <input type="checkbox"/>	140.0#
		36 x 18 x 39-1/4"	S7L/363603D	<input type="checkbox"/> <input type="checkbox"/> <input type="checkbox"/> <input type="checkbox"/>	<input type="checkbox"/> <input type="checkbox"/>	<input type="checkbox"/> <input type="checkbox"/> <input type="checkbox"/> <input type="checkbox"/> <input type="checkbox"/> <input type="checkbox"/>	<input type="checkbox"/> <input type="checkbox"/>	150.0#
		42 x 18 x 39-1/4"	S7L/423603D	<input type="checkbox"/> <input type="checkbox"/> <input type="checkbox"/> <input type="checkbox"/>	<input type="checkbox"/> <input type="checkbox"/>	<input type="checkbox"/> <input type="checkbox"/> <input type="checkbox"/> <input type="checkbox"/> <input type="checkbox"/> <input type="checkbox"/>	<input type="checkbox"/> <input type="checkbox"/>	170.0#
			A	B	C	D	E	

HOW TO ORDER

Indicate the following information on order form:

- Quantity of each item.
- Model number, including options. See "How To Build a Model Number".
- Any special service required.

Note: • The indicates that a choice is required.

- The absence of the indicates that no choice is required.
- Alpha-numeric characters in place of indicate that no other alternatives are available.

HOW TO BUILD A MODEL NUMBER

NLC - No lock core

- A** Select basic model.
- B** Select pull option.
- | | |
|------|------------------------|
| ALBT | - Aluminum Bow Tie |
| ALMT | - Aluminum Metric |
| ARCN | - Arc Nickel |
| CLSC | - Classic (inset pull) |
| NKBT | - Nickel Bow Tie |
| RETN | - Retro Nickel |
- C** Select unit and drawer color.
Refer to color addendum at ki.com or KI Fabrics & Finishes binder.
- D** Select counterbalance weight.
- | | |
|-------|-----------------------|
| CBW | - With Counterbalance |
| NOCBW | - No Counterbalance |
- See pricing column for counterbalance weight upcharge.
- E** Select key option.
- | | |
|----|----------------|
| KA | - Key alike |
| KS | - Key standard |

INFORMATION

Folder Bars

Files are configured for side-to-side media storage. For alternative configurations, see the General Information section.

Height

All dimensions shown include 1/8" allowance for glides in recessed position.

Accessories

See accessory section for accessories that can be ordered separately.

Weights

Figures provided are approximate and reflect packaged product without additional accessories.



Preconfigured Lateral Files

700 Series® Drawer Units

Delivered Pricing	Counter-balance Weight add to list price
\$ 819	\$ 161
921	161
1004	161
<hr/>	
\$ 819	\$ 161
921	161
1004	161
<hr/>	
\$ 819	\$ 161
921	161
1004	161
<hr/>	
\$ 1098	\$ 161
1242	161
1385	161

SPECIAL SERVICES

Special Carton Marking

With specially marked information N/C



Shipping

Shipped **assembled freight prepaid f.o.b. Pembroke, Ontario K8A 0E1** factory. Freight class #70.

Specifications and prices are subject to change without prior notice.

Preconfigured Lateral Files

700 Series® Drawer Units

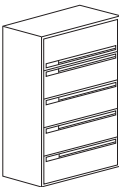
	MODEL	W x D x H	MODEL NUMBER					Approx. Packaged Weight
			Basic Model	Pull Option	Unit Color	Optional Counterbalance Weight	Key Option	
 <p>S7LTU</p>	51-1/2" File, 4 High • Four 12" drawers with FBA folder bars • Counterbalance weights are recommended for freestanding units	30 x 18 x 51-1/2"	S7L/304804D	<input type="checkbox"/> <input type="checkbox"/> <input type="checkbox"/> <input type="checkbox"/>	<input type="checkbox"/>	<input type="checkbox"/> <input type="checkbox"/> <input type="checkbox"/> <input type="checkbox"/> <input type="checkbox"/> <input type="checkbox"/>	<input type="checkbox"/> <input type="checkbox"/>	180.0#
		36 x 18 x 51-1/2"	S7L/364804D	<input type="checkbox"/> <input type="checkbox"/> <input type="checkbox"/> <input type="checkbox"/>	<input type="checkbox"/>	<input type="checkbox"/> <input type="checkbox"/> <input type="checkbox"/> <input type="checkbox"/> <input type="checkbox"/> <input type="checkbox"/>	<input type="checkbox"/> <input type="checkbox"/>	200.0#
		42 x 18 x 51-1/2"	S7L/424804D	<input type="checkbox"/> <input type="checkbox"/> <input type="checkbox"/> <input type="checkbox"/>	<input type="checkbox"/>	<input type="checkbox"/> <input type="checkbox"/> <input type="checkbox"/> <input type="checkbox"/> <input type="checkbox"/> <input type="checkbox"/>	<input type="checkbox"/> <input type="checkbox"/>	220.0#
 <p>S7LTU</p>	54-9/16" File, 4 High • One 15" receding door/end tab shelf with 3 plate dividers • Three 12" drawers with FBA folder bars • Counterbalance weights are recommended for freestanding units	30 x 18 x 54-9/16"	S7L/305104D	<input type="checkbox"/> <input type="checkbox"/> <input type="checkbox"/> <input type="checkbox"/>	<input type="checkbox"/>	<input type="checkbox"/> <input type="checkbox"/> <input type="checkbox"/> <input type="checkbox"/> <input type="checkbox"/> <input type="checkbox"/>	<input type="checkbox"/> <input type="checkbox"/>	170.0#
		36 x 18 x 54-9/16"	S7L/365104D	<input type="checkbox"/> <input type="checkbox"/> <input type="checkbox"/> <input type="checkbox"/>	<input type="checkbox"/>	<input type="checkbox"/> <input type="checkbox"/> <input type="checkbox"/> <input type="checkbox"/> <input type="checkbox"/> <input type="checkbox"/>	<input type="checkbox"/> <input type="checkbox"/>	190.0#
		42 x 18 x 54-9/16"	S7L/425104D	<input type="checkbox"/> <input type="checkbox"/> <input type="checkbox"/> <input type="checkbox"/>	<input type="checkbox"/>	<input type="checkbox"/> <input type="checkbox"/> <input type="checkbox"/> <input type="checkbox"/> <input type="checkbox"/> <input type="checkbox"/>	<input type="checkbox"/> <input type="checkbox"/>	210.0#
 <p>S7LTU</p>	56-3/32" File, 5 High • Five 10-1/2" drawers with FBA folder bars • Counterbalance weights are recommended for freestanding units	30 x 18 x 56-3/32"	S7L/305255D	<input type="checkbox"/> <input type="checkbox"/> <input type="checkbox"/> <input type="checkbox"/>	<input type="checkbox"/>	<input type="checkbox"/> <input type="checkbox"/> <input type="checkbox"/> <input type="checkbox"/> <input type="checkbox"/> <input type="checkbox"/>	<input type="checkbox"/> <input type="checkbox"/>	235.0#
		36 x 18 x 56-3/32"	S7L/365255D	<input type="checkbox"/> <input type="checkbox"/> <input type="checkbox"/> <input type="checkbox"/>	<input type="checkbox"/>	<input type="checkbox"/> <input type="checkbox"/> <input type="checkbox"/> <input type="checkbox"/> <input type="checkbox"/> <input type="checkbox"/>	<input type="checkbox"/> <input type="checkbox"/>	255.0#
		42 x 18 x 56-3/32"	S7L/425255D	<input type="checkbox"/> <input type="checkbox"/> <input type="checkbox"/> <input type="checkbox"/>	<input type="checkbox"/>	<input type="checkbox"/> <input type="checkbox"/> <input type="checkbox"/> <input type="checkbox"/> <input type="checkbox"/> <input type="checkbox"/>	<input type="checkbox"/> <input type="checkbox"/>	275.0#
 <p>S7LTU</p>	59-5/32" File, 5 High • One 12" receding door/rollout shelf with 3 plate dividers • One 12" drawer with FBA folder bars • Three 10-1/2" drawers with FBA folder bars • Counterbalance weights are recommended for freestanding units	30 x 18 x 59-5/32"	S7L/305555D	<input type="checkbox"/> <input type="checkbox"/> <input type="checkbox"/> <input type="checkbox"/>	<input type="checkbox"/>	<input type="checkbox"/> <input type="checkbox"/> <input type="checkbox"/> <input type="checkbox"/> <input type="checkbox"/> <input type="checkbox"/>	<input type="checkbox"/> <input type="checkbox"/>	200.0#
		36 x 18 x 59-5/32"	S7L/365555D	<input type="checkbox"/> <input type="checkbox"/> <input type="checkbox"/> <input type="checkbox"/>	<input type="checkbox"/>	<input type="checkbox"/> <input type="checkbox"/> <input type="checkbox"/> <input type="checkbox"/> <input type="checkbox"/> <input type="checkbox"/>	<input type="checkbox"/> <input type="checkbox"/>	215.0#
		42 x 18 x 59-5/32"	S7L/425555D	<input type="checkbox"/> <input type="checkbox"/> <input type="checkbox"/> <input type="checkbox"/>	<input type="checkbox"/>	<input type="checkbox"/> <input type="checkbox"/> <input type="checkbox"/> <input type="checkbox"/> <input type="checkbox"/> <input type="checkbox"/>	<input type="checkbox"/> <input type="checkbox"/>	230.0#

A **B** **C** **D** **E**

HOW TO ORDER

Indicate the following information on order form:

- Quantity of each item.
- Model number, including options. See "How To Build a Model Number".
- Any special service required.

Note: • The indicates that a choice is required.

- The absence of the indicates that no choice is required.
- Alpha-numeric characters in place of indicate that no other alternatives are available.

HOW TO BUILD A MODEL NUMBER

NLC - No lock core

- A** Select basic model.
 - ALBT - Aluminum Bow Tie
 - ALMT - Aluminum Metric
 - ARCN - Arc Nickel
 - CLSC - Classic (inset pull)
 - NKBT - Nickel Bow Tie
 - RETN - Retro Nickel
- C** Select unit and drawer color. Refer to color addendum at ki.com or KI Fabrics & Finishes binder.
- D** Select counterbalance weight.
 - CBW - With Counterbalance
 - NOCBW - No Counterbalance
 See pricing column for counterbalance weight upcharge.
- E** Select key option.
 - KA - Key alike
 - KS - Key standard

INFORMATION

Folder Bars

Files are configured for side-to-side media storage. For alternative configurations, see the General Information section.

Height

All dimensions shown include 1/8" allowance for glides in recessed position.

Accessories

See accessory section for accessories that can be ordered separately.

Weights

Figures provided are approximate and reflect packaged product without additional accessories.



Preconfigured Lateral Files

700 Series® Drawer Units

Delivered Pricing	Counter-balance Weight add to list price
\$ 1375	\$ 125
1605	125
1822	125
<hr/>	
\$ 1580	\$ 125
1698	125
2030	125
<hr/>	
\$ 1779	\$ 125
1928	125
2080	125
<hr/>	
\$ 1639	\$ 125
1877	125
2124	125

SPECIAL SERVICES

Special Carton Marking

With specially marked information N/C

Shipping

Shipped **assembled freight prepaid f.o.b. Pembroke, Ontario K8A 0E1** factory.
Freight class #70.

Specifications and prices are subject to change without prior notice.

Preconfigured Lateral Files

700 Series® Drawer Units

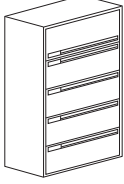
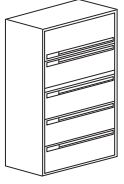
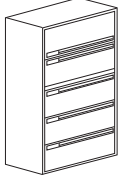
	MODEL	W x D x H	MODEL NUMBER					Approx. Packaged Weight
			Basic Model	Pull Option	Unit Color	Optional Counterbalance Weight	Key Option	
	63-3/4" File, 5 High • One 12" receding door/rollout shelf with 3 plate dividers • Four 12" drawers with FBA folding bars • Counterbalance weights are recommended for freestanding units	30 x 18 x 63-3/4"	S7L/306005D	<input type="checkbox"/> <input type="checkbox"/> <input type="checkbox"/> <input type="checkbox"/>	<input type="checkbox"/> <input type="checkbox"/>	<input type="checkbox"/> <input type="checkbox"/> <input type="checkbox"/> <input type="checkbox"/> <input type="checkbox"/> <input type="checkbox"/>	<input type="checkbox"/> <input type="checkbox"/>	230.0#
		36 x 18 x 63-3/4"	S7L/366005D	<input type="checkbox"/> <input type="checkbox"/> <input type="checkbox"/> <input type="checkbox"/>	<input type="checkbox"/> <input type="checkbox"/>	<input type="checkbox"/> <input type="checkbox"/> <input type="checkbox"/> <input type="checkbox"/> <input type="checkbox"/> <input type="checkbox"/>	<input type="checkbox"/> <input type="checkbox"/>	250.0#
		42 x 18 x 63-3/4"	S7L/426005D	<input type="checkbox"/> <input type="checkbox"/> <input type="checkbox"/> <input type="checkbox"/>	<input type="checkbox"/> <input type="checkbox"/>	<input type="checkbox"/> <input type="checkbox"/> <input type="checkbox"/> <input type="checkbox"/> <input type="checkbox"/> <input type="checkbox"/>	<input type="checkbox"/> <input type="checkbox"/>	270.0#
S7LTU								
	65-9/32" File, 5 High • One 12" receding door/rollout shelf with 3 plate dividers • One 1-1/2" tie bar or posting shelf • DP model replaces 1-1/2" tie bar with a 1-1/2" posting shelf • Four 12" drawers with FBA folder bars • Counterbalance weights are recommended for freestanding units	30 x 18 x 65-9/32"	S7L/306155D	<input type="checkbox"/> <input type="checkbox"/> <input type="checkbox"/> <input type="checkbox"/>	<input type="checkbox"/> <input type="checkbox"/>	<input type="checkbox"/> <input type="checkbox"/> <input type="checkbox"/> <input type="checkbox"/> <input type="checkbox"/> <input type="checkbox"/>	<input type="checkbox"/> <input type="checkbox"/>	230.0#
		30 x 18 x 65-9/32"	S7L/306155DP	<input type="checkbox"/> <input type="checkbox"/> <input type="checkbox"/> <input type="checkbox"/>	<input type="checkbox"/> <input type="checkbox"/>	<input type="checkbox"/> <input type="checkbox"/> <input type="checkbox"/> <input type="checkbox"/> <input type="checkbox"/> <input type="checkbox"/>	<input type="checkbox"/> <input type="checkbox"/>	255.0#
		36 x 18 x 65-9/32"	S7L/366155D	<input type="checkbox"/> <input type="checkbox"/> <input type="checkbox"/> <input type="checkbox"/>	<input type="checkbox"/> <input type="checkbox"/>	<input type="checkbox"/> <input type="checkbox"/> <input type="checkbox"/> <input type="checkbox"/> <input type="checkbox"/> <input type="checkbox"/>	<input type="checkbox"/> <input type="checkbox"/>	250.0#
		36 x 18 x 65-9/32"	S7L/366155DP	<input type="checkbox"/> <input type="checkbox"/> <input type="checkbox"/> <input type="checkbox"/>	<input type="checkbox"/> <input type="checkbox"/>	<input type="checkbox"/> <input type="checkbox"/> <input type="checkbox"/> <input type="checkbox"/> <input type="checkbox"/> <input type="checkbox"/>	<input type="checkbox"/> <input type="checkbox"/>	270.0#
		42 x 18 x 65-9/32"	S7L/426155D	<input type="checkbox"/> <input type="checkbox"/> <input type="checkbox"/> <input type="checkbox"/>	<input type="checkbox"/> <input type="checkbox"/>	<input type="checkbox"/> <input type="checkbox"/> <input type="checkbox"/> <input type="checkbox"/> <input type="checkbox"/> <input type="checkbox"/>	<input type="checkbox"/> <input type="checkbox"/>	270.0#
		42 x 18 x 65-9/32"	S7L/426155DP	<input type="checkbox"/> <input type="checkbox"/> <input type="checkbox"/> <input type="checkbox"/>	<input type="checkbox"/> <input type="checkbox"/>	<input type="checkbox"/> <input type="checkbox"/> <input type="checkbox"/> <input type="checkbox"/> <input type="checkbox"/> <input type="checkbox"/>	<input type="checkbox"/> <input type="checkbox"/>	315.0#
S7LTU								
	68-11/32" File, 5 High • One 15" receding door/end tab shelf with 3 plate dividers • One 1-1/2" tie bar • 1-1/2" structural filler shelf on 42" wide • Four 12" drawers with FBA folder bars • Counterbalance weights are recommended for freestanding units	30 x 18 x 68-11/32"	S7L/306455D	<input type="checkbox"/> <input type="checkbox"/> <input type="checkbox"/> <input type="checkbox"/>	<input type="checkbox"/> <input type="checkbox"/>	<input type="checkbox"/> <input type="checkbox"/> <input type="checkbox"/> <input type="checkbox"/> <input type="checkbox"/> <input type="checkbox"/>	<input type="checkbox"/> <input type="checkbox"/>	225.0#
		36 x 18 x 68-11/32"	S7L/366455D	<input type="checkbox"/> <input type="checkbox"/> <input type="checkbox"/> <input type="checkbox"/>	<input type="checkbox"/> <input type="checkbox"/>	<input type="checkbox"/> <input type="checkbox"/> <input type="checkbox"/> <input type="checkbox"/> <input type="checkbox"/> <input type="checkbox"/>	<input type="checkbox"/> <input type="checkbox"/>	240.0#
		42 x 18 x 68-11/32"	S7L/426455D	<input type="checkbox"/> <input type="checkbox"/> <input type="checkbox"/> <input type="checkbox"/>	<input type="checkbox"/> <input type="checkbox"/>	<input type="checkbox"/> <input type="checkbox"/> <input type="checkbox"/> <input type="checkbox"/> <input type="checkbox"/> <input type="checkbox"/>	<input type="checkbox"/> <input type="checkbox"/>	275.0#
S7LTU								
			A	B	C	D	E	

HOW TO ORDER

Indicate the following information on order form:

- Quantity of each item.
- Model number, including options. See "How To Build a Model Number".
- Any special service required.

Note: • The indicates that a choice is required.

- The absence of the indicates that no choice is required.
- Alpha-numeric characters in place of indicate that no other alternatives are available.

HOW TO BUILD A MODEL NUMBER

NLC - No lock core

- A** Select basic model.
- B** Select pull option.
- | | |
|-------------|------------------------|
| <u>ALBT</u> | - Aluminum Bow Tie |
| <u>ALMT</u> | - Aluminum Metric |
| <u>ARCN</u> | - Arc Nickel |
| <u>CLSC</u> | - Classic (inset pull) |
| <u>NKBT</u> | - Nickel Bow Tie |
| <u>RETN</u> | - Retro Nickel |
- C** Select unit and drawer color.
Refer to color addendum at ki.com or KI Fabrics & Finishes binder.
- D** Select counterbalance weight.
- | | |
|--------------|-----------------------|
| <u>CBW</u> | - With Counterbalance |
| <u>NOCBW</u> | - No Counterbalance |
- See pricing column for counterbalance weight upcharge.
- E** Select key option.
- | | |
|-----------|----------------|
| <u>KA</u> | - Key alike |
| <u>KS</u> | - Key standard |

INFORMATION

Folder Bars

Files are configured for side-to-side media storage. For alternative configurations, see the General Information section.

Height

All dimensions shown include 1/8" allowance for glides in recessed position.

Accessories

See accessory section for accessories that can be ordered separately.

Weights

Figures provided are approximate and reflect packaged product without additional accessories.



Preconfigured Lateral Files

700 Series® Drawer Units

Delivered Pricing	Counter-balance Weight add to list price
\$ 1639	\$ 125
1877	125
2124	125
\$ 1639	\$ 125
1751	125
1877	125
1991	125
2124	125
2235	125
\$ 1915	\$ 125
2039	125
2326	125

SPECIAL SERVICES

Special Carton Marking

With specially marked information N/C

Shipping

Shipped **assembled freight prepaid f.o.b. Pembroke, Ontario K8A 0E1** factory. Freight class #70.

Specifications and prices are subject to change without prior notice.

Preconfigured Lateral Files

700 Series® Drawer Units

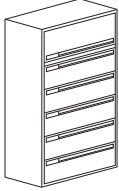
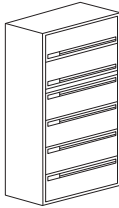
	MODEL	W x D x H	MODEL NUMBER					Approx. Packaged Weight
			Basic Model	Pull Option	Unit Color	Optional Counterbalance Weight	Key Option	
	71-13/32" File, 6 High • One 13-1/2" receding door • One 1-1/2" tie bar slotted shelf with 3 plate dividers on 30" and 36" wide • 1-1/2" structural filler shelf on 42" wide • Five 10-1/2" drawers with FBA folder bars • Counterbalance weights are recommended for freestanding units	30 x 18 x 71-13/32"	S7L/306756D	<input type="checkbox"/> <input type="checkbox"/> <input type="checkbox"/> <input type="checkbox"/>	<input type="checkbox"/> <input type="checkbox"/>	<input type="checkbox"/> <input type="checkbox"/> <input type="checkbox"/> <input type="checkbox"/> <input type="checkbox"/> <input type="checkbox"/>	<input type="checkbox"/> <input type="checkbox"/> <input type="checkbox"/>	270.0#
		36 x 18 x 71-13/32"	S7L/366756D	<input type="checkbox"/> <input type="checkbox"/> <input type="checkbox"/> <input type="checkbox"/>	<input type="checkbox"/> <input type="checkbox"/>	<input type="checkbox"/> <input type="checkbox"/> <input type="checkbox"/> <input type="checkbox"/> <input type="checkbox"/> <input type="checkbox"/>	<input type="checkbox"/> <input type="checkbox"/> <input type="checkbox"/>	300.0#
		42 x 18 x 71-13/32"	S7L/426756D	<input type="checkbox"/> <input type="checkbox"/> <input type="checkbox"/> <input type="checkbox"/>	<input type="checkbox"/> <input type="checkbox"/>	<input type="checkbox"/> <input type="checkbox"/> <input type="checkbox"/> <input type="checkbox"/> <input type="checkbox"/> <input type="checkbox"/>	<input type="checkbox"/> <input type="checkbox"/> <input type="checkbox"/>	345.0#
S7LTU								
	77-17/32" File, 6 High • One 12" receding door/end tab shelf with plate dividers • One 12" receding door/rollout shelf with 3 plate dividers • One 1-1/2" tie bar • 1-1/2" structural filler shelf on 42" wide • Four 12" drawers with FBA folder bars • Counterbalance weights are recommended for freestanding units	30 x 18 x 77-17/32"	S7L/307356D	CLSC	<input type="checkbox"/> <input type="checkbox"/>	<input type="checkbox"/> <input type="checkbox"/> <input type="checkbox"/> <input type="checkbox"/> <input type="checkbox"/> <input type="checkbox"/>	<input type="checkbox"/> <input type="checkbox"/> <input type="checkbox"/>	270.0#
		36 x 18 x 77-17/32"	S7L/367356D	CLSC	<input type="checkbox"/> <input type="checkbox"/>	<input type="checkbox"/> <input type="checkbox"/> <input type="checkbox"/> <input type="checkbox"/> <input type="checkbox"/> <input type="checkbox"/>	<input type="checkbox"/> <input type="checkbox"/> <input type="checkbox"/>	295.0#
		42 x 18 x 77-17/32"	S7L/427356D	CLSC	<input type="checkbox"/> <input type="checkbox"/>	<input type="checkbox"/> <input type="checkbox"/> <input type="checkbox"/> <input type="checkbox"/> <input type="checkbox"/> <input type="checkbox"/>	<input type="checkbox"/> <input type="checkbox"/> <input type="checkbox"/>	339.0#
S7LTU								

A **B** **C** **D** **E**

HOW TO ORDER

Indicate the following information on order form:

- Quantity of each item.
- Model number, including options. See "How To Build a Model Number".
- Any special service required.

Note: • The indicates that a choice is required.

- The absence of the indicates that no choice is required.
- Alpha-numeric characters in place of indicate that no other alternatives are available.

HOW TO BUILD A MODEL NUMBER

NLC - No lock core

- A** Select basic model.

<u>ALBT</u>	- Aluminum Bow Tie
<u>ALMT</u>	- Aluminum Metric
<u>ARCN</u>	- Arc Nickel
<u>CLSC</u>	- Classic (inset pull)
<u>NKBT</u>	- Nickel Bow Tie
<u>RETN</u>	- Retro Nickel
- C** Select unit and drawer color. Refer to color addendum at ki.com or KI Fabrics & Finishes binder.
- D** Select counterbalance weight.

<u>CBW</u>	- With Counterbalance
<u>NOCBW</u>	- No Counterbalance

 See pricing column for counterbalance weight upcharge.
- E** Select key option.

<u>KA</u>	- Key alike
<u>KS</u>	- Key standard

INFORMATION

Folder Bars

Files are configured for side-to-side media storage. For alternative configurations, see the General Information section.

Height

All dimensions shown include 1/8" allowance for glides in recessed position.

Accessories

See accessory section for accessories that can be ordered separately.

Weights

Figures provided are approximate and reflect packaged product without additional accessories.



Preconfigured Lateral Files

700 Series® Drawer Units

Delivered Pricing	Counter-balance Weight add to list price
\$ 2222	\$ 125
2456	125
2803	125
\$ 1985	\$ 125
2277	125
2600	125

SPECIAL SERVICES

Special Carton Marking

With specially marked information N/C





Shipping

Shipped **assembled freight prepaid f.o.b. Pembroke, Ontario K8A 0E1** factory. Freight class #70.

Specifications and prices are subject to change without prior notice.

Preconfigured Lateral Files

700 Series® Curve Drawer Units

			MODEL NUMBER						Approx. Packaged Weight
MODEL	W x D	Basic Model	Dimpled	Unit Color	Pull Color	Optional Counterbalance Weight	Key Option		
 <p>23-15/16" File, 2 High</p> <ul style="list-style-type: none"> Two 10-1/2" drawers with FBA folder bars Counterbalance weights are recommended for freestanding units 	30 x 18"	S7CL302102D	<input type="checkbox"/>	<input type="checkbox"/>	<input type="checkbox"/>	<input type="checkbox"/>	<input type="checkbox"/>	110.0#	
	36 x 18"	S7CL362102D	<input type="checkbox"/>	<input type="checkbox"/>	<input type="checkbox"/>	<input type="checkbox"/>	<input type="checkbox"/>	120.0#	
	42 x 18"	S7CL422102D	<input type="checkbox"/>	<input type="checkbox"/>	<input type="checkbox"/>	<input type="checkbox"/>	<input type="checkbox"/>	130.0#	
S7CL									
 <p>27" File, 2 High</p> <ul style="list-style-type: none"> Two 12" drawers with FBA folder bars Counterbalance weights are recommended for freestanding units 	30 x 18"	S7CL302402D	<input type="checkbox"/>	<input type="checkbox"/>	<input type="checkbox"/>	<input type="checkbox"/>	<input type="checkbox"/>	110.0#	
	36 x 18"	S7CL362402D	<input type="checkbox"/>	<input type="checkbox"/>	<input type="checkbox"/>	<input type="checkbox"/>	<input type="checkbox"/>	120.0#	
	42 x 18"	S7CL422402D	<input type="checkbox"/>	<input type="checkbox"/>	<input type="checkbox"/>	<input type="checkbox"/>	<input type="checkbox"/>	130.0#	
S7CL									
 <p>39-1/4" File, 3 High</p> <ul style="list-style-type: none"> Three 12" drawers with FBA folder bars Counterbalance weights are recommended for freestanding units 	30 x 18"	S7CL303603D	<input type="checkbox"/>	<input type="checkbox"/>	<input type="checkbox"/>	<input type="checkbox"/>	<input type="checkbox"/>	140.0#	
	36 x 18"	S7CL363603D	<input type="checkbox"/>	<input type="checkbox"/>	<input type="checkbox"/>	<input type="checkbox"/>	<input type="checkbox"/>	150.0#	
	42 x 18"	S7CL423603D	<input type="checkbox"/>	<input type="checkbox"/>	<input type="checkbox"/>	<input type="checkbox"/>	<input type="checkbox"/>	170.0#	
S7CL									
 <p>51-1/2" File, 4 High</p> <ul style="list-style-type: none"> Four 12" drawers with FBA folder bars Counterbalance weights are recommended for freestanding units 	30 x 18"	S7CL304804D	<input type="checkbox"/>	<input type="checkbox"/>	<input type="checkbox"/>	<input type="checkbox"/>	<input type="checkbox"/>	180.0#	
	36 x 18"	S7CL364804D	<input type="checkbox"/>	<input type="checkbox"/>	<input type="checkbox"/>	<input type="checkbox"/>	<input type="checkbox"/>	200.0#	
	42 x 18"	S7CL424804D	<input type="checkbox"/>	<input type="checkbox"/>	<input type="checkbox"/>	<input type="checkbox"/>	<input type="checkbox"/>	220.0#	
S7CL									
			A	B	C	D	E	F	

HOW TO ORDER

Indicate the following information on order form:

- Quantity of each item.
- Model number, including options. See "How To Build a Model Number".
- Any special service required.

- Note:
- The indicates that a choice is required.
 - The absence of the indicates that no choice is required.
 - Alpha-numeric characters in place of indicate that no other alternatives are available.

HOW TO BUILD A MODEL NUMBER

- A** Select basic model.
- B** Select flat or dimpled front.
 - D** - Dimpled
 - F** - Flat
 See upcharge column for D option.
- C** Select unit and drawer color. Refer to color addendum at ki.com or KI Fabrics & Finishes binder.
- D** Select drawer pull color. Refer to color addendum at ki.com or KI Fabrics & Finishes binder.
- E** Select counterbalance weight.
 - CBW** - With Counterbalance
 - NOCBW** - No Counterbalance
 See pricing column for counterbalance weight upcharge.
- F** Select key option.
 - KA** - Key alike

- KS** - Key standard
- NLC** - No lock core

INFORMATION

Folder Bars

Files are configured for side-to-side media storage. For alternative configurations, see the General Information section.

Height

All dimensions shown include 1/8" allowance for glides in recessed position.

Accessories

See accessory section for accessories that can be ordered separately.

Weights

Figures provided are approximate and reflect packaged product without additional accessories.



Preconfigured Lateral Files

700 Series® Curve Drawer Units

Delivered Pricing	Dimpled Front add to list price	Counter-balance Weight add to list price
\$ 919	\$ 16	\$ 161
1031	21	161
1125	23	161
<hr/>		
\$ 919	\$ 16	\$ 161
1031	21	161
1125	23	161
<hr/>		
\$ 1230	\$ 25	\$ 161
1394	28	161
1551	32	161
<hr/>		
\$ 1540	\$ 31	\$ 125
1799	35	125
2039	41	125

SPECIAL SERVICES

Special Carton Marking

With specially marked information N/C

Shipping

Shipped **assembled freight prepaid f.o.b. Pembroke, Ontario K8A 0E1** factory. Freight class #70.

Specifications and prices are subject to change without prior notice.

Preconfigured Lateral Files

700 Series® Curve Drawer Units

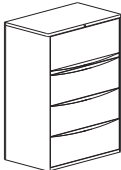
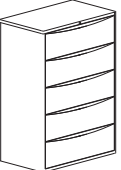
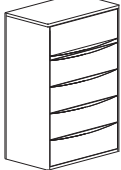
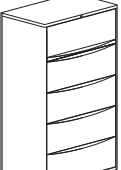
	MODEL	W x D	MODEL NUMBER						Approx. Packaged Weight
			Basic Model	Dimpled	Unit Color	Pull Color	Optional Counterbalance Weight	Key Option	
 <p>S7CL</p>	54-9/16" File, 4 High • One 13-1/2" receding door/end tab shelf with 3 plate dividers • 1-1/2" tie bar shelf • Three 12" drawers with FBA folder bars • Counterbalance weights are recommended for freestanding units	30 x 18"	S7CL305104D	<input type="checkbox"/>	<input type="checkbox"/> <input type="checkbox"/> <input type="checkbox"/>	<input type="checkbox"/> <input type="checkbox"/> <input type="checkbox"/> <input type="checkbox"/> <input type="checkbox"/> <input type="checkbox"/> <input type="checkbox"/> <input type="checkbox"/>	<input type="checkbox"/> <input type="checkbox"/> <input type="checkbox"/> <input type="checkbox"/> <input type="checkbox"/> <input type="checkbox"/>	<input type="checkbox"/> <input type="checkbox"/>	170.0#
		36 x 18"	S7CL365104D	<input type="checkbox"/>	<input type="checkbox"/> <input type="checkbox"/> <input type="checkbox"/>	<input type="checkbox"/> <input type="checkbox"/> <input type="checkbox"/> <input type="checkbox"/> <input type="checkbox"/> <input type="checkbox"/> <input type="checkbox"/> <input type="checkbox"/>	<input type="checkbox"/> <input type="checkbox"/> <input type="checkbox"/> <input type="checkbox"/> <input type="checkbox"/> <input type="checkbox"/>	<input type="checkbox"/> <input type="checkbox"/>	190.0#
		42 x 18"	S7CL425104D	<input type="checkbox"/>	<input type="checkbox"/> <input type="checkbox"/> <input type="checkbox"/>	<input type="checkbox"/> <input type="checkbox"/> <input type="checkbox"/> <input type="checkbox"/> <input type="checkbox"/> <input type="checkbox"/> <input type="checkbox"/> <input type="checkbox"/>	<input type="checkbox"/> <input type="checkbox"/> <input type="checkbox"/> <input type="checkbox"/> <input type="checkbox"/> <input type="checkbox"/>	<input type="checkbox"/> <input type="checkbox"/>	210.0#
 <p>S7CL</p>	56-3/32" File, 5 High • Five 10-1/2" drawers with FBA folder bars • Counterbalance weights are recommended for freestanding units	30 x 18"	S7CL305255D	<input type="checkbox"/>	<input type="checkbox"/> <input type="checkbox"/> <input type="checkbox"/>	<input type="checkbox"/> <input type="checkbox"/> <input type="checkbox"/> <input type="checkbox"/> <input type="checkbox"/> <input type="checkbox"/> <input type="checkbox"/> <input type="checkbox"/>	<input type="checkbox"/> <input type="checkbox"/> <input type="checkbox"/> <input type="checkbox"/> <input type="checkbox"/> <input type="checkbox"/>	<input type="checkbox"/> <input type="checkbox"/>	235.0#
		36 x 18"	S7CL365255D	<input type="checkbox"/>	<input type="checkbox"/> <input type="checkbox"/> <input type="checkbox"/>	<input type="checkbox"/> <input type="checkbox"/> <input type="checkbox"/> <input type="checkbox"/> <input type="checkbox"/> <input type="checkbox"/> <input type="checkbox"/> <input type="checkbox"/>	<input type="checkbox"/> <input type="checkbox"/> <input type="checkbox"/> <input type="checkbox"/> <input type="checkbox"/> <input type="checkbox"/>	<input type="checkbox"/> <input type="checkbox"/>	255.0#
		42 x 18"	S7CL425255D	<input type="checkbox"/>	<input type="checkbox"/> <input type="checkbox"/> <input type="checkbox"/>	<input type="checkbox"/> <input type="checkbox"/> <input type="checkbox"/> <input type="checkbox"/> <input type="checkbox"/> <input type="checkbox"/> <input type="checkbox"/> <input type="checkbox"/>	<input type="checkbox"/> <input type="checkbox"/> <input type="checkbox"/> <input type="checkbox"/> <input type="checkbox"/> <input type="checkbox"/>	<input type="checkbox"/> <input type="checkbox"/>	275.0#
 <p>S7CL</p>	59-5/32" File, 5 High • One 12" receding door/rollout shelf with 3 plate dividers • 1-1/2" tie bar • Four 10-1/2" drawers with FBA folder bars • Counterbalance weights are recommended for freestanding units	30 x 18"	S7CL305555D	<input type="checkbox"/>	<input type="checkbox"/> <input type="checkbox"/> <input type="checkbox"/>	<input type="checkbox"/> <input type="checkbox"/> <input type="checkbox"/> <input type="checkbox"/> <input type="checkbox"/> <input type="checkbox"/> <input type="checkbox"/> <input type="checkbox"/>	<input type="checkbox"/> <input type="checkbox"/> <input type="checkbox"/> <input type="checkbox"/> <input type="checkbox"/> <input type="checkbox"/>	<input type="checkbox"/> <input type="checkbox"/>	200.0#
		36 x 18"	S7CL365555D	<input type="checkbox"/>	<input type="checkbox"/> <input type="checkbox"/> <input type="checkbox"/>	<input type="checkbox"/> <input type="checkbox"/> <input type="checkbox"/> <input type="checkbox"/> <input type="checkbox"/> <input type="checkbox"/> <input type="checkbox"/> <input type="checkbox"/>	<input type="checkbox"/> <input type="checkbox"/> <input type="checkbox"/> <input type="checkbox"/> <input type="checkbox"/> <input type="checkbox"/>	<input type="checkbox"/> <input type="checkbox"/>	215.0#
		42 x 18"	S7CL425555D	<input type="checkbox"/>	<input type="checkbox"/> <input type="checkbox"/> <input type="checkbox"/>	<input type="checkbox"/> <input type="checkbox"/> <input type="checkbox"/> <input type="checkbox"/> <input type="checkbox"/> <input type="checkbox"/> <input type="checkbox"/> <input type="checkbox"/>	<input type="checkbox"/> <input type="checkbox"/> <input type="checkbox"/> <input type="checkbox"/> <input type="checkbox"/> <input type="checkbox"/>	<input type="checkbox"/> <input type="checkbox"/>	230.0#
 <p>S7CL</p>	65-9/32" File, 5 High • One 12" receding door/rollout shelf with 3 plate dividers • 1-1/2" tie bar • Four 12" drawers with FBA folder bars • Counterbalance weights are recommended for freestanding units	30 x 18"	S7CL306155D	<input type="checkbox"/>	<input type="checkbox"/> <input type="checkbox"/> <input type="checkbox"/>	<input type="checkbox"/> <input type="checkbox"/> <input type="checkbox"/> <input type="checkbox"/> <input type="checkbox"/> <input type="checkbox"/> <input type="checkbox"/> <input type="checkbox"/>	<input type="checkbox"/> <input type="checkbox"/> <input type="checkbox"/> <input type="checkbox"/> <input type="checkbox"/> <input type="checkbox"/>	<input type="checkbox"/> <input type="checkbox"/>	230.0#
		36 x 18"	S7CL366155D	<input type="checkbox"/>	<input type="checkbox"/> <input type="checkbox"/> <input type="checkbox"/>	<input type="checkbox"/> <input type="checkbox"/> <input type="checkbox"/> <input type="checkbox"/> <input type="checkbox"/> <input type="checkbox"/> <input type="checkbox"/> <input type="checkbox"/>	<input type="checkbox"/> <input type="checkbox"/> <input type="checkbox"/> <input type="checkbox"/> <input type="checkbox"/> <input type="checkbox"/>	<input type="checkbox"/> <input type="checkbox"/>	250.0#
		42 x 18"	S7CL426155D	<input type="checkbox"/>	<input type="checkbox"/> <input type="checkbox"/> <input type="checkbox"/>	<input type="checkbox"/> <input type="checkbox"/> <input type="checkbox"/> <input type="checkbox"/> <input type="checkbox"/> <input type="checkbox"/> <input type="checkbox"/> <input type="checkbox"/>	<input type="checkbox"/> <input type="checkbox"/> <input type="checkbox"/> <input type="checkbox"/> <input type="checkbox"/> <input type="checkbox"/>	<input type="checkbox"/> <input type="checkbox"/>	270.0#

A **B** **C** **D** **E** **F**

HOW TO ORDER

Indicate the following information on order form:

- Quantity of each item.
- Model number, including options. See "How To Build a Model Number".
- Any special service required.

- Note:
- The indicates that a choice is required.
 - The absence of the indicates that no choice is required.
 - Alpha-numeric characters in place of indicate that no other alternatives are available.

HOW TO BUILD A MODEL NUMBER

- A** Select basic model.

- B** Select flat or dimpled front.
 D _____ - Dimpled
 F _____ - Flat
 See upcharge column for D option.
- C** Select unit and drawer color.
 Refer to color addendum at ki.com or KI Fabrics & Finishes binder.
- D** Select drawer pull color.
 Refer to color addendum at ki.com or KI Fabrics & Finishes binder.
- E** Select counterbalance weight.
 CBW _____ - With Counterbalance
 NOCBW _____ - No Counterbalance
 See pricing column for counterbalance weight upcharge.
- F** Select key option.
 KA _____ - Key alike

- KS - Key standard
- NLC - No lock core

INFORMATION

Folder Bars

Files are configured for side-to-side media storage. For alternative configurations, see the General Information section.

Height

All dimensions shown include 1/8" allowance for glides in recessed position.

Accessories

See accessory section for accessories that can be ordered separately.

Weights

Figures provided are approximate and reflect packaged product without additional accessories.



Preconfigured Lateral Files

700 Series® Curve Drawer Units

Delivered Pricing	Dimpled Front add to list price	Counter-balance Weight add to list price
\$ 1769	\$ 34	\$ 125
1902	36	125
2271	45	125
\$ 1992	\$ 39	\$ 125
2159	42	125
2332	45	125
\$ 1833	\$ 35	\$ 125
2102	42	125
2378	46	125
\$ 1833	\$ 35	\$ 125
2102	42	125
2378	46	125

SPECIAL SERVICES

Special Carton Marking

With specially marked information N/C



Shipping

Shipped **assembled freight prepaid f.o.b. Pembroke, Ontario K8A 0E1** factory. Freight class #70.

Specifications and prices are subject to change without prior notice.

Preconfigured Lateral Files

700 Series® Curve Drawer Units

		MODEL NUMBER							Approx. Packaged Weight
MODEL	W x D	Basic Model	Dimpled	Unit Color	Pull Color	Optional Counterbalance Weight	Key Option		
 <p>S7CL</p>	66-13/16" File, 5 High • One 13-1/2" receding door/rollout shelf with 3 plate dividers • 1-1/2" slotted tie bar • Four 12" drawers with FBA folding bars • Counterbalance weights are recommended for freestanding units	30 x 18"	S7CL306305D	<input type="checkbox"/>	<input type="checkbox"/> <input type="checkbox"/> <input type="checkbox"/>	<input type="checkbox"/> <input type="checkbox"/> <input type="checkbox"/> <input type="checkbox"/> <input type="checkbox"/> <input type="checkbox"/> <input type="checkbox"/> <input type="checkbox"/>	<input type="checkbox"/> <input type="checkbox"/> <input type="checkbox"/> <input type="checkbox"/> <input type="checkbox"/> <input type="checkbox"/>	<input type="checkbox"/> <input type="checkbox"/>	203.0#
		36 x 18"	S7CL366305D	<input type="checkbox"/>	<input type="checkbox"/> <input type="checkbox"/> <input type="checkbox"/>	<input type="checkbox"/> <input type="checkbox"/> <input type="checkbox"/> <input type="checkbox"/> <input type="checkbox"/> <input type="checkbox"/> <input type="checkbox"/> <input type="checkbox"/>	<input type="checkbox"/> <input type="checkbox"/> <input type="checkbox"/> <input type="checkbox"/> <input type="checkbox"/> <input type="checkbox"/>	<input type="checkbox"/> <input type="checkbox"/>	218.0#
		42 x 18"	S7CL426305D	<input type="checkbox"/>	<input type="checkbox"/> <input type="checkbox"/> <input type="checkbox"/>	<input type="checkbox"/> <input type="checkbox"/> <input type="checkbox"/> <input type="checkbox"/> <input type="checkbox"/> <input type="checkbox"/> <input type="checkbox"/> <input type="checkbox"/>	<input type="checkbox"/> <input type="checkbox"/> <input type="checkbox"/> <input type="checkbox"/> <input type="checkbox"/> <input type="checkbox"/>	<input type="checkbox"/> <input type="checkbox"/>	233.0#
 <p>S7CL</p>	71-13/32" File, 6 High • One 13-1/2" receding door • 1-1/2" tie bar slotted shelf with 3 plate dividers • Five 10-1/2" drawers with FBA folder bars • Counterbalance weights are recommended for freestanding units	30 x 18"	S7CL306756D	<input type="checkbox"/>	<input type="checkbox"/> <input type="checkbox"/> <input type="checkbox"/>	<input type="checkbox"/> <input type="checkbox"/> <input type="checkbox"/> <input type="checkbox"/> <input type="checkbox"/> <input type="checkbox"/> <input type="checkbox"/> <input type="checkbox"/>	<input type="checkbox"/> <input type="checkbox"/> <input type="checkbox"/> <input type="checkbox"/> <input type="checkbox"/> <input type="checkbox"/>	<input type="checkbox"/> <input type="checkbox"/>	270.0#
		36 x 18"	S7CL366756D	<input type="checkbox"/>	<input type="checkbox"/> <input type="checkbox"/> <input type="checkbox"/>	<input type="checkbox"/> <input type="checkbox"/> <input type="checkbox"/> <input type="checkbox"/> <input type="checkbox"/> <input type="checkbox"/> <input type="checkbox"/> <input type="checkbox"/>	<input type="checkbox"/> <input type="checkbox"/> <input type="checkbox"/> <input type="checkbox"/> <input type="checkbox"/> <input type="checkbox"/>	<input type="checkbox"/> <input type="checkbox"/>	300.0#

A **B** **C** **D** **E** **F**

HOW TO ORDER

Indicate the following information on order form:

- Quantity of each item.
- Model number, including options. See "How To Build a Model Number".
- Any special service required.

Note: • The indicates that a choice is required.
 • The absence of the indicates that no choice is required.
 • Alpha-numeric characters in place of indicate that no other alternatives are available.

HOW TO BUILD A MODEL NUMBER

- A** Select basic model.
- B** Select flat or dimpled front.
 D - Dimpled
 F - Flat
 See upcharge column for D option.
- C** Select unit and drawer color.
 Refer to color addendum at ki.com or KI Fabrics & Finishes binder.
- D** Select drawer pull color.
 Refer to color addendum at ki.com or KI Fabrics & Finishes binder.
- E** Select counterbalance weight.
 CBW - With Counterbalance
 NOCBW - No Counterbalance
 See pricing column for counterbalance weight upcharge.
- F** Select key option.
 KA - Key alike

KS - Key standard
 NLC - No lock core

INFORMATION

Folder Bars

Files are configured for side-to-side media storage. For alternative configurations, see the General Information section.

Height

All dimensions shown include 1/8" allowance for glides in recessed position.

Accessories

See accessory section for accessories that can be ordered separately.

Weights

Figures provided are approximate and reflect packaged product without additional accessories.



Preconfigured Lateral Files

700 Series® Curve Drawer Units

Delivered Pricing	Dimpled Front add to list price	Counter-balance Weight add to list price
\$ 1907	\$ 35	\$ 125
2185	42	125
2474	46	125
\$ 2486	\$ 47	\$ 125
2751	55	125

SPECIAL SERVICES

Special Carton Marking

With specially marked information N/C

Shipping

Shipped **assembled freight prepaid f.o.b. Pembroke, Ontario K8A 0E1** factory. Freight class #70.

Specifications and prices are subject to change without prior notice.

Preconfigured Lateral Files

700 Series® Receding Door Units

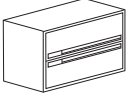
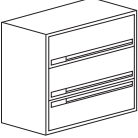
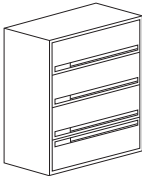
	MODEL	W x D x H	MODEL NUMBER					Approx. Packaged Weight
			Basic Model	Pull Option	Unit Color	Optional Counterbalance Weight	Key Option	
 <p>S7LTU</p>	27" File, 2 High • One 12" receding door/rollout shelf with FBA folder bars • One 12" drawer with FBA folder bars • Counterbalance weights are recommended for freestanding units	30 x 18 x 27"	S7L/302402R	CLSC	<input type="checkbox"/>	<input type="checkbox"/> <input type="checkbox"/> <input type="checkbox"/> <input type="checkbox"/>	<input type="checkbox"/> <input type="checkbox"/>	110.0#
		36 x 18 x 27"	S7L/362402R	CLSC	<input type="checkbox"/>	<input type="checkbox"/> <input type="checkbox"/> <input type="checkbox"/> <input type="checkbox"/>	<input type="checkbox"/> <input type="checkbox"/>	120.0#
		42 x 18 x 27"	S7L/422402R	CLSC	<input type="checkbox"/>	<input type="checkbox"/> <input type="checkbox"/> <input type="checkbox"/> <input type="checkbox"/>	<input type="checkbox"/> <input type="checkbox"/>	130.0#
 <p>S7LTU</p>	39-1/4" File, 3 High • Two 12" receding doors/rollout shelves with FBA folder bars • One 12" drawer with FBA folder bars • Counterbalance weights are recommended for freestanding units	30 x 18 x 39-1/4"	S7L/303603R	CLSC	<input type="checkbox"/>	<input type="checkbox"/> <input type="checkbox"/> <input type="checkbox"/> <input type="checkbox"/>	<input type="checkbox"/> <input type="checkbox"/>	145.0#
		36 x 18 x 39-1/4"	S7L/363603R	CLSC	<input type="checkbox"/>	<input type="checkbox"/> <input type="checkbox"/> <input type="checkbox"/> <input type="checkbox"/>	<input type="checkbox"/> <input type="checkbox"/>	155.0#
		42 x 18 x 39-1/4"	S7L/423603R	CLSC	<input type="checkbox"/>	<input type="checkbox"/> <input type="checkbox"/> <input type="checkbox"/> <input type="checkbox"/>	<input type="checkbox"/> <input type="checkbox"/>	175.0#
 <p>S7LTU</p>	51-1/2" File, 4 High • Three 12" receding doors/rollout shelves with FBA folder bars • One 12" drawer with FBA folder bars • Counterbalance weights are recommended for freestanding units	30 x 18 x 51-1/2"	S7L/304804R	CLSC	<input type="checkbox"/>	<input type="checkbox"/> <input type="checkbox"/> <input type="checkbox"/> <input type="checkbox"/>	<input type="checkbox"/> <input type="checkbox"/>	185.0#
		36 x 18 x 51-1/2"	S7L/364804R	CLSC	<input type="checkbox"/>	<input type="checkbox"/> <input type="checkbox"/> <input type="checkbox"/> <input type="checkbox"/>	<input type="checkbox"/> <input type="checkbox"/>	200.0#
		42 x 18 x 51-1/2"	S7L/424804R	CLSC	<input type="checkbox"/>	<input type="checkbox"/> <input type="checkbox"/> <input type="checkbox"/> <input type="checkbox"/>	<input type="checkbox"/> <input type="checkbox"/>	220.0#

A

B

C

D

E

HOW TO ORDER

Indicate the following information on order form:

- Quantity of each item.
- Model number, including options. See "How To Build a Model Number".
- Any special service required.

Note: • The indicates that a choice is required.

- The absence of the indicates that no choice is required.
- Alpha-numeric characters in place of indicate that no other alternatives are available.

HOW TO BUILD A MODEL NUMBER

- A** Select basic model.
- B** Select pull option.
CLSC - Classic (inset pull)
- C** Select unit and drawer color.
Refer to color addendum at ki.com or KI Fabrics & Finishes binder.
- D** Select counterbalance weight.
CBW - With Counterbalance
NOCBW - No Counterbalance
See pricing column for counterbalance weight upcharge.
- E** Select key option.
KA - Key alike
KS - Key standard
NLC - No lock core

INFORMATION

Folder Bars

Files are configured for side-to-side media storage. For alternative configurations, see the General Information section.

Height

All dimensions shown include 1/8" allowance for glides in recessed position.

Accessories

See accessory section for accessories that can be ordered separately.

Weights

Figures provided are approximate and reflect packaged product without additional accessories.



Preconfigured Lateral Files

700 Series® Receding Door Units

Delivered Pricing	Counter-balance Weight add to list price
\$ 819	\$ 161
921	161
1004	161
<hr/>	
\$ 1098	\$ 161
1242	161
1385	161
<hr/>	
\$ 1375	\$ 125
1605	125
1822	125

SPECIAL SERVICES

Special Carton Marking

With specially marked information N/C

Shipping

Shipped **assembled freight prepaid f.o.b. Pembroke, Ontario K8A 0E1** factory. Freight class #70.

Specifications and prices are subject to change without prior notice.

Preconfigured Lateral Files

700 Series® Receding Door Units

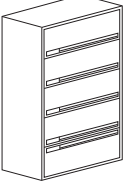
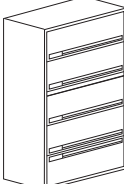
	MODEL	W x D x H	MODEL NUMBER					Approx. Packaged Weight
			Basic Model	Pull Option	Unit Color	Optional Counterbalance Weight	Key Option	
	63-3/4" File, 5 High	30 x 18 x 63-3/4"	S7L/306005R	CLSC	<input type="checkbox"/>	<input type="checkbox"/>	<input type="checkbox"/>	240.0#
	• One 12" receding door/rollout shelf with 3 plate dividers	36 x 18 x 63-3/4"	S7L/366005R	CLSC	<input type="checkbox"/>	<input type="checkbox"/>	<input type="checkbox"/>	260.0#
	• Three 12" receding doors/rollout shelves with FBA folder bars	42 x 18 x 63-3/4"	S7L/426005R	CLSC	<input type="checkbox"/>	<input type="checkbox"/>	<input type="checkbox"/>	280.0#
	• One 12" drawer with FBA folder bars							
	• Counterbalance weights are recommended for freestanding units							
S7LTU								
	65-9/32" File, 5 High	30 x 18 x 65-9/32"	S7L/306155R	CLSC	<input type="checkbox"/>	<input type="checkbox"/>	<input type="checkbox"/>	204.0#
	• One 12" receding door/rollout shelf with 3 plate dividers	30 x 18 x 65-9/32"	S7L/306155RP	CLSC	<input type="checkbox"/>	<input type="checkbox"/>	<input type="checkbox"/>	255.0#
	• Three 12" receding door/rollout shelves with FBA folder bars	36 x 18 x 65-9/32"	S7L/366155R	CLSC	<input type="checkbox"/>	<input type="checkbox"/>	<input type="checkbox"/>	260.0#
	• One 1-1/2" tie bar or posting shelf	36 x 18 x 65-9/32"	S7L/366155RP	CLSC	<input type="checkbox"/>	<input type="checkbox"/>	<input type="checkbox"/>	270.0#
	• One 12" drawer with FBA folder bars	42 x 18 x 65-9/32"	S7L/426155R	CLSC	<input type="checkbox"/>	<input type="checkbox"/>	<input type="checkbox"/>	280.0#
	• Counterbalance weights are recommended for freestanding units	42 x 18 x 65-9/32"	S7L/426155RP	CLSC	<input type="checkbox"/>	<input type="checkbox"/>	<input type="checkbox"/>	315.0#
	• RP model replaces 1-1/2" tie bar with a 1-1/2" posting shelf							
S7LTU								
			A	B	C	D	E	

HOW TO ORDER

Indicate the following information on order form:

- Quantity of each item.
- Model number, including options. See "How To Build a Model Number".
- Any special service required.

Note: • The indicates that a choice is required.

- The absence of the indicates that no choice is required.
- Alpha-numeric characters in place of indicate that no other alternatives are available.

HOW TO BUILD A MODEL NUMBER

- A** Select basic model.
- B** Select pull option.
CLSC - Classic (inset pull)
- C** Select unit and drawer color.
Refer to color addendum at ki.com or KI Fabrics & Finishes binder.
- D** Select counterbalance weight.
CBW - With Counterbalance
NOCBW - No Counterbalance
See pricing column for counterbalance weight upcharge.
- E** Select key option.
KA - Key alike
KS - Key standard
NLC - No lock core

INFORMATION

Folder Bars

Files are configured for side-to-side media storage. For alternative configurations, see the General Information section.

Height

All dimensions shown include 1/8" allowance for glides in recessed position.

Accessories

See accessory section for accessories that can be ordered separately.

Weights

Figures provided are approximate and reflect packaged product without additional accessories.



Preconfigured Lateral Files

700 Series® Receding Door Units

Delivered Pricing	Counter-balance Weight add to list price
\$ 1639	\$ 125
1877	125
2124	125
\$ 1693	\$ 125
1783	125
1862	125
1877	125
2037	125
2124	125

SPECIAL SERVICES

Special Carton Marking

With specially marked information N/C



Shipping

Shipped **assembled freight prepaid f.o.b. Pembroke, Ontario K8A 0E1** factory. Freight class #70.

Specifications and prices are subject to change without prior notice.

Preconfigured Lateral Files

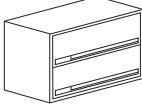
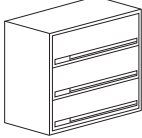
700 Series® End Tab Shelving Units

	MODEL	W x D x H	MODEL NUMBER				Approx. Packaged Weight
			Basic Model	Pull Option	Unit Color	Key Option	
 <p>27" File, 2 High</p> <ul style="list-style-type: none"> Two 12" receding doors with fixed end tab shelves Three plate dividers per opening 		30 x 18 x 27"	S7L/302402E	CLSC	<input type="checkbox"/> <input type="checkbox"/>	<input type="checkbox"/> <input type="checkbox"/> <input type="checkbox"/> <input type="checkbox"/>	110.0#
		36 x 18 x 27"	S7L/362402E	CLSC	<input type="checkbox"/> <input type="checkbox"/>	<input type="checkbox"/> <input type="checkbox"/> <input type="checkbox"/> <input type="checkbox"/>	120.0#
		42 x 18 x 27"	S7L/422402E	CLSC	<input type="checkbox"/> <input type="checkbox"/>	<input type="checkbox"/> <input type="checkbox"/> <input type="checkbox"/> <input type="checkbox"/>	140.0#
S7LTU							
 <p>39-1/4" File, 3 High</p> <ul style="list-style-type: none"> Three 12" receding doors with fixed end tab shelves Three plate dividers per opening 		30 x 18 x 39-1/4"	S7L/303603E	CLSC	<input type="checkbox"/> <input type="checkbox"/>	<input type="checkbox"/> <input type="checkbox"/> <input type="checkbox"/> <input type="checkbox"/>	150.0#
		36 x 18 x 39-1/4"	S7L/363603E	CLSC	<input type="checkbox"/> <input type="checkbox"/>	<input type="checkbox"/> <input type="checkbox"/> <input type="checkbox"/> <input type="checkbox"/>	165.0#
		42 x 18 x 39-1/4"	S7L/423603E	CLSC	<input type="checkbox"/> <input type="checkbox"/>	<input type="checkbox"/> <input type="checkbox"/> <input type="checkbox"/> <input type="checkbox"/>	185.0#
S7LTU							
 <p>51-1/2" File, 4 High</p> <ul style="list-style-type: none"> Four 12" receding doors with fixed end tab shelves Three plate dividers per opening Lock included 		30 x 18 x 51-1/2"	S7L/304804E	CLSC	<input type="checkbox"/> <input type="checkbox"/>	<input type="checkbox"/> <input type="checkbox"/> <input type="checkbox"/> <input type="checkbox"/>	195.0#
		36 x 18 x 51-1/2"	S7L/364804E	CLSC	<input type="checkbox"/> <input type="checkbox"/>	<input type="checkbox"/> <input type="checkbox"/> <input type="checkbox"/> <input type="checkbox"/>	210.0#
		42 x 18 x 51-1/2"	S7L/424804E	CLSC	<input type="checkbox"/> <input type="checkbox"/>	<input type="checkbox"/> <input type="checkbox"/> <input type="checkbox"/> <input type="checkbox"/>	230.0#
S7LTU							

A

B

C

D

HOW TO ORDER

Indicate the following information on order form:

- Quantity of each item.
- Model number, including options. See "How To Build a Model Number".
- Any special service required.

Note: • The indicates that a choice is required.

- The absence of the indicates that no choice is required.
- Alpha-numeric characters in place of indicate that no other alternatives are available.

HOW TO BUILD A MODEL NUMBER

- A** Select basic model.
- B** Select pull option.
CLSC - Classic (inset pull)
- C** Select unit and drawer color.
Refer to color addendum at ki.com or KI Fabrics & Finishes binder.
- D** Select key option.
KA - Key alike
KS - Key standard
NLC - No lock core

INFORMATION

Height

All dimensions shown include 1/8" allowance for glides in recessed position.

Accessories

See accessory section for accessories that can be ordered separately.

Weights

Figures provided are approximate and reflect packaged product without additional accessories.



Preconfigured Lateral Files

700 Series® End Tab Shelving Units

Delivered
Pricing

\$ 886
991
1075

\$ 1195
1336
1483

\$ 1496
1736
1950

SPECIAL SERVICES

Special Carton Marking

With specially marked information N/C

Shipping

Shipped **assembled freight prepaid f.o.b. Pembroke, Ontario K8A 0E1** factory.
Freight class #70.

Specifications and prices are subject to change without prior notice.

Preconfigured Lateral Files

700 Series® End Tab Shelving Units

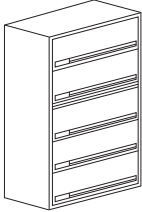
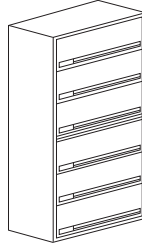
	MODEL	W x D x H	MODEL NUMBER				Approx. Packaged Weight
			Basic Model	Pull Option	Unit Color	Key Option	
	65-9/32" File, 5 High • Two 12" receding doors with fixed end tab shelves • 1-1/2" tie bar • Three 12" receding doors with fixed end tab shelves • Three plate dividers per opening	30 x 18 x 65-9/32"	S7L/306155E	CLSC	<input type="checkbox"/> <input type="checkbox"/>	<input type="checkbox"/> <input type="checkbox"/> <input type="checkbox"/>	220.0#
		36 x 18 x 65-9/32"	S7L/366155E	CLSC	<input type="checkbox"/> <input type="checkbox"/>	<input type="checkbox"/> <input type="checkbox"/> <input type="checkbox"/>	245.0#
		42 x 18 x 65-9/32"	S7L/426155E	CLSC	<input type="checkbox"/> <input type="checkbox"/>	<input type="checkbox"/> <input type="checkbox"/> <input type="checkbox"/>	280.0#
S7LTU							
	77-17/32" File, 6 High • Three 12" receding doors with fixed end tab shelves • 1-1/2" tie bar on 30" and 36" wide • 1-1/2" structural filler shelf on 42" wide • Three 12" receding doors with fixed end tab shelves • Three plate dividers per opening	30 x 18 x 77-17/32"	S7L/307356E	CLSC	<input type="checkbox"/> <input type="checkbox"/>	<input type="checkbox"/> <input type="checkbox"/> <input type="checkbox"/>	245.0#
		36 x 18 x 77-17/32"	S7L/367356E	CLSC	<input type="checkbox"/> <input type="checkbox"/>	<input type="checkbox"/> <input type="checkbox"/> <input type="checkbox"/>	280.0#
		42 x 18 x 77-17/32"	S7L/427356E	CLSC	<input type="checkbox"/> <input type="checkbox"/>	<input type="checkbox"/> <input type="checkbox"/> <input type="checkbox"/>	325.0#
S7LTU							
			A	B	C	D	

HOW TO ORDER

Indicate the following information on order form:

- Quantity of each item.
- Model number, including options. See "How To Build a Model Number".
- Any special service required.

Note: • The indicates that a choice is required.

- The absence of the indicates that no choice is required.
- Alpha-numeric characters in place of indicate that no other alternatives are available.

HOW TO BUILD A MODEL NUMBER

- A** Select basic model.
- B** Select pull option.
CLSC - Classic (inset pull)
- C** Select unit and drawer color.
 Refer to color addendum at ki.com or KI Fabrics & Finishes binder.
- D** Select key option.
KA - Key alike
KS - Key standard
NLC - No lock core

INFORMATION

Height

All dimensions shown include 1/8" allowance for glides in recessed position.

Accessories

See accessory section for accessories that can be ordered separately.

Weights

Figures provided are approximate and reflect packaged product without additional accessories.



Preconfigured Lateral Files

700 Series® End Tab Shelving Units

Delivered
Pricing

\$ 1784
2022
2274

\$ 2165
2460
2805

SPECIAL SERVICES

Special Carton Marking

With specially marked information N/C

Shipping

Shipped **assembled freight prepaid f.o.b. Pembroke, Ontario K8A 0E1** factory.
Freight class #70.

Specifications and prices are subject to change without prior notice.

Preconfigured Lateral Files

700 Series® Credenza Files

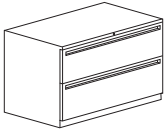
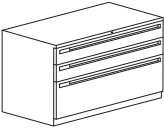
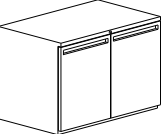
	MODEL	W x D	MODEL NUMBER					Approx. Packaged Weight
			Basic Model	Pull Option	Unit Color	Optional Counterbalance Weight	Key Option	
 <p>S7LTU</p>	27-7/8" Credenza File - FF • Height to match worksurface supporting pedestal, drawer fronts compatible with all pedestals • Two 12" file drawers with FBA bars for side-to-side filing • Counterbalance weights are recommended for freestanding units	30 x 18-7/8 x 27-7/8"	S7L/30240FF	<input type="checkbox"/> <input type="checkbox"/> <input type="checkbox"/> <input type="checkbox"/>	<input type="checkbox"/>	<input type="checkbox"/> <input type="checkbox"/> <input type="checkbox"/> <input type="checkbox"/> <input type="checkbox"/> <input type="checkbox"/>	<input type="checkbox"/> <input type="checkbox"/>	120.0#
		36 x 18-7/8 x 27-7/8"	S7L/36240FF	<input type="checkbox"/> <input type="checkbox"/> <input type="checkbox"/> <input type="checkbox"/>	<input type="checkbox"/>	<input type="checkbox"/> <input type="checkbox"/> <input type="checkbox"/> <input type="checkbox"/> <input type="checkbox"/> <input type="checkbox"/>	<input type="checkbox"/> <input type="checkbox"/>	130.0#
		42 x 18-7/8 x 27-7/8"	S7L/42240FF	<input type="checkbox"/> <input type="checkbox"/> <input type="checkbox"/> <input type="checkbox"/>	<input type="checkbox"/>	<input type="checkbox"/> <input type="checkbox"/> <input type="checkbox"/> <input type="checkbox"/> <input type="checkbox"/> <input type="checkbox"/>	<input type="checkbox"/> <input type="checkbox"/>	145.0#
 <p>S7LTU</p>	27-7/8" Credenza File - BBF • Height to match worksurface supporting pedestal, drawer fronts compatible with all pedestals • Two 6" box drawers, one 12" file drawer with FBA bars for side-to-side filing • Counterbalance weights are recommended for freestanding units	30 x 18-7/8 x 27-7/8"	S7L/30240BBF	<input type="checkbox"/> <input type="checkbox"/> <input type="checkbox"/> <input type="checkbox"/>	<input type="checkbox"/>	<input type="checkbox"/> <input type="checkbox"/> <input type="checkbox"/> <input type="checkbox"/> <input type="checkbox"/> <input type="checkbox"/>	<input type="checkbox"/> <input type="checkbox"/>	135.0#
		36 x 18-7/8 x 27-7/8"	S7L/36240BBF	<input type="checkbox"/> <input type="checkbox"/> <input type="checkbox"/> <input type="checkbox"/>	<input type="checkbox"/>	<input type="checkbox"/> <input type="checkbox"/> <input type="checkbox"/> <input type="checkbox"/> <input type="checkbox"/> <input type="checkbox"/>	<input type="checkbox"/> <input type="checkbox"/>	145.0#
		42 x 18-7/8 x 27-7/8"	S7L/42240BBF	<input type="checkbox"/> <input type="checkbox"/> <input type="checkbox"/> <input type="checkbox"/>	<input type="checkbox"/>	<input type="checkbox"/> <input type="checkbox"/> <input type="checkbox"/> <input type="checkbox"/> <input type="checkbox"/> <input type="checkbox"/>	<input type="checkbox"/> <input type="checkbox"/>	160.0#
 <p>S7CBU</p>	27-7/8" Credenza Cupboard • Height to match worksurface supporting pedestal • One adjustable shelf	30 x 18-7/8 x 27-7/8"	S7L/30240CC	<input type="checkbox"/> <input type="checkbox"/> <input type="checkbox"/> <input type="checkbox"/>	<input type="checkbox"/>		<input type="checkbox"/> <input type="checkbox"/>	95.0#
		36 x 18-7/8 x 27-7/8"	S7L/36240CC	<input type="checkbox"/> <input type="checkbox"/> <input type="checkbox"/> <input type="checkbox"/>	<input type="checkbox"/>		<input type="checkbox"/> <input type="checkbox"/>	105.0#
		42 x 18-7/8 x 27-7/8"	S7L/42240CC	<input type="checkbox"/> <input type="checkbox"/> <input type="checkbox"/> <input type="checkbox"/>	<input type="checkbox"/>		<input type="checkbox"/> <input type="checkbox"/>	121.0#
				A	B	C	D	E

HOW TO ORDER

Indicate the following information on order form:

- Quantity of each item.
- Model number, including options. See "How To Build a Model Number".
- Any special service required.

Note: • The indicates that a choice is required.

- The absence of the indicates that no choice is required.
- Alpha-numeric characters in place of indicate that no other alternatives are available.

HOW TO BUILD A MODEL NUMBER

NLC - No lock core

- A** Select basic model.
- B** Select pull option.
- ALBT** - Aluminum Bow Tie
ALMT - Aluminum Metric
ARCN - Arc Nickel
CLSC - Classic (inset pull)
NKBT - Nickel Bow Tie
RETN - Retro Nickel
- C** Select unit and drawer color.
 Refer to color addendum at ki.com or KI Fabrics & Finishes binder.
- D** Select counterbalance weight.
- CBW** - With Counterbalance
NOCBW - No Counterbalance
 See pricing column for counterbalance weight upcharge.
- E** Select key option.
- KA** - Key alike
KS - Key standard

INFORMATION

Height

All dimensions shown include 1/4" allowance for glides in recessed position.

Accessories

See accessory section for accessories that can be ordered separately.

Weights

Figures provided are approximate and reflect packaged product without additional accessories.



Preconfigured Lateral Files

700 Series® Credenza Files

Delivered Pricing	Counter-balance Weight add to list price
\$ 1060	\$ 201
1135	201
1210	201
\$ 1244	\$ 201
1320	201
1401	201
\$ 983	N/A
1056	N/A
1107	N/A

SPECIAL SERVICES

Special Carton Marking

With specially marked information N/C

Shipping

Shipped **assembled freight prepaid f.o.b. Pembroke, Ontario K8A 0E1** factory.
Freight class #70.

Specifications and prices are subject to change without prior notice.

Preconfigured Lateral Files

700 Series® OF Flush Top No Fronts

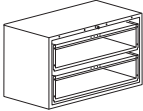
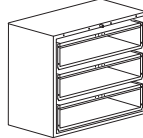
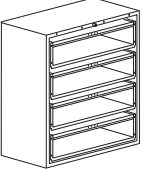
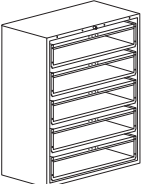
	MODEL	W x D	MODEL NUMBER				Approx. Packaged Weight
			Basic Model	Unit Color	Optional Counterbalance Weight	Key Option	
 S7LOU	27" File, 2 High • No drawer fronts • Two drawer bodies to accept 12" fronts • Depth dimension does not include thickness of drawer front • With FBA bars, lock included • Hardware included • Counterbalance weights are recommended for freestanding units	30 x 18"	S7LF/302402DX	<input type="checkbox"/>	<input type="checkbox"/> <input type="checkbox"/> <input type="checkbox"/> <input type="checkbox"/>	<input type="checkbox"/> <input type="checkbox"/>	100.0#
		36 x 18"	S7LF/362402DX	<input type="checkbox"/>	<input type="checkbox"/> <input type="checkbox"/> <input type="checkbox"/> <input type="checkbox"/>	<input type="checkbox"/> <input type="checkbox"/>	110.0#
		42 x 18"	S7LF/422402DX	<input type="checkbox"/>	<input type="checkbox"/> <input type="checkbox"/> <input type="checkbox"/> <input type="checkbox"/>	<input type="checkbox"/> <input type="checkbox"/>	120.0#
 S7LOU	39-1/4" File, 3 High • No drawer fronts • Three drawer bodies to accept 12" fronts • Depth dimension does not include thickness of drawer front • With FBA bars, lock included • Hardware included • Counterbalance weights are recommended for freestanding units	30 x 18"	S7LF/303603DX	<input type="checkbox"/>	<input type="checkbox"/> <input type="checkbox"/> <input type="checkbox"/> <input type="checkbox"/>	<input type="checkbox"/> <input type="checkbox"/>	125.0#
		36 x 18"	S7LF/363603DX	<input type="checkbox"/>	<input type="checkbox"/> <input type="checkbox"/> <input type="checkbox"/> <input type="checkbox"/>	<input type="checkbox"/> <input type="checkbox"/>	135.0#
		42 x 18"	S7LF/423603DX	<input type="checkbox"/>	<input type="checkbox"/> <input type="checkbox"/> <input type="checkbox"/> <input type="checkbox"/>	<input type="checkbox"/> <input type="checkbox"/>	155.0#
 S7LOU	51-1/2" File, 4 High • No drawer fronts • Four drawer bodies to accept 12" fronts • Depth dimension does not include thickness of drawer front • With FBA bars, lock included • Hardware included • Counterbalance weights are recommended for freestanding units	30 x 18"	S7LF/304804DX	<input type="checkbox"/>	<input type="checkbox"/> <input type="checkbox"/> <input type="checkbox"/> <input type="checkbox"/>	<input type="checkbox"/> <input type="checkbox"/>	160.0#
		36 x 18"	S7LF/364804DX	<input type="checkbox"/>	<input type="checkbox"/> <input type="checkbox"/> <input type="checkbox"/> <input type="checkbox"/>	<input type="checkbox"/> <input type="checkbox"/>	180.0#
		42 x 18"	S7LF/424804DX	<input type="checkbox"/>	<input type="checkbox"/> <input type="checkbox"/> <input type="checkbox"/> <input type="checkbox"/>	<input type="checkbox"/> <input type="checkbox"/>	200.0#
 S7LOU	56-3/32" File, 5 High • No drawer fronts • Five drawer bodies to accept 10-1/2" fronts • Depth dimension does not include thickness of drawer front • With FBA bars, lock included • Drawer bodies will not accept plate dividers • Hardware included • Counterbalance weights are recommended for freestanding units	30 x 18"	S7LF/305255DX	<input type="checkbox"/>	<input type="checkbox"/> <input type="checkbox"/> <input type="checkbox"/> <input type="checkbox"/>	<input type="checkbox"/> <input type="checkbox"/>	175.0#
		36 x 18"	S7LF/365255DX	<input type="checkbox"/>	<input type="checkbox"/> <input type="checkbox"/> <input type="checkbox"/> <input type="checkbox"/>	<input type="checkbox"/> <input type="checkbox"/>	190.0#
		42 x 18"	S7LF/425255DX	<input type="checkbox"/>	<input type="checkbox"/> <input type="checkbox"/> <input type="checkbox"/> <input type="checkbox"/>	<input type="checkbox"/> <input type="checkbox"/>	205.0#

A

B

C

D

HOW TO ORDER

Indicate the following information on order form:

- Quantity of each item.
- Model number, including options. See "How To Build a Model Number".
- Any special service required.

Note: • The indicates that a choice is required.

- The absence of the indicates that no choice is required.
- Alpha-numeric characters in place of indicate that no other alternatives are available.

HOW TO BUILD A MODEL NUMBER

- A** Select basic model.
- B** Select unit color.
Refer to color addendum at ki.com or KI Fabrics & Finishes binder.
- C** Select counterbalance weight.
CBW - With Counterbalance
NOCBW - No Counterbalance
 See pricing column for counterbalance weight upcharge.
- D** Select key option.
KA - Key alike
KS - Key standard
NLC - No lock core

INFORMATION

Folder Bars

Files are configured for side-to-side media storage. For alternative configurations, see the General Information section.

Height

All dimensions shown include 1/8" allowance for glides in recessed position.

Accessories

See accessory section for accessories that can be ordered separately.

Weights

Figures provided are approximate and reflect packaged product without additional accessories.



Preconfigured Lateral Files

700 Series® OF Flush Top No Fronts

Delivered Pricing	Counter-balance Weight add to list price
\$ 814	\$ 201
870	201
935	201
<hr/>	
\$ 1075	\$ 201
1210	201
1342	201
<hr/>	
\$ 1320	\$ 161
1529	161
1711	161
<hr/>	
\$ 1580	\$ 161
1784	161
1965	161

SPECIAL SERVICES

Special Carton Marking

With specially marked information N/C

Shipping

Shipped **assembled freight prepaid f.o.b. Pembroke, Ontario K8A 0E1** factory. Freight class #70.

Specifications and prices are subject to change without prior notice.

Preconfigured Lateral Files

700 Series® OF Extended Top No Fronts

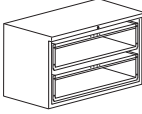
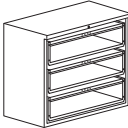
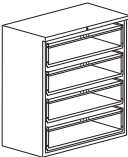
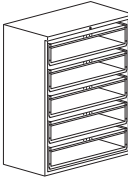
	MODEL	W x D	MODEL NUMBER				Approx. Packaged Weight
			Basic Model	Unit Color	Optional Counterbalance Weight	Key Option	
 <p>S7LOU</p>	27" File, 2 High • No drawer fronts • Two drawer bodies to accept 12" fronts • With FBA bars, lock included • Hardware included • Counterbalance weights are recommended for freestanding units	30 x 18-7/8"	S7LE/302402DX	<input type="checkbox"/>	<input type="checkbox"/>	<input type="checkbox"/>	100.0#
		36 x 18-7/8"	S7LE/362402DX	<input type="checkbox"/>	<input type="checkbox"/>	<input type="checkbox"/>	110.0#
		42 x 18-7/8"	S7LE/422402DX	<input type="checkbox"/>	<input type="checkbox"/>	<input type="checkbox"/>	120.0#
 <p>S7LOU</p>	39-1/4" File, 3 High • No drawer fronts • Three drawer bodies to accept 12" fronts • With FBA bars, lock included • Hardware included • Counterbalance weights are recommended for freestanding units	30 x 18-7/8"	S7LE/303603DX	<input type="checkbox"/>	<input type="checkbox"/>	<input type="checkbox"/>	125.0#
		36 x 18-7/8"	S7LE/363603DX	<input type="checkbox"/>	<input type="checkbox"/>	<input type="checkbox"/>	135.0#
		42 x 18-7/8"	S7LE/423603DX	<input type="checkbox"/>	<input type="checkbox"/>	<input type="checkbox"/>	155.0#
 <p>S7LOU</p>	51-1/2" File, 4 High • No drawer fronts • Four drawer bodies to accept 12" fronts • With FBA bars, lock included • Hardware included • Counterbalance weights are recommended for freestanding units	30 x 18-7/8"	S7LE/304804DX	<input type="checkbox"/>	<input type="checkbox"/>	<input type="checkbox"/>	160.0#
		36 x 18-7/8"	S7LE/364804DX	<input type="checkbox"/>	<input type="checkbox"/>	<input type="checkbox"/>	180.0#
		42 x 18-7/8"	S7LE/424804DX	<input type="checkbox"/>	<input type="checkbox"/>	<input type="checkbox"/>	200.0#
 <p>S7LOU</p>	56-3/32" File, 5 High • No drawer fronts • Five drawer bodies to accept 10-1/2" fronts • With FBA bars, lock included • Drawer bodies will not accept plate dividers • Hardware included • Counterbalance weights are recommended for freestanding units	30 x 18-7/8"	S7LE/305255DX	<input type="checkbox"/>	<input type="checkbox"/>	<input type="checkbox"/>	175.0#
		36 x 18-7/8"	S7LE/365255DX	<input type="checkbox"/>	<input type="checkbox"/>	<input type="checkbox"/>	190.0#
		42 x 18-7/8"	S7LE/425255DX	<input type="checkbox"/>	<input type="checkbox"/>	<input type="checkbox"/>	205.0#

A

B

C

D

HOW TO ORDER

Indicate the following information on order form:

- Quantity of each item.
- Model number, including options. See "How To Build a Model Number".
- Any special service required.

Note: • The indicates that a choice is required.

- The absence of the indicates that no choice is required.
- Alpha-numeric characters in place of indicate that no other alternatives are available.

HOW TO BUILD A MODEL NUMBER

- A** Select basic model.
- B** Select unit color.
Refer to color addendum at ki.com or KI Fabrics & Finishes binder.
- C** Select counterbalance weight.
CBW - With Counterbalance
NOCBW - No Counterbalance
 See pricing column for counterbalance weight upcharge.
- D** Select key option.
KA - Key alike
KS - Key standard
NLC - No lock core

INFORMATION

Folder Bars

Files are configured for side-to-side media storage. For alternative configurations, see the General Information section.

Height

All dimensions shown include 1/8" allowance for glides in recessed position.

Accessories

See accessory section for accessories that can be ordered separately.

Weights

Figures provided are approximate and reflect packaged product without additional accessories.



Preconfigured Lateral Files

700 Series® OF Extended Top No Fronts

Delivered Pricing	Counter-balance Weight add to list price
\$ 814	\$ 201
870	201
935	201
<hr/>	
\$ 1075	\$ 201
1210	201
1342	201
<hr/>	
\$ 1320	\$ 161
1529	161
1711	161
<hr/>	
\$ 1580	\$ 161
1784	161
1965	161

SPECIAL SERVICES

Special Carton Marking

With specially marked information N/C



Shipping

Shipped **assembled freight prepaid f.o.b. Pembroke, Ontario K8A 0E1** factory. Freight class #70.

Specifications and prices are subject to change without prior notice.

Preconfigured Lateral Files

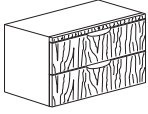
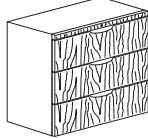
700 Series® OF Flush Top Wood Fronts

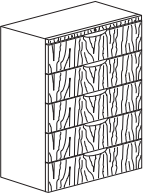
MODEL	W x D	MODEL NUMBER					
		Basic Model	Unit Color	Veneer Color	Pull Color Optional Front	Optional Counterbalance Weight	Key Option
 <p>27" File, 2 High</p> <ul style="list-style-type: none"> Two 12" drawers, wood veneer fronts and center pulls With FBA bars, lock included Counterbalance weights are recommended for freestanding units 	30 x 18-7/8"	S7LF/302402DW1	<input type="checkbox"/>	<input type="checkbox"/>	<input type="checkbox"/>	<input type="checkbox"/>	<input type="checkbox"/>
	36 x 18-7/8"	S7LF/362402DW1	<input type="checkbox"/>	<input type="checkbox"/>	<input type="checkbox"/>	<input type="checkbox"/>	<input type="checkbox"/>
	42 x 18-7/8"	S7LF/422402DW1	<input type="checkbox"/>	<input type="checkbox"/>	<input type="checkbox"/>	<input type="checkbox"/>	<input type="checkbox"/>
S7LOU							
 <p>39-1/4" File, 3 High</p> <ul style="list-style-type: none"> Three 12" drawers, wood veneer fronts and center pulls With FBA bars, lock included Counterbalance weights are recommended for freestanding units 	30 x 18-7/8"	S7LF/303603DW1	<input type="checkbox"/>	<input type="checkbox"/>	<input type="checkbox"/>	<input type="checkbox"/>	<input type="checkbox"/>
	36 x 18-7/8"	S7LF/363603DW1	<input type="checkbox"/>	<input type="checkbox"/>	<input type="checkbox"/>	<input type="checkbox"/>	<input type="checkbox"/>
	42 x 18-7/8"	S7LF/423603DW1	<input type="checkbox"/>	<input type="checkbox"/>	<input type="checkbox"/>	<input type="checkbox"/>	<input type="checkbox"/>
S7LOU							
 <p>51-1/2" File, 4 High</p> <ul style="list-style-type: none"> Four 12" drawers, wood veneer fronts and center pulls With FBA bars, lock included Counterbalance weights are recommended for freestanding units 	30 x 18-7/8"	S7LF/304804DW1	<input type="checkbox"/>	<input type="checkbox"/>	<input type="checkbox"/>	<input type="checkbox"/>	<input type="checkbox"/>
	36 x 18-7/8"	S7LF/364804DW1	<input type="checkbox"/>	<input type="checkbox"/>	<input type="checkbox"/>	<input type="checkbox"/>	<input type="checkbox"/>
	42 x 18-7/8"	S7LF/424804DW1	<input type="checkbox"/>	<input type="checkbox"/>	<input type="checkbox"/>	<input type="checkbox"/>	<input type="checkbox"/>
S7LOU							
 <p>56-3/32" File, 5 High</p> <ul style="list-style-type: none"> Five 10-1/2" drawers, wood veneer fronts and center pulls With FBA bars, lock included Drawer bodies will not accept plate dividers Counterbalance weights are recommended for freestanding units 	30 x 18-7/8"	S7LF/305255DW1	<input type="checkbox"/>	<input type="checkbox"/>	<input type="checkbox"/>	<input type="checkbox"/>	<input type="checkbox"/>
	36 x 18-7/8"	S7LF/365255DW1	<input type="checkbox"/>	<input type="checkbox"/>	<input type="checkbox"/>	<input type="checkbox"/>	<input type="checkbox"/>
	42 x 18-7/8"	S7LF/425255DW1	<input type="checkbox"/>	<input type="checkbox"/>	<input type="checkbox"/>	<input type="checkbox"/>	<input type="checkbox"/>
S7LOU							

A **B** **C** **D** **E** **F**

HOW TO ORDER

Indicate the following information on order form:

- Quantity of each item.
- Model number, including options. See "How To Build a Model Number".
- Any special service required.

Note: • The indicates that a choice is required.

- The absence of the indicates that no choice is required.
- Alpha-numeric characters in place of indicate that no other alternatives are available.

HOW TO BUILD A MODEL NUMBER

NLC - No lock core

- A** Select basic model.
- B** Select unit color.
Refer to color addendum at ki.com or KI Fabrics & Finishes binder.
- C** Select veneer color.
Refer to color addendum at ki.com or KI Fabrics & Finishes binder.
- D** Select pull color optional front.
Refer to color addendum at ki.com or KI Fabrics & Finishes binder.
- E** Select counterbalance weight.

CBW	- With Counterbalance
NOCBW	- No Counterbalance

 See pricing column for counterbalance weight upcharge.
- F** Select key option.

KA	- Key alike
KS	- Key standard

INFORMATION

Folder Bars

Files are configured for side-to-side media storage. For alternative configurations, see the General Information section.

Height

All dimensions shown include 1/8" allowance for glides in recessed position.

Accessories

See accessory section for accessories that can be ordered separately.

Weights

Figures provided are approximate and reflect packaged product without additional accessories.



Preconfigured Lateral Files

700 Series® OF Flush Top Wood Fronts

Approx. Packaged Weight	Delivered Pricing	Counter-balance Weight add to list price
120.0#	\$ 1466	\$ 201
130.0#	1646	201
150.0#	1694	201
<hr/>		
155.0#	\$ 2012	\$ 201
165.0#	2192	201
185.0#	2399	201
<hr/>		
200.0#	\$ 2578	\$ 161
220.0#	2760	161
240.0#	2967	161
<hr/>		
225.0#	\$ 3146	\$ 161
240.0#	3316	161
255.0#	3514	161

SPECIAL SERVICES

Special Carton Marking

With specially marked information N/C

Shipping

Shipped **assembled freight prepaid f.o.b. Pembroke, Ontario K8A 0E1** factory. Freight class #70.

Specifications and prices are subject to change without prior notice.

Preconfigured Lateral Files

700 Series® OF Extended Top Laminate Front

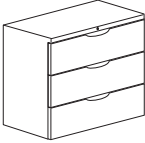
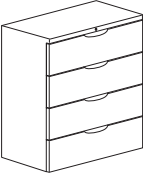
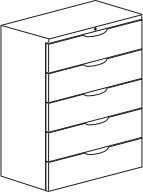
			MODEL NUMBER					
MODEL	W x D	Basic Model	Unit Color	Front Surface Finish	Pull Color Optional Front	Optional Counterbalance Weight	Key Option	
 <p>27" File, 2 High</p> <ul style="list-style-type: none"> Two 12" drawers, laminate fronts and center pulls With FBA bars, lock included Counterbalance weights are recommended with freestanding units 	30 x 18-7/8"	S7LE/302402DL1	<input type="checkbox"/>	<input type="checkbox"/>	<input type="checkbox"/>	<input type="checkbox"/>	<input type="checkbox"/>	
	36 x 18-7/8"	S7LE/362402DL1	<input type="checkbox"/>	<input type="checkbox"/>	<input type="checkbox"/>	<input type="checkbox"/>	<input type="checkbox"/>	
	42 x 18-7/8"	S7LE/422402DL1	<input type="checkbox"/>	<input type="checkbox"/>	<input type="checkbox"/>	<input type="checkbox"/>	<input type="checkbox"/>	
S7LOU								
 <p>39-1/4" File, 3 High</p> <ul style="list-style-type: none"> Three 12" drawers, laminate fronts and center pulls With FBA bars, lock included Counterbalance weights are recommended for freestanding units 	30 x 18-7/8"	S7LE/303603DL1	<input type="checkbox"/>	<input type="checkbox"/>	<input type="checkbox"/>	<input type="checkbox"/>	<input type="checkbox"/>	
	36 x 18-7/8"	S7LE/363603DL1	<input type="checkbox"/>	<input type="checkbox"/>	<input type="checkbox"/>	<input type="checkbox"/>	<input type="checkbox"/>	
	42 x 18-7/8"	S7LE/423603DL1	<input type="checkbox"/>	<input type="checkbox"/>	<input type="checkbox"/>	<input type="checkbox"/>	<input type="checkbox"/>	
S7LOU								
 <p>51-1/2" File, 4 High</p> <ul style="list-style-type: none"> Four 12" drawers, laminate fronts and center pulls With FBA bars, lock included Counterbalance weights are recommended for freestanding units 	30 x 18-7/8"	S7LE/304804DL1	<input type="checkbox"/>	<input type="checkbox"/>	<input type="checkbox"/>	<input type="checkbox"/>	<input type="checkbox"/>	
	36 x 18-7/8"	S7LE/364804DL1	<input type="checkbox"/>	<input type="checkbox"/>	<input type="checkbox"/>	<input type="checkbox"/>	<input type="checkbox"/>	
	42 x 18-7/8"	S7LE/424804DL1	<input type="checkbox"/>	<input type="checkbox"/>	<input type="checkbox"/>	<input type="checkbox"/>	<input type="checkbox"/>	
S7LOU								
 <p>56-3/32" File, 5 High</p> <ul style="list-style-type: none"> Five 10-1/2" drawers, laminate fronts and center pulls With FBA bars, lock included Counterbalance weights are recommended for freestanding units Drawer bodies will not accept plate dividers 	30 x 18-7/8"	S7LE/305255DL1	<input type="checkbox"/>	<input type="checkbox"/>	<input type="checkbox"/>	<input type="checkbox"/>	<input type="checkbox"/>	
	36 x 18-7/8"	S7LE/365255DL1	<input type="checkbox"/>	<input type="checkbox"/>	<input type="checkbox"/>	<input type="checkbox"/>	<input type="checkbox"/>	
	42 x 18-7/8"	S7LE/425255DL1	<input type="checkbox"/>	<input type="checkbox"/>	<input type="checkbox"/>	<input type="checkbox"/>	<input type="checkbox"/>	
S7LOU								

A **B** **C** **D** **E** **F**

HOW TO ORDER

Indicate the following information on order form:

- Quantity of each item.
- Model number, including options. See "How To Build a Model Number".
- Any special service required.

Note: • The indicates that a choice is required.

- The absence of the indicates that no choice is required.
- Alpha-numeric characters in place of indicate that no other alternatives are available.

HOW TO BUILD A MODEL NUMBER

NLC - No lock core

- A** Select basic model.
- B** Select unit color.
Refer to color addendum at ki.com or KI Fabrics & Finishes binder.
- C** Select front surface finish.
Refer to color addendum at ki.com or KI Fabrics & Finishes binder.
- D** Select pull color optional front.
Refer to color addendum at ki.com or KI Fabrics & Finishes binder.
- E** Select counterbalance weight.
CBW - With Counterbalance
NOCBW - No Counterbalance
See pricing column for counterbalance weight upcharge.
- F** Select key option.
KA - Key alike
KS - Key standard

INFORMATION

Folder Bars

Files are configured for side-to-side media storage. For alternative configurations, see the General Information section.

Height

All dimensions shown include 1/8" allowance for glides in recessed position.

Accessories

See accessory section for accessories that can be ordered separately.

Weights

Figures provided are approximate and reflect packaged product without additional accessories.



Preconfigured Lateral Files

700 Series® OF Extended Top Laminate Front

Approx. Packaged Weight	Delivered Pricing	Counter-balance Weight add to list price
120.0#	\$ 1083	\$ 201
130.0#	1218	201
140.0#	1372	201
<hr/>		
155.0#	\$ 1490	\$ 201
165.0#	1779	201
185.0#	1776	201
<hr/>		
200.0#	\$ 1907	\$ 161
220.0#	2045	161
240.0#	2195	161
<hr/>		
225.0#	\$ 2331	\$ 161
240.0#	2454	161
255.0#	2601	161

SPECIAL SERVICES

Special Carton Marking

With specially marked information N/C

Shipping

Shipped **assembled freight prepaid f.o.b. Pembroke, Ontario K8A 0E1** factory. Freight class #70.

Specifications and prices are subject to change without prior notice.

Preconfigured Multimedia Storage

700 Series® Cupboard/Lateral

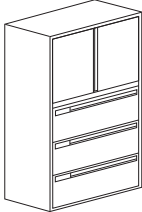
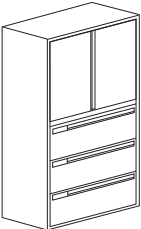
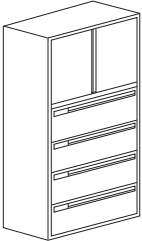
	MODEL	W x D x H	MODEL NUMBER					Approx. Packaged Weight
			Basic Model	Pull Option	Unit Color	Optional Counterbalance Weight	Key Option	
	65-9/32" File	30 x 18 x 65-9/32"	S7L/306155M	<input type="checkbox"/> <input type="checkbox"/> <input type="checkbox"/> <input type="checkbox"/>	<input type="checkbox"/>	<input type="checkbox"/> <input type="checkbox"/> <input type="checkbox"/> <input type="checkbox"/> <input type="checkbox"/> <input type="checkbox"/>	<input type="checkbox"/> <input type="checkbox"/>	215.0#
	• One 24" hinged door insert with one blank shelf	36 x 18 x 65-9/32"	S7L/366155M	<input type="checkbox"/> <input type="checkbox"/> <input type="checkbox"/> <input type="checkbox"/>	<input type="checkbox"/>	<input type="checkbox"/> <input type="checkbox"/> <input type="checkbox"/> <input type="checkbox"/> <input type="checkbox"/> <input type="checkbox"/>	<input type="checkbox"/> <input type="checkbox"/>	240.0#
	• One 1-1/2" locking tie bar shelf	42 x 18 x 65-9/32"	S7L/426155M	<input type="checkbox"/> <input type="checkbox"/> <input type="checkbox"/> <input type="checkbox"/>	<input type="checkbox"/>	<input type="checkbox"/> <input type="checkbox"/> <input type="checkbox"/> <input type="checkbox"/> <input type="checkbox"/> <input type="checkbox"/>	<input type="checkbox"/> <input type="checkbox"/>	270.0#
	• Three 12" drawers with FBA folder bars for side-to-side filing							
	• Cabinet supplied with two locks; one lock controls hinged door, other lock controls drawers							
	• Counterbalance weights are recommended for freestanding units							
S7LTU								
	71-13/32" File	30 x 18 x 71-13/32"	S7L/306755M	<input type="checkbox"/> <input type="checkbox"/> <input type="checkbox"/> <input type="checkbox"/>	<input type="checkbox"/>	<input type="checkbox"/> <input type="checkbox"/> <input type="checkbox"/> <input type="checkbox"/> <input type="checkbox"/> <input type="checkbox"/>	<input type="checkbox"/> <input type="checkbox"/>	245.0#
	• One 30" hinged door insert with one blank shelf	36 x 18 x 71-13/32"	S7L/366755M	<input type="checkbox"/> <input type="checkbox"/> <input type="checkbox"/> <input type="checkbox"/>	<input type="checkbox"/>	<input type="checkbox"/> <input type="checkbox"/> <input type="checkbox"/> <input type="checkbox"/> <input type="checkbox"/> <input type="checkbox"/>	<input type="checkbox"/> <input type="checkbox"/>	280.0#
	• One 1-1/2" locking tie bar shelf	42 x 18 x 71-13/32"	S7L/426755M	<input type="checkbox"/> <input type="checkbox"/> <input type="checkbox"/> <input type="checkbox"/>	<input type="checkbox"/>	<input type="checkbox"/> <input type="checkbox"/> <input type="checkbox"/> <input type="checkbox"/> <input type="checkbox"/> <input type="checkbox"/>	<input type="checkbox"/> <input type="checkbox"/>	320.0#
	• Three 12" drawers with FBA folder bars for side-to-side filing							
	• Cabinet supplied with two locks; one lock controls hinged doors, other lock controls drawers							
	• Counterbalance weights are recommended for freestanding units							
S7LTU								
	77-17/32" File	30 x 18 x 77-17/32"	S7L/307356M	<input type="checkbox"/> <input type="checkbox"/> <input type="checkbox"/> <input type="checkbox"/>	<input type="checkbox"/>	<input type="checkbox"/> <input type="checkbox"/> <input type="checkbox"/> <input type="checkbox"/> <input type="checkbox"/> <input type="checkbox"/>	<input type="checkbox"/> <input type="checkbox"/>	245.0#
	• One 24" hinged door insert with one blank shelf	36 x 18 x 77-17/32"	S7L/367356M	<input type="checkbox"/> <input type="checkbox"/> <input type="checkbox"/> <input type="checkbox"/>	<input type="checkbox"/>	<input type="checkbox"/> <input type="checkbox"/> <input type="checkbox"/> <input type="checkbox"/> <input type="checkbox"/> <input type="checkbox"/>	<input type="checkbox"/> <input type="checkbox"/>	280.0#
	• One 1-1/2" locking tie bar shelf	42 x 18 x 77-17/32"	S7L/427356M	<input type="checkbox"/> <input type="checkbox"/> <input type="checkbox"/> <input type="checkbox"/>	<input type="checkbox"/>	<input type="checkbox"/> <input type="checkbox"/> <input type="checkbox"/> <input type="checkbox"/> <input type="checkbox"/> <input type="checkbox"/>	<input type="checkbox"/> <input type="checkbox"/>	320.0#
	• Four 12" drawers with FBA folder bars for side-to-side filing							
	• Cabinet supplied with two locks; one lock controls hinged doors, other lock controls drawers							
	• Counterbalance weights are recommended for freestanding units							
S7LTU								

A

B

C

D

E

HOW TO ORDER

Indicate the following information on order form:

- Quantity of each item.
- Model number, including options. See "How To Build a Model Number".
- Any special service required.

Note: • The indicates that a choice is required.

- The absence of the indicates that no choice is required.
- Alpha-numeric characters in place of indicate that no other alternatives are available.

HOW TO BUILD A MODEL NUMBER

NLC - No lock core

A Select basic model.

B Select pull option.

ALBT - Aluminum Bow Tie

ALMT - Aluminum Metric

ARC� - Arc Nickel

CLSC - Classic (inset pull)

NKBT - Nickel Bow Tie

RETN - Retro Nickel

C Select unit and drawer color.

Refer to color addendum at ki.com or KI Fabrics & Finishes binder.

D Select counterbalance weight.

CBW - With Counterbalance

NOCBW - No Counterbalance

See pricing column for counterbalance weight upcharge.

E Select key option.

KA - Key alike

KS - Key standard

INFORMATION

Folder Bars

Files are configured for side-to-side media storage. For alternative configurations, see the General Information section.

Height

All dimensions shown include 1/8" allowance for glides in recessed position.

Accessories

See accessory section for accessories that can be ordered separately.

Weights

Figures provided are approximate and reflect packaged product without additional accessories.



Preconfigured Multimedia Storage

700 Series® Cupboard/Lateral

Delivered Pricing	Counter-balance Weight add to list price
\$ 1874	\$ 125
2114	125
2371	125
<hr/>	
\$ 1936	\$ 125
2080	125
2371	125
<hr/>	
\$ 2251	\$ 125
2557	125
2916	125

SPECIAL SERVICES

Special Carton Marking

With specially marked information N/C

Shipping

Shipped **assembled freight prepaid f.o.b. Pembroke, Ontario K8A 0E1** factory. Freight class #70.

Specifications and prices are subject to change without prior notice.

Preconfigured Multimedia Storage

700 Series® Curve Cupboard/Lateral

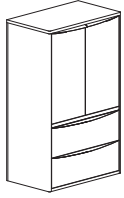

S7CL

MODEL

- 65-9/32" Cupboard/Lateral File**
- One 36" hinged door insert with two blank shelves
 - 1-1/2" locking tie bar shelf
 - Two 12" drawers with FBA folder bars
 - Cabinet supplied with two locks; one lock controls hinged doors, other lock controls drawers, keyed-alike unless otherwise specified
 - Counterbalance weights are recommended for freestanding units

W x D

- 30 x 18"
- 36 x 18"
- 42 x 18"

MODEL NUMBER

Basic Model	Dimpled	Unit Color	Pull Color	Optional Counterbalance Weight	Key Option
S7CL306152D36C	<input type="checkbox"/>	<input type="checkbox"/> <input type="checkbox"/>	<input type="checkbox"/> <input type="checkbox"/> <input type="checkbox"/> <input type="checkbox"/> <input type="checkbox"/> <input type="checkbox"/>	<input type="checkbox"/> <input type="checkbox"/> <input type="checkbox"/> <input type="checkbox"/>	<input type="checkbox"/> <input type="checkbox"/> <input type="checkbox"/> <input type="checkbox"/>
S7CL366152D36C	<input type="checkbox"/>	<input type="checkbox"/> <input type="checkbox"/>	<input type="checkbox"/> <input type="checkbox"/> <input type="checkbox"/> <input type="checkbox"/> <input type="checkbox"/> <input type="checkbox"/>	<input type="checkbox"/> <input type="checkbox"/> <input type="checkbox"/> <input type="checkbox"/>	<input type="checkbox"/> <input type="checkbox"/> <input type="checkbox"/> <input type="checkbox"/>
S7CL426152D36C	<input type="checkbox"/>	<input type="checkbox"/> <input type="checkbox"/>	<input type="checkbox"/> <input type="checkbox"/> <input type="checkbox"/> <input type="checkbox"/> <input type="checkbox"/> <input type="checkbox"/>	<input type="checkbox"/> <input type="checkbox"/> <input type="checkbox"/> <input type="checkbox"/>	<input type="checkbox"/> <input type="checkbox"/> <input type="checkbox"/> <input type="checkbox"/>

A B C D E F

HOW TO ORDER

Indicate the following information on order form:

1. Quantity of each item.
2. Model number, including options. See "How To Build a Model Number".
3. Any special service required.

Note:

- The indicates that a choice is required.
- The absence of the indicates that no choice is required.
- Alpha-numeric characters in place of indicate that no other alternatives are available.

HOW TO BUILD A MODEL NUMBER

- A** Select basic model.
- B** Select flat or dimpled front.
 - D** - Dimpled
 - F** - Flat
 See upcharge column for D option.
- C** Select unit and drawer color. Refer to color addendum at ki.com or KI Fabrics & Finishes binder.
- D** Select drawer pull color. Refer to color addendum at ki.com or KI Fabrics & Finishes binder.
- E** Select counterbalance weight.
 - CBW** - With Counterbalance
 - NOCBW** - No Counterbalance
 See pricing column for counterbalance weight upcharge.
- F** Select key option.
 - KA** - Key alike

KS - Key standard
NLC - No lock core

INFORMATION

Folder Bars

Files are configured for side-to-side media storage. For alternative configurations, see the General Information section.

Height

All dimensions shown include 1/8" allowance for glides in recessed position.

Accessories

See accessory section for accessories that can be ordered separately.

Weights

Figures provided are approximate and reflect packaged product without additional accessories.



Preconfigured Multimedia Storage

700 Series® Curve Cupboard/Lateral

Approx. Packaged Weight	Delivered Pricing	Dimpled Front add to list price	Counter-balance Weight add to list price
215.0#	\$ 1950	\$ 39	\$ 125
240.0#	2184	44	125
270.0#	2433	47	125

SPECIAL SERVICES

Special Carton Marking

With specially marked information N/C

Shipping

Shipped **assembled freight prepaid f.o.b. Pembroke, Ontario K8A 0E1** factory. Freight class #70.

Specifications and prices are subject to change without prior notice.

Preconfigured Multimedia Storage

700 Series® Curve Cupboard/Lateral

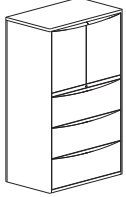

S7CL

MODEL	W x D	MODEL NUMBER						Approx. Packaged Weight
		Basic Model	Dimpled	Unit Color	Pull Color	Optional Counterbalance Weight	Key Option	
65-9/32" Cupboard/Lateral File • One 24" hinged door inset with one blank shelf • 1-1/2" lock tie bar shelf • Three 12" drawers with FBA folder bars • Cabinet supplied with two locks; one lock controls hinged doors, other lock controls drawers, keyed-alike unless otherwise specified • Counterbalance weights are recommended for freestanding units	30 x 18"	S7CL306155M	<input type="checkbox"/>	<input type="checkbox"/>	<input type="checkbox"/>	<input type="checkbox"/>	<input type="checkbox"/>	215.0#
	36 x 18"	S7CL366155M	<input type="checkbox"/>	<input type="checkbox"/>	<input type="checkbox"/>	<input type="checkbox"/>	<input type="checkbox"/>	240.0#
	42 x 18"	S7CL426155M	<input type="checkbox"/>	<input type="checkbox"/>	<input type="checkbox"/>	<input type="checkbox"/>	<input type="checkbox"/>	270.0#

A
B
C
D
E
F

HOW TO ORDER

Indicate the following information on order form:

- Quantity of each item.
- Model number, including options. See "How To Build a Model Number".
- Any special service required.

Note:

- The indicates that a choice is required.
- The absence of the indicates that no choice is required.
- Alpha-numeric characters in place of indicate that no other alternatives are available.

HOW TO BUILD A MODEL NUMBER

- A** Select basic model.
- B** Select flat or dimpled front.
 - D** - Dimpled
 - F** - Flat
 See upcharge column for D option.
- C** Select unit and drawer color. Refer to color addendum at ki.com or KI Fabrics & Finishes binder.
- D** Select drawer pull color. Refer to color addendum at ki.com or KI Fabrics & Finishes binder.
- E** Select counterbalance weight.
 - CBW** - With Counterbalance
 - NOCBW** - No Counterbalance
 See pricing column for counterbalance weight upcharge.
- F** Select key option.
 - KA** - Key alike

- KS** - Key standard
- NLC** - No lock core

INFORMATION

Folder Bars

Files are configured for side-to-side media storage. For alternative configurations, see the General Information section.

Height

All dimensions shown include 1/8" allowance for glides in recessed position.

Accessories

See accessory section for accessories that can be ordered separately.

Weights

Figures provided are approximate and reflect packaged product without additional accessories.



Preconfigured Multimedia Storage

700 Series® Curve Cupboard/Lateral

Delivered Pricing	Dimpled Front add to list price	Counter-balance Weight add to list price
\$ 2058	\$ 41	\$ 125
2331	45	125
2608	50	125

SPECIAL SERVICES

Special Carton Marking

With specially marked information N/C

Shipping

Shipped **assembled freight prepaid f.o.b. Pembroke, Ontario K8A 0E1** factory. Freight class #70.

Specifications and prices are subject to change without prior notice.

Preconfigured Multimedia Storage

700 Series® Curve Cupboard/Lateral



S7CL

MODEL

- 71-13/32" Cupboard/Lateral File**
- One 30" hinged door insert with one blank shelf
 - 1-1/2" locking tie bar shelf
 - Three 12" drawers with FBA folder bars
 - Cabinet supplied with two locks; one lock controls hinged doors, other lock controls drawers, keyed-alike unless otherwise specified
 - Counterbalance weights are recommended for freestanding units

W x D

30 x 18"

36 x 18"

MODEL NUMBER

Basic Model

Dimpled

Unit Color

Pull Color

Optional Counterbalance Weight

Key Option

Approx. Packaged Weight

S7CL306755M

245.0#

S7CL366755M

280.0#

A

B

C

D

E

F

HOW TO ORDER

Indicate the following information on order form:

1. Quantity of each item.
2. Model number, including options. See "How To Build a Model Number".
3. Any special service required.

- Note:
- The indicates that a choice is required.
 - The absence of the indicates that no choice is required.
 - Alpha-numeric characters in place of indicate that no other alternatives are available.

HOW TO BUILD A MODEL NUMBER

- A** Select basic model.
- B** Select flat or dimpled front.
 - D** - Dimpled
 - F** - Flat
 See upcharge column for D option.
- C** Select unit and drawer color. Refer to color addendum at ki.com or KI Fabrics & Finishes binder.
- D** Select drawer pull color. Refer to color addendum at ki.com or KI Fabrics & Finishes binder.
- E** Select counterbalance weight.
 - CBW** - With Counterbalance
 - NOCBW** - No Counterbalance
 See pricing column for counterbalance weight upcharge.
- F** Select key option.
 - KA** - Key alike

- KS** - Key standard
- NLC** - No lock core

INFORMATION

Folder Bars

Files are configured for side-to-side media storage. For alternative configurations, see the General Information section.

Height

All dimensions shown include 1/8" allowance for glides in recessed position.

Accessories

See accessory section for accessories that can be ordered separately.

Weights

Figures provided are approximate and reflect packaged product without additional accessories.



Preconfigured Multimedia Storage

700 Series® Curve Cupboard/Lateral

Delivered Pricing	Dimpled Front add to list price	Counter-balance Weight add to list price
\$ 2148	\$ 42	\$ 125
2438	47	125

SPECIAL SERVICES

Special Carton Marking

With specially marked information N/C

Shipping

Shipped **assembled freight prepaid f.o.b. Pembroke, Ontario K8A 0E1** factory. Freight class #70.

Specifications and prices are subject to change without prior notice.

Preconfigured Multimedia Storage

700 Series® Curve Cupboard/Lateral

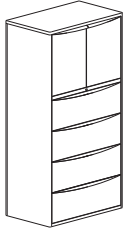

S7CL

MODEL

- 77-13/32" Cupboard/Lateral File**
- One 24" hinged door insert with one blank shelf
 - 1-1/2" lock tie bar shelf
 - Four 12" drawers with FBA folder bars
 - Cabinet supplied with two locks; one lock controls hinged doors, other lock controls drawers, keyed-alike unless otherwise specified
 - Counterbalance weights are recommended for freestanding units

W x D

30 x 18"

36 x 18"

MODEL NUMBER

Basic Model

Dimpled

Unit Color

Pull Color

Optional Counterbalance Weight

Key Option

Approx. Packaged Weight

S7CL307356M

270.0#

S7CL367356M

315.0#

A

B

C

D

E

F

HOW TO ORDER

Indicate the following information on order form:

1. Quantity of each item.
2. Model number, including options. See "How To Build a Model Number".
3. Any special service required.

- Note:
- The indicates that a choice is required.
 - The absence of the indicates that no choice is required.
 - Alpha-numeric characters in place of indicate that no other alternatives are available.

HOW TO BUILD A MODEL NUMBER

- A** Select basic model.
- B** Select flat or dimpled front.
 - D** - Dimpled
 - F** - Flat
 See upcharge column for D option.
- C** Select unit and drawer color. Refer to color addendum at ki.com or KI Fabrics & Finishes binder.
- D** Select drawer pull color. Refer to color addendum at ki.com or KI Fabrics & Finishes binder.
- E** Select counterbalance weight.
 - CBW** - With Counterbalance
 - NOCBW** - No Counterbalance
 See pricing column for counterbalance weight upcharge.
- F** Select key option.
 - KA** - Key alike

- KS** - Key standard
- NLC** - No lock core

INFORMATION

Folder Bars

Files are configured for side-to-side media storage. For alternative configurations, see the General Information section.

Height

All dimensions shown include 1/8" allowance for glides in recessed position.

Accessories

See accessory section for accessories that can be ordered separately.

Weights

Figures provided are approximate and reflect packaged product without additional accessories.



Preconfigured Multimedia Storage

700 Series® Curve Cupboard/Lateral

Delivered Pricing	Dimpled Front add to list price	Counter-balance Weight add to list price
\$ 2475	\$ 47	\$ 125
2819	55	125

SPECIAL SERVICES

Special Carton Marking

With specially marked information N/C

Shipping

Shipped **assembled freight prepaid f.o.b. Pembroke, Ontario K8A 0E1** factory. Freight class #70.

Specifications and prices are subject to change without prior notice.

Preconfigured Multimedia Storage

700 Series® Bookcase/File

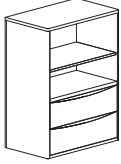
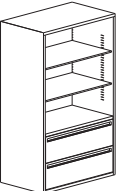
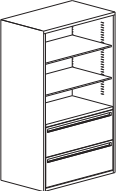
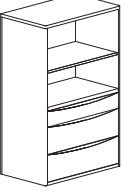
MODEL	W x D	MODEL NUMBER					Approx. Packaged Weight
		Basic Model	Pull Option	Unit Color	Optional Counterbalance Weight	Key Option	
 <p>53-1/32" Bookcase/File</p> <ul style="list-style-type: none"> One 27" bookcase section with one 1/2" adjustable shelf 1-1/2" lock tie bar shelf Two 10-1/2" drawers with FBA folder bars Counterbalance weights are recommended for freestanding units 	30 x 18"	7FB/30495/2D270B	<input type="checkbox"/> <input type="checkbox"/> <input type="checkbox"/> <input type="checkbox"/>	<input type="checkbox"/> <input type="checkbox"/>	<input type="checkbox"/> <input type="checkbox"/> <input type="checkbox"/> <input type="checkbox"/> <input type="checkbox"/> <input type="checkbox"/>	<input type="checkbox"/> <input type="checkbox"/>	197.0#
	36 x 18"	7FB/36495/2D270B	<input type="checkbox"/> <input type="checkbox"/> <input type="checkbox"/> <input type="checkbox"/>	<input type="checkbox"/> <input type="checkbox"/>	<input type="checkbox"/> <input type="checkbox"/> <input type="checkbox"/> <input type="checkbox"/> <input type="checkbox"/> <input type="checkbox"/>	<input type="checkbox"/> <input type="checkbox"/>	213.0#
	42 x 18"	7FB/42495/2D270B	<input type="checkbox"/> <input type="checkbox"/> <input type="checkbox"/> <input type="checkbox"/>	<input type="checkbox"/> <input type="checkbox"/>	<input type="checkbox"/> <input type="checkbox"/> <input type="checkbox"/> <input type="checkbox"/> <input type="checkbox"/> <input type="checkbox"/>	<input type="checkbox"/> <input type="checkbox"/>	235.0#
S7FB							
 <p>65-9/32" Bookcase/File</p> <ul style="list-style-type: none"> One 39" bookcase section with two 1/2" adjustable shelves 1-1/2" locking tie bar shelf Two 10-1/2" drawers with FBA folder bars Counterbalance weights are recommended for freestanding units 	30 x 18"	7FB/30615/2D390B	<input type="checkbox"/> <input type="checkbox"/> <input type="checkbox"/> <input type="checkbox"/>	<input type="checkbox"/> <input type="checkbox"/>	<input type="checkbox"/> <input type="checkbox"/> <input type="checkbox"/> <input type="checkbox"/> <input type="checkbox"/> <input type="checkbox"/>	<input type="checkbox"/> <input type="checkbox"/>	215.0#
	36 x 18"	7FB/36615/2D390B	<input type="checkbox"/> <input type="checkbox"/> <input type="checkbox"/> <input type="checkbox"/>	<input type="checkbox"/> <input type="checkbox"/>	<input type="checkbox"/> <input type="checkbox"/> <input type="checkbox"/> <input type="checkbox"/> <input type="checkbox"/> <input type="checkbox"/>	<input type="checkbox"/> <input type="checkbox"/>	240.0#
	42 x 18"	7FB/42615/2D390B	<input type="checkbox"/> <input type="checkbox"/> <input type="checkbox"/> <input type="checkbox"/>	<input type="checkbox"/> <input type="checkbox"/>	<input type="checkbox"/> <input type="checkbox"/> <input type="checkbox"/> <input type="checkbox"/> <input type="checkbox"/> <input type="checkbox"/>	<input type="checkbox"/> <input type="checkbox"/>	270.0#
S7FB							
 <p>65-9/32" Bookcase/File</p> <ul style="list-style-type: none"> One 36" bookcase section with two 1/2" adjustable shelves 1-1/2" locking tie bar shelf Two 12" drawers with FBA folder bars Counterbalance weights are recommended for freestanding units 	30 x 18"	7FB/30615/2D360B	<input type="checkbox"/> <input type="checkbox"/> <input type="checkbox"/> <input type="checkbox"/>	<input type="checkbox"/> <input type="checkbox"/>	<input type="checkbox"/> <input type="checkbox"/> <input type="checkbox"/> <input type="checkbox"/> <input type="checkbox"/> <input type="checkbox"/>	<input type="checkbox"/> <input type="checkbox"/>	215.0#
	36 x 18"	7FB/36615/2D360B	<input type="checkbox"/> <input type="checkbox"/> <input type="checkbox"/> <input type="checkbox"/>	<input type="checkbox"/> <input type="checkbox"/>	<input type="checkbox"/> <input type="checkbox"/> <input type="checkbox"/> <input type="checkbox"/> <input type="checkbox"/> <input type="checkbox"/>	<input type="checkbox"/> <input type="checkbox"/>	240.0#
	42 x 18"	7FB/42615/2D360B	<input type="checkbox"/> <input type="checkbox"/> <input type="checkbox"/> <input type="checkbox"/>	<input type="checkbox"/> <input type="checkbox"/>	<input type="checkbox"/> <input type="checkbox"/> <input type="checkbox"/> <input type="checkbox"/> <input type="checkbox"/> <input type="checkbox"/>	<input type="checkbox"/> <input type="checkbox"/>	270.0#
S7FB							
 <p>65-9/32" Bookcase/File</p> <ul style="list-style-type: none"> One 33" bookcase section with one 1/2" adjustable shelf 1-1/2" locking tie bar shelf One 6" drawer and two 10-1/2" drawers with FBA folder bars Counterbalance weights are recommended for freestanding units 	30 x 18"	7FB/30615/3D330B	<input type="checkbox"/> <input type="checkbox"/> <input type="checkbox"/> <input type="checkbox"/>	<input type="checkbox"/> <input type="checkbox"/>	<input type="checkbox"/> <input type="checkbox"/> <input type="checkbox"/> <input type="checkbox"/> <input type="checkbox"/> <input type="checkbox"/>	<input type="checkbox"/> <input type="checkbox"/>	215.0#
	36 x 18"	7FB/36615/3D330B	<input type="checkbox"/> <input type="checkbox"/> <input type="checkbox"/> <input type="checkbox"/>	<input type="checkbox"/> <input type="checkbox"/>	<input type="checkbox"/> <input type="checkbox"/> <input type="checkbox"/> <input type="checkbox"/> <input type="checkbox"/> <input type="checkbox"/>	<input type="checkbox"/> <input type="checkbox"/>	240.0#
	42 x 18"	7FB/42615/3D330B	<input type="checkbox"/> <input type="checkbox"/> <input type="checkbox"/> <input type="checkbox"/>	<input type="checkbox"/> <input type="checkbox"/>	<input type="checkbox"/> <input type="checkbox"/> <input type="checkbox"/> <input type="checkbox"/> <input type="checkbox"/> <input type="checkbox"/>	<input type="checkbox"/> <input type="checkbox"/>	270.0#
S7FB							

A **B** **C** **D** **E**

HOW TO ORDER

Indicate the following information on order form:

- Quantity of each item.
- Model number, including options. See "How To Build a Model Number".
- Any special service required.

Note: • The indicates that a choice is required.

- The absence of the indicates that no choice is required.
- Alpha-numeric characters in place of indicate that no other alternatives are available.

HOW TO BUILD A MODEL NUMBER

NLC - No lock core

- A** Select basic model.
 - ALBT - Aluminum Bow Tie
 - ALMT - Aluminum Metric
 - ARCN - Arc Nickel
 - CLSC - Classic (inset pull)
 - NKBT - Nickel Bow Tie
 - RETN - Retro Nickel
- B** Select pull option.
 - ALBT - Aluminum Bow Tie
 - ALMT - Aluminum Metric
 - ARCN - Arc Nickel
 - CLSC - Classic (inset pull)
 - NKBT - Nickel Bow Tie
 - RETN - Retro Nickel
- C** Select unit and drawer color. Refer to color addendum at ki.com or KI Fabrics & Finishes binder.
- D** Select counterbalance weight.
 - CBW - With Counterbalance
 - NOCBW - No Counterbalance
 See pricing column for counterbalance weight upcharge.
- E** Select key option.
 - KA - Key alike
 - KS - Key standard

INFORMATION

Folder Bars

Files are configured for side-to-side media storage. For alternative configurations, see the General Information section.

Height

All dimensions shown include 1/8" allowance for glides in recessed position.

Accessories

See accessory section for accessories that can be ordered separately.

Weights

Figures provided are approximate and reflect packaged product without additional accessories.



Preconfigured Multimedia Storage

700 Series® Bookcase/File

Delivered Pricing	Counter-balance Weight add to list price
\$ 1540	\$ 125
1582	125
1692	125
<hr/>	
\$ 1739	\$ 125
1769	125
1907	125
<hr/>	
\$ 1729	\$ 125
1754	125
1897	125
<hr/>	
\$ 1822	\$ 125
1855	125
1993	125

SPECIAL SERVICES

Special Carton Marking

With specially marked information N/C

Shipping

Shipped **assembled freight prepaid f.o.b. Pembroke, Ontario K8A 0E1** factory. Freight class #70.

Specifications and prices are subject to change without prior notice.

Preconfigured Multimedia Storage

700 Series® Bookcase/File

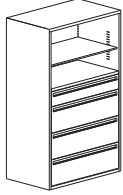

S7FB

MODEL	W x D	MODEL NUMBER					Approx. Packaged Weight
		Basic Model	Pull Option	Unit Color	Optional Counterbalance Weight	Key Option	
65-9/32" Bookcase/File • One 22-1/2" bookcase section with one 1/2" adjustable shelf • 1-1/2" locking tie bar shelf • One 6" drawer and three 10-1/2" drawers with FBA folder bars • Counterbalance weights are recommended for freestanding units	30 x 18"	7FB/30615/4D225B	<input type="checkbox"/> <input type="checkbox"/> <input type="checkbox"/> <input type="checkbox"/>	<input type="checkbox"/> <input type="checkbox"/>	<input type="checkbox"/> <input type="checkbox"/> <input type="checkbox"/> <input type="checkbox"/> <input type="checkbox"/> <input type="checkbox"/>	<input type="checkbox"/> <input type="checkbox"/>	215.0#
	36 x 18"	7FB/36615/4D225B	<input type="checkbox"/> <input type="checkbox"/> <input type="checkbox"/> <input type="checkbox"/>	<input type="checkbox"/> <input type="checkbox"/>	<input type="checkbox"/> <input type="checkbox"/> <input type="checkbox"/> <input type="checkbox"/> <input type="checkbox"/> <input type="checkbox"/>	<input type="checkbox"/> <input type="checkbox"/>	240.0#
	42 x 18"	7FB/42615/4D225B	<input type="checkbox"/> <input type="checkbox"/> <input type="checkbox"/> <input type="checkbox"/>	<input type="checkbox"/> <input type="checkbox"/>	<input type="checkbox"/> <input type="checkbox"/> <input type="checkbox"/> <input type="checkbox"/> <input type="checkbox"/> <input type="checkbox"/>	<input type="checkbox"/> <input type="checkbox"/>	270.0#

A **B** **C** **D** **E**

HOW TO ORDER

Indicate the following information on order form:

- Quantity of each item.
- Model number, including options. See "How To Build a Model Number".
- Any special service required.

Note: • The indicates that a choice is required.

- The absence of the indicates that no choice is required.
- Alpha-numeric characters in place of indicate that no other alternatives are available.

HOW TO BUILD A MODEL NUMBER

NLC - No lock core

- A** Select basic model.

- B** Select pull option.

ALBT	- Aluminum Bow Tie
ALMT	- Aluminum Metric
ARCN	- Arc Nickel
CLSC	- Classic (inset pull)
NKBT	- Nickel Bow Tie
RETN	- Retro Nickel
- C** Select unit and drawer color.
Refer to color addendum at ki.com or KI Fabrics & Finishes binder.

- D** Select counterbalance weight.

CBW	- With Counterbalance
NOCBW	- No Counterbalance

 See pricing column for counterbalance weight upcharge.

- E** Select key option.

KA	- Key alike
KS	- Key standard

INFORMATION

Folder Bars

Files are configured for side-to-side media storage. For alternative configurations, see the General Information section.

Height

All dimensions shown include 1/8" allowance for glides in recessed position.

Accessories

See accessory section for accessories that can be ordered separately.

Weights

Figures provided are approximate and reflect packaged product without additional accessories.



Preconfigured Multimedia Storage

700 Series® Bookcase/File

Delivered Pricing	Counter-balance Weight add to list price
\$ 2051	\$ 125
2089	125
2254	125

SPECIAL SERVICES

Special Carton Marking

With specially marked information N/C

Shipping

Shipped **assembled freight prepaid f.o.b. Pembroke, Ontario K8A 0E1** factory. Freight class #70.

Specifications and prices are subject to change without prior notice.



Preconfigured Multimedia Storage

700 Series® Curve Bookcase/Lateral File

Approx. Packaged Weight	Delivered Pricing	Dimpled Front add to list price	Counter-balance Weight add to list price
197.0#	\$ 1693	\$ 33	\$ 125
213.0#	1739	34	125
235.0#	1862	36	125
215.0#	\$ 1910	\$ 36	\$ 125
240.0#	1948	39	125
270.0#	2098	N/A	125

SPECIAL SERVICES

Special Carton Marking

With specially marked information N/C

Shipping

Shipped **assembled freight prepaid f.o.b. Pembroke, Ontario K8A 0E1** factory. Freight class #70.

Specifications and prices are subject to change without prior notice.



Preconfigured Multimedia Storage

700 Series® Curve Bookcase/Lateral File

Approx. Packaged Weight	Delivered Pricing	Dimpled Front add to list price	Counter- balance Weight add to list price
215.0#	\$ 1902	\$ 36	\$ 125
240.0#	1932	36	125
270.0#	2086	N/A	125

215.0#	\$ 2002	\$ 39	\$ 125
240.0#	2044	N/A	125
270.0#	2192	44	125

SPECIAL SERVICES

Special Carton Marking

With specially marked information N/C

Shipping

Shipped **assembled freight prepaid f.o.b. Pembroke, Ontario K8A 0E1** factory.
Freight class #70.

Specifications and prices are subject to change without prior notice.

Preconfigured Multimedia Storage

700 Series® Wardrobe Cabinets

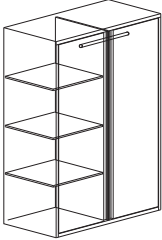
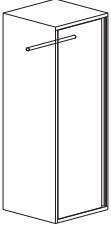
	MODEL	Features	W x D x H	MODEL NUMBER				Approx. Packaged Weight	
				Basic Model	Pull Option	Unit Color	Key Option		
	65-9/32" Wardrobe Multimedia Storage Cabinet	<ul style="list-style-type: none"> Coat rod on right side Three adjustable blank shelves on left side 	With 3 Shelves	30 x 18 x 65-9/32"	S7L/30615HWS	<input type="checkbox"/> <input type="checkbox"/> <input type="checkbox"/> <input type="checkbox"/>	<input type="checkbox"/>	<input type="checkbox"/> <input type="checkbox"/> <input type="checkbox"/>	205.0#
			With 3 Shelves	36 x 18 x 65-9/32"	S7L/36615HWS	<input type="checkbox"/> <input type="checkbox"/> <input type="checkbox"/> <input type="checkbox"/>	<input type="checkbox"/>	<input type="checkbox"/> <input type="checkbox"/> <input type="checkbox"/>	220.0#
S7CBU									
	65-9/32" Wardrobe Multimedia Storage Cabinet	<ul style="list-style-type: none"> Available with coat rod Door hinged right or left 	Left Door	18 x 18 x 65-9/32"	S7L/18615HWL	<input type="checkbox"/> <input type="checkbox"/> <input type="checkbox"/> <input type="checkbox"/>	<input type="checkbox"/>	<input type="checkbox"/> <input type="checkbox"/> <input type="checkbox"/>	135.0#
			Right Door	18 x 18 x 65-9/32"	S7L/18615HWR	<input type="checkbox"/> <input type="checkbox"/> <input type="checkbox"/> <input type="checkbox"/>	<input type="checkbox"/>	<input type="checkbox"/> <input type="checkbox"/> <input type="checkbox"/>	135.0#
S7CBU									
					A	B	C	D	

HOW TO ORDER

Indicate the following information on order form:

- Quantity of each item.
- Model number, including options. See "How To Build a Model Number".
- Any special service required.

Note: • The indicates that a choice is required.

- The absence of the indicates that no choice is required.
- Alpha-numeric characters in place of indicate that no other alternatives are available.

HOW TO BUILD A MODEL NUMBER

A Select basic model.

B Select pull option.

ALBT	- Aluminum Bow Tie
ALMT	- Aluminum Metric
ARCN	- Arc Nickel
CLSC	- Classic (inset pull)
NKBT	- Nickel Bow Tie
RETN	- Retro Nickel

C Select unit color.

Refer to color addendum at ki.com or KI Fabrics & Finishes binder.

D Select key option.

KA	- Key alike
KS	- Key standard
NLC	- No lock core

INFORMATION

Height

All dimensions shown include 1/8" allowance for glides in recessed position.

Accessories

See accessory section for accessories that can be ordered separately.

Weights

Figures provided are approximate and reflect packaged product without additional accessories.



Preconfigured Multimedia Storage

700 Series® Wardrobe Cabinets

Delivered
Pricing

\$ 1746

1806

\$ 998

998

SPECIAL SERVICES

Special Carton Marking

With specially marked information N/C

Shipping

Shipped **assembled freight prepaid f.o.b. Pembroke, Ontario K8A 0E1** factory.
Freight class #70.

Specifications and prices are subject to change without prior notice.

Preconfigured Locker Units

700 Series® Cupboard/Bookcase/Markerboard

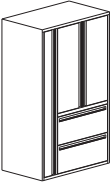
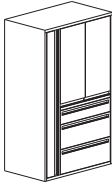
MODEL	Features	W x D	MODEL NUMBER			
			Basic Model	Pull Option	Unit Color	Key Option
 <p>S7FL</p> <p>30" Wide - 24" File, 6" Wide Locker, 18" Deep</p> <ul style="list-style-type: none"> • 36" H cupboard or bookcase with 2 shelves (files 2 rows of binders) • 1-1/2" tie bar shelf • Two 12" high drawers with FBA bars • 6" wide full length door (left or right side) with coat rod • Full length pull and lock • Cupboard shown in picture • Two locks per bookcase unit • Three locks per cupboard and markerboard units • Last model digit indicates locker hinge location 	Locker Left, Bookcase, Right	30 x 18"	7FL/3061518/2D360B/6FLL	<input type="checkbox"/> <input type="checkbox"/> <input type="checkbox"/> <input type="checkbox"/>	<input type="checkbox"/> <input type="checkbox"/>	<input type="checkbox"/> <input type="checkbox"/> <input type="checkbox"/>
	Locker Right, Bookcase Left	30 x 18"	7FL/3061518/2D360B/6FLR	<input type="checkbox"/> <input type="checkbox"/> <input type="checkbox"/> <input type="checkbox"/>	<input type="checkbox"/> <input type="checkbox"/>	<input type="checkbox"/> <input type="checkbox"/> <input type="checkbox"/>
	Locker Left, Cupboard Right	30 x 18"	7FL/3061518/2D360C/6FLL	<input type="checkbox"/> <input type="checkbox"/> <input type="checkbox"/> <input type="checkbox"/>	<input type="checkbox"/> <input type="checkbox"/>	<input type="checkbox"/> <input type="checkbox"/> <input type="checkbox"/>
	Locker Right, Cupboard Left	30 x 18"	7FL/3061518/2D360C/6FLR	<input type="checkbox"/> <input type="checkbox"/> <input type="checkbox"/> <input type="checkbox"/>	<input type="checkbox"/> <input type="checkbox"/>	<input type="checkbox"/> <input type="checkbox"/> <input type="checkbox"/>
	Locker Left, Markerboard Right	30 x 18"	7FL/3061518/2D360CMB/6FLL	<input type="checkbox"/> <input type="checkbox"/> <input type="checkbox"/> <input type="checkbox"/>	<input type="checkbox"/> <input type="checkbox"/>	<input type="checkbox"/> <input type="checkbox"/> <input type="checkbox"/>
	Locker Right, Markerboard Left	30 x 18"	7FL/3061518/2D360CMB/6FLR	<input type="checkbox"/> <input type="checkbox"/> <input type="checkbox"/> <input type="checkbox"/>	<input type="checkbox"/> <input type="checkbox"/>	<input type="checkbox"/> <input type="checkbox"/> <input type="checkbox"/>
 <p>S7FL</p> <p>30" Wide - 24" File, 6" Wide Locker, 18" Deep</p> <ul style="list-style-type: none"> • 30" H cupboard or bookcase with 1 shelf (files 2 rows of binders) • 1-1/2" tie bar shelf • One 6" high drawer, two 12" high drawers • 6" wide full length door (left or right side) with coat rod • Full length pull and lock • Markerboard shown in picture • Two locks per bookcase unit • Three locks per cupboard and markerboard units • Last model digit indicates locker hinge location 	Locker Left, Bookcase Right	30 x 18"	7FL/3061518/3D300B/6FLL	<input type="checkbox"/> <input type="checkbox"/> <input type="checkbox"/> <input type="checkbox"/>	<input type="checkbox"/> <input type="checkbox"/>	<input type="checkbox"/> <input type="checkbox"/> <input type="checkbox"/>
	Locker Right, Bookcase Left	30 x 18"	7FL/3061518/3D300B/6FLR	<input type="checkbox"/> <input type="checkbox"/> <input type="checkbox"/> <input type="checkbox"/>	<input type="checkbox"/> <input type="checkbox"/>	<input type="checkbox"/> <input type="checkbox"/> <input type="checkbox"/>
	Locker Left, Cupboard Right	30 x 18"	7FL/3061518/3D300C/6FLL	<input type="checkbox"/> <input type="checkbox"/> <input type="checkbox"/> <input type="checkbox"/>	<input type="checkbox"/> <input type="checkbox"/>	<input type="checkbox"/> <input type="checkbox"/> <input type="checkbox"/>
	Locker Right, Cupboard Left	30 x 18"	7FL/3061518/3D300C/6FLR	<input type="checkbox"/> <input type="checkbox"/> <input type="checkbox"/> <input type="checkbox"/>	<input type="checkbox"/> <input type="checkbox"/>	<input type="checkbox"/> <input type="checkbox"/> <input type="checkbox"/>
	Locker Left, Markerboard Right	30 x 18"	7FL/3061518/3D300CMB/6FLL	<input type="checkbox"/> <input type="checkbox"/> <input type="checkbox"/> <input type="checkbox"/>	<input type="checkbox"/> <input type="checkbox"/>	<input type="checkbox"/> <input type="checkbox"/> <input type="checkbox"/>
	Locker Right, Markerboard Left	30 x 18"	7FL/3061518/3D300CMB/6FLR	<input type="checkbox"/> <input type="checkbox"/> <input type="checkbox"/> <input type="checkbox"/>	<input type="checkbox"/> <input type="checkbox"/>	<input type="checkbox"/> <input type="checkbox"/> <input type="checkbox"/>

A

B

C

D

HOW TO ORDER

Indicate the following information on order form:

1. Quantity of each item.
2. Model number, including options. See "How To Build a Model Number".
3. Any special service required.

Note: • The indicates that a choice is required.

- The absence of the indicates that no choice is required.
- Alpha-numeric characters in place of indicate that no other alternatives are available.

HOW TO BUILD A MODEL NUMBER

A Select basic model.

B Select pull option.

ALBT	- Aluminum Bow Tie
ALMT	- Aluminum Metric
ARCN	- Arc Nickel
CLSC	- Classic (inset pull)
NKBT	- Nickel Bow Tie
RETN	- Retro Nickel

C Select unit and drawer color.

Refer to color addendum at ki.com or KI Fabrics & Finishes binder.

D Select key option.

KA	- Key alike
KS	- Key standard
NLC	- No lock core

INFORMATION

Folder Bars

Files are configured for side-to-side media storage. For alternative configurations, see the General Information section.

Height

All dimensions shown include 1/8" allowance for glides in recessed position.

Accessories

See accessory section for accessories that can be ordered separately.

Weights

Figures provided are approximate and reflect packaged product without additional accessories.



Preconfigured Locker Units

700 Series® Cupboard/Bookcase/Markerboard

Approx. Packaged Weight	Delivered Pricing
168.0#	\$ 2310
168.0#	2310
175.0#	2562
175.0#	2562
175.0#	3789
175.0#	3789

182.0#	\$ 2334
182.0#	2334
191.0#	2534
191.0#	2534
191.0#	3344
191.0#	3344

SPECIAL SERVICES

Special Carton Marking

With specially marked information N/C

Shipping

Shipped **assembled freight prepaid f.o.b. Pembroke, Ontario K8A 0E1** factory. Freight class #70.

Specifications and prices are subject to change without prior notice.

Preconfigured Locker Units

700 Series® Cupboard/Bookcase/Markerboard

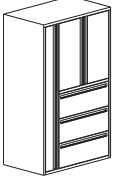
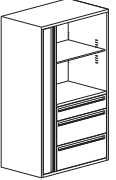
MODEL	Features	W x D	MODEL NUMBER			
			Basic Model	Pull Option	Unit Color	Key Option
 <p>S7FL</p> <p>30" Wide - 24" File, 6" Wide Locker, 18" Deep</p> <ul style="list-style-type: none"> • 28-1/2" H cupboard or bookcase with 1 shelf (files 2 rows of binders) • 1-1/2" tie bar shelf • Three 10-1/2" high drawers • 6" wide full length door (left or right side) with coat rod • Full length pull and lock • Cupboard shown in picture • Two locks per bookcase unit • Three locks per cupboard and markerboard units • Last model digit indicates locker hinge location 	Locker Left, Bookcase Right	30 x 18"	7FL/3061518/3D285B/6FLL	<input type="checkbox"/> <input type="checkbox"/> <input type="checkbox"/> <input type="checkbox"/>	<input type="checkbox"/> <input type="checkbox"/>	<input type="checkbox"/> <input type="checkbox"/> <input type="checkbox"/>
	Locker Right, Bookcase Left	30 x 18"	7FL/3061518/3D285B/6FLR	<input type="checkbox"/> <input type="checkbox"/> <input type="checkbox"/> <input type="checkbox"/>	<input type="checkbox"/> <input type="checkbox"/>	<input type="checkbox"/> <input type="checkbox"/> <input type="checkbox"/>
	Locker Left, Cupboard Right	30 x 18"	7FL/3061518/3D285C/6FLL	<input type="checkbox"/> <input type="checkbox"/> <input type="checkbox"/> <input type="checkbox"/>	<input type="checkbox"/> <input type="checkbox"/>	<input type="checkbox"/> <input type="checkbox"/> <input type="checkbox"/>
	Locker Right, Cupboard Left	30 x 18"	7FL/3061518/3D285C/6FLR	<input type="checkbox"/> <input type="checkbox"/> <input type="checkbox"/> <input type="checkbox"/>	<input type="checkbox"/> <input type="checkbox"/>	<input type="checkbox"/> <input type="checkbox"/> <input type="checkbox"/>
	Locker Left, Markerboard Right	30 x 18"	7FL/3061518/3D285CMB/6FLL	<input type="checkbox"/> <input type="checkbox"/> <input type="checkbox"/> <input type="checkbox"/>	<input type="checkbox"/> <input type="checkbox"/>	<input type="checkbox"/> <input type="checkbox"/> <input type="checkbox"/>
	Locker Right, Markerboard Left	30 x 18"	7FL/3061518/3D285CMB/6FLR	<input type="checkbox"/> <input type="checkbox"/> <input type="checkbox"/> <input type="checkbox"/>	<input type="checkbox"/> <input type="checkbox"/>	<input type="checkbox"/> <input type="checkbox"/> <input type="checkbox"/>
 <p>S7FL</p> <p>30" Wide - 24" File, 6" Wide Locker, 18" Deep</p> <ul style="list-style-type: none"> • 33" H cupboard or bookcase with 1 shelf (files 2 rows of binders) • 1-1/2" tie bar shelf • One 6" high drawer, two 10-1/2" high drawers • 6" wide full length door (left or right side) with coat rod • Full length pull and lock • Bookcase shown in picture • Two locks per bookcase unit • Three locks per cupboard and markerboard units • Last model digit indicates locker hinge location 	Locker Left, Bookcase Right	30 x 18"	7FL/3061518/3D330B/6FLL	<input type="checkbox"/> <input type="checkbox"/> <input type="checkbox"/> <input type="checkbox"/>	<input type="checkbox"/> <input type="checkbox"/>	<input type="checkbox"/> <input type="checkbox"/> <input type="checkbox"/>
	Locker Right, Bookcase Left	30 x 18"	7FL/3061518/3D330B/6FLR	<input type="checkbox"/> <input type="checkbox"/> <input type="checkbox"/> <input type="checkbox"/>	<input type="checkbox"/> <input type="checkbox"/>	<input type="checkbox"/> <input type="checkbox"/> <input type="checkbox"/>
	Locker Left, Cupboard Right	30 x 18"	7FL/3061518/3D330C/6FLL	<input type="checkbox"/> <input type="checkbox"/> <input type="checkbox"/> <input type="checkbox"/>	<input type="checkbox"/> <input type="checkbox"/>	<input type="checkbox"/> <input type="checkbox"/> <input type="checkbox"/>
	Locker Right, Cupboard Left	30 x 18"	7FL/3061518/3D330C/6FLR	<input type="checkbox"/> <input type="checkbox"/> <input type="checkbox"/> <input type="checkbox"/>	<input type="checkbox"/> <input type="checkbox"/>	<input type="checkbox"/> <input type="checkbox"/> <input type="checkbox"/>
	Locker Left, Markerboard Right	30 x 18"	7FL/3061518/3D330CMB/6FLL	<input type="checkbox"/> <input type="checkbox"/> <input type="checkbox"/> <input type="checkbox"/>	<input type="checkbox"/> <input type="checkbox"/>	<input type="checkbox"/> <input type="checkbox"/> <input type="checkbox"/>
	Locker Right, Markerboard Left	30 x 18"	7FL/3061518/3D330CMB/6FLR	<input type="checkbox"/> <input type="checkbox"/> <input type="checkbox"/> <input type="checkbox"/>	<input type="checkbox"/> <input type="checkbox"/>	<input type="checkbox"/> <input type="checkbox"/> <input type="checkbox"/>

A

B

C

D

HOW TO ORDER

Indicate the following information on order form:

1. Quantity of each item.
2. Model number, including options. See "How To Build a Model Number".
3. Any special service required.

Note: • The indicates that a choice is required.

- The absence of the indicates that no choice is required.
- Alpha-numeric characters in place of indicate that no other alternatives are available.

HOW TO BUILD A MODEL NUMBER

A Select basic model.

B Select pull option.

ALBT	- Aluminum Bow Tie
ALMT	- Aluminum Metric
ARCN	- Arc Nickel
CLSC	- Classic (inset pull)
NKBT	- Nickel Bow Tie
RETN	- Retro Nickel

C Select unit and drawer color.

Refer to color addendum at ki.com or KI Fabrics & Finishes binder.

D Select key option.

KA	- Key alike
KS	- Key standard
NLC	- No lock core

INFORMATION

Folder Bars

Files are configured for side-to-side media storage. For alternative configurations, see the General Information section.

Height

All dimensions shown include 1/8" allowance for glides in recessed position.

Accessories

See accessory section for accessories that can be ordered separately.

Weights

Figures provided are approximate and reflect packaged product without additional accessories.



Preconfigured Locker Units

700 Series® Cupboard/Bookcase/Markerboard

Approx. Packaged Weight	Delivered Pricing
186.0#	\$ 2478
186.0#	2478
194.0#	2675
194.0#	2675
194.0#	3405
194.0#	3405

182.0#	\$ 2543
182.0#	2543
191.0#	2762
191.0#	2762
191.0#	3649
191.0#	3649

SPECIAL SERVICES

Special Carton Marking

With specially marked information N/C



Shipping

Shipped **assembled freight prepaid f.o.b. Pembroke, Ontario K8A 0E1** factory. Freight class #70.

Specifications and prices are subject to change without prior notice.

Preconfigured Locker Units

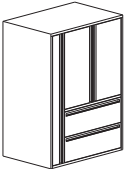
700 Series® Cupboard/Bookcase/Markerboard

MODEL	Features	W x D	MODEL NUMBER			
			Basic Model	Pull Option	Unit Color	Key Option
 <p>S7FL</p> <p>30" Wide - 24" File, 6" Wide Locker, 24" Deep</p> <ul style="list-style-type: none"> • 36" H cupboard or bookcase with 2 shelves (files 2 rows of binders) • 1-1/2" tie bar shelf • Two 12" high drawers • 6" wide full length door (left or right side) with coat rod • Full length pull and lock • Cupboard shown in picture • Two locks per bookcase unit • Three locks per cupboard and markerboard units • Last model digit indicates locker hinge location 	Locker Left, Bookcase Right	30 x 24"	7FL/3061524/2D360B/6FLL	<input type="checkbox"/> <input type="checkbox"/> <input type="checkbox"/> <input type="checkbox"/>	<input type="checkbox"/> <input type="checkbox"/>	<input type="checkbox"/> <input type="checkbox"/> <input type="checkbox"/>
	Locker Right, Bookcase Left	30 x 24"	7FL/3061524/2D360B/6FLR	<input type="checkbox"/> <input type="checkbox"/> <input type="checkbox"/> <input type="checkbox"/>	<input type="checkbox"/> <input type="checkbox"/>	<input type="checkbox"/> <input type="checkbox"/> <input type="checkbox"/>
	Locker Left, Cupboard Right	30 x 24"	7FL/3061524/2D360C/6FLL	<input type="checkbox"/> <input type="checkbox"/> <input type="checkbox"/> <input type="checkbox"/>	<input type="checkbox"/> <input type="checkbox"/>	<input type="checkbox"/> <input type="checkbox"/> <input type="checkbox"/>
	Locker Right, Cupboard Left	30 x 24"	7FL/3061524/2D360C/6FLR	<input type="checkbox"/> <input type="checkbox"/> <input type="checkbox"/> <input type="checkbox"/>	<input type="checkbox"/> <input type="checkbox"/>	<input type="checkbox"/> <input type="checkbox"/> <input type="checkbox"/>
	Locker Left, Markerboard Right	30 x 24"	7FL/3061524/2D360CMB/6FLL	<input type="checkbox"/> <input type="checkbox"/> <input type="checkbox"/> <input type="checkbox"/>	<input type="checkbox"/> <input type="checkbox"/>	<input type="checkbox"/> <input type="checkbox"/> <input type="checkbox"/>
	Locker Right, Markerboard Left	30 x 24"	7FL/3061524/2D360CMB/6FLR	<input type="checkbox"/> <input type="checkbox"/> <input type="checkbox"/> <input type="checkbox"/>	<input type="checkbox"/> <input type="checkbox"/>	<input type="checkbox"/> <input type="checkbox"/> <input type="checkbox"/>
 <p>S7FL</p> <p>30" Wide - 24" File, 6" Wide Locker, 24" Deep</p> <ul style="list-style-type: none"> • 30" H cupboard or bookcase with 1 shelf (files 2 rows of binders) • 1-1/2" tie bar shelf • One 6" high drawer, two 12" high drawers • 6" wide full length door (left or right side) with coat rod • Full length pull and lock • Markerboard shown in picture • Two locks per bookcase unit • Three locks per cupboard and markerboard units • Last model digit indicates locker hinge location 	Locker Left, Bookcase Right	30 x 24"	7FL/3061524/3D300B/6FLL	<input type="checkbox"/> <input type="checkbox"/> <input type="checkbox"/> <input type="checkbox"/>	<input type="checkbox"/> <input type="checkbox"/>	<input type="checkbox"/> <input type="checkbox"/> <input type="checkbox"/>
	Locker Right, Bookcase Left	30 x 24"	7FL/3061524/3D300B/6FLR	<input type="checkbox"/> <input type="checkbox"/> <input type="checkbox"/> <input type="checkbox"/>	<input type="checkbox"/> <input type="checkbox"/>	<input type="checkbox"/> <input type="checkbox"/> <input type="checkbox"/>
	Locker Left, Cupboard Right	30 x 24"	7FL/3061524/3D300C/6FLL	<input type="checkbox"/> <input type="checkbox"/> <input type="checkbox"/> <input type="checkbox"/>	<input type="checkbox"/> <input type="checkbox"/>	<input type="checkbox"/> <input type="checkbox"/> <input type="checkbox"/>
	Locker Right, Cupboard Left	30 x 24"	7FL/3061524/3D300C/6FLR	<input type="checkbox"/> <input type="checkbox"/> <input type="checkbox"/> <input type="checkbox"/>	<input type="checkbox"/> <input type="checkbox"/>	<input type="checkbox"/> <input type="checkbox"/> <input type="checkbox"/>
	Locker Left, Markerboard Right	30 x 24"	7FL/3061524/3D300CMB/6FLL	<input type="checkbox"/> <input type="checkbox"/> <input type="checkbox"/> <input type="checkbox"/>	<input type="checkbox"/> <input type="checkbox"/>	<input type="checkbox"/> <input type="checkbox"/> <input type="checkbox"/>
	Locker Right, Markerboard Left	30 x 24"	7FL/3061524/3D300CMB/6FLR	<input type="checkbox"/> <input type="checkbox"/> <input type="checkbox"/> <input type="checkbox"/>	<input type="checkbox"/> <input type="checkbox"/>	<input type="checkbox"/> <input type="checkbox"/> <input type="checkbox"/>
			A	B	C	D

HOW TO ORDER

Indicate the following information on order form:

1. Quantity of each item.
2. Model number, including options. See "How To Build a Model Number".
3. Any special service required.

Note: • The indicates that a choice is required.

- The absence of the indicates that no choice is required.
- Alpha-numeric characters in place of indicate that no other alternatives are available.

HOW TO BUILD A MODEL NUMBER

A Select basic model.

B Select pull option.

ALBT	- Aluminum Bow Tie
ALMT	- Aluminum Metric
ARCN	- Arc Nickel
CLSC	- Classic (inset pull)
NKBT	- Nickel Bow Tie
RETN	- Retro Nickel

C Select unit and drawer color.

Refer to color addendum at ki.com or KI Fabrics & Finishes binder.

D Select key option.

KA	- Key alike
KS	- Key standard
NLC	- No lock core

INFORMATION

Folder Bars

Files are configured for side-to-side media storage. For alternative configurations, see the General Information section.

Height

All dimensions shown include 1/8" allowance for glides in recessed position.

Accessories

See accessory section for accessories that can be ordered separately.

Weights

Figures provided are approximate and reflect packaged product without additional accessories.



Preconfigured Locker Units

700 Series® Cupboard/Bookcase/Markerboard

Approx. Packaged Weight	Delivered Pricing
188.0#	\$ 2481
188.0#	2481
196.0#	2704
196.0#	2704
196.0#	3933
196.0#	3933

199.0#	\$ 2484
199.0#	2484
208.0#	2675
208.0#	2675
208.0#	3488
208.0#	3488

SPECIAL SERVICES

Special Carton Marking

With specially marked information N/C

Shipping

Shipped **assembled freight prepaid f.o.b. Pembroke, Ontario K8A 0E1** factory. Freight class #70.

Specifications and prices are subject to change without prior notice.

Preconfigured Locker Units

700 Series® Cupboard/Bookcase/Markerboard

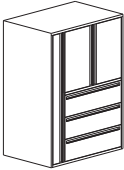
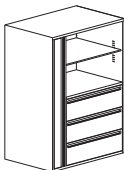
MODEL	Features	W x D	MODEL NUMBER			
			Basic Model	Pull Option	Unit Color	Key Option
 <p>S7FL</p> <p>30" Wide - 24" File, 6" Wide Locker, 24" Deep</p> <ul style="list-style-type: none"> • 28-1/2" H cupboard or bookcase with 1 shelf (files 2 rows of binders) • 1-1/2" tie bar shelf • Three 10-1/2" high drawers • 6" wide full length door (left or right side) with coat rod • Full length pull and lock • Cupboard shown in picture • Two locks per bookcase unit • Three locks per cupboard and markerboard units • Last model digit indicates locker hinge location 	Locker Left, Bookcase Right	30 x 24"	7FL/3061524/3D285B/6FLL	<input type="checkbox"/> <input type="checkbox"/> <input type="checkbox"/> <input type="checkbox"/>	<input type="checkbox"/> <input type="checkbox"/>	<input type="checkbox"/> <input type="checkbox"/> <input type="checkbox"/>
	Locker Right, Bookcase Left	30 x 24"	7FL/3061524/3D285B/6FLR	<input type="checkbox"/> <input type="checkbox"/> <input type="checkbox"/> <input type="checkbox"/>	<input type="checkbox"/> <input type="checkbox"/>	<input type="checkbox"/> <input type="checkbox"/> <input type="checkbox"/>
	Locker Left, Cupboard Right	30 x 24"	7FL/3061524/3D285C/6FLL	<input type="checkbox"/> <input type="checkbox"/> <input type="checkbox"/> <input type="checkbox"/>	<input type="checkbox"/> <input type="checkbox"/>	<input type="checkbox"/> <input type="checkbox"/> <input type="checkbox"/>
	Locker Right, Cupboard Left	30 x 24"	7FL/3061524/3D285C/6FLR	<input type="checkbox"/> <input type="checkbox"/> <input type="checkbox"/> <input type="checkbox"/>	<input type="checkbox"/> <input type="checkbox"/>	<input type="checkbox"/> <input type="checkbox"/> <input type="checkbox"/>
	Locker Left, Markerboard Right	30 x 24"	7FL/3061524/3D285CMB/6FLL	<input type="checkbox"/> <input type="checkbox"/> <input type="checkbox"/> <input type="checkbox"/>	<input type="checkbox"/> <input type="checkbox"/>	<input type="checkbox"/> <input type="checkbox"/> <input type="checkbox"/>
	Locker Right, Markerboard Left	30 x 24"	7FL/3061524/3D285CMB/6FLR	<input type="checkbox"/> <input type="checkbox"/> <input type="checkbox"/> <input type="checkbox"/>	<input type="checkbox"/> <input type="checkbox"/>	<input type="checkbox"/> <input type="checkbox"/> <input type="checkbox"/>
 <p>S7FL</p> <p>30" Wide - 24" File, 6" Wide Locker, 24" Deep</p> <ul style="list-style-type: none"> • 33" H cupboard or bookcase with 1 shelf (files 2 rows of binders) • 1-1/2" tie bar shelf • One 6" high drawer, two 10-1/2" high drawers • 6" wide full length door (left or right side) with coat rod • Full length pull and lock • Bookcase shown in picture • Two locks per bookcase unit • Three locks per cupboard and markerboard units • Last model digit indicates locker hinge location 	Locker Left, Bookcase Right	30 x 24"	7FL/3061524/3D330B/6FLL	<input type="checkbox"/> <input type="checkbox"/> <input type="checkbox"/> <input type="checkbox"/>	<input type="checkbox"/> <input type="checkbox"/>	<input type="checkbox"/> <input type="checkbox"/> <input type="checkbox"/>
	Locker Right, Bookcase Left	30 x 24"	7FL/3061524/3D330B/6FLR	<input type="checkbox"/> <input type="checkbox"/> <input type="checkbox"/> <input type="checkbox"/>	<input type="checkbox"/> <input type="checkbox"/>	<input type="checkbox"/> <input type="checkbox"/> <input type="checkbox"/>
	Locker Left, Cupboard Right	30 x 24"	7FL/3061524/3D330C/6FLL	<input type="checkbox"/> <input type="checkbox"/> <input type="checkbox"/> <input type="checkbox"/>	<input type="checkbox"/> <input type="checkbox"/>	<input type="checkbox"/> <input type="checkbox"/> <input type="checkbox"/>
	Locker Right, Cupboard Left	30 x 24"	7FL/3061524/3D330C/6FLR	<input type="checkbox"/> <input type="checkbox"/> <input type="checkbox"/> <input type="checkbox"/>	<input type="checkbox"/> <input type="checkbox"/>	<input type="checkbox"/> <input type="checkbox"/> <input type="checkbox"/>
	Locker Left, Markerboard Right	30 x 24"	7FL/3061524/3D330CMB/6FLL	<input type="checkbox"/> <input type="checkbox"/> <input type="checkbox"/> <input type="checkbox"/>	<input type="checkbox"/> <input type="checkbox"/>	<input type="checkbox"/> <input type="checkbox"/> <input type="checkbox"/>
	Locker Right, Markerboard Left	30 x 24"	7FL/3061524/3D330CMB/6FLR	<input type="checkbox"/> <input type="checkbox"/> <input type="checkbox"/> <input type="checkbox"/>	<input type="checkbox"/> <input type="checkbox"/>	<input type="checkbox"/> <input type="checkbox"/> <input type="checkbox"/>

A

B

C

D

HOW TO ORDER

Indicate the following information on order form:

1. Quantity of each item.
2. Model number, including options. See "How To Build a Model Number".
3. Any special service required.

Note: • The indicates that a choice is required.

- The absence of the indicates that no choice is required.
- Alpha-numeric characters in place of indicate that no other alternatives are available.

HOW TO BUILD A MODEL NUMBER

A Select basic model.

B Select pull option.

ALBT	- Aluminum Bow Tie
ALMT	- Aluminum Metric
ARCN	- Arc Nickel
CLSC	- Classic (inset pull)
NKBT	- Nickel Bow Tie
RETN	- Retro Nickel

C Select unit and drawer color.

Refer to color addendum at ki.com or KI Fabrics & Finishes binder.

D Select key option.

KA	- Key alike
KS	- Key standard
NLC	- No lock core

INFORMATION

Folder Bars

Files are configured for side-to-side media storage. For alternative configurations, see the General Information section.

Height

All dimensions shown include 1/8" allowance for glides in recessed position.

Accessories

See accessory section for accessories that can be ordered separately.

Weights

Figures provided are approximate and reflect packaged product without additional accessories.



Preconfigured Locker Units

700 Series® Cupboard/Bookcase/Markerboard

Approx. Packaged Weight	Delivered Pricing
208.0#	\$ 2636
208.0#	2636
231.0#	2816
231.0#	2816
231.0#	3547
231.0#	3547

199.0#	\$ 2484
199.0#	2484
208.0#	2675
208.0#	2675
208.0#	3488
208.0#	3488

SPECIAL SERVICES

Special Carton Marking

With specially marked information N/C

Shipping

Shipped **assembled freight prepaid f.o.b. Pembroke, Ontario K8A 0E1** factory. Freight class #70.

Specifications and prices are subject to change without prior notice.

Preconfigured Locker Units

700 Series® Curve Cupboard/Bookcase/Markerboard

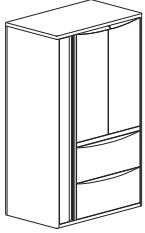

7CFL

30" Wide - 24" File, 6" Wide Locker, 18" Deep

- 36" H cupboard or bookcase w/2 shelves (files 2 rows of binders)
- 1-1/2" tie bar shelf
- Two 12" high drawers
- 6" wide full length door (left or right side) with coat rod
- Full length pull and lock
- Cupboard shown in picture
- Two locks per bookcase unit
- Three locks per cupboard and markerboard units
- Last model digit indicates locker hinge location

Features	W x D	MODEL NUMBER				
		Basic Model	Dimpled	Unit Color	Pull Color	Key Option
Locker Left, Bookcase Right	30 x 18"	7CFL3061518/2D360B/6FLL	<input type="checkbox"/>	<input type="checkbox"/> <input type="checkbox"/> <input type="checkbox"/>	<input type="checkbox"/> <input type="checkbox"/> <input type="checkbox"/> <input type="checkbox"/> <input type="checkbox"/> <input type="checkbox"/> <input type="checkbox"/> <input type="checkbox"/>	<input type="checkbox"/> <input type="checkbox"/> <input type="checkbox"/>
Locker Right, Bookcase Left	30 x 18"	7CFL3061518/2D360B/6FLR	<input type="checkbox"/>	<input type="checkbox"/> <input type="checkbox"/> <input type="checkbox"/>	<input type="checkbox"/> <input type="checkbox"/> <input type="checkbox"/> <input type="checkbox"/> <input type="checkbox"/> <input type="checkbox"/> <input type="checkbox"/> <input type="checkbox"/>	<input type="checkbox"/> <input type="checkbox"/> <input type="checkbox"/>
Locker Left, Cupboard Right	30 x 18"	7CFL3061518/2D360C/6FLL	<input type="checkbox"/>	<input type="checkbox"/> <input type="checkbox"/> <input type="checkbox"/>	<input type="checkbox"/> <input type="checkbox"/> <input type="checkbox"/> <input type="checkbox"/> <input type="checkbox"/> <input type="checkbox"/> <input type="checkbox"/> <input type="checkbox"/>	<input type="checkbox"/> <input type="checkbox"/> <input type="checkbox"/>
Locker Right, Cupboard Left	30 x 18"	7CFL3061518/2D360C/6FLR	<input type="checkbox"/>	<input type="checkbox"/> <input type="checkbox"/> <input type="checkbox"/>	<input type="checkbox"/> <input type="checkbox"/> <input type="checkbox"/> <input type="checkbox"/> <input type="checkbox"/> <input type="checkbox"/> <input type="checkbox"/> <input type="checkbox"/>	<input type="checkbox"/> <input type="checkbox"/> <input type="checkbox"/>
Locker Left, Markerboard Right	30 x 18"	7CFL3061518/2D360CMB/6FLL	<input type="checkbox"/>	<input type="checkbox"/> <input type="checkbox"/> <input type="checkbox"/>	<input type="checkbox"/> <input type="checkbox"/> <input type="checkbox"/> <input type="checkbox"/> <input type="checkbox"/> <input type="checkbox"/> <input type="checkbox"/> <input type="checkbox"/>	<input type="checkbox"/> <input type="checkbox"/> <input type="checkbox"/>
Locker Right, Markerboard Left	30 x 18"	7CFL3061518/2D360CMB/6FLR	<input type="checkbox"/>	<input type="checkbox"/> <input type="checkbox"/> <input type="checkbox"/>	<input type="checkbox"/> <input type="checkbox"/> <input type="checkbox"/> <input type="checkbox"/> <input type="checkbox"/> <input type="checkbox"/> <input type="checkbox"/> <input type="checkbox"/>	<input type="checkbox"/> <input type="checkbox"/> <input type="checkbox"/>

A **B** **C** **D** **E**

HOW TO ORDER

Indicate the following information on order form:

1. Quantity of each item.
2. Model number, including options. See "How To Build a Model Number".
3. Any special service required.

Note: • The indicates that a choice is required.
 • The absence of the indicates that no choice is required.
 • Alpha-numeric characters in place of indicate that no other alternatives are available.

HOW TO BUILD A MODEL NUMBER

- A** Select basic model.
- B** Select flat or dimpled front.

D	- Dimpled
F	- Flat

 See upcharge column for D option.
- C** Select unit and drawer color. Refer to color addendum at ki.com or KI Fabrics & Finishes binder.
- D** Select drawer pull color. Refer to color addendum at ki.com or KI Fabrics & Finishes binder.
- E** Select key option.

KA	- Key alike
KS	- Key standard
NLC	- No lock core

INFORMATION

Folder Bars

Files are configured for side-to-side media storage. For alternative configurations, see the General Information section.

Height

All dimensions shown include 1/8" allowance for glides in recessed position.

Accessories

See accessory section for accessories that can be ordered separately.

Weights

Figures provided are approximate and reflect packaged product without additional accessories.



Preconfigured Locker Units

700 Series® Curve Cupboard/Bookcase/Markerboard

Approx. Packaged Weight	Delivered Pricing	Dimpled Front add to list price
168.0#	\$ 2773	\$ 54
168.0#	2773	54
175.0#	3074	59
175.0#	3074	59
175.0#	4551	84
175.0#	4551	84

SPECIAL SERVICES

Special Carton Marking

With specially marked information N/C

Shipping

Shipped **assembled freight prepaid f.o.b. Pembroke, Ontario K8A 0E1** factory. Freight class #70.

Specifications and prices are subject to change without prior notice.



Preconfigured Locker Units

700 Series® Curve Cupboard/Bookcase/Markerboard

Approx. Packaged Weight	Delivered Pricing	Dimpled Front add to list price
182.0#	\$ 2801	\$ 54
182.0#	2801	54
191.0#	3040	58
191.0#	3040	58
191.0#	4011	77
191.0#	4011	77

SPECIAL SERVICES

Special Carton Marking

With specially marked information N/C

Shipping

Shipped **assembled freight prepaid f.o.b. Pembroke, Ontario K8A 0E1** factory. Freight class #70.

Specifications and prices are subject to change without prior notice.

Preconfigured Locker Units

700 Series® Curve Cupboard/Bookcase/Markerboard

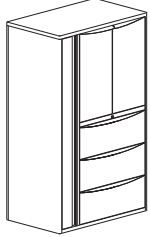

7CFL

30" Wide - 24" File, 6" Wide Locker, 18" Deep

- 28-1/2" H cupboard or bookcase w/1 shelf (files 2 rows of binders)
- 1-1/2" tie bar shelf
- Three 10-1/2" high drawers
- 6" wide full length door (left or right side) with coat rod
- Full length pull and lock
- Cupboard shown in picture
- Two locks per bookcase unit
- Three locks per cupboard and markerboard units
- Last model digit indicates locker hinge location

Features	W x D	MODEL NUMBER				
		Basic Model	Dimpled	Unit Color	Pull Color	Key Option
Locker Left, Bookcase Right	30 x 18"	7CFL3061518/3D285B/6FLL	<input type="checkbox"/>	<input type="checkbox"/> <input type="checkbox"/> <input type="checkbox"/>	<input type="checkbox"/> <input type="checkbox"/> <input type="checkbox"/> <input type="checkbox"/> <input type="checkbox"/> <input type="checkbox"/> <input type="checkbox"/> <input type="checkbox"/>	<input type="checkbox"/> <input type="checkbox"/> <input type="checkbox"/>
Locker Right, Bookcase Left	30 x 18"	7CFL3061518/3D285B/6FLR	<input type="checkbox"/>	<input type="checkbox"/> <input type="checkbox"/> <input type="checkbox"/>	<input type="checkbox"/> <input type="checkbox"/> <input type="checkbox"/> <input type="checkbox"/> <input type="checkbox"/> <input type="checkbox"/> <input type="checkbox"/> <input type="checkbox"/>	<input type="checkbox"/> <input type="checkbox"/> <input type="checkbox"/>
Locker Left, Cupboard Right	30 x 18"	7CFL3061518/3D285C/6FLL	<input type="checkbox"/>	<input type="checkbox"/> <input type="checkbox"/> <input type="checkbox"/>	<input type="checkbox"/> <input type="checkbox"/> <input type="checkbox"/> <input type="checkbox"/> <input type="checkbox"/> <input type="checkbox"/> <input type="checkbox"/> <input type="checkbox"/>	<input type="checkbox"/> <input type="checkbox"/> <input type="checkbox"/>
Locker Right, Cupboard Left	30 x 18"	7CFL3061518/3D285C/6FLR	<input type="checkbox"/>	<input type="checkbox"/> <input type="checkbox"/> <input type="checkbox"/>	<input type="checkbox"/> <input type="checkbox"/> <input type="checkbox"/> <input type="checkbox"/> <input type="checkbox"/> <input type="checkbox"/> <input type="checkbox"/> <input type="checkbox"/>	<input type="checkbox"/> <input type="checkbox"/> <input type="checkbox"/>
Locker Left, Markerboard Right	30 x 18"	7CFL3061518/3D285CMB/6FLL	<input type="checkbox"/>	<input type="checkbox"/> <input type="checkbox"/> <input type="checkbox"/>	<input type="checkbox"/> <input type="checkbox"/> <input type="checkbox"/> <input type="checkbox"/> <input type="checkbox"/> <input type="checkbox"/> <input type="checkbox"/> <input type="checkbox"/>	<input type="checkbox"/> <input type="checkbox"/> <input type="checkbox"/>
Locker Right, Markerboard Left	30 x 18"	7CFL3061518/3D285CMB/6FLR	<input type="checkbox"/>	<input type="checkbox"/> <input type="checkbox"/> <input type="checkbox"/>	<input type="checkbox"/> <input type="checkbox"/> <input type="checkbox"/> <input type="checkbox"/> <input type="checkbox"/> <input type="checkbox"/> <input type="checkbox"/> <input type="checkbox"/>	<input type="checkbox"/> <input type="checkbox"/> <input type="checkbox"/>

A **B** **C** **D** **E**

HOW TO ORDER

Indicate the following information on order form:

1. Quantity of each item.
2. Model number, including options. See "How To Build a Model Number".
3. Any special service required.

Note: • The indicates that a choice is required.
 • The absence of the indicates that no choice is required.
 • Alpha-numeric characters in place of indicate that no other alternatives are available.

HOW TO BUILD A MODEL NUMBER

- A** Select basic model.
- B** Select flat or dimpled front.

D	- Dimpled
F	- Flat

 See upcharge column for D option.
- C** Select unit and drawer color. Refer to color addendum at ki.com or KI Fabrics & Finishes binder.
- D** Select drawer pull color. Refer to color addendum at ki.com or KI Fabrics & Finishes binder.
- E** Select key option.

KA	- Key alike
KS	- Key standard
NLC	- No lock core

INFORMATION

Folder Bars

Files are configured for side-to-side media storage. For alternative configurations, see the General Information section.

Height

All dimensions shown include 1/8" allowance for glides in recessed position.

Accessories

See accessory section for accessories that can be ordered separately.

Weights

Figures provided are approximate and reflect packaged product without additional accessories.



Preconfigured Locker Units

700 Series® Curve Cupboard/Bookcase/Markerboard

Approx. Packaged Weight	Delivered Pricing	Dimpled Front add to list price
186.0#	\$ 2974	\$ 58
186.0#	2974	58
194.0#	3208	63
194.0#	3208	63
194.0#	4086	78
194.0#	4086	78

SPECIAL SERVICES

Special Carton Marking

With specially marked information N/C

Shipping

Shipped **assembled freight prepaid f.o.b. Pembroke, Ontario K8A 0E1** factory. Freight class #70.

Specifications and prices are subject to change without prior notice.



Preconfigured Locker Units

700 Series® Curve Cupboard/Bookcase/Markerboard

Approx. Packaged Weight	Delivered Pricing	Dimpled Front add to list price
182.0#	\$ 2801	\$ 54
182.0#	2801	54
191.0#	3040	58
191.0#	3040	58
191.0#	4011	77
191.0#	4011	77

SPECIAL SERVICES

Special Carton Marking

With specially marked information N/C

Shipping

Shipped **assembled freight prepaid f.o.b. Pembroke, Ontario K8A 0E1** factory. Freight class #70.

Specifications and prices are subject to change without prior notice.

Preconfigured Locker Units

700 Series® Curve Cupboard/Bookcase/Markerboard

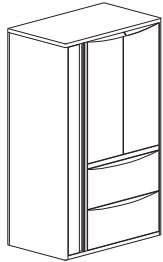

7CFL

30" Wide - 24" File, 6" Wide Locker, 24" Deep

- 36" H cupboard or bookcase w/2 shelves (files 2 rows of binders)
- 1-1/2" tie bar shelf
- Two 12" high drawers
- 6" wide full length door (left or right side) with coat rod
- Full length pull and lock
- Cupboard shown in picture
- Two locks per bookcase unit
- Three locks per cupboard and markerboard units
- Last model digit indicates locker hinge location

Features	W x D	MODEL NUMBER				
		Basic Model	Dimpled	Unit Color	Pull Color	Key Option
Locker Left, Bookcase Right	30 x 24"	7CFL3061524/2D360B/6FLL	<input type="checkbox"/>	<input type="checkbox"/>	<input type="checkbox"/>	<input type="checkbox"/>
Locker Right, Bookcase Left	30 x 24"	7CFL3061524/2D360B/6FLR	<input type="checkbox"/>	<input type="checkbox"/>	<input type="checkbox"/>	<input type="checkbox"/>
Locker Left, Cupboard Right	30 x 24"	7CFL3061524/2D360C/6FLL	<input type="checkbox"/>	<input type="checkbox"/>	<input type="checkbox"/>	<input type="checkbox"/>
Locker Right, Cupboard Left	30 x 24"	7CFL3061524/2D360C/6FLR	<input type="checkbox"/>	<input type="checkbox"/>	<input type="checkbox"/>	<input type="checkbox"/>
Locker Left, Markerboard Right	30 x 24"	7CFL3061524/2D360CMB/6FLL	<input type="checkbox"/>	<input type="checkbox"/>	<input type="checkbox"/>	<input type="checkbox"/>
Locker Right, Markerboard Left	30 x 24"	7CFL3061524/2D360CMB/6FLR	<input type="checkbox"/>	<input type="checkbox"/>	<input type="checkbox"/>	<input type="checkbox"/>

A **B** **C** **D** **E**

HOW TO ORDER

Indicate the following information on order form:

1. Quantity of each item.
2. Model number, including options. See "How To Build a Model Number".
3. Any special service required.

Note: • The indicates that a choice is required.

- The absence of the indicates that no choice is required.
- Alpha-numeric characters in place of indicate that no other alternatives are available.

HOW TO BUILD A MODEL NUMBER

- A** Select basic model.
- B** Select flat or dimpled front.
 D - Dimpled
 F - Flat
 See upcharge column for D option.
- C** Select unit and drawer color.
 Refer to color addendum at ki.com or KI Fabrics & Finishes binder.
- D** Select drawer pull color.
 Refer to color addendum at ki.com or KI Fabrics & Finishes binder.
- E** Select key option.
 KA - Key alike
 KS - Key standard
 NLC - No lock core

INFORMATION

Folder Bars

Files are configured for side-to-side media storage. For alternative configurations, see the General Information section.

Height

All dimensions shown include 1/8" allowance for glides in recessed position.

Accessories

See accessory section for accessories that can be ordered separately.

Weights

Figures provided are approximate and reflect packaged product without additional accessories.



Preconfigured Locker Units

700 Series® Curve Cupboard/Bookcase/Markerboard

Approx. Packaged Weight	Delivered Pricing	Dimpled Front add to list price
188.0#	\$ 2979	\$ 58
188.0#	2979	58
196.0#	3246	63
196.0#	3246	63
196.0#	4717	93
196.0#	4717	93

SPECIAL SERVICES

Special Carton Marking

With specially marked information N/C

Shipping

Shipped **assembled freight prepaid f.o.b. Pembroke, Ontario K8A 0E1** factory. Freight class #70.

Specifications and prices are subject to change without prior notice.



Preconfigured Locker Units

700 Series® Curve Cupboard/Bookcase/Markerboard

Approx. Packaged Weight	Delivered Pricing	Dimpled Front add to list price
199.0#	\$ 2983	\$ 58
199.0#	2983	58
208.0#	3211	63
208.0#	3211	63
208.0#	4184	79
208.0#	4184	79

SPECIAL SERVICES

Special Carton Marking

With specially marked information N/C

Shipping

Shipped **assembled freight prepaid f.o.b. Pembroke, Ontario K8A 0E1** factory. Freight class #70.

Specifications and prices are subject to change without prior notice.

Preconfigured Locker Units

700 Series® Curve Cupboard/Bookcase/Markerboard

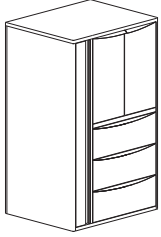

7CFL

30" Wide - 24" File, 6" Wide Locker, 24" Deep

- 28-1/2" H cupboard or bookcase w/1 shelf (files 2 rows of binders)
- 1-1/2" tie bar shelf
- Three 10-1/2" high drawers
- 6" wide full length door (left or right side) with coat rod
- Full length pull and lock
- Cupboard shown in picture
- Two locks per bookcase unit
- Three locks per cupboard and markerboard units
- Last model digit indicates locker hinge location

Features	W x D	MODEL NUMBER				
		Basic Model	Dimpled	Unit Color	Pull Color	Key Option
Locker Left, Bookcase Right	30 x 24"	7CFL3061524/3D285B/6FLL	<input type="checkbox"/>	<input type="checkbox"/> <input type="checkbox"/> <input type="checkbox"/>	<input type="checkbox"/> <input type="checkbox"/> <input type="checkbox"/> <input type="checkbox"/> <input type="checkbox"/> <input type="checkbox"/> <input type="checkbox"/> <input type="checkbox"/>	<input type="checkbox"/> <input type="checkbox"/>
Locker Right, Bookcase Left	30 x 24"	7CFL3061524/3D285B/6FLR	<input type="checkbox"/>	<input type="checkbox"/> <input type="checkbox"/> <input type="checkbox"/>	<input type="checkbox"/> <input type="checkbox"/> <input type="checkbox"/> <input type="checkbox"/> <input type="checkbox"/> <input type="checkbox"/> <input type="checkbox"/> <input type="checkbox"/>	<input type="checkbox"/> <input type="checkbox"/>
Locker Left, Cupboard Right	30 x 24"	7CFL3061524/3D285C/6FLL	<input type="checkbox"/>	<input type="checkbox"/> <input type="checkbox"/> <input type="checkbox"/>	<input type="checkbox"/> <input type="checkbox"/> <input type="checkbox"/> <input type="checkbox"/> <input type="checkbox"/> <input type="checkbox"/> <input type="checkbox"/> <input type="checkbox"/>	<input type="checkbox"/> <input type="checkbox"/>
Locker Right, Cupboard Left	30 x 24"	7CFL3061524/3D285C/6FLR	<input type="checkbox"/>	<input type="checkbox"/> <input type="checkbox"/> <input type="checkbox"/>	<input type="checkbox"/> <input type="checkbox"/> <input type="checkbox"/> <input type="checkbox"/> <input type="checkbox"/> <input type="checkbox"/> <input type="checkbox"/> <input type="checkbox"/>	<input type="checkbox"/> <input type="checkbox"/>
Locker Left, Markerboard Right	30 x 24"	7CFL3061524/3D285CMB/6FLL	<input type="checkbox"/>	<input type="checkbox"/> <input type="checkbox"/> <input type="checkbox"/>	<input type="checkbox"/> <input type="checkbox"/> <input type="checkbox"/> <input type="checkbox"/> <input type="checkbox"/> <input type="checkbox"/> <input type="checkbox"/> <input type="checkbox"/>	<input type="checkbox"/> <input type="checkbox"/>
Locker Right, Markerboard Left	30 x 24"	7CFL3061524/3D285CMB/6FLR	<input type="checkbox"/>	<input type="checkbox"/> <input type="checkbox"/> <input type="checkbox"/>	<input type="checkbox"/> <input type="checkbox"/> <input type="checkbox"/> <input type="checkbox"/> <input type="checkbox"/> <input type="checkbox"/> <input type="checkbox"/> <input type="checkbox"/>	<input type="checkbox"/> <input type="checkbox"/>

A **B** **C** **D** **E**

HOW TO ORDER

Indicate the following information on order form:

1. Quantity of each item.
2. Model number, including options. See "How To Build a Model Number".
3. Any special service required.

Note: • The indicates that a choice is required.
 • The absence of the indicates that no choice is required.
 • Alpha-numeric characters in place of indicate that no other alternatives are available.

HOW TO BUILD A MODEL NUMBER

- A** Select basic model.
- B** Select flat or dimpled front.

D	- Dimpled
F	- Flat

 See upcharge column for D option.
- C** Select unit and drawer color. Refer to color addendum at ki.com or KI Fabrics & Finishes binder.
- D** Select drawer pull color. Refer to color addendum at ki.com or KI Fabrics & Finishes binder.
- E** Select key option.

KA	- Key alike
KS	- Key standard
NLC	- No lock core

INFORMATION

Folder Bars
 Files are configured for side-to-side media storage. For alternative configurations, see the General Information section.

Height
 All dimensions shown include 1/8" allowance for glides in recessed position.

Accessories
 See accessory section for accessories that can be ordered separately.

Weights
 Figures provided are approximate and reflect packaged product without additional accessories.



Preconfigured Locker Units

700 Series® Curve Cupboard/Bookcase/Markerboard

Approx. Packaged Weight	Delivered Pricing	Dimpled Front add to list price
208.0#	\$ 3162	\$ 60
208.0#	3162	60
231.0#	3376	67
231.0#	3376	67
231.0#	4253	81
231.0#	4253	81

SPECIAL SERVICES

Special Carton Marking

With specially marked information N/C

Shipping

Shipped **assembled freight prepaid f.o.b. Pembroke, Ontario K8A 0E1** factory. Freight class #70.

Specifications and prices are subject to change without prior notice.

Preconfigured Locker Units

700 Series® Curve Cupboard/Bookcase/Markerboard

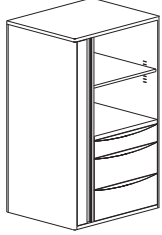

7CFL

30" Wide - 24" File, 6" Wide Locker, 24" Deep

- 33" H cupboard or bookcase w/1 shelf (files 2 rows of binders)
- 1-1/2" tie bar shelf
- One 6" high drawer, two 10-1/2" high drawers
- 6" wide full length door (left or right side) with coat rod
- Full length pull and lock
- Bookcase shown in picture
- Two locks per bookcase unit
- Three locks per cupboard and markerboard units
- Last model digit indicates locker hinge location

Features	W x D	MODEL NUMBER				
		Basic Model	Dimpled	Unit Color	Pull Color	Key Option
Locker Left, Bookcase Right	30 x 24"	7CFL3061524/3D330B/6FLL	<input type="checkbox"/>	<input type="checkbox"/> <input type="checkbox"/> <input type="checkbox"/>	<input type="checkbox"/> <input type="checkbox"/> <input type="checkbox"/> <input type="checkbox"/> <input type="checkbox"/> <input type="checkbox"/> <input type="checkbox"/> <input type="checkbox"/>	<input type="checkbox"/> <input type="checkbox"/>
Locker Right, Bookcase Left	30 x 24"	7CFL3061524/3D330B/6FLR	<input type="checkbox"/>	<input type="checkbox"/> <input type="checkbox"/> <input type="checkbox"/>	<input type="checkbox"/> <input type="checkbox"/> <input type="checkbox"/> <input type="checkbox"/> <input type="checkbox"/> <input type="checkbox"/> <input type="checkbox"/> <input type="checkbox"/>	<input type="checkbox"/> <input type="checkbox"/>
Locker Left, Cupboard Right	30 x 24"	7CFL3061524/3D330C/6FLL	<input type="checkbox"/>	<input type="checkbox"/> <input type="checkbox"/> <input type="checkbox"/>	<input type="checkbox"/> <input type="checkbox"/> <input type="checkbox"/> <input type="checkbox"/> <input type="checkbox"/> <input type="checkbox"/> <input type="checkbox"/> <input type="checkbox"/>	<input type="checkbox"/> <input type="checkbox"/>
Locker Right, Cupboard Left	30 x 24"	7CFL3061524/3D330C/6FLR	<input type="checkbox"/>	<input type="checkbox"/> <input type="checkbox"/> <input type="checkbox"/>	<input type="checkbox"/> <input type="checkbox"/> <input type="checkbox"/> <input type="checkbox"/> <input type="checkbox"/> <input type="checkbox"/> <input type="checkbox"/> <input type="checkbox"/>	<input type="checkbox"/> <input type="checkbox"/>
Locker Left, Markerboard Right	30 x 24"	7CFL3061524/3D330CMB/6FLL	<input type="checkbox"/>	<input type="checkbox"/> <input type="checkbox"/> <input type="checkbox"/>	<input type="checkbox"/> <input type="checkbox"/> <input type="checkbox"/> <input type="checkbox"/> <input type="checkbox"/> <input type="checkbox"/> <input type="checkbox"/> <input type="checkbox"/>	<input type="checkbox"/> <input type="checkbox"/>
Locker Right, Markerboard Left	30 x 24"	7CFL3061524/3D330CMB/6FLR	<input type="checkbox"/>	<input type="checkbox"/> <input type="checkbox"/> <input type="checkbox"/>	<input type="checkbox"/> <input type="checkbox"/> <input type="checkbox"/> <input type="checkbox"/> <input type="checkbox"/> <input type="checkbox"/> <input type="checkbox"/> <input type="checkbox"/>	<input type="checkbox"/> <input type="checkbox"/>

A **B** **C** **D** **E**

HOW TO ORDER

Indicate the following information on order form:

1. Quantity of each item.
2. Model number, including options. See "How To Build a Model Number".
3. Any special service required.

Note: • The indicates that a choice is required.
 • The absence of the indicates that no choice is required.
 • Alpha-numeric characters in place of indicate that no other alternatives are available.

HOW TO BUILD A MODEL NUMBER

- A** Select basic model.
- B** Select flat or dimpled front.

D	- Dimpled
F	- Flat

 See upcharge column for D option.
- C** Select unit and drawer color.
 Refer to color addendum at ki.com or KI Fabrics & Finishes binder.
- D** Select drawer pull color.
 Refer to color addendum at ki.com or KI Fabrics & Finishes binder.
- E** Select key option.

KA	- Key alike
KS	- Key standard
NLC	- No lock core

INFORMATION

Folder Bars
 Files are configured for side-to-side media storage. For alternative configurations, see the General Information section.

Height
 All dimensions shown include 1/8" allowance for glides in recessed position.

Accessories
 See accessory section for accessories that can be ordered separately.

Weights
 Figures provided are approximate and reflect packaged product without additional accessories.



Preconfigured Locker Units

700 Series® Curve Cupboard/Bookcase/Markerboard

Approx. Packaged Weight	Delivered Pricing	Dimpled Front add to list price
199.0#	\$ 2983	\$ 58
199.0#	2983	58
208.0#	3211	63
208.0#	3211	63
208.0#	4184	79
208.0#	4184	79

SPECIAL SERVICES

Special Carton Marking

With specially marked information N/C

Shipping

Shipped **assembled freight prepaid f.o.b. Pembroke, Ontario K8A 0E1** factory. Freight class #70.

Specifications and prices are subject to change without prior notice.

Preconfigured Storage

700 Series® Multimedia Storage Cabinets

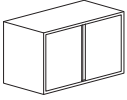
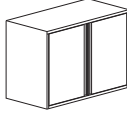
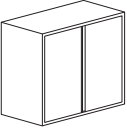
	MODEL	Features	W x D x H	MODEL NUMBER				Approx. Packaged Weight
				Basic Model	Pull Option	Unit Color	Key Option	
 S7CUBU	27" Multimedia Storage Cabinet • Available with one adjustable blank shelf	With 1 Shelf	30 x 18 x 27"	S7L/30240HD	<input type="checkbox"/> <input type="checkbox"/> <input type="checkbox"/> <input type="checkbox"/>	<input type="checkbox"/> <input type="checkbox"/>	<input type="checkbox"/> <input type="checkbox"/> <input type="checkbox"/>	95.0#
		With 1 Shelf	36 x 18 x 27"	S7L/36240HD	<input type="checkbox"/> <input type="checkbox"/> <input type="checkbox"/> <input type="checkbox"/>	<input type="checkbox"/> <input type="checkbox"/>	<input type="checkbox"/> <input type="checkbox"/> <input type="checkbox"/>	105.0#
		With 1 Shelf	42 x 18 x 27"	S7L/42240HD	<input type="checkbox"/> <input type="checkbox"/> <input type="checkbox"/> <input type="checkbox"/>	<input type="checkbox"/> <input type="checkbox"/>	<input type="checkbox"/> <input type="checkbox"/> <input type="checkbox"/>	121.0#
 S7CUBU	33-1/2" Multimedia Storage Cabinet • Available with one adjustable blank shelf	With 1 Shelf	30 x 18 x 33-1/8"	S7L/30300HD	<input type="checkbox"/> <input type="checkbox"/> <input type="checkbox"/> <input type="checkbox"/>	<input type="checkbox"/> <input type="checkbox"/>	<input type="checkbox"/> <input type="checkbox"/> <input type="checkbox"/>	105.0#
		With 1 Shelf	36 x 18 x 33-1/8"	S7L/36300HD	<input type="checkbox"/> <input type="checkbox"/> <input type="checkbox"/> <input type="checkbox"/>	<input type="checkbox"/> <input type="checkbox"/>	<input type="checkbox"/> <input type="checkbox"/> <input type="checkbox"/>	121.0#
		With 1 Shelf	42 x 18 x 33-1/8"	S7L/42300HD	<input type="checkbox"/> <input type="checkbox"/> <input type="checkbox"/> <input type="checkbox"/>	<input type="checkbox"/> <input type="checkbox"/>	<input type="checkbox"/> <input type="checkbox"/> <input type="checkbox"/>	137.0#
 S7CUBU	39-1/4" Multimedia Storage Cabinet • Available with two adjustable blank shelves	With 2 Shelves	30 x 18 x 39-1/4"	S7L/30360HD	<input type="checkbox"/> <input type="checkbox"/> <input type="checkbox"/> <input type="checkbox"/>	<input type="checkbox"/> <input type="checkbox"/>	<input type="checkbox"/> <input type="checkbox"/> <input type="checkbox"/>	121.0#
		With 2 Shelves	36 x 18 x 39-1/4"	S7L/36360HD	<input type="checkbox"/> <input type="checkbox"/> <input type="checkbox"/> <input type="checkbox"/>	<input type="checkbox"/> <input type="checkbox"/>	<input type="checkbox"/> <input type="checkbox"/> <input type="checkbox"/>	137.0#
		With 2 Shelves	42 x 18 x 39-1/4"	S7L/42360HD	<input type="checkbox"/> <input type="checkbox"/> <input type="checkbox"/> <input type="checkbox"/>	<input type="checkbox"/> <input type="checkbox"/>	<input type="checkbox"/> <input type="checkbox"/> <input type="checkbox"/>	152.0#

A **B** **C** **D**

HOW TO ORDER

Indicate the following information on order form:

- Quantity of each item.
- Model number, including options. See "How To Build a Model Number".
- Any special service required.

Note: • The indicates that a choice is required.

- The absence of the indicates that no choice is required.
- Alpha-numeric characters in place of indicate that no other alternatives are available.

HOW TO BUILD A MODEL NUMBER

A Select basic model.

B Select pull option.

ALBT - Aluminum Bow Tie

ALMT - Aluminum Metric

ARCN - Arc Nickel

CLSC - Classic (inset pull)

NKBT - Nickel Bow Tie

RETN - Retro Nickel

C Select unit color.

Refer to color addendum at ki.com or KI Fabrics & Finishes binder.

D Select key option.

KA - Key alike

KS - Key standard

NLC - No lock core

INFORMATION

Height

All dimensions shown include 1/8" allowance for glides in recessed position.

Accessories

See accessory section for accessories that can be ordered separately.

Weights

Figures provided are approximate and reflect packaged product without additional accessories.



Preconfigured Storage

700 Series® Multimedia Storage Cabinets

Delivered
Pricing

\$ 774

840

897

\$ 870

962

1020

\$ 962

1038

1135

SPECIAL SERVICES

Special Carton Marking

With specially marked information N/C

Shipping

Shipped **assembled freight prepaid f.o.b. Pembroke, Ontario K8A 0E1** factory.
Freight class #70.

Specifications and prices are subject to change without prior notice.

Preconfigured Storage

700 Series® Multimedia Storage Cabinets

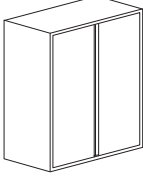
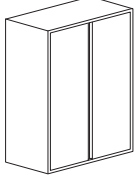
	MODEL	Features	W x D x H	MODEL NUMBER				Approx. Packaged Weight
				Basic Model	Pull Option	Unit Color	Key Option	
 <p>S7CBU</p>	51-1/2" Multimedia Storage Cabinet • Available with two adjustable blank shelves	With 2 Shelves	30 x 18 x 51-1/2"	S7L/30480HD	<input type="checkbox"/> <input type="checkbox"/> <input type="checkbox"/> <input type="checkbox"/>	<input type="checkbox"/> <input type="checkbox"/>	<input type="checkbox"/> <input type="checkbox"/> <input type="checkbox"/> <input type="checkbox"/>	150.0#
		With 2 Shelves	36 x 18 x 51-1/2"	S7L/36480HD	<input type="checkbox"/> <input type="checkbox"/> <input type="checkbox"/> <input type="checkbox"/>	<input type="checkbox"/> <input type="checkbox"/>	<input type="checkbox"/> <input type="checkbox"/> <input type="checkbox"/> <input type="checkbox"/>	160.0#
		With 2 Shelves	42 x 18 x 51-1/2"	S7L/42480HD	<input type="checkbox"/> <input type="checkbox"/> <input type="checkbox"/> <input type="checkbox"/>	<input type="checkbox"/> <input type="checkbox"/>	<input type="checkbox"/> <input type="checkbox"/> <input type="checkbox"/> <input type="checkbox"/>	180.0#
 <p>S7CBU</p>	56-3/32" Multimedia Storage Cabinet • Available with two adjustable blank shelves	With 2 Shelves	30 x 18 x 56-3/32"	S7L/30525HD	<input type="checkbox"/> <input type="checkbox"/> <input type="checkbox"/> <input type="checkbox"/>	<input type="checkbox"/> <input type="checkbox"/>	<input type="checkbox"/> <input type="checkbox"/> <input type="checkbox"/> <input type="checkbox"/>	160.0#
		With 2 Shelves	36 x 18 x 56-3/32"	S7L/36525HD	<input type="checkbox"/> <input type="checkbox"/> <input type="checkbox"/> <input type="checkbox"/>	<input type="checkbox"/> <input type="checkbox"/>	<input type="checkbox"/> <input type="checkbox"/> <input type="checkbox"/> <input type="checkbox"/>	170.0#
		With 2 Shelves	42 x 18 x 56-3/32"	S7L/42525HD	<input type="checkbox"/> <input type="checkbox"/> <input type="checkbox"/> <input type="checkbox"/>	<input type="checkbox"/> <input type="checkbox"/>	<input type="checkbox"/> <input type="checkbox"/> <input type="checkbox"/> <input type="checkbox"/>	190.0#

A

B

C

D

HOW TO ORDER

Indicate the following information on order form:

- Quantity of each item.
- Model number, including options. See "How To Build a Model Number".
- Any special service required.

Note: • The indicates that a choice is required.

- The absence of the indicates that no choice is required.
- Alpha-numeric characters in place of indicate that no other alternatives are available.

HOW TO BUILD A MODEL NUMBER

A Select basic model.

B Select pull option.

ALBT - Aluminum Bow Tie

ALMT - Aluminum Metric

ARCN - Arc Nickel

CLSC - Classic (inset pull)

NKBT - Nickel Bow Tie

RETN - Retro Nickel

C Select unit color.

Refer to color addendum at ki.com or KI Fabrics & Finishes binder.

D Select key option.

KA - Key alike

KS - Key standard

NLC - No lock core

INFORMATION

Height

All dimensions shown include 1/8" allowance for glides in recessed position.

Accessories

See accessory section for accessories that can be ordered separately.

Weights

Figures provided are approximate and reflect packaged product without additional accessories.



Preconfigured Storage

700 Series® Multimedia Storage Cabinets

Delivered
Pricing

\$ 1038
1190
1342

\$ 1222
1305
1380

SPECIAL SERVICES

Special Carton Marking

With specially marked information N/C

Shipping

Shipped **assembled freight prepaid f.o.b. Pembroke, Ontario K8A 0E1** factory.
Freight class #70.

Specifications and prices are subject to change without prior notice.

Preconfigured Storage

700 Series® Multimedia Storage Cabinets

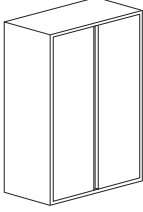
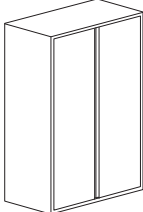
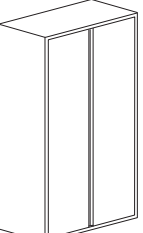
	MODEL	Features	W x D x H	MODEL NUMBER				Approx. Packaged Weight
				Basic Model	Pull Option	Unit Color	Key Option	
 <p>S7CBU</p>	63-3/4" Multimedia Storage Cabinet • Available with three adjustable blank shelves	With 3 Shelves	30 x 18 x 63-3/4"	S7L/30600HD	<input type="checkbox"/> <input type="checkbox"/> <input type="checkbox"/> <input type="checkbox"/>	<input type="checkbox"/> <input type="checkbox"/>	<input type="checkbox"/> <input type="checkbox"/> <input type="checkbox"/>	175.0#
		With 3 Shelves	36 x 18 x 63-3/4"	S7L/36600HD	<input type="checkbox"/> <input type="checkbox"/> <input type="checkbox"/> <input type="checkbox"/>	<input type="checkbox"/> <input type="checkbox"/>	<input type="checkbox"/> <input type="checkbox"/> <input type="checkbox"/>	190.0#
		With 3 Shelves	42 x 18 x 63-3/4"	S7L/42600HD	<input type="checkbox"/> <input type="checkbox"/> <input type="checkbox"/> <input type="checkbox"/>	<input type="checkbox"/> <input type="checkbox"/>	<input type="checkbox"/> <input type="checkbox"/> <input type="checkbox"/>	225.0#
 <p>S7CBU</p>	65-9/32" Multimedia Storage Cabinet • Available with three adjustable blank shelves	With 3 Shelves	30 x 18 x 65-9/32"	S7L/30615HD	<input type="checkbox"/> <input type="checkbox"/> <input type="checkbox"/> <input type="checkbox"/>	<input type="checkbox"/> <input type="checkbox"/>	<input type="checkbox"/> <input type="checkbox"/> <input type="checkbox"/>	180.0#
		With 3 Shelves	36 x 18 x 65-9/32"	S7L/36615HD	<input type="checkbox"/> <input type="checkbox"/> <input type="checkbox"/> <input type="checkbox"/>	<input type="checkbox"/> <input type="checkbox"/>	<input type="checkbox"/> <input type="checkbox"/> <input type="checkbox"/>	195.0#
		With 3 Shelves	42 x 18 x 65-9/32"	S7L/42615HD	<input type="checkbox"/> <input type="checkbox"/> <input type="checkbox"/> <input type="checkbox"/>	<input type="checkbox"/> <input type="checkbox"/>	<input type="checkbox"/> <input type="checkbox"/> <input type="checkbox"/>	230.0#
 <p>S7CBU</p>	77-17/32" Multimedia Storage Cabinet • Available with four adjustable blank shelves	With 4 Shelves	30 x 18 x 77-17/32"	S7L/30735HD	<input type="checkbox"/> <input type="checkbox"/> <input type="checkbox"/> <input type="checkbox"/>	<input type="checkbox"/> <input type="checkbox"/>	<input type="checkbox"/> <input type="checkbox"/> <input type="checkbox"/>	210.0#
		With 4 Shelves	36 x 18 x 77-17/32"	S7L/36735HD	<input type="checkbox"/> <input type="checkbox"/> <input type="checkbox"/> <input type="checkbox"/>	<input type="checkbox"/> <input type="checkbox"/>	<input type="checkbox"/> <input type="checkbox"/> <input type="checkbox"/>	230.0#

A **B** **C** **D**

HOW TO ORDER

Indicate the following information on order form:

- Quantity of each item.
- Model number, including options. See "How To Build a Model Number".
- Any special service required.

Note: • The indicates that a choice is required.

- The absence of the indicates that no choice is required.
- Alpha-numeric characters in place of indicate that no other alternatives are available.

HOW TO BUILD A MODEL NUMBER

- A** Select basic model.

ALBT	- Aluminum Bow Tie
ALMT	- Aluminum Metric
ARCN	- Arc Nickel
CLSC	- Classic (inset pull)
NKBT	- Nickel Bow Tie
RETN	- Retro Nickel
- C** Select unit color.
Refer to color addendum at ki.com or KI Fabrics & Finishes binder.
- D** Select key option.

KA	- Key alike
KS	- Key standard
NLC	- No lock core

INFORMATION

Height

All dimensions shown include 1/8" allowance for glides in recessed position.

Accessories

See accessory section for accessories that can be ordered separately.

Weights

Figures provided are approximate and reflect packaged product without additional accessories.



Preconfigured Storage

700 Series® Multimedia Storage Cabinets

Delivered
Pricing

\$ 1238

1320

1510

\$ 1238

1320

1510

\$ 1504

1646

SPECIAL SERVICES

Special Carton Marking

With specially marked information N/C

Shipping

Shipped **assembled freight prepaid f.o.b. Pembroke, Ontario K8A 0E1** factory.
Freight class #70.

Specifications and prices are subject to change without prior notice.

Preconfigured Storage

700 Series® Multimedia Storage Cabinets

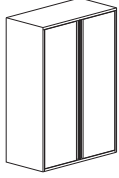

S7GBU

MODEL	Features	W x D x H	MODEL NUMBER				Approx. Packaged Weight
			Basic Model	Pull Option	Unit Color	Key Option	
69-7/8" Multimedia Storage Cabinet • All internal accessories must be ordered separately	No Shelf	30 x 18 x 69-7/8"	S7L/30660HX	<input type="checkbox"/> <input type="checkbox"/> <input type="checkbox"/> <input type="checkbox"/>	<input type="checkbox"/>	<input type="checkbox"/> <input type="checkbox"/>	95.0#
	No Shelf	36 x 18 x 69-7/8"	S7L/36660HX	<input type="checkbox"/> <input type="checkbox"/> <input type="checkbox"/> <input type="checkbox"/>	<input type="checkbox"/>	<input type="checkbox"/> <input type="checkbox"/>	102.0#

A **B** **C** **D**

HOW TO ORDER

Indicate the following information on order form:

- Quantity of each item.
- Model number, including options. See "How To Build a Model Number".
- Any special service required.

Note: • The indicates that a choice is required.

- The absence of the indicates that no choice is required.
- Alpha-numeric characters in place of indicate that no other alternatives are available.

HOW TO BUILD A MODEL NUMBER

- A** Select basic model.

ALBT	- Aluminum Bow Tie
ALMT	- Aluminum Metric
ARCN	- Arc Nickel
CLSC	- Classic (inset pull)
NKBT	- Nickel Bow Tie
RETN	- Retro Nickel
- C** Select unit color.
Refer to color addendum at ki.com or KI Fabrics & Finishes binder.
- D** Select key option.

KA	- Key alike
KS	- Key standard
NLC	- No lock core

INFORMATION

Height

All dimensions shown include 1/8" allowance for glides in recessed position.

Accessories

See accessory section for accessories that can be ordered separately.

Weights

Figures provided are approximate and reflect packaged product without additional accessories.



Preconfigured Storage

700 Series® Multimedia Storage Cabinets

Delivered
Pricing

\$ 1225

1304

SPECIAL SERVICES

Special Carton Marking

With specially marked information N/C

Shipping

Shipped **assembled freight prepaid f.o.b. Pembroke, Ontario K8A 0E1** factory.
Freight class #70.

Specifications and prices are subject to change without prior notice.

Preconfigured Storage

700 Series® Multimedia Storage Cabinets

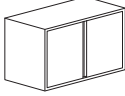
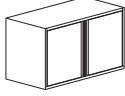
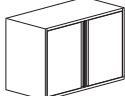
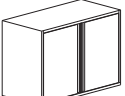
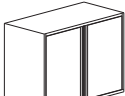
	MODEL	W x D x H	MODEL NUMBER				Approx. Packaged Weight
			Basic Model	Pull Option	Unit Color	Key Option	
	26-7/8" OverCupboard Storage Cabinet • For placement on top of similar width cabinet; not for floor installation • Available with one adjustable blank shelf • Lock located at bottom of cabinet	30 x 18 x 26-7/8"	S7L/302400VHD	<input type="checkbox"/> <input type="checkbox"/> <input type="checkbox"/> <input type="checkbox"/>	<input type="checkbox"/> <input type="checkbox"/>	<input type="checkbox"/> <input type="checkbox"/> <input type="checkbox"/>	70.0#
		36 x 18 x 26-7/8"	S7L/362400VHD	<input type="checkbox"/> <input type="checkbox"/> <input type="checkbox"/> <input type="checkbox"/>	<input type="checkbox"/> <input type="checkbox"/>	<input type="checkbox"/> <input type="checkbox"/> <input type="checkbox"/>	80.0#
		42 x 18 x 26-7/8"	S7L/422400VHD	<input type="checkbox"/> <input type="checkbox"/> <input type="checkbox"/> <input type="checkbox"/>	<input type="checkbox"/> <input type="checkbox"/>	<input type="checkbox"/> <input type="checkbox"/> <input type="checkbox"/>	95.0#
S70V							
	26-7/8" OverCupboard Storage Cabinet • Interiors to be specified separately at time of configuration • For placement on top of similar width cabinet; not for floor installation • Lock located at bottom of cabinet	30 x 18 x 26-7/8"	S7L/302400VHX	<input type="checkbox"/> <input type="checkbox"/> <input type="checkbox"/> <input type="checkbox"/>	<input type="checkbox"/> <input type="checkbox"/>	<input type="checkbox"/> <input type="checkbox"/> <input type="checkbox"/>	42.0#
		36 x 18 x 26-7/8"	S7L/362400VHX	<input type="checkbox"/> <input type="checkbox"/> <input type="checkbox"/> <input type="checkbox"/>	<input type="checkbox"/> <input type="checkbox"/>	<input type="checkbox"/> <input type="checkbox"/> <input type="checkbox"/>	50.0#
		42 x 18 x 26-7/8"	S7L/422400VHX	<input type="checkbox"/> <input type="checkbox"/> <input type="checkbox"/> <input type="checkbox"/>	<input type="checkbox"/> <input type="checkbox"/>	<input type="checkbox"/> <input type="checkbox"/> <input type="checkbox"/>	56.0#
S70V							
	31-15/32" OverCupboard Storage Cabinet • Interiors to be specified separately at time of configuration • For placement on top of similar width cabinet; not for floor installation • Lock located at bottom of cabinet	30 x 18 x 31-15/32"	S7L/302850VHX	<input type="checkbox"/> <input type="checkbox"/> <input type="checkbox"/> <input type="checkbox"/>	<input type="checkbox"/> <input type="checkbox"/>	<input type="checkbox"/> <input type="checkbox"/> <input type="checkbox"/>	48.0#
		36 x 18 x 31-15/32"	S7L/362850VHX	<input type="checkbox"/> <input type="checkbox"/> <input type="checkbox"/> <input type="checkbox"/>	<input type="checkbox"/> <input type="checkbox"/>	<input type="checkbox"/> <input type="checkbox"/> <input type="checkbox"/>	56.0#
		42 x 18 x 31-15/32"	S7L/422850VHX	<input type="checkbox"/> <input type="checkbox"/> <input type="checkbox"/> <input type="checkbox"/>	<input type="checkbox"/> <input type="checkbox"/>	<input type="checkbox"/> <input type="checkbox"/> <input type="checkbox"/>	63.0#
S70V							
	33" OverCupboard Storage Cabinet • Interiors to be specified separately at time of configuration • For placement on top of similar width cabinet; not for floor installation • Lock located at bottom of cabinet	30 x 18 x 33"	S7L/303000VHX	<input type="checkbox"/> <input type="checkbox"/> <input type="checkbox"/> <input type="checkbox"/>	<input type="checkbox"/> <input type="checkbox"/>	<input type="checkbox"/> <input type="checkbox"/> <input type="checkbox"/>	52.0#
		36 x 18 x 33"	S7L/363000VHX	<input type="checkbox"/> <input type="checkbox"/> <input type="checkbox"/> <input type="checkbox"/>	<input type="checkbox"/> <input type="checkbox"/>	<input type="checkbox"/> <input type="checkbox"/> <input type="checkbox"/>	60.0#
		42 x 18 x 33"	S7L/423000VHX	<input type="checkbox"/> <input type="checkbox"/> <input type="checkbox"/> <input type="checkbox"/>	<input type="checkbox"/> <input type="checkbox"/>	<input type="checkbox"/> <input type="checkbox"/> <input type="checkbox"/>	67.0#
S70V							
	34-17/32" OverCupboard Storage Cabinet • Interiors to be specified separately at time of configuration • For placement on top of similar width cabinet; not for floor installation • Lock located at bottom of cabinet	30 x 18 x 34-17/32"	S7L/303150VHX	<input type="checkbox"/> <input type="checkbox"/> <input type="checkbox"/> <input type="checkbox"/>	<input type="checkbox"/> <input type="checkbox"/>	<input type="checkbox"/> <input type="checkbox"/> <input type="checkbox"/>	54.0#
		36 x 18 x 34-17/32"	S7L/363150VHX	<input type="checkbox"/> <input type="checkbox"/> <input type="checkbox"/> <input type="checkbox"/>	<input type="checkbox"/> <input type="checkbox"/>	<input type="checkbox"/> <input type="checkbox"/> <input type="checkbox"/>	62.0#
		42 x 18 x 34-17/32"	S7L/423150VHX	<input type="checkbox"/> <input type="checkbox"/> <input type="checkbox"/> <input type="checkbox"/>	<input type="checkbox"/> <input type="checkbox"/>	<input type="checkbox"/> <input type="checkbox"/> <input type="checkbox"/>	69.0#
S70V							

A

B

C

D

HOW TO ORDER

Indicate the following information on order form:

- Quantity of each item.
- Model number, including options. See "How To Build a Model Number".
- Any special service required.

Note: • The indicates that a choice is required.

- The absence of the indicates that no choice is required.
- Alpha-numeric characters in place of indicate that no other alternatives are available.

HOW TO BUILD A MODEL NUMBER

A Select basic model.

B Select pull option.

ALBT	- Aluminum Bow Tie
ALMT	- Aluminum Metric
ARCN	- Arc Nickel
CLSC	- Classic (inset pull)
NKBT	- Nickel Bow Tie
RETN	- Retro Nickel

C Select unit color.

Refer to color addendum at ki.com or KI Fabrics & Finishes binder.

D Select key option.

KA	- Key alike
KS	- Key standard
NLC	- No lock core

INFORMATION

Accessories

See accessory section for accessories that can be ordered separately.

Weights

Figures provided are approximate and reflect packaged product without additional accessories.



Preconfigured Storage

700 Series® Multimedia Storage Cabinets

Delivered Pricing

\$ 814
850
927

\$ 744
777
821

\$ 829
863
922

\$ 834
874
928

\$ 835
879
934

SPECIAL SERVICES

Special Carton Marking

With specially marked information N/C

Shipping

Shipped **assembled freight prepaid f.o.b. Pembroke, Ontario K8A 0E1** factory. Freight class #70.

Specifications and prices are subject to change without prior notice.

Preconfigured Storage

700 Series® Multimedia Storage Cabinets

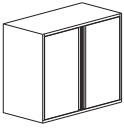
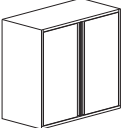
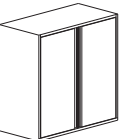
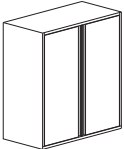
	MODEL	W x D x H	MODEL NUMBER				Approx. Packaged Weight
			Basic Model	Pull Option	Unit Color	Key Option	
 <p>S70V</p>	39-1/8" OverCupboard Storage Cabinet • Interiors to be specified separately at time of configuration • For placement on top of similar width cabinet; not for floor installation • Lock located at bottom of cabinet	30 x 18 x 39-1/8"	S7L/303600VHX	<input type="checkbox"/> <input type="checkbox"/> <input type="checkbox"/> <input type="checkbox"/>	<input type="checkbox"/> <input type="checkbox"/>	<input type="checkbox"/> <input type="checkbox"/> <input type="checkbox"/>	58.0#
		36 x 18 x 39-1/8"	S7L/363600VHX	<input type="checkbox"/> <input type="checkbox"/> <input type="checkbox"/> <input type="checkbox"/>	<input type="checkbox"/> <input type="checkbox"/>	<input type="checkbox"/> <input type="checkbox"/> <input type="checkbox"/>	68.0#
		42 x 18 x 39-1/8"	S7L/423600VHX	<input type="checkbox"/> <input type="checkbox"/> <input type="checkbox"/> <input type="checkbox"/>	<input type="checkbox"/> <input type="checkbox"/>	<input type="checkbox"/> <input type="checkbox"/> <input type="checkbox"/>	75.0#
 <p>S70V</p>	43-23/32" OverCupboard Storage Cabinet • Interiors to be specified separately at time of configuration • For placement on top of similar width cabinet; not for floor installation • Lock located at bottom of cabinet	30 x 18 x 43-23/32"	S7L/304050VHX	<input type="checkbox"/> <input type="checkbox"/> <input type="checkbox"/> <input type="checkbox"/>	<input type="checkbox"/> <input type="checkbox"/>	<input type="checkbox"/> <input type="checkbox"/> <input type="checkbox"/>	68.0#
		36 x 18 x 43-23/32"	S7L/364050VHX	<input type="checkbox"/> <input type="checkbox"/> <input type="checkbox"/> <input type="checkbox"/>	<input type="checkbox"/> <input type="checkbox"/>	<input type="checkbox"/> <input type="checkbox"/> <input type="checkbox"/>	75.0#
		42 x 18 x 43-23/32"	S7L/424050VHX	<input type="checkbox"/> <input type="checkbox"/> <input type="checkbox"/> <input type="checkbox"/>	<input type="checkbox"/> <input type="checkbox"/>	<input type="checkbox"/> <input type="checkbox"/> <input type="checkbox"/>	82.0#
 <p>S70V</p>	46-25/32" OverCupboard Storage Cabinet • Interiors to be specified separately at time of configuration • For placement on top of similar width cabinet; not for floor installation • Lock located at bottom of cabinet	30 x 18 x 46-25/32"	S7L/304350VHX	<input type="checkbox"/> <input type="checkbox"/> <input type="checkbox"/> <input type="checkbox"/>	<input type="checkbox"/> <input type="checkbox"/>	<input type="checkbox"/> <input type="checkbox"/> <input type="checkbox"/>	71.0#
		36 x 18 x 46-25/32"	S7L/364350VHX	<input type="checkbox"/> <input type="checkbox"/> <input type="checkbox"/> <input type="checkbox"/>	<input type="checkbox"/> <input type="checkbox"/>	<input type="checkbox"/> <input type="checkbox"/> <input type="checkbox"/>	78.0#
		42 x 18 x 46-25/32"	S7L/424350VHX	<input type="checkbox"/> <input type="checkbox"/> <input type="checkbox"/> <input type="checkbox"/>	<input type="checkbox"/> <input type="checkbox"/>	<input type="checkbox"/> <input type="checkbox"/> <input type="checkbox"/>	85.0#
 <p>S70V</p>	51-3/8" OverCupboard Storage Cabinet • Interiors to be specified separately at time of configuration • For placement on top of similar width cabinet; not for floor installation • Lock located at bottom of cabinet	30 x 18 x 51-3/8"	S7L/304800VHX	<input type="checkbox"/> <input type="checkbox"/> <input type="checkbox"/> <input type="checkbox"/>	<input type="checkbox"/> <input type="checkbox"/>	<input type="checkbox"/> <input type="checkbox"/> <input type="checkbox"/>	76.0#
		36 x 18 x 51-3/8"	S7L/364800VHX	<input type="checkbox"/> <input type="checkbox"/> <input type="checkbox"/> <input type="checkbox"/>	<input type="checkbox"/> <input type="checkbox"/>	<input type="checkbox"/> <input type="checkbox"/> <input type="checkbox"/>	83.0#
		42 x 18 x 51-3/8"	S7L/424800VHX	<input type="checkbox"/> <input type="checkbox"/> <input type="checkbox"/> <input type="checkbox"/>	<input type="checkbox"/> <input type="checkbox"/>	<input type="checkbox"/> <input type="checkbox"/> <input type="checkbox"/>	90.0#

A

B

C

D

HOW TO ORDER

Indicate the following information on order form:

- Quantity of each item.
- Model number, including options. See "How To Build a Model Number".
- Any special service required.

Note: • The indicates that a choice is required.

- The absence of the indicates that no choice is required.
- Alpha-numeric characters in place of indicate that no other alternatives are available.

HOW TO BUILD A MODEL NUMBER

A Select basic model.

B Select pull option.

ALBT	- Aluminum Bow Tie
ALMT	- Aluminum Metric
ARCN	- Arc Nickel
CLSC	- Classic (inset pull)
NKBT	- Nickel Bow Tie
RETN	- Retro Nickel

C Select unit color.

Refer to color addendum at ki.com or KI Fabrics & Finishes binder.

D Select key option.

KA	- Key alike
KS	- Key standard
NLC	- No lock core

INFORMATION

Accessories

See accessory section for accessories that can be ordered separately.

Weights

Figures provided are approximate and reflect packaged product without additional accessories.



Preconfigured Storage

700 Series® Multimedia Storage Cabinets

Delivered Pricing

\$ 896
942
999

\$ 962
1009
1067

\$ 979
1028
1075

\$ 984
1042
1094

SPECIAL SERVICES

Special Carton Marking

With specially marked information N/C

Shipping

Shipped **assembled freight prepaid f.o.b. Pembroke, Ontario K8A 0E1** factory. Freight class #70.

Specifications and prices are subject to change without prior notice.

Preconfigured Storage

700 Series® Curve Multimedia Storage Cabinets

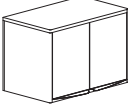
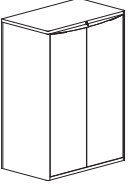
				MODEL NUMBER				
MODEL	Features	W x D	Basic Model	Dimpled	Unit Color	Pull Color	Key Option	
	26-7/8" OverCupboard Storage Cabinet	With 1 Shelf	30 x 18"	S7CL302400VHD	<input type="checkbox"/>	<input type="checkbox"/> <input type="checkbox"/> <input type="checkbox"/>	<input type="checkbox"/> <input type="checkbox"/> <input type="checkbox"/> <input type="checkbox"/> <input type="checkbox"/> <input type="checkbox"/> <input type="checkbox"/> <input type="checkbox"/>	<input type="checkbox"/> <input type="checkbox"/> <input type="checkbox"/>
	<ul style="list-style-type: none"> For placement on top of similar width cabinet; not for floor installation 	With 1 Shelf	36 x 18"	S7CL362400VHD	<input type="checkbox"/>	<input type="checkbox"/> <input type="checkbox"/> <input type="checkbox"/>	<input type="checkbox"/> <input type="checkbox"/> <input type="checkbox"/> <input type="checkbox"/> <input type="checkbox"/> <input type="checkbox"/> <input type="checkbox"/> <input type="checkbox"/>	<input type="checkbox"/> <input type="checkbox"/> <input type="checkbox"/>
	<ul style="list-style-type: none"> Available with one adjustable blank shelf Lock located at bottom of cabinet 	With 1 Shelf	42 x 18"	S7CL422400VHD	<input type="checkbox"/>	<input type="checkbox"/> <input type="checkbox"/> <input type="checkbox"/>	<input type="checkbox"/> <input type="checkbox"/> <input type="checkbox"/> <input type="checkbox"/> <input type="checkbox"/> <input type="checkbox"/> <input type="checkbox"/> <input type="checkbox"/>	<input type="checkbox"/> <input type="checkbox"/> <input type="checkbox"/>
S7CC								
	56-3/32" Multimedia Storage Cabinet	With 2 Shelves	36 x 18"	S7CL36525HD	<input type="checkbox"/>	<input type="checkbox"/> <input type="checkbox"/> <input type="checkbox"/>	<input type="checkbox"/> <input type="checkbox"/> <input type="checkbox"/> <input type="checkbox"/> <input type="checkbox"/> <input type="checkbox"/> <input type="checkbox"/> <input type="checkbox"/>	<input type="checkbox"/> <input type="checkbox"/> <input type="checkbox"/>
	<ul style="list-style-type: none"> Available with two adjustable blank shelves or without any shelves 							
S7CC								

A **B** **C** **D** **E**

HOW TO ORDER

Indicate the following information on order form:

- Quantity of each item.
- Model number, including options. See "How To Build a Model Number".
- Any special service required.

Note:

- The indicates that a choice is required.
- The absence of the indicates that no choice is required.
- Alpha-numeric characters in place of indicate that no other alternatives are available.

HOW TO BUILD A MODEL NUMBER

- A** Select basic model.
- B** Select flat or dimpled front.

D	- Dimpled
F	- Flat

 See upcharge column for D option.
- C** Select unit and drawer color. Refer to color addendum at ki.com or KI Fabrics & Finishes binder.
- D** Select drawer pull color. Refer to color addendum at ki.com or KI Fabrics & Finishes binder.
- E** Select key option.

KA	- Key alike
KS	- Key standard
NLC	- No lock core

INFORMATION

Height
All dimensions shown include 1/8" allowance for glides in recessed position.

Accessories
See accessory section for accessories that can be ordered separately.

Weights
Figures provided are approximate and reflect packaged product without additional accessories.



Preconfigured Storage

700 Series® Curve Multimedia Storage Cabinets

Approx. Packaged Weight	Delivered Pricing	Dimpled Front add to list price
70.0#	\$ 912	\$ 15
80.0#	951	16
95.0#	1037	21

170.0#	\$ 1462	\$ 15
--------	---------	-------

SPECIAL SERVICES

Special Carton Marking

With specially marked information N/C

Shipping

Shipped **assembled freight prepaid f.o.b. Pembroke, Ontario K8A 0E1** factory.
Freight class #70.

Specifications and prices are subject to change without prior notice.

Preconfigured Storage

700 Series® OF Flush Top No Fronts

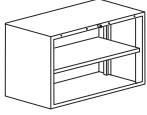
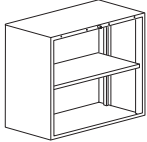
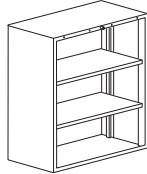
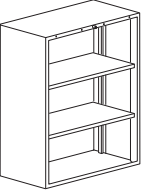
	MODEL	Features	W x D	MODEL NUMBER			Approx. Packaged Weight
				Basic Model	Unit Color	Key Option	
 <p>S7CBO</p>	27" Storage Cabinet • One adjustable shelf • Hinges and mounting hardware included • Depth dimension does not include thickness of drawer front	1 Shelf	30 x 18"	S7LF/30240HDX	<input type="checkbox"/>	<input type="checkbox"/>	70.0#
		1 Shelf	36 x 18"	S7LF/36240HDX	<input type="checkbox"/>	<input type="checkbox"/>	90.0#
		1 Shelf	42 x 18"	S7LF/42240HDX	<input type="checkbox"/>	<input type="checkbox"/>	105.0#
 <p>S7CBO</p>	39-1/4" Storage Cabinet • One adjustable shelf • Hinges and mounting hardware included • Depth dimension does not include thickness of drawer front	1 Shelf	30 x 18"	S7LF/30360HDX	<input type="checkbox"/>	<input type="checkbox"/>	80.0#
		1 Shelf	36 x 18"	S7LF/36360HDX	<input type="checkbox"/>	<input type="checkbox"/>	105.0#
		1 Shelf	42 x 18"	S7LF/42360HDX	<input type="checkbox"/>	<input type="checkbox"/>	110.0#
 <p>S7CBO</p>	51-1/2" Storage Cabinet • Two adjustable shelves • Hinges and mounting hardware included • Depth dimension does not include thickness of drawer front	2 Shelves	30 x 18"	S7LF/30480HDX	<input type="checkbox"/>	<input type="checkbox"/>	125.0#
		2 Shelves	36 x 18"	S7LF/36480HDX	<input type="checkbox"/>	<input type="checkbox"/>	135.0#
		2 Shelves	42 x 18"	S7LF/42480HDX	<input type="checkbox"/>	<input type="checkbox"/>	155.0#
 <p>S7CBO</p>	56-3/32" Storage Cabinet • Two adjustable shelves • Hinges and mounting hardware included • Depth dimension does not include thickness of drawer front	2 Shelves	30 x 18"	S7LF/30525HDX	<input type="checkbox"/>	<input type="checkbox"/>	145.0#
		2 Shelves	36 x 18"	S7LF/36525HDX	<input type="checkbox"/>	<input type="checkbox"/>	155.0#
		2 Shelves	42 x 18"	S7LF/42525HDX	<input type="checkbox"/>	<input type="checkbox"/>	190.0#

A **B** **C**

HOW TO ORDER

Indicate the following information on order form:

- Quantity of each item.
- Model number, including options. See "How To Build a Model Number".
- Any special service required.

Note: • The indicates that a choice is required.

- The absence of the indicates that no choice is required.
- Alpha-numeric characters in place of indicate that no other alternatives are available.

HOW TO BUILD A MODEL NUMBER

- A** Select basic model.
- B** Select unit color.
Refer to color addendum at ki.com or KI Fabrics & Finishes binder.
- C** Select key option.

KA	- Key alike
KS	- Key standard
NLC	- No lock core

INFORMATION

Height

All dimensions shown include 1/8" allowance for glides in recessed position.

Weights

Figures provided are approximate and reflect packaged product without additional accessories.



Preconfigured Storage

700 Series® OF Flush Top No Fronts

Delivered Pricing

\$ 665
708
729

\$ 775
828
860

\$ 874
931
968

\$ 1036
1098
1181

SPECIAL SERVICES

Special Carton Marking

With specially marked information N/C

Shipping

Shipped **assembled freight prepaid f.o.b. Pembroke, Ontario K8A 0E1** factory. Freight class #70.

Specifications and prices are subject to change without prior notice.

Preconfigured Storage

700 Series® OF Flush Top Veneer Fronts

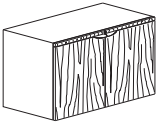
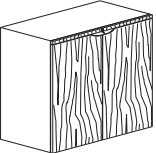
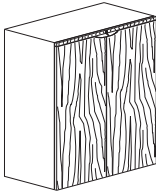
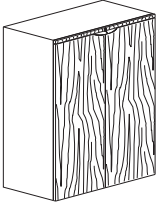
	MODEL	W x D	MODEL NUMBER					Approx. Packaged Weight
			Basic Model	Unit Color	Veneer Color	Pull Color Optional Front	Key Option	
 <p>S7CBO</p>	27" Storage Cabinet with Wood Doors • One adjustable shelf • Veneer door with center pulls • Includes all necessary installation hardware	30 x 18-7/8"	S7LF/30240HW1	<input type="checkbox"/>	<input type="checkbox"/>	<input type="checkbox"/>	<input type="checkbox"/>	95.0#
		36 x 18-7/8"	S7LF/36240HW1	<input type="checkbox"/>	<input type="checkbox"/>	<input type="checkbox"/>	<input type="checkbox"/>	105.0#
		42 x 18-7/8"	S7LF/42240HW1	<input type="checkbox"/>	<input type="checkbox"/>	<input type="checkbox"/>	<input type="checkbox"/>	121.0#
 <p>S7CBO</p>	39-1/4" Storage Cabinet with Wood Doors • One adjustable shelf • Veneer door with center pulls • Includes all necessary installation hardware	30 x 18-7/8"	S7LF/30360HW1	<input type="checkbox"/>	<input type="checkbox"/>	<input type="checkbox"/>	<input type="checkbox"/>	121.0#
		36 x 18-7/8"	S7LF/36360HW1	<input type="checkbox"/>	<input type="checkbox"/>	<input type="checkbox"/>	<input type="checkbox"/>	137.0#
		42 x 18-7/8"	S7LF/42360HW1	<input type="checkbox"/>	<input type="checkbox"/>	<input type="checkbox"/>	<input type="checkbox"/>	152.0#
 <p>S7CBO</p>	51-1/2" Storage Cabinet with Wood Doors • Two adjustable shelves • Veneer door with center pulls • Includes all necessary installation hardware	30 x 18-7/8"	S7LF/30480HW1	<input type="checkbox"/>	<input type="checkbox"/>	<input type="checkbox"/>	<input type="checkbox"/>	150.0#
		36 x 18-7/8"	S7LF/36480HW1	<input type="checkbox"/>	<input type="checkbox"/>	<input type="checkbox"/>	<input type="checkbox"/>	160.0#
		42 x 18-7/8"	S7LF/42480HW1	<input type="checkbox"/>	<input type="checkbox"/>	<input type="checkbox"/>	<input type="checkbox"/>	170.0#
 <p>S7CBO</p>	56-3/32" Storage Cabinet with Wood Doors • Two adjustable shelves • Veneer door with center pulls • Includes all necessary installation hardware	30 x 18-7/8"	S7LF/30525HW1	<input type="checkbox"/>	<input type="checkbox"/>	<input type="checkbox"/>	<input type="checkbox"/>	160.0#
		36 x 18-7/8"	S7LF/36525HW1	<input type="checkbox"/>	<input type="checkbox"/>	<input type="checkbox"/>	<input type="checkbox"/>	170.0#
		42 x 18-7/8"	S7LF/42525HW1	<input type="checkbox"/>	<input type="checkbox"/>	<input type="checkbox"/>	<input type="checkbox"/>	190.0#

A **B** **C** **D** **E**

HOW TO ORDER

Indicate the following information on order form:

- Quantity of each item.
- Model number, including options. See "How To Build a Model Number".
- Any special service required.

Note: • The indicates that a choice is required.

- The absence of the indicates that no choice is required.
- Alpha-numeric characters in place of indicate that no other alternatives are available.

HOW TO BUILD A MODEL NUMBER

- A** Select basic model.
- B** Select unit color.
Refer to color addendum at ki.com or KI Fabrics & Finishes binder.
- C** Select veneer color.
Refer to color addendum at ki.com or KI Fabrics & Finishes binder.
- D** Select pull color optional front.
Refer to color addendum at ki.com or KI Fabrics & Finishes binder.
- E** Select key option.

KA	- Key alike
KS	- Key standard
NLC	- No lock core

INFORMATION

Height
All dimensions shown include 1/8" allowance for glides in recessed position.

Accessories
See accessory section for accessories that can be ordered separately.

Weights
Figures provided are approximate and reflect packaged product without additional accessories.



Preconfigured Storage

700 Series® OF Flush Top Veneer Fronts

Delivered Pricing

\$ 1195
1281
1380

\$ 1501
1694
1809

\$ 1824
2023
1707

\$ 2056
2258
2426

SPECIAL SERVICES

Special Carton Marking

With specially marked information N/C

Shipping

Shipped **assembled freight prepaid f.o.b. Pembroke, Ontario K8A 0E1** factory.
Freight class #70.

Specifications and prices are subject to change without prior notice.

Preconfigured Storage

700 Series® OF Extended Top Laminate Fronts

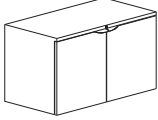
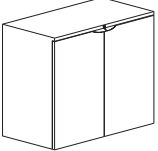
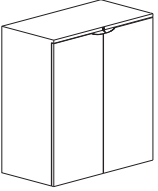
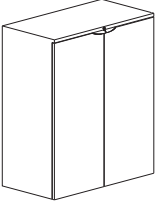
MODEL	W x D	MODEL NUMBER					Approx. Packaged Weight
		Basic Model	Unit Color	Front Surface Finish	Pull Color Optional Front	Key Option	
 <p>27" Storage Cabinet with Laminate Doors</p> <ul style="list-style-type: none"> • One adjustable shelf • Laminate door with center pulls • Self edge on all sides • Includes all necessary installation hardware 	30 x 18-7/8"	S7LE/30240HL1	<input type="checkbox"/>	<input type="checkbox"/>	<input type="checkbox"/>	<input type="checkbox"/>	95.0#
	36 x 18-7/8"	S7LE/36240HL1	<input type="checkbox"/>	<input type="checkbox"/>	<input type="checkbox"/>	<input type="checkbox"/>	105.0#
	42 x 18-7/8"	S7LE/42240HL1	<input type="checkbox"/>	<input type="checkbox"/>	<input type="checkbox"/>	<input type="checkbox"/>	121.0#
S7CBO							
 <p>39-1/4" Storage Cabinet with Laminate Doors</p> <ul style="list-style-type: none"> • One adjustable shelf • Laminate door with center pulls • Self edge on all sides • Includes all necessary installation hardware 	30 x 18-7/8"	S7LE/30360HL1	<input type="checkbox"/>	<input type="checkbox"/>	<input type="checkbox"/>	<input type="checkbox"/>	121.0#
	36 x 18-7/8"	S7LE/36360HL1	<input type="checkbox"/>	<input type="checkbox"/>	<input type="checkbox"/>	<input type="checkbox"/>	137.0#
	42 x 18-7/8"	S7LE/42360HL1	<input type="checkbox"/>	<input type="checkbox"/>	<input type="checkbox"/>	<input type="checkbox"/>	152.0#
S7CBO							
 <p>51-1/2" Storage Cabinet with Laminate Doors</p> <ul style="list-style-type: none"> • Two adjustable shelves • Laminate door with center pulls • Self edge on all sides • Includes all necessary installation hardware 	30 x 18-7/8"	S7LE/30480HL1	<input type="checkbox"/>	<input type="checkbox"/>	<input type="checkbox"/>	<input type="checkbox"/>	150.0#
	36 x 18-7/8"	S7LE/36480HL1	<input type="checkbox"/>	<input type="checkbox"/>	<input type="checkbox"/>	<input type="checkbox"/>	160.0#
	42 x 18-7/8"	S7LE/42480HL1	<input type="checkbox"/>	<input type="checkbox"/>	<input type="checkbox"/>	<input type="checkbox"/>	170.0#
S7CBO							
 <p>56-3/32" Storage Cabinet with Laminate Doors</p> <ul style="list-style-type: none"> • Two adjustable shelves • Laminate door with center pulls • Self edge on all sides • Includes all necessary installation hardware 	30 x 18-7/8"	S7LE/30525HL1	<input type="checkbox"/>	<input type="checkbox"/>	<input type="checkbox"/>	<input type="checkbox"/>	160.0#
	36 x 18-7/8"	S7LE/36525HL1	<input type="checkbox"/>	<input type="checkbox"/>	<input type="checkbox"/>	<input type="checkbox"/>	170.0#
	42 x 18-7/8"	S7LE/42525HL1	<input type="checkbox"/>	<input type="checkbox"/>	<input type="checkbox"/>	<input type="checkbox"/>	190.0#
S7CBO							
			A	B	C	D	E

HOW TO ORDER

Indicate the following information on order form:

1. Quantity of each item.
2. Model number, including options. See "How To Build a Model Number".
3. Any special service required.

Note: • The indicates that a choice is required.

- The absence of the indicates that no choice is required.
- Alpha-numeric characters in place of indicate that no other alternatives are available.

HOW TO BUILD A MODEL NUMBER

- A** Select basic model.
- B** Select unit color.
Refer to color addendum at ki.com or KI Fabrics & Finishes binder.
- C** Select front surface finish.
Refer to color addendum at ki.com or KI Fabrics & Finishes binder.
- D** Select pull color optional front.
Refer to color addendum at ki.com or KI Fabrics & Finishes binder.
- E** Select key option.

KA	- Key alike
KS	- Key standard
NLC	- No lock core

INFORMATION

Height

All dimensions shown include 1/8" allowance for glides in recessed position.

Accessories

See accessory section for accessories that can be ordered separately.

Weights

Figures provided are approximate and reflect packaged product without additional accessories.



Preconfigured Storage

700 Series® OF Extended Top Laminate Fronts

Delivered Pricing

\$ 949
974
1054

\$ 1213
1272
1344

\$ 1543
1623
1707

\$ 1766
1838
1980

SPECIAL SERVICES

Special Carton Marking

With specially marked information N/C



Shipping

Shipped **assembled freight prepaid f.o.b. Pembroke, Ontario K8A 0E1** factory. Freight class #70.

Specifications and prices are subject to change without prior notice.

Preconfigured Storage

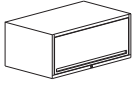
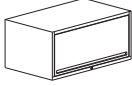
700 Series® Overfile Cabinets

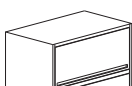
	MODEL	W x D x H	MODEL NUMBER				Approx. Packaged Weight
			Basic Model	Pull Option	Unit Color	Key Option	
 S70V	16-5/32" Overfile Storage Cabinet • One 13" receding door • For placement on the top of similar width cabinet; not for floor installation • Lock located at bottom of cabinet • Lower units must be drilled to accept four 1/4-20 bolts to secure unit	30 x 18 x 16-5/32"	S7L/301350V1F	<input type="checkbox"/> <input type="checkbox"/> <input type="checkbox"/> <input type="checkbox"/>	<input type="checkbox"/>	<input type="checkbox"/> <input type="checkbox"/> <input type="checkbox"/>	46.0#
		36 x 18 x 16-5/32"	S7L/361350V1F	<input type="checkbox"/> <input type="checkbox"/> <input type="checkbox"/> <input type="checkbox"/>	<input type="checkbox"/>	<input type="checkbox"/> <input type="checkbox"/> <input type="checkbox"/>	52.0#
		42 x 18 x 16-5/32"	S7L/421350V1F	<input type="checkbox"/> <input type="checkbox"/> <input type="checkbox"/> <input type="checkbox"/>	<input type="checkbox"/>	<input type="checkbox"/> <input type="checkbox"/> <input type="checkbox"/>	56.0#
 S70V	17-11/16" Overfile Storage Cabinet • One 15" receding door • For placement on the top of similar width cabinet; not for floor installation • Lock located at bottom of cabinet • Lower units must be drilled to accept four 1/4-20 bolts to secure unit	30 x 18 x 17-11/16"	S7L/301500V1F	<input type="checkbox"/> <input type="checkbox"/> <input type="checkbox"/> <input type="checkbox"/>	<input type="checkbox"/>	<input type="checkbox"/> <input type="checkbox"/> <input type="checkbox"/>	50.0#
		36 x 18 x 17-11/16"	S7L/361500V1F	<input type="checkbox"/> <input type="checkbox"/> <input type="checkbox"/> <input type="checkbox"/>	<input type="checkbox"/>	<input type="checkbox"/> <input type="checkbox"/> <input type="checkbox"/>	56.0#
		42 x 18 x 17-11/16"	S7L/421500V1F	<input type="checkbox"/> <input type="checkbox"/> <input type="checkbox"/> <input type="checkbox"/>	<input type="checkbox"/>	<input type="checkbox"/> <input type="checkbox"/> <input type="checkbox"/>	62.0#
 S70V	31-15/32" Overfile Storage Cabinet • Two 13-1/2" receding doors • One slotted tie bar shelf with 3 dividers • For placement on the top of similar width cabinet; not for floor installation • Lock located at bottom of cabinet • Lower units must be drilled to accept four 1/4-20 bolts to secure unit	30 x 18 x 31-15/32"	S7L/302850V2F	<input type="checkbox"/> <input type="checkbox"/> <input type="checkbox"/> <input type="checkbox"/>	<input type="checkbox"/>	<input type="checkbox"/> <input type="checkbox"/> <input type="checkbox"/>	87.0#
		36 x 18 x 31-15/32"	S7L/362850V2F	<input type="checkbox"/> <input type="checkbox"/> <input type="checkbox"/> <input type="checkbox"/>	<input type="checkbox"/>	<input type="checkbox"/> <input type="checkbox"/> <input type="checkbox"/>	98.0#
		42 x 18 x 31-15/32"	S7L/422850V2F	<input type="checkbox"/> <input type="checkbox"/> <input type="checkbox"/> <input type="checkbox"/>	<input type="checkbox"/>	<input type="checkbox"/> <input type="checkbox"/> <input type="checkbox"/>	108.0#
 S70V	34-17/32" Overfile Storage Cabinet • Two 15" receding doors • One slotted tie bar shelf with 3 dividers • For placement on the top of similar width cabinet; not for floor installation • Lock located at bottom of cabinet • Lower units must be drilled to accept four 1/4-20 bolts to secure unit	30 x 18 x 34-17/32"	S7L/303150V2F	<input type="checkbox"/> <input type="checkbox"/> <input type="checkbox"/> <input type="checkbox"/>	<input type="checkbox"/>	<input type="checkbox"/> <input type="checkbox"/> <input type="checkbox"/>	94.0#
		36 x 18 x 34-17/32"	S7L/363150V2F	<input type="checkbox"/> <input type="checkbox"/> <input type="checkbox"/> <input type="checkbox"/>	<input type="checkbox"/>	<input type="checkbox"/> <input type="checkbox"/> <input type="checkbox"/>	107.0#
		42 x 18 x 34-17/32"	S7L/423150V2F	<input type="checkbox"/> <input type="checkbox"/> <input type="checkbox"/> <input type="checkbox"/>	<input type="checkbox"/>	<input type="checkbox"/> <input type="checkbox"/> <input type="checkbox"/>	119.0#

A **B** **C** **D**

HOW TO ORDER

Indicate the following information on order form:

- Quantity of each item.
- Model number, including options. See "How To Build a Model Number".
- Any special service required.

Note: • The indicates that a choice is required.

- The absence of the indicates that no choice is required.
- Alpha-numeric characters in place of indicate that no other alternatives are available.

HOW TO BUILD A MODEL NUMBER

- A** Select basic model.
- | | |
|-------------|------------------------|
| ALBT | - Aluminum Bow Tie |
| ALMT | - Aluminum Metric |
| ARCN | - Arc Nickel |
| CLSC | - Classic (inset pull) |
| NKBT | - Nickel Bow Tie |
| RETN | - Retro Nickel |
- C** Select unit color.
Refer to color addendum at ki.com or KI Fabrics & Finishes binder.
- D** Select key option.
- | | |
|------------|----------------|
| KA | - Key alike |
| KS | - Key standard |
| NLC | - No lock core |

INFORMATION

Accessories

See accessory section for accessories that can be ordered separately.

Weights

Figures provided are approximate and reflect packaged product without additional accessories.



Preconfigured Storage

700 Series® Overfile Cabinets

Delivered
Pricing

\$ 610

685

695

\$ 574

696

741

\$ 914

950

1034

\$ 1019

1059

1152

SPECIAL SERVICES

Special Carton Marking

With specially marked information N/C

Shipping

Shipped **assembled freight prepaid f.o.b. Pembroke, Ontario K8A 0E1** factory.
Freight class #70.

Specifications and prices are subject to change without prior notice.

Preconfigured Storage

700 Series® Overfile Cabinets

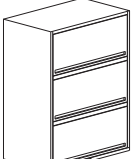
	MODEL	W x D x H	MODEL NUMBER				Approx. Packaged Weight
			Basic Model	Pull Option	Unit Color	Key Option	
 <p>S70V</p>	46-25/32" Overfile Storage Cabinet	30 x 18 x 46-25/32"	S7L/304350V3F	CLSC	<input type="checkbox"/> <input type="checkbox"/>	<input type="checkbox"/> <input type="checkbox"/> <input type="checkbox"/>	127.0#
	<ul style="list-style-type: none"> • Three 13-1/2" receding doors • One slotted tie bar shelf with 3 dividers • For placement on the top of similar width cabinet; not for floor installation • Lock located at bottom of cabinet • Lower units must be drilled to accept four 1/4-20 bolts to secure unit 	36 x 18 x 46-25/32"	S7L/364350V3F	CLSC	<input type="checkbox"/> <input type="checkbox"/>	<input type="checkbox"/> <input type="checkbox"/> <input type="checkbox"/>	144.0#
		42 x 18 x 46-25/32"	S7L/424350V3F	CLSC	<input type="checkbox"/> <input type="checkbox"/>	<input type="checkbox"/> <input type="checkbox"/> <input type="checkbox"/>	160.0#
 <p>S70V</p>	51-3/8" Overfile Storage Cabinet	30 x 18 x 51-3/8"	S7L/304800V3F	CLSC	<input type="checkbox"/> <input type="checkbox"/>	<input type="checkbox"/> <input type="checkbox"/> <input type="checkbox"/>	140.0#
	<ul style="list-style-type: none"> • Three 15" receding doors • Two slotted tie bar shelves with 3 dividers • For placement on the top of similar width cabinet; not for floor installation • Lock located at bottom of cabinet • Lower units must be drilled to accept four 1/4-20 bolts to secure unit 	36 x 18 x 51-3/8"	S7L/364800V3F	CLSC	<input type="checkbox"/> <input type="checkbox"/>	<input type="checkbox"/> <input type="checkbox"/> <input type="checkbox"/>	158.0#
		42 x 18 x 51-3/8"	S7L/424800V3F	CLSC	<input type="checkbox"/> <input type="checkbox"/>	<input type="checkbox"/> <input type="checkbox"/> <input type="checkbox"/>	177.0#

A **B** **C** **D**

HOW TO ORDER

Indicate the following information on order form:

1. Quantity of each item.
2. Model number, including options. See "How To Build a Model Number".
3. Any special service required.

Note: • The indicates that a choice is required.

- The absence of the indicates that no choice is required.
- Alpha-numeric characters in place of indicate that no other alternatives are available.

HOW TO BUILD A MODEL NUMBER

- A** Select basic model.
CLSC - Classic (inset pull)
- B** Select pull option.
- C** Select unit color.
Refer to color addendum at ki.com or KI Fabrics & Finishes binder.
- D** Select key option.
KA - Key alike
KS - Key standard
NLC - No lock core

INFORMATION

Accessories

See accessory section for accessories that can be ordered separately.

Weights

Figures provided are approximate and reflect packaged product without additional accessories.



Preconfigured Storage

700 Series® Overfile Cabinets

Delivered
Pricing

\$ 1211

1261

1359

\$ 1363

1411

1509

SPECIAL SERVICES

Special Carton Marking





With specially marked information N/C

Shipping

Shipped **assembled freight prepaid f.o.b.**
Pembroke, Ontario K8A 0E1 factory.
Freight class #70.

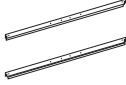
Specifications and prices are subject to
change without prior notice.

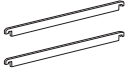
Lateral File Accessories

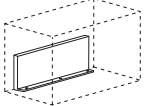
				MODEL NUMBER	
MODEL	Features	W	Basic Model	Approx. Packaged Weight	
 LTACU	Type "A" Folder Bars <ul style="list-style-type: none"> Files one row legal or letter, side-to-side Priced per set Installs in 10-1/2, 12, 13-1/2, and 15" drawers and similar sized receding door rollout shelf combinations Black finish only 	Side-to-side 30"	S7L/30FBA	3.0#	
		Side-to-side 36"	S7L/36FBA	3.0#	
		Side-to-side 42"	S7L/42FBA	4.0#	
 LTACU	Type "E" Folder Bars <ul style="list-style-type: none"> EDP interior for print-outs Files one row side-to-side Installs in 13-1/2, and 15" drawers and 15" receding door rollout shelf combinations. Not for installation behind 13-1/2" receding doors Priced per unit Black finish only 	Side-to-side 30"	S7L/30FBE	5.0#	
		Side-to-side 36"	S7L/36FBE	5.0#	
		Side-to-side 42"	S7L/42FBE	7.0#	
 LTACU	Type "K" Folder Bars <ul style="list-style-type: none"> Converts side-to-side filing to front-to-back filing One set (two bars) required per row of filing Priced per set of two Legal or letter 	Front-to-back	S7L/334FBK	5.0#	
 LTACU	Type "J" Folder Bars <ul style="list-style-type: none"> For EDP filing front-to-back One set (two bars) required per row of filing Priced per set of two 	Front-to-back	S7L/334FBJ	5.0#	
 LTACU	Counterbalance <ul style="list-style-type: none"> For lateral file units Recommended unless cabinets are ganged Factory installed, if specified 		S7L/CBW35	35.0#	
			S7L/CBW50	50.0#	
			S7L/CBW60	60.0#	

A

HOW TO ORDER

Indicate the following information on order form:

- Quantity of each item.
- Model number, including options. See "How To Build a Model Number".
- Any special service required.

Note: • The indicates that a choice is required.

- The absence of the indicates that no choice is required.
- Alpha-numeric characters in place of indicate that no other alternatives are available.

HOW TO BUILD A MODEL NUMBER

A Select basic model.

Counterbalance Weight

Model #	700 Series Lateral File
CBW35	30" Wide 4, 5, 6 High
CBW35	36" Wide 4, 5, 6 High
CBW35	42" Wide 4, 5, 6 High
CBW50	30" Wide 2, 3 High
CBW50	36" Wide 2, 3 High
CBW50	42" Wide 2, 3 High

Model #	700 Series Optional Front Lateral File
CBW50	30" Wide 4, 5, 6 High
CBW50	36" Wide 4, 5, 6 High
CBW60	30" Wide 2, 3 High
CBW60	36" Wide 2, 3 High
CBW60	42" Wide 2, 3 High



Lateral File Accessories

Delivered
Pricing

\$ 34
34
34

\$ 76
76
76

\$ 15

\$ 23

\$ 125
161
201

SPECIAL SERVICES

Special Carton Marking







With specially marked information N/C

Shipping

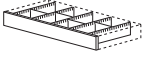
Shipped **assembled freight prepaid f.o.b. Pembroke, Ontario K8A 0E1** factory. Freight class #70.

Specifications and prices are subject to change without prior notice.

Lateral File Accessories

			MODEL NUMBER	
	MODEL	W x D x H	Basic Model	Approx. Packaged Weight
 LTACU	Drawer Organizer • For installation in 6", 7-1/2", 9" or box lateral file drawers • Black finish only	30 x 15-7/8 x 4"	S7L/30MEDKIT	8.0#
		36 x 15-7/8 x 4"	S7L/36MEDKIT	8.0#
		42 x 15-7/8 x 4"	S7L/42MEDKIT	9.0#
 LTACU	Organizer Front Pan • Attaches to sides of 6", 7-1/2", 9" or box drawer body • Field installation on product manufactured prior to January 1995 will require drilling 4 holes in the drawer • Black finish only	30 x 1 x 4"	S7L/30MEDPAN	2.0#
		36 x 1 x 4"	S7L/36MEDPAN	2.0#
		42 x 1 x 4"	S7L/42MEDPAN	2.0#
 LTACU	Organizer Partition • Front-to-back partition must be used with organizer front pan • Priced individually • Black finish only	1/2 x 16 x 4"	S7L/334MPART	1.0#
 LTACU	Organizer Divider • Side-to-side divider • Models listed provide 4", 5", 6" or 8" clear width • Black finish only	4 x 4"	S7L/334DIV40	1.0#
		5 x 4"	S7L/334DIV50	1.0#
		6 x 4"	S7L/334DIV60	1.0#
		8 x 4"	S7L/334DIV80	1.0#
 LTACU	6" Dividers • For 6" rollout shelves and 6", 7-1/2", and 9" drawers • Sold in packs of 3 • Black finish only	6"	S7L/3346DV	3.0#
 LTACU	Plate Dividers • For 10-1/2", 12", 13-1/2", and 15" rollout shelves and drawers • Sold in packs of 3 • Black finish only	12"	S7L/33412DV	3.0#

A

HOW TO ORDER

Indicate the following information on order form:

- Quantity of each item.
- Model number, including options. See "How To Build a Model Number".
- Any special service required.

Note: • The indicates that a choice is required.

- The absence of the indicates that no choice is required.
- Alpha-numeric characters in place of indicate that no other alternatives are available.

HOW TO BUILD A MODEL NUMBER

- A** Select basic model.



Lateral File Accessories

Delivered Pricing

\$ 156
192
192

\$ 58
58
68

\$ 16

\$ 9
9
9
9

\$ 42

\$ 35

SPECIAL SERVICES

Special Carton Marking





With specially marked information N/C

Shipping

Shipped **assembled freight prepaid f.o.b. Pembroke, Ontario K8A 0E1** factory. Freight class #70.

Specifications and prices are subject to change without prior notice.

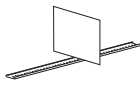
Lateral File Accessories

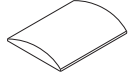
	MODEL	Features	W x D	MODEL NUMBER		Approx. Packaged Weight
				Basic Model	Unit Color	
 LTACU	Legal/Letter Conversion <ul style="list-style-type: none"> Black finish only To be used when filing letter-size folders side-to-side 			S7L/30LL		3.0#
				S7L/36LL		3.0#
				S7L/42LL		3.0#
 LTACU	EDP Legal/Letter Conversion <ul style="list-style-type: none"> Black finish only To be used when filing letter-size folders side-to-side 			S7L/30LLETS		3.0#
				S7L/36LLETS		3.0#
				S7L/42LLETS		3.0#
 LTACU	Compressor Follower <ul style="list-style-type: none"> Installs in 12, 13-1/2, and 15" drawers and receding door/rollout shelf combinations All installation hardware included Black finish only Compressor moves side-to-side 		27 x 8"	S7L/30CF		3.0#
			33 x 8"	S7L/36CF		4.0#
			39 x 8"	S7L/42CF		4.0#
 LTACU	Touch-up Paint <ul style="list-style-type: none"> Specify color code One-ounce brush application 			S7L/97003	<input type="checkbox"/>	2.0#
 LTACU	Coat Rod <ul style="list-style-type: none"> Includes mounting hardware For installation behind hinged doors Fixed blank shelf may be installed directly above. Specify separately 		30"	S7L/30CR		8.0#
			36"	S7L/36CR		8.0#
			42"	S7L/42CR		8.0#
HRDPT	P-Series Keys <ul style="list-style-type: none"> Extractor key used for core removal 	Lock/Core Set		2.KP20522		0.4#
				2.KP20550		0.2#
				2.KP20551		0.2#
				2.KP20552		0.2#
				2.KP20557		0.2#
 LTACU	700 Series® Files Lateral Toppers <ul style="list-style-type: none"> Fixed to the top with double stick tape For aesthetic appeal 		30 x 18"	S7L/30DT	<input type="checkbox"/>	9.0#
			36 x 18"	S7L/36DT	<input type="checkbox"/>	9.0#
			42 x 18"	S7L/42DT	<input type="checkbox"/>	9.0#

A

B

HOW TO ORDER

Indicate the following information on order form:

- Quantity of each item.
- Model number, including options. See "How To Build a Model Number".
- Any special service required.

Note: • The indicates that a choice is required.

- The absence of the indicates that no choice is required.
- Alpha-numeric characters in place of indicate that no other alternatives are available.

HOW TO BUILD A MODEL NUMBER

- A** Select basic model.
- B** Select unit color.
Refer to color addendum at ki.com or KI Fabrics & Finishes binder.



Lateral File Accessories

Delivered
Pricing

\$ 16
16
16

\$ 16
16
16

\$ 47
47
47

\$ 36

\$ 42
42
42

\$ 12
9
9
3
4

\$ 249
258
267

SPECIAL SERVICES

Special Carton Marking



With specially marked information N/C

Shipping

Shipped **assembled freight prepaid f.o.b. Pembroke, Ontario K8A 0E1** factory. Freight class #70.

Specifications and prices are subject to change without prior notice.

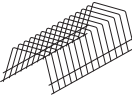
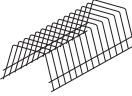
Computer Media Accessories

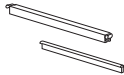
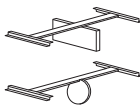
			MODEL NUMBER	
	MODEL	W x D x H	Basic Model	Approx. Packaged Weight
 LTACU	Reel Insert Shelf for Storage Cabinets/Doors <ul style="list-style-type: none"> Installs behind 12", 13-1/2" and 15" receding doors and hinged doors; check reel size 30" unit accepts 21 reels 36" unit accepts 26 reels 42" unit accepts 30 reels Black finish only 	30 x 10-1/2 x 7-1/2"	S7L/30RRC	9.0#
		36 x 10-1/2 x 7-1/2"	S7L/36RRC	10.0#
		42 x 10-1/2 x 7-1/2"	S7L/42RRC	11.0#
 LTACU	Reel Insert for Drawers <ul style="list-style-type: none"> Installs in 10-1/2", 12", 13-1/2", and 15" drawers; check reel size 30" unit accepts 20 reels 36" unit accepts 24 reels 42" unit accepts 29 reels Black finish only 	30 x 10-1/2 x 7-1/2"	S7L/30RRF	9.0#
		36 x 10-1/2 x 7-1/2"	S7L/36RRF	10.0#
		42 x 10-1/2 x 7-1/2"	S7L/42RRF	11.0#
 LTACU	Binder Frame for Computer Print-outs <ul style="list-style-type: none"> For use with binder hanger 334KIH (not included), see below Installs behind hinged door or 15" receding door Black finish only 	30 x 16-1/2 x 1-1/2"	S7L/30KIF	7.0#
		36 x 16-1/2 x 1-1/2"	S7L/36KIF	8.0#
		42 x 16-1/2 x 1-1/2"	S7L/42KIF	9.0#
 LTACU	Binder Hanger <ul style="list-style-type: none"> Hangs on binder frame KIF Metal channel with plastic T-bar Allow one for every 3" of filing width Channel is Dark Tone enamel finish Priced individually 		S7L/334KIH	1.0#
 LTACU	Binder Frame: WrightLine <ul style="list-style-type: none"> Installs behind hinged doors or 13-1/2" and 15" receding doors Accepts one for every 3" of filing width Black finish only 	30 x 16-1/2 x 1-1/2"	S7L/30WLD	7.0#
		36 x 16-1/2 x 1-1/2"	S7L/36WLD	8.0#
		42 x 16-1/2 x 1-1/2"	S7L/42WLD	9.0#

A

HOW TO ORDER

Indicate the following information on order form:

- Quantity of each item.
- Model number, including options. See "How To Build a Model Number".
- Any special service required.

Note: • The indicates that a choice is required.

- The absence of the indicates that no choice is required.
- Alpha-numeric characters in place of indicate that no other alternatives are available.

HOW TO BUILD A MODEL NUMBER

A Select basic model.



Delivered
Pricing

\$ 125

125

125

\$ 129

129

129

\$ 116

116

116

\$ 15

\$ 116

116

116

SPECIAL SERVICES

Special Carton Marking

With specially marked information N/C

Shipping

Shipped **assembled freight prepaid f.o.b.**
Pembroke, Ontario K8A 0E1 factory.
Freight class #70.

Specifications and prices are subject to
change without prior notice.

Computer Media Accessories

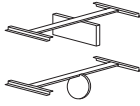
		MODEL NUMBER		
MODEL	W x D x H	Basic Model	Approx. Packaged Weight	
 <p>LTACU</p>				
	Binder Frame: Acco Data	30 x 16-1/2 x 1-1/2"	S7L/30ADF	7.0#
	<ul style="list-style-type: none"> • Installs behind hinged doors • Not recommended behind 15" receding door • Black finish only 	36 x 16-1/2 x 1-1/2"	S7L/36ADF	8.0#
	42 x 16-1/2 x 1-1/2"	S7L/42ADF	9.0#	

A

HOW TO ORDER

Indicate the following information on order form:

1. Quantity of each item.
2. Model number, including options. See "How To Build a Model Number".
3. Any special service required.

Note: • The indicates that a choice is required.

- The absence of the indicates that no choice is required.
- Alpha-numeric characters in place of indicate that no other alternatives are available.

HOW TO BUILD A MODEL NUMBER

A Select basic model.



Delivered
Pricing

\$ 116

116

116

SPECIAL SERVICES**Special Carton Marking**



With specially marked information N/C

Shipping

Shipped **assembled freight prepaid f.o.b.**
Pembroke, Ontario K8A 0E1 factory.
Freight class #70.

Specifications and prices are subject to
change without prior notice.

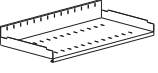
Cupboard Accessories

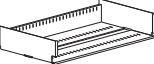
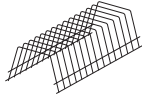
			MODEL NUMBER	
	MODEL	W x D x H	Basic Model	Approx. Packaged Weight
 LTACU	Adjustable Blank Shelf <ul style="list-style-type: none"> • May be installed behind hinged or receding doors • Black finish only • Included brackets 	30"	S7L/30BS	6.0#
		36"	S7L/36BS	7.0#
		42"	S7L/42BS	8.0#
 LTACU	Slotted Shelf <ul style="list-style-type: none"> • Accepts 33412DV dividers • May be installed behind 12", 13-1/2", or 15" receding doors or hinged cupboard doors • All internal accessories must be specified separately • Black finish only • Includes brackets 	30"	S7L/30SS	8.0#
		36"	S7L/36SS	10.0#
		42"	S7L/42SS	11.0#
 LTACU	Coat Rod <ul style="list-style-type: none"> • Includes mounting hardware • For installation behind hinged doors • Fixed blank shelf may be installed directly above. Specify separately 	30"	S7L/30CR	8.0#
		36"	S7L/36CR	8.0#
		42"	S7L/42CR	8.0#
 LTACU	Fixed End Tab Shelf <ul style="list-style-type: none"> • End tab shelf for cupboards only • Installs behind hinged doors • Accepts 33412DV dividers • All internal accessories must be specified separately • Black finish only 	30"	S7L/30ETSC	8.0#
		36"	S7L/36ETSC	10.0#
		42"	S7L/42ETSC	11.0#
 LTACU	Reel Insert <ul style="list-style-type: none"> • Installs behind hinged doors; check reel size • 30" unit accepts 20 reels • 36" unit accepts 24 reels • 42" unit accepts 29 reels • Black finish only 	30 x 10-1/2 x 7-1/2"	S7L/30RRC	9.0#
		36 x 10-1/2 x 7-1/2"	S7L/36RRC	10.0#
		42 x 10-1/2 x 7-1/2"	S7L/42RRC	11.0#

A

HOW TO ORDER

Indicate the following information on order form:

1. Quantity of each item.
2. Model number, including options. See "How To Build a Model Number".
3. Any special service required.

Note: • The indicates that a choice is required.

- The absence of the indicates that no choice is required.
- Alpha-numeric characters in place of indicate that no other alternatives are available.

HOW TO BUILD A MODEL NUMBER

- A** Select basic model.



Delivered
Pricing

\$ 83
83
83

\$ 116
116
116

\$ 42
42
42

\$ 116
131
148

\$ 125
125
125

SPECIAL SERVICES

Special Carton Marking





With specially marked information N/C

Shipping

Shipped **assembled freight prepaid f.o.b.**
Pembroke, Ontario K8A 0E1 factory.
Freight class #70.

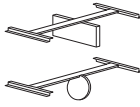
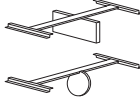
Specifications and prices are subject to
change without prior notice.

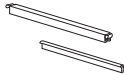
Cupboard Accessories

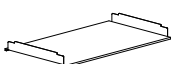
			MODEL NUMBER	
	MODEL	W x D x H	Basic Model	Approx. Packaged Weight
 LTACU	Binder Frame: Acco Data • Installs behind hinged doors • Not recommended behind 15" receding doors • Black finish only	30 x 16-1/2 x 1-1/2"	S7L/30ADF	7.0#
		36 x 16-1/2 x 1-1/2"	S7L/36ADF	8.0#
		42 x 16-1/2 x 1-1/2"	S7L/42ADF	9.0#
 LTACU	Binder Frame: Wrightline • Installs behind hinged doors or 13-1/2" and 15" receding doors • Accepts center hanging channel (not included) • Black finish only	30 x 16-1/2 x 1-1/2"	S7L/30WLD	7.0#
		36 x 16-1/2 x 1-1/2"	S7L/36WLD	8.0#
		42 x 16-1/2 x 1-1/2"	S7L/42WLD	9.0#
 LTACU	Binder Frame for Computer Print-outs • For use with binder hanger 334KIH (not included), see below • Installs behind hinged door or 15" receding door • Black finish only	30 x 16-1/2 x 1-1/2"	S7L/30KIF	7.0#
		36 x 16-1/2 x 1-1/2"	S7L/36KIF	8.0#
		42 x 16-1/2 x 1-1/2"	S7L/42KIF	9.0#
 LTACU	Binder Hanger • Hangs on binder frame KIF • Metal channel with plastic T-bar • Allow one for every 3" of filing width • Channel is Dark Tone enamel finish • Priced individually		S7L/334KIH	1.0#
 LTACU	12" Plate Divider (3 Pack) • For slotted shelves, 10-1/2" and 12" drawers • Sold in packs of 3 • Black finish only	12"	S7L/33412DV	3.0#
 LTACU	Thin Blank Shelf (Screw Mount) • May be installed behind hinged or receding doors • Black finish only	30"	S7L/30TBS	6.0#
		36"	S7L/36TBS	7.0#
		42"	S7L/42TBS	8.0#

A

HOW TO ORDER

Indicate the following information on order form:

- Quantity of each item.
- Model number, including options. See "How To Build a Model Number".
- Any special service required.

Note: • The indicates that a choice is required.

- The absence of the indicates that no choice is required.
- Alpha-numeric characters in place of indicate that no other alternatives are available.

HOW TO BUILD A MODEL NUMBER

- A** Select basic model.



Delivered
Pricing

\$ 116

116

116

\$ 116

116

116

\$ 116

116

116

\$ 15

\$ 35

\$ 133

142

151

SPECIAL SERVICES

Special Carton Marking

With specially marked information N/C

Shipping

Shipped **assembled freight prepaid f.o.b. Pembroke, Ontario K8A 0E1** factory.
Freight class #70.

Specifications and prices are subject to change without prior notice.

700 Series® Custom-Built Lateral Files

General Information

GENERAL INFORMATION

To meet specific filing requirements, 700 Series lateral file and storage cabinet units can be created from an unparalleled selection of cabinet sizes and specialized interior options. The section includes shells and corresponding drawers, receding doors, storage cabinets and legal/letter and EDP interiors.

Cabinet shells are available in three widths and 40 standard heights. Shells are notched in 1/2" increments to accept a wide variety of interior options. Interior options range from 3", 6", 7 1/2", 9" and 10 1/2" drawers through 12", 13 1/2" and 15" drawers and receding doors. Cupboards are also available in numerous heights. Various shelves and computer media storage accessories may be specified behind storage cabinet doors and receding doors.

Height

Lateral files and storage cabinets are available in 40 standard heights. Heights include 1/8" allowance for leveling glides fully recessed.

Depth

All lateral files and storage cabinets are 18" deep.

Width

Lateral files and storage cabinets are available in three standard widths: 30", 36" and 42".

Drawer Dimensions

Refer to the illustrations for the range of drawer sizes and the height clearance of each.

CONSTRUCTION AND STANDARD FEATURES

Basic Shell

Shell common to lateral file and storage cabinet

units. Uprights punched to accept interior components on 1 1/2" centers. Uprights and top and bottom reinforcements are welded into rigid "boxframe." Constructed of 18- and 20-gauge steel. Seamless back and top with reinforced corners.

Illustrated shell heights include 1/8" for adjustable glide in recessed position.

Doors/Drawers

Drawer fronts, 20-gauge steel with full-width flush inset pull and label holder. Fronts are screw-mounted to roll-out shelves to build drawers. Roll-out shelf body, 22-gauge steel slotted on 1 1/2" centers to accept dividers. Leading edge formed to provide handle; center section offset for additional strength. Shelf ends, 19-gauge steel, notched to accept hanging folder bars. Each roll-out shelf equipped with two heavy-duty, three-section, ball-bearing suspensions.

Note: Drawers have been tested to accept loads of 125 lbs. This exceeds ANSI/BIFMA X5.9-2004

standards for lateral files when recommended counterbalance weight is installed. Hinged door, 20-gauge steel, double-wall construction. Door swing is limited to 110° to prevent contact with adjacent cabinet, and self-closing hinges and full height vertical flush inset pull.

Shelves

Blank shelf, 22-gauge steel, formed 7/8" thick on front and back edges. End Tab Shelf, 20-gauge steel shelf and back, 18-gauge sides. Shelf offset along width to increase strength. Slotted on 1" increments to accept plate dividers.

Lateral files meet or exceed ANSI/BIFMA X5.4-2009 standards.

Receding Door

20-gauge steel with full-width flush inset pull and label holder. Equipped with sound absorber. Doors have guiding mechanism fitted with nylon glides to prevent metal-to-metal contact and ensure effortless operation. The diagrams on the following page identify various shelf and drawer combinations & related height clearances behind a receding door. The diagrams illustrate typical use. Additional interior options can be installed behind a receding door. **Note:** Dimensions have been taken from the front raised edge of the rollout shelf.

Note: Receding doors cannot be installed directly below a drawer.

Accessories

Plate dividers, 18-gauge steel, notched to lock into shelf. Folder bars, 30" & 36" (14-gauge steel); 42" (12-gauge steel), offset to maximize strength. Suspended binder frames are constructed of 14- to 18-gauge steel. Screw-mounted to cabinet. Can be used behind 13 1/2" and 15" receding doors and hinged storage cabinet doors.

Adjustable Glides

Lateral files and storage cabinets are supplied with four adjustable glides. The glides can be adjusted from inside the cabinet using a 1/4" hex socket wrench, or from outside the cabinet using a 7/8" wrench. Standard glides provide 3/4" adjustment; longer glides are also available. Overall cabinet heights include the glide in its recessed position.

Interlock

All cabinets are equipped with an interlock safety mechanism. This mechanism reduces the possibility of cabinet tipover by permitting only one drawer to be opened at a time. With some unique combinations an individual drawer may not be controlled by the interlock. In these instances a caution label will be affixed to the drawer body.

Locks

Locks are standard on all units. The lock is a high-security double-bit type. The double-bit lock offers superior security when compared to a single-bit lock. Units are standard with random keys in a range of 994 different numbers. Specific keying combinations are available at no additional charge. This information must be included with the order. Locks can be master keyed. Please see the accessories section of this price book for order information on master keys, extractor (core-removal) keys, key blanks, cut keys, and core and key sets.

All locks have removable and interchangeable plugs. This feature provides for onsite custom keying. Units can be supplied with the lock plugs installed or shipped separately. To install or remove lock plugs a unique key is required. This key is the extractor (core removal) key and can be found in the accessories section of this price book. Contact Customer Service to order lock accessories. To order plugs for field installation, specify "lock plugs not installed" on order. Order must specify total quantity of specific key-numbered locks.

Example: 30 plugs:
3 keyed alike
10 keyed alike
17 keyed alike

Commercial Pack

This is the standard pack that KI offers on all files and storage products. This consists of a plastic poly bag placed over the unit, corrugated top and bottom cap, corner blocking and stretch wrap to keep the packaging intact.

Standard Paint Finishes

All KI products are iron phosphate treated prior to painting. This process enhances top coat bonding.

Powder coat application is a jighbred epoxy. The paint is baked on to provide a scratch and stain resistant surface.

All inside and outside shell and front surfaces are painted with the same specified paint color. Interior components and accessories are painted a black finish. Mechanical components are black plated. Powder coated/enamel finish colors shown in Color Addendums are standard and are available where specifications call for painted surfaces

Special Paint Finishes

All special colors, including other manufacturers' standard finishes, are available subject to the following conditions.

- Two steel color chips (minimum 2.5" x 3.5") are requested for color matching purposes. Paper samples are acceptable, however, a reasonable tolerance must be allowed when comparing the two variations.
- All nonstandard colors are available at no additional charge (excluding hi-chromatic colors), but may be subject to extended lead times. Order will not be processed until color match is approved. Written confirmation must accompany order.

Nonstock Plastic Laminate Surfaces

Additional laminates are available but may be subject to additional lead time. Other special laminates require an upcharge and additional lead time. Contact KI.

Model Numbering System

Each character in the basic model number corresponds to a specific unit feature.

How to Build a Model Number

Example: 700 Series Custom Built Lateral Files

S7L	36	555	BL	Insert drawer options here	CBW50	Optional Picks	33412DV
-----	----	-----	----	----------------------------	-------	----------------	---------

S7L	Product name	700 Series Shell				
36	Width	36" wide				
555	Interior height (nominal)	55 1/2" high				
BL	Color code	Custom Built Black				
CBW50	Optional	50# Counterbalance weight				
33412DV	Optional	12" Front-to-back filing bars				

Each internal component has a corresponding character:

D	Drawer with no interiors
DA	Drawer with FBA folder bars
DE	Drawer with FBE folder bars
R	Receding door
RS	Receding door, rollout shelf
RSA	Receding door, rollout shelf with FBA folder bars
RSE	Receding door, rollout shelf with FBE folder bars
RED	Receding door, end tab shelf with dividers
S	Rollout shelf
BS	Blank shelf
ES	End tab shelf
SS	Slotted shelf
CR	Coat rod

Models are built from the TOP TO THE BOTTOM.

The 334 model number for accessories indicates the item may be used in all cabinet widths.

NOTE: The unit must SPECIFY optional CBW and accessories as INSTALLED or they will be shipped separately.



700 Series[®] Custom-Built Lateral Files

General Information

Inside Drawer and Shelf Dimensions*	30W x 18D Cabinet		36W x 18D Cabinet		42W x 18D Cabinet	
	W	D	W	D	W	D
3" Drawer	26 ¹ / ₈ "	15 ¹ / ₂ "	32 ¹ / ₈ "	15 ¹ / ₂ "	38 ¹ / ₈ "	15 ¹ / ₂ "
6" Drawer	26 ³ / ₄ "	15 ⁷ / ₈ "	32 ³ / ₄ "	15 ⁷ / ₈ "	38 ³ / ₄ "	15 ⁷ / ₈ "
7 ¹ / ₂ " Drawer	26 ³ / ₄ "	15 ⁷ / ₈ "	32 ³ / ₄ "	15 ⁷ / ₈ "	38 ³ / ₄ "	15 ⁷ / ₈ "
9" Drawer	26 ³ / ₄ "	15 ⁷ / ₈ "	32 ³ / ₄ "	15 ⁷ / ₈ "	38 ³ / ₄ "	15 ⁷ / ₈ "
10 ¹ / ₂ " Drawer	26 ³ / ₄ "	15 ⁷ / ₈ "	32 ³ / ₄ "	15 ⁷ / ₈ "	38 ³ / ₄ "	15 ⁷ / ₈ "
12" Single Rollout Shelf	26 ³ / ₄ "	15 ⁷ / ₈ "	32 ³ / ₄ "	15 ⁷ / ₈ "	38 ³ / ₄ "	15 ⁷ / ₈ "
Blank Shelf	26 ³ / ₄ "	16 ³ / ₁₆ "	32 ³ / ₄ "	16 ³ / ₁₆ "	38 ³ / ₄ "	16 ³ / ₁₆ "
End Tab Filing Shelf	26 ³ / ₄ "	15 ³ / ₄ "	32 ³ / ₄ "	15 ³ / ₄ "	38 ³ / ₄ "	15 ³ / ₄ "
Slotted Shelf	26 ³ / ₄ "	15 ¹ / ₂ "	32 ³ / ₄ "	15 ¹ / ₂ "	38 ³ / ₄ "	15 ¹ / ₂ "
12" Drawer	26 ³ / ₄ "	15 ⁷ / ₈ "	32 ³ / ₄ "	15 ⁷ / ₈ "	38 ³ / ₄ "	15 ⁷ / ₈ "
13 ¹ / ₂ " Rollout Shelf	26 ³ / ₄ "	15 ⁷ / ₈ "	32 ³ / ₄ "	15 ⁷ / ₈ "	38 ³ / ₄ "	15 ⁷ / ₈ "
13 ¹ / ₂ " Drawer	26 ³ / ₄ "	15 ⁷ / ₈ "	32 ³ / ₄ "	15 ⁷ / ₈ "	38 ³ / ₄ "	15 ⁷ / ₈ "
15" Single Rollout Shelf	26 ³ / ₄ "	15 ⁷ / ₈ "	32 ³ / ₄ "	15 ⁷ / ₈ "	38 ³ / ₄ "	15 ⁷ / ₈ "
15" Drawer	26 ³ / ₄ "	15 ⁷ / ₈ "	32 ³ / ₄ "	15 ⁷ / ₈ "	38 ³ / ₄ "	15 ⁷ / ₈ "
Cupboard	28 ¹ / ₂ "	17"	34 ¹ / ₂ "	17"	40 ¹ / ₂ "	17"

*Dimensions have been taken from the front raised edge of rollout shelf. The inside clear dimension wide approximately 1/2" greater.

Hanging File Configurations		30W Cabinet	36W Cabinet	42W Cabinet
Letter	side-to-side	30FBA	36FBA	42FBA
	front-to-back	30FBA w(2)334FBK	36FBA w(2)334FBK	42FBA w(3)334FBK
Legal	side-to-side	30FBA	36FBA	42FBA
	front-to-back	w(1)334FBK	36FBA w(2)334FBK	42FBA w(2)334FBK
EDP	side-to-side	30FBE	36FBE	42FBE
	front-to-back	w(1)334FBJ	w(2)334FBJ	w(2)334FBJ

Inside Clear Dimensions of Shelf and Drawer Options

	6" Rollout Shelf Behind Receding Door	12" Rollout Shelf Behind Receding Door	Blank Shelf Behind Receding Door	End Tab Shelf Behind Receding Door	Tie Bar Shelf Below Receding Door	Drawer
3"						2 ⁹ / ₁₆ "
6"						5 ²³ / ₃₂ "
7 ¹ / ₂ "						7 ¹ / ₄ "
9"						8 ²⁵ / ₃₂ "
10 ¹ / ₂ "						10 ¹ / ₄ "
12"						11 ¹ / ₂ "
13 ¹ / ₂ "						13 ¹ / ₃₂ "
15"						14 ⁹ / ₁₆ "

700 Series® Custom-Built Lateral Files

General Information

TERMINOLOGY

BIFMA. "Business and Institutional Furniture Manufacturer's Association" set minimum standards by which contract furniture manufacturers measure the performance of their products.

Clear Filing Height. The available, unobstructed storage space in a drawer or on a shelf.

Counterbalance Weight. A weight affixed into the inside back of the file to minimize the possibility of the cabinet tipping over when a fully loaded drawer is opened.

"Double Bit" Lock. A lock plug with metal wafers or "bits" on opposing sides of the channel in which the key fits. The corresponding key has teeth on both sides of its blade. The double bit system provides greater security and a wider variety of keying options when compared to single bit locks.

End Tab Filing. Describes storage materials which have the identification tab at the short end of the file folder. The tab is seen from the side, not the top, of the folder.

Tie Bar. Used to complete the available filing height when no insert is required or where no insert is available to complete the remaining height. Required on 5 and 6-high cabinets. (Perpendicular to the width of the cabinet).

Folder Bars. The heavy gauge steel bars that fit into a drawer to suspend hanging folders and computer print-out binders. Available for side-to-side (across the width of the cabinet) and front-to-back filing.

Ganging. Describes the bolting together of cabinets when installed side by side. Enhances safety.

Glides. Adjustable large footed bolts that screw into the four bottom corners of all lateral files, cupboards, and pedestals; adjusts the level and height of a cabinet.

Interlock. A safety mechanism installed in all lateral files. Prevents opening more than one drawer at a time. Minimizes the possibility of the cabinet tipping over.

Lock Plug. The removable center portion of the lock. With a special key, lock plugs can be removed to allow for customer keying configurations after the lateral files or pedestals have been installed.

Posting Shelf. A horizontal extendible worksurface that can fit into a 1½" opening of a lateral file, in place of a tie bar.

Receding Door. Sometimes called a "flipper door"; the door opens by lifting it at the bottom and sliding it into the file on a horizontal plane.

Suspensions. Sometimes called "glides;" the ball bearing support mechanism on which a rollout shelf or drawer operates.

"X" High. (ie. 2 high, 3 high, etc.) The nominal height of a unity measured in 12-inch increments.

CUSTOM UNIT EXAMPLES

Requirement: 30-inch wide cabinet with binder storage in top two openings and legal file storage in bottom two openings. Maximum height, 57".

Unit Height	x	Qty	=	Insert Height	Description	Model No.	Price	x	Qty	=	Extended Price
56 ⁹ / ₃₂ "		1		52 ¹ / ₂ " max.	Shell, 5 high	S7L/30525	\$547		1		\$547
15"		2		30"	Receding door	S7L/30150R	134		2		268
		2			Blank shelf	S7L/30BS	83		2		166
10 ¹ / ₂ "		1		10 ¹ / ₂ "	Drawer w/folder bars	S7L/30105DA	242		1		242
12"		1		12"	Drawer w/folder bars	S7L/30120DA	242		1		242
Total insert height: 52 ¹ / ₂ "							Total Price:		\$1465		

Color code:

Requirement: 36-inch wide cabinet with miscellaneous stationery storage in top opening, letter file storage in middle opening, and 14 x 11" EDP file storage in bottom opening.

Unit Height	x	Qty	=	Insert Height	Description	Model No.	Price	x	Qty	=	Extended Price
33 ¹ / ₈ "		1		30" max.	Shell, 3 high	S7L/36300	\$489		1		\$489
6"		1		6"	Drawer	S7L/36060D	232		1		232
10 ¹ / ₂ "		1		10 ¹ / ₂ "	Drawer w/folder bars	S7L/36105DA	276		1		276
13 ¹ / ₂ "		1		13 ¹ / ₂ "	Drawer for EDP	S7L/36135DE	346		1		346
Total insert height: 30"							Total Price:		\$1343		

Color code:

Requirement: 42-inch wide cabinet with hanging WrightLine 14 x 11" EDP printout storage in top opening, multiple summary report storage in second opening, and EDP print-out storage in bottom two openings.

Unit Height	x	Qty	=	Insert Height	Description	Model No.	Price	x	Qty	=	Extended Price
65 ⁹ / ₃₂ "		1		60" max.	Shell, 5 high	S7L/42615	\$814		1		\$814
15"		2		30"	Receding door	S7L/42150R	167		2		334
		1			WrightLine	S7L/42WLD	116		1		116
		1			Blank shelf	S7L/42BS	83		1		83
15"		2		30"	Drawer for EDP	S7L/42150DE	402		2		804
Total insert height: 60"							Total Price:		\$2151		

Color code:

Note: Structural Filler Shelf

All 42" wide units taller than 65⁹/₃₂" require a 1½" structural tie bar shelf nominally located between 25½" and 36" from the top of the cabinet based on configuration.



700 Series® Custom-Built Lateral Files

General Information

HOW TO ORDER A CUSTOM UNIT

1. Specify the appropriate shell height and width.
2. Specify the required number of internal components from the TOP to the BOTTOM of the shell.
3. Be certain the dimensions of the components add up to match the available interior shell height.
4. A 1 1/2" tie bar/tie bar shelf is required on all shells 65 9/32" and over and must be specified. Optimally located between 12" from top and 24" from bottom of unit.
5. All units over 65 9/32" and 42" wide have a structural filler shelf located nominally 25 1/2" - 39" from the top of the cabinet.
6. Specify interior options directly below the component in which they are required.
7. Specify color code.

General Guidelines

- Use this worksheet when specifying components to help build a unit and ensure that all components are in the proper sequence.
- Specify the interior components from the top to the bottom of the cabinet.
- Be sure that the internal components add up to the interior space available in the basic shell.
- In units 65 9/32" and higher be sure to specify 1 1/2" tie bar/tie bar shelf following case specific rules.
- Locking tie bar may be substituted for tie bar in units without structural filler shelves.
- Counterbalance weights are recommended for all free standing units.

Note: Hinged cupboard door inserts include 1 1/2" tie bar shelf, additional tie bar not required.

Guidelines for Ordering Components

- Receding doors are recommended when the top of the component is above eye level or approximately 50" from the floor.
- The quantity of rollout components specified behind a receding door is limited only by the interior component height.
- Rollout components should not be specified in openings above eye level.
- In most instances, interior accessories are not included with components and must be specified separately.
- Locks are included in all units.

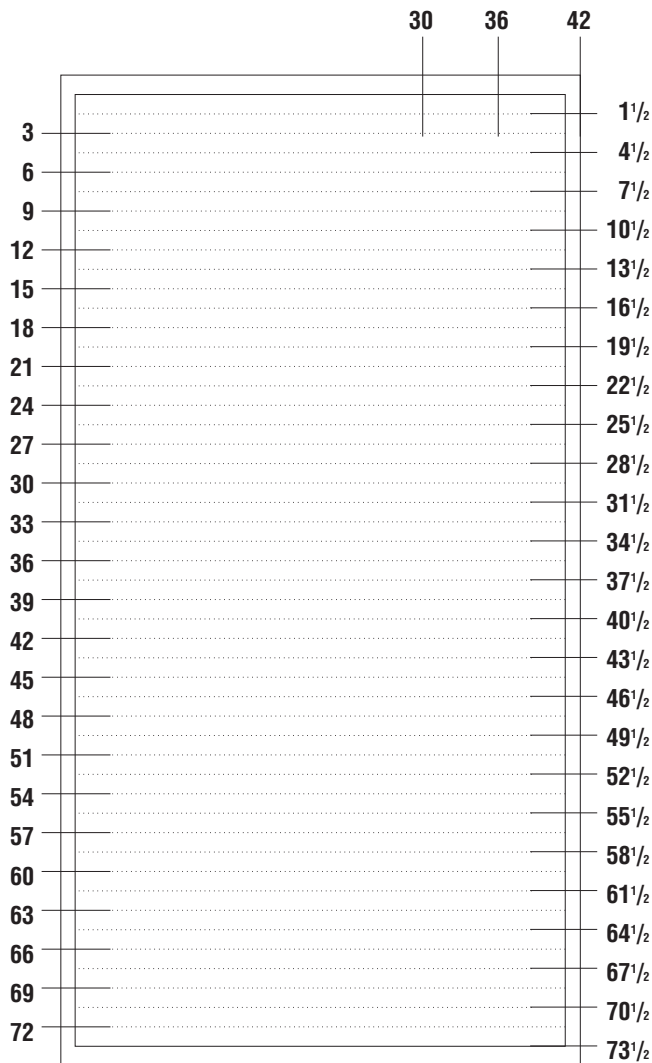

WORKSHEET

Unit Height	x	Qty	=	Insert Height	Description	Model No.	Price	x	Qty	=	Extended Price

Total insert height: _____ **Total Price:** _____ **\$**
Color code: _____

Custom-Built Lateral Files

700 Series® Shells

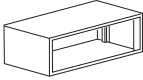
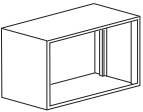
	MODEL	Accepts Inserts Totaling	W x D	MODEL NUMBER				Approx. Packaged Weight
				Basic Model	Unit Color	Optional Counterbalance Weight	Key Option	
	17-13/16" High Shell	15"	30 x 18"	S7L/30150	<input type="checkbox"/>	<input type="checkbox"/> <input type="checkbox"/> <input type="checkbox"/> <input type="checkbox"/> <input type="checkbox"/>	<input type="checkbox"/> <input type="checkbox"/> <input type="checkbox"/>	26.0#
		15"	36 x 18"	S7L/36150	<input type="checkbox"/>	<input type="checkbox"/> <input type="checkbox"/> <input type="checkbox"/> <input type="checkbox"/> <input type="checkbox"/>	<input type="checkbox"/> <input type="checkbox"/> <input type="checkbox"/>	32.0#
		15"	42 x 18"	S7L/42150	<input type="checkbox"/>	<input type="checkbox"/> <input type="checkbox"/> <input type="checkbox"/> <input type="checkbox"/> <input type="checkbox"/>	<input type="checkbox"/> <input type="checkbox"/> <input type="checkbox"/>	38.0#
	S7LCU							
S7LCU	19-11/32" High Shell	16-1/2"	30 x 18"	S7L/30165	<input type="checkbox"/>	<input type="checkbox"/> <input type="checkbox"/> <input type="checkbox"/> <input type="checkbox"/> <input type="checkbox"/>	<input type="checkbox"/> <input type="checkbox"/> <input type="checkbox"/>	28.0#
		16-1/2"	36 x 18"	S7L/36165	<input type="checkbox"/>	<input type="checkbox"/> <input type="checkbox"/> <input type="checkbox"/> <input type="checkbox"/> <input type="checkbox"/>	<input type="checkbox"/> <input type="checkbox"/> <input type="checkbox"/>	35.0#
		16-1/2"	42 x 18"	S7L/42165	<input type="checkbox"/>	<input type="checkbox"/> <input type="checkbox"/> <input type="checkbox"/> <input type="checkbox"/> <input type="checkbox"/>	<input type="checkbox"/> <input type="checkbox"/> <input type="checkbox"/>	41.0#
S7LCU	20-7/8" High Shell	18"	30 x 18"	S7L/30180	<input type="checkbox"/>	<input type="checkbox"/> <input type="checkbox"/> <input type="checkbox"/> <input type="checkbox"/> <input type="checkbox"/>	<input type="checkbox"/> <input type="checkbox"/> <input type="checkbox"/>	30.0#
		18"	36 x 18"	S7L/36180	<input type="checkbox"/>	<input type="checkbox"/> <input type="checkbox"/> <input type="checkbox"/> <input type="checkbox"/> <input type="checkbox"/>	<input type="checkbox"/> <input type="checkbox"/> <input type="checkbox"/>	39.0#
		18"	42 x 18"	S7L/42180	<input type="checkbox"/>	<input type="checkbox"/> <input type="checkbox"/> <input type="checkbox"/> <input type="checkbox"/> <input type="checkbox"/>	<input type="checkbox"/> <input type="checkbox"/> <input type="checkbox"/>	44.0#
S7LCU	22-13/32" High Shell	19-1/2"	30 x 18"	S7L/30195	<input type="checkbox"/>	<input type="checkbox"/> <input type="checkbox"/> <input type="checkbox"/> <input type="checkbox"/> <input type="checkbox"/>	<input type="checkbox"/> <input type="checkbox"/> <input type="checkbox"/>	33.0#
		19-1/2"	36 x 18"	S7L/36195	<input type="checkbox"/>	<input type="checkbox"/> <input type="checkbox"/> <input type="checkbox"/> <input type="checkbox"/> <input type="checkbox"/>	<input type="checkbox"/> <input type="checkbox"/> <input type="checkbox"/>	41.0#
		19-1/2"	42 x 18"	S7L/42195	<input type="checkbox"/>	<input type="checkbox"/> <input type="checkbox"/> <input type="checkbox"/> <input type="checkbox"/> <input type="checkbox"/>	<input type="checkbox"/> <input type="checkbox"/> <input type="checkbox"/>	48.0#
	23-15/16" High Shell	21"	30 x 18"	S7L/30210	<input type="checkbox"/>	<input type="checkbox"/> <input type="checkbox"/> <input type="checkbox"/> <input type="checkbox"/> <input type="checkbox"/>	<input type="checkbox"/> <input type="checkbox"/> <input type="checkbox"/>	37.0#
		21"	36 x 18"	S7L/36210	<input type="checkbox"/>	<input type="checkbox"/> <input type="checkbox"/> <input type="checkbox"/> <input type="checkbox"/> <input type="checkbox"/>	<input type="checkbox"/> <input type="checkbox"/> <input type="checkbox"/>	45.0#
		21"	42 x 18"	S7L/42210	<input type="checkbox"/>	<input type="checkbox"/> <input type="checkbox"/> <input type="checkbox"/> <input type="checkbox"/> <input type="checkbox"/>	<input type="checkbox"/> <input type="checkbox"/> <input type="checkbox"/>	51.0#
	S7LCU							
S7LCU	25-15/32" High Shell	22-1/2"	30 x 18"	S7L/30225	<input type="checkbox"/>	<input type="checkbox"/> <input type="checkbox"/> <input type="checkbox"/> <input type="checkbox"/> <input type="checkbox"/>	<input type="checkbox"/> <input type="checkbox"/> <input type="checkbox"/>	40.0#
		22-1/2"	36 x 18"	S7L/36225	<input type="checkbox"/>	<input type="checkbox"/> <input type="checkbox"/> <input type="checkbox"/> <input type="checkbox"/> <input type="checkbox"/>	<input type="checkbox"/> <input type="checkbox"/> <input type="checkbox"/>	48.0#
		22-1/2"	42 x 18"	S7L/42225	<input type="checkbox"/>	<input type="checkbox"/> <input type="checkbox"/> <input type="checkbox"/> <input type="checkbox"/> <input type="checkbox"/>	<input type="checkbox"/> <input type="checkbox"/> <input type="checkbox"/>	54.0#

A **B** **C** **D**

HOW TO ORDER

Indicate the following information on order form:

- Quantity of each item.
- Model number, including options. See "How To Build a Model Number".
- Any special service required.

Note:

- The indicates that a choice is required.
- The absence of the indicates that no choice is required.
- Alpha-numeric characters in place of indicate that no other alternatives are available.

HOW TO BUILD A MODEL NUMBER

- A** Select basic model.
- B** Select unit color.
Refer to color addendum at ki.com or KI Fabrics & Finishes binder.
- C** Select counterbalance weight.
CBW - With Counterbalance
NOCBW - No Counterbalance
See pricing column for counterbalance weight upcharge.
- D** Select key option.
KA - Key alike
KS - Key standard
NLC - No lock core

INFORMATION

Height

All dimensions shown include 1/8" allowance for glides in recessed position.

Weights

Figures provided are approximate and reflect packaged product without additional accessories.



Custom-Built Lateral Files

700 Series® Shells

Delivered Pricing	Counter-balance Weight add to list price
\$ 380	\$ 161
434	161
472	161
\$ 380	\$ 161
434	161
472	161
\$ 380	\$ 161
434	161
472	161
\$ 380	\$ 161
434	161
472	161
\$ 398	\$ 161
454	161
489	161
\$ 398	\$ 161
454	161
489	161

SPECIAL SERVICES

Special Carton Marking

With specially marked information N/C

Shipping

Shipped **assembled freight prepaid f.o.b. Pembroke, Ontario K8A 0E1** factory.
Freight class #70.

Specifications and prices are subject to change without prior notice.

Custom-Built Lateral Files

700 Series® Shells

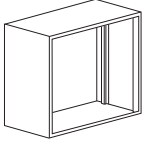
	MODEL	Accepts Inserts Totaling	W x D	MODEL NUMBER				Approx. Packaged Weight
				Basic Model	Unit Color	Optional Counterbalance Weight	Key Option	
S7LCU	27" High Shell	24"	30 x 18"	S7L/30240	<input type="checkbox"/>	<input type="checkbox"/> <input type="checkbox"/> <input type="checkbox"/> <input type="checkbox"/> <input type="checkbox"/> <input type="checkbox"/>	<input type="checkbox"/> <input type="checkbox"/> <input type="checkbox"/>	42.0#
		24"	36 x 18"	S7L/36240	<input type="checkbox"/>	<input type="checkbox"/> <input type="checkbox"/> <input type="checkbox"/> <input type="checkbox"/> <input type="checkbox"/> <input type="checkbox"/>	<input type="checkbox"/> <input type="checkbox"/> <input type="checkbox"/>	50.0#
		24"	42 x 18"	S7L/42240	<input type="checkbox"/>	<input type="checkbox"/> <input type="checkbox"/> <input type="checkbox"/> <input type="checkbox"/> <input type="checkbox"/> <input type="checkbox"/>	<input type="checkbox"/> <input type="checkbox"/> <input type="checkbox"/>	56.0#
S7LCU	28-17/32" High Shell	25-1/2"	30 x 18"	S7L/30255	<input type="checkbox"/>	<input type="checkbox"/> <input type="checkbox"/> <input type="checkbox"/> <input type="checkbox"/> <input type="checkbox"/> <input type="checkbox"/>	<input type="checkbox"/> <input type="checkbox"/> <input type="checkbox"/>	45.0#
		25-1/2"	36 x 18"	S7L/36255	<input type="checkbox"/>	<input type="checkbox"/> <input type="checkbox"/> <input type="checkbox"/> <input type="checkbox"/> <input type="checkbox"/> <input type="checkbox"/>	<input type="checkbox"/> <input type="checkbox"/> <input type="checkbox"/>	53.0#
		25-1/2"	42 x 18"	S7L/42255	<input type="checkbox"/>	<input type="checkbox"/> <input type="checkbox"/> <input type="checkbox"/> <input type="checkbox"/> <input type="checkbox"/> <input type="checkbox"/>	<input type="checkbox"/> <input type="checkbox"/> <input type="checkbox"/>	60.0#
S7LCU	30-1/16" High Shell	27"	30 x 18"	S7L/30270	<input type="checkbox"/>	<input type="checkbox"/> <input type="checkbox"/> <input type="checkbox"/> <input type="checkbox"/> <input type="checkbox"/> <input type="checkbox"/>	<input type="checkbox"/> <input type="checkbox"/> <input type="checkbox"/>	47.0#
		27"	36 x 18"	S7L/36270	<input type="checkbox"/>	<input type="checkbox"/> <input type="checkbox"/> <input type="checkbox"/> <input type="checkbox"/> <input type="checkbox"/> <input type="checkbox"/>	<input type="checkbox"/> <input type="checkbox"/> <input type="checkbox"/>	55.0#
		27"	42 x 18"	S7L/42270	<input type="checkbox"/>	<input type="checkbox"/> <input type="checkbox"/> <input type="checkbox"/> <input type="checkbox"/> <input type="checkbox"/> <input type="checkbox"/>	<input type="checkbox"/> <input type="checkbox"/> <input type="checkbox"/>	62.0#
	31-19/32" High Shell	28-1/2"	30 x 18"	S7L/30285	<input type="checkbox"/>	<input type="checkbox"/> <input type="checkbox"/> <input type="checkbox"/> <input type="checkbox"/> <input type="checkbox"/> <input type="checkbox"/>	<input type="checkbox"/> <input type="checkbox"/> <input type="checkbox"/>	49.0#
		28-1/2"	36 x 18"	S7L/36285	<input type="checkbox"/>	<input type="checkbox"/> <input type="checkbox"/> <input type="checkbox"/> <input type="checkbox"/> <input type="checkbox"/> <input type="checkbox"/>	<input type="checkbox"/> <input type="checkbox"/> <input type="checkbox"/>	57.0#
		28-1/2"	42 x 18"	S7L/42285	<input type="checkbox"/>	<input type="checkbox"/> <input type="checkbox"/> <input type="checkbox"/> <input type="checkbox"/> <input type="checkbox"/> <input type="checkbox"/>	<input type="checkbox"/> <input type="checkbox"/> <input type="checkbox"/>	64.0#
S7LCU	33-1/8" High Shell	30"	30 x 18"	S7L/30300	<input type="checkbox"/>	<input type="checkbox"/> <input type="checkbox"/> <input type="checkbox"/> <input type="checkbox"/> <input type="checkbox"/> <input type="checkbox"/>	<input type="checkbox"/> <input type="checkbox"/> <input type="checkbox"/>	52.0#
		30"	36 x 18"	S7L/36300	<input type="checkbox"/>	<input type="checkbox"/> <input type="checkbox"/> <input type="checkbox"/> <input type="checkbox"/> <input type="checkbox"/> <input type="checkbox"/>	<input type="checkbox"/> <input type="checkbox"/> <input type="checkbox"/>	60.0#
		30"	42 x 18"	S7L/42300	<input type="checkbox"/>	<input type="checkbox"/> <input type="checkbox"/> <input type="checkbox"/> <input type="checkbox"/> <input type="checkbox"/> <input type="checkbox"/>	<input type="checkbox"/> <input type="checkbox"/> <input type="checkbox"/>	67.0#
S7LCU	34-21/32" High Shell	31-1/2"	30 x 18"	S7L/30315	<input type="checkbox"/>	<input type="checkbox"/> <input type="checkbox"/> <input type="checkbox"/> <input type="checkbox"/> <input type="checkbox"/> <input type="checkbox"/>	<input type="checkbox"/> <input type="checkbox"/> <input type="checkbox"/>	54.0#
		31-1/2"	36 x 18"	S7L/36315	<input type="checkbox"/>	<input type="checkbox"/> <input type="checkbox"/> <input type="checkbox"/> <input type="checkbox"/> <input type="checkbox"/> <input type="checkbox"/>	<input type="checkbox"/> <input type="checkbox"/> <input type="checkbox"/>	62.0#
		31-1/2"	42 x 18"	S7L/42315	<input type="checkbox"/>	<input type="checkbox"/> <input type="checkbox"/> <input type="checkbox"/> <input type="checkbox"/> <input type="checkbox"/> <input type="checkbox"/>	<input type="checkbox"/> <input type="checkbox"/> <input type="checkbox"/>	69.0#

A **B** **C** **D**

HOW TO ORDER

Indicate the following information on order form:

- Quantity of each item.
- Model number, including options. See "How To Build a Model Number".
- Any special service required.

Note:

- The indicates that a choice is required.
- The absence of the indicates that no choice is required.
- Alpha-numeric characters in place of indicate that no other alternatives are available.

HOW TO BUILD A MODEL NUMBER

- A** Select basic model.
- B** Select unit color.
Refer to color addendum at ki.com or KI Fabrics & Finishes binder.
- C** Select counterbalance weight.

CBW	- With Counterbalance
NOCBW	- No Counterbalance

 See pricing column for counterbalance weight upcharge.
- D** Select key option.

KA	- Key alike
KS	- Key standard
NLC	- No lock core

INFORMATION

Height

All dimensions shown include 1/8" allowance for glides in recessed position.

Weights

Figures provided are approximate and reflect packaged product without additional accessories.



Custom-Built Lateral Files

700 Series® Shells

Delivered Pricing	Counter-balance Weight add to list price
\$ 398	\$ 161
454	161
489	161
\$ 398	\$ 161
454	161
489	161
\$ 427	\$ 161
489	161
587	161
\$ 427	\$ 161
489	161
587	161
\$ 427	\$ 161
489	161
587	161
\$ 427	\$ 161
489	161
587	161

SPECIAL SERVICES

Special Carton Marking

With specially marked information N/C

Shipping

Shipped **assembled freight prepaid f.o.b. Pembroke, Ontario K8A 0E1** factory. Freight class #70.

Specifications and prices are subject to change without prior notice.

Custom-Built Lateral Files

700 Series® Shells

	MODEL	Accepts Inserts Totaling	W x D	MODEL NUMBER				Approx. Packaged Weight
				Basic Model	Unit Color	Optional Counterbalance Weight	Key Option	
S7LCU	36-3/16" High Shell	33"	30 x 18"	S7L/30330	<input type="checkbox"/>	<input type="checkbox"/> <input type="checkbox"/> <input type="checkbox"/> <input type="checkbox"/> <input type="checkbox"/>	<input type="checkbox"/> <input type="checkbox"/> <input type="checkbox"/>	56.0#
		33"	36 x 18"	S7L/36330	<input type="checkbox"/>	<input type="checkbox"/> <input type="checkbox"/> <input type="checkbox"/> <input type="checkbox"/> <input type="checkbox"/>	<input type="checkbox"/> <input type="checkbox"/> <input type="checkbox"/>	64.0#
		33"	42 x 18"	S7L/42330	<input type="checkbox"/>	<input type="checkbox"/> <input type="checkbox"/> <input type="checkbox"/> <input type="checkbox"/> <input type="checkbox"/>	<input type="checkbox"/> <input type="checkbox"/> <input type="checkbox"/>	71.0#
S7LCU	37-23/32" High Shell	34-1/2"	30 x 18"	S7L/30345	<input type="checkbox"/>	<input type="checkbox"/> <input type="checkbox"/> <input type="checkbox"/> <input type="checkbox"/> <input type="checkbox"/>	<input type="checkbox"/> <input type="checkbox"/> <input type="checkbox"/>	58.0#
		34-1/2"	36 x 18"	S7L/36345	<input type="checkbox"/>	<input type="checkbox"/> <input type="checkbox"/> <input type="checkbox"/> <input type="checkbox"/> <input type="checkbox"/>	<input type="checkbox"/> <input type="checkbox"/> <input type="checkbox"/>	66.0#
		34-1/2"	42 x 18"	S7L/42345	<input type="checkbox"/>	<input type="checkbox"/> <input type="checkbox"/> <input type="checkbox"/> <input type="checkbox"/> <input type="checkbox"/>	<input type="checkbox"/> <input type="checkbox"/> <input type="checkbox"/>	73.0#
S7LCU	39-1/4" High Shell	36"	30 x 18"	S7L/30360	<input type="checkbox"/>	<input type="checkbox"/> <input type="checkbox"/> <input type="checkbox"/> <input type="checkbox"/> <input type="checkbox"/>	<input type="checkbox"/> <input type="checkbox"/> <input type="checkbox"/>	61.0#
		36"	36 x 18"	S7L/36360	<input type="checkbox"/>	<input type="checkbox"/> <input type="checkbox"/> <input type="checkbox"/> <input type="checkbox"/> <input type="checkbox"/>	<input type="checkbox"/> <input type="checkbox"/> <input type="checkbox"/>	68.0#
		36"	42 x 18"	S7L/42360	<input type="checkbox"/>	<input type="checkbox"/> <input type="checkbox"/> <input type="checkbox"/> <input type="checkbox"/> <input type="checkbox"/>	<input type="checkbox"/> <input type="checkbox"/> <input type="checkbox"/>	75.0#
S7LCU	40-25/32" High Shell	37-1/2"	30 x 18"	S7L/30375	<input type="checkbox"/>	<input type="checkbox"/> <input type="checkbox"/> <input type="checkbox"/> <input type="checkbox"/> <input type="checkbox"/>	<input type="checkbox"/> <input type="checkbox"/> <input type="checkbox"/>	64.0#
		37-1/2"	36 x 18"	S7L/36375	<input type="checkbox"/>	<input type="checkbox"/> <input type="checkbox"/> <input type="checkbox"/> <input type="checkbox"/> <input type="checkbox"/>	<input type="checkbox"/> <input type="checkbox"/> <input type="checkbox"/>	71.0#
		37-1/2"	42 x 18"	S7L/42375	<input type="checkbox"/>	<input type="checkbox"/> <input type="checkbox"/> <input type="checkbox"/> <input type="checkbox"/> <input type="checkbox"/>	<input type="checkbox"/> <input type="checkbox"/> <input type="checkbox"/>	78.0#
S7LCU	42-5/16" High Shell	39"	30 x 18"	S7L/30390	<input type="checkbox"/>	<input type="checkbox"/> <input type="checkbox"/> <input type="checkbox"/> <input type="checkbox"/> <input type="checkbox"/>	<input type="checkbox"/> <input type="checkbox"/> <input type="checkbox"/>	66.0#
		39"	36 x 18"	S7L/36390	<input type="checkbox"/>	<input type="checkbox"/> <input type="checkbox"/> <input type="checkbox"/> <input type="checkbox"/> <input type="checkbox"/>	<input type="checkbox"/> <input type="checkbox"/> <input type="checkbox"/>	73.0#
		39"	42 x 18"	S7L/42390	<input type="checkbox"/>	<input type="checkbox"/> <input type="checkbox"/> <input type="checkbox"/> <input type="checkbox"/> <input type="checkbox"/>	<input type="checkbox"/> <input type="checkbox"/> <input type="checkbox"/>	80.0#
S7LCU	43-27/32" High Shell	40-1/2"	30 x 18"	S7L/30405	<input type="checkbox"/>	<input type="checkbox"/> <input type="checkbox"/> <input type="checkbox"/> <input type="checkbox"/> <input type="checkbox"/>	<input type="checkbox"/> <input type="checkbox"/> <input type="checkbox"/>	68.0#
		40-1/2"	36 x 18"	S7L/36405	<input type="checkbox"/>	<input type="checkbox"/> <input type="checkbox"/> <input type="checkbox"/> <input type="checkbox"/> <input type="checkbox"/>	<input type="checkbox"/> <input type="checkbox"/> <input type="checkbox"/>	75.0#
		40-1/2"	42 x 18"	S7L/42405	<input type="checkbox"/>	<input type="checkbox"/> <input type="checkbox"/> <input type="checkbox"/> <input type="checkbox"/> <input type="checkbox"/>	<input type="checkbox"/> <input type="checkbox"/> <input type="checkbox"/>	82.0#

A **B** **C** **D**

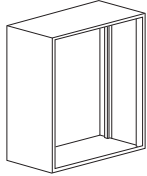

HOW TO ORDER

Indicate the following information on order form:

- Quantity of each item.
- Model number, including options. See "How To Build a Model Number".
- Any special service required.

- Note:
- The indicates that a choice is required.
 - The absence of the indicates that no choice is required.
 - Alpha-numeric characters in place of indicate that no other alternatives are available.

HOW TO BUILD A MODEL NUMBER

- A** Select basic model.
- B** Select unit color.
Refer to color addendum at ki.com or KI Fabrics & Finishes binder.
- C** Select counterbalance weight.
CBW - With Counterbalance
NOCBW - No Counterbalance
See pricing column for counterbalance weight upcharge.
- D** Select key option.
KA - Key alike
KS - Key standard
NLC - No lock core

INFORMATION

Height

All dimensions shown include 1/8" allowance for glides in recessed position.

Weights

Figures provided are approximate and reflect packaged product without additional accessories.



Custom-Built Lateral Files

700 Series® Shells

Delivered Pricing	Counter-balance Weight add to list price
\$ 465	\$ 161
528	161
605	161
\$ 465	\$ 161
528	161
605	161
\$ 465	\$ 161
528	161
605	161
\$ 465	\$ 161
528	161
605	161
\$ 489	\$ 161
594	161
692	161
\$ 489	\$ 161
594	161
692	161

SPECIAL SERVICES

Special Carton Marking

With specially marked information N/C

Shipping

Shipped **assembled freight prepaid f.o.b. Pembroke, Ontario K8A 0E1** factory. Freight class #70.

Specifications and prices are subject to change without prior notice.

Custom-Built Lateral Files

700 Series® Shells

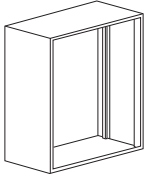
	MODEL	Accepts Inserts Totaling	W x D	MODEL NUMBER				Approx. Packaged Weight
				Basic Model	Unit Color	Optional Counterbalance Weight	Key Option	
	45-3/8" High Shell	42"	30 x 18"	S7L/30420	<input type="checkbox"/>	<input type="checkbox"/> <input type="checkbox"/> <input type="checkbox"/> <input type="checkbox"/> <input type="checkbox"/>	<input type="checkbox"/> <input type="checkbox"/> <input type="checkbox"/>	70.0#
		42"	36 x 18"	S7L/36420	<input type="checkbox"/>	<input type="checkbox"/> <input type="checkbox"/> <input type="checkbox"/> <input type="checkbox"/> <input type="checkbox"/>	<input type="checkbox"/> <input type="checkbox"/> <input type="checkbox"/>	77.0#
		42"	42 x 18"	S7L/42420	<input type="checkbox"/>	<input type="checkbox"/> <input type="checkbox"/> <input type="checkbox"/> <input type="checkbox"/> <input type="checkbox"/>	<input type="checkbox"/> <input type="checkbox"/> <input type="checkbox"/>	84.0#
S7LCU								
S7LCU	46-29/32" High Shell	43-1/2"	30 x 18"	S7L/30435	<input type="checkbox"/>	<input type="checkbox"/> <input type="checkbox"/> <input type="checkbox"/> <input type="checkbox"/> <input type="checkbox"/>	<input type="checkbox"/> <input type="checkbox"/> <input type="checkbox"/>	71.0#
		43-1/2"	36 x 18"	S7L/36435	<input type="checkbox"/>	<input type="checkbox"/> <input type="checkbox"/> <input type="checkbox"/> <input type="checkbox"/> <input type="checkbox"/>	<input type="checkbox"/> <input type="checkbox"/> <input type="checkbox"/>	78.0#
		43-1/2"	42 x 18"	S7L/42435	<input type="checkbox"/>	<input type="checkbox"/> <input type="checkbox"/> <input type="checkbox"/> <input type="checkbox"/> <input type="checkbox"/>	<input type="checkbox"/> <input type="checkbox"/> <input type="checkbox"/>	85.0#
S7LCU	48-7/16" High Shell	45"	30 x 18"	S7L/30450	<input type="checkbox"/>	<input type="checkbox"/> <input type="checkbox"/> <input type="checkbox"/> <input type="checkbox"/> <input type="checkbox"/>	<input type="checkbox"/> <input type="checkbox"/> <input type="checkbox"/>	73.0#
		45"	36 x 18"	S7L/36450	<input type="checkbox"/>	<input type="checkbox"/> <input type="checkbox"/> <input type="checkbox"/> <input type="checkbox"/> <input type="checkbox"/>	<input type="checkbox"/> <input type="checkbox"/> <input type="checkbox"/>	80.0#
		45"	42 x 18"	S7L/42450	<input type="checkbox"/>	<input type="checkbox"/> <input type="checkbox"/> <input type="checkbox"/> <input type="checkbox"/> <input type="checkbox"/>	<input type="checkbox"/> <input type="checkbox"/> <input type="checkbox"/>	87.0#
S7LCU	49-31/32" High Shell	46-1/2"	30 x 18"	S7L/30465	<input type="checkbox"/>	<input type="checkbox"/> <input type="checkbox"/> <input type="checkbox"/> <input type="checkbox"/> <input type="checkbox"/>	<input type="checkbox"/> <input type="checkbox"/> <input type="checkbox"/>	75.0#
		46-1/2"	36 x 18"	S7L/36465	<input type="checkbox"/>	<input type="checkbox"/> <input type="checkbox"/> <input type="checkbox"/> <input type="checkbox"/> <input type="checkbox"/>	<input type="checkbox"/> <input type="checkbox"/> <input type="checkbox"/>	82.0#
		46-1/2"	42 x 18"	S7L/42465	<input type="checkbox"/>	<input type="checkbox"/> <input type="checkbox"/> <input type="checkbox"/> <input type="checkbox"/> <input type="checkbox"/>	<input type="checkbox"/> <input type="checkbox"/> <input type="checkbox"/>	89.0#
S7LCU	51-1/2" High Shell	48"	30 x 18"	S7L/30480	<input type="checkbox"/>	<input type="checkbox"/> <input type="checkbox"/> <input type="checkbox"/> <input type="checkbox"/> <input type="checkbox"/>	<input type="checkbox"/> <input type="checkbox"/> <input type="checkbox"/>	76.0#
		48"	36 x 18"	S7L/36480	<input type="checkbox"/>	<input type="checkbox"/> <input type="checkbox"/> <input type="checkbox"/> <input type="checkbox"/> <input type="checkbox"/>	<input type="checkbox"/> <input type="checkbox"/> <input type="checkbox"/>	83.0#
		48"	42 x 18"	S7L/42480	<input type="checkbox"/>	<input type="checkbox"/> <input type="checkbox"/> <input type="checkbox"/> <input type="checkbox"/> <input type="checkbox"/>	<input type="checkbox"/> <input type="checkbox"/> <input type="checkbox"/>	90.0#
S7LCU	53-1/32" High Shell	49-1/2"	30 x 18"	S7L/30495	<input type="checkbox"/>	<input type="checkbox"/> <input type="checkbox"/> <input type="checkbox"/> <input type="checkbox"/> <input type="checkbox"/>	<input type="checkbox"/> <input type="checkbox"/> <input type="checkbox"/>	78.0#
		49-1/2"	36 x 18"	S7L/36495	<input type="checkbox"/>	<input type="checkbox"/> <input type="checkbox"/> <input type="checkbox"/> <input type="checkbox"/> <input type="checkbox"/>	<input type="checkbox"/> <input type="checkbox"/> <input type="checkbox"/>	85.0#
		49-1/2"	42 x 18"	S7L/42495	<input type="checkbox"/>	<input type="checkbox"/> <input type="checkbox"/> <input type="checkbox"/> <input type="checkbox"/> <input type="checkbox"/>	<input type="checkbox"/> <input type="checkbox"/> <input type="checkbox"/>	92.0#

A **B** **C** **D**

HOW TO ORDER

Indicate the following information on order form:

- Quantity of each item.
- Model number, including options. See "How To Build a Model Number".
- Any special service required.

Note:

- The indicates that a choice is required.
- The absence of the indicates that no choice is required.
- Alpha-numeric characters in place of indicate that no other alternatives are available.

HOW TO BUILD A MODEL NUMBER

- A** Select basic model.
- B** Select unit color.
Refer to color addendum at ki.com or KI Fabrics & Finishes binder.
- C** Select counterbalance weight.

CBW	- With Counterbalance
NOCBW	- No Counterbalance

 See pricing column for counterbalance weight upcharge.
- D** Select key option.

KA	- Key alike
KS	- Key standard
NLC	- No lock core

INFORMATION

Height
All dimensions shown include 1/8" allowance for glides in recessed position.

Weights
Figures provided are approximate and reflect packaged product without additional accessories.



Custom-Built Lateral Files

700 Series® Shells

Delivered Pricing	Counter-balance Weight add to list price
\$ 489	\$ 161
594	161
692	161
\$ 489	\$ 161
594	161
692	161
\$ 521	\$ 161
664	161
774	161
\$ 521	\$ 161
664	161
774	161
\$ 521	\$ 125
664	125
774	125
\$ 521	\$ 125
664	125
774	125

SPECIAL SERVICES

Special Carton Marking

With specially marked information N/C

Shipping

Shipped **assembled freight prepaid f.o.b. Pembroke, Ontario K8A 0E1** factory. Freight class #70.

Specifications and prices are subject to change without prior notice.

Custom-Built Lateral Files

700 Series® Shells

	MODEL	Accepts Inserts Totaling	W x D	MODEL NUMBER				Approx. Packaged Weight
				Basic Model	Unit Color	Optional Counterbalance Weight	Key Option	
S7LCU	54-9/16" High Shell	51"	30 x 18"	S7L/30510	<input type="checkbox"/>	<input type="checkbox"/> <input type="checkbox"/> <input type="checkbox"/> <input type="checkbox"/>	<input type="checkbox"/> <input type="checkbox"/>	79.0#
		51"	36 x 18"	S7L/36510	<input type="checkbox"/>	<input type="checkbox"/> <input type="checkbox"/> <input type="checkbox"/> <input type="checkbox"/>	<input type="checkbox"/> <input type="checkbox"/>	86.0#
		51"	42 x 18"	S7L/42510	<input type="checkbox"/>	<input type="checkbox"/> <input type="checkbox"/> <input type="checkbox"/> <input type="checkbox"/>	<input type="checkbox"/> <input type="checkbox"/>	93.0#
S7LCU	56-3/32" High Shell	52-1/2"	30 x 18"	S7L/30525	<input type="checkbox"/>	<input type="checkbox"/> <input type="checkbox"/> <input type="checkbox"/> <input type="checkbox"/>	<input type="checkbox"/> <input type="checkbox"/>	81.0#
		52-1/2"	36 x 18"	S7L/36525	<input type="checkbox"/>	<input type="checkbox"/> <input type="checkbox"/> <input type="checkbox"/> <input type="checkbox"/>	<input type="checkbox"/> <input type="checkbox"/>	88.0#
		52-1/2"	42 x 18"	S7L/42525	<input type="checkbox"/>	<input type="checkbox"/> <input type="checkbox"/> <input type="checkbox"/> <input type="checkbox"/>	<input type="checkbox"/> <input type="checkbox"/>	95.0#
S7LCU	57-5/8" High Shell	54"	30 x 18"	S7L/30540	<input type="checkbox"/>	<input type="checkbox"/> <input type="checkbox"/> <input type="checkbox"/> <input type="checkbox"/>	<input type="checkbox"/> <input type="checkbox"/>	83.0#
		54"	36 x 18"	S7L/36540	<input type="checkbox"/>	<input type="checkbox"/> <input type="checkbox"/> <input type="checkbox"/> <input type="checkbox"/>	<input type="checkbox"/> <input type="checkbox"/>	90.0#
		54"	42 x 18"	S7L/42540	<input type="checkbox"/>	<input type="checkbox"/> <input type="checkbox"/> <input type="checkbox"/> <input type="checkbox"/>	<input type="checkbox"/> <input type="checkbox"/>	97.0#
S7LCU	59-5/32" High Shell	55-1/2"	30 x 18"	S7L/30555	<input type="checkbox"/>	<input type="checkbox"/> <input type="checkbox"/> <input type="checkbox"/> <input type="checkbox"/>	<input type="checkbox"/> <input type="checkbox"/>	84.0#
		55-1/2"	36 x 18"	S7L/36555	<input type="checkbox"/>	<input type="checkbox"/> <input type="checkbox"/> <input type="checkbox"/> <input type="checkbox"/>	<input type="checkbox"/> <input type="checkbox"/>	91.0#
		55-1/2"	42 x 18"	S7L/42555	<input type="checkbox"/>	<input type="checkbox"/> <input type="checkbox"/> <input type="checkbox"/> <input type="checkbox"/>	<input type="checkbox"/> <input type="checkbox"/>	98.0#
S7LCU	60-11/16" High Shell	57"	30 x 18"	S7L/30570	<input type="checkbox"/>	<input type="checkbox"/> <input type="checkbox"/> <input type="checkbox"/> <input type="checkbox"/>	<input type="checkbox"/> <input type="checkbox"/>	85.0#
		57"	36 x 18"	S7L/36570	<input type="checkbox"/>	<input type="checkbox"/> <input type="checkbox"/> <input type="checkbox"/> <input type="checkbox"/>	<input type="checkbox"/> <input type="checkbox"/>	93.0#
		57"	42 x 18"	S7L/42570	<input type="checkbox"/>	<input type="checkbox"/> <input type="checkbox"/> <input type="checkbox"/> <input type="checkbox"/>	<input type="checkbox"/> <input type="checkbox"/>	99.0#
S7LCU	62-7/32" High Shell	58-1/2"	30 x 18"	S7L/30585	<input type="checkbox"/>	<input type="checkbox"/> <input type="checkbox"/> <input type="checkbox"/> <input type="checkbox"/>	<input type="checkbox"/> <input type="checkbox"/>	87.0#
		58-1/2"	36 x 18"	S7L/36585	<input type="checkbox"/>	<input type="checkbox"/> <input type="checkbox"/> <input type="checkbox"/> <input type="checkbox"/>	<input type="checkbox"/> <input type="checkbox"/>	94.0#
		58-1/2"	42 x 18"	S7L/42585	<input type="checkbox"/>	<input type="checkbox"/> <input type="checkbox"/> <input type="checkbox"/> <input type="checkbox"/>	<input type="checkbox"/> <input type="checkbox"/>	101.0#

A **B** **C** **D**

HOW TO ORDER

Indicate the following information on order form:

- Quantity of each item.
- Model number, including options. See "How To Build a Model Number".
- Any special service required.

Note:

- The indicates that a choice is required.
- The absence of the indicates that no choice is required.
- Alpha-numeric characters in place of indicate that no other alternatives are available.

HOW TO BUILD A MODEL NUMBER

- A** Select basic model.
- B** Select unit color.
Refer to color addendum at ki.com or KI Fabrics & Finishes binder.
- C** Select counterbalance weight.
CBW - With Counterbalance
NOCBW - No Counterbalance
See pricing column for counterbalance weight upcharge.
- D** Select key option.
KA - Key alike
KS - Key standard
NLC - No lock core

INFORMATION

Height

All dimensions shown include 1/8" allowance for glides in recessed position.

Weights

Figures provided are approximate and reflect packaged product without additional accessories.



Custom-Built Lateral Files

700 Series® Shells

Delivered Pricing	Counter-balance Weight add to list price
\$ 547	\$ 125
671	125
797	125
\$ 547	\$ 125
671	125
797	125
\$ 547	\$ 125
671	125
797	125
\$ 547	\$ 125
671	125
797	125
\$ 569	\$ 125
681	125
814	125
\$ 569	\$ 125
681	125
814	125

SPECIAL SERVICES

Special Carton Marking

With specially marked information N/C

Shipping

Shipped **assembled freight prepaid f.o.b. Pembroke, Ontario K8A 0E1** factory. Freight class #70.

Specifications and prices are subject to change without prior notice.

Custom-Built Lateral Files

700 Series® Shells

	MODEL	Accepts Inserts Totaling	W x D	MODEL NUMBER				Approx. Packaged Weight
				Basic Model	Unit Color	Optional Counterbalance Weight	Key Option	
S7LCU	63-3/4" High Shell	60"	30 x 18"	S7L/30600	<input type="checkbox"/>	<input type="checkbox"/> <input type="checkbox"/> <input type="checkbox"/> <input type="checkbox"/>	<input type="checkbox"/> <input type="checkbox"/>	88.0#
		60"	36 x 18"	S7L/36600	<input type="checkbox"/>	<input type="checkbox"/> <input type="checkbox"/> <input type="checkbox"/> <input type="checkbox"/>	<input type="checkbox"/> <input type="checkbox"/>	95.0#
		60"	42 x 18"	S7L/42600	<input type="checkbox"/>	<input type="checkbox"/> <input type="checkbox"/> <input type="checkbox"/> <input type="checkbox"/>	<input type="checkbox"/> <input type="checkbox"/>	102.0#
S7LCU	65-9/32" High Shell • 1-1/2" tie bar/tie bar shelf is required, optimally located between 12" from top of unit and 24" from bottom	61-1/2"	30 x 18"	S7L/30615	<input type="checkbox"/>	<input type="checkbox"/> <input type="checkbox"/> <input type="checkbox"/> <input type="checkbox"/>	<input type="checkbox"/> <input type="checkbox"/>	91.0#
		61-1/2"	36 x 18"	S7L/36615	<input type="checkbox"/>	<input type="checkbox"/> <input type="checkbox"/> <input type="checkbox"/> <input type="checkbox"/>	<input type="checkbox"/> <input type="checkbox"/>	98.0#
		61-1/2"	42 x 18"	S7L/42615	<input type="checkbox"/>	<input type="checkbox"/> <input type="checkbox"/> <input type="checkbox"/> <input type="checkbox"/>	<input type="checkbox"/> <input type="checkbox"/>	105.0#
S7LCU	66-13/16" High Shell • 1-1/2" tie bar/tie bar shelf is required for 30" and 36" width units, optimally located between 12" from top of unit and 24" from bottom • 1-1/2" structural filler shelf is required on 42" widths located nominally between 25-1/2" and 39" from the top of the cabinet based on configuration	63"	30 x 18"	S7L/30630	<input type="checkbox"/>	<input type="checkbox"/> <input type="checkbox"/> <input type="checkbox"/> <input type="checkbox"/>	<input type="checkbox"/> <input type="checkbox"/>	92.0#
		63"	36 x 18"	S7L/36630	<input type="checkbox"/>	<input type="checkbox"/> <input type="checkbox"/> <input type="checkbox"/> <input type="checkbox"/>	<input type="checkbox"/> <input type="checkbox"/>	99.0#
		63"	42 x 18"	S7L/42630	<input type="checkbox"/>	<input type="checkbox"/> <input type="checkbox"/> <input type="checkbox"/> <input type="checkbox"/>	<input type="checkbox"/> <input type="checkbox"/>	106.0#
S7LCU	68-11/32" High Shell • 1-1/2" tie bar/tie bar shelf is required for 30" and 36" width units, optimally located between 12" from top of unit and 24" from bottom • 1-1/2" structural filler shelf is required on 42" widths located nominally between 25-1/2" and 39" from the top of the cabinet based on configuration	64-1/2"	30 x 18"	S7L/30645	<input type="checkbox"/>	<input type="checkbox"/> <input type="checkbox"/> <input type="checkbox"/> <input type="checkbox"/>	<input type="checkbox"/> <input type="checkbox"/>	93.0#
		64-1/2"	36 x 18"	S7L/36645	<input type="checkbox"/>	<input type="checkbox"/> <input type="checkbox"/> <input type="checkbox"/> <input type="checkbox"/>	<input type="checkbox"/> <input type="checkbox"/>	100.0#
		64-1/2"	42 x 18"	S7L/42645	<input type="checkbox"/>	<input type="checkbox"/> <input type="checkbox"/> <input type="checkbox"/> <input type="checkbox"/>	<input type="checkbox"/> <input type="checkbox"/>	108.0#

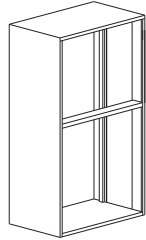
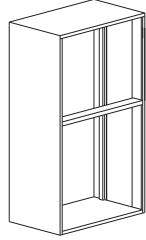

A **B** **C** **D**

HOW TO ORDER

Indicate the following information on order form:

- Quantity of each item.
- Model number, including options. See "How To Build a Model Number".
- Any special service required.

Note:

- The indicates that a choice is required.
- The absence of the indicates that no choice is required.
- Alpha-numeric characters in place of indicate that no other alternatives are available.

HOW TO BUILD A MODEL NUMBER

- A** Select basic model.
- B** Select unit color.
Refer to color addendum at ki.com or KI Fabrics & Finishes binder.
- C** Select counterbalance weight.
CBW - With Counterbalance
NOCBW - No Counterbalance
See pricing column for counterbalance weight upcharge.
- D** Select key option.
KA - Key alike
KS - Key standard
NLC - No lock core

INFORMATION

Height

All dimensions shown include 1/8" allowance for glides in recessed position.

Weights

Figures provided are approximate and reflect packaged product without additional accessories.



Custom-Built Lateral Files

700 Series® Shells

Delivered Pricing	Counter-balance Weight add to list price
\$ 569	\$ 125
681	125
814	125
\$ 569	\$ 125
681	125
814	125
\$ 636	\$ 125
767	125
907	125
\$ 636	\$ 125
767	125
907	125

SPECIAL SERVICES

Special Carton Marking

With specially marked information N/C

Shipping

Shipped **assembled freight prepaid f.o.b. Pembroke, Ontario K8A 0E1** factory. Freight class #70.

Specifications and prices are subject to change without prior notice.

Custom-Built Lateral Files

700 Series® Shells

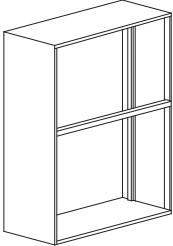
	MODEL	Accepts Inserts Totaling	W x D	MODEL NUMBER				Approx. Packaged Weight
				Basic Model	Unit Color	Optional Counter-balance Weight	Key Option	
S7LCU	69-7/8" High Shell • 1-1/2" tie bar/tie bar shelf is required for 30" and 36" width units, optimally located between 12" from top of unit and 24" from bottom • 1-1/2" structural filler shelf is required on 42" widths located nominally between 25-1/2" and 39" from the top of the cabinet based on configuration	66"	30 x 18"	S7L/30660	<input type="checkbox"/>	<input type="checkbox"/> <input type="checkbox"/> <input type="checkbox"/> <input type="checkbox"/>	<input type="checkbox"/> <input type="checkbox"/>	95.0#
		66"	36 x 18"	S7L/36660	<input type="checkbox"/>	<input type="checkbox"/> <input type="checkbox"/> <input type="checkbox"/> <input type="checkbox"/>	<input type="checkbox"/> <input type="checkbox"/>	102.0#
		66"	42 x 18"	S7L/42660	<input type="checkbox"/>	<input type="checkbox"/> <input type="checkbox"/> <input type="checkbox"/> <input type="checkbox"/>	<input type="checkbox"/> <input type="checkbox"/>	110.0#
S7LCU	71-13/32" High Shell • 1-1/2" tie bar/tie bar shelf is required for 30" and 36" width units, optimally located between 12" from top of unit and 24" from bottom • 1-1/2" structural filler shelf is required on 42" widths located nominally between 25-1/2" and 39" from the top of the cabinet based on configuration	67-1/2"	30 x 18"	S7L/30675	<input type="checkbox"/>	<input type="checkbox"/> <input type="checkbox"/> <input type="checkbox"/> <input type="checkbox"/>	<input type="checkbox"/> <input type="checkbox"/>	96.0#
		67-1/2"	36 x 18"	S7L/36675	<input type="checkbox"/>	<input type="checkbox"/> <input type="checkbox"/> <input type="checkbox"/> <input type="checkbox"/>	<input type="checkbox"/> <input type="checkbox"/>	101.0#
		67-1/2"	42 x 18"	S7L/42675	<input type="checkbox"/>	<input type="checkbox"/> <input type="checkbox"/> <input type="checkbox"/> <input type="checkbox"/>	<input type="checkbox"/> <input type="checkbox"/>	109.0#
	72-15/16" High Shell • 1-1/2" tie bar/tie bar shelf is required for 30" and 36" width units, optimally located between 12" from top of unit and 24" from bottom • 1-1/2" structural filler shelf is required on 42" widths located nominally between 25-1/2" and 39" from the top of the cabinet based on configuration	69"	30 x 18"	S7L/30690	<input type="checkbox"/>	<input type="checkbox"/> <input type="checkbox"/> <input type="checkbox"/> <input type="checkbox"/>	<input type="checkbox"/> <input type="checkbox"/>	97.0#
		69"	36 x 18"	S7L/36690	<input type="checkbox"/>	<input type="checkbox"/> <input type="checkbox"/> <input type="checkbox"/> <input type="checkbox"/>	<input type="checkbox"/> <input type="checkbox"/>	102.0#
		69"	42 x 18"	S7L/42690	<input type="checkbox"/>	<input type="checkbox"/> <input type="checkbox"/> <input type="checkbox"/> <input type="checkbox"/>	<input type="checkbox"/> <input type="checkbox"/>	110.0#

A **B** **C** **D**

HOW TO ORDER

Indicate the following information on order form:

- Quantity of each item.
- Model number, including options. See "How To Build a Model Number".
- Any special service required.

Note:

- The indicates that a choice is required.
- The absence of the indicates that no choice is required.
- Alpha-numeric characters in place of indicate that no other alternatives are available.

HOW TO BUILD A MODEL NUMBER

- A** Select basic model.
- B** Select unit color.
Refer to color addendum at ki.com or KI Fabrics & Finishes binder.
- C** Select counterbalance weight.

CBW	- With Counterbalance
NOCBW	- No Counterbalance

 See pricing column for counterbalance weight upcharge.
- D** Select key option.

KA	- Key alike
KS	- Key standard
NLC	- No lock core

INFORMATION

Height

All dimensions shown include 1/8" allowance for glides in recessed position.

Weights

Figures provided are approximate and reflect packaged product without additional accessories.



Custom-Built Lateral Files

700 Series® Shells

Delivered Pricing	Counter-balance Weight add to list price
\$ 636	\$ 125
767	125
907	125
<hr/>	
\$ 636	\$ 125
767	125
907	125
<hr/>	
\$ 700	\$ 125
850	125
1009	125

SPECIAL SERVICES

Special Carton Marking

With specially marked information N/C

Shipping

Shipped **assembled freight prepaid f.o.b. Pembroke, Ontario K8A 0E1** factory. Freight class #70.

Specifications and prices are subject to change without prior notice.

Custom-Built Lateral Files

700 Series® Shells

	MODEL	Accepts Inserts Totaling	W x D	MODEL NUMBER				Approx. Packaged Weight
				Basic Model	Unit Color	Optional Counter-balance Weight	Key Option	
S7LCU	74-15/32" High Shell • 1-1/2" tie bar/tie bar shelf is required for 30" and 36" width units, optimally located between 12" from top of unit and 24" from bottom • 1-1/2" structural filler shelf is required on 42" widths located nominally between 25-1/2" and 39" from the top of the cabinet based on configuration	70-1/2"	30 x 18"	S7L/30705	<input type="checkbox"/>	<input type="checkbox"/> <input type="checkbox"/> <input type="checkbox"/> <input type="checkbox"/>	<input type="checkbox"/> <input type="checkbox"/>	99.0#
		70-1/2"	36 x 18"	S7L/36705	<input type="checkbox"/>	<input type="checkbox"/> <input type="checkbox"/> <input type="checkbox"/> <input type="checkbox"/>	<input type="checkbox"/> <input type="checkbox"/>	104.0#
		70-1/2"	42 x 18"	S7L/42705	<input type="checkbox"/>	<input type="checkbox"/> <input type="checkbox"/> <input type="checkbox"/> <input type="checkbox"/>	<input type="checkbox"/> <input type="checkbox"/>	112.0#
S7LCU	76" High Shell • 1-1/2" tie bar/tie bar shelf is required for 30" and 36" width units, optimally located between 12" from top of unit and 24" from bottom • 1-1/2" structural filler shelf is required on 42" widths located nominally between 25-1/2" and 39" from the top of the cabinet based on configuration	72"	30 x 18"	S7L/30720	<input type="checkbox"/>	<input type="checkbox"/> <input type="checkbox"/> <input type="checkbox"/> <input type="checkbox"/>	<input type="checkbox"/> <input type="checkbox"/>	100.0#
		72"	36 x 18"	S7L/36720	<input type="checkbox"/>	<input type="checkbox"/> <input type="checkbox"/> <input type="checkbox"/> <input type="checkbox"/>	<input type="checkbox"/> <input type="checkbox"/>	105.0#
		72"	42 x 18"	S7L/42720	<input type="checkbox"/>	<input type="checkbox"/> <input type="checkbox"/> <input type="checkbox"/> <input type="checkbox"/>	<input type="checkbox"/> <input type="checkbox"/>	113.0#
S7LCU	77-17/32" High Shell • 1-1/2" tie bar/tie bar shelf is required for 30" and 36" width units, optimally located between 12" from top of unit and 24" from bottom • 1-1/2" structural filler shelf is required on 42" widths located nominally between 25-1/2" and 39" from the top of the cabinet based on configuration	73-1/2"	30 x 18"	S7L/30735	<input type="checkbox"/>	<input type="checkbox"/> <input type="checkbox"/> <input type="checkbox"/> <input type="checkbox"/>	<input type="checkbox"/> <input type="checkbox"/>	102.0#
		73-1/2"	36 x 18"	S7L/36735	<input type="checkbox"/>	<input type="checkbox"/> <input type="checkbox"/> <input type="checkbox"/> <input type="checkbox"/>	<input type="checkbox"/> <input type="checkbox"/>	108.0#
		73-1/2"	42 x 18"	S7L/42735	<input type="checkbox"/>	<input type="checkbox"/> <input type="checkbox"/> <input type="checkbox"/> <input type="checkbox"/>	<input type="checkbox"/> <input type="checkbox"/>	116.0#

A **B** **C** **D**

HOW TO ORDER

Indicate the following information on order form:

- Quantity of each item.
- Model number, including options. See "How To Build a Model Number".
- Any special service required.

Note:

- The indicates that a choice is required.
- The absence of the indicates that no choice is required.
- Alpha-numeric characters in place of indicate that no other alternatives are available.

HOW TO BUILD A MODEL NUMBER

- A** Select basic model.
- B** Select unit color.
Refer to color addendum at ki.com or KI Fabrics & Finishes binder.
- C** Select counterbalance weight.

CBW	- With Counterbalance
NOCBW	- No Counterbalance

 See pricing column for counterbalance weight upcharge.
- D** Select key option.

KA	- Key alike
KS	- Key standard
NLC	- No lock core

INFORMATION

Height
All dimensions shown include 1/8" allowance for glides in recessed position.

Weights
Figures provided are approximate and reflect packaged product without additional accessories.



Custom-Built Lateral Files

700 Series® Shells

Delivered Pricing	Counter-balance Weight add to list price
\$ 700	\$ 125
850	125
1009	125
<hr/>	
\$ 700	\$ 125
850	125
1009	125
<hr/>	
\$ 700	\$ 125
850	125
1009	125

SPECIAL SERVICES

Special Carton Marking

With specially marked information N/C





Shipping

Shipped **assembled freight prepaid f.o.b. Pembroke, Ontario K8A 0E1** factory. Freight class #70.

Specifications and prices are subject to change without prior notice.

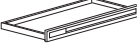
Custom-Built Lateral Files

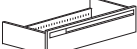
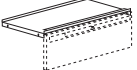
700 Series® Drawers

	MODEL	Accessories Included	W	MODEL NUMBER		Approx. Packaged Weight
				Basic Model	Unit Color	
 LTACU	3" High Drawer • Will not accept plate dividers • Specify with caution, not controlled by safety interlock	None	30"	S7L/30030D	<input type="checkbox"/>	13.0#
		None	36"	S7L/36030D	<input type="checkbox"/>	16.0#
		None	42"	S7L/42030D	<input type="checkbox"/>	20.0#
 LTACU	6" High Drawers • All internal accessories must be specified separately - slotted on 1/2" centers • Accepts 3346DV dividers	None	30"	S7L/30060D	<input type="checkbox"/>	18.0#
		None	36"	S7L/36060D	<input type="checkbox"/>	19.0#
		None	42"	S7L/42060D	<input type="checkbox"/>	23.0#
 LTACU	7-1/2" High Drawer • All internal accessories must be specified separately - slotted on 1/2" centers • Accepts 3346DV dividers	None	30"	S7L/30075D	<input type="checkbox"/>	18.0#
		None	36"	S7L/36075D	<input type="checkbox"/>	19.0#
		None	42"	S7L/42075D	<input type="checkbox"/>	23.0#
 LTACU	9" High Drawer • All internal accessories must be specified separately - slotted on 1/2" centers • Accepts 3346DV dividers	None	30"	S7L/30090D	<input type="checkbox"/>	19.0#
		None	36"	S7L/36090D	<input type="checkbox"/>	20.0#
		None	42"	S7L/42090D	<input type="checkbox"/>	24.0#
 LTACU	Individual Drawer Lock and Security Shelf • Use on 7-1/2", 9", 12", 13-1/2" and 15" drawers • Not designed for receding door applications or 10-1/2" drawers • Includes 20-gauge security shelf, drawer lock and all necessary installation hardware • Must be factory installed • Does not increase insert height	None	30"	S7L/30DL		6.0#
		None	36"	S7L/36DL		7.0#
		None	42"	S7L/42DL		8.0#
 LTACU	10-1/2" High Drawer • For letter or legal size materials • All internal accessories must be specified separately • Will not accept plate dividers	None	30"	S7L/30105D	<input type="checkbox"/>	23.0#
		None	36"	S7L/36105D	<input type="checkbox"/>	25.0#
		None	42"	S7L/42105D	<input type="checkbox"/>	30.0#

A

B

HOW TO ORDER

Indicate the following information on order form:

- Quantity of each item.
- Model number, including options. See "How To Build a Model Number".
- Any special service required.

Note: • The indicates that a choice is required.

- The absence of the indicates that no choice is required.
- Alpha-numeric characters in place of indicate that no other alternatives are available.

HOW TO BUILD A MODEL NUMBER

- A** Select basic model.
- B** Select drawer color.
Refer to color addendum at ki.com or KI Fabrics & Finishes binder.



Custom-Built Lateral Files

700 Series® Drawers

Delivered Pricing

\$ 233
247
259

\$ 212
232
250

\$ 228
248
267

\$ 250
276
312

\$ 143
143
143

\$ 217
242
276

SPECIAL SERVICES

Special Carton Marking

With specially marked information N/C

Shipping

Shipped **assembled freight prepaid f.o.b.**
Pembroke, Ontario K8A 0E1 factory.
Freight class #70.

Specifications and prices are subject to
change without prior notice.

Custom-Built Lateral Files

700 Series® Drawers

	MODEL	Accessories Included	W	MODEL NUMBER		Approx. Packaged Weight
				Basic Model	Unit Color	
LTACU	10-1/2" High Drawer with Folder Bars • Includes FBA folder bars for side-to-side legal or letter hanging files • Will not accept plate dividers	FBA bars	30"	S7L/30105DA	<input type="checkbox"/>	27.0#
		FBA bars	36"	S7L/36105DA	<input type="checkbox"/>	29.0#
		FBA bars	42"	S7L/42105DA	<input type="checkbox"/>	34.0#

A

B

HOW TO ORDER

Indicate the following information on order form:

1. Quantity of each item.
2. Model number, including options. See "How To Build a Model Number".
3. Any special service required.

Note: • The indicates that a choice is required.

- The absence of the indicates that no choice is required.
- Alpha-numeric characters in place of indicate that no other alternatives are available.

HOW TO BUILD A MODEL NUMBER

A Select basic model.

B Select drawer color.
Refer to color addendum at ki.com or KI Fabrics & Finishes binder.



Custom-Built Lateral Files

700 Series® Drawers

Delivered
Pricing

\$ 242

276

305

SPECIAL SERVICES

Special Carton Marking

With specially marked information N/C



Shipping

Shipped **assembled freight prepaid f.o.b.**
Pembroke, Ontario K8A 0E1 factory.
Freight class #70.

Specifications and prices are subject to
change without prior notice.

Custom-Built Lateral Files

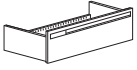
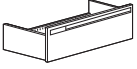
700 Series® Drawers

	MODEL	Accessories Included	W	MODEL NUMBER		Approx. Packaged Weight
				Basic Model	Unit Color	
 LTACU	12" High Drawer • For letter or legal size materials • All internal accessories must be specified separately	None	30"	S7L/30120D	<input type="checkbox"/>	23.0#
		None	36"	S7L/36120D	<input type="checkbox"/>	25.0#
		None	42"	S7L/42120D	<input type="checkbox"/>	30.0#
LTACU	12" High Drawer with Folder Bars • Includes FBA folder bars for side-to-side legal or letter hanging files	FBA bars	30"	S7L/30120DA	<input type="checkbox"/>	27.0#
		FBA bars	36"	S7L/36120DA	<input type="checkbox"/>	29.0#
		FBA bars	42"	S7L/42120DA	<input type="checkbox"/>	34.0#
 LTACU	13-1/2" High Drawer • For letter, legal and computer print-out hanging storage • All internal accessories must be specified separately	None	30"	S7L/30135D	<input type="checkbox"/>	24.0#
		None	36"	S7L/36135D	<input type="checkbox"/>	27.0#
		None	42"	S7L/42135D	<input type="checkbox"/>	31.0#
LTACU	13-1/2" High Drawer with Folder Bars • Includes FBA folder bars for side-to-side legal or letter hanging files	FBA bars	30"	S7L/30135DA	<input type="checkbox"/>	24.0#
		FBA bars	36"	S7L/36135DA	<input type="checkbox"/>	27.0#
		FBA bars	42"	S7L/42135DA	<input type="checkbox"/>	31.0#
LTACU	13-1/2" High Drawer with Folder Bars • For letter, legal and computer print-out hanging storage • Includes EDP folder bars for side-to-side hanging print-out files	FBE bars	30"	S7L/30135DE	<input type="checkbox"/>	30.0#
		FBE bars	36"	S7L/36135DE	<input type="checkbox"/>	33.0#
		FBE bars	42"	S7L/42135DE	<input type="checkbox"/>	37.0#
 LTACU	15" High Drawer • For EDP print-out storage when specified with E-style folder bars • All internal accessories must be specified separately	None	30"	S7L/30150D	<input type="checkbox"/>	24.0#
		None	36"	S7L/36150D	<input type="checkbox"/>	27.0#
		None	42"	S7L/42150D	<input type="checkbox"/>	31.0#
LTACU	15" High Drawer with Folder Bars • For EDP print-out storage • Includes EDP folder bars for side-to-side hanging print-out files	FBE bars	30"	S7L/30150DE	<input type="checkbox"/>	30.0#
		FBE bars	36"	S7L/36150DE	<input type="checkbox"/>	33.0#
		FBE bars	42"	S7L/42150DE	<input type="checkbox"/>	37.0#

A

B

HOW TO ORDER

Indicate the following information on order form:

- Quantity of each item.
- Model number, including options. See "How To Build a Model Number".
- Any special service required.

Note: • The indicates that a choice is required.

- The absence of the indicates that no choice is required.
- Alpha-numeric characters in place of indicate that no other alternatives are available.

HOW TO BUILD A MODEL NUMBER

- A** Select basic model.
- B** Select drawer color.
Refer to color addendum at ki.com or KI Fabrics & Finishes binder.



Custom-Built Lateral Files

700 Series® Drawers

Delivered Pricing

\$ 217
242
276

\$ 242
276
305

\$ 242
280
317

\$ 271
310
345

\$ 313
346
402

\$ 242
280
317

\$ 313
346
402

SPECIAL SERVICES

Special Carton Marking

With specially marked information N/C



Shipping

Shipped **assembled freight prepaid f.o.b. Pembroke, Ontario K8A 0E1** factory.
Freight class #70.

Specifications and prices are subject to change without prior notice.

Custom-Built Lateral Files

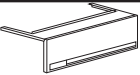
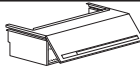
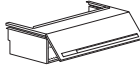
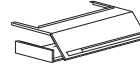
700 Series® Receding Doors and Shelves

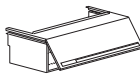
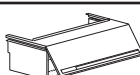
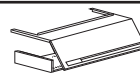
	MODEL	Components Included	W	MODEL NUMBER		Approx. Packaged Weight
				Basic Model	Unit Color	
	12" High Receding Door • All internal accessories must be ordered separately	None	30"	S7L/30120R	<input type="checkbox"/>	9.0#
		None	36"	S7L/36120R	<input type="checkbox"/>	10.0#
		None	42"	S7L/42120R	<input type="checkbox"/>	11.0#
LTACU						
	12" High Receding Door w/Rollout Shelf • All additional internal accessories must be ordered separately	Rollout shelf	30"	S7L/30120RS	<input type="checkbox"/>	26.0#
		Rollout shelf	36"	S7L/36120RS	<input type="checkbox"/>	28.0#
		Rollout shelf	42"	S7L/42120RS	<input type="checkbox"/>	31.0#
LTACU						
	12" High Receding Door w/Rollout Shelf and Bars • Includes FBA folder bars for side-to-side legal or letter hanging files	Shelf/FBA bars	30"	S7L/30120RSA	<input type="checkbox"/>	30.0#
		Shelf/FBA bars	36"	S7L/36120RSA	<input type="checkbox"/>	32.0#
		Shelf/FBA bars	42"	S7L/42120RSA	<input type="checkbox"/>	35.0#
LTACU						
	12" High Receding Door w/End Tab Filing Shelf and 3 Dividers • Includes 3 dividers	Shelf/Dividers	30"	S7L/30120RED	<input type="checkbox"/>	17.0#
		Shelf/Dividers	36"	S7L/36120RED	<input type="checkbox"/>	20.0#
		Shelf/Dividers	42"	S7L/42120RED	<input type="checkbox"/>	22.0#
LTACU						
	13-1/2" High Receding Door • All internal accessories must be ordered separately	None	30"	S7L/30135R	<input type="checkbox"/>	9.0#
		None	36"	S7L/36135R	<input type="checkbox"/>	10.0#
		None	42"	S7L/42135R	<input type="checkbox"/>	11.0#
LTACU						
	13-1/2" High Receding Door w/Rollout Shelf • All additional internal accessories must be ordered separately • Will not accept EDP folder bars	Rollout shelf	30"	S7L/30135RS	<input type="checkbox"/>	26.0#
		Rollout shelf	36"	S7L/36135RS	<input type="checkbox"/>	28.0#
		Rollout shelf	42"	S7L/42135RS	<input type="checkbox"/>	31.0#
LTACU						
	13-1/2" High Receding Door w/Rollout Shelf and Bars • Includes FBA folder bars for side-to-side legal or letter hanging files	Shelf/FBA bars	30"	S7L/30135RSA	<input type="checkbox"/>	32.0#
		Shelf/FBA bars	36"	S7L/36135RSA	<input type="checkbox"/>	34.0#
		Shelf/FBA bars	42"	S7L/42135RSA	<input type="checkbox"/>	37.0#
LTACU						
	13-1/2" High Receding Door w/End Tab Filing Shelf and 3 Dividers • Includes 3 dividers	Shelf/Dividers	30"	S7L/30135RED	<input type="checkbox"/>	18.0#
		Shelf/Dividers	36"	S7L/36135RED	<input type="checkbox"/>	21.0#
		Shelf/Dividers	42"	S7L/42135RED	<input type="checkbox"/>	23.0#
LTACU						

A

B

HOW TO ORDER

Indicate the following information on order form:

- Quantity of each item.
- Model number, including options. See "How To Build a Model Number".
- Any special service required.

Note: • The indicates that a choice is required.

- The absence of the indicates that no choice is required.
- Alpha-numeric characters in place of indicate that no other alternatives are available.

HOW TO BUILD A MODEL NUMBER

- A** Select basic model.
- B** Select unit color.
Refer to color addendum at ki.com or KI Fabrics & Finishes binder.



Custom-Built Lateral Files

700 Series® Receding Doors and Shelves

Delivered Pricing

\$ 100
111
118

\$ 247
271
296

\$ 276
302
324

\$ 242
269
294

\$ 134
144
167

\$ 262
284
312

\$ 288
315
341

\$ 261
283
308

SPECIAL SERVICES

Special Carton Marking

With specially marked information N/C



Shipping

Shipped **assembled freight prepaid f.o.b. Pembroke, Ontario K8A 0E1** factory.
Freight class #70.

Specifications and prices are subject to change without prior notice.

Custom-Built Lateral Files

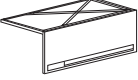
700 Series® Receding Doors and Shelves

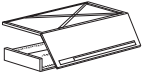
	MODEL	Components Included	W	MODEL NUMBER		Approx. Packaged Weight
				Basic Model	Unit Color	
	15" High Receding Door • All internal accessories must be ordered separately	None	30"	S7L/30150R	<input type="checkbox"/>	11.0#
		None	36"	S7L/36150R	<input type="checkbox"/>	13.0#
		None	42"	S7L/42150R	<input type="checkbox"/>	15.0#
LTACU						
	15" High Receding Door w/Rollout Shelf • All additional internal accessories must be ordered separately	Rollout shelf	30"	S7L/30150RS	<input type="checkbox"/>	28.0#
		Rollout shelf	36"	S7L/36150RS	<input type="checkbox"/>	31.0#
		Rollout shelf	42"	S7L/42150RS	<input type="checkbox"/>	35.0#
LTACU						
	15" High Receding Door w/Rollout Shelf and Bars • Includes EDP folder bars for side-to-side hanging print-out files	Shelf/FBE bars	30"	S7L/30150RSE	<input type="checkbox"/>	34.0#
		Shelf/FBE bars	36"	S7L/36150RSE	<input type="checkbox"/>	37.0#
		Shelf/FBE bars	42"	S7L/42150RSE	<input type="checkbox"/>	41.0#
LTACU						
	15" High Receding Door w/End Tab Filing Shelf and 3 Dividers • Includes 3 dividers	Shelf/Dividers	30"	S7L/30150RED	<input type="checkbox"/>	19.0#
		Shelf/Dividers	36"	S7L/36150RED	<input type="checkbox"/>	23.0#
		Shelf/Dividers	42"	S7L/42150RED	<input type="checkbox"/>	26.0#
LTACU						

A

B

HOW TO ORDER

Indicate the following information on order form:

- Quantity of each item.
- Model number, including options. See "How To Build a Model Number".
- Any special service required.

Note: • The indicates that a choice is required.
• The absence of the indicates that no choice is required.
• Alpha-numeric characters in place of indicate that no other alternatives are available.

HOW TO BUILD A MODEL NUMBER

- A** Select basic model.
- B** Select unit color.
Refer to color addendum at ki.com or KI Fabrics & Finishes binder.



Custom-Built Lateral Files

700 Series® Receding Doors and Shelves

Delivered
Pricing

\$ 134
144
167

\$ 296
341
385

\$ 380
422
426

\$ 300
342
387

SPECIAL SERVICES

Special Carton Marking

With specially marked information N/C

Shipping

Shipped **assembled freight prepaid f.o.b.**
Pembroke, Ontario K8A 0E1 factory.
Freight class #70.

Specifications and prices are subject to
change without prior notice.

Custom-Built Lateral Files

700 Series® Shelves

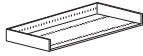
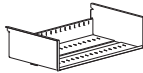
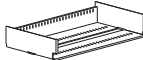
		MODEL	W	MODEL NUMBER		Approx. Packaged Weight
				Basic Model	Unit Color	
 LTACU	1-1/2" Posting Shelf <ul style="list-style-type: none"> Use in place of 1-1/2" tie bar or to occupy 1-1/2" of internal space in shorter cabinets Cannot be specified in bottom of cabinet Cannot be located above filler 	30"	S7L/3015PS	<input type="checkbox"/>	9.0#	
		36"	S7L/3615PS	<input type="checkbox"/>	12.0#	
		42"	S7L/4215PS	<input type="checkbox"/>	15.0#	
 LTACU	6" Rollout Shelf <ul style="list-style-type: none"> Accepts 3346DV dividers - slotted on 1/2" centers Multiples may be installed behind larger receding doors All internal accessories must be specified separately Black finish only Does not increase insert height 	30"	S7L/30060S		14.0#	
		36"	S7L/36060S		15.0#	
		42"	S7L/42060S		16.0#	
 LTACU	12" Rollout Shelf <ul style="list-style-type: none"> Accepts 33412DV dividers - slotted on 1/2" centers Accepts hanging folder bars All internal accessories must be specified separately Black finish only Does not increase insert height Can be used for End-Tab Filing with 3312DV dividers Can be used for Binder Storage with 3312DV dividers 	30"	S7L/30120S		17.0#	
		36"	S7L/36120S		18.0#	
		42"	S7L/42120S		19.0#	
 LTACU	Fixed End Tab Filing Shelf <ul style="list-style-type: none"> Accepts 33412DV dividers For use behind 12", 13-1/2" or 15" receding doors All internal accessories must be specified separately Black finish only Does not increase insert height 	30"	S7L/30ETS		8.0#	
		36"	S7L/36ETS		10.0#	
		42"	S7L/42ETS		11.0#	

A

B

HOW TO ORDER

Indicate the following information on order form:

- Quantity of each item.
- Model number, including options. See "How To Build a Model Number".
- Any special service required.

Note: • The indicates that a choice is required.

- The absence of the indicates that no choice is required.
- Alpha-numeric characters in place of indicate that no other alternatives are available.

HOW TO BUILD A MODEL NUMBER

- A** Select basic model.
- B** Select unit color.
Refer to color addendum at ki.com or KI Fabrics & Finishes binder.



Custom-Built Lateral Files

700 Series® Shelves

Delivered
Pricing

\$ 166
166
166

\$ 153
167
181

\$ 164
175
190

\$ 112
126
142

SPECIAL SERVICES

Special Carton Marking

With specially marked information N/C

Shipping

Shipped **assembled freight prepaid f.o.b. Pembroke, Ontario K8A 0E1** factory.
Freight class #70.

Specifications and prices are subject to change without prior notice.

Custom-Built Lateral Files

700 Series® Shelves

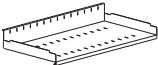
		MODEL NUMBER		Approx. Packaged Weight
MODEL	W	Basic Model		
LTACU	Fixed End Tab Cupboard Shelf • End tab shelf for cupboards only • Black finish only • Does not increase insert height	30"	S7L/30ETSC	8.0#
		36"	S7L/36ETSC	10.0#
		42"	S7L/42ETSC	11.0#
LTACU	 Adjustable Blank Shelf • May be installed behind hinged or receding doors • Black finish only • Does not increase height • Brackets included	30"	S7L/30BS	6.0#
		36"	S7L/36BS	7.0#
		42"	S7L/42BS	8.0#
LTACU	 Slotted Shelf • Accepts 33412DV dividers • May be installed behind 12", 13-1/2" or 15" receding doors or hinged cupboard doors • All internal accessories must be specified separately • Black finish only • Does not increase insert height • Brackets included	30"	S7L/30SS	8.0#
		36"	S7L/36SS	10.0#
		42"	S7L/42SS	11.0#

A

HOW TO ORDER

Indicate the following information on order form:

1. Quantity of each item.
2. Model number, including options. See "How To Build a Model Number".
3. Any special service required.

Note:

- The indicates that a choice is required.
- The absence of the indicates that no choice is required.
- Alpha-numeric characters in place of indicate that no other alternatives are available.

HOW TO BUILD A MODEL NUMBER

A Select basic model.



Custom-Built Lateral Files

700 Series® Shelves

Delivered
Pricing

\$ 116

131

148

\$ 83

83

83

\$ 116

116

116

SPECIAL SERVICES

Special Carton Marking

With specially marked information N/C

Shipping

Shipped **assembled freight prepaid f.o.b. Pembroke, Ontario K8A 0E1** factory.
Freight class #70.

Specifications and prices are subject to change without prior notice.

Custom-Built Lateral Files

Accessories

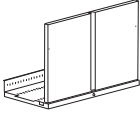
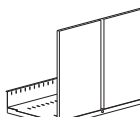
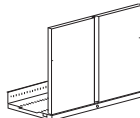
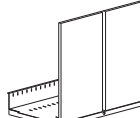
	MODEL	W	MODEL NUMBER			Approx. Packaged Weight
			Basic Model	Unit Color	Key Option	
 <p>LTACU</p>	25-1/2" Hinged Door Insert <ul style="list-style-type: none"> • 24" hinged doors, 1-1/2" locking tie bar shelf • Must be located at top of cabinet shell • Bottom shelf slotted to accept 33412DV plate dividers (not included) • All internal accessories must be specified separately • Two locks per unit 	30"	S7L/30255MHX	<input type="checkbox"/>	<input type="checkbox"/>	30.0#
		36"	S7L/36255MHX	<input type="checkbox"/>	<input type="checkbox"/>	35.0#
		42"	S7L/42255MHX	<input type="checkbox"/>	<input type="checkbox"/>	40.0#
 <p>LTACU</p>	30" Hinged Door Insert <ul style="list-style-type: none"> • 28-1/2" hinged doors, 1-1/2" locking tie bar shelf • Must be located at top of cabinet shell • Bottom shelf slotted to accept 33412DV plate dividers (not included) • All internal accessories must be specified separately • Two locks per unit 	30"	S7L/30300MHX	<input type="checkbox"/>	<input type="checkbox"/>	34.0#
		36"	S7L/36300MHX	<input type="checkbox"/>	<input type="checkbox"/>	39.0#
		42"	S7L/42300MHX	<input type="checkbox"/>	<input type="checkbox"/>	44.0#
 <p>LTACU</p>	31-1/2" Hinged Door Insert <ul style="list-style-type: none"> • 30" hinged doors, 1-1/2" locking tie bar shelf • Must be located at top of cabinet shell • Bottom shelf slotted to accept 33412DV plate dividers (not included) • All internal accessories must be specified separately • Two locks per unit 	30"	S7L/30315MHX	<input type="checkbox"/>	<input type="checkbox"/>	35.0#
		36"	S7L/36315MHX	<input type="checkbox"/>	<input type="checkbox"/>	40.0#
		42"	S7L/42315MHX	<input type="checkbox"/>	<input type="checkbox"/>	45.0#
 <p>LTACU</p>	33" Hinged Door Insert <ul style="list-style-type: none"> • 31-1/2" hinged doors, 1-1/2" locking tie bar shelf • Must be located at top of cabinet shell • Bottom shelf slotted to accept 33412DV plate dividers (not included) • All internal accessories must be specified separately • Two locks per unit 	30"	S7L/30330MHX	<input type="checkbox"/>	<input type="checkbox"/>	37.0#
		36"	S7L/36330MHX	<input type="checkbox"/>	<input type="checkbox"/>	42.0#
		42"	S7L/42330MHX	<input type="checkbox"/>	<input type="checkbox"/>	47.0#

A **B** **C**

HOW TO ORDER

Indicate the following information on order form:

1. Quantity of each item.
2. Model number, including options. See "How To Build a Model Number".
3. Any special service required.

Note: • The indicates that a choice is required.

- The absence of the indicates that no choice is required.
- Alpha-numeric characters in place of indicate that no other alternatives are available.

HOW TO BUILD A MODEL NUMBER

- A** Select basic model.
- B** Select unit color.
Refer to color addendum at ki.com or KI Fabrics & Finishes binder.
- C** Select key option.

KA	- Key alike
KS	- Key standard
NLC	- No lock core



Custom-Built Lateral Files

Accessories

Delivered
Pricing

\$ 572
609
650

\$ 462
483
516

\$ 588
625
664

\$ 468
489
522

SPECIAL SERVICES

Special Carton Marking

With specially marked information N/C

Shipping

Shipped **assembled freight prepaid f.o.b. Pembroke, Ontario K8A 0E1** factory.
Freight class #70.

Specifications and prices are subject to change without prior notice.

Custom-Built Lateral Files

Accessories

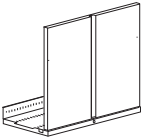
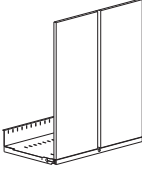
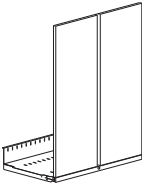
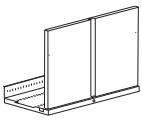
	MODEL	W	MODEL NUMBER			Approx. Packaged Weight
			Basic Model	Unit Color	Key Option	
 <p>LTACU</p>	37-1/2" Hinged Door Insert	30"	S7L/30375MHX	<input type="checkbox"/> <input type="checkbox"/>	<input type="checkbox"/> <input type="checkbox"/> <input type="checkbox"/>	40.0#
	<ul style="list-style-type: none"> • 36" hinged doors, 1-1/2" locking tie bar shelf • Must be located at top of cabinet shell • Bottom shelf slotted to accept 33412DV plate dividers (not included) • All internal accessories must be specified separately • Two locks per unit 	36"	S7L/36375MHX	<input type="checkbox"/> <input type="checkbox"/>	<input type="checkbox"/> <input type="checkbox"/> <input type="checkbox"/>	45.0#
		42"	S7L/42375MHX	<input type="checkbox"/> <input type="checkbox"/>	<input type="checkbox"/> <input type="checkbox"/> <input type="checkbox"/>	50.0#
 <p>LTACU</p>	45" Hinged Door Insert	30"	S7L/30450MHX	<input type="checkbox"/> <input type="checkbox"/>	<input type="checkbox"/> <input type="checkbox"/> <input type="checkbox"/>	47.0#
	<ul style="list-style-type: none"> • 43-1/2" hinged doors, 1-1/2" locking tie bar shelf • Must be located at top of cabinet shell • Bottom shelf slotted to accept 33412DV plate dividers (not included) • All internal accessories must be specified separately • Two locks per unit 	36"	S7L/36450MHX	<input type="checkbox"/> <input type="checkbox"/>	<input type="checkbox"/> <input type="checkbox"/> <input type="checkbox"/>	52.0#
		42"	S7L/42450MHX	<input type="checkbox"/> <input type="checkbox"/>	<input type="checkbox"/> <input type="checkbox"/> <input type="checkbox"/>	57.0#
 <p>LTACU</p>	49-1/2" Hinged Door Insert	30"	S7L/30495MHX	<input type="checkbox"/> <input type="checkbox"/>	<input type="checkbox"/> <input type="checkbox"/> <input type="checkbox"/>	50.0#
	<ul style="list-style-type: none"> • 48" hinged doors, 1-1/2" locking tie bar shelf • Must be located at top of cabinet shell • Bottom shelf slotted to accept 33412DV plate dividers (not included) • All internal accessories must be specified separately • Two locks per unit 	36"	S7L/36495MHX	<input type="checkbox"/> <input type="checkbox"/>	<input type="checkbox"/> <input type="checkbox"/> <input type="checkbox"/>	55.0#
		42"	S7L/42495MHX	<input type="checkbox"/> <input type="checkbox"/>	<input type="checkbox"/> <input type="checkbox"/> <input type="checkbox"/>	60.0#
 <p>LTACU</p>	25-1/2" Hinged Markerboard Door Insert	30"	S7L/30255MHXMB	<input type="checkbox"/> <input type="checkbox"/>	<input type="checkbox"/> <input type="checkbox"/> <input type="checkbox"/>	30.0#
	<ul style="list-style-type: none"> • 24" hinged markerboard door, 1-1/2" locking tie bar shelf • Must be located at top of cabinet shell • Bottom shelf slotted to accept 33412DV plate dividers (not included) • All internal accessories must be specified separately • Two locks per unit 	36"	S7L/36255MHXMB	<input type="checkbox"/> <input type="checkbox"/>	<input type="checkbox"/> <input type="checkbox"/> <input type="checkbox"/>	35.0#
		42"	S7L/42255MHXMB	<input type="checkbox"/> <input type="checkbox"/>	<input type="checkbox"/> <input type="checkbox"/> <input type="checkbox"/>	40.0#

A **B** **C**

HOW TO ORDER

Indicate the following information on order form:

1. Quantity of each item.
2. Model number, including options. See "How To Build a Model Number".
3. Any special service required.

Note: • The indicates that a choice is required.

- The absence of the indicates that no choice is required.
- Alpha-numeric characters in place of indicate that no other alternatives are available.

HOW TO BUILD A MODEL NUMBER

- A** Select basic model.
- B** Select unit color.
Refer to color addendum at ki.com or KI Fabrics & Finishes binder.
- C** Select key option.

KA	- Key alike
KS	- Key standard
NLC	- No lock core



Custom-Built Lateral Files

Accessories

Delivered
Pricing

\$ 715
754
797

\$ 544
571
589

\$ 561
597
625

\$ 855
976
1097

SPECIAL SERVICES

Special Carton Marking

With specially marked information N/C

Shipping

Shipped **assembled freight prepaid f.o.b.**
Pembroke, Ontario K8A 0E1 factory.
Freight class #70.

Specifications and prices are subject to
change without prior notice.

Custom-Built Lateral Files

Accessories

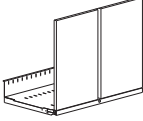
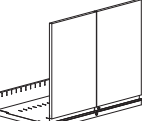
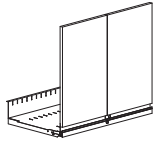
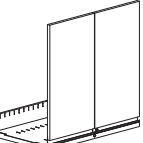
		MODEL NUMBER			Approx. Packaged Weight	
		MODEL	W	Basic Model		Unit Color
 <p>LTACU</p>	30" Hinged Markerboard Door Insert	30"	S7L/30300MHXMB	<input type="checkbox"/>	<input type="checkbox"/>	34.0#
	<ul style="list-style-type: none"> • 28-1/2" hinged markerboard door, 1-1/2" locking tie bar shelf • Must be located at top of cabinet shell • Bottom shelf slotted to accept 33412DV plate dividers (not included) • All internal accessories must be specified separately • Two locks per unit 	36"	S7L/36300MHXMB	<input type="checkbox"/>	<input type="checkbox"/>	39.0#
		42"	S7L/42300MHXMB	<input type="checkbox"/>	<input type="checkbox"/>	44.0#
 <p>LTACU</p>	31-1/2" Hinged Markerboard Door Insert	30"	S7L/30315MHXMB	<input type="checkbox"/>	<input type="checkbox"/>	35.0#
	<ul style="list-style-type: none"> • 30" hinged markerboard door, 1-1/2" locking tie bar shelf • Must be located at top of cabinet shell • Bottom shelf slotted to accept 33412DV plate dividers (not included) • All internal accessories must be specified separately • Two locks per unit 	36"	S7L/36315MHXMB	<input type="checkbox"/>	<input type="checkbox"/>	40.0#
		42"	S7L/42315MHXMB	<input type="checkbox"/>	<input type="checkbox"/>	45.0#
 <p>LTACU</p>	33" Hinged Markerboard Door Insert	30"	S7L/30330MHXMB	<input type="checkbox"/>	<input type="checkbox"/>	37.0#
	<ul style="list-style-type: none"> • 31-1/2" hinged markerboard door, 1-1/2" locking tie bar shelf • Must be located at top of cabinet shell • Bottom shelf slotted to accept 33412DV plate dividers (not included) • All internal accessories must be specified separately • Two locks per unit 	36"	S7L/36330MHXMB	<input type="checkbox"/>	<input type="checkbox"/>	42.0#
		42"	S7L/42330MHXMB	<input type="checkbox"/>	<input type="checkbox"/>	47.0#
 <p>LTACU</p>	37-1/2" Hinged Markerboard Door Insert	30"	S7L/30375MHXMB	<input type="checkbox"/>	<input type="checkbox"/>	40.0#
	<ul style="list-style-type: none"> • 36" hinged markerboard door, 1-1/2" locking tie bar shelf • Must be located at top of cabinet shell • Bottom shelf slotted to accept 33412DV plate dividers (not included) • All internal accessories must be specified separately • Two locks per unit 	36"	S7L/36375MHXMB	<input type="checkbox"/>	<input type="checkbox"/>	45.0#
		42"	S7L/42375MHXMB	<input type="checkbox"/>	<input type="checkbox"/>	50.0#

A **B** **C**

HOW TO ORDER

Indicate the following information on order form:

1. Quantity of each item.
2. Model number, including options. See "How To Build a Model Number".
3. Any special service required.

Note: • The indicates that a choice is required.

- The absence of the indicates that no choice is required.
- Alpha-numeric characters in place of indicate that no other alternatives are available.

HOW TO BUILD A MODEL NUMBER

- A** Select basic model.
- B** Select unit color.
Refer to color addendum at ki.com or KI Fabrics & Finishes binder.
- C** Select key option.

KA	- Key alike
KS	- Key standard
NLC	- No lock core



Custom-Built Lateral Files

Accessories

Delivered
Pricing

\$ 961
1102
1243

\$ 998
1144
1296

\$ 1032
1189
1345

\$ 1140
1316
1497

SPECIAL SERVICES

Special Carton Marking

With specially marked information N/C

Shipping

Shipped **assembled freight prepaid f.o.b. Pembroke, Ontario K8A 0E1** factory. Freight class #70.

Specifications and prices are subject to change without prior notice.

Custom-Built Lateral Files

Accessories

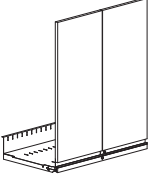
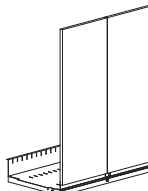
	MODEL	W	MODEL NUMBER			Approx. Packaged Weight
			Basic Model	Unit Color	Key Option	
 <p>LTACU</p>	45" Hinged Markerboard Door Insert • 43-1/2" hinged markerboard door, 1-1/2" locking tie bar shelf • Must be located at top of cabinet shell • Bottom shelf slotted to accept 33412DV plate dividers (not included) • All internal accessories must be specified separately • Two locks per unit	30"	S7L/30450MHXMB	<input type="checkbox"/> <input type="checkbox"/>	<input type="checkbox"/> <input type="checkbox"/> <input type="checkbox"/>	47.0#
		36"	S7L/36450MHXMB	<input type="checkbox"/> <input type="checkbox"/>	<input type="checkbox"/> <input type="checkbox"/> <input type="checkbox"/>	52.0#
		42"	S7L/42450MHXMB	<input type="checkbox"/> <input type="checkbox"/>	<input type="checkbox"/> <input type="checkbox"/> <input type="checkbox"/>	57.0#
 <p>LTACU</p>	49-1/2" Hinged Markerboard Door Insert • 48" hinged markerboard door, 1-1/2" locking tie bar shelf • Must be located at top of cabinet shell • Bottom shelf slotted to accept 33412DV plate dividers (not included) • All internal accessories must be specified separately • Two locks per unit	30"	S7L/30495MHXMB	<input type="checkbox"/> <input type="checkbox"/>	<input type="checkbox"/> <input type="checkbox"/> <input type="checkbox"/>	50.0#
		36"	S7L/36495MHXMB	<input type="checkbox"/> <input type="checkbox"/>	<input type="checkbox"/> <input type="checkbox"/> <input type="checkbox"/>	55.0#
		42"	S7L/42495MHXMB	<input type="checkbox"/> <input type="checkbox"/>	<input type="checkbox"/> <input type="checkbox"/> <input type="checkbox"/>	60.0#

A **B** **C**

HOW TO ORDER

Indicate the following information on order form:

- Quantity of each item.
- Model number, including options. See "How To Build a Model Number".
- Any special service required.

Note: • The indicates that a choice is required.

- The absence of the indicates that no choice is required.
- Alpha-numeric characters in place of indicate that no other alternatives are available.

HOW TO BUILD A MODEL NUMBER

- A** Select basic model.
- B** Select unit color.
Refer to color addendum at ki.com or KI Fabrics & Finishes binder.
- C** Select key option.

KA	- Key alike
KS	- Key standard
NLC	- No lock core



Custom-Built Lateral Files

Accessories

Delivered
Pricing

\$ 1317

1529

1745

\$ 1423

1659

1896

SPECIAL SERVICES

Special Carton Marking

With specially marked information N/C





Shipping

Shipped **assembled freight prepaid f.o.b. Pembroke, Ontario K8A 0E1** factory.
Freight class #70.

Specifications and prices are subject to change without prior notice.

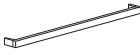
Custom-Built Lateral Files

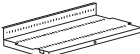
Accessories

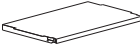
	MODEL	W	MODEL NUMBER			Approx. Packaged Weight
			Basic Model	Unit Color	Key Option	
 LTACU	1-1/2" Tie Bar • Use in 1-1/2" openings where no insert is required • Standard and included in all shells 65-9/32" and taller • Cannot be specified in bottom of cabinet or below posting shelf	30"	S7L/30015F	<input type="checkbox"/>		3.0#
		36"	S7L/36015F	<input type="checkbox"/>		3.0#
		42"	S7L/42015F	<input type="checkbox"/>		3.0#
 LTACU	1-1/2" Locking Tie Bar • Replaces standard cabinet lock and 1-1/2" tie bar • Use when lock is required at a location other than at top of cabinet • Can be installed in any position in any cabinet or below posting shelf	30"	S7L/3015LF	<input type="checkbox"/>		7.0#
		36"	S7L/3615LF	<input type="checkbox"/>		10.0#
		42"	S7L/4215LF	<input type="checkbox"/>		13.0#
 LTACU	1-1/2" Tie Bar Shelf • To be installed below receding door for binder storage • Use in place of 1-1/2" tie bar • Will accept 33412DV plate dividers (not included)	30"	S7L/3015FS	<input type="checkbox"/>		9.0#
		36"	S7L/3615FS	<input type="checkbox"/>		12.0#
		42"	S7L/4215FS	<input type="checkbox"/>		15.0#
 LTACU	1-1/2" Locking Tie Bar Shelf • To be installed below receding door for binder storage • Use in place of 1-1/2" locking tie bar • Will accept 33412DV plate dividers (not included)	30"	S7L/3015LFS	<input type="checkbox"/>	<input type="checkbox"/>	11.0#
		36"	S7L/3615LFS	<input type="checkbox"/>	<input type="checkbox"/>	14.0#
		42"	S7L/4215LFS	<input type="checkbox"/>	<input type="checkbox"/>	17.0#
 LTACU	Blank Filler Shelf • Can be used in place of tie bar shelf • No slots for dividers	30"	S7L/3015BFS	<input type="checkbox"/>		9.0#
		36"	S7L/3615BFS	<input type="checkbox"/>		12.0#
		42"	S7L/4215BFS	<input type="checkbox"/>		15.0#
 LTACU	Locking Blank Filler Shelf • Can be used in place of tie bar shelf • No slots for dividers	30"	S7L/3015BLFS	<input type="checkbox"/>		9.0#
		36"	S7L/3615BLFS	<input type="checkbox"/>		12.0#
		42"	S7L/4215BLFS	<input type="checkbox"/>		15.0#

A

B

C

HOW TO ORDER

Indicate the following information on order form:

- Quantity of each item.
- Model number, including options. See "How To Build a Model Number".
- Any special service required.

Note: • The indicates that a choice is required.

- The absence of the indicates that no choice is required.
- Alpha-numeric characters in place of indicate that no other alternatives are available.

HOW TO BUILD A MODEL NUMBER

A Select basic model.

B Select unit color.
Refer to color addendum at ki.com or KI Fabrics & Finishes binder.

C Select key option.

KA	- Key alike
KS	- Key standard
NLC	- No lock core



Custom-Built Lateral Files

Accessories

Delivered
Pricing

\$ 54
54
54

\$ 136
136
136

\$ 143
143
143

\$ 171
171
171

\$ 140
144
156

\$ 179
182
204

SPECIAL SERVICES

Special Carton Marking

With specially marked information N/C

Shipping

Shipped **assembled freight prepaid f.o.b.**
Pembroke, Ontario K8A 0E1 factory.
Freight class #70.

Specifications and prices are subject to
change without prior notice.

Custom-Built Laminate Tops

700 Series® Lateral Files

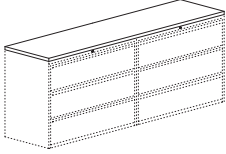
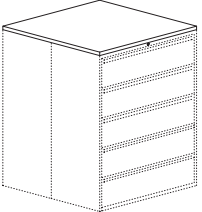
	Features	W x D x H	MODEL NUMBER				Approx. Packaged Weight
			Basic Model	Edge Style	Surface Finish	Edge Color	
 <p>S7TP Laminate Top for Side-by-Side Units</p> <ul style="list-style-type: none"> • Tops are manufactured to allow for 1/16" overhang on all sides. • Do not specify individual tops when ganging multiple units due to the 1/16" overhang. Specify proper size top for correct configuration and alignment. 	Fits one 30" wide lateral	30 X 18 X 1-1/4"	S7L/3018T	<input type="checkbox"/> <input type="checkbox"/>	<input type="checkbox"/> <input type="checkbox"/>	<input type="checkbox"/> <input type="checkbox"/>	18.0#
	Fits one 36" wide lateral	36 X 18 X 1-1/4"	S7L/3618T	<input type="checkbox"/> <input type="checkbox"/>	<input type="checkbox"/> <input type="checkbox"/>	<input type="checkbox"/> <input type="checkbox"/>	21.0#
	Fits one 42" wide lateral	42 X 18 X 1-1/4"	S7L/4218T	<input type="checkbox"/> <input type="checkbox"/>	<input type="checkbox"/> <input type="checkbox"/>	<input type="checkbox"/> <input type="checkbox"/>	25.0#
	Fits two 30" wide laterals	60 X 18 X 1-1/4"	S7L/6018T	<input type="checkbox"/> <input type="checkbox"/>	<input type="checkbox"/> <input type="checkbox"/>	<input type="checkbox"/> <input type="checkbox"/>	36.0#
	Fits one 30" & one 36" wide laterals	66 X 18 X 1-1/4"	S7L/6618T	<input type="checkbox"/> <input type="checkbox"/>	<input type="checkbox"/> <input type="checkbox"/>	<input type="checkbox"/> <input type="checkbox"/>	39.0#
	Fits two 36" or one 30" & one 42" laterals	72 X 18 X 1-1/4"	S7L/7218T	<input type="checkbox"/> <input type="checkbox"/>	<input type="checkbox"/> <input type="checkbox"/>	<input type="checkbox"/> <input type="checkbox"/>	43.0#
	Fits one 36" & one 42" wide laterals	78 X 18 X 1-1/4"	S7L/7818T	<input type="checkbox"/> <input type="checkbox"/>	<input type="checkbox"/> <input type="checkbox"/>	<input type="checkbox"/> <input type="checkbox"/>	46.0#
	Fits two 42" wide laterals	84 X 18 X 1-1/4"	S7L/8418T	<input type="checkbox"/> <input type="checkbox"/>	<input type="checkbox"/> <input type="checkbox"/>	<input type="checkbox"/> <input type="checkbox"/>	50.0#
	Fits three 30" wide laterals	90 X 18 X 1-1/4"	S7L/9018T	<input type="checkbox"/> <input type="checkbox"/>	<input type="checkbox"/> <input type="checkbox"/>	<input type="checkbox"/> <input type="checkbox"/>	53.0#
	Fits two 30" & one 42" or one 30" & two 36"	102 X 18 X 1-1/4"	S7L/10218T	<input type="checkbox"/> <input type="checkbox"/>	<input type="checkbox"/> <input type="checkbox"/>	<input type="checkbox"/> <input type="checkbox"/>	60.0#
Fits three 36" or one 30" & one 36" & one 42"	108 X 18 X 1-1/4"	S7L/10818T	<input type="checkbox"/> <input type="checkbox"/>	<input type="checkbox"/> <input type="checkbox"/>	<input type="checkbox"/> <input type="checkbox"/>	64.0#	
Fits four 30" or one 36" & two 42" laterals	120 X 18 X 1-1/4"	S7L/12018T	<input type="checkbox"/> <input type="checkbox"/>	<input type="checkbox"/> <input type="checkbox"/>	<input type="checkbox"/> <input type="checkbox"/>	71.0#	
 <p>S7TP Laminate Top for Back-to-Back Units</p> <ul style="list-style-type: none"> • Tops are manufactured to allow for 1/16" overhang on all sides. • Do not specify individual tops when ganging multiple units due to the 1/16" overhang. Specify proper size top for correct configuration and alignment. • Tops are for Standard or Flat Front units only. 	Fits two 30" wide laterals	30 X 36 X 1-1/4"	S7L/3036T	<input type="checkbox"/> <input type="checkbox"/>	<input type="checkbox"/> <input type="checkbox"/>	<input type="checkbox"/> <input type="checkbox"/>	36.0#
	Fits two 36" wide laterals	36 X 36 X 1-1/4"	S7L/3636T	<input type="checkbox"/> <input type="checkbox"/>	<input type="checkbox"/> <input type="checkbox"/>	<input type="checkbox"/> <input type="checkbox"/>	43.0#
	Fits two 42" wide laterals	42 X 36 X 1-1/4"	S7L/4236T	<input type="checkbox"/> <input type="checkbox"/>	<input type="checkbox"/> <input type="checkbox"/>	<input type="checkbox"/> <input type="checkbox"/>	50.0#
	Fits four 30" wide laterals	60 X 36 X 1-1/4"	S7L/6036T	<input type="checkbox"/> <input type="checkbox"/>	<input type="checkbox"/> <input type="checkbox"/>	<input type="checkbox"/> <input type="checkbox"/>	71.0#
	Fits four 36" wide laterals	72 X 36 X 1-1/4"	S7L/7236T	<input type="checkbox"/> <input type="checkbox"/>	<input type="checkbox"/> <input type="checkbox"/>	<input type="checkbox"/> <input type="checkbox"/>	85.0#
	Fits four 42" wide laterals	84 X 36 X 1-1/4"	S7L/8436T	<input type="checkbox"/> <input type="checkbox"/>	<input type="checkbox"/> <input type="checkbox"/>	<input type="checkbox"/> <input type="checkbox"/>	99.0#
	Fits six 30" wide laterals	90 X 36 X 1-1/4"	S7L/9036T	<input type="checkbox"/> <input type="checkbox"/>	<input type="checkbox"/> <input type="checkbox"/>	<input type="checkbox"/> <input type="checkbox"/>	106.0#
	Fits six 36" wide laterals	108 X 36 X 1-1/4"	S7L/10836T	<input type="checkbox"/> <input type="checkbox"/>	<input type="checkbox"/> <input type="checkbox"/>	<input type="checkbox"/> <input type="checkbox"/>	127.0#
			A	B	C	D	

HOW TO ORDER

Indicate the following information on order form:

1. Quantity of each item.
2. Model number, including options. See "How To Build a Model Number".
3. Any special service required.

- Note:
- The indicates that a choice is required.
 - The absence of the indicates that no choice is required.
 - Alpha-numeric characters in place of indicate that no other alternatives are available.

HOW TO BUILD A MODEL NUMBER

- A** Select basic model.
- B** Select edge style.
SE - Self Edge
74P - 74P edge
- C** Select surface finish.
Refer to color addendum at ki.com or KI Fabrics & Finishes binder.
Surface finish offerings are based on edge style selections.
- D** Select edge color.
Refer to color addendum at ki.com or KI Fabrics & Finishes binder.
Edge color offerings are based on edge style selections.



Custom-Built Laminate Tops

700 Series® Lateral Files

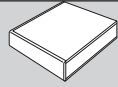
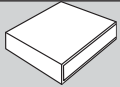

Self Edge
(SE)

74P Edge
(74P)

\$ 258	\$ 268
290	306
310	318
368	386
383	402
402	417
436	457
482	501
557	578
673	709
693	723
708	743

\$ 358	\$ 381
397	417
436	457
617	647
670	705
716	752
767	804
1118	1173

SPECIAL SERVICES

Special Carton Marking

With specially marked information N/C

Shipping

Shipped **assembled freight prepaid f.o.b. Pembroke, Ontario K8A 0E1** factory.
Freight class #70.

Specifications and prices are subject to change without prior notice.

Custom-Built Laminate Tops

700 Series® OF Storage Cabinet

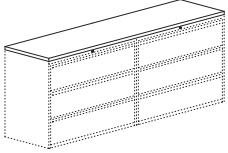
	Features	W x D x H	MODEL NUMBER				Approx. Packaged Weight
			Basic Model	Edge Style	Surface Finish	Edge Color	
 <p>S7TP</p> <p>Laminate Top for Side-by-Side Units</p> <ul style="list-style-type: none"> • High pressure laminate with particle-board core • Self edge or 74P edge available • Other sizes available upon request • Tops are manufactured to allow for 1/16" overhang on all sides. • Do not specify individual tops when ganging multiple units due to the 1/16" overhang. Specify proper size top for correct configuration and alignment. 	Fits one 30" wide optional front credenza	30 X 19 X 1-1/4"	S7L/3019T	<input type="checkbox"/> <input type="checkbox"/>	<input type="checkbox"/> <input type="checkbox"/>	<input type="checkbox"/> <input type="checkbox"/>	19.0#
	Fits one 36" wide optional front credenza	36 X 19 X 1-1/4"	S7L/3619T	<input type="checkbox"/> <input type="checkbox"/>	<input type="checkbox"/> <input type="checkbox"/>	<input type="checkbox"/> <input type="checkbox"/>	22.0#
	Fits one 42" wide optional front credenza	42 X 19 X 1-1/4"	S7L/4219T	<input type="checkbox"/> <input type="checkbox"/>	<input type="checkbox"/> <input type="checkbox"/>	<input type="checkbox"/> <input type="checkbox"/>	26.0#
	Fits two 30" wide optional front credenzas	60 X 19 X 1-1/4"	S7L/6019T	<input type="checkbox"/> <input type="checkbox"/>	<input type="checkbox"/> <input type="checkbox"/>	<input type="checkbox"/> <input type="checkbox"/>	37.0#
	Fits one 30" & one 36" wide credenza	66 X 19 X 1-1/4"	S7L/6619T	<input type="checkbox"/> <input type="checkbox"/>	<input type="checkbox"/> <input type="checkbox"/>	<input type="checkbox"/> <input type="checkbox"/>	41.0#
	Fits two 36" or one 30" & one 42" wide credenzas	72 X 19 X 1-1/4"	S7L/7219T	<input type="checkbox"/> <input type="checkbox"/>	<input type="checkbox"/> <input type="checkbox"/>	<input type="checkbox"/> <input type="checkbox"/>	45.0#
	Fits one 36" & one 42" wide credenza	78 X 19 X 1-1/4"	S7L/7819T	<input type="checkbox"/> <input type="checkbox"/>	<input type="checkbox"/> <input type="checkbox"/>	<input type="checkbox"/> <input type="checkbox"/>	48.0#
	Fits two 42" wide optional front credenzas	84 X 19 X 1-1/4"	S7L/8419T	<input type="checkbox"/> <input type="checkbox"/>	<input type="checkbox"/> <input type="checkbox"/>	<input type="checkbox"/> <input type="checkbox"/>	52.0#
	Fits three 30" wide optional front credenzas	90 X 19 X 1-1/4"	S7L/9019T	<input type="checkbox"/> <input type="checkbox"/>	<input type="checkbox"/> <input type="checkbox"/>	<input type="checkbox"/> <input type="checkbox"/>	56.0#
	Fits three 36" or one 30", 36" & 42" credenzas	108 X 19 X 1-1/4"	S7L/10819T	<input type="checkbox"/> <input type="checkbox"/>	<input type="checkbox"/> <input type="checkbox"/>	<input type="checkbox"/> <input type="checkbox"/>	67.0#
Fits four 30" or one 36" & 42" credenzas	120 X 19 X 1-1/4"	S7L/12019T	<input type="checkbox"/> <input type="checkbox"/>	<input type="checkbox"/> <input type="checkbox"/>	<input type="checkbox"/> <input type="checkbox"/>	75.0#	

A **B** **C** **D**

HOW TO ORDER

Indicate the following information on order form:

1. Quantity of each item.
2. Model number, including options. See "How To Build a Model Number".
3. Any special service required.

Note:

- The indicates that a choice is required.
- The absence of the indicates that no choice is required.
- Alpha-numeric characters in place of indicate that no other alternatives are available.

HOW TO BUILD A MODEL NUMBER

- A** Select basic model.
- B** Select edge style.

SE	- Self Edge
74P	- 74P edge
- C** Select surface finish.
 Refer to color addendum at ki.com or KI Fabrics & Finishes binder.
 Surface finish offerings are based on edge style selections.
- D** Select edge color.
 Refer to color addendum at ki.com or KI Fabrics & Finishes binder.
 Edge color offerings are based on edge style selections.



Custom-Built Laminate Tops

700 Series® OF Storage Cabinet

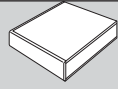
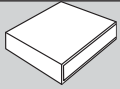

Self Edge
(SE)

74P Edge
(74P)

\$ 260	\$ 263
300	290
323	323
453	451
497	511
526	515
574	587
585	588
621	638
728	748
767	786

SPECIAL SERVICES

Special Carton Marking

With specially marked information N/C

Shipping

Shipped **assembled freight prepaid f.o.b.**
Pembroke, Ontario K8A 0E1 factory.
 Freight class #70.

Specifications and prices are subject to
 change without prior notice.

700 Series® Bookcases

General Information

GENERAL INFORMATION

KI 700 Series Bookcases have been designed to optimally store standard three-ring binders on **all** shelves. Shelves are adjustable on 1" increments to accommodate other media storage needs.

The units described on the following pages are to suit the most common storage requirements. Other bookcase sizes can be built to suit specific needs.

Contact KI Customer Service for details.

Height

Bookcases are available in several standard heights. Non-standard heights will be considered on a special order basis, contact KI Customer Service for details. Heights include 1/8" allowance for leveling glides fully recessed.

Depth

Bookcases are available in two standard depths: 12" and 15".

Width

All bookcases are 30" and 36" wide.

Shelf Clearance

Refer to height and depth clearance dimensions.

CONSTRUCTION AND STANDARD FEATURES

Basic Shell

Shells are unique to bookcases, featuring a flush inner liner. The liner is punched to accept shelf brackets on 1" increments, starting approximately 8" from the bottom of the cabinet and terminating approximately 8" from the top of the cabinet. The liners, top and bottom reinforcements are welded into a rigid box frame. The shell is constructed from 18- and 20-gauge steel, with multiple strategically located offsets to maximize strength. The back is seamless. All corners are reinforced. Illustrated shell heights include 1/8" for adjustable glide in recessed position.

Shelves

Shelves are constructed using 22-gauge steel, formed 7/8" thick on the leading and trailing edges to enhance strength.

Adjustable Glides

Bookcases are supplied with four adjustable glides. The glides can be adjusted from inside the bookcase using a 1/4" hex socket wrench, or from outside the bookcase using a 7/8" wrench. Standard glides provide 3/4" adjustment; longer glides are also available. Overall bookcase heights include the glide in its recessed position.

Commercial Pack

This is the standard pack that KI offers on all files and storage products. This consists of a plastic poly bag placed over the unit, corrugated top and bottom cap, corner blocking and stretch wrap to keep the packaging intact.

Standard Paint Finishes

All KI products are iron phosphate treated prior to painting. This process enhances top coat bonding.

Powder coat application is a highbred epoxy. The paint is baked on to provide a scratch and stain resistant surface.

All inside and outside shell and front surfaces are painted with the same specified paint color. Interior components and accessories are painted a black finish. Mechanical components are black plated.

Powder coated/enamel finish colors shown in Color Addendums are standard and are available where specifications call for painted surfaces.

Special Paint Finishes

All special colors, including other manufacturers' standard enamel finishes, are available subject to the following conditions.

- Two steel color chips (minimum 2.5" x 3.5") are requested for color matching purposes. Paper samples are acceptable, however, a reasonable tolerance must be allowed when comparing the two variations.
- All nonstandard colors are available at no additional charge (excluding hi-chromatic colors), but may be subject to extended lead times. Order will not be processed until color match is approved. Written confirmation must accompany order.

Model Numbering System

Each character in the basic model number corresponds to a specific unit feature.

How to Build a Model Number

Example: 700 Series Bookcases

S7B	36	255	12	BL
------------	-----------	------------	-----------	-----------

S7B	Product name	700 Series Bookcase
36	Bookcase width	36" wide
255	Interior height (nominal)	25 1/2" high
12	Bookcase depth	12" deep
BL	Color code	Black



700 Series® Bookcases

General Information

Inside Clear Dimensions

Bookcase Height	Inside Width		Inside Depth	
	30" model	36" model	12" model	15" model
28 ¹⁵ / ₃₂ "	28 ¹ / ₂ "	34 ¹ / ₂ "	11 ¹ / ₂ "	14 ¹ / ₂ "
42 ⁵ / ₁₆ "	28 ¹ / ₂ "	34 ¹ / ₂ "	11 ¹ / ₂ "	14 ¹ / ₂ "
54 ⁹ / ₁₆ "	28 ¹ / ₂ "	34 ¹ / ₂ "	11 ¹ / ₂ "	14 ¹ / ₂ "
56 ³ / ₃₂ "	28 ¹ / ₂ "	34 ¹ / ₂ "	11 ¹ / ₂ "	14 ¹ / ₂ "
66 ¹³ / ₁₆ "	28 ¹ / ₂ "	34 ¹ / ₂ "	11 ¹ / ₂ "	14 ¹ / ₂ "

Bookcase Height	Top Opening	Middle Opening	Bottom Opening
28 ¹⁵ / ₃₂ "	12 ¹³ / ₆₄ "		12 ²³ / ₆₄ "
42 ⁵ / ₁₆ "	12 ³⁷ / ₆₄ "	12 ¹ / ₈ "	12 ⁴⁷ / ₆₄ "
54 ⁹ / ₁₆ "	12 ⁶¹ / ₆₄ "	12 ¹ / ₈ "	13 ³ / ₆₄ "
56 ³ / ₃₂ "	14 ¹ / ₄ "	12 ¹ / ₈ "	12 ⁵ / ₁₆ "
66 ¹³ / ₁₆ "	12 ⁹ / ₁₆ "	12 ¹ / ₈ "	12 ²³ / ₃₂ "

Note: Dimensions shown above are with shelves located to provide for storage of three-ring binders. Shelves are easily adjustable on 1" increments. Dimensions will vary according.

700 Series® Curve Bookcases

General Information

GENERAL INFORMATION

KI 700 Series Curve Bookcases have been designed to optimally store standard three-ring binders on all shelves. Shelves are adjustable on 1" increments to accommodate other media storage needs.

The units described on the following pages are to suit the most common storage requirements. Other bookcase sizes can be built to suit specific needs. Contact KI Customer Service for details.

Height

Bookcases are available in several standard heights. Non-standard heights will be considered on a special order basis, contact KI Customer Service for details. Heights include 1/8" allowance for leveling glides fully recessed.

Depth

Bookcases are available in two standard depths: 12" and 15".

Width

All bookcases are 30" and 36" wide.

Shelf Clearance

Refer to height and depth clearance dimensions.

CONSTRUCTION AND STANDARD FEATURES

Basic Shell

Shells are unique to bookcases, featuring a flush inner liner. The liner is punched to accept shelf brackets on 1" increments, starting approximately 8" from the bottom of the cabinet and terminating approximately 8" from the top of the cabinet. The liners, top and

bottom reinforcements are welded into a rigid box frame. The shell is constructed from 18- and 20-gauge steel, with multiple strategically located offsets to maximize strength. The back is seamless. All corners are reinforced.

Illustrated shell heights include 7/8" for adjustable glide in recessed position.

Shelves

Shelves are constructed using 22-gauge steel, formed 1/8" thick on the leading and trailing edges to enhance strength.

Adjustable Glides

Bookcases are supplied with four adjustable glides. The glides can be adjusted from inside the bookcase using a 1/4" hex socket wrench, or from outside the bookcase using a 7/8" wrench. Standard glides provide 3/4" adjustment; longer glides are also available. Overall bookcase heights include the glide in its recessed position.

Standard Paint Finishes

All KI products are chemically etched prior to painting. This process enhances top coat bonding. The top coat is a high solids modified polyester enamel. The enamel is baked on to provide a scratch-and stain-resistant surface.

All inside and outside shell and drawer front surfaces are painted with the same specified paint color.

Interior components and accessories are Dark Tone. Mechanical components are black chrome-plated.

Powder coated/enamel finish colors shown in Color Addendum are standard and are available where specifications call for painted surfaces.

Commercial Pack

This is the standard pack that KI offers on all files and storage products. This consists of a plastic poly bag placed over the unit, corrugated top and bottom cap, corner blocking and stretch wrap to keep the packaging intact.

Standard Paint Finishes

All KI products are iron phosphate treated prior to painting. This process enhances top coat bonding. The wet coat application is either alkyd or acrylic paint finish. The powder coat application is a highbred epoxy. The paint is baked on to provide a scratch and stain resistant surface.

All inside and outside shell and front surfaces are painted with the same specified paint color. Interior components and accessories are painted a black finish. Mechanical components are black plated.

Powder coated/enamel finish colors shown in Color Addendums are standard and are available where specifications call for painted surfaces.

Special Paint Finishes

All special colors, including other manufacturers' standard enamel finishes, are available subject to the following conditions.

- Two steel color chips (minimum 3" x 5") are requested for color matching purposes. Paper samples are acceptable, however, a reasonable tolerance must be allowed when comparing the two variations.
- All nonstandard colors are available at no additional charge (excluding hi-chromatic colors), but may be subject to extended lead times. Order will not be processed until color match is approved. Written confirmation must accompany order.

Model Numbering System

Each character in the basic model number corresponds to a specific unit feature.

How to Build a Model Number

Example: 700 Series Bookcases

S7CB	36	255	12	BL
S7CB	Product name	700 Series Curve Bookcase		
36	Bookcase width	36" wide		
255	Interior height (nominal)	25 1/2" high		
12	Bookcase depth	12" deep		
BL	Color code	Black		



700 Series[®] Curve Bookcases

General Information

Inside Clear Dimensions



Bookcase Height	Inside Width		Inside Depth	
	30" model	36" model	12" model	15" model
28 $\frac{1}{2}$ "	28 $\frac{1}{2}$ "	34 $\frac{1}{2}$ "	11 $\frac{1}{2}$ "	14 $\frac{1}{2}$ "
42 $\frac{3}{16}$ "	28 $\frac{1}{2}$ "	34 $\frac{1}{2}$ "	11 $\frac{1}{2}$ "	14 $\frac{1}{2}$ "
54 $\frac{3}{16}$ "	28 $\frac{1}{2}$ "	34 $\frac{1}{2}$ "	11 $\frac{1}{2}$ "	14 $\frac{1}{2}$ "
66 $\frac{3}{16}$ "	28 $\frac{1}{2}$ "	34 $\frac{1}{2}$ "	11 $\frac{1}{2}$ "	14 $\frac{1}{2}$ "

Bookcase Height	Top Opening	Middle Opening	Bottom Opening
28 $\frac{1}{2}$ "	12 $\frac{3}{4}$ "		12 $\frac{3}{4}$ "
42 $\frac{3}{16}$ "	12 $\frac{5}{16}$ "	12 $\frac{1}{8}$ "	12 $\frac{5}{16}$ "
54 $\frac{3}{16}$ "	12 $\frac{5}{16}$ "	12 $\frac{1}{8}$ "	13 $\frac{1}{4}$ "
66 $\frac{3}{16}$ "	12 $\frac{3}{16}$ "	12 $\frac{1}{8}$ "	12 $\frac{3}{16}$ "

Note: Dimensions shown above are with shelves located to provide for storage of three-ring binders. Shelves are easily adjustable on 1" increments. Dimensions will vary according.

Bookcases

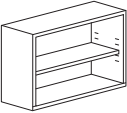
700 Series® 12" Deep

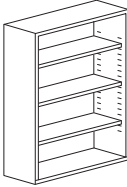
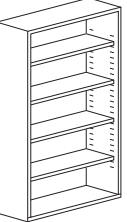
	MODEL	W x D	MODEL NUMBER		Approx. Packaged Weight
			Basic Model	Unit Color	
	28-17/32" High • One adjustable shelf	30 x 12"	S7B/3025512	<input type="checkbox"/>	47.0#
		36 x 12"	S7B/3625512	<input type="checkbox"/>	50.0#
CIBKU					
	42-5/16" High • Two adjustable shelves	30 x 12"	S7B/3039012	<input type="checkbox"/>	61.0#
		36 x 12"	S7B/3639012	<input type="checkbox"/>	65.0#
CIBKU					
	54-9/16" High • Three adjustable shelves	30 x 12"	S7B/3051012	<input type="checkbox"/>	80.0#
		36 x 12"	S7B/3651012	<input type="checkbox"/>	85.0#
CIBKU					
	66-13/16" High • Four adjustable shelves	30 x 12"	S7B/3063012	<input type="checkbox"/>	99.0#
		36 x 12"	S7B/3663012	<input type="checkbox"/>	105.0#
CIBKU					

A

B

HOW TO ORDER

Indicate the following information on order form:

- Quantity of each item.
- Model number, including options. See "How To Build a Model Number".
- Any special service required.

Note: • The indicates that a choice is required.

- The absence of the indicates that no choice is required.
- Alpha-numeric characters in place of indicate that no other alternatives are available.

HOW TO BUILD A MODEL NUMBER

- A** Select basic model.
- B** Select unit color.
Refer to color addendum at ki.com or KI Fabrics & Finishes binder.

INFORMATION

Height

All dimensions shown include 1/4" allowance for glides in recessed position.

Accessories

See accessory section for accessories that can be ordered separately.

Weights

Figures provided are approximate and reflect packaged product without additional accessories.



Bookcases

700 Series® 12" Deep

Delivered
Pricing

\$ 434

521

\$ 584

624

\$ 677

783

\$ 815

938

SPECIAL SERVICES

Special Carton Marking

With specially marked information N/C

Shipping

Shipped **assembled freight prepaid f.o.b.**
Pembroke, Ontario K8A 0E1 factory.
Freight class #70.

Specifications and prices are subject to
change without prior notice.

Bookcases

700 Series® Curve 12" Deep

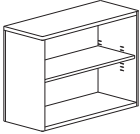
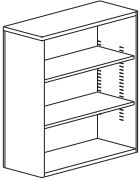
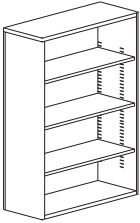
	MODEL	W x D	MODEL NUMBER		Approx. Packaged Weight
			Basic Model	Unit Color	
	28-17/32" High • One adjustable shelf	30 x 12"	S7CB3025512	<input type="checkbox"/> <input type="checkbox"/>	47.0#
		36 x 12"	S7CB3625512	<input type="checkbox"/> <input type="checkbox"/>	50.0#
S7BK					
	42-5/16" High • Two adjustable shelves	30 x 12"	S7CB3039012	<input type="checkbox"/> <input type="checkbox"/>	61.0#
		36 x 12"	S7CB3639012	<input type="checkbox"/> <input type="checkbox"/>	63.0#
S7BK					
	54-9/16" High • Three adjustable shelves	30 x 12"	S7CB3051012	<input type="checkbox"/> <input type="checkbox"/>	80.0#
		36 x 12"	S7CB3651012	<input type="checkbox"/> <input type="checkbox"/>	85.0#
S7BK					

A

B

HOW TO ORDER

Indicate the following information on order form:

- Quantity of each item.
- Model number, including options. See "How To Build a Model Number".
- Any special service required.

Note:

- The indicates that a choice is required.
- The absence of the indicates that no choice is required.
- Alpha-numeric characters in place of indicate that no other alternatives are available.

HOW TO BUILD A MODEL NUMBER

- A** Select basic model.
- B** Select unit color. Refer to color addendum at ki.com or KI Fabrics & Finishes binder.

INFORMATION

Height

All dimensions shown include 1/8" allowance for glides in recessed position.

Weights

Figures provided are approximate and reflect packaged product without additional accessories.



Bookcases

700 Series® Curve 12" Deep

Delivered
Pricing

\$ 487

585

\$ 650

696

\$ 757

879

SPECIAL SERVICES

Special Carton Marking

With specially marked information N/C

Shipping

Shipped **assembled freight prepaid f.o.b. Pembroke, Ontario K8A 0E1** factory.
Freight class #70.

Specifications and prices are subject to change without prior notice.

Bookcases

700 Series® Curve 12" Deep

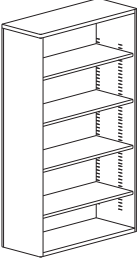
	MODEL	W x D	MODEL NUMBER		Approx. Packaged Weight
			Basic Model	Unit Color	
 <p>S7BK</p>	66-13/16" High • Four adjustable shelves	30 x 12"	S7CB3063012	<input type="checkbox"/> <input type="checkbox"/> <input type="checkbox"/>	99.0#
		36 x 12"	S7CB3663012	<input type="checkbox"/> <input type="checkbox"/> <input type="checkbox"/>	105.0#

A **B**

HOW TO ORDER

Indicate the following information on order form:

1. Quantity of each item.
2. Model number, including options. See "How To Build a Model Number".
3. Any special service required.

Note: • The indicates that a choice is required.
 • The absence of the indicates that no choice is required.
 • Alpha-numeric characters in place of indicate that no other alternatives are available.

HOW TO BUILD A MODEL NUMBER

- A** Select basic model.
- B** Select unit color.
Refer to color addendum at ki.com or KI Fabrics & Finishes binder.

INFORMATION

Height
 All dimensions shown include 1/8" allowance for glides in recessed position.

Weights
 Figures provided are approximate and reflect packaged product without additional accessories.



Bookcases

700 Series® Curve 12" Deep

Delivered
Pricing

\$ 914

1052

SPECIAL SERVICES

Special Carton Marking

With specially marked information N/C

Shipping

Shipped **assembled freight prepaid f.o.b. Pembroke, Ontario K8A 0E1** factory.
Freight class #70.

Specifications and prices are subject to change without prior notice.

Bookcases

700 Series® 15" Deep

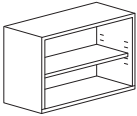
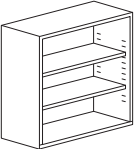
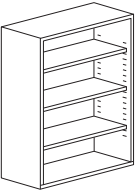
	MODEL	W x D	MODEL NUMBER		Approx. Packaged Weight
			Basic Model	Unit Color	
 CIBKU	28-17/32" High • One adjustable shelf	30 x 15"	S7B/3025515	<input type="checkbox"/>	52.0#
		36 x 15"	S7B/3625515	<input type="checkbox"/>	55.0#
 CIBKU	42-5/16" High • Two adjustable shelves	30 x 15"	S7B/3039015	<input type="checkbox"/>	66.0#
		36 x 15"	S7B/3639015	<input type="checkbox"/>	70.0#
 CIBKU	54-9/16" High • Three adjustable shelves	30 x 15"	S7B/3051015	<input type="checkbox"/>	85.0#
		36 x 15"	S7B/3651015	<input type="checkbox"/>	90.0#

A

B

HOW TO ORDER

Indicate the following information on order form:

- Quantity of each item.
- Model number, including options. See "How To Build a Model Number".
- Any special service required.

Note: • The indicates that a choice is required.
 • The absence of the indicates that no choice is required.
 • Alpha-numeric characters in place of indicate that no other alternatives are available.

HOW TO BUILD A MODEL NUMBER

- A** Select basic model.
- B** Select unit color.
Refer to color addendum at ki.com or KI Fabrics & Finishes binder.

INFORMATION

Height

All dimensions shown include 1/4" allowance for glides in recessed position.

Accessories

See accessory section for accessories that can be ordered separately.

Weights

Figures provided are approximate and reflect packaged product without additional accessories.



Bookcases

700 Series® 15" Deep

Delivered
Pricing

\$ 467

552

\$ 602

665

\$ 726

805

SPECIAL SERVICES

Special Carton Marking

With specially marked information N/C

Shipping

Shipped **assembled freight prepaid f.o.b. Pembroke, Ontario K8A 0E1** factory.
Freight class #70.

Specifications and prices are subject to change without prior notice.

Bookcases

700 Series® 15" Deep

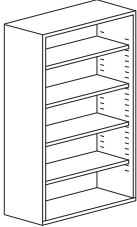
	MODEL	W x D	MODEL NUMBER		Approx. Packaged Weight
			Basic Model	Unit Color	
	56-5/32" High • Three adjustable shelves	30 x 15"	S7B/3052515	<input type="checkbox"/>	95.0#
		36 x 15"	S7B/3652515	<input type="checkbox"/>	100.0#
CIBKU					
	66-13/16" High • Four adjustable shelves	30 x 15"	S7B/3063015	<input type="checkbox"/>	104.0#
		36 x 15"	S7B/3663015	<input type="checkbox"/>	110.0#
CIBKU					

A

B

HOW TO ORDER

Indicate the following information on order form:

- Quantity of each item.
- Model number, including options. See "How To Build a Model Number".
- Any special service required.

Note: • The indicates that a choice is required.

- The absence of the indicates that no choice is required.
- Alpha-numeric characters in place of indicate that no other alternatives are available.

HOW TO BUILD A MODEL NUMBER

- A** Select basic model.
- B** Select unit color.
Refer to color addendum at ki.com or KI Fabrics & Finishes binder.

INFORMATION

Height

All dimensions shown include 1/4" allowance for glides in recessed position.

Accessories

See accessory section for accessories that can be ordered separately.

Weights

Figures provided are approximate and reflect packaged product without additional accessories.



Bookcases

700 Series® 15" Deep

Delivered
Pricing

\$ 770

801

\$ 871

1004

SPECIAL SERVICES

Special Carton Marking

With specially marked information N/C

Shipping

Shipped **assembled freight prepaid f.o.b. Pembroke, Ontario K8A 0E1** factory.
Freight class #70.

Specifications and prices are subject to change without prior notice.

Bookcases

700 Series® Curve 15" Deep

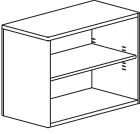
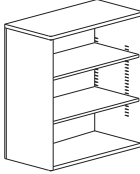
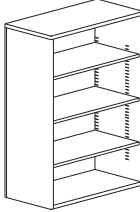
	MODEL	W x D	MODEL NUMBER		Approx. Packaged Weight
			Basic Model	Unit Color	
	28-17/32" High • One adjustable shelf	30 x 15"	S7CB3025515	<input type="checkbox"/> <input type="checkbox"/> <input type="checkbox"/>	52.0#
		36 x 15"	S7CB3625515	<input type="checkbox"/> <input type="checkbox"/> <input type="checkbox"/>	55.0#
S7BK					
	42-5/16" High • Two adjustable shelves	30 x 15"	S7CB3039015	<input type="checkbox"/> <input type="checkbox"/> <input type="checkbox"/>	66.0#
		36 x 15"	S7CB3639015	<input type="checkbox"/> <input type="checkbox"/> <input type="checkbox"/>	70.0#
S7BK					
	54-9/16" High • Three adjustable shelves	30 x 15"	S7CB3051015	<input type="checkbox"/> <input type="checkbox"/> <input type="checkbox"/>	85.0#
		36 x 15"	S7CB3651015	<input type="checkbox"/> <input type="checkbox"/> <input type="checkbox"/>	90.0#
S7BK					

A

B

HOW TO ORDER

Indicate the following information on order form:

1. Quantity of each item.
2. Model number, including options. See "How To Build a Model Number".
3. Any special service required.

- Note:
- The indicates that a choice is required.
 - The absence of the indicates that no choice is required.
 - Alpha-numeric characters in place of indicate that no other alternatives are available.

HOW TO BUILD A MODEL NUMBER

- A** Select basic model.
- B** Select unit color. Refer to color addendum at ki.com or KI Fabrics & Finishes binder.

INFORMATION

Height

All dimensions shown include 1/8" allowance for glides in recessed position.

Weights

Figures provided are approximate and reflect packaged product without additional accessories.



Bookcases

700 Series® Curve 15" Deep

Delivered
Pricing

\$ 501

594

\$ 647

716

\$ 782

867

SPECIAL SERVICES

Special Carton Marking

With specially marked information N/C

Shipping

Shipped **assembled freight prepaid f.o.b. Pembroke, Ontario K8A 0E1** factory.
Freight class #70.

Specifications and prices are subject to change without prior notice.

Bookcases

700 Series® Curve 15" Deep

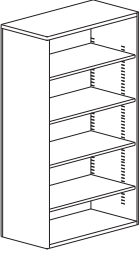
	MODEL	W x D	MODEL NUMBER		Approx. Packaged Weight
			Basic Model	Unit Color	
 <p>S7BK</p>	66-13/16" High • Four adjustable shelves	30 x 15"	S7CB3063015	<input type="checkbox"/> <input type="checkbox"/> <input type="checkbox"/>	104.0#
		36 x 15"	S7CB3663015	<input type="checkbox"/> <input type="checkbox"/> <input type="checkbox"/>	110.0#

A

B

HOW TO ORDER

Indicate the following information on order form:

1. Quantity of each item.
2. Model number, including options. See "How To Build a Model Number".
3. Any special service required.

Note:

- The indicates that a choice is required.
- The absence of the indicates that no choice is required.
- Alpha-numeric characters in place of indicate that no other alternatives are available.

HOW TO BUILD A MODEL NUMBER

- A** Select basic model.
- B** Select unit color. Refer to color addendum at ki.com or KI Fabrics & Finishes binder.

INFORMATION

Height
All dimensions shown include 1/8" allowance for glides in recessed position.

Weights
Figures provided are approximate and reflect packaged product without additional accessories.



Bookcases

700 Series® Curve 15" Deep

Delivered
Pricing

\$ 939

1079

SPECIAL SERVICES

Special Carton Marking



With specially marked information N/C

Shipping

Shipped **assembled freight prepaid f.o.b. Pembroke, Ontario K8A 0E1** factory.
Freight class #70.

Specifications and prices are subject to change without prior notice.

Bookcase Accessories

	MODEL	Features	W x D x H	MODEL NUMBER		Approx. Packaged Weight
				Basic Model	Unit Color	
 LTACU	Blank Shelf • Must specify color	For 12" D bookcases only	30 x 12 x 1"	S7B/3012BS	<input type="checkbox"/>	5.0#
		For 15" D bookcases only	30 x 15 x 1"	S7B/3015BS	<input type="checkbox"/>	6.0#
		For 12" D bookcases only	36 x 12 x 1"	S7B/3612BS	<input type="checkbox"/>	6.0#
		For 15" D bookcases only	36 x 15 x 1"	S7B/3615BS	<input type="checkbox"/>	7.0#
 LTACU	Book End Support • Black finish only	For all 12" D bookcase shelves	1-1/2 x 12 x 8"	S7B/BES12		2.0#
		For all 15" D bookcase shelves	1-1/2 x 15 x 8"	S7B/BES15		2.0#
				A	B	

HOW TO ORDER

Indicate the following information on order form:

- Quantity of each item.
- Model number, including options. See "How To Build a Model Number".
- Any special service required.

Note: • The indicates that a choice is required.

- The absence of the indicates that no choice is required.
- Alpha-numeric characters in place of indicate that no other alternatives are available.

HOW TO BUILD A MODEL NUMBER

- A** Select basic model.
- B** Select unit color.
Refer to color addendum at ki.com or KI Fabrics & Finishes binder.



Delivered
Pricing

\$ 70

75

96

102

\$ 34

36

SPECIAL SERVICES

Special Carton Marking

With specially marked information N/C

Shipping

Shipped **assembled freight prepaid f.o.b. Pembroke, Ontario K8A 0E1** factory.
Freight class #70.

Specifications and prices are subject to change without prior notice.

Bookcase Laminate Tops

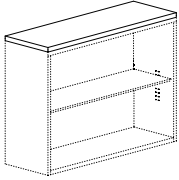
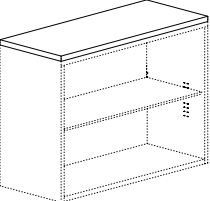
	Features	W x D x H	MODEL NUMBER				Approx. Packaged Weight
			Basic Model	Edge Style	Edge Color	Surface Finish	
 <p>S7TP</p> <p>Laminate Top for 12" Deep Bookcases</p> <ul style="list-style-type: none"> • High pressure laminate with particle-board core • Self edge or 74P edge available • Other sizes available upon request 	Fits one 30" wide bookcase	30 x 12 x 1-1/4"	S7B/3012T	<input type="checkbox"/>	<input type="checkbox"/>	<input type="checkbox"/>	12.0#
	Fits one 36" wide bookcase	36 x 12 x 1-1/4"	S7B/3612T	<input type="checkbox"/>	<input type="checkbox"/>	<input type="checkbox"/>	14.0#
	Fits two 30" wide bookcases	60 x 12 x 1-1/4"	S7B/6012T	<input type="checkbox"/>	<input type="checkbox"/>	<input type="checkbox"/>	24.0#
	Fits two 36" or one 30" & one 42" wide bookcases	72 x 12 x 1-1/4"	S7B/7212T	<input type="checkbox"/>	<input type="checkbox"/>	<input type="checkbox"/>	29.0#
 <p>S7TP</p> <p>Laminate Top for 15" Deep Bookcases</p> <ul style="list-style-type: none"> • High pressure laminate with particle-board core • Self edge or 74P edge available • Other sizes available upon request 	Fits one 30" wide bookcase	30 x 15 x 1-1/4"	S7B/3015T	<input type="checkbox"/>	<input type="checkbox"/>	<input type="checkbox"/>	15.0#
	Fits one 36" wide bookcase	36 x 15 x 1-1/4"	S7B/3615T	<input type="checkbox"/>	<input type="checkbox"/>	<input type="checkbox"/>	18.0#
	Fits two 30" wide bookcases	60 x 15 x 1-1/4"	S7B/6015T	<input type="checkbox"/>	<input type="checkbox"/>	<input type="checkbox"/>	30.0#
	Fits two 36" or one 30" & one 42" wide bookcases	72 x 15 x 1-1/4"	S7B/7215T	<input type="checkbox"/>	<input type="checkbox"/>	<input type="checkbox"/>	36.0#
			A	B	C	D	

HOW TO ORDER

Indicate the following information on order form:

1. Quantity of each item.
2. Model number, including options. See "How To Build a Model Number".
3. Any special service required.

- Note:
- The indicates that a choice is required.
 - The absence of the indicates that no choice is required.
 - Alpha-numeric characters in place of indicate that no other alternatives are available.

HOW TO BUILD A MODEL NUMBER

- A** Select basic model.
- B** Select edge style.

SE	- Self Edge
74P	- 74P edge
- C** Select edge color. Refer to color addendum at ki.com or KI Fabrics & Finishes binder. Edge color offerings are based on edge style selections.
- D** Select surface finish. Refer to color addendum at ki.com or KI Fabrics & Finishes binder. Surface finish offerings are based on edge style selections.



Bookcase Laminate Tops

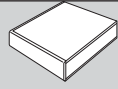
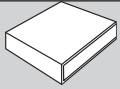

Self Edge
(SE)

74P Edge
(74P)

\$ 272
312
457
569

\$ 284
327
483
593

\$ 277
312
457
569

\$ 291
328
483
593

SPECIAL SERVICES

Special Carton Marking

With specially marked information N/C

Shipping

Shipped **assembled freight prepaid f.o.b. Pembroke, Ontario K8A 0E1** factory. Freight class #70.

Specifications and prices are subject to change without prior notice.

700 Series® Pedestals

General Information

GENERAL INFORMATION

KI 700 Series pedestals are available in sizes and drawer combinations to suit any personal storage requirement. Freestanding and mobile units are designed to fit below most work-surfaces. Hanging and worksurface supporting units are sized to fit under KI Systems furniture. A mounting kit is provided with each unit to allow installation under other compatible workstations.

Preconfigured Units

To simplify the specification process, KI offers preconfigured pedestals in the most popular sizes with the most popular internal components. These units are assembled using standard components.

Height

Four pedestal styles are available. Heights include 1/4" allowance for leveling glides fully recessed. Worksurface Supporting: 27 1/8". Freestanding: 22 3/8", 25 7/16". Mobile: 24 11/16", 27 3/8". Hanging: 19 3/16", 22 1/8"

Depth

Products are available in three standard depths: 17 5/8", 21 5/8" and 27 5/8".

Width

All products are 15" wide.

Drawer Dimensions

Refer to the illustrations for the range of drawer sizes and the height clearance of each.

CONSTRUCTION AND STANDARD FEATURES

Basic Shell

Twenty-gauge steel body with 20-gauge steel top and box frame front and back uprights. Uprights are notched in 3" intervals for drawer suspension mounting.

Drawers

Fronts: Two-piece metal construction. Twenty-two gauge steel outerskin welded to 22-gauge inner liner. With full width inset or overlap front of pedestal.

Three-inch (pencil) drawer: Single wall two-piece construction. Body 22-gauge; back 22-gauge. Operates on two section 3/4 extension ball bearing suspension.

Six-inch (box) drawer; single wall two-piece construction. Body 22-gauge; back 22-gauge. Operates on two-section 3/4 extension ball-bearing suspension.

Twelve-inch (file): Single wall, two-piece construction. Front liner 20-gauge; body 22-gauge. Mounted on full extension slide arm suspensions. Flat front with exterior pulls. Drawer fronts

Adjustable Glides

Freestanding and floor supporting pedestals include four glides, adjustable from outside the cabinet. Standard glides provide 1" adjustment.

Counterbalance

Counterbalance weight is standard in all mobile units and is recommended in all freestanding units.

Caster Kit

Consists of four twin-wheel hooded casters. Front two casters are locking; rear two casters are non-locking. Counterbalance weight included in all mobile units.

Locks

Locks are standard on all units. The lock is a high-security double-bit type. The double-bit lock offers superior security when compared to a single-bit lock. Units are standard with random keys in a range of 994 different numbers. Specific keying combinations are available at no additional charge. This

information must be included with the order. Locks can be master keyed. Please see the accessories section of this price book for order information on master keys, extractor (core-removal) keys, key blanks, cut keys, and core and key sets.

All locks have removable and interchangeable plugs. This feature provides for onsite custom keying. Units can be supplied with the lock plugs installed or shipped separately. To install or remove lock plugs a unique key is required. This key is the extractor (core removal) key and can be found in the accessories section of this price book. Contact Customer Service to order lock accessories. To order plugs for field installation, specify "lock plugs not installed" on order. Order must specify total quantity of specific key-numbered locks.

Example: 30 plugs:
3 keyed alike
10 keyed alike
17 keyed alike

Commercial Pack

This is the standard pack that KI offers on all files and storage products. This consists of a plastic poly bag placed over the unit, corrugated top and bottom cap, corner blocking and stretch wrap to keep the packaging intact.

Standard Paint Finishes

All KI products are iron phosphate treated prior to painting. This process enhances top coat bonding.

Powder coat application is a highbred epoxy. The paint is baked on to provide a scratch and stain resistant surface.

All inside and outside shell and front surfaces are painted with the same specified paint color. Interior components and accessories are painted a black finish. Mechanical components are black plated.

Powder coated/enamel finish colors shown in Color Addendums are standard and are available where specifications call for painted surfaces.

Special Paint Finishes

All special colors, including other manufacturers' standard enamel finishes, are available subject to the following conditions.

1. Two steel color chips (minimum 2.5" x 3.5") are requested for color matching purposes. Paper samples are acceptable, however, a reasonable tolerance must be allowed when comparing the two variations.
2. All nonstandard colors are available at no additional charge (excluding hi-chromatic colors), but may be subject to extended color match is approved. Written confirmation must accompany order.

Field Reconfiguration

As needs change, KI pedestals can readily be field-changed; however, this process should be undertaken by a qualified service technician.

Model Numbering System

Each character in the basic model number corresponds to a specific unit feature.

How to Build a Model Number

Example: 700 Series Pedestals

Optional Picks

S7P	15	24	F	FF	BL	CBW50
S7P	Product name		700 Series Pedestal			
15	Cabinet width		15" wide			
24	Cabinet depth (nominal)		24" depth			
F	Pedestal type		Freestanding			
FF	Drawer type		Two 12" file drawers			
BL	Color code		Black			
CBW50	Optional		50# Counterbalance weight			
Each pedestal type and accessory has a corresponding character:						
M	Mobile					
H	Hanging/suspended					
F	Freestanding					
W	Worksurface supporting					
P	3" pencil drawer					
B	6" box drawer					
F	12" file drawer					

NOTE: The unit must SPECIFY optional CBW as INSTALLED or they will be shipped separately.



Inside Dimensions of Drawers

	17 ⁵ / ₈ "D PEDESTAL			21 ⁵ / ₈ "D PEDESTAL			27 ⁵ / ₈ "D PEDESTAL		
	W	D	H	W	D	H	W	D	H
3" Pencil	12 ¹ / ₈ "	16¹/₄"	2 ³ / ₁₆ "	12 ¹ / ₈ "	19⁵/₁₆"	2 ³ / ₁₆ "	12 ¹ / ₈ "	25¹³/₁₆"	2 ³ / ₁₆ "
6" Box	12 ¹ / ₈ "	16¹/₄"	5 ¹ / ₈ "	12 ¹ / ₈ "	19⁵/₁₆"	5 ¹ / ₈ "	12 ¹ / ₈ "	25¹³/₁₆"	5 ¹ / ₈ "
12" File	12 ¹ / ₈ "	15³/₄"	11"	12 ¹ / ₈ "	18¹³/₁₆"	11"	12 ¹ / ₈ "	25⁵/₁₆"	11"

Pedestal Heights and Depths

	Depths	Heights Including Glides	Heights Including Casters	Heights Without Glides/Casters
Freestanding	17 ⁵ / ₈ ", 21 ⁵ / ₈ ", 27 ⁵ / ₈ "	22 ³ / ₈ ", 25 ⁵ / ₁₆ "		
Mobile	17 ⁵ / ₈ ", 21 ⁵ / ₈ ", 27 ⁵ / ₈ "		21 ³ / ₄ ", 24 ⁵ / ₈ ", 27 ⁹ / ₁₆ "	
Hanging	17 ⁵ / ₈ ", 21 ⁵ / ₈ ", 27 ⁵ / ₈ "			19 ³ / ₁₆ ", 22 ¹ / ₈ ", 25 ¹ / ₁₆ "
Worksurface supporting	17 ⁵ / ₈ ", 21 ⁵ / ₈ ", 27 ⁵ / ₈ "	27 ⁷ / ₈ "		

700 Series® Curve Pedestals

General Information

GENERAL INFORMATION

KI Curve pedestal files are available in sizes and drawer combinations to suit any personal storage requirements. Freestanding and mobile units are designed to fit below most worksurfaces. Hanging and worksurface supporting units are sized to fit under KI systems furniture. A mounting kit is provided with each unit to allow installation under other compatible workstations.

Clean stylish looks, flexible aesthetics and durability allow Curve to work in private offices and open plan environments. With a gentle curved front and contoured drawer pulls, Curve creates a timeless design element.

Flexible aesthetic and flexible format. Curve allows you to design from the inside out, fitting the media to the appropriate lateral, pedestal, cupboard, bookcase and combination unit or locker/file unit.

Heavy-gauge steel construction and welded internal box frame for structural integrity. Multi-extension suspensions provide smooth drawer operation. Curve enhances security with its 994 key possibilities.

Preconfigured Units

To simplify the specification process, KI offers preconfigured pedestals in the most popular sizes with the most popular internal components. These units are assembled using standard components.

Height

Four pedestal styles are available. Heights include 1/4" allowance for leveling glides fully recessed. Refer to the illustrations for the range of height clearance of each.

Depth

Products are available in three standard depths: 17 7/8", 21 5/8" and 27 5/8". Refer to the illustrations for the range height clearance of each.

Width

All products are 15" wide.

Drawer Dimensions

Refer to the illustrations for the range of drawer sizes and the height clearance of each.

CONSTRUCTION AND STANDARD FEATURES

Basic Shell

20 gauge steel body with 20-gauge steel top and box frame front and back uprights. Uprights are notched in 3" intervals for drawer suspensions mounting.

Drawers

Fronts: two-piece metal construction. 22-gauge steel outerskin welded to 22-gauge inner liner. With full width contoured curved steel pull. Radius drawer fronts overlap front of pedestal.

Three-inch (pencil) drawer: Single wall two-piece construction. Body 22-gauge; back 22-gauge. Mounted on full extension slide arm suspensions.

Six-inch (box) drawer: single wall, two-piece construction. Front liner 20-gauge; body 22-gauge. Mounted on full extension slide arm suspensions.

Twelve-inch (file); single wall, two-piece construction. Front liner 20-gauge; body 22-gauge. Mounted on full extension slide arm suspensions.

Adjustable Glides

Freestanding and floor supporting pedestals include four glides, adjustable from outside the cabinet. Standard glides provide 1" adjustment.

Counterbalance

Counterbalance weight is included on all mobile units (file/file) that do not use the 5th wheel under the bottom drawer. Counterbalance weight is recommended in all freestanding units.

Caster Kit

Consists of four twin-wheel-hooded casters. Front two casters are locking; rear two casters are non-locking.

Locks

Locks are standard on all units. The lock is a high-security double-bit type. The double-bit lock offers superior security when compared to a single-bit lock. Units are standard with random keys in a range of 994 different numbers. Specific keying combinations are available at no additional charge. This information must be included with the order. Locks can be master keyed. Please see the accessories section of this price book for order information on master keys, extractor (core-removal) keys, key blanks, cut keys, and core and key sets.

All locks have removable and interchangeable plugs. This feature provides for onsite custom keying. Units can be supplied with the lock plugs installed or shipped separately. To install or remove lock plugs a unique key is required. This key is the extractor (core removal) key and can be found in the accessories section of this price book. Contact Customer Service to order lock accessories. To order plugs for field installation, specify "lock plugs not installed" on order. Order must specify total quantity of specific key-numbered locks.

Example: 30 plugs:
3 keyed alike
10 keyed alike
17 keyed alike

Commercial Pack

This is the standard pack that KI offers on all files and storage products. This consists of a plastic poly bag placed over the unit, corrugated top and bottom cap, corner blocking and stretch wrap to keep the packaging intact.

Standard Paint Finishes

All KI products are iron phosphate treated prior to painting. This process enhances top coat bonding. The wet coat application is either Alkyd or Acrylic paint finish. The powder coat application is a high-bred epoxy. The paint is baked on to provide a scratch and stain resistant surface.

All inside and outside shell and front surfaces are painted with the same specified paint color. Interior components and accessories are painted a black finish. Mechanical components are black plated.

Powder coated/enamel finish colors shown in Color Addendums are standard and are available where specifications call for painted surfaces.

Special Paint Finishes

All special colors, including other manufacturers' standard enamel finishes, are available subject to the following conditions.

1. Two steel color chips (minimum 2.5" x 3.5") are requested for color matching purposes. Paper samples are acceptable, however, a reasonable tolerance must be allowed when comparing the two variations.
2. All nonstandard colors are available at no additional charge (excluding hi-chromatic colors), but may be subject to extended lead times. Order will not be processed until color match is approved. Written confirmation must accompany order.

Field Reconfiguration

As needs change, KI pedestals can readily be field-changed; however, this process should be undertaken by a qualified service technician.

Model Numbering System

Each character in the basic model number corresponds to a specific unit feature.

How to Build a Model Number

Example: 700 Series Pedestals

S7CP	15	24	F	FF	BL	Optional Picks
						CBW50
S7CP	Product name	700 Series Curve Pedestal				
15	Cabinet width	15" wide				
24	Cabinet depth (nominal)	24" depth				
F	Pedestal type	Freestanding				
FF	Drawer type	Two 12" file drawers				
BL	Color code	Black				
CBW50	Optional	50# Counterbalance weight				

Each pedestal type and accessory has a corresponding character:

M	Mobile
H	Hanging/suspended
F	Freestanding
W	Worksurface supporting
P	3" pencil drawer
B	6" box drawer
F	12" file drawer

NOTE: The unit must SPECIFY optional CBW as INSTALLED or they will be shipped separately.



700 Series[®] Curve Pedestals

General Information

Inside Dimensions of Drawers

	17 ⁵ / ₈ "D PEDESTAL			21 ⁵ / ₈ "D PEDESTAL			27 ⁵ / ₈ "D PEDESTAL		
	W	D	H	W	D	H	W	D	H
3" Pencil	12 ¹ / ₈ "	16 ¹ / ₄ "	2 ³ / ₁₆ "	12 ¹ / ₈ "	19 ⁵ / ₁₆ "	2 ³ / ₁₆ "	12 ¹ / ₈ "	25 ¹³ / ₁₆ "	2 ³ / ₁₆ "
6" Box	12 ¹ / ₈ "	16 ¹ / ₄ "	5 ¹ / ₈ "	12 ¹ / ₈ "	19 ⁵ / ₁₆ "	5 ¹ / ₈ "	12 ¹ / ₈ "	25 ¹³ / ₁₆ "	5 ¹ / ₈ "
12" File	12 ¹ / ₈ "	15 ³ / ₄ "	11"	12 ¹ / ₈ "	18 ¹³ / ₁₆ "	11"	12 ¹ / ₈ "	25 ⁵ / ₁₆ "	11"

Pedestal Heights and Depths

	Depths	Heights Including Glides	Heights Including Casters	Heights Without Glides/Casters
Freestanding	17 ⁵ / ₈ " , 21 ⁵ / ₈ " , 27 ⁵ / ₈ "	22 ³ / ₈ " , 25 ⁵ / ₁₆ "		
Mobile	17 ⁵ / ₈ " , 21 ⁵ / ₈ " , 27 ⁵ / ₈ "		21 ³ / ₄ " , 24 ¹¹ / ₁₆ " , 27 ⁵ / ₈ "	
Hanging	17 ⁵ / ₈ " , 21 ⁵ / ₈ " , 27 ⁵ / ₈ "			19 ³ / ₁₆ " , 22 ¹ / ₈ " , 25 ¹ / ₁₆ "
Worksurface supporting	21 ⁵ / ₈ " , 27 ⁵ / ₈ " ,	24 ¹³ / ₁₆ " , 27 ⁷ / ₈ "		

700 Series® OF Pedestals

General Information

GENERAL INFORMATION

700 Series OF pedestals are illustrated in the most common drawer and size configurations. Other drawer and size combinations are available since the product is designed and manufactured utilizing components from the 700 Series product line. Freestanding and mobile units are designed to fit below most worksurfaces. Hanging and worksurface supporting units are sized to fit under KI Systems furniture. A mounting kit is provided

with each hanging unit and worksurface supporting unit to allow installation under other compatible workstations.

Height

Three pedestal styles are illustrated. Heights include a $\frac{1}{8}$ " allowance for glides or casters.

Depth

Products are available in three standard depths: $17\frac{7}{8}$ ", $21\frac{1}{8}$ " and $27\frac{3}{8}$ ". The dimension includes the allowance for drawer fronts.

Width

All products are 15" wide.

Drawer Dimensions

Refer to the illustrations for the range of drawer sizes and the height clearance of each.

CONSTRUCTION AND STANDARD FEATURES

Basic Shell

Twenty-gauge steel body with 18- and 20-gauge steel top and box frame front and back uprights. Uprights are notched in 3" intervals for drawer suspension mounting.

Two shell styles are available. One style has a flush top, allowing for the application of a lock rail and thereby providing an entirely custom front facade. The other shell style has an extended top where the $1\frac{1}{8}$ " top extends flush to the front of the pedestal.

Drawers

Six-inch (box) drawer; single wall two-piece construction. Body 22-gauge; back 22-gauge. Operates on two-section $\frac{3}{4}$ " extension ball-bearing suspension.

Twelve-inch (file): Single wall, two-piece construction. Back and body 22-gauge. Mounted on full extension slide arm suspensions.

Fronts: When specified without fronts, drawers come standard with hardware to mount fronts to drawer bodies. Mounting hardware can be specified for delivery prior to product delivery. Contact Customer Service for details. When specified with fronts, fronts are particleboard core with either wood veneer or plastic laminate finish. Fronts are nominally $\frac{3}{4}$ " thick.

Front Specifications: To assist in the manufacturing of custom fronts, refer to the specification section. This section provides illustrations detailing recommended dimensions and hole locations.

Adjustable Glides

Freestanding and floor supporting pedestals include four glides, adjustable from outside the cabinet.

Counterbalance

Counterbalance weight is standard in all mobile units and is recommended in all freestanding units.

Caster Kit

Consists of four twin-wheel hooded casters. Front two casters are locking; rear two casters are non-locking. Counterbalance weight included in all mobile units.

Locks

Locks are standard on all units. The lock is a high-security double-bit type. The double-bit lock offers superior security when compared to a single-bit lock. Units are standard with random keys in a range of 994 different numbers. Specific keying combinations are available at no additional charge. This information must be included with the order. Locks can be master keyed. Please see the accessories section of this price book for order information on master keys, extractor (core-removal) keys, key blanks, cut keys, and core and key sets.

All locks have removable and interchangeable plugs. This feature provides for onsite custom keying. Units can be supplied with the lock plugs installed or shipped separately. To install or remove lock plugs a unique key is required. This key is the extractor (core removal) key and can be found in the accessories section of this price book. Contact Customer Service to order lock accessories. To order plugs for field installation, specify "lock plugs not installed" on order. Order must specify total quantity of specific key-numbered locks.

Example: 30 plugs:
3 keyed alike
10 keyed alike
17 keyed alike

Commercial Pack

This is the standard pack that KI offers on all files and storage products. This consists of a plastic poly bag placed over the unit, corrugated top and bottom cap, corner blocking and stretch wrap to keep the packaging intact.

Standard Paint Finishes

All KI products are iron phosphate treated prior to painting. This process enhances top coat bonding.

Powder coat application is a highbred epoxy. The paint is baked on to provide a scratch and stain resistant surface.

All inside and outside shell and front surfaces are painted with the same specified paint color. Interior components and accessories are painted a black finish. Mechanical components are black plated.

Powder coated/enamel finish colors shown in Color Addendums are standard and are available where specifications call for painted surfaces.

Model Numbering System

Each character in the basic model number corresponds to a specific unit feature. How to Build a Model Number

Example: 700 Series Optional Front Extended Top Pedestals

		Front Option			Front Finish		Optional Picks	
S7PE	15	24	F	FF	X	BL	CBW50	
S7PE	Product name	700 Series Pedestal, Extended Top						
15	Cabinet width	15" wide						
24	Cabinet depth (nominal)	24" depth						
F	Pedestal type	Freestanding						
FF	Drawer type	Two 12" file drawers						
X	Color code	No front						
BL	Front type	Black						
CBW50	Optional	50# Counterbalance weight						
Each pedestal type and accessory has a corresponding character:								
M	Mobile							
H	Hanging/suspended							
F	Freestanding							
W	Worksurface supporting							
P	3" pencil drawer							
B	6" box drawer							
F	12" file drawer							
L1	Laminate front							
X	No Front							
NOTE: The unit must SPECIFY optional CBW as INSTALLED or they will be shipped separately.								

Model Numbering System

Each character in the basic model number corresponds to a specific unit feature. How to Build a Model Number

Example: 700 Series Optional Front Flush Top Pedestals

		Front Option			Front Finish		Optional Picks	
S7PF	15	24	F	FF	W1	BL	RCY	CBW50
S7PF	Product name	700 Series Pedestal, Flush Top						
15	Cabinet width	15" wide						
24	Cabinet depth (nominal)	24" depth						
F	Pedestal type	Freestanding						
FF	Drawer type	Two 12" file drawers						
W1	Front type	Wood front, center pull						
BL	Color code	Black						
RCY	Wood color	Cherry veneer						
CBW50	Optional	50# Counterbalance weight						
Each pedestal type and accessory has a corresponding character:								
M	Mobile							
H	Hanging/suspended							
F	Freestanding							
W	Worksurface supporting							
P	3" pencil drawer							
B	6" box drawer							
F	12" file drawer							
X	No front							
W1	Wood front							
NOTE: The unit must SPECIFY optional CBW as INSTALLED or they will be shipped separately.								



General Information (continued)

Nonstock Plastic Laminate Surfaces

Additional laminates are available but may be subject to additional lead time. Other special laminates require an up-charge and additional lead time. Contact KI.

Special Paint Finishes

All special colors, including other manufacturers' standard enamel finishes, are available subject to the following conditions.

1. Two steel color chips (minimum 2.5"x3.5") are requested for color matching purposes. Paper samples are acceptable, however, a reasonable tolerance must be allowed when comparing the two variations.

2. All nonstandard colors are available at no additional charge (excluding hi-chromatic colors), but may be subject to extended lead times. Order will not be processed until color match is approved. Written confirmation must accompany order.

Field Reconfiguration

As needs change, KI pedestals can readily be field-changed; however, this process should be undertaken by a qualified service technician.

Inside Dimensions of Drawers

	17 ⁵ / ₈ "D PEDESTAL			21 ⁵ / ₈ "D PEDESTAL			27 ⁵ / ₈ "D PEDESTAL		
	W	D	H	W	D	H	W	D	H
6" Box	12 ¹ / ₈ "	16 ¹ / ₄ "	5 ¹ / ₈ "	12 ¹ / ₈ "	19 ⁵ / ₁₆ "	5 ¹ / ₈ "	12 ¹ / ₈ "	25 ¹³ / ₁₆ "	5 ¹ / ₈ "
12" File	12 ¹ / ₈ "	15 ³ / ₄ "	11"	12 ¹ / ₈ "	18 ¹³ / ₁₆ "	11"	12 ¹ / ₈ "	25 ⁵ / ₁₆ "	11"

Pedestal Heights and Depths

	Depths*	Heights Including Glides	Heights Including Casters	Heights Without Glides/Casters
Freestanding	21 ⁵ / ₈ " , 27 ⁵ / ₈ "	25 ⁵ / ₁₆ "		
Mobile	21 ⁵ / ₈ " , 27 ⁵ / ₈ "		27 ⁵ / ₈ "	
Hanging	17 ⁵ / ₈ " , 21 ⁵ / ₈ " , 27 ⁵ / ₈ "			19 ³ / ₁₆ "

* including 3/4" thick fronts.

700 Series® OF Pedestals

General Information

The information outlined below should be used to communicate critical dimensions for various drawer fronts. Larger drawings are available for specific size fronts. Contact Customer Service for availability.

The KI product is designed for 3/4" thick fronts. Thinner or thicker file fronts can be adapted to flush top product only. Please be aware that on fronts with thickness different from 3/4" the lock barrel will protrude from or be recessed into the filler rail by the dimension the fronts differ from 3/4".

On extended top product, the top rail is not required. It is integral to the shell construction, and is painted the color of the cabinet. KI center pulls are available for installation on custom fronts. **Note:** the drawings on this page do not provide allowance for KI drawer pulls. Drawings are available for fronts with an allowance for KI drawer pulls.

The hardware necessary for mounting the drawer fronts will vary depending on the material used. The parts supplied by KI are for use when mounting medium or high-density particle or fiberboard core fronts.

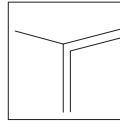
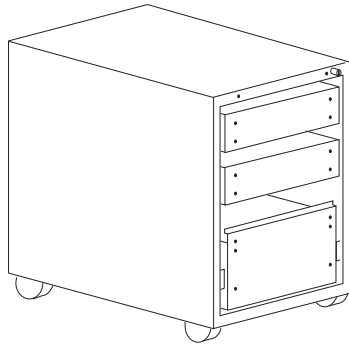

Flush Top

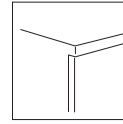

Extended Top

15" Filler Rail

(For flush top applications only)

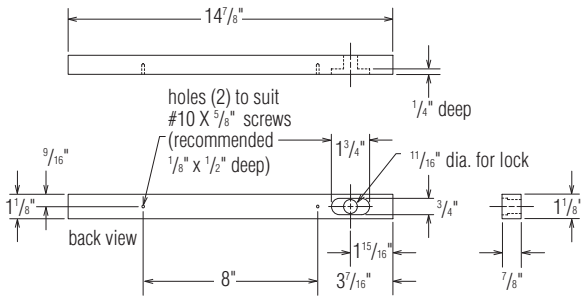

6 x 15" Pedestal Front

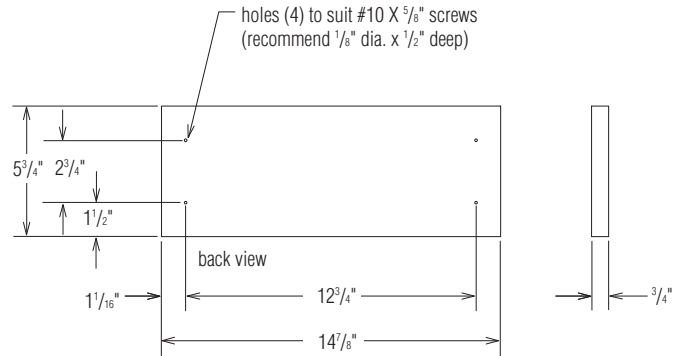

12 x 15" Pedestal Front

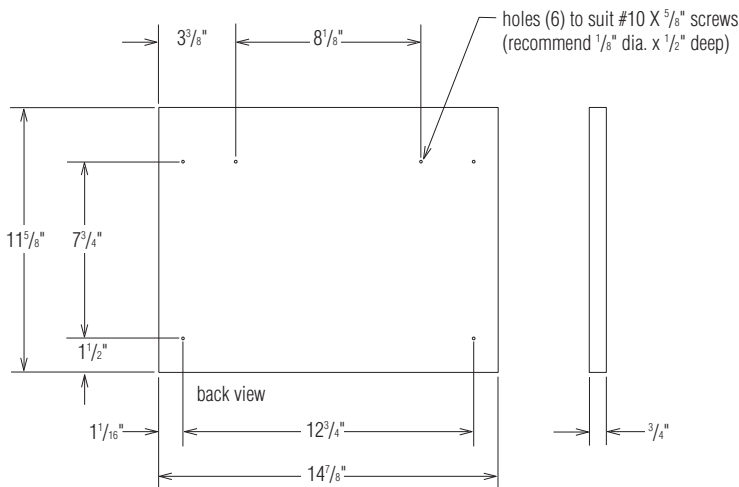



700 Series[®] OF Pedestals





General Information

Fabric

Fabric will be applied as swatched by the fabric manufacturer. Fabric that is required to be applied differently than is swatched will need a Special Cost Request written specifying the direction the fabric is to be applied. The posted standard lead time will apply to the Special Cost Request.

Pedestals - Mobile and Freestanding

700 Series®

	MODEL	Features	W x D x H	MODEL NUMBER					
				Basic Model	Pull Option	Unit Color	Optional Counterbalance Weight	Key Option	
 <p>S7PDU</p>	Pedestal - BFTP • Top surface of pedestal has black, four compartment pencil tray and black recessed pull • 6" box drawer with partition • 12" file drawer with partition • Anti-tip caster travels with file drawer • Counterbalance weight not required • Only use 21-5/8" D peds with 30" D desks	Mobile	15 x 21-5/8 x 21-3/4"	S7P/1524MBFTP	<input type="checkbox"/> <input type="checkbox"/> <input type="checkbox"/> <input type="checkbox"/>	<input type="checkbox"/>		<input type="checkbox"/> <input type="checkbox"/>	
 <p>S7PDU</p>	Pedestal - BF • One 6" box drawer, one 12" file drawer with hanging folder partition • 5th wheel in lieu of counterbalance weight • Only use 21-5/8" D peds with 30" D desks	Mobile	15 x 17-5/8 x 21-3/4"	S7P/1520MBF	<input type="checkbox"/> <input type="checkbox"/> <input type="checkbox"/> <input type="checkbox"/>	<input type="checkbox"/>		<input type="checkbox"/> <input type="checkbox"/>	
		Mobile	15 x 21-5/8 x 21-3/4"	S7P/1524MBF	<input type="checkbox"/> <input type="checkbox"/> <input type="checkbox"/> <input type="checkbox"/>	<input type="checkbox"/>		<input type="checkbox"/> <input type="checkbox"/>	
		Mobile	15 x 27-5/8 x 21-3/4"	S7P/1530MBF	<input type="checkbox"/> <input type="checkbox"/> <input type="checkbox"/> <input type="checkbox"/>	<input type="checkbox"/>		<input type="checkbox"/> <input type="checkbox"/>	
 <p>S7PDU</p>	Pedestal - BBB • Three 6" box drawers • 5th wheel in lieu of counterbalance weight • Only use 21-5/8" D peds with 30" D desks	Mobile	15 x 17-5/8 x 21-3/4"	S7P/1520MBBB	<input type="checkbox"/> <input type="checkbox"/> <input type="checkbox"/> <input type="checkbox"/>	<input type="checkbox"/>		<input type="checkbox"/> <input type="checkbox"/>	
		Mobile	15 x 21-5/8 x 21-3/4"	S7P/1524MBBB	<input type="checkbox"/> <input type="checkbox"/> <input type="checkbox"/> <input type="checkbox"/>	<input type="checkbox"/>		<input type="checkbox"/> <input type="checkbox"/>	
		Mobile	15 x 27-5/8 x 21-3/4"	S7P/1530MBBB	<input type="checkbox"/> <input type="checkbox"/> <input type="checkbox"/> <input type="checkbox"/>	<input type="checkbox"/>		<input type="checkbox"/> <input type="checkbox"/>	
 <p>S7PDU</p>	Pedestal - PBF • One 3" pencil drawer; one 6" box drawer; one 12" file drawer with hanging folder partition • Mobile units include 5th wheel in lieu of counterbalance weight • Counterbalance is recommended in freestanding pedestals • Only use 21-5/8" D peds with 30" D desks	Freestanding	15 x 17-5/8 x 22-3/8"	S7P/1520FPBF	<input type="checkbox"/> <input type="checkbox"/> <input type="checkbox"/> <input type="checkbox"/>	<input type="checkbox"/>	<input type="checkbox"/> <input type="checkbox"/> <input type="checkbox"/> <input type="checkbox"/>	<input type="checkbox"/> <input type="checkbox"/>	
		Mobile	15 x 17-5/8 x 24-11/16"	S7P/1520MPBF	<input type="checkbox"/> <input type="checkbox"/> <input type="checkbox"/> <input type="checkbox"/>	<input type="checkbox"/>		<input type="checkbox"/> <input type="checkbox"/>	
		Freestanding	15 x 21-5/8 x 22-3/8"	S7P/1524FPBF	<input type="checkbox"/> <input type="checkbox"/> <input type="checkbox"/> <input type="checkbox"/>	<input type="checkbox"/>	<input type="checkbox"/> <input type="checkbox"/> <input type="checkbox"/> <input type="checkbox"/>	<input type="checkbox"/> <input type="checkbox"/>	
		Mobile	15 x 21-5/8 x 24-11/16"	S7P/1524MPBF	<input type="checkbox"/> <input type="checkbox"/> <input type="checkbox"/> <input type="checkbox"/>	<input type="checkbox"/>		<input type="checkbox"/> <input type="checkbox"/>	
		Freestanding	15 x 27-5/8 x 22-3/8"	S7P/1530FPBF	<input type="checkbox"/> <input type="checkbox"/> <input type="checkbox"/> <input type="checkbox"/>	<input type="checkbox"/>	<input type="checkbox"/> <input type="checkbox"/> <input type="checkbox"/> <input type="checkbox"/>	<input type="checkbox"/> <input type="checkbox"/>	
		Mobile	15 x 27-5/8 x 24-11/16"	S7P/1530MPBF	<input type="checkbox"/> <input type="checkbox"/> <input type="checkbox"/> <input type="checkbox"/>	<input type="checkbox"/>		<input type="checkbox"/> <input type="checkbox"/>	

A **B** **C** **D** **E**

HOW TO ORDER

Indicate the following information on order form:

- Quantity of each item.
- Model number, including options. See "How To Build a Model Number".
- Any special service required.

Note: • The indicates that a choice is required.

- The absence of the indicates that no choice is required.
- Alpha-numeric characters in place of indicate that no other alternatives are available.

HOW TO BUILD A MODEL NUMBER

NLC - No lock core

- A** Select basic model.
 - ALBT** - Aluminum bow tie
 - ALMT** - Aluminum metric
 - ARCN** - Arc nickel
 - CLSC** - Classic (inset pull)
 - NKBT** - Nickel bow tie
 - RETN** - Retro nickel
- C** Select unit and drawer color.
Refer to color addendum at ki.com or KI Fabrics & Finishes binder.
- D** Select counterbalance weight.
 - CBW** - With Counterbalance
 - NOCBW** - No Counterbalance
 See pricing column for counterbalance weight upcharge.
- E** Select key option.
 - KA** - Key alike
 - KS** - Key standard

INFORMATION

Height

All freestanding pedestals include 1/4" allowance for glides in recessed position. Mobile pedestals include 2-5/16" allowance for casters.

Accessories

See accessory section for accessories that can be ordered separately.

Weights

Figures provided are approximate and reflect packaged product without additional accessories.



Pedestals - Mobile and Freestanding

700 Series®

Approx. Packaged Weight	Delivered Pricing	Counter- balance Weight add to list price
79.0#	\$ 798	N/A
79.0#	\$ 695	N/A
90.0#	798	N/A
93.0#	798	N/A
83.0#	\$ 798	N/A
92.0#	774	N/A
95.0#	774	N/A
53.0#	\$ 729	\$ 166
89.0#	871	N/A
55.0#	769	142
90.0#	829	N/A
75.0#	819	82
95.0#	881	N/A

SPECIAL SERVICES

Special Carton Marking

With specially marked information N/C





Shipping

Shipped **assembled freight prepaid f.o.b. Pembroke, Ontario K8A 0E1** factory.
Freight class #70.

Specifications and prices are subject to change without prior notice.

Pedestals - Mobile and Freestanding

700 Series®

MODEL	Features	W x D x H	MODEL NUMBER				
			Basic Model	Pull Option	Unit Color	Optional Counterbalance Weight	Key Option
 <p>Pedestal - FF</p> <ul style="list-style-type: none"> Two 12" file drawers with hanging folder partitions Counterbalance weight: included in mobile unit; recommended in freestanding pedestals Only use 21-5/8" D peds with 30" D desks 	Freestanding	15 x 17-5/8 x 25-5/16"	S7P/1520FFF	<input type="checkbox"/> <input type="checkbox"/> <input type="checkbox"/> <input type="checkbox"/>	<input type="checkbox"/>	<input type="checkbox"/> <input type="checkbox"/> <input type="checkbox"/> <input type="checkbox"/>	<input type="checkbox"/> <input type="checkbox"/>
	Mobile	15 x 17-5/8 x 27-5/8"	S7P/1520MFF	<input type="checkbox"/> <input type="checkbox"/> <input type="checkbox"/> <input type="checkbox"/>	<input type="checkbox"/>	<input type="checkbox"/> <input type="checkbox"/> <input type="checkbox"/> <input type="checkbox"/>	<input type="checkbox"/> <input type="checkbox"/>
	Freestanding	15 x 21-5/8 x 25-5/16"	S7P/1524FFF	<input type="checkbox"/> <input type="checkbox"/> <input type="checkbox"/> <input type="checkbox"/>	<input type="checkbox"/>	<input type="checkbox"/> <input type="checkbox"/> <input type="checkbox"/> <input type="checkbox"/>	<input type="checkbox"/> <input type="checkbox"/>
	Mobile	15 x 21-5/8 x 27-5/8"	S7P/1524MFF	<input type="checkbox"/> <input type="checkbox"/> <input type="checkbox"/> <input type="checkbox"/>	<input type="checkbox"/>	<input type="checkbox"/> <input type="checkbox"/> <input type="checkbox"/> <input type="checkbox"/>	<input type="checkbox"/> <input type="checkbox"/>
	Freestanding	15 x 27-5/8 x 25-5/16"	S7P/1530FFF	<input type="checkbox"/> <input type="checkbox"/> <input type="checkbox"/> <input type="checkbox"/>	<input type="checkbox"/>	<input type="checkbox"/> <input type="checkbox"/> <input type="checkbox"/> <input type="checkbox"/>	<input type="checkbox"/> <input type="checkbox"/>
	Mobile	15 x 27-5/8 x 27-5/8"	S7P/1530MFF	<input type="checkbox"/> <input type="checkbox"/> <input type="checkbox"/> <input type="checkbox"/>	<input type="checkbox"/>	<input type="checkbox"/> <input type="checkbox"/> <input type="checkbox"/> <input type="checkbox"/>	<input type="checkbox"/> <input type="checkbox"/>
S7PDU							
 <p>Pedestal - BBF</p> <ul style="list-style-type: none"> Two 6" box drawers; one 12" file drawer with hanging folder partition Counterbalance weight: included in mobile unit; recommended in freestanding pedestals Only use 21-5/8" D peds with 30" D desks 	Freestanding	15 x 17-5/8 x 25-5/16"	S7P/1520BBF	<input type="checkbox"/> <input type="checkbox"/> <input type="checkbox"/> <input type="checkbox"/>	<input type="checkbox"/>	<input type="checkbox"/> <input type="checkbox"/> <input type="checkbox"/> <input type="checkbox"/>	<input type="checkbox"/> <input type="checkbox"/>
	Mobile	15 x 17-5/8 x 27-5/8"	S7P/1520MBBF	<input type="checkbox"/> <input type="checkbox"/> <input type="checkbox"/> <input type="checkbox"/>	<input type="checkbox"/>	<input type="checkbox"/> <input type="checkbox"/> <input type="checkbox"/> <input type="checkbox"/>	<input type="checkbox"/> <input type="checkbox"/>
	Freestanding	15 x 21-5/8 x 25-5/16"	S7P/1524BBF	<input type="checkbox"/> <input type="checkbox"/> <input type="checkbox"/> <input type="checkbox"/>	<input type="checkbox"/>	<input type="checkbox"/> <input type="checkbox"/> <input type="checkbox"/> <input type="checkbox"/>	<input type="checkbox"/> <input type="checkbox"/>
	Mobile	15 x 21-5/8 x 27-5/8"	S7P/1524MBBF	<input type="checkbox"/> <input type="checkbox"/> <input type="checkbox"/> <input type="checkbox"/>	<input type="checkbox"/>	<input type="checkbox"/> <input type="checkbox"/> <input type="checkbox"/> <input type="checkbox"/>	<input type="checkbox"/> <input type="checkbox"/>
	Freestanding	15 x 27-5/8 x 25-5/16"	S7P/1530BBF	<input type="checkbox"/> <input type="checkbox"/> <input type="checkbox"/> <input type="checkbox"/>	<input type="checkbox"/>	<input type="checkbox"/> <input type="checkbox"/> <input type="checkbox"/> <input type="checkbox"/>	<input type="checkbox"/> <input type="checkbox"/>
	Mobile	15 x 27-5/8 x 27-5/8"	S7P/1530MBBF	<input type="checkbox"/> <input type="checkbox"/> <input type="checkbox"/> <input type="checkbox"/>	<input type="checkbox"/>	<input type="checkbox"/> <input type="checkbox"/> <input type="checkbox"/> <input type="checkbox"/>	<input type="checkbox"/> <input type="checkbox"/>
S7PDU							
 <p>Pedestal - BBBB</p> <ul style="list-style-type: none"> Four 6" box drawers Counterbalance weight: included in mobile unit; recommended in freestanding pedestals Only use 21-5/8" D peds with 30" D desks 	Freestanding	15 x 17-5/8 x 25-5/16"	S7P/1520BBBB	<input type="checkbox"/> <input type="checkbox"/> <input type="checkbox"/> <input type="checkbox"/>	<input type="checkbox"/>	<input type="checkbox"/> <input type="checkbox"/> <input type="checkbox"/> <input type="checkbox"/>	<input type="checkbox"/> <input type="checkbox"/>
	Mobile	15 x 17-5/8 x 27-5/8"	S7P/1520MBBBB	<input type="checkbox"/> <input type="checkbox"/> <input type="checkbox"/> <input type="checkbox"/>	<input type="checkbox"/>	<input type="checkbox"/> <input type="checkbox"/> <input type="checkbox"/> <input type="checkbox"/>	<input type="checkbox"/> <input type="checkbox"/>
	Freestanding	15 x 21-5/8 x 25-5/16"	S7P/1524BBBB	<input type="checkbox"/> <input type="checkbox"/> <input type="checkbox"/> <input type="checkbox"/>	<input type="checkbox"/>	<input type="checkbox"/> <input type="checkbox"/> <input type="checkbox"/> <input type="checkbox"/>	<input type="checkbox"/> <input type="checkbox"/>
	Mobile	15 x 21-5/8 x 27-5/8"	S7P/1524MBBBB	<input type="checkbox"/> <input type="checkbox"/> <input type="checkbox"/> <input type="checkbox"/>	<input type="checkbox"/>	<input type="checkbox"/> <input type="checkbox"/> <input type="checkbox"/> <input type="checkbox"/>	<input type="checkbox"/> <input type="checkbox"/>
	Freestanding	15 x 27-5/8 x 25-5/16"	S7P/1530BBBB	<input type="checkbox"/> <input type="checkbox"/> <input type="checkbox"/> <input type="checkbox"/>	<input type="checkbox"/>	<input type="checkbox"/> <input type="checkbox"/> <input type="checkbox"/> <input type="checkbox"/>	<input type="checkbox"/> <input type="checkbox"/>
	Mobile	15 x 27-5/8 x 27-5/8"	S7P/1530MBBBB	<input type="checkbox"/> <input type="checkbox"/> <input type="checkbox"/> <input type="checkbox"/>	<input type="checkbox"/>	<input type="checkbox"/> <input type="checkbox"/> <input type="checkbox"/> <input type="checkbox"/>	<input type="checkbox"/> <input type="checkbox"/>
S7PDU							
 <p>Pedestal - PBBB</p> <ul style="list-style-type: none"> One 3" pencil drawer; three 6" box drawers Counterbalance weight: included in mobile unit; recommended in freestanding pedestals Only use 21-5/8" D peds with 30" D desks 	Freestanding	15 x 17-5/8 x 22-3/8"	S7P/1520FPBBB	<input type="checkbox"/> <input type="checkbox"/> <input type="checkbox"/> <input type="checkbox"/>	<input type="checkbox"/>	<input type="checkbox"/> <input type="checkbox"/> <input type="checkbox"/> <input type="checkbox"/>	<input type="checkbox"/> <input type="checkbox"/>
	Mobile	15 x 17-5/8 x 24-11/16"	S7P/1520MPBBB	<input type="checkbox"/> <input type="checkbox"/> <input type="checkbox"/> <input type="checkbox"/>	<input type="checkbox"/>	<input type="checkbox"/> <input type="checkbox"/> <input type="checkbox"/> <input type="checkbox"/>	<input type="checkbox"/> <input type="checkbox"/>
	Freestanding	15 x 21-5/8 x 22-3/8"	S7P/1524FPBBB	<input type="checkbox"/> <input type="checkbox"/> <input type="checkbox"/> <input type="checkbox"/>	<input type="checkbox"/>	<input type="checkbox"/> <input type="checkbox"/> <input type="checkbox"/> <input type="checkbox"/>	<input type="checkbox"/> <input type="checkbox"/>
	Mobile	15 x 21-5/8 x 24-11/16"	S7P/1524MPBBB	<input type="checkbox"/> <input type="checkbox"/> <input type="checkbox"/> <input type="checkbox"/>	<input type="checkbox"/>	<input type="checkbox"/> <input type="checkbox"/> <input type="checkbox"/> <input type="checkbox"/>	<input type="checkbox"/> <input type="checkbox"/>
	Freestanding	15 x 27-5/8 x 22-3/8"	S7P/1530FPBBB	<input type="checkbox"/> <input type="checkbox"/> <input type="checkbox"/> <input type="checkbox"/>	<input type="checkbox"/>	<input type="checkbox"/> <input type="checkbox"/> <input type="checkbox"/> <input type="checkbox"/>	<input type="checkbox"/> <input type="checkbox"/>
	Mobile	15 x 27-5/8 x 24-11/16"	S7P/1530MPBBB	<input type="checkbox"/> <input type="checkbox"/> <input type="checkbox"/> <input type="checkbox"/>	<input type="checkbox"/>	<input type="checkbox"/> <input type="checkbox"/> <input type="checkbox"/> <input type="checkbox"/>	<input type="checkbox"/> <input type="checkbox"/>
S7PDU							

A **B** **C** **D** **E**

HOW TO ORDER

Indicate the following information on order form:

- Quantity of each item.
- Model number, including options. See "How To Build a Model Number".
- Any special service required.

Note: • The indicates that a choice is required.

- The absence of the indicates that no choice is required.
- Alpha-numeric characters in place of indicate that no other alternatives are available.

HOW TO BUILD A MODEL NUMBER

NLC - No lock core

- A** Select basic model.
 - ALBT** - Aluminum bow tie
 - ALMT** - Aluminum metric
 - ARCN** - Arc nickel
 - CLSC** - Classic (inset pull)
 - NKBT** - Nickel bow tie
 - RETN** - Retro nickel
- C** Select unit and drawer color. Refer to color addendum at ki.com or KI Fabrics & Finishes binder.
- D** Select counterbalance weight.
 - CBW** - With Counterbalance
 - NOCBW** - No Counterbalance
 See pricing column for counterbalance weight upcharge.
- E** Select key option.
 - KA** - Key alike
 - KS** - Key standard

INFORMATION

Height

All freestanding pedestals include 1/4" allowance for glides in recessed position. Mobile pedestals include 2-5/16" allowance for casters.

Accessories

See accessory section for accessories that can be ordered separately.

Weights

Figures provided are approximate and reflect packaged product without additional accessories.



Pedestals - Mobile and Freestanding

700 Series®

Approx. Packaged Weight	Delivered Pricing	Counter-balance Weight add to list price
55.0#	\$ 666	\$ 166
93.0#	739	N/A
55.0#	700	142
90.0#	767	N/A
75.0#	746	82
95.0#	809	N/A
<hr/>		
57.0#	\$ 700	\$ 166
93.0#	805	N/A
60.0#	739	142
95.0#	848	N/A
80.0#	834	82
100.0#	882	N/A
<hr/>		
59.0#	\$ 755	\$ 166
95.0#	921	N/A
66.0#	798	142
105.0#	893	N/A
78.0#	871	82
96.0#	921	N/A
<hr/>		
62.0#	\$ 809	\$ 166
91.0#	971	N/A
62.0#	854	142
102.0#	950	N/A
73.0#	871	82
91.0#	921	N/A

SPECIAL SERVICES

Special Carton Marking

With specially marked information N/C

Shipping

Shipped **assembled freight prepaid f.o.b. Pembroke, Ontario K8A 0E1** factory.
Freight class #70.

Specifications and prices are subject to change without prior notice.

Pedestals - Mobile and Freestanding

700 Series® Curve

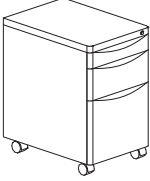
			MODEL NUMBER						Approx. Packaged Weight
Features	W x D x H	Basic Model	Dimpled	Unit Color	Pull Color	Optional Counterbalance Weight	Key Option		
 <p>S7CP Pedestal - BF</p> <ul style="list-style-type: none"> • One 6" box drawer • One 12" file drawer with hanging folder partition • Mobile units include 5th wheel in lieu of counterbalance weight 	Mobile	15 x 17-5/8 x 21-3/4"	S7CP1520MBF	<input type="checkbox"/>	□□□	□□□□□□□□		□□□	79.0#
	Mobile	15 x 21-5/8 x 21-3/4"	S7CP1524MBF	<input type="checkbox"/>	□□□	□□□□□□□□		□□□	90.0#
	Mobile	15 x 27-5/8 x 21-3/4"	S7CP1530MBF	<input type="checkbox"/>	□□□	□□□□□□□□		□□□	93.0#
 <p>S7CP Pedestal - PBF</p> <ul style="list-style-type: none"> • One 3" pencil drawer • One 6" box drawer • One 12" file drawer with hanging folder partition • Mobile units include 5th wheel in lieu of counterbalance weight • Counterbalance weight is recommended in freestanding pedestals 	Mobile	15 x 17-5/8 x 24-11/16"	S7CP1520MPBF	<input type="checkbox"/>	□□□	□□□□□□□□		□□□	89.0#
	Freestanding	15 x 21-5/8 x 22-3/8"	S7CP1524FPBF	<input type="checkbox"/>	□□□	□□□□□□□□	□□□□□□	□□□	55.0#
	Mobile	15 x 21-5/8 x 24-11/16"	S7CP1524MPBF	<input type="checkbox"/>	□□□	□□□□□□□□		□□□	90.0#
	Freestanding	15 x 27-5/8 x 22-3/8"	S7CP1530FPBF	<input type="checkbox"/>	□□□	□□□□□□□□	□□□□□□	□□□	75.0#
	Mobile	15 x 27-5/8 x 24-11/16"	S7CP1530MPBF	<input type="checkbox"/>	□□□	□□□□□□□□		□□□	95.0#
			A	B	C	D	E	F	

HOW TO ORDER

Indicate the following information on order form:

1. Quantity of each item.
2. Model number, including options. See "How To Build a Model Number".
3. Any special service required.

Note: • The indicates that a choice is required.
 • The absence of the indicates that no choice is required.
 • Alpha-numeric characters in place of indicate that no other alternatives are available.

HOW TO BUILD A MODEL NUMBER

- A** Select basic model.
- B** Select flat or dimpled front.
 D - Dimpled
 F - Flat
 See upcharge column for D option.
- C** Select unit and drawer color.
 Refer to color addendum at ki.com or KI Fabrics & Finishes binder.
- D** Select drawer pull color.
 Refer to color addendum at ki.com or KI Fabrics & Finishes binder.
- E** Select counterbalance weight.
 CBW - With Counterbalance
 NOCBW - No Counterbalance
 See pricing column for counterbalance weight upcharge.
- F** Select key option.
 KA - Key alike

KS - Key standard
 NLC - No lock core

INFORMATION

Height

All freestanding pedestals include 1/4" allowance for glides in recessed position. Mobile pedestals include 2-5/16" allowance for casters.

Accessories

See accessory section for accessories that can be ordered separately.

Weights

Figures provided are approximate and reflect packaged product without additional accessories.



Pedestals - Mobile and Freestanding

700 Series® Curve

Delivered Pricing	Dimpled Front add to list price	Counter-balance Weight add to list price
\$ 777	\$ 14	N/A
890	15	N/A
890	15	N/A
\$ 977	\$ 16	N/A
860	15	142
929	16	N/A
919	16	82
986	16	N/A

SPECIAL SERVICES

Special Carton Marking

With specially marked information N/C



Shipping

Shipped **assembled freight prepaid f.o.b. Pembroke, Ontario K8A 0E1** factory. Freight class #70.

Specifications and prices are subject to change without prior notice.

Pedestals - Mobile and Freestanding

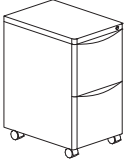
700 Series® Curve

			MODEL NUMBER						Approx. Packaged Weight
Features	W x D x H	Basic Model	Dimpled	Unit Color	Pull Color	Optional Counterbalance Weight	Key Option		
 <p>S7CP Pedestal - FF</p> <ul style="list-style-type: none"> Two 12" file drawers with hanging folder partitions Counterbalance weight included in mobile unit Counterbalance is recommended in freestanding pedestals 	Mobile	15 x 17-5/8 x 27-5/8"	S7CP1520MFF	<input type="checkbox"/>	<input type="checkbox"/> <input type="checkbox"/>	<input type="checkbox"/> <input type="checkbox"/> <input type="checkbox"/> <input type="checkbox"/> <input type="checkbox"/> <input type="checkbox"/>		<input type="checkbox"/> <input type="checkbox"/> <input type="checkbox"/>	93.0#
	Freestanding	15 x 21-5/8 x 25-5/16"	S7CP1524FFF	<input type="checkbox"/>	<input type="checkbox"/> <input type="checkbox"/>	<input type="checkbox"/> <input type="checkbox"/> <input type="checkbox"/> <input type="checkbox"/> <input type="checkbox"/> <input type="checkbox"/>	<input type="checkbox"/> <input type="checkbox"/> <input type="checkbox"/> <input type="checkbox"/>	<input type="checkbox"/> <input type="checkbox"/> <input type="checkbox"/>	55.0#
	Mobile	15 x 21-5/8 x 27-5/8"	S7CP1524MFF	<input type="checkbox"/>	<input type="checkbox"/> <input type="checkbox"/>	<input type="checkbox"/> <input type="checkbox"/> <input type="checkbox"/> <input type="checkbox"/> <input type="checkbox"/> <input type="checkbox"/>		<input type="checkbox"/> <input type="checkbox"/> <input type="checkbox"/>	90.0#
	Freestanding	15 x 27-5/8 x 25-5/16"	S7CP1530FFF	<input type="checkbox"/>	<input type="checkbox"/> <input type="checkbox"/>	<input type="checkbox"/> <input type="checkbox"/> <input type="checkbox"/> <input type="checkbox"/> <input type="checkbox"/> <input type="checkbox"/>	<input type="checkbox"/> <input type="checkbox"/> <input type="checkbox"/> <input type="checkbox"/>	<input type="checkbox"/> <input type="checkbox"/> <input type="checkbox"/>	75.0#
	Mobile	15 x 27-5/8 x 27-5/8"	S7CP1530MFF	<input type="checkbox"/>	<input type="checkbox"/> <input type="checkbox"/>	<input type="checkbox"/> <input type="checkbox"/> <input type="checkbox"/> <input type="checkbox"/> <input type="checkbox"/> <input type="checkbox"/>		<input type="checkbox"/> <input type="checkbox"/> <input type="checkbox"/>	95.0#
 <p>S7CP Pedestal - BBF</p> <ul style="list-style-type: none"> Two 6" box drawers One 12" file drawer with hanging partition Counterbalance is recommended in freestanding pedestals 5th wheel in lieu of counterbalance weight on mobile pedestal 	Mobile	15 x 17-5/8 x 27-5/8"	S7CP1520MBBF	<input type="checkbox"/>	<input type="checkbox"/> <input type="checkbox"/>	<input type="checkbox"/> <input type="checkbox"/> <input type="checkbox"/> <input type="checkbox"/> <input type="checkbox"/> <input type="checkbox"/>		<input type="checkbox"/> <input type="checkbox"/> <input type="checkbox"/>	93.0#
	Freestanding	15 x 21-5/8 x 25-5/16"	S7CP1524FBBF	<input type="checkbox"/>	<input type="checkbox"/> <input type="checkbox"/>	<input type="checkbox"/> <input type="checkbox"/> <input type="checkbox"/> <input type="checkbox"/> <input type="checkbox"/> <input type="checkbox"/>	<input type="checkbox"/> <input type="checkbox"/> <input type="checkbox"/> <input type="checkbox"/>	<input type="checkbox"/> <input type="checkbox"/> <input type="checkbox"/>	60.0#
	Mobile	15 x 21-5/8 x 27-5/8"	S7CP1524MBBF	<input type="checkbox"/>	<input type="checkbox"/> <input type="checkbox"/>	<input type="checkbox"/> <input type="checkbox"/> <input type="checkbox"/> <input type="checkbox"/> <input type="checkbox"/> <input type="checkbox"/>		<input type="checkbox"/> <input type="checkbox"/> <input type="checkbox"/>	95.0#
	Freestanding	15 x 27-5/8 x 25-5/16"	S7CP1530FBBF	<input type="checkbox"/>	<input type="checkbox"/> <input type="checkbox"/>	<input type="checkbox"/> <input type="checkbox"/> <input type="checkbox"/> <input type="checkbox"/> <input type="checkbox"/> <input type="checkbox"/>	<input type="checkbox"/> <input type="checkbox"/> <input type="checkbox"/> <input type="checkbox"/>	<input type="checkbox"/> <input type="checkbox"/> <input type="checkbox"/>	80.0#
	Mobile	15 x 27-5/8 x 27-5/8"	S7CP1530MBBF	<input type="checkbox"/>	<input type="checkbox"/> <input type="checkbox"/>	<input type="checkbox"/> <input type="checkbox"/> <input type="checkbox"/> <input type="checkbox"/> <input type="checkbox"/> <input type="checkbox"/>		<input type="checkbox"/> <input type="checkbox"/> <input type="checkbox"/>	100.0#
			A	B	C	D	E	F	

HOW TO ORDER

Indicate the following information on order form:

- Quantity of each item.
- Model number, including options. See "How To Build a Model Number".
- Any special service required.

Note:

- The indicates that a choice is required.
- The absence of the indicates that no choice is required.
- Alpha-numeric characters in place of indicate that no other alternatives are available.

HOW TO BUILD A MODEL NUMBER

- A** Select basic model.
- B** Select flat or dimpled front.
 - D** - Dimpled
 - F** - Flat
 See upcharge column for D option.
- C** Select unit and drawer color. Refer to color addendum at ki.com or KI Fabrics & Finishes binder.
- D** Select drawer pull color. Refer to color addendum at ki.com or KI Fabrics & Finishes binder.
- E** Select counterbalance weight.
 - CBW** - With Counterbalance
 - NOCBW** - No Counterbalance
 See pricing column for counterbalance weight upcharge.
- F** Select key option.
 - KA** - Key alike

KS - Key standard
NLC - No lock core

INFORMATION

Height

All freestanding pedestals include 1/4" allowance for glides in recessed position. Mobile pedestals include 2-5/16" allowance for casters.

Accessories

See accessory section for accessories that can be ordered separately.

Weights

Figures provided are approximate and reflect packaged product without additional accessories.



Pedestals - Mobile and Freestanding

700 Series® Curve

Delivered Pricing		Dimpled Front add to list price	Counter-balance Weight add to list price
\$ 826		\$ 14	N/A
783		14	142
858		15	N/A
833		15	82
906		15	N/A
\$ 900		\$ 15	N/A
826		14	142
949		16	N/A
934		16	82
987		16	N/A

SPECIAL SERVICES

Special Carton Marking

With specially marked information N/C

Shipping

Shipped **assembled freight prepaid f.o.b. Pembroke, Ontario K8A 0E1** factory. Freight class #70.

Specifications and prices are subject to change without prior notice.

Pedestals - Mobile and Freestanding

700 Series® OF Flush Top No Front

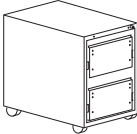
MODEL	Features	W x D x H	MODEL NUMBER			
			Basic Model	Unit Color	Optional Counterbalance Weight	Key Option
 S7POU Pedestal - BBFX • No drawer fronts • Two drawer bodies to accept 6" fronts • One drawer body to accept 12" front • Counterbalance weight included in mobile units • Counterbalance is recommended in freestanding pedestals • Hardware included	Freestanding	15 x 20-3/4 x 25-5/16"	S7PF/1524FBBFX	<input type="checkbox"/>	<input type="checkbox"/> <input type="checkbox"/> <input type="checkbox"/> <input type="checkbox"/>	<input type="checkbox"/> <input type="checkbox"/>
	Mobile	15 x 20-3/4 x 27-5/8"	S7PF/1524MBBFX	<input type="checkbox"/>		<input type="checkbox"/> <input type="checkbox"/>
	Freestanding	15 x 26-3/4 x 25-5/16"	S7PF/1530FBBFX	<input type="checkbox"/>	<input type="checkbox"/> <input type="checkbox"/> <input type="checkbox"/> <input type="checkbox"/>	<input type="checkbox"/> <input type="checkbox"/>
	Mobile	15 x 26-3/4 x 27-5/8"	S7PF/1530MBBFX	<input type="checkbox"/>		<input type="checkbox"/> <input type="checkbox"/>
 S7POU Pedestal - FFX • No drawer fronts • Two drawer bodies to accept 12" fronts • Counterbalance weight included in mobile units • Counterbalance is recommended in freestanding pedestals • Hardware included	Freestanding	15 x 20-3/4 x 25-5/16"	S7PF/1524FFFX	<input type="checkbox"/>	<input type="checkbox"/> <input type="checkbox"/> <input type="checkbox"/> <input type="checkbox"/>	<input type="checkbox"/> <input type="checkbox"/>
	Mobile	15 x 20-3/4 x 27-5/8"	S7PF/1524MFFX	<input type="checkbox"/>		<input type="checkbox"/> <input type="checkbox"/>
	Freestanding	15 x 26-3/4 x 25-5/16"	S7PF/1530FFFX	<input type="checkbox"/>	<input type="checkbox"/> <input type="checkbox"/> <input type="checkbox"/> <input type="checkbox"/>	<input type="checkbox"/> <input type="checkbox"/>
	Mobile	15 x 26-3/4 x 27-5/8"	S7PF/1530MFFX	<input type="checkbox"/>		<input type="checkbox"/> <input type="checkbox"/>

A **B** **C** **D**

HOW TO ORDER

Indicate the following information on order form:

- Quantity of each item.
- Model number, including options. See "How To Build a Model Number".
- Any special service required.

Note:

- The indicates that a choice is required.
- The absence of the indicates that no choice is required.
- Alpha-numeric characters in place of indicate that no other alternatives are available.

HOW TO BUILD A MODEL NUMBER

- A** Select basic model.
- B** Select unit color.
Refer to color addendum at ki.com or KI Fabrics & Finishes binder.
- C** Select counterbalance weight.

CBW	- With Counterbalance
NOCBW	- No Counterbalance

 See pricing column for counterbalance weight upcharge.
- D** Select key option.

KA	- Key alike
KS	- Key standard
NLC	- No lock core

INFORMATION

Height

All freestanding pedestals include 1/4" allowance for glides in recessed position. Mobile pedestals include 2-5/16" allowance for casters.

Accessories

See accessory section for accessories that can be ordered separately.

Weights

Figures provided are approximate and reflect packaged product without additional accessories.



Pedestals - Mobile and Freestanding

700 Series® OF Flush Top No Front

Approx. Packaged Weight	Delivered Pricing	Counter-balance Weight add to list price
45.0#	\$ 717	\$ 142
80.0#	828	N/A
65.0#	816	82
85.0#	860	N/A
45.0#	\$ 681	\$ 142
80.0#	751	N/A
65.0#	724	82
85.0#	791	N/A

SPECIAL SERVICES

Special Carton Marking

With specially marked information N/C

Shipping

Shipped **assembled freight prepaid f.o.b. Pembroke, Ontario K8A 0E1** factory. Freight class #70.

Specifications and prices are subject to change without prior notice.

Pedestals - Mobile and Freestanding

700 Series® OF Extended Top No Front

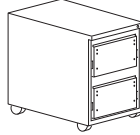
	MODEL	Features	W x D x H	MODEL NUMBER			
				Basic Model	Unit Color	Optional Counterbalance Weight	Key Option
 S7POU	Pedestal - BBFX • No drawer fronts • Two drawer bodies to accept 6" fronts • One drawer body to accept 12" front • Counterbalance weight included in mobile units • Counterbalance is recommended in freestanding pedestals	Freestanding	15 x 21-5/8 x 25-5/16"	S7PE/1524FBBFX	<input type="checkbox"/>	<input type="checkbox"/> <input type="checkbox"/> <input type="checkbox"/> <input type="checkbox"/>	<input type="checkbox"/> <input type="checkbox"/>
		Mobile	15 x 21-5/8 x 27-5/8"	S7PE/1524MBBFX	<input type="checkbox"/>		<input type="checkbox"/> <input type="checkbox"/>
		Freestanding	15 x 27-5/8 x 25-5/16"	S7PE/1530FBBFX	<input type="checkbox"/>	<input type="checkbox"/> <input type="checkbox"/> <input type="checkbox"/> <input type="checkbox"/>	<input type="checkbox"/> <input type="checkbox"/>
		Mobile	15 x 27-5/8 x 27-5/8"	S7PE/1530MBBFX	<input type="checkbox"/>		<input type="checkbox"/> <input type="checkbox"/>
 S7POU	Pedestal - FFX • No drawer fronts • Two drawer bodies to accept 12" fronts • Counterbalance weight included in mobile units • Counterbalance is recommended in freestanding pedestals	Freestanding	15 x 21-5/8 x 25-5/16"	S7PE/1524FFFX	<input type="checkbox"/>	<input type="checkbox"/> <input type="checkbox"/> <input type="checkbox"/> <input type="checkbox"/>	<input type="checkbox"/> <input type="checkbox"/>
		Mobile	15 x 21-5/8 x 27-5/8"	S7PE/1524MFFX	<input type="checkbox"/>		<input type="checkbox"/> <input type="checkbox"/>
		Freestanding	15 x 27-5/8 x 25-5/16"	S7PE/1530FFFX	<input type="checkbox"/>	<input type="checkbox"/> <input type="checkbox"/> <input type="checkbox"/> <input type="checkbox"/>	<input type="checkbox"/> <input type="checkbox"/>
		Mobile	15 x 27-5/8 x 27-5/8"	S7PE/1530MFFX	<input type="checkbox"/>		<input type="checkbox"/> <input type="checkbox"/>
				A	B	C	D

HOW TO ORDER

Indicate the following information on order form:

- Quantity of each item.
- Model number, including options. See "How To Build a Model Number".
- Any special service required.

Note: • The indicates that a choice is required.

- The absence of the indicates that no choice is required.
- Alpha-numeric characters in place of indicate that no other alternatives are available.

HOW TO BUILD A MODEL NUMBER

- A** Select basic model.
- B** Select unit color.
Refer to color addendum at ki.com or KI Fabrics & Finishes binder.
- C** Select counterbalance weight.
CBW - With Counterbalance
NOCBW - No Counterbalance
 See pricing column for counterbalance weight upcharge.
- D** Select key option.
KA - Key alike
KS - Key standard
NLC - No lock core

INFORMATION

Height

All freestanding pedestals include 1/4" allowance for glides in recessed position. Mobile pedestals include 2-5/16" allowance for casters.

Accessories

See accessory section for accessories that can be ordered separately.

Weights

Figures provided are approximate and reflect packaged product without additional accessories.



Pedestals - Mobile and Freestanding

700 Series® OF Extended Top No Front

Approx. Packaged Weight	Delivered Pricing	Counter- balance Weight add to list price
45.0#	\$ 717	\$ 142
80.0#	828	N/A
65.0#	816	82
85.0#	860	N/A
45.0#	\$ 681	\$ 142
80.0#	751	N/A
65.0#	724	82
85.0#	791	N/A

SPECIAL SERVICES

Special Carton Marking

With specially marked information N/C

Shipping

Shipped **assembled freight prepaid f.o.b.**
Pembroke, Ontario K8A 0E1 factory.
Freight class #70.

Specifications and prices are subject to
change without prior notice.

Pedestals - Mobile and Freestanding

700 Series® OF Flush Top Wood Front

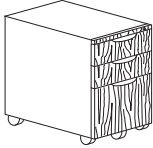
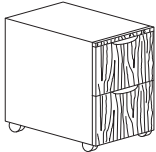
			MODEL NUMBER						Approx. Packaged Weight
Features	W x D x H	Basic Model	Unit Color	Veneer Color	Pull Color Optional Front	Optional Counterbalance Weight	Key Option		
 <p>S7POU Pedestal - BBFW1</p> <ul style="list-style-type: none"> • Two 6" box drawers • One 12" file drawer with hanging file partition • Wood veneer fronts with center drawer pulls • Counterbalance weight included in mobile units • Counterbalance is recommended in freestanding pedestals 	Freestanding	15 x 21-5/8 x 25-5/16"	S7PF/1524FBBFW1	<input type="checkbox"/>	<input type="checkbox"/>	<input type="checkbox"/>	<input type="checkbox"/>	<input type="checkbox"/>	65.0#
	Mobile	15 x 21-5/8 x 27-5/8"	S7PF/1524MBBFW1	<input type="checkbox"/>	<input type="checkbox"/>	<input type="checkbox"/>		<input type="checkbox"/>	100.0#
	Freestanding	15 x 27-5/8 x 25-5/16"	S7PF/1530FBBFW1	<input type="checkbox"/>	<input type="checkbox"/>	<input type="checkbox"/>	<input type="checkbox"/>	<input type="checkbox"/>	85.0#
	Mobile	15 x 27-5/8 x 27-5/8"	S7PF/1530MBBFW1	<input type="checkbox"/>	<input type="checkbox"/>	<input type="checkbox"/>		<input type="checkbox"/>	105.0#
 <p>S7POU Pedestal - FFW1</p> <ul style="list-style-type: none"> • Two 12" file drawers each with hanging folder partition • Wood veneer fronts with center drawer pulls • Counterbalance weight included in mobile units • Counterbalance is recommended in freestanding pedestals 	Freestanding	15 x 21-5/8 x 25-5/16"	S7PF/1524FFFW1	<input type="checkbox"/>	<input type="checkbox"/>	<input type="checkbox"/>	<input type="checkbox"/>	<input type="checkbox"/>	75.0#
	Mobile	15 x 21-5/8 x 27-5/8"	S7PF/1524MFFFW1	<input type="checkbox"/>	<input type="checkbox"/>	<input type="checkbox"/>		<input type="checkbox"/>	110.0#
	Freestanding	15 x 27-5/8 x 25-5/16"	S7PF/1530FFFW1	<input type="checkbox"/>	<input type="checkbox"/>	<input type="checkbox"/>	<input type="checkbox"/>	<input type="checkbox"/>	95.0#
	Mobile	15 x 27-5/8 x 27-5/8"	S7PF/1530MFFFW1	<input type="checkbox"/>	<input type="checkbox"/>	<input type="checkbox"/>		<input type="checkbox"/>	115.0#
			A	B	C	D	E	F	

HOW TO ORDER

Indicate the following information on order form:

1. Quantity of each item.
2. Model number, including options. See "How To Build a Model Number".
3. Any special service required.

Note: • The indicates that a choice is required.

- The absence of the indicates that no choice is required.
- Alpha-numeric characters in place of indicate that no other alternatives are available.

HOW TO BUILD A MODEL NUMBER

NLC - No lock core

- A** Select basic model.
- B** Select unit color.
Refer to color addendum at ki.com or KI Fabrics & Finishes binder.
- C** Select veneer color.
Refer to color addendum at ki.com or KI Fabrics & Finishes binder.
- D** Select pull color optional front.
Refer to color addendum at ki.com or KI Fabrics & Finishes binder.
- E** Select counterbalance weight.

CBW	- With Counterbalance
NOCBW	- No Counterbalance

 See pricing column for counterbalance weight upcharge.
- F** Select key option.

KA	- Key alike
KS	- Key standard

INFORMATION

Height

All freestanding pedestals include 1/4" allowance for glides in recessed position. Mobile pedestals include 2-5/16" allowance for casters.

Accessories

See accessory section for accessories that can be ordered separately.

Weights

Figures provided are approximate and reflect packaged product without additional accessories.



Pedestals - Mobile and Freestanding

700 Series® OF Flush Top Wood Front

Delivered Pricing	Counter-balance Weight add to list price
\$ 1447	\$ 142
1573	N/A
1519	82
1586	N/A
\$ 1244	\$ 142
1375	N/A
1309	82
1395	N/A

SPECIAL SERVICES

Special Carton Marking

With specially marked information N/C

Shipping

Shipped **assembled freight prepaid f.o.b. Pembroke, Ontario K8A 0E1** factory.
Freight class #70.

Specifications and prices are subject to change without prior notice.

Pedestals - Mobile and Freestanding

700 Series® OF Extended Top Laminate Front

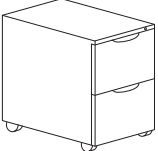
			MODEL NUMBER						Approx. Packaged Weight
Features	W x D x H	Basic Model	Unit Color	Front Surface Finish	Pull Color Optional Front	Optional Counterbalance Weight	Key Option		
 <p>S7POU Pedestal - BBFL1</p> <ul style="list-style-type: none"> • Two 6" box drawers • One 12" file drawer with folder partition • Laminate fronts with center pulls • Counterbalance weight included in mobile units • Counterbalance is recommended in freestanding pedestals 	Freestanding	15 x 21-5/8 x 25-5/16"	S7PE/1524FBBFL1	<input type="checkbox"/>	<input type="checkbox"/>	<input type="checkbox"/>	<input type="checkbox"/>	<input type="checkbox"/>	65.0#
	Mobile	15 x 21-5/8 x 27-5/8"	S7PE/1524MBBFL1	<input type="checkbox"/>	<input type="checkbox"/>	<input type="checkbox"/>	<input type="checkbox"/>	<input type="checkbox"/>	100.0#
	Freestanding	15 x 27-5/8 x 25-5/16"	S7PE/1530FBBFL1	<input type="checkbox"/>	<input type="checkbox"/>	<input type="checkbox"/>	<input type="checkbox"/>	<input type="checkbox"/>	85.0#
	Mobile	15 x 27-5/8 x 27-5/8"	S7PE/1530MBBFL1	<input type="checkbox"/>	<input type="checkbox"/>	<input type="checkbox"/>	<input type="checkbox"/>	<input type="checkbox"/>	105.0#
 <p>S7POU Pedestal - FFL1</p> <ul style="list-style-type: none"> • Two 12" file drawers with folder partitions • Laminate fronts with center pulls • Counterbalance weight included in mobile units • Counterbalance is recommended in freestanding pedestals 	Freestanding	15 x 21-5/8 x 25-5/16"	S7PE/1524FFFL1	<input type="checkbox"/>	<input type="checkbox"/>	<input type="checkbox"/>	<input type="checkbox"/>	<input type="checkbox"/>	75.0#
	Mobile	15 x 21-5/8 x 27-5/8"	S7PE/1524MFFFL1	<input type="checkbox"/>	<input type="checkbox"/>	<input type="checkbox"/>	<input type="checkbox"/>	<input type="checkbox"/>	105.0#
	Freestanding	15 x 27-5/8 x 25-5/16"	S7PE/1530FFFL1	<input type="checkbox"/>	<input type="checkbox"/>	<input type="checkbox"/>	<input type="checkbox"/>	<input type="checkbox"/>	95.0#
	Mobile	15 x 27-5/8 x 27-5/8"	S7PE/1530MFFFL1	<input type="checkbox"/>	<input type="checkbox"/>	<input type="checkbox"/>	<input type="checkbox"/>	<input type="checkbox"/>	115.0#
			A	B	C	D	E	F	

HOW TO ORDER

Indicate the following information on order form:

1. Quantity of each item.
2. Model number, including options. See "How To Build a Model Number".
3. Any special service required.

Note: • The indicates that a choice is required.

- The absence of the indicates that no choice is required.
- Alpha-numeric characters in place of indicate that no other alternatives are available.

HOW TO BUILD A MODEL NUMBER

NLC - No lock core

- A** Select basic model.
- B** Select unit color.
Refer to color addendum at ki.com or KI Fabrics & Finishes binder.
- C** Select front surface finish.
Refer to color addendum at ki.com or KI Fabrics & Finishes binder.
- D** Select pull color optional front.
Refer to color addendum at ki.com or KI Fabrics & Finishes binder.
- E** Select counterbalance weight.

CBW	- With Counterbalance
NOCBW	- No Counterbalance

 See pricing column for counterbalance weight upcharge.
- F** Select key option.

KA	- Key alike
KS	- Key standard

INFORMATION

Height

All freestanding pedestals include 1/4" allowance for glides in recessed position. Mobile pedestals include 2-5/16" allowance for casters.

Accessories

See accessory section for accessories that can be ordered separately.

Weights

Figures provided are approximate and reflect packaged product without additional accessories.



Pedestals - Mobile and Freestanding

700 Series® OF Extended Top Laminate Front

Delivered Pricing	Counter-balance Weight add to list price
\$ 991	\$ 142
1117	N/A
1063	82
1134	N/A
\$ 881	\$ 142
1010	N/A
939	82
1020	N/A

SPECIAL SERVICES

Special Carton Marking

With specially marked information N/C

Shipping

Shipped **assembled freight prepaid f.o.b. Pembroke, Ontario K8A 0E1** factory. Freight class #70.

Specifications and prices are subject to change without prior notice.

Pedestals - Hanging

700 Series®

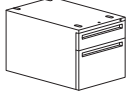
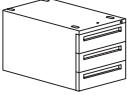
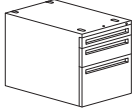
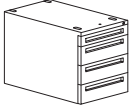
MODEL	Features	W x D x H	MODEL NUMBER				Approx. Packaged Weight
			Basic Model	Pull Option	Unit Color	Key Option	
 <p>Pedestal - BF • One 6" box drawer • One 12" file drawer with hanging folder partition</p>	Hanging	15 x 17-5/8 x 19-3/16"	S7P/1520HBF	<input type="checkbox"/> <input type="checkbox"/> <input type="checkbox"/> <input type="checkbox"/>	<input type="checkbox"/> <input type="checkbox"/>	<input type="checkbox"/> <input type="checkbox"/>	62.0#
	Hanging	15 x 21-5/8 x 19-3/16"	S7P/1524HBF	<input type="checkbox"/> <input type="checkbox"/> <input type="checkbox"/> <input type="checkbox"/>	<input type="checkbox"/> <input type="checkbox"/>	<input type="checkbox"/> <input type="checkbox"/>	80.0#
	Hanging	15 x 27-5/8 x 19-3/16"	S7P/1530HBF	<input type="checkbox"/> <input type="checkbox"/> <input type="checkbox"/> <input type="checkbox"/>	<input type="checkbox"/> <input type="checkbox"/>	<input type="checkbox"/> <input type="checkbox"/>	93.0#
S7PDU							
 <p>Pedestal - BBB • Three 6" box drawers</p>	Hanging	15 x 17-5/8 x 19-3/16"	S7P/1520HBBB	<input type="checkbox"/> <input type="checkbox"/> <input type="checkbox"/> <input type="checkbox"/>	<input type="checkbox"/> <input type="checkbox"/>	<input type="checkbox"/> <input type="checkbox"/>	45.0#
	Hanging	15 x 21-5/8 x 19-3/16"	S7P/1524HBBB	<input type="checkbox"/> <input type="checkbox"/> <input type="checkbox"/> <input type="checkbox"/>	<input type="checkbox"/> <input type="checkbox"/>	<input type="checkbox"/> <input type="checkbox"/>	50.0#
	Hanging	15 x 27-5/8 x 19-3/16"	S7P/1530HBBB	<input type="checkbox"/> <input type="checkbox"/> <input type="checkbox"/> <input type="checkbox"/>	<input type="checkbox"/> <input type="checkbox"/>	<input type="checkbox"/> <input type="checkbox"/>	61.0#
S7PDU							
 <p>Pedestal - PBF • One 3" pencil drawer • One 6" box drawer • One 12" file drawer with hanging folder partition</p>	Hanging	15 x 17-5/8 x 22-1/8"	S7P/1520HPBF	<input type="checkbox"/> <input type="checkbox"/> <input type="checkbox"/> <input type="checkbox"/>	<input type="checkbox"/> <input type="checkbox"/>	<input type="checkbox"/> <input type="checkbox"/>	62.0#
	Hanging	15 x 21-5/8 x 22-1/8"	S7P/1524HPBF	<input type="checkbox"/> <input type="checkbox"/> <input type="checkbox"/> <input type="checkbox"/>	<input type="checkbox"/> <input type="checkbox"/>	<input type="checkbox"/> <input type="checkbox"/>	80.0#
	Hanging	15 x 27-5/8 x 22-1/8"	S7P/1530HPBF	<input type="checkbox"/> <input type="checkbox"/> <input type="checkbox"/> <input type="checkbox"/>	<input type="checkbox"/> <input type="checkbox"/>	<input type="checkbox"/> <input type="checkbox"/>	95.0#
S7PDU							
 <p>Pedestal - PBBB • One 3" pencil drawer • Three 6" box drawers</p>	Hanging	15 x 17-5/8 x 22-1/8"	S7P/1520HPBBB	<input type="checkbox"/> <input type="checkbox"/> <input type="checkbox"/> <input type="checkbox"/>	<input type="checkbox"/> <input type="checkbox"/>	<input type="checkbox"/> <input type="checkbox"/>	53.0#
	Hanging	15 x 21-5/8 x 22-1/8"	S7P/1524HPBBB	<input type="checkbox"/> <input type="checkbox"/> <input type="checkbox"/> <input type="checkbox"/>	<input type="checkbox"/> <input type="checkbox"/>	<input type="checkbox"/> <input type="checkbox"/>	59.0#
	Hanging	15 x 27-5/8 x 22-1/8"	S7P/1530HPBBB	<input type="checkbox"/> <input type="checkbox"/> <input type="checkbox"/> <input type="checkbox"/>	<input type="checkbox"/> <input type="checkbox"/>	<input type="checkbox"/> <input type="checkbox"/>	71.0#
S7PDU							

A **B** **C** **D**

HOW TO ORDER

Indicate the following information on order form:

- Quantity of each item.
- Model number, including options. See "How To Build a Model Number".
- Any special service required.

Note: • The indicates that a choice is required.

- The absence of the indicates that no choice is required.
- Alpha-numeric characters in place of indicate that no other alternatives are available.

HOW TO BUILD A MODEL NUMBER

- A** Select basic model.

ALBT	- Aluminum bow tie
ALMT	- Aluminum metric
ARCN	- Arc nickel
CLSC	- Classic (inset pull)
NKBT	- Nickel bow tie
RETN	- Retro nickel
- C** Select unit and drawer color. Refer to color addendum at ki.com or KI Fabrics & Finishes binder.
- D** Select key option.

KA	- Key alike
KS	- Key standard
NLC	- No lock core

INFORMATION

Height
 All dimensions shown include 1/4" allowance for glides in recessed position.

Accessories
 See accessory section for accessories that can be ordered separately.

Weights
 Figures provided are approximate and reflect packaged product without additional accessories.



Pedestals - Hanging

700 Series®

Delivered Pricing

\$ 613
637
724

\$ 624
630
717

\$ 720
754
755

\$ 825
833
854

SPECIAL SERVICES

Special Carton Marking

With specially marked information N/C

Shipping

Shipped **assembled freight prepaid f.o.b. Pembroke, Ontario K8A 0E1** factory. Freight class #70.

Specifications and prices are subject to change without prior notice.

Pedestals - Hanging

700 Series® Curve

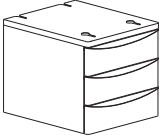
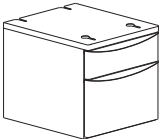
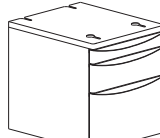
MODEL	Features	W x D x H	MODEL NUMBER				
			Basic Model	Dimpled	Unit Color	Pull Color	Key Option
 <p>Pedestal - BBB • Three 6" box drawers</p>	Hanging	15 x 17-5/8 x 19-3/16"	S7CP1520HBBB	<input type="checkbox"/>	□□□	□□□□□□□□	□□□
	Hanging	15 x 21-5/8 x 19-3/16"	S7CP1524HBBB	<input type="checkbox"/>	□□□	□□□□□□□□	□□□
	Hanging	15 x 27-5/8 x 19-3/16"	S7CP1530HBBB	<input type="checkbox"/>	□□□	□□□□□□□□	□□□
S7CP							
 <p>Pedestal - BF • One 6" box drawer • One 12" file drawer with hanging folder partition</p>	Hanging	15 x 17-5/8 x 19-3/16"	S7CP1520HBF	<input type="checkbox"/>	□□□	□□□□□□□□	□□□
	Hanging	15 x 21-5/8 x 19-3/16"	S7CP1524HBF	<input type="checkbox"/>	□□□	□□□□□□□□	□□□
	Hanging	15 x 27-5/8 x 19-3/16"	S7CP1530HBF	<input type="checkbox"/>	□□□	□□□□□□□□	□□□
S7CP							
 <p>Pedestal - PBF • One 3" pencil drawer • One 6" box drawer • One 12" file drawer with hanging folder partition</p>	Hanging	15 x 17-5/8 x 22-1/8"	S7CP1520HPBF	<input type="checkbox"/>	□□□	□□□□□□□□	□□□
	Hanging	15 x 21-5/8 x 22-1/8"	S7CP1524HPBF	<input type="checkbox"/>	□□□	□□□□□□□□	□□□
	Hanging	15 x 27-5/8 x 22-1/8"	S7CP1530HPBF	<input type="checkbox"/>	□□□	□□□□□□□□	□□□
S7CP							

A **B** **C** **D** **E**

HOW TO ORDER

Indicate the following information on order form:

- Quantity of each item.
- Model number, including options. See "How To Build a Model Number".
- Any special service required.

Note: • The indicates that a choice is required.
• The absence of the indicates that no choice is required.
• Alpha-numeric characters in place of indicate that no other alternatives are available.

HOW TO BUILD A MODEL NUMBER

- A** Select basic model.
- B** Select flat or dimpled front.

D	- Dimpled
F	- Flat

 See upcharge column for D option.
- C** Select unit and drawer color. Refer to color addendum at ki.com or KI Fabrics & Finishes binder.
- D** Select drawer pull color. Refer to color addendum at ki.com or KI Fabrics & Finishes binder.
- E** Select key option.

KA	- Key alike
KS	- Key standard
NLC	- No lock core

INFORMATION

Accessories
See accessory section for accessories that can be ordered separately.

Weights
Figures provided are approximate and reflect packaged product without additional accessories.



Pedestals - Hanging

700 Series® Curve

Approx. Packaged Weight	Delivered Pricing		Dimpled Front add to list price
45.0#	\$ 696		\$ 12
50.0#	706		12
61.0#	804		14
62.0#	\$ 691		\$ 12
80.0#	713		12
93.0#	814		14
62.0#	\$ 808		\$ 14
80.0#	845		15
93.0#	847		15

SPECIAL SERVICES

Special Carton Marking

With specially marked information N/C

Shipping

Shipped **assembled freight prepaid f.o.b. Pembroke, Ontario K8A 0E1** factory. Freight class #70.

Specifications and prices are subject to change without prior notice.

Pedestals - Hanging

700 Series® OF Flush Top No Front

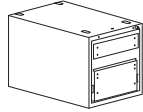

S7POU

MODEL

Pedestal - BFX

- No drawer fronts
- One drawer body to accept 6" front
- One drawer body to accept 12" front
- Hardware included

Features

W x D x H

MODEL NUMBER

Basic Model

Unit Color

Key Option

Approx. Packaged Weight

Hanging	15 x 16-3/4 x 19-3/16"	S7PF/1520HBFX	<input type="checkbox"/>	<input type="checkbox"/>	52.0#
Hanging	15 x 20-3/4 x 19-3/16"	S7PF/1524HBFX	<input type="checkbox"/>	<input type="checkbox"/>	70.0#
Hanging	15 x 26-3/4 x 19-3/16"	S7PF/1530HBFX	<input type="checkbox"/>	<input type="checkbox"/>	83.0#

A

B

C

HOW TO ORDER

Indicate the following information on order form:

1. Quantity of each item.
2. Model number, including options. See "How To Build a Model Number".
3. Any special service required.

Note: • The indicates that a choice is required.

- The absence of the indicates that no choice is required.
- Alpha-numeric characters in place of indicate that no other alternatives are available.

HOW TO BUILD A MODEL NUMBER

- A** Select basic model.
- B** Select unit color. Refer to color addendum at ki.com or KI Fabrics & Finishes binder.
- C** Select key option.

KA	- Key alike
KS	- Key standard
NLC	- No lock core

INFORMATION

Height

All dimensions shown include 1/4" allowance for glides in recessed position.

Accessories

See accessory section for accessories that can be ordered separately.

Weights

Figures provided are approximate and reflect packaged product without additional accessories.



Pedestals - Hanging

700 Series® OF Flush Top No Front

Delivered
Pricing

\$ 590
607
668

SPECIAL SERVICES

Special Carton Marking

With specially marked information N/C

Shipping

Shipped **assembled freight prepaid f.o.b. Pembroke, Ontario K8A 0E1** factory.
Freight class #70.

Specifications and prices are subject to change without prior notice.

Pedestals - Hanging

700 Series® OF Extended Top No Front

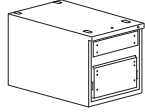

S7POU

MODEL

Pedestal - BFX

- No drawer fronts
- One drawer body to accept 6" front
- One drawer body to accept 12" front

Features

W x D x H

Hanging	15 x 17-5/8 x 19-3/16"
Hanging	15 x 21-5/8 x 19-3/16"
Hanging	15 x 27-5/8 x 19-3/16"

MODEL NUMBER

Basic Model

Unit Color

Key Option

Approx. Packaged Weight

S7PE/1520HBFX	<input type="checkbox"/> <input type="checkbox"/>	<input type="checkbox"/> <input type="checkbox"/> <input type="checkbox"/>
S7PE/1524HBFX	<input type="checkbox"/> <input type="checkbox"/>	<input type="checkbox"/> <input type="checkbox"/> <input type="checkbox"/>
S7PE/1530HBFX	<input type="checkbox"/> <input type="checkbox"/>	<input type="checkbox"/> <input type="checkbox"/> <input type="checkbox"/>

52.0#
70.0#
83.0#

A **B** **C**

HOW TO ORDER

Indicate the following information on order form:

1. Quantity of each item.
2. Model number, including options. See "How To Build a Model Number".
3. Any special service required.

Note: • The indicates that a choice is required.

- The absence of the indicates that no choice is required.
- Alpha-numeric characters in place of indicate that no other alternatives are available.

HOW TO BUILD A MODEL NUMBER

- A** Select basic model.
- B** Select unit color. Refer to color addendum at ki.com or KI Fabrics & Finishes binder.
- C** Select key option.

KA	- Key alike
KS	- Key standard
NLC	- No lock core

INFORMATION

Height
All dimensions shown include 1/4" allowance for glides in recessed position.

Accessories
See accessory section for accessories that can be ordered separately.

Weights
Figures provided are approximate and reflect packaged product without additional accessories.



Pedestals - Hanging

700 Series® OF Extended Top No Front

Delivered
Pricing

\$ 590
607
668

SPECIAL SERVICES

Special Carton Marking

With specially marked information N/C

Shipping

Shipped **assembled freight prepaid f.o.b.**
Pembroke, Ontario K8A 0E1 factory.
Freight class #70.

Specifications and prices are subject to
change without prior notice.

Pedestals - Hanging

700 Series® OF Flush Top Wood Front

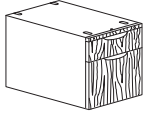

S7POU

MODEL	Features	W x D x H	MODEL NUMBER				
			Basic Model	Unit Color	Veneer Color	Pull Color Optional Front	Key Option
Pedestal - BFW1 • One 6" box drawer • One 12" file drawer with hanging file partition • Wood veneer fronts with center drawer pulls	Hanging	15 x 17-5/8 x 19-3/16"	S7PF/1520HBFW1	<input type="checkbox"/>	<input type="checkbox"/>	<input type="checkbox"/>	<input type="checkbox"/>
	Hanging	15 x 21-5/8 x 19-3/16"	S7PF/1524HBFW1	<input type="checkbox"/>	<input type="checkbox"/>	<input type="checkbox"/>	<input type="checkbox"/>
	Hanging	15 x 27-5/8 x 19-3/16"	S7PF/1530HBFW1	<input type="checkbox"/>	<input type="checkbox"/>	<input type="checkbox"/>	<input type="checkbox"/>

A **B** **C** **D** **E**

HOW TO ORDER

Indicate the following information on order form:

- Quantity of each item.
- Model number, including options. See "How To Build a Model Number".
- Any special service required.

Note: • The indicates that a choice is required.

- The absence of the indicates that no choice is required.
- Alpha-numeric characters in place of indicate that no other alternatives are available.

HOW TO BUILD A MODEL NUMBER

- A** Select basic model.
- B** Select unit color.
Refer to color addendum at ki.com or KI Fabrics & Finishes binder.
- C** Select veneer color.
Refer to color addendum at ki.com or KI Fabrics & Finishes binder.
- D** Select pull color optional front.
Refer to color addendum at ki.com or KI Fabrics & Finishes binder.
- E** Select key option.

KA	- Key alike
KS	- Key standard
NLC	- No lock core

INFORMATION

Height
All dimensions shown include 1/4" allowance for glides in recessed position.

Accessories
See accessory section for accessories that can be ordered separately.

Weights
Figures provided are approximate and reflect packaged product without additional accessories.



Pedestals - Hanging

700 Series® OF Flush Top Wood Front

Approx. Packaged Weight	Delivered Pricing
72.0#	\$ 1104
90.0#	1123
103.0#	1182

SPECIAL SERVICES

Special Carton Marking

With specially marked information N/C

Shipping

Shipped **assembled freight prepaid f.o.b.**
Pembroke, Ontario K8A 0E1 factory.
 Freight class #70.

Specifications and prices are subject to
 change without prior notice.

Pedestals - Hanging

700 Series® OF Extended Top Laminate Front

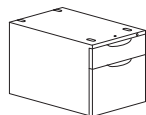

S7POU

MODEL	Features	W x D x H	MODEL NUMBER				
			Basic Model	Unit Color	Front Surface Finish	Pull Color Optional Front	Key Option
Pedestal - BFL1 • One 6" box drawer • One 12" file drawer with folder partition • Laminate fronts with center pulls	Hanging	15 x 17-5/8 x 19-3/16"	S7PE/1520HBFL1	<input type="checkbox"/>	<input type="checkbox"/>	<input type="checkbox"/>	<input type="checkbox"/>
	Hanging	15 x 21-5/8 x 19-3/16"	S7PE/1524HBFL1	<input type="checkbox"/>	<input type="checkbox"/>	<input type="checkbox"/>	<input type="checkbox"/>
	Hanging	15 x 27-5/8 x 19-3/16"	S7PE/1530HBFL1	<input type="checkbox"/>	<input type="checkbox"/>	<input type="checkbox"/>	<input type="checkbox"/>

A **B** **C** **D** **E**

HOW TO ORDER

Indicate the following information on order form:

1. Quantity of each item.
2. Model number, including options. See "How To Build a Model Number".
3. Any special service required.

Note: • The indicates that a choice is required.

- The absence of the indicates that no choice is required.
- Alpha-numeric characters in place of indicate that no other alternatives are available.

HOW TO BUILD A MODEL NUMBER

- A** Select basic model.
- B** Select unit color.
Refer to color addendum at ki.com or KI Fabrics & Finishes binder.
- C** Select front surface finish.
Refer to color addendum at ki.com or KI Fabrics & Finishes binder.
- D** Select pull color optional front.
Refer to color addendum at ki.com or KI Fabrics & Finishes binder.
- E** Select key option.
- | | |
|------------|----------------|
| KA | - Key alike |
| KS | - Key standard |
| NLC | - No lock core |

INFORMATION

Height

All dimensions shown include 1/4" allowance for glides in recessed position.

Accessories

See accessory section for accessories that can be ordered separately.

Weights

Figures provided are approximate and reflect packaged product without additional accessories.



Pedestals - Hanging

700 Series® OF Extended Top Laminate Front

Approx. Packaged Weight	Delivered Pricing
72.0#	\$ 756
90.0#	774
103.0#	834

SPECIAL SERVICES

Special Carton Marking

With specially marked information N/C



Shipping

Shipped **assembled freight prepaid f.o.b.**
Pembroke, Ontario K8A 0E1 factory.
 Freight class #70.

Specifications and prices are subject to
 change without prior notice.

Pedestals - Worksurface Supporting

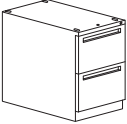
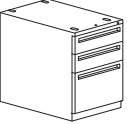
700 Series®

	MODEL	Features	W x D x H	MODEL NUMBER				Approx. Packaged Weight
				Basic Model	Pull Option	Unit Color	Key Option	
 <p>S7PDU</p>	Pedestal - FF • Two 12" file drawers with hanging folder partitions • Includes four leveling glides	Supporting	15 x 17-5/8 x 27-7/8"	S7P/1520WFF	<input type="checkbox"/> <input type="checkbox"/> <input type="checkbox"/> <input type="checkbox"/>	<input type="checkbox"/> <input type="checkbox"/>	<input type="checkbox"/> <input type="checkbox"/>	59.0#
		Supporting	15 x 21-5/8 x 27-7/8"	S7P/1524WFF	<input type="checkbox"/> <input type="checkbox"/> <input type="checkbox"/> <input type="checkbox"/>	<input type="checkbox"/> <input type="checkbox"/>	<input type="checkbox"/> <input type="checkbox"/>	82.0#
		Supporting	15 x 27-5/8 x 27-7/8"	S7P/1530WFF	<input type="checkbox"/> <input type="checkbox"/> <input type="checkbox"/> <input type="checkbox"/>	<input type="checkbox"/> <input type="checkbox"/>	<input type="checkbox"/> <input type="checkbox"/>	95.0#
 <p>S7PDU</p>	Pedestal - BBF • Two 6" box drawers • One 12" file drawer with hanging folder partition • Includes four leveling glides	Supporting	15 x 17-5/8 x 27-7/8"	S7P/1520WBBF	<input type="checkbox"/> <input type="checkbox"/> <input type="checkbox"/> <input type="checkbox"/>	<input type="checkbox"/> <input type="checkbox"/>	<input type="checkbox"/> <input type="checkbox"/>	61.0#
		Supporting	15 x 21-5/8 x 27-7/8"	S7P/1524WBBF	<input type="checkbox"/> <input type="checkbox"/> <input type="checkbox"/> <input type="checkbox"/>	<input type="checkbox"/> <input type="checkbox"/>	<input type="checkbox"/> <input type="checkbox"/>	80.0#
		Supporting	15 x 27-5/8 x 27-7/8"	S7P/1530WBBF	<input type="checkbox"/> <input type="checkbox"/> <input type="checkbox"/> <input type="checkbox"/>	<input type="checkbox"/> <input type="checkbox"/>	<input type="checkbox"/> <input type="checkbox"/>	93.0#
 <p>S7PDU</p>	Pedestal - BBBB • Four 6" box drawers • Includes four leveling glides	Supporting	15 x 17-5/8 x 27-7/8"	S7P/1520WBBBB	<input type="checkbox"/> <input type="checkbox"/> <input type="checkbox"/> <input type="checkbox"/>	<input type="checkbox"/> <input type="checkbox"/>	<input type="checkbox"/> <input type="checkbox"/>	70.0#
		Supporting	15 x 21-5/8 x 27-7/8"	S7P/1524WBBBB	<input type="checkbox"/> <input type="checkbox"/> <input type="checkbox"/> <input type="checkbox"/>	<input type="checkbox"/> <input type="checkbox"/>	<input type="checkbox"/> <input type="checkbox"/>	70.0#
		Supporting	15 x 27-5/8 x 27-7/8"	S7P/1530WBBBB	<input type="checkbox"/> <input type="checkbox"/> <input type="checkbox"/> <input type="checkbox"/>	<input type="checkbox"/> <input type="checkbox"/>	<input type="checkbox"/> <input type="checkbox"/>	81.0#
				A	B	C	D	

HOW TO ORDER

Indicate the following information on order form:

- Quantity of each item.
- Model number, including options. See "How To Build a Model Number".
- Any special service required.

Note: • The indicates that a choice is required.

- The absence of the indicates that no choice is required.
- Alpha-numeric characters in place of indicate that no other alternatives are available.

HOW TO BUILD A MODEL NUMBER

- A** Select basic model.
- B** Select pull option.

ALBT	- Aluminum Bow Tie
ALMT	- Aluminum Metric
ARCN	- Arc Nickel
CLSC	- Classic (inset pull)
NKBT	- Nickel Bow Tie
RETN	- Retro Nickel
- C** Select unit and drawer color. Refer to color addendum at ki.com or KI Fabrics & Finishes binder.
- D** Select key option.

KA	- Key alike
KS	- Key standard
NLC	- No lock core

INFORMATION

Height

All dimensions shown include 1/4" allowance for glides in recessed position.

Accessories

See accessory section for accessories that can be ordered separately.

Weights

Figures provided are approximate and reflect packaged product without additional accessories.



Pedestals - Worksurface Supporting

700 Series®

Delivered
Pricing

\$ 630
737
766

\$ 698
806
850

\$ 798
815
894

SPECIAL SERVICES

Special Carton Marking

With specially marked information N/C

Shipping

Shipped **assembled freight prepaid f.o.b. Pembroke, Ontario K8A 0E1** factory. Freight class #70.

Specifications and prices are subject to change without prior notice.

Pedestals - Worksurface Supporting

700 Series® Curve

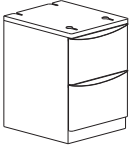
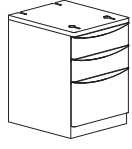
				MODEL NUMBER				
MODEL	Features	W x D x H	Basic Model	Dimpled	Unit Color	Pull Color	Key Option	
 <p>Pedestal - FF</p> <ul style="list-style-type: none"> Two 12" file drawers with hanging folder partitions Includes four leveling glides 	Supporting	15 x 17-5/8 x 27-7/8"	S7CP1520WFF	<input type="checkbox"/>	<input type="checkbox"/> <input type="checkbox"/> <input type="checkbox"/>	<input type="checkbox"/> <input type="checkbox"/> <input type="checkbox"/> <input type="checkbox"/> <input type="checkbox"/> <input type="checkbox"/> <input type="checkbox"/> <input type="checkbox"/>	<input type="checkbox"/> <input type="checkbox"/> <input type="checkbox"/>	
	Supporting	15 x 21-5/8 x 27-7/8"	S7CP1524WFF	<input type="checkbox"/>	<input type="checkbox"/> <input type="checkbox"/> <input type="checkbox"/>	<input type="checkbox"/> <input type="checkbox"/> <input type="checkbox"/> <input type="checkbox"/> <input type="checkbox"/> <input type="checkbox"/> <input type="checkbox"/> <input type="checkbox"/>	<input type="checkbox"/> <input type="checkbox"/> <input type="checkbox"/>	
	Supporting	15 x 27-5/8 x 27-7/8"	S7CP1530WFF	<input type="checkbox"/>	<input type="checkbox"/> <input type="checkbox"/> <input type="checkbox"/>	<input type="checkbox"/> <input type="checkbox"/> <input type="checkbox"/> <input type="checkbox"/> <input type="checkbox"/> <input type="checkbox"/> <input type="checkbox"/> <input type="checkbox"/>	<input type="checkbox"/> <input type="checkbox"/> <input type="checkbox"/>	
 <p>Pedestal - BBF</p> <ul style="list-style-type: none"> Two 6" box drawers One 12" file drawer with hanging folder partition Includes four leveling glides 	Supporting	15 x 17-5/8 x 27-7/8"	S7CP1520WBBF	<input type="checkbox"/>	<input type="checkbox"/> <input type="checkbox"/> <input type="checkbox"/>	<input type="checkbox"/> <input type="checkbox"/> <input type="checkbox"/> <input type="checkbox"/> <input type="checkbox"/> <input type="checkbox"/> <input type="checkbox"/> <input type="checkbox"/>	<input type="checkbox"/> <input type="checkbox"/> <input type="checkbox"/>	
	Supporting	15 x 21-5/8 x 27-7/8"	S7CP1524WBBF	<input type="checkbox"/>	<input type="checkbox"/> <input type="checkbox"/> <input type="checkbox"/>	<input type="checkbox"/> <input type="checkbox"/> <input type="checkbox"/> <input type="checkbox"/> <input type="checkbox"/> <input type="checkbox"/> <input type="checkbox"/> <input type="checkbox"/>	<input type="checkbox"/> <input type="checkbox"/> <input type="checkbox"/>	
	Supporting	15 x 27-5/8 x 27-7/8"	S7CP1530WBBF	<input type="checkbox"/>	<input type="checkbox"/> <input type="checkbox"/> <input type="checkbox"/>	<input type="checkbox"/> <input type="checkbox"/> <input type="checkbox"/> <input type="checkbox"/> <input type="checkbox"/> <input type="checkbox"/> <input type="checkbox"/> <input type="checkbox"/>	<input type="checkbox"/> <input type="checkbox"/> <input type="checkbox"/>	
				A	B	C	D	E

S7CP

S7CP

HOW TO ORDER

Indicate the following information on order form:

- Quantity of each item.
- Model number, including options. See "How To Build a Model Number".
- Any special service required.

Note:

- The indicates that a choice is required.
- The absence of the indicates that no choice is required.
- Alpha-numeric characters in place of indicate that no other alternatives are available.

HOW TO BUILD A MODEL NUMBER

- A** Select basic model.
- B** Select flat or dimpled front.

D	- Dimpled
F	- Flat

 See upcharge column for D option.
- C** Select unit and drawer color. Refer to color addendum at ki.com or KI Fabrics & Finishes binder.
- D** Select drawer pull color. Refer to color addendum at ki.com or KI Fabrics & Finishes binder.
- E** Select key option.

KA	- Key alike
KS	- Key standard
NLC	- No lock core

INFORMATION

Height
All dimensions shown include 1/4" allowance for glides in recessed position.

Accessories
See accessory section for accessories that can be ordered separately.

Weights
Figures provided are approximate and reflect packaged product without additional accessories.



Pedestals - Worksurface Supporting

700 Series® Curve

Approx. Packaged Weight	Delivered Pricing		Dimpled Front add to list price
59.0#	\$ 706		\$ 12
82.0#	825		14
95.0#	857		15
61.0#	\$ 782		\$ 14
80.0#	903		15
93.0#	951		16

SPECIAL SERVICES

Special Carton Marking



With specially marked information N/C

Shipping

Shipped **assembled freight prepaid f.o.b.**
Pembroke, Ontario K8A 0E1 factory.
 Freight class #70.

Specifications and prices are subject to
 change without prior notice.

Pedestal Accessories

				MODEL NUMBER	
MODEL	Features	W x D x H	Basic Model	Approx. Packaged Weight	
 PDACU	Counterbalance Weight • For mobile and freestanding units • Included in mobile pedestals; recommended in freestanding units • Factory installed, if specified	For 30"D Units	12-1/2 x 1/2 x 12-3/4"	S7P/CBW20	20.0#
		For 24"D Units	12-1/2 x 1-1/4 x 16-3/4"	S7P/CBW40	40.0#
 PDACU	Counterbalance Weight • Two required for 20" deep units • Sold in pairs	For 20"D Units	7-1/2 x 3/4 x 16"	S7P/CBW36	36.0#
HRDPT	P-Series Keys • Extractor key used for core removal	Lock/Core Set		2.KP20522	0.4#
		Master Key		2.KP20550	0.2#
		Extractor Key		2.KP20551	0.2#
		Key Blank		2.KP20552	0.2#
		Cut Key		2.KP20557	0.2#
 PDACU	Caster Kit • Converts freestanding pedestals to mobile units • Adds 2-5/16" to pedestal height • Must use with counterbalance weight (see above)		2-9/16"	S7P/CK	13.0#

A

HOW TO ORDER

Indicate the following information on order form:

- Quantity of each item.
- Model number, including options. See "How To Build a Model Number".
- Any special service required.

Note: • The indicates that a choice is required.

- The absence of the indicates that no choice is required.
- Alpha-numeric characters in place of indicate that no other alternatives are available.

HOW TO BUILD A MODEL NUMBER

- A** Select basic model.



Delivered
Pricing

\$ 82

142

\$ 166

\$ 12

9

9

3

4

\$ 68

SPECIAL SERVICES

Special Carton Marking



With specially marked information N/C

Shipping

Shipped **assembled freight prepaid f.o.b. Pembroke, Ontario K8A 0E1** factory.
Freight class #70.

Specifications and prices are subject to change without prior notice.

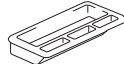
Pedestal Accessories

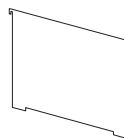
	MODEL	W x D x H	MODEL NUMBER		Approx. Packaged Weight
			Basic Model		
 <p>PDACU</p>	Glide Kit <ul style="list-style-type: none"> • Adds 1/4 to 1 inch to pedestal height • 4 per kit 		S7P/GK		1.0#
 <p>PDACU</p>	Pencil Tray <ul style="list-style-type: none"> • For 3" pencil and 6" box drawers • Black finish only • Priced individually 	12-1/8 x 4 x 1"	S7P/PENTRAY		1.0#
 <p>PDACU</p>	6" Partition <ul style="list-style-type: none"> • For 6" box drawers • Black finish only • Priced individually 	12-1/8 x 4-5/8"	S7P/D6		1.0#
 <p>PDACU</p>	Hanging Folder Partition <ul style="list-style-type: none"> • For 12" file drawers • Black finish only • Priced individually 	12-1/8 x 9-5/8"	S7P/D12		1.0#

A

HOW TO ORDER

Indicate the following information on order form:

1. Quantity of each item.
2. Model number, including options. See "How To Build a Model Number".
3. Any special service required.

Note:

- The indicates that a choice is required.
- The absence of the indicates that no choice is required.
- Alpha-numeric characters in place of indicate that no other alternatives are available.

HOW TO BUILD A MODEL NUMBER

A Select basic model.



Delivered Pricing

\$ 9

\$ 8

\$ 5

\$ 8

SPECIAL SERVICES

Special Carton Marking

With specially marked information N/C

Shipping

Shipped **assembled freight prepaid f.o.b. Pembroke, Ontario K8A 0E1** factory. Freight class #70.

Specifications and prices are subject to change without prior notice.

Pedestal Accessories

	MODEL	W x D x H	MODEL NUMBER			Approx. Packaged Weight	Delivered Pricing C.O.M.
			Basic Model	Trim Color	Upholstery Color		
 <p>PDCU</p>	Cushioned Seat for Mobile Pedestal • 17" deep, used with 17-5/8" deep mobile pedestal • 20" deep, used with 21-5/8" deep mobile pedestal • Fabric runs side-to-side • Lip height is 3-1/4"	15 x 17 x 1-7/8"	PDCU/17	<input type="checkbox"/> <input type="checkbox"/>	<input type="checkbox"/> <input type="checkbox"/> <input type="checkbox"/> <input type="checkbox"/>	5.0#	\$ 151
		15 x 20 x 1-7/8"	PDCU/20	<input type="checkbox"/> <input type="checkbox"/>	<input type="checkbox"/> <input type="checkbox"/> <input type="checkbox"/> <input type="checkbox"/>	6.0#	163

A
B
C

HOW TO ORDER

Indicate the following information on order form:

- Quantity of each item.
- Model number, including options. See "How To Build a Model Number".
- Any special service required.

- Note:
- The indicates that a choice is required.
 - The absence of the indicates that no choice is required.
 - Alpha-numeric characters in place of indicate that no other alternatives are available.

HOW TO BUILD A MODEL NUMBER

- A** Select basic model.
- B** Select trim color.
Refer to color addendum at ki.com or KI Fabrics & Finishes binder.
- C** Select upholstery color.
Refer to color addendum at ki.com or KI Fabrics & Finishes binder.
For a listing of available fabric finishes, please refer to the Color Addendum. For specific fabric availability on cushioned seats, please refer to E Spec.



Pedestal Accessories

Delivered Pricing Fabric Grade 1	Delivered Pricing Fabric Grade 2	Delivered Pricing Fabric Grade 3	Delivered Pricing Pallas Fabric Group P0	Delivered Pricing Pallas Fabric Group P1	Delivered Pricing Pallas Fabric Group P2	Delivered Pricing Pallas Fabric Group P3	Delivered Pricing Pallas Fabric Group P4
\$ 151	\$ 172	\$ 181	\$ 190	\$ 201	\$ 212	\$ 236	\$ 242
163	180	193	200	210	221	247	253

SPECIAL SERVICES

Special Carton Marking

With specially marked information N/C

Shipping

Shipped **assembled freight prepaid f.o.b.**
Green Bay, Wisconsin 54302 factory.
Freight class #100.

Specifications and prices are subject to
change without prior notice.



Pedestal Laminate Tops

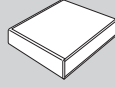
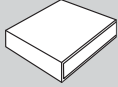

Approx. Packaged Weight	Self Edge (SE)	74P Edge (74P)
8.0#	\$ 137	\$ 139
11.0#	153	161
14.0#	178	185

SPECIAL SERVICES

Special Carton Marking

With specially marked information N/C

Shipping

Shipped **assembled freight prepaid f.o.b. Pembroke, Ontario K8A 0E1** factory.
Freight class #70.

Specifications and prices are subject to change without prior notice.

700 Series® Vertical Files

General Information

GENERAL INFORMATION

KI vertical files are designed on a 11" module. To assure KI files are compatible with panel systems, desks or custom architectural details, cabinets are available in 4 different heights.

Height

Vertical files are available in 4 standard heights. Heights include $\frac{1}{8}$ " allowance for leveling glides fully recessed.

Depth

All products are 27 $\frac{5}{8}$ " deep.

Width

Cabinets are available in two standard widths: 15" and 18".

Drawer Dimensions

Refer to the illustrations for the range of drawer sizes and the height clearance of each.

CONSTRUCTION AND STANDARD FEATURES

Basic Shell

Uprights and top and bottom reinforcements are welded into rigid "boxframe." Constructed of 18- and 20-gauge steel. Seamless back and top with reinforced corners. 5-drawer cabinets also feature a welded tie bar midway in the shell.

Illustrated shell heights include $\frac{1}{8}$ " for adjustable glide in recessed position.

Doors/Drawers

Drawer fronts, 20-gauge steel double wall with full-width flush inset pull and label holder. Fronts are screw-mounted to shelves to build drawers. Shelf body, 20-gauge steel. Each roll-out shelf equipped with two heavy-duty, three-section, ball-bearing suspensions. Components have been tested to accept loads of 75 lbs.

Adjustable Glides

Cabinets are supplied with two adjustable glides. The glides can be adjusted from inside the cabinet using a $\frac{1}{4}$ " hex socket wrench, or from outside the cabinet using a $\frac{7}{16}$ " wrench. Standard glides provide $\frac{3}{4}$ " adjustment; longer glides are also available. Overall cabinet heights include the glide in its recessed position.

Locks

Locks are standard on all units. The lock is a high-security double-bit type. The double-bit lock offers superior security when compared to a single-bit lock. Units are standard with random keys in a range of 994 different numbers. Specific keying combinations are available at no additional charge. This information must be included with the order. Locks can be master keyed. Please see the accessories section of this price book for order information on master keys, extractor (core-removal) keys, key blanks, cut keys, and core and key sets.

All locks have removable and interchangeable plugs. This feature provides for onsite custom keying. Units can be supplied with the lock plugs installed or shipped separately. To install or remove lock plugs a unique key is required. This key is the extractor (core removal) key and can be found in the accessories section of this price book. Contact Customer Service to order lock accessories. To order plugs for field installation, specify "lock plugs not installed" on order. Order must specify total quantity of specific key-numbered locks.

Example: 30 plugs:
3 keyed alike
10 keyed alike
17 keyed alike

Commercial Pack

This is the standard pack that KI offers on all files and storage products. This consists of a plastic poly bag placed over the unit,

corrugated top and bottom cap, corner blocking and stretch wrap to keep the packaging intact.

Standard Paint Finishes

All KI products are iron phosphate treated prior to painting. This process enhances top coat bonding.

Powder coat application is a highbred epoxy. The paint is baked on to provide a scratch and stain resistant surface.

All inside and outside shell and front surfaces are painted with the same specified paint color. Interior components and accessories are painted a black finish. Mechanical components are black plated.

Powder coated/enamel finish colors shown in Color Addendums are standard and are available where specifications call for painted surfaces.

Special Paint Finishes

All special colors, including other manufacturers' standard enamel finishes, are available subject to the following conditions.

- Two steel color chips (minimum 2.5" x 3.5") are requested for color matching purposes. Paper samples are acceptable, however, a reasonable tolerance must be allowed when comparing the two variations.
- All nonstandard colors are available at no additional charge (excluding hi-chromatic colors), but may be subject to extended lead times. Order will not be processed until color match is approved. Written confirmation must accompany order.

Model Numbering System

Each character in the basic model number corresponds to a specific unit feature.

How to Build a Model Number

Example: 700 Series Vertical Files

						Optional Picks
S7V	15	30	3D	CF	BL	CBW50
S7V	Product name	700 Series Vertical File				
15	Width	15" wide, letter size				
30	Depth (nominal)	30" depth				
3D	Number of drawers	3 drawers				
CF	Equipped with	Compressor follower (as opposed to folder bars)				
BL	Color code	Black				
Each internal component has a corresponding character:						
D	11" file drawer					
CF	Compressor follower					
FB	Folder bar					
NOTE: Must SPECIFY either CF or FB for each unit.						





700 Series[®] Vertical Files

General Information

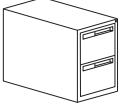
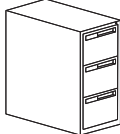

Vertical Files

700 Series® Letter Size Documents

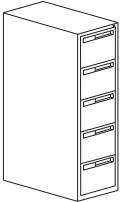
	MODEL	Accessories Included	W x D	MODEL NUMBER			Approx. Packaged Weight
				Basic Model	Unit Color	Key Option	
 S7VTU	25-3/4" File, 2 High • Two 11" drawers with either folder bars or compressor follower in each drawer	Compressor	15 x 27-5/8"	S7V/15302DCF	<input type="checkbox"/>	<input type="checkbox"/>	110.0#
		Folder bars	15 x 27-5/8"	S7V/15302DFB	<input type="checkbox"/>	<input type="checkbox"/>	110.0#
 S7VTU	36-7/8" File, 3 High • Three 11" drawers with either folder bars or compressor follower in each drawer	Compressor	15 x 27-5/8"	S7V/15303DCF	<input type="checkbox"/>	<input type="checkbox"/>	150.0#
		Folder bars	15 x 27-5/8"	S7V/15303DFB	<input type="checkbox"/>	<input type="checkbox"/>	150.0#
 S7VTU	48" File, 4 High • Four 11" drawers with either folder bars or compressor follower in each drawer	Compressor	15 x 27-5/8"	S7V/15304DCF	<input type="checkbox"/>	<input type="checkbox"/>	190.0#
		Folder bars	15 x 27-5/8"	S7V/15304DFB	<input type="checkbox"/>	<input type="checkbox"/>	190.0#
 S7VTU	59-1/8" File, 5 High • Five 11" drawers with either folder bars or compressor follower in each drawer	Compressor	15 x 27-5/8"	S7V/15305DCF	<input type="checkbox"/>	<input type="checkbox"/>	230.0#
		Folder bars	15 x 27-5/8"	S7V/15305DFB	<input type="checkbox"/>	<input type="checkbox"/>	230.0#

A **B** **C**

HOW TO ORDER

Indicate the following information on order form:

- Quantity of each item.
- Model number, including options. See "How To Build a Model Number".
- Any special service required.

Note: • The indicates that a choice is required.

- The absence of the indicates that no choice is required.
- Alpha-numeric characters in place of indicate that no other alternatives are available.

HOW TO BUILD A MODEL NUMBER

- A** Select basic model.
- B** Select unit and drawer color.
Refer to color addendum at ki.com or KI Fabrics & Finishes binder.
- C** Select key option.

KA	- Key alike
KS	- Key standard
NLC	- No lock core

INFORMATION

Height

All dimensions shown include 1/4" allowance for glides in recessed position.

Accessories

See accessory section for accessories that can be ordered separately.

Weights

Figures provided are approximate and reflect packaged product without additional accessories.



Delivered
Pricing

\$ 758

758

\$ 968

968

\$ 1249

1249

\$ 1499

1499

SPECIAL SERVICES

Special Carton Marking

With specially marked information N/C



Shipping

Shipped **assembled freight prepaid f.o.b. Pembroke, Ontario K8A 0E1** factory.
Freight class #70.

Specifications and prices are subject to change without prior notice.

Vertical Files

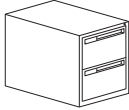
700 Series® Legal Size Documents

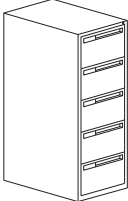
	MODEL	Accessories Included	W x D	MODEL NUMBER			Approx. Packaged Weight
				Basic Model	Unit Color	Key Option	
	25-3/4" File, 2 High • Two 11" drawers with either folder bars or compressor follower in each drawer	Compressor	18 x 27-5/8"	S7V/18302DCF	<input type="checkbox"/>	<input type="checkbox"/>	115.0#
		Folder bars	18 x 27-5/8"	S7V/18302DFB	<input type="checkbox"/>	<input type="checkbox"/>	115.0#
S7VTU							
	36-7/8" File, 3 High • Three 11" drawers with either folder bars or compressor follower in each drawer	Compressor	18 x 27-5/8"	S7V/18303DCF	<input type="checkbox"/>	<input type="checkbox"/>	160.0#
		Folder bars	18 x 27-5/8"	S7V/18303DFB	<input type="checkbox"/>	<input type="checkbox"/>	160.0#
S7VTU							
	48" File, 4 High • Four 11" drawers with either folder bars or compressor follower in each drawer	Compressor	18 x 27-5/8"	S7V/18304DCF	<input type="checkbox"/>	<input type="checkbox"/>	210.0#
		Folder bars	18 x 27-5/8"	S7V/18304DFB	<input type="checkbox"/>	<input type="checkbox"/>	210.0#
S7VTU							
	59-1/8" File, 5 High • Five 11" drawers with either folder bars or compressor follower in each drawer	Compressor	18 x 27-5/8"	S7V/18305DCF	<input type="checkbox"/>	<input type="checkbox"/>	245.0#
		Folder bars	18 x 27-5/8"	S7V/18305DFB	<input type="checkbox"/>	<input type="checkbox"/>	245.0#
S7VTU							

A

B

C

HOW TO ORDER

Indicate the following information on order form:

- Quantity of each item.
- Model number, including options. See "How To Build a Model Number".
- Any special service required.

Note: • The indicates that a choice is required.

- The absence of the indicates that no choice is required.
- Alpha-numeric characters in place of indicate that no other alternatives are available.

HOW TO BUILD A MODEL NUMBER

- A** Select basic model.
- B** Select unit and drawer color.
Refer to color addendum at ki.com or KI Fabrics & Finishes binder.
- C** Select key option.
- | | |
|-----|----------------|
| KA | - Key alike |
| KS | - Key standard |
| NLC | - No lock core |

INFORMATION

Height

All dimensions shown include 1/4" allowance for glides in recessed position.

Accessories

See accessory section for accessories that can be ordered separately.

Weights

Figures provided are approximate and reflect packaged product without additional accessories.



Vertical Files

700 Series® Legal Size Documents

Delivered
Pricing

\$ 758
758

\$ 968
968

\$ 1249
1249

\$ 1499
1499

SPECIAL SERVICES

Special Carton Marking

With specially marked information N/C

Shipping

Shipped **assembled freight prepaid f.o.b. Pembroke, Ontario K8A 0E1** factory. Freight class #70.

Specifications and prices are subject to change without prior notice.

Vertical File Accessories

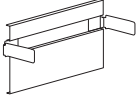
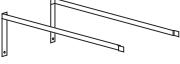
	MODEL	Features	W x D	MODEL NUMBER		Approx. Packaged Weight
				Basic Model		
 VTACU	Compressor <ul style="list-style-type: none"> Includes parts required for one 18" wide drawer Black finish only 	Fits any letter size drawer	15 x 1 x 7"	S7V/15CF		5.0#
		Fits any legal size drawer	18 x 1 x 7"	S7V/18CF		5.0#
 VTACU	Folder Bars <ul style="list-style-type: none"> Fits any legal or letter size drawer Priced per set Black finish only 		1 x 26 x 9"	S7V/1518FB		5.0#

A

HOW TO ORDER

Indicate the following information on order form:

- Quantity of each item.
- Model number, including options. See "How To Build a Model Number".
- Any special service required.

Note:

- The indicates that a choice is required.
- The absence of the indicates that no choice is required.
- Alpha-numeric characters in place of indicate that no other alternatives are available.

HOW TO BUILD A MODEL NUMBER

A Select basic model.



Vertical File Accessories

Delivered
Pricing

\$ 29
29

\$ 29

SPECIAL SERVICES

Special Carton Marking

With specially marked information N/C

Shipping

Shipped **assembled freight prepaid f.o.b. Pembroke, Ontario K8A 0E1** factory.
Freight class #70.

Specifications and prices are subject to change without prior notice.

Index

Model No.	Description	Page	Model No.	Description	Page
2.KP20522	P-Series Keys	116		30" Wide - 24" File, 6" Wide Locker, 24" Deep	70
7CFB30495/2D270B	700 Series® Curve Bookcase/Lateral File: 53-1/32" Bookcase/Lateral	58	PDCU/17	Cushioned Seat for Mobile Pedestal	240
7CFB30615/2D360B	700 Series® Curve Bookcase/Lateral File: 65-9/32" Bookcase/Lateral	60	S7B/3012BS	Blank Shelf	192
7CFB30615/2D390B	700 Series® Curve Bookcase/Lateral File: 65-9/32" Bookcase/Lateral	58	S7B/3012T	Laminate Top for 12" Deep Bookcases	194
7CFB30615/3D330B	700 Series® Curve Bookcase/Lateral File: 65-9/32" Bookcase/Lateral	60	S7B/3015T	Laminate Top for 15" Deep Bookcases	194
7CFL3061518/2D360B/6FLL	700 Series® Curve Cupboard/Bookcase/Markerboard: 30" Wide - 24" File, 6" Wide Locker, 18" Deep	72	S7B/3025512	700 Series® 12" Deep: 28-17/32" High	178
7CFL3061518/3D285B/6FLL	700 Series® Curve Cupboard/Bookcase/Markerboard: 30" Wide - 24" File, 6" Wide Locker, 18" Deep	76	S7B/3025515	700 Series® 15" Deep: 28-17/32" High	184
7CFL3061518/3D300B/6FLL	700 Series® Curve Cupboard/Bookcase/Markerboard: 30" Wide - 24" File, 6" Wide Locker, 18" Deep	74	S7B/3039012	700 Series® 12" Deep: 42-5/16" High	178
7CFL3061518/3D330B/6FLL	700 Series® Curve Cupboard/Bookcase/Markerboard: 30" Wide - 24" File, 6" Wide Locker, 18" Deep	78	S7B/3039015	700 Series® 15" Deep: 42-5/16" High	184
7CFL3061524/2D360B/6FLL	700 Series® Curve Cupboard/Bookcase/Markerboard: 30" Wide - 24" File, 6" Wide Locker, 24" Deep	80	S7B/3051012	700 Series® 12" Deep: 54-9/16" High	178
7CFL3061524/3D285B/6FLL	700 Series® Curve Cupboard/Bookcase/Markerboard: 30" Wide - 24" File, 6" Wide Locker, 24" Deep	84	S7B/3051015	700 Series® 15" Deep: 54-9/16" High	184
7CFL3061524/3D300B/6FLL	700 Series® Curve Cupboard/Bookcase/Markerboard: 30" Wide - 24" File, 6" Wide Locker, 24" Deep	82	S7B/3052515	700 Series® 15" Deep: 56-5/32" High	186
7CFL3061524/3D330B/6FLL	700 Series® Curve Cupboard/Bookcase/Markerboard: 30" Wide - 24" File, 6" Wide Locker, 24" Deep	86	S7B/3063012	700 Series® 12" Deep: 66-13/16" High	178
7FB/30495/2D270B	700 Series® Bookcase/File: 53-1/32" Bookcase/File	54	S7B/3063015	700 Series® 15" Deep: 66-13/16" High	186
7FB/30615/2D360B	700 Series® Bookcase/File: 65-9/32" Bookcase/File	54	S7B/BES12	700 Series® 15" Deep: 66-13/16" High	186
7FB/30615/2D390B	700 Series® Bookcase/File: 65-9/32" Bookcase/File	54	S7CB3025512	Book End Support	192
7FB/30615/3D330B	700 Series® Bookcase/File: 65-9/32" Bookcase/File	54	S7CB3025515	700 Series® Curve 12" Deep: 28-17/32" High	180
7FB/30615/4D225B	700 Series® Bookcase/File: 65-9/32" Bookcase/File	56	S7CB3039012	700 Series® Curve 15" Deep: 28-17/32" High	188
7FL/3061518/2D360B/6FLL	700 Series® Cupboard/Bookcase/Markerboard: 30" Wide - 24" File, 6" Wide Locker, 18" Deep	64	S7CB3039015	700 Series® Curve 12" Deep: 42-5/16" High	180
7FL/3061518/3D285B/6FLL	700 Series® Cupboard/Bookcase/Markerboard: 30" Wide - 24" File, 6" Wide Locker, 18" Deep	66	S7CB3051012	700 Series® Curve 15" Deep: 42-5/16" High	188
7FL/3061518/3D300B/6FLL	700 Series® Cupboard/Bookcase/Markerboard: 30" Wide - 24" File, 6" Wide Locker, 18" Deep	64	S7CB3051015	700 Series® Curve 12" Deep: 54-9/16" High	180
7FL/3061518/3D330B/6FLL	700 Series® Cupboard/Bookcase/Markerboard: 30" Wide - 24" File, 6" Wide Locker, 18" Deep	66	S7CB3051015	700 Series® Curve 15" Deep: 54-9/16" High	188
7FL/3061524/2D360B/6FLL	700 Series® Cupboard/Bookcase/Markerboard: 30" Wide - 24" File, 6" Wide Locker, 24" Deep	68	S7CB3063012	700 Series® Curve 12" Deep: 66-13/16" High	182
7FL/3061524/3D285B/6FLL	700 Series® Cupboard/Bookcase/Markerboard: 30" Wide - 24" File, 6" Wide Locker, 24" Deep	70	S7CB3063015	700 Series® Curve 15" Deep: 66-13/16" High	190
7FL/3061524/3D300B/6FLL	700 Series® Cupboard/Bookcase/Markerboard: 30" Wide - 24" File, 6" Wide Locker, 24" Deep	68	S7CL302102D	700 Series® Curve Drawer Units: 23-15/16" File, 2 High	20
7FL/3061524/3D330B/6FLL	700 Series® Cupboard/Bookcase/Markerboard: 30" Wide - 24" File, 6" Wide Locker, 24" Deep	68	S7CL302402D	700 Series® Curve Drawer Units: 27" File, 2 High	20
			S7CL302400VHD	700 Series® Curve Multimedia Storage Cabinets: 26-7/8" OverCupboard Storage Cabinet	100
			S7CL303603D	700 Series® Curve Drawer Units: 39-1/4" File, 3 High	20
			S7CL304804D	700 Series® Curve Drawer Units: 51-1/2" File, 4 High	20
			S7CL305104D	700 Series® Curve Drawer Units: 54-9/16" File, 4 High	22
			S7CL305255D	700 Series® Curve Drawer Units: 56-3/32" File, 5 High	22
			S7CL305555D	700 Series® Curve Drawer Units: 59-5/32" File, 5 High	22
			S7CL306152D36C	700 Series® Curve Cupboard/Lateral: 65-9/32"	46
			S7CL306155D	700 Series® Curve Cupboard/Lateral File	46
			S7CL306155M	700 Series® Curve Drawer Units: 65-9/32" File, 5 High	22
			S7CL306305D	700 Series® Curve Cupboard/Lateral: 65-9/32"	48
			S7CL306755M	Cupboard/Lateral File	48
			S7CL306756D	700 Series® Curve Drawer Units: 66-13/16" File, 5 High	24
			S7CL307356M	700 Series® Curve Cupboard/Lateral: 71-13/32"	50
			S7CL36525HD	Cupboard/Lateral File	50
			S7CP1520HBBB	700 Series® Curve Drawer Units: 71-13/32" File, 6 High	24
			S7CP1520HBF	700 Series® Curve Cupboard/Lateral: 77-13/32"	52
			S7CP1520HPBF	Cupboard/Lateral File	52
			S7CP1520MBBF	700 Series® Curve Multimedia Storage Cabinets: 56-3/32" Multimedia Storage Cabinet	100
			S7CP1520MBF	700 Series® Curve: Pedestal - BBB	222
			S7CP1520MFF	700 Series® Curve: Pedestal - BF	222
			S7CP1520MPBF	700 Series® Curve: Pedestal - PBF	222
			S7CP1520WBFF	700 Series® Curve: Pedestal - BBF	210
			S7CP1520WFF	700 Series® Curve: Pedestal - BF	208
			S7L/18615HWL	700 Series® Curve: Pedestal - FF	210
			S7L/30015F	700 Series® Curve: Pedestal - PBF	208
			S7L/30030D	700 Series® Curve: Pedestal - BBF	234
				700 Series® Curve: Pedestal - FF	234
				700 Series® Wardrobe Cabinets: 65-9/32" Wardrobe Multimedia Storage Cabinet	62
				Accessories: 1-1/2" Tie Bar	168
				700 Series® Drawers: 3" High Drawer	146



Model No.	Description	Page	Model No.	Description	Page
S7L/30060D	700 Series® Drawers: 6" High Drawers	146	S7L/30195	700 Series® Shells: 22-13/32" High Shell	130
S7L/30060S	700 Series® Shelves: 6" Rollout Shelf	156	S7L/3019T	700 Series® OF Storage Cabinet: Laminate Top for Side-by-Side Units	172
S7L/30075D	700 Series® Drawers: 7-1/2" High Drawer	146	S7L/30210	700 Series® Shells: 23-15/16" High Shell	130
S7L/30090D	700 Series® Drawers: 9" High Drawer	146	S7L/302102D	700 Series® Drawer Units: 23-15/16" File, 2 High	12
S7L/30105D	700 Series® Drawers: 10-1/2" High Drawer	146	S7L/30225	700 Series® Shells: 25-15/32" High Shell	130
S7L/30105DA	700 Series® Drawers: 10-1/2" High Drawer with Folder Bars	148	S7L/30240	700 Series® Shells: 27" High Shell	132
S7L/30120D	700 Series® Drawers: 12" High Drawer	150	S7L/302402D	700 Series® Drawer Units: 27" File, 2 High	12
S7L/30120DA	700 Series® Drawers: 12" High Drawer with Folder Bars	150	S7L/302402E	700 Series® End Tab Shelving Units: 27" File, 2 High	30
S7L/30120R	700 Series® Receding Doors and Shelves: 12" High Receding Door	152	S7L/302402R	700 Series® Receding Door Units: 27" File, 2 High	26
S7L/30120RED	700 Series® Receding Doors and Shelves: 12" High Receding Door w/End Tab Filing Shelf and 3 Dividers	152	S7L/30240BBF	700 Series® Credenza Files: 27-7/8" Credenza File - BBF	34
S7L/30120RS	700 Series® Receding Doors and Shelves: 12" High Receding Door w/Rollout Shelf	152	S7L/30240CC	700 Series® Credenza Files: 27-7/8" Credenza Cupboard	34
S7L/30120RSA	700 Series® Receding Doors and Shelves: 12" High Receding Door w/Rollout Shelf and Bars	152	S7L/30240FF	700 Series® Credenza Files: 27-7/8" Credenza File - FF34	
S7L/30120S	700 Series® Shelves: 12" Rollout Shelf	156	S7L/30240HD	700 Series® Multimedia Storage Cabinets: 27" Multimedia Storage Cabinet	88
S7L/30135D	700 Series® Drawers: 13-1/2" High Drawer	150	S7L/30240VHD	700 Series® Multimedia Storage Cabinets: 26-7/8" OverCupboard Storage Cabinet	96
S7L/30135DA	700 Series® Drawers: 13-1/2" High Drawer with Folder Bars	150	S7L/30240VHX	700 Series® Multimedia Storage Cabinets: 26-7/8" OverCupboard Storage Cabinet	96
S7L/30135DE	700 Series® Drawers: 13-1/2" High Drawer with Folder Bars	150	S7L/30255	700 Series® Shells: 28-17/32" High Shell	132
S7L/30135OV1F	700 Series® Overfile Cabinets: 16-5/32" Overfile Storage Cabinet	108	S7L/30255MHX	Accessories: 25-1/2" Hinged Door Insert	160
S7L/30135R	700 Series® Receding Doors and Shelves: 13-1/2" High Receding Door	152	S7L/30255MHXMB	Accessories: 25-1/2" Hinged Markerboard Door Insert	162
S7L/30135RED	700 Series® Receding Doors and Shelves: 13-1/2" High Receding Door w/End Tab Filing Shelf and 3 Dividers	152	S7L/30270	700 Series® Shells: 30-1/16" High Shell	132
S7L/30135RS	700 Series® Receding Doors and Shelves: 13-1/2" High Receding Door w/Rollout Shelf	152	S7L/302702D	700 Series® Drawer Units: 30-1/16" File, 2 High	12
S7L/30135RSA	700 Series® Receding Doors and Shelves: 13-1/2" High Receding Door w/Rollout Shelf and Bars	152	S7L/30285	700 Series® Shells: 31-19/32" High Shell	132
S7L/30150	700 Series® Shells: 17-13/16" High Shell	130	S7L/30285OV2F	700 Series® Overfile Cabinets: 31-15/32" Overfile Storage Cabinet	108
S7L/30150D	700 Series® Drawers: 15" High Drawer	150	S7L/30285OVHX	700 Series® Multimedia Storage Cabinets: 31-15/32" OverCupboard Storage Cabinet	96
S7L/30150DE	700 Series® Drawers: 15" High Drawer with Folder Bars	150	S7L/30300	700 Series® Shells: 33-1/8" High Shell	132
S7L/30150OV1F	700 Series® Overfile Cabinets: 17-11/16" Overfile Storage Cabinet	108	S7L/30300HD	700 Series® Multimedia Storage Cabinets: 33-1/2" Multimedia Storage Cabinet	88
S7L/30150R	700 Series® Receding Doors and Shelves: 15" High Receding Door	154	S7L/30300MHX	Accessories: 30" Hinged Door Insert	160
S7L/30150RED	700 Series® Receding Doors and Shelves: 15" High Receding Door w/End Tab Filing Shelf and 3 Dividers	154	S7L/30300MHXMB	Accessories: 30" Hinged Markerboard Door Insert	164
S7L/30150RS	700 Series® Receding Doors and Shelves: 15" High Receding Door w/Rollout Shelf	154	S7L/30300VHX	700 Series® Multimedia Storage Cabinets: 33" OverCupboard Storage Cabinet	96
S7L/30150RSE	700 Series® Receding Doors and Shelves: 15" High Receding Door w/Rollout Shelf and Bars	154	S7L/30315	700 Series® Shells: 34-21/32" High Shell	132
S7L/3015BFS	Accessories: Blank Filler Shelf	168	S7L/30315MHX	Accessories: 31-1/2" Hinged Door Insert	160
S7L/3015BLFS	Accessories: Locking Blank Filler Shelf	168	S7L/30315MHXMB	Accessories: 31-1/2" Hinged Markerboard Door Insert	164
S7L/3015FS	Accessories: 1-1/2" Tie Bar Shelf	168	S7L/30315OV2F	700 Series® Overfile Cabinets: 34-17/32" Overfile Storage Cabinet	108
S7L/3015LF	Accessories: 1-1/2" Locking Tie Bar	168	S7L/30315OVHX	700 Series® Multimedia Storage Cabinets: 34-17/32" OverCupboard Storage Cabinet	96
S7L/3015LFS	Accessories: 1-1/2" Locking Tie Bar Shelf	168	S7L/30330	700 Series® Shells: 36-3/16" High Shell	134
S7L/3015PS	700 Series® Shelves: 1-1/2" Posting Shelf	156	S7L/30330MHX	Accessories: 33" Hinged Door Insert	160
S7L/30165	700 Series® Shells: 19-11/32" High Shell	130	S7L/30330MHXMB	Accessories: 33" Hinged Markerboard Door Insert	164
S7L/30180	700 Series® Shells: 20-7/8" High Shell	130	S7L/30345	700 Series® Shells: 37-23/32" High Shell	134
S7L/3018T	700 Series® Lateral Files: Laminate Top for Side-by-Side Units	170	S7L/30360	700 Series® Shells: 39-1/4" High Shell	134
			S7L/303603D	700 Series® Drawer Units: 39-1/4" File, 3 High	12
			S7L/303603E	700 Series® End Tab Shelving Units: 39-1/4" File, 3 High	30
			S7L/303603R	700 Series® Receding Door Units: 39-1/4" File, 3 High	26
			S7L/30360HD	700 Series® Multimedia Storage Cabinets: 39-1/4" Multimedia Storage Cabinet	88
			S7L/30360OVHX	700 Series® Multimedia Storage Cabinets: 39-1/8" OverCupboard Storage Cabinet	98
			S7L/3036T	700 Series® Lateral Files: Laminate Top for Back-	

Index

Model No.	Description	Page	Model No.	Description	Page
	to-Back Units	170	S7L/30630	700 Series® Shells: 66-13/16" High Shell	140
S7L/30375	700 Series® Shells: 40-25/32" High Shell	134	S7L/30645	700 Series® Shells: 68-11/32" High Shell	140
S7L/30375MHX	Accessories: 37-1/2" Hinged Door Insert	162	S7L/306455D	700 Series® Drawer Units: 68-11/32" File, 5 High	16
S7L/30375MHXMB	Accessories: 37-1/2" Hinged Markerboard Door Insert	164	S7L/30660	700 Series® Shells: 69-7/8" High Shell	142
			S7L/30660HX	700 Series® Multimedia Storage Cabinets: 69-7/8" Multimedia Storage Cabinet	94
S7L/30390	700 Series® Shells: 42-5/16" High Shell	134			
S7L/30405	700 Series® Shells: 43-27/32" High Shell	134	S7L/30675	700 Series® Shells: 71-13/32" High Shell	142
S7L/30405OVHX	700 Series® Multimedia Storage Cabinets: 43-23/32" OverCupboard Storage Cabinet	98	S7L/306755M	700 Series® Cupboard/Lateral: 71-13/32" File	44
			S7L/306756D	700 Series® Drawer Units: 71-13/32" File, 6 High	18
S7L/30420	700 Series® Shells: 45-3/8" High Shell	136	S7L/30690	700 Series® Shells: 72-15/16" High Shell	142
S7L/30435	700 Series® Shells: 46-29/32" High Shell	136	S7L/30705	700 Series® Shells: 74-15/32" High Shell	144
S7L/30435OV3F	700 Series® Overfile Cabinets: 46-25/32" Overfile Storage Cabinet	110	S7L/30720	700 Series® Shells: 76" High Shell	144
			S7L/30735	700 Series® Shells: 77-17/32" High Shel	144
S7L/30435OVHX	700 Series® Multimedia Storage Cabinets: 46-25/32" OverCupboard Storage Cabinet	98	S7L/307356D	700 Series® Drawer Units: 77-17/32" File, 6 High	18
			S7L/307356E	700 Series® End Tab Shelving Units: 77-17/32" File, 6 High	32
S7L/30450	700 Series® Shells: 48-7/16" High Shell	136			
S7L/30450MHX	Accessories: 45" Hinged Door Insert	162	S7L/307356M	700 Series® Cupboard/Lateral: 77-17/32" File	44
S7L/30450MHXMB	Accessories: 45" Hinged Markerboard Door Insert	166	S7L/30735HD	700 Series® Multimedia Storage Cabinets: 77-17/32" Multimedia Storage Cabinet	92
S7L/30465	700 Series® Shells: 49-31/32" High Shell	136			
S7L/30480	700 Series® Shells: 51-1/2" High Shell	136	S7L/30ADF	Binder Frame: Acco Data	120
S7L/304804D	700 Series® Drawer Units: 51-1/2" File, 4 High	14	S7L/30BS	Adjustable Blank Shelf	122
S7L/304804E	700 Series® End Tab Shelving Units: 51-1/2" File, 4 High	30	S7L/30CF	Compressor Follower	116
			S7L/30CR	Coat Rod	116
S7L/304804R	700 Series® Receding Door Units: 51-1/2" File, 4 High	26	S7L/30DL	700 Series® Drawers: Individual Drawer Lock and Security Shelf	146
S7L/30480HD	700 Series® Multimedia Storage Cabinets: 51-1/2" Multimedia Storage Cabinet	90			
			S7L/30DT	700 Series® Files Lateral Toppers	116
S7L/30480OV3F	700 Series® Overfile Cabinets: 51-3/8" Overfile Storage Cabinet	110	S7L/30ETS	700 Series® Shelves: Fixed End Tab Filing Shelf	156
			S7L/30ETSC	Fixed End Tab Shelf	122
S7L/30480OVHX	700 Series® Multimedia Storage Cabinets: 51-3/8" OverCupboard Storage Cabinet	98	S7L/30FBA	Type "A" Folder Bars	112
			S7L/30FBE	Type "E" Folder Bars	112
S7L/30495	700 Series® Shells: 53-1/32" High Shell	136	S7L/30KIF	Binder Frame for Computer Print-outs	118
S7L/30495MHX	Accessories: 49-1/2" Hinged Door Insert	162	S7L/30LL	Legal/Letter Conversion	116
S7L/30495MHXMB	Accessories: 49-1/2" Hinged Markerboard Door Insert	166	S7L/30LLETS	EDP Legal/Letter Conversion	116
			S7L/30MEDKIT	Drawer Organizer	114
S7L/30510	700 Series® Shells: 54-9/16" High Shell	138	S7L/30MEDPAN	Organizer Front Pan	114
S7L/305104D	700 Series® Drawer Units: 54-9/16" File, 4 High	14	S7L/30RRC	Reel Insert Shelf for Storage Cabinets/Doors	118
S7L/30525	700 Series® Shells: 56-3/32" High Shell	138	S7L/30RRF	Reel Insert for Drawers	118
S7L/305255D	700 Series® Drawer Units: 56-3/32" File, 5 High	14	S7L/30SS	Slotted Shelf	122
S7L/30525HD	700 Series® Multimedia Storage Cabinets: 56-3/32" Multimedia Storage Cabinet	90	S7L/30TBS	Thin Blank Shelf (Screw Mount)	124
			S7L/30WLD	Binder Frame: WrightLine	118
S7L/30540	700 Series® Shells: 57-5/8" High Shell	138	S7L/33412DV	Plate Dividers	114
S7L/30555	700 Series® Shells: 59-5/32" High Shell	138	S7L/3346DV	6" Dividers	114
S7L/305555D	700 Series® Drawer Units: 59-5/32" File, 5 High	14	S7L/334DIV40	Organizer Divider	114
S7L/30570	700 Series® Shells: 60-11/16" High Shell	138	S7L/334FBJ	Type "J" Folder Bars	112
S7L/30585	700 Series® Shells: 62-7/32" High Shell	138	S7L/334FBK	Type "K" Folder Bars	112
S7L/30600	700 Series® Shells: 63-3/4" High Shell	140	S7L/334KIH	Binder Hanger	118
S7L/306005D	700 Series® Drawer Units: 63-3/4" File, 5 High	16	S7L/334MPART	Organizer Partition	114
S7L/306005R	700 Series® Receding Door Units: 63-3/4" File, 5 High	28	S7L/97003	Touch-up Paint	116
S7L/30600HD	700 Series® Multimedia Storage Cabinets: 63-3/4" Multimedia Storage Cabinet	92	S7L/CBW35	Counterbalance	112
			S7LE/302402DL1	700 Series® OF Extended Top Laminate Front: 27" File, 2 High	42
S7L/30615	700 Series® Shells: 65-9/32" High Shell	140			
S7L/306155D	700 Series® Drawer Units: 65-9/32" File, 5 High	16	S7LE/302402DX	700 Series® OF Extended Top No Fronts: 27" File, 2 High	38
S7L/306155E	700 Series® End Tab Shelving Units: 65-9/32" File, 5 High	32			
			S7LE/30240HL1	700 Series® OF Extended Top Laminate Fronts : 27" Storage Cabinet with Laminate Doors	106
S7L/306155M	700 Series® Cupboard/Lateral: 65-9/32" File	44			
S7L/306155R	700 Series® Receding Door Units: 65-9/32" File, 5 High	28	S7LE/303603DL1	700 Series® OF Extended Top Laminate Front: 39-1/4" File, 3 High	42
S7L/30615HD	700 Series® Multimedia Storage Cabinets: 65-9/32" Multimedia Storage Cabinet	92	S7LE/303603DX	700 Series® OF Extended Top No Fronts: 39-1/4" File, 3 High	38
S7L/30615HWS	700 Series® Wardrobe Cabinets: 65-9/32" Wardrobe Multimedia Storage Cabinet	62	S7LE/30360HL1	700 Series® OF Extended Top Laminate Fronts : 39-1/4" Storage Cabinet with Laminate Doors	106



Model No.	Description	Page	Model No.	Description	Page
S7LE/304804DL1	700 Series® OF Extended Top Laminate Front: 51-1/2" File, 4 High	42	S7P/CK	Caster Kit	236
S7LE/304804DX	700 Series® OF Extended Top No Fronts: 51-1/2" File, 4 High	38	S7P/D12	Hanging Folder Partition	238
S7LE/30480HL1	700 Series® OF Extended Top Laminate Fronts : 51-1/2" Storage Cabinet with Laminate Doors	106	S7P/D6	6" Partition	238
S7LE/305255DL1	700 Series® OF Extended Top Laminate Front: 56-3/32" File, 5 High	42	S7P/GK	Glide Kit	238
S7LE/305255DX	700 Series® OF Extended Top No Fronts: 56-3/32" File, 5 High	38	S7P/PENTRAY	Pencil Tray	238
S7LE/30525HL1	700 Series® OF Extended Top Laminate Fronts : 56-3/32" Storage Cabinet with Laminate Doors	106	S7PE/1520HBFL1	700 Series® OF Extended Top Laminate Front: Pedestal - BFL1	230
S7LF/302402DW1	700 Series® OF Flush Top Wood Fronts: 27" File, 2 High	40	S7PE/1520HBFX	700 Series® OF Extended Top No Front: Pedestal - BFX	226
S7LF/302402DX	700 Series® OF Flush Top No Fronts: 27" File, 2 High	36	S7PE/1524FBFL1	700 Series® OF Extended Top Laminate Front: Pedestal - BBFL1	218
S7LF/30240HDX	700 Series® OF Flush Top No Fronts : 27" Storage Cabinet	102	S7PE/1524FBFX	700 Series® OF Extended Top No Front: Pedestal - BBFX	214
S7LF/30240HW1	700 Series® OF Flush Top Veneer Fronts : 27" Storage Cabinet with Wood Doors	104	S7PE/1524FFFL1	700 Series® OF Extended Top Laminate Front: Pedestal - FFL1	218
S7LF/303603DW1	700 Series® OF Flush Top Wood Fronts: 39-1/4" File, 3 High	40	S7PE/1524FFFX	700 Series® OF Extended Top No Front: Pedestal - FFX	214
S7LF/303603DX	700 Series® OF Flush Top No Fronts: 39-1/4" File, 3 High	36	S7PF/1520HBFW1	700 Series® OF Flush Top Wood Front: Pedestal - BFW1	228
S7LF/30360HDX	700 Series® OF Flush Top No Fronts : 39-1/4" Storage Cabinet	102	S7PF/1520HBFX	700 Series® OF Flush Top No Front: Pedestal - BFX	224
S7LF/30360HW1	700 Series® OF Flush Top Veneer Fronts : 39-1/4" Storage Cabinet with Wood Doors	104	S7PF/1524FBFW1	700 Series® OF Flush Top Wood Front: Pedestal - BBFW1	216
S7LF/304804DW1	700 Series® OF Flush Top Wood Fronts: 51-1/2" File, 4 High	40	S7PF/1524FBFX	700 Series® OF Flush Top No Front: Pedestal - BBFX	212
S7LF/304804DX	700 Series® OF Flush Top No Fronts: 51-1/2" File, 4 High	36	S7PF/1524FFW1	700 Series® OF Flush Top Wood Front: Pedestal - FFW1	216
S7LF/30480HDX	700 Series® OF Flush Top No Fronts : 51-1/2" Storage Cabinet	102	S7PF/1524FFFX	700 Series® OF Flush Top No Front: Pedestal - FFX	212
S7LF/30480HW1	700 Series® OF Flush Top Veneer Fronts : 51-1/2" Storage Cabinet with Wood Doors	104	S7V/1518FB	Folder Bars	250
S7LF/305255DW1	700 Series® OF Flush Top Wood Fronts: 56-3/32" File, 5 High	40	S7V/15302DCF	700 Series® Letter Size Documents: 25-3/4" File, 2 High	246
S7LF/305255DX	700 Series® OF Flush Top No Fronts: 56-3/32" File, 5 High	36	S7V/15303DCF	700 Series® Letter Size Documents: 36-7/8" File, 3 High	246
S7LF/30525HDX	700 Series® OF Flush Top No Fronts : 56-3/32" Storage Cabinet	102	S7V/15304DCF	700 Series® Letter Size Documents: 48" File, 4 High	246
S7LF/30525HW1	700 Series® OF Flush Top Veneer Fronts : 56-3/32" Storage Cabinet with Wood Doors	104	S7V/15305DCF	700 Series® Letter Size Documents: 59-1/8" File, 5 High	246
S7P/1520FBBBB	700 Series®: Pedestal - BBBB	206	S7V/15CF	Compressor	250
S7P/1520FBBF	700 Series®: Pedestal - BBF	206	S7V/18302DCF	700 Series® Legal Size Documents: 25-3/4" File, 2 High	248
S7P/1520FFF	700 Series®: Pedestal - FF	206	S7V/18303DCF	700 Series® Legal Size Documents: 36-7/8" File, 3 High	248
S7P/1520FPBBB	700 Series®: Pedestal - PBBB	206	S7V/18304DCF	700 Series® Legal Size Documents: 48" File, 4 High	248
S7P/1520FPBF	700 Series®: Pedestal - PBF	204	S7V/18305DCF	700 Series® Legal Size Documents: 59-1/8" File, 5 High	248
S7P/1520HBBB	700 Series®: Pedestal - BBB	220			
S7P/1520HBF	700 Series®: Pedestal - BF	220			
S7P/1520HPBBB	700 Series®: Pedestal - PBBB	220			
S7P/1520HPBF	700 Series®: Pedestal - PBF	220			
S7P/1520MBBB	700 Series®: Pedestal - BBB	204			
S7P/1520MBF	700 Series®: Pedestal - BF	204			
S7P/1520WBBBB	700 Series®: Pedestal - BBBB	232			
S7P/1520WBBF	700 Series®: Pedestal - BBF	232			
S7P/1520WFF	700 Series®: Pedestal - FF	232			
S7P/1524MBFTP	700 Series®: Pedestal - BFTP	204			
S7P/1715T	Laminate Tops	242			
S7P/CBW20	Counterbalance Weight	236			
S7P/CBW36	Counterbalance Weight	236			



KI
1330 Bellevue Street
P.O. Box 8100
Green Bay, Wisconsin 54308-8100
1-800-424-2432
www.ki.com

KI and Furnishing Knowledge
are registered trademarks
of Krueger International, Inc.

© 2011 KI
All Rights Reserved.
Litho in USA.
Code KI-11493R1/KI/VL/211

Printed using only water-based inks,
including metallics. Please recycle.