

D A R R A N

# Richmond Park

price list | effective January 2016 | updated 1.19.17



## RICHMOND PARK PRICE LIST REVISIONS

DATE	PAGE	MODIFICATION	DESCRIPTION
7.20.16	ALL	Removed Finish	Removed discontinued finish GRC Caramel Cherry

TABLE OF CONTENTS

Product index ..... 2

General Information ..... 4

Limited Lifetime Warranty ..... 5

Damages | Returns | Reparis ..... 6

Ordering Information ..... 7

GSA Customer Information ..... 8

Freight..... 9

Features & Advantages ..... 10

Finishes | Specifications..... 12

Edges | Pulls | Knobs..... 13

Grommets | Grommet Reference ..... 14

Ganging | Height Reference ..... 15

Modesty Reference | Grain Direction..... 16

Drawer Dimensions | FILING Reference ..... 17

Double Pedestal Desk ..... 18

Table Desk..... 21

Single Pedestal Desk ..... 23

Conference Desk ..... 25

Service Desk ..... 27

Returns..... 29

Bridges ..... 31

Corner Units..... 32

Freestanding Credenzas..... 33

Workstation Credenzas..... 38

Service Credenzas..... 40

Single Height Freestanding Overheads ..... 42

Overhead Accessories..... 45

Single Height Wall Hung Overheads ..... 49

Wall Hung Accessories ..... 51

Overhead Half Towers ..... 56

Overhead Bookcases ..... 58

Vertical Half Towers ..... 60

Vertical Full Towers ..... 63

Bookcases..... 65

Reception..... 67

Options ..... 71

Power and Data..... 94

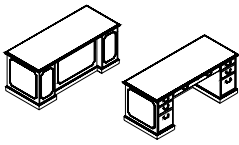

PAGE 18  
DOUBLE PEDESTAL DESKS

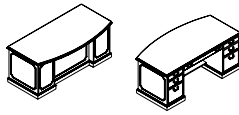

PAGE 19  
DOUBLE PEDESTAL DESKS

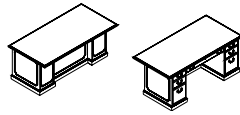

PAGE 20  
DOUBLE PEDESTAL DESKS

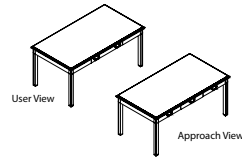

PAGE 21  
DESKS

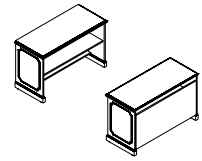

PAGE 22  
DESKS

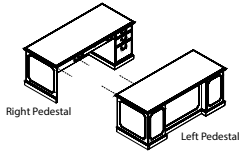

PAGE 23  
WORKSTATION DESKS

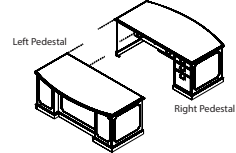

PAGE 24  
WORKSTATION DESKS

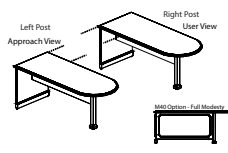

PAGE 25  
WORKSTATION DESKS

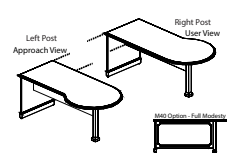

PAGE 26  
WORKSTATION DESKS

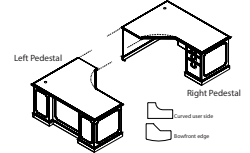

PAGE 27  
SERVICE WORKSTATION DESKS

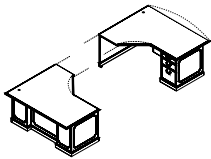

PAGE 28  
SERVICE WORKSTATION DESKS

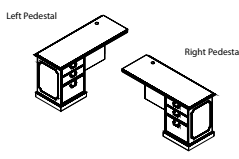

PAGE 29  
WORKSTATION RETURNS

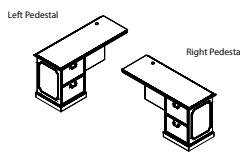

PAGE 30  
WORKSTATION RETURNS

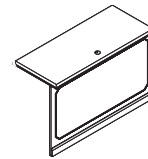

PAGE 31  
WORKSTATION UNITS

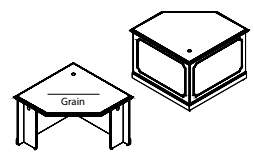

PAGE 32  
CORNER UNIT

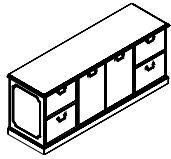

PAGE 33  
CREDENZAS / FILES

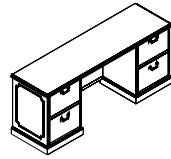

PAGE 34  
CREDENZAS / FILES

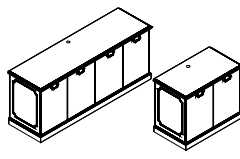

PAGE 35  
CREDENZAS / FILES

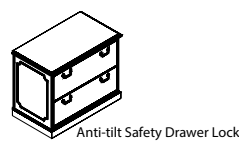

PAGE 36  
LATERAL FILE CREDENZAS



PAGE 37  
CREDENZAS / FILES

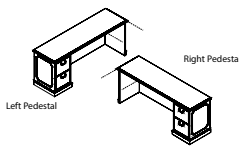

PAGE 38  
WORKSTATION CREDENZA

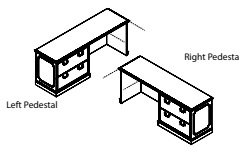

PAGE 39  
WORKSTATION CREDENZA

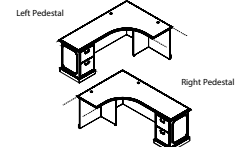

PAGE 40  
SERVICE CREDENZAS

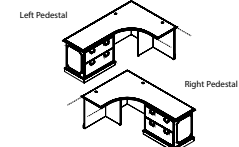

PAGE 41  
SERVICE CREDENZAS

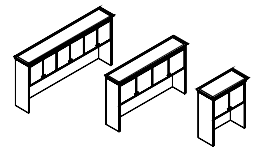

PAGE 42  
OVERHEAD CONSOLES

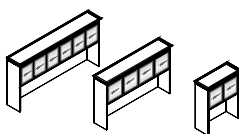

PAGE 43  
OVERHEAD CONSOLES

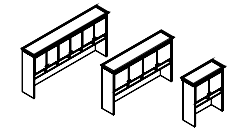

PAGE 44  
OVERHEAD CONSOLES W/ PAPER ORGANIZER

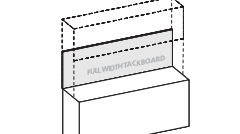

PAGE 45  
OVERHEAD TACKBOARDS

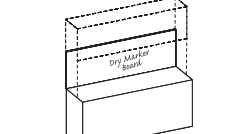

PAGE 46  
OVERHEAD DRY MARKER BOARDS

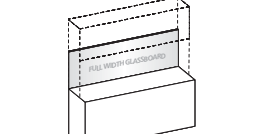

PAGE 47  
OVERHEAD GLASSBOARDS

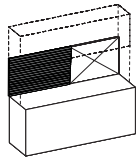

PAGE 48  
OVERHEAD SLAT WALL

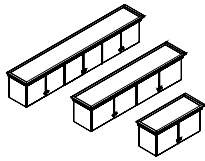

PAGE 49  
WALL HUNG OVERHEADS

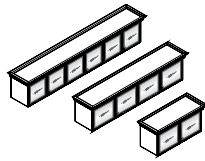

PAGE 50  
WALL HUNG OVERHEADS

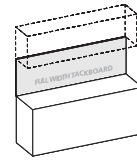

PAGE 51  
WALL HUNG TACKBOARDS

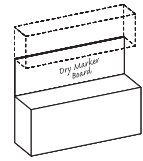

PAGE 52  
WALL HUNG DRY MARKER  
BOARDS

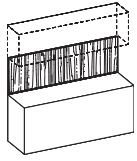

PAGE 53  
WALL HUNG VENEER PANELS

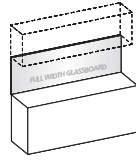

PAGE 54  
WALL HUNG GLASSBOARDS

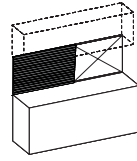

PAGE 55  
WALL HUNG SLAT WALL

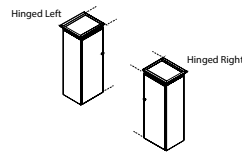

PAGE 56  
GANGING OVERHEAD EXTENSION  
TOWERS

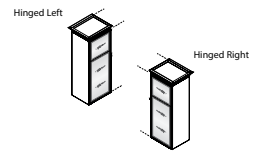

PAGE 57  
GANGING OVERHEAD EXTENSION  
TOWERS



PAGE 58  
ASSEMBLED OVERHEAD  
BOOKCASE / HUTCH

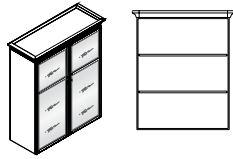

PAGE 59  
ASSEMBLED OVERHEAD  
BOOKCASE / HUTCH

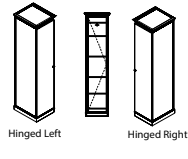

PAGE 60  
VERTICAL HALF TOWERS

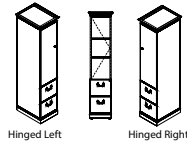

PAGE 61  
VERTICAL HALF TOWERS

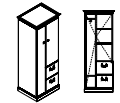

PAGE 62  
VERTICAL HALF TOWERS

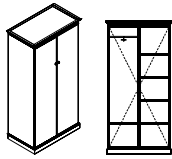

PAGE 63  
VERTICAL FULL TOWERS

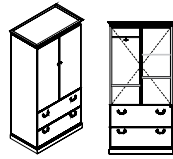

PAGE 64  
VERTICAL FULL TOWERS

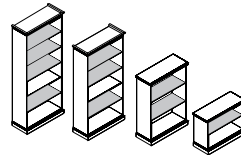

PAGE 65  
ASSEMBLED BOOKCASES

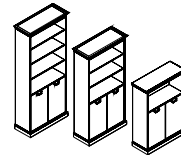

PAGE 66  
ASSEMBLED BOOKCASES

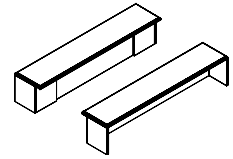

PAGE 67  
SIT-ON TRANSACTION COUNTERS

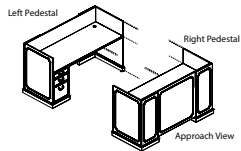

PAGE 68  
RECEPTION DESK

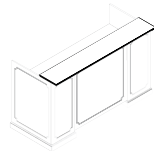

PAGE 69  
RECEPTION DESK COUNTERTOPS

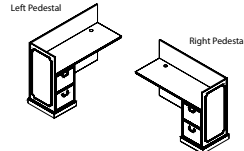

PAGE 70  
RECEPTION RETURN



All DARRAN products are proudly manufactured in the U.S.A.

**BUILT TO ORDER**

Manufactured per order the way you want it, including modifications.

**FULLY ASSEMBLED**

Unless otherwise noted, all products are fully assembled and ready to use, including add-on options.

**PERFORMANCE TESTED**

All products are tested to ensure performance exceeds BIFMA / ANSI standards.



**GREEN CERTIFIED**

DARRAN has been committed to improving indoor air quality of office buildings since 1996. Since then, finish technology has allowed our commitment to continue with products that are air quality Certified Green.

DARRAN is proud to announce that all in veneer, laminate, and guest seating are MAS Certified Green for complying with the ANSI/BIFMA X 7.1 standard / LEED 4.5 Standard for low –VOC emitting Furniture.

MAS is an independent emission testing laboratory that is ISO 17025 compliant using ASTM, ANSI and CEN methods. MAS is a true 3rd party certification through NSF International to BIFMA standards and California’s ARB formaldehyde standard. Certification of compliance under the Low – VOC emitting Furniture testing, qualifies products for LEED 4.5 credits.



**FINISH TECHNOLOGY**

DARRAN has continued its partnership with AkzoNobel Chemicals ([www.akzonobel.com](http://www.akzonobel.com)) to develop a new finish technology further improving indoor air quality with a coating that meets today’s environmental standards and supports LEED buildings.

ENVI-CT (Environmental Coatings Technology) utilizes advanced European finish technology to deliver a high-end furniture coating with superior performance in appearance and durability, allowing DARRAN to deliver more sustainable products to our customers.

*ENVI-CT Advantages:*

- › ENVI-CT is a re-engineered high performance Top Coat
- › Exceptional hardness and clarity
- › Highly resistant to solvents and chemicals
- › Plasticizer Migration resistant
- › Excellent UV inhibitors for maximum color resistance
- › Exceeds current and proposed future Federal and State air quality requirements
- › Field Repairable
- › Dynamic chamber emissions tested and certified compliant to ANSI/BIFMA X 7.1 Standard / LEED 4.5 Standard for low – VOC emitting furniture.
- › Standard with Anti-microbial additive.

**ADVANTAGES**

DARRAN has upgraded the standard Anti-microbial protection, to , the latest in Silver Ion Technology. DARRAN collaborated with the world’s leader in finishing materials, to formulate an additive that will inhibit the growth of mold, mildew, fungus and bacteria on wood surfaces. This additive infuses Silver Ions into DARRAN’s ENVI-CT (Environmental Coatings Finish Technology), creating a protective surface for the life of the furniture. The best part - is standard on all DARRAN Caseloads for no additional fee.



## LIMITED LIFETIME WARRANTY

DARRAN Furniture Industries, Inc. ("DARRAN") warrants that each piece of furniture manufactured in its North Carolina Facilities will be free from defects in material and workmanship for as long as the original purchaser owns and uses the product. Subject to the limitations and exclusions herein, DARRAN, at its discretion and as the sole remedy under the DARRAN Limited Lifetime Warranty, will replace or repair a defective product or components with comparable product or components free of charge. This warranty is made only to the original purchaser from an authorized DARRAN dealer, for as long as that original purchaser owns and uses the product.

### LIMITATIONS: USE / CARE

- › Warranty is limited to normal single shift use.
- › Warranty is limited to generally accepted care and maintenance of natural wood products and environments.
- › Natural wood surfaces are subject to denting, scratching, and gauging if not properly used and cared for. Warranty is subject to use and care in accordance with the use and care instructions provided in the Product Care section of this site (including, but not limited to, the care and maintenance guide downloads linked thereon), available at [www.darran.com/product-care](http://www.darran.com/product-care), which are incorporated herein by reference.

### LIMITATIONS: MATERIALS / COMPONENTS

- › Laminates, Veneers / Finishes - 10 Years
- › Electrical lamps, Ballasts, Transformers - 5 Years
- › Fabrics, Pneumatic lifts, Foam - 5 Years
- › Custom products built to customers specifications - 3 Years

### WARRANTY EXCLUSIONS

*Damage identified as carrier or installer related.*

- › Normal wear and tear of wood products during course of ownership.
- › Color, grain, or texture of natural wood materials, laminates, and other covering materials.
- › Damages or failures resulting from misuse, abuse, negligence, improper care, modifications, or relocation.
- › Non Commercial use or locations.
- › So-called "ghost" indentions and similar damage caused by the failure to use appropriate desk or writing pads.

All Warranty Claims are subject to DARRAN-approved inspections. Disputes may involve independent third-party evaluation

### QUALITY ASSURANCE

DARRAN manufactures in accordance with the standards set by Architectural Woodwork Institute (AWI) for Quality Standards.

Every unit produced at DARRAN is completely inspected by an independent quality control team located within each plant whose emphasis is on assembly, finish, and final inspections with empowerment to stop any unit not meeting DARRAN's high quality standards.

### LIGHT AND NATURAL FINISHES

The beauty of veneer and all wood products comes from the variations created by nature including color, grain, and texture.

These variations are not considered defects and DARRAN's Limited Lifetime Warranty does not cover color, grain and texture variations associated with natural wood and grain seen in any finish color. DARRAN sets standards for veneer selections; however, variations, especially apparent in light/natural finishes, will occur from one piece to another even if they are finished at the same time.

Finishes such as Clear Maple, Light/Gunstock Walnut, and Clear/Caramel Cherry will display more natural characteristics due to their light stain. Grain, pattern and color from unit to unit are not guaranteed or warranted and products will not be replaced due to these variations. Exposure to light and age will cause darkening of natural wood products; therefore DARRAN cannot guarantee or warrant finish match of new products being placed with existing products in the field.

### GLASS

Use of glass overlays on surfaces will void DARRAN's Limited Lifetime Warranty, unless the overlay is installed and maintained in strict accordance with DARRAN's instructions. If an overlay is to be used, please contact DARRAN for installation and maintenance instructions.

### GENERAL

Performance questions will be tested to generally accepted practices and AWI guidelines and standards for wood veneer furniture. To obtain performance of the Limited Lifetime Warranty, the purchaser should contact in writing the authorized DARRAN representatives or current dealer who sold the product to the purchaser or mail the warranty claim to:

Warranty Department  
DARRAN Furniture Industries, Inc.  
P.O. Box 7614  
High Point, NC 27264  
Telephone: 336-861-2400      Toll Free: 800-334-7891  
email: [warranty@darran.com](mailto:warranty@darran.com)

EXCEPT FOR THE LIMITED LIFETIME WARRANTY EXPRESSLY DESCRIBED HEREIN, DARRAN MAKES NO OTHER REPRESENTATION OR WARRANTY OF ANY KIND, EXPRESS OR IMPLIED. DARRAN MAKES NO WARRANTY OF MERCHANTABILITY OR FITNESS FOR A PARTICULAR PURPOSE, AND DARRAN WILL NOT UNDER ANY CIRCUMSTANCES BE LIABLE FOR ANY INCIDENTAL OR CONSEQUENTIAL DAMAGES, OR ANY INDIRECT OR SPECIAL DAMAGES.

### THE WARRANTY AS STATED ABOVE, SUPERSEDES ALL PREVIOUS WARRANTIES

**NO HASSLE FREIGHT DAMAGED MERCHANDISE**

DARRAN products are packed in specially designed cartons and padding that protects all edges and corners from damage. This is proven by an industry low damage rate of .0030% per total pieces shipped.

For qualified freight damage claims DARRAN will take responsibility for the claim and remedy processes including assuming total cost coverage from claim settlements.

(Some items may not qualify. Contact Factory for specific details.)

**QUALIFIED CLAIM CONDITIONS****VISIBLE CARTON DAMAGE**

1. Take digital pictures of the damaged carton and damaged furniture if visible damage is found upon delivery at the dock
2. Open all cartons with puncture or crushed corner damage.
3. Note any damage to the goods on the Carrier's freight bill as number of pieces damaged.

**CONCEALED DAMAGE**

1. Take digital pictures of the furniture as it sits partially unpacked. Also, photograph external and internal carton materials that correspond with the damaged area on the product.
2. Carton and damaged unit(s) must be located at the location matching the original delivery address for Carrier inspection.
3. Digital pictures must be provided of the damaged furniture and carton materials

For qualified claims per above contact DARRAN Customer Service Department at 1-800-334-7891 or complete DARRAN's online warranty report form within the 15 day limit. [www.darran.com/warrantyreport](http://www.darran.com/warrantyreport)

**NON-QUALIFIED CLAIM CONDITIONS**

1. Deliveries made to non-dock locations
2. Claims made after furniture is installed and/or removed from original delivery location
3. Carton and padding has been discarded
4. Carrier used was not DARRAN approved
5. Inspection reveals questionable damages

**REPLACEMENT ORDERS**

Replacement orders entered without replacement tagging or factory authorization is considered a new order without dispute, therefore full payment is expected and will be collected.

**RETURN SHIPMENTS**

DARRAN will not accept return of merchandise without a signed RA (return authorization) form.

DARRAN will specify the carrier to be used. Return bills of lading must be marked "Class 125" freight rate and a copy of the RA should be used as a packing list. All returns must be received by DARRAN within 30 days of the RA date or the products will be considered accepted by the customer.

All products being returned must be properly packed and protected to avoid freight damage. Whenever possible, use the original cartons in which the merchandise was shipped. Freight

damage, signs of usage, missing parts, etc., will result in an adjustment of any credit to be issued.

DARRAN will issue RA's for the following reasons:

1. Manufacturing defect (inspection required)
2. Order processing error by DARRAN
3. Shipping error
4. Mismatched carton / merchandise

**SPECIFICATION CHANGES**

We reserve the right to change without notice any dimension, style, or specification of any model in the DARRAN line. Dimensions shown in the price list are nominal. It is the buyer's responsibility to read specification carefully when matching existing goods is desired.

**MANUFACTURING DEFECTS**

Claims of manufacturing defects will not be entertained without prior consultation with DARRAN's warranty department. Unauthorized deduction in payment of invoices will not be allowed without prior factory approval. Unapproved deductions are subject to factor's late payment charges.

**DAMAGE CLAIMS**

Claims of manufacturing damage or freight damage reported as nicks, dents, scratches, etc. after installation of furniture will not be covered under warranty or freight claim.

**ATTENTION:** Damage claims involving glass or stone components must be inspected and damage noted on delivering freight bill to qualify for replacement.

**REPAIR CHARGES**

Factory authorization must be secured from DARRAN's warranty department prior to incurring repair charges. Warranty will utilize DARRAN's National Repair Service through the Furniture Medic Franchise ([www.furnituremedic.com](http://www.furnituremedic.com)).

Repair charge authorizations are based on:

- › Set travel rate
- › Average regional job rate
- › Factory set maximum repair time
- › Falsely reported defect claims are subject to local service charges being charged to dealer/distributor.

**FINISH MAINTENANCE**

Wood office furniture and wood finishes can retain their natural beauty for life if proper care is taken and a stable environment is provided. Fluctuations in humidity and temperature cause panels and solid wood components to expand and contract and may lead to panel warpage and finish "checking" or cracking. Prolonged exposure of furniture to dry heat during winter months should be avoided. Careful examination of interior wood trim may indicate a damaging dry environment. If open joints, splits and cracks are appearing in trimwork consult with a HVAC professional for appropriate remedy.

DARRAN finishes are field repairable should damage occur. Professional furniture repair services are recommended. Regular cleaning with a non-silicone polish is recommended.



**ORDERING**

All orders should be emailed, mailed or transmitted by fax to:

DARRAN Furniture Industries, Inc.  
P.O. Box 7614  
High Point, NC 27264  
email: orders@darran.com  
Fax: 336-861-6485

DARRAN will only accept orders from authorized Dealers. All orders must be accurate and detailed. All Quick Ship orders must contain Quick Ship product ONLY. Orders should be separated and submitted according to lead time. Orders must contain Quick Ship code "QS" or have designated Quick Ship lead time to ensure correct order entry. Orders that contain multiple lead time products will be entered as one order and scheduled with the most extended lead time.

**CREDIT APPROVAL**

All orders are subject to credit approval for open account. All new accounts must be approved by a local DARRAN Sales Representative and should submit current financial information and trade references to:

DARRAN Furniture Industries, Inc. ATTN: Credit Department  
P.O. Box 7614  
High Point, NC 27264  
Telephone: 336-861-2400 Toll Free: 800-334-7891  
Fax: 336-861-2512

Orders submitted without accounts pre-approval or credit approval are subject to acceptance with lead times scheduled only after approval dates.

**LEAD TIME SCHEDULE**

DARRAN cannot assign a firm lead time until Credit approval and order accuracy are complete. Extended lead times due to credit or information delays are the responsibility of the Buyer.

**ORDER DELAY / HOLD**

Due to the committed manufacturing cost on Quick Ship processes, DARRAN cannot delay or hold orders, either in process or after completion.

**CANCELLATION AND ORDER CHANGES - FEES**

Acknowledged orders are considered firm orders and therefore not subject to cancellation or change. However, in the event we are able to stop an order prior to manufacturing process, we will consider cancellation or changes with a reprocessing fee of \$40.00 Net. Exceptions: Quickship orders cannot be changed or canceled after the 3rd business date after acknowledgment. Qualified changes/cancellations will be assessed a \$40.00 Net processing fee.

Changes or cancellation of order with special options or custom quoted items are also subject to additional material and vendor fee costs, plus a DARRAN special/custom reprocessing fee of \$100 NET.

**ORDER MOVEUPS**

Should an original scheduled ship date need to be improved, the Factory must be contacted 15 business days prior to the desired ship date. Move ups are subject to schedule availability.

**ORDER ACKNOWLEDGMENT**

Upon credit approval your order will be acknowledged and identified by an order number. When making reference to your order, please use this order number. Your acknowledgment is a detailed description of our interpretation of your order, pricing, shipping information, and estimated delivery date.

If you have not received an Acknowledgment within 10 Days of order issue, contact Customer Service immediately. All Quick Ship order acknowledgments will be faxed or emailed upon request to speed processing. Please read your acknowledgment carefully for correctness and notify DARRAN immediately of any discrepancies. Failure to notify relieves DARRAN from error liability.

Order acknowledgment is the final agreement between DARRAN and the customer superseding all previous communications regarding the order. DARRAN will not be responsible for errors made on orders placed by phone without written confirmation.

**SELLING INFORMATION**

Possession of this price list does not in itself constitute the right to sell DARRAN products. DARRAN products are sold and distributed through authorized dealerships. Contact factory for a listing of local representatives and dealerships.

**INVOICE TERMS**

Standard terms are NET 30 days. Finance charges of 1-1/2% will be added to delinquent accounts after 45 Days and for each 30 Days thereafter until paid.

Complaints involving newly received merchandise must be reported within 10 days from receipt to qualify for full invoice remittance suspension or term extension. Otherwise only items in dispute can be suspended from payment of invoice within terms.

**WAREHOUSE/STORAGE**

DARRAN will determine order warehousing approvals on a case by case basis. Orders that can be accommodated will be limited to a max of 30 days storage and must be invoiced at time of storage. Orders that exceed factory storage capacity will be transferred to local storage facilities subject to current storage rates and handling-transit charges. Storage charges must be paid prior to order release to shipping.

**EXECUTIVE OFFICE & CONFERENCE ROOM  
FURNITURE**

**November 3, 2015 through November 2, 2020**

FSC Group 71

GSA CONTRACT NUMBER: GS-27F-001DA

Business Classification:

WBENC Certified Woman-Owned Small Business

DARRAN FURNITURE INDUSTRIES

2402 SHORE DRIVE

HIGH POINT, NC 27263

336.861.2400 FAX 336.861.6485

Business Classification:

Woman-Owned Small Business

On-line access to contract ordering information, terms and conditions, up-to-date pricing, and the option to create an electronic delivery order are available through GSA Advantage!, a menu driven database system. The INTERNET address for GSA Advantage is <http://www.fss.gsa.gov>

For more information on ordering from Federal Supply Schedules click on the FSS Schedules button at <http://www.fss.gsa.gov>

**1a. Special Item Number**

711-8: Executive Office Furniture

711-9: Executive Conference Room Furniture

711-11: Tables and Accessories

711-16: Upholstered Seating

711-18: Multi-purpose Seating

**2. Maximum Order Limitations:**

711-8 \$500,000

711-9 \$500,000

711-11 \$500,000

711-16 \$300,000

711-18 \$200,000

**3. Minimum Order: \$100**

**4. Geographic Coverage:** 48 Contiguous States and the District of Columbia

**5. Point of Production:** High Point, North Carolina (Randolph County)

**6. Discount:** Prices shown herein are List (Discount is 56.9% Off List)

**7. Quantity Discounts:**

• \$467,837 List to \$1,000,000 List = 59.70%

• \$1,000,001 List to \$1,315,789 List = 61.70%

**8. Payment Terms:** ½% - Net 15 Days, Net 30 Days

**8a. Terms and Conditions of Government Credit Card Acceptance:**

a. No discount allowed for payment by Government Purchase Card

b. Provide commercial credit card number

c. Provide commercial credit card expiration date

d. Provide individual's name as it appears on

credit card

e. Provide telephone number of individual to whom credit is issued

**9a. Government Purchase Cards are accepted below the Micro Purchase Threshold.**

**9b. Government Purchase Cards are accepted above the Micro Purchase Threshold.**

**10. Foreign Terms:** None

**11a. Time of Delivery:** Regular Product: 60 - 90 days after receipt of order

Quick Ship Program: Contact DARRAN

**11b. Quick Ship Program:** Items available for expedited delivery are included in main Price Lists.

**11c. Overnight and 2-day delivery:** N/A

**11d. Urgent Requirements:** Will be considered on an individual basis. Contact DARRAN for details.

**12. FOB Point:** All destinations are limited to Commercial docks only. Carriers may refuse non-dock deliveries.

**12a. Freight Prices:**

a. All prices shown are suggested list prices with freight included where indicated.

b. Freight allows delivery to one qualified destination.

c. Within the Continental USA, all orders above \$1,500 net are shipped FOB factory, freight prepaid and allowed. All orders less than \$1,500 net will be subject to a \$100 net freight charge.

**13. Ordering Address:**

DARRAN Furniture Industries

P.O. Box 7614

High Point, NC 27264

Ph: 800.334.7891

Fax: 336.861.6485

**13a. Payment Address:**

BB&T

P.O. Box 890011

Charlotte, NC 28289-0011

**14. Warranty Provision:** Limited Lifetime (Contact DARRAN for details)

**15. Export Packing Charges:** Quoted on request

**13. Terms and Conditions: Order Cancellation / Changes.**

Restocking/Returns: No merchandise may be returned without a return authorization and shipping instructions. No credit or allowance will be given for repairs to defective materials unless DARRAN has given authority to make such repairs. A restocking charge of 25% will apply.

Cancellation: No cost prior to production. After

## GSA CUSTOMER INFORMATION

production has begun, only actual cost incurred will be billed to the Government that cannot be recovered through resale in 6 months

**14. Terms and Condition of Rental, Maintenance and Repair: Consult the Factory.**

**15. Terms and Conditions of Installation:** Installation by a Third party to be quoted on a per job basis. The ordering must specify what ranges of installation services are required.

**16. Terms and Conditions of Repair Parts:** Contact DARRAN for details.

**17. List of Service and distribution points:** Contact DARRAN for details..

**18. Preventative Maintenance:** Information enclosed with product.

**19. List of Participating Dealers:** Contact DARRAN for details.

**23. Environmental Attributes:** DARRAN is compliant with EPA standards. All plywood core material is CARB 2 compliant and contains recycled content. All DARRAN Casegood Products are BIFMA Level 2 Certified. DARRAN is FSC CoC Certified and our products are MAS Certified for Indoor Air Quality.

**23a. Recyclable and Recycled Content Packaging:** The corrugated packaging that is supplied to DARRAN, meets the federal mandate that requires the paperboard to be composed of 30%-50% recycled paper, and in some cases the recycled content is close to 100%.

**23b. Chemical Emission:** DARRAN finishes its products in an ENVI-CT Finish. (Environmental Coatings Technology). DARRAN's seating is finished with a low VOC Conversion Varnish and the casegoods are finished with a formaldehyde free, low VOC Urethane finish. These ENVI-CT finishes allow DARRAN's products to be MAS Certified Green under the ANSI BIFMA X7.1 Standard. Products assist with LEED 4.5 Credit.

**23c. Vapor Emissions:** DARRAN's ENVI-CT finishes use the latest environmental coatings technology to provide lasting durability and exceptional clarity with BACGUARD Silver anti-microbial protection built-in. The ENVI-CT finishes allows DARRAN casegoods to be MAS Certified Green meeting LEED Credit 4.5.

**24a. Duns Number:** 08-363-5318

**24b. Cage Code:** 0Y-6B6

**24c. Federal ID Number:** 56-117-1971

**24d. NAICS Code:** 337211

**25. SAM Network:** DARRAN is registered

## SHIPPING SCHEDULE

When requested, DARRAN will assist in locating special express carriers that may have short transit times. These services may exceed our prepaid freight costs; therefore, pricing is limited to the Freight Excluded formula with special express charges added to the invoice.

For special deliveries, DARRAN will make every effort to meet the appointed time; however DARRAN will not be responsible for any additional charges for late deliveries beyond our control.

## PRICES

- › All prices shown are suggested list prices with freight included where indicated.
- › Freight allows delivery to one qualified destination.
- › Within the Continental USA, all orders above \$1,500 net are shipped FOB factory, freight prepaid and allowed. All orders less than \$1,500 net will be subject to a \$100 net freight charge.

## CALL BEFORE DELIVERY REQUEST

DARRAN will arrange for carriers to call before delivery when requested.

Important Non-Qualified Destinations DARRAN Prepaid Freight Pricing does not include delivery to:

- › Residential Areas
- › Restricted Commercial Areas
- › No Dock Locations
- › Inside delivery/setup service

Orders received and installed without professional Furniture Installers voids all Warranty Coverage.

## CARRIER SELECTION

DARRAN selects and uses only carriers specialized in furniture transportation. Customer requested carriers can be authorized using Freight Excluded pricing with invoice add-on.

## SPECIFIC DELIVERY TIMES

DARRAN will assist in coordinating a requested delivery time from a carrier. DARRAN makes no guarantees and accepts no responsibility for such services as DARRAN has no control over possible carrier hazards. To ensure specific time arrival, we recommend arranging single stop, designated load carriers. Less than trailer load (LTL) shipments cannot be coordinated for a guaranteed delivery time.

## EXPRESS CARRIERS

When requested DARRAN will assist in locating special express carriers that may have short transit times. These services exceed our prepaid freight cost, therefore, pricing is limited to the Freight Excluded formula with special express charges added to invoice.

## FEATURES & ADVANTAGES

### VENEER AND HPL TOPS

Wood veneer tops and high-pressure laminate tops feature a M2 Grade, CARB2 MDF Core with balanced 3-ply construction. Tops are 1-5/16" thick on all veneer and HPL products except for the Rift Collection, which features 1-1/2" thick primary work surfaces. Tops are connected to chassis with steel angle brackets, wood cleats and dowels. DARRAN only uses HPVA A Grade Flat Cut Cherry, Maple, and Walnut Veneers that are book-matched and slip-matched. Rift-Cut White Oak and Quarter-Cut Ash are available as premium veneers. DARRAN's Rift Collection features a double-cut veneer in a rift-cut pattern for a clean linear aesthetic. Veneer tops feature shapeable MDF edges, 3/4", 1", or 3mm external solid hardwood bands based on collection and edge selection. HPL tops feature a laminate self edge, shapeable MDF edge, or a 3mm solid wood edge based on edge selection.

### TFL TOPS

Thermally Fused Laminate tops feature M2 Grade, CARB2 MDF Core with 3-ply balanced construction. Tops are 1-1/8" thick and feature a 2mm flat PVC edge band providing high impact durability. Tops are connected to chassis with steel angle brackets and dowels.

### CHASSIS & PEDESTAL CONSTRUCTION

All pedestals and chassis are constructed with 3/4" thick balanced 3-ply panels. Panels are securely fastened together using rails that are bored and doweled, glued, metal reinforcement brackets and wood cleat construction. Thick end panels are pre-bored to accept a tee nut for the adjustable glide and are reinforced with pvc banding to prevent glide tear out. Glue blocks are used where 3/4" thick panels are joined, bored for tee nut to accept adjustable glide.

### OVERHEAD CABINET CONSTRUCTION

(FREESTANDING AND WALL MOUNT)

Freestanding Overhead storage cabinets are constructed of 1" and 3/4" thick balanced 3-ply panels. Panels are attached with cam fasteners in conjunction with dowels securely adhered with PVAc (white polyvinyl acetate) glue. All surface mount cabinets connect to work surface with anti-slip tape. Wall mount cabinets are mounted to the wall with steel "z" bracket attachment method using 5mm euro screws to attach to the back of the cabinet. All units ship with a steel "z" bracket. This bracket is mounted to the wall by field installers. Installers are responsible for selecting and supplying appropriate fasteners for wall conditions.

### BOOKCASE CONSTRUCTION

All chassis (sides, back, top and bottom panels) are constructed with 3/4" thick balanced 3-ply panels. Panels are attached with cam fasteners in conjunction with dowels securely adhered with PVAc (white polyvinyl acetate) glue. Shelves on all units are 3/4" thick balance 3 ply panels. Optional heavy duty shelves are 1" thick lumber core balanced 5 ply construction.

### TACKBOARDS

Wall mount tackboards are constructed of .75" thick fiberboard.

The fabric is precisely aligned and fitted to the tackboard with a sock on cover.

Overhead storage tackboards are constructed of .5" thick fiberboard. The fabric is precisely aligned and fitted to the tackboard and adhered to the rigid hardboard with staples.

### ADJUSTABLE GLIDES

Glides provide 1" of vertical leveling adjustment. Glide bottom is durable metal.

### DRAWERS

All drawers are constructed of four sides and a bottom, which are attached to a drawer front with screws for easy removal. Drawer fronts feature vertically matched veneer within each pedestal. Pencil trays are standard in all box drawers. Jamestown, Prado, Rift, and Spaces feature maple veneer 1/2" thick material for drawer sides, fronts and backs with a UV finish for maximum durability. Drawer bottoms are 7/32" thick 3-ply maple veneer. Drawer boxes are assemble at each corner with dowel joinery for maximum drawer strength. Capitol Park, Central Park, NSsq, Reception Park, and Richmond Park feature drawers that are 1/2" thick wood grained wrapped 5 sided miter-folded construction with 1/8" thick hardboard bottoms.

### SUSPENSIONS

All casegoods utilize cold rolled steel zinc plated high-grade drawer suspensions. All suspensions are warranted for the lifetime of the product. Box and File drawers are full extension, featuring steel ball bearings for a smoother quieter range of motion with soft close operation and are rated 100lbs. Lateral file drawers are a progressive action full extension suspension with the soft close operation and is rated at 150lbs. Lateral files include anti tip mechanism that will allow only one drawer at a time to be opened.

### HINGES

Units with doors include 95 degree swing hinges.

### FILING

Capitol Park, Central Park, NSsq, Reception Park, and Richmond Park feature a highly durable black plastic extrusion that is securely fastened into a route on top of the drawer.

Desk drawers are provided with a cross bar that allows for adjustability for letter or legal filing side to side, letter width filing front to back without the use of a cross bar. Credenza and Return filing is letter width front to back and legal width side to side without the use of a cross bar, letter width side to side with the use of a cross bar. Lateral files feature legal with filing side to side and two rows of letter width front to back with the use of cross bars.

Jamestown, Prado, Rift, and Spaces feature metal file frames around the perimeter of the drawers with cross bars. Desk drawers are provided with a cross bar that allows for adjustability for letter or legal filing side to side, letter width filing front to back without the use of a cross bar. . Legal width drawers are specified on desks 72" and larger, and filing is legal front to back or two rows letter side to side. Credenza and Return filing is letter width front to back and legal width side to side without the use of a cross bar, letter width side to side with the use of a cross bar. Lateral files feature legal with filing

side to side and two rows of letter width front to back with the use of cross bars.

**LOCKS**

Silver, black or bronze face locks are standard on all desks, credenzas, returns, and modular pedestals and match the color of the pull selection. Locks are optional on door storage, overhead storage, towers with doors and all door units. Each drawer pedestal is independently locked. Lock plugs are factory or field installed.

**KEYING**

Keying is available either factory or field installed. Factory installed keying is random.

**WIRE MANAGEMENT**

Wire management capabilities include standard and optional worksurface grommets. When grommets are standard or specified in a unit, wire channels under the surface are provided for organization and management of all communication wires and cords.

**GROMMETS**

Metal grommets are provided to match the drawer pull selection. Grommet is available in black, silver, white or antique brass. Must specify standard or non-standard location. Black plastic grommets are available as an option for vertical applications.

**POWERPORTS**

A large selection of powerports are available and handle power, data, docking stations and communication. See options section for selection.

**LED TASKLIGHTS**

LED task lighting provides high efficiency, low energy lighting with long life. LED lights are encased in a silver aluminum alloy material with built in switch to turn the light on/off. Lights are factory installed.

*Product specifications listed below:*

- Diffuser creates a softer light and eliminates hot spots.
- Built in switch with dimmer control.
- 30w 12Vdc 120V (UL approved) power supply
- Can be "daisy chained" up to 30W
- 50,000 hour life

SIZE	VOLTAGE	WATTAGE	COLOR TEMP.	CRI
24" light	12Vdc	6.4	5000K	90
48" light	12Vdc	12.8	5000K	90
60" light	12Vdc	16	5000K	90

**FINISHES**

<b>"W" VENEER</b> <small>Veneer</small>	<b>"G" LAMINATE HPL TOPS</b> <small>HPL</small>	<b>"M" THERMALLY FUSED LAMINATE</b> <small>TFL</small>
WAC Amber Cherry .....	GAC Amber Cherry .....	N/A
WRC Caramel Cherry.....	N/A	
WIC Crimson Cherry .....	GIC Crimson Cherry	
WEC Ebony Cherry .....	N/A	
WHC Honey Cherry.....	GHC Honey Cherry	
WOC Koko Cherry.....	GOC Koko Cherry	
WSC Scotch Cherry .....	N/A	
WEW Executive Walnut.....	GEW Executive Walnut	
WRW Gray Luster Walnut .....	GRW Gray Luster Walnut	
WGW Gunstock Walnut.....	N/A	
WJW Judicial Walnut.....	N/A	
WNW Natural Walnut.....	GNW Natural Walnut	
WTW Studio Teak Walnut.....	GTW Studio Teak Walnut	

Send 3x3 or larger finish chip for color match. Custom finish upcharge is 3% or \$250 Net (whichever is greater).

**FINISH**

ENVI-CT Green Certified European Technology Coatings Finish with Anti-microbial protection.

**VENEER AND HPL TOPS**

Wood veneer tops and high-pressure laminate tops feature a M2 Grade, CARB2 MDF Core with balanced 3-ply construction. Tops are 1-5/16" thick on all veneer and HPL products except for the Rift Collection, which features 1-1/2" thick primary worksurfaces. Tops are connected to chassis with steel angle brackets, wood cleats and dowels. DARRAN only uses HPVA A Grade Flat Cut Cherry, Maple, and Walnut Veneers that are book-matched and slip-matched. Rift-Cut White Oak and Quarter-Cut Ash are available as premium veneers. DARRAN's Rift Collection features a double-cut veneer in a rift-cut pattern for a clean linear aesthetic. Veneer tops feature shapeable MDF edges, 3/4", 1", or 3mm external solid hardwood bands based on collection and edge selection. HPL tops feature a laminate self edge, shapeable MDF edge, or a 3mm solid wood edge based on edge selection.

**TFL TOPS**

Thermally Fused Laminate tops feature M2 Grade, CARB2 MDF Core with 3-ply balanced construction. Tops are 1-1/8" thick and feature a 2mm flat PVC edge band providing high impact durability. Tops are connected to chassis with steel angle brackets and dowels.

**CHASSIS**

3/4" thick core, Medium Density Fiberboard (MDF) rated EPP/SCS/CARB-II material with 3 ply balanced construction. Pedestal and cabinets feature dowel construction reinforced with steel bracket plates, wood cleats, screws and glue. Exposed interiors feature finished veneer of same species as exterior faces. Panel molding standard on approach and end panels of all worksurface height units.

NOTE: All units are standard with 1" adjustable glides that allow for leveling of units.

**DRAWER FRONTS**

Drawer fronts are vertically matched in balanced sets. Doors feature vertical veneer bookmatched horizontally in sets of 2 / 4 and 6 doors. All drawers and doors have traditional scallop profile edge shape. All tower fronts matched in vertical sets.

**DRAWERS**

Drawers feature mitre joint / dowel construction with a natural maple finish. All drawers extend 100% for full access on steel ball bearing slides with cushion in-out stops. Drawers have been tested and passed BIFMA 50,000 cycle test. File drawers feature 1/4" bottoms reinforced for heavy weight capacity. All drawers are guaranteed lifetime with free replacement warranty.

**OPTIONAL WOOD DRAWERS**

Optional hardwood veneer plywood drawers feature banded top and bottom edges for smoothness. Drawers are dowel joint construction with a UV cured finish over maple veneers, plus a lifetime free replacement guarantee.

Optional Wood Drawer (Any Size) – Option Code P33...\$40 List Price Per Drawer

**RANDOM LOCKS & KEYING (STANDARD)**

Locks are standard on all storage units below the worksurface. Random lock cores are installed at the factory. Some units may be shipped with the same key number. Locks are Silver, Black or Bronze and match pull finish unless specified.

- SRK: Random Silver Random Key - n/c
- BRK: Random Black Random Key - n/c
- ZRK: Random Bronze Random Key - n/c

**FIELD INSTALLED LOCKS & KEYING (OPTION)**

A separate line item must be ordered to receive the numbered lock cores for field installation. Field installed locks are available at no additional charge. Specify Silver or Black Locks.

- SFK: Field Installed Silver Random Key - n/c
- BFK: Field Installed Black Random Key - n/c
- ZFK: Field Installed Bronze Random Key - n/c

**STANDARD PROFILE**

Richmond Park Edge  
Hardwood Rim Band Species Same As Surface Veneer

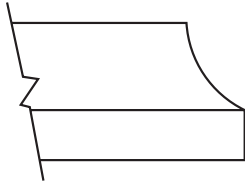

**OPTIONAL PROFILE**

Classic Edge - No additional upcharge  
Hardwood Rim Band Species Same As Surface Veneer

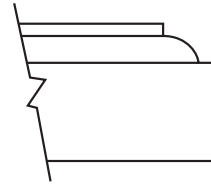

3mm solid  
hardwood band

**CORNICE TOP PROFILE**

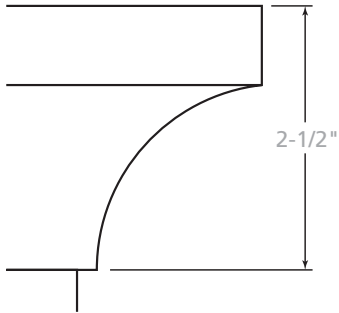

**BASE PROFILE**



**DRAWER/DOOR  
EDGE PROFILE**



**HOOKUP EDGE PROFILE**

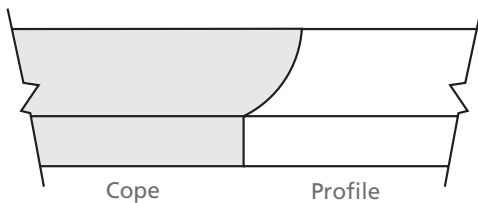

**PULLS/KNOBS**

Factory Installed

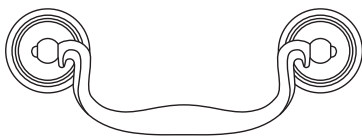

PL-5 Antique Brass  
PL-50 Brushed Pewter



PL-4 Antique Brass



DK-114  
Brushed Pewter

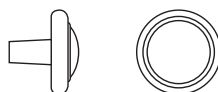

DK-4  
Antique Brass

**OPTIONAL GROMMETS**

Factory Installed

Grommets (Standard Location)

Specify Color and Left/Right/Center - \$45 ea.

- Black: TM30-R (Right), TM30-L (Left), TM30-C (Center)
- Silver: TM31-R (Right), TM31-L (Left), TM31-C (Center)
- Antique Brass: TM33-R (Right), TM33-L (Left), TM33-C (Center)

Grommets (Non-Standard Location)

Provide drawing w/ Grommet Location and Specify Color - \$90 ea.

- Black: TM30-NS
- Silver: TM31-NS
- Antique Brass: TM33-NS

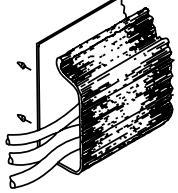

Horizontal J-Channel wire management (Sku: W-1) is sold separately to conceal wire under worksurfaces.

W1



TM30  
Black  
1-5/8" Dia.



TM31  
Silver  
1-5/8" Dia.



TM33  
Antique Brass  
1-5/8" Dia.



TM50  
Black  
1-5/8" Dia.

**GROMMETS (VERTICAL SURFACE)**

Standard Location - \$45 ea.

- Black Plastic Vertical Surface: TM50-C (Bottom Center)

Non-Standard Location - \$90 ea.

- Black Plastic Vertical Surface: TM50-NS

**STANDARD GROMMET LOCATION REFERENCE**

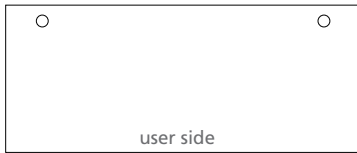

Desk  
Specify Right or Left Grommet



6" Overhang Desk  
Specify Right or Left Grommet

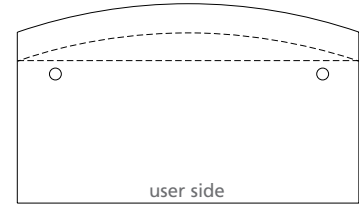

6 1/2" Bow Front Desk  
Specify Right or Left Grommet



Bullet Conference Desk (Right Post)  
Center Grommet

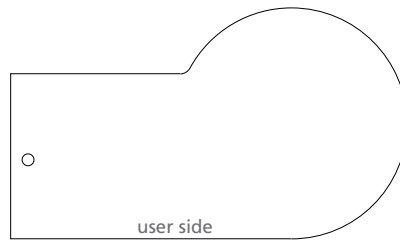

P Conference Desk (Right Post)  
Center Grommet

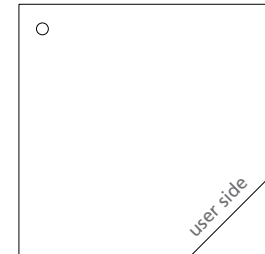

Corner  
Center Grommet



Bridge  
Center Grommet



Return (Left Pedestal Shown)  
Right Pedestal - Left Grommet  
Left Pedestal - Right Grommet



Workstation Credenza  
Center Kneespace Grommet



**GANGING – FLUSH CUT MODIFICATION**

30”H Casework Worksurface & Base Ganging Modifications

To gang two casework units, each unit end to be ganged must be flush cut modified for gapless surfaces and cabinet chassis.

Order Option:

- FC-B: Flush Unit Both Sides(Facing) for Ganging - \$95
- FC-L: Flush Unit Left (Facing) for Ganging - \$95
- FC-R: Flush Unit Right (Facing) for Ganging - \$95

Flush cut modification per unit includes all modifications to gang to one end or both ends when units are ganged. Modification includes tops, base and molding. Modification reduces width size approximately 1” per end.

Overhead consoles and towers are offered freestanding and ganging – inclusive of flush cut modifications.

Example:

RPC3121100W Two Drawer Lateral File (Left) Flush Cut Right – FC-R...\$95

RPC7221054 Kneespace Credenza (Right) Flush Cut Left – FC-L...\$95

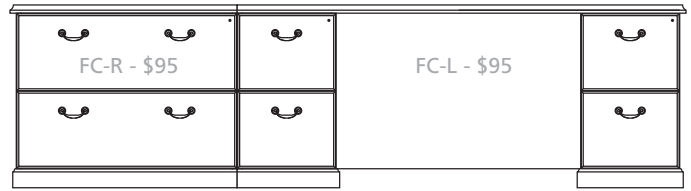

**HEIGHT REFERENCE**

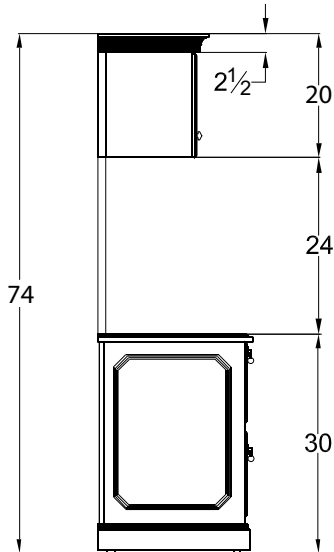

Typical Single Height Side Profile Wall Hung Overhead

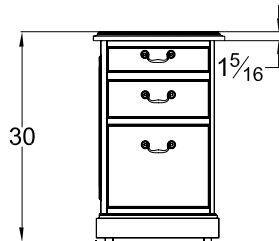

Pedestal Front Profile Box/Box/File

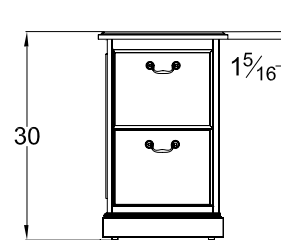

Pedestal Front Profile File/File

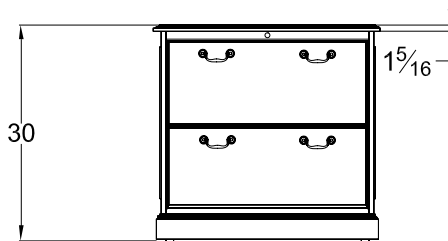

Pedestal Front Profile Lateral File

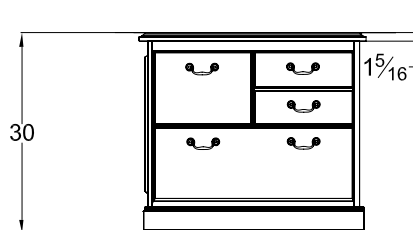

Pedestal Front Profile Multi-File

MODESTY REFERENCE

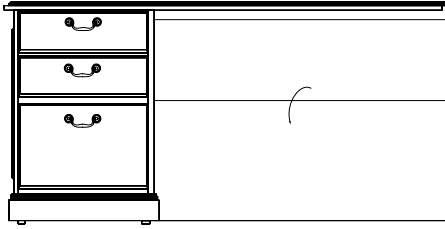

Top View

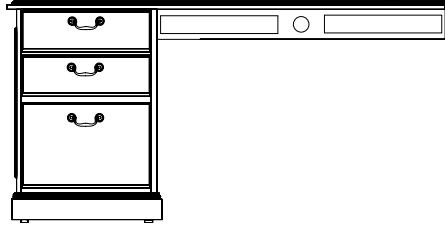

M51

Open Back Modesty with 4" Wire Management Rail

M34

Drop Door Tech Modesty

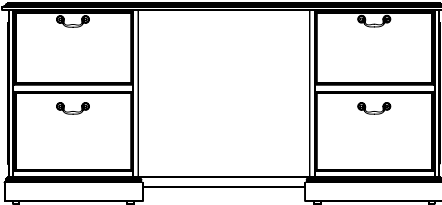

M37

Fixed Full Modesty

GRAIN DIRECTION



Desk

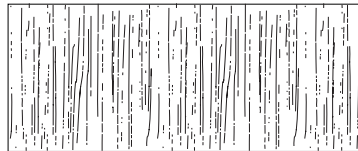

Runoff Desk

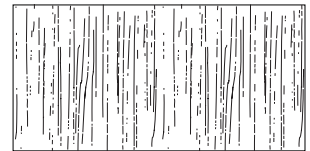

Bridge



Credenza

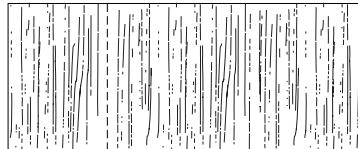

Return

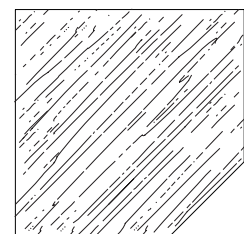

Corner

**INTERIOR DRAWER DIMENSIONS**

UNIT DEPTH	DRAWER TYPE	OVERALL DIMENSIONS			INTERIOR DRAWER DIMENSIONS			NOTES
		W	D	H	W	D	H	
15-5/8" Letter	36" Box	13-1/8	19-11/16	4	12-1/8	18-11/16	3-7/16	Units less than 72"
	36" File	13-1/8	19-11/16	9-13/16	12-1/8	18-11/16	9-5/16	Units less than 72"
	30" Box	13-1/8	19-11/16	4	12-1/8	18-11/16	3-7/16	Units less than 72"
	30" File	13-1/8	19-11/16	9-13/16	12-1/8	18-11/16	9-5/16	Units less than 72"
	24" Box	13-1/8	16-1/16	4	12-1/8	15-1/16	3-7/16	Units less than 72"
	24" File	13-1/8	16-1/16	9-13/16	12-1/8	15-1/16	9-5/16	Units less than 72"
29" Lateral	24" Box	26-1/2	16-1/16	4	25-1/2	15-1/16	3-7/16	Workstation Credenzas less than 82"
	24" File	26-1/2	16-1/16	9-13/16	25-1/2	15-1/16	9-5/16	Workstation Credenzas less than 82"
35" Lateral	24" Box	32-1/2	16-1/16	4	31-1/2	15-1/16	3-7/16	Workstation Credenzas over 83"
	24" File	32-1/2	16-1/16	9-13/16	31-1/2	15-1/16	9-5/16	Workstation Credenzas over 83"
41" Lateral	24" File	38-1/2	16-1/16	9-13/16	37-1/2	15-1/16	9-5/16	Wood Drawer Only

**FILING REFERENCE**

**FILING FOR 24" DEPTH UNITS**

13 1/8" Wide File Drawer - 16 1/16" Deep

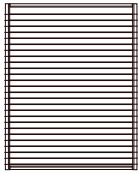

Letter Front to Back

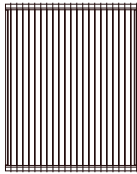

Legal Side to Side with File Rail

**FILING FOR 30" & 36" DEPTH UNITS**

13 1/8" Wide File Drawer - 19 11/16" Deep

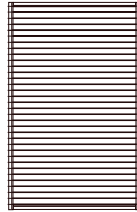

Letter Front to Back

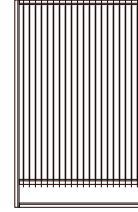

Legal Side to Side with File Rail

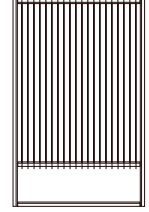

Letter Side to Side with File Rail

**29" LATERAL FILE DRAWER**

26-1/2" Wide File Drawer - 16-1/16" Deep

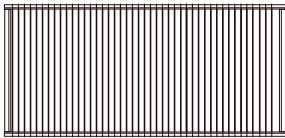

Legal Side to Side

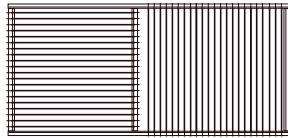

Legal Side to Side Letter Front to Back with File Rail

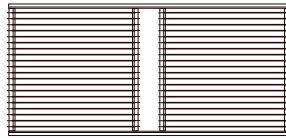

Letter Front to Back with File Rail

**35" LATERAL FILE DRAWER**

32-1/2" Wide File Drawer - 16-1/16" Deep

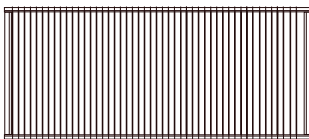

Legal Side to Side

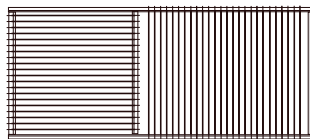

Legal Side to Side Letter Front to Back with File Rail

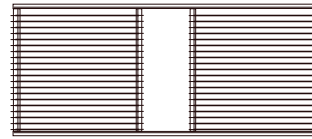

Letter Front to Back with File Rail

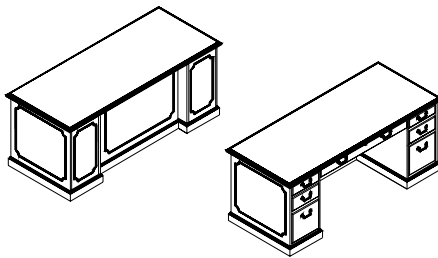

**EXECUTIVE CHASSIS BREAKFRONT**

**STANDARD FEATURES**

- Box/Box/File
- Full extension drawers - locking
- Drawer fronts w/ profile edges
- Full modesty w/ base
- Pull out writing shelf
- Soft close suspension drawer(s)

[CLICK HERE TO VIEW PRODUCT INDEX](#)

**1 SELECT A STYLE**

DIMENSIONS		STYLE NUMBER	LIST PRICE	STYLE NUMBER	LIST PRICE	STYLE NUMBER	LIST PRICE
W" x D" x H"	WGT	"W" Veneer Top Veneer Chassis		"G" High Pressure Laminate Top HPL Veneer Chassis		"M" Thermally Fused Laminate Top Thermally Fused Laminate Chassis	
84 x 36 x 30	350	RPC8436DD000W	3949	RPC8436DD000G	3949	"M" Option N/A	
72 x 36 x 30	335	RPC7236DD000W	3557	RPC7236DD000G	3557	"M" Option N/A	
72 x 30 x 30	320	RPC7230DD000W	3488	RPC7230DD000G	3488	"M" Option N/A	
66 x 36 x 30	315	RPC6636DD000W	3488	RPC6636DD000G	3488	"M" Option N/A	
66 x 30 x 30	275	RPC6630DD000W	3402	RPC6630DD000G	3402	"M" Option N/A	
60 x 30 x 30	230	RPC6030DD000W	3153	RPC6030DD000G	3153	"M" Option N/A	

**2 SELECT A FINISH**

"W" Veneer	"G" HPL	"M" TFL	
WAC	GAC	-	Amber Cherry
WRC	-	-	Caramel Cherry
WIC	GIC	-	Crimson Cherry
WEC	-	-	Ebony Cherry
WHC	GHC	-	Honey Cherry
WOC	GOC	-	KoKo Cherry
WSC	-	-	Scotch Cherry
WEW	GEW	-	Executive Walnut
WRW	GRW	-	Gray Luster Walnut
WGW	-	-	Gunstock Walnut
WJW	-	-	Judicial Walnut
WNW	GNW	-	Natural Walnut
WTW	GTW	-	Studio Teak Walnut

**3 SELECT AN EDGE**



**5 OPTIONS**

- ACCESSORIES**
- K28: Articulating Keyboard w/ Mouse (removes center drawer) - \$375
- DRAWER**
- P6: Modify Box/Box/File to File/File - \$50 per pedestal
  - P33: Wood Drawer Upgrade - \$40 per drawer
- GROMMETS (STANDARD LOCATION)**
- Specify Color and Location Right/Left - \$45 ea.
- Black: TM30-R (Right), TM30-L (Left)
  - Silver: TM31-R (Right), TM31-L (Left)
  - Antique Brass: TM33-R (Right), TM33-L (Left)
- GROMMETS (NON-STANDARD LOCATION)**
- Provide drawing w/ Grommet Location and Specify Color - \$90 ea.
- Black: TM30-NS
  - Silver: TM31-NS
  - Antique Brass: TM33-NS
- MOLDING**
- DSM1: Delete Molding - Deduct \$95

**4 SELECT HARDWARE**



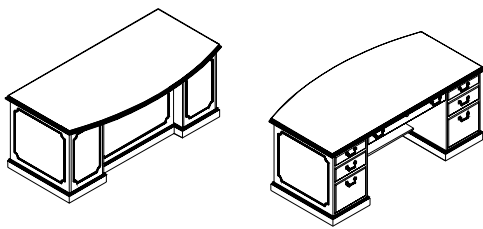

**BOWFRONT / BREAKFRONT EXECUTIVE CHASSIS**

**STANDARD FEATURES**

- Box/Box/File
- Decorative molding
- Drawer fronts w/ profile edges
- Full extension drawers - locking
- Full fixed modesty w/ base
- Pull out writing shelf
- Soft close suspension drawer(s)

**NOTES**

- 6" overhang on approach

[CLICK HERE TO VIEW PRODUCT INDEX](#)

**1 SELECT A STYLE**

DIMENSIONS		STYLE NUMBER	LIST PRICE	STYLE NUMBER	LIST PRICE	STYLE NUMBER	LIST PRICE
W" x D" x H"	WGT	"W" Veneer Top Veneer Chassis		"G" High Pressure Laminate Top Veneer Chassis		"M" Thermally Fused Laminate Top Thermally Fused Laminate Chassis	
84 x 36/42 x 30	370	RPC8442DD006W	4334	RPC8442DD006G	4334	"M" Option N/A	
72 x 36/42 x 30	350	RPC7242DD006W	3943	RPC7242DD006G	3943	"M" Option N/A	
72 x 30/36 x 30	340	RPC7236DD006W	3794	RPC7236DD006G	3794	"M" Option N/A	
66 x 30/36 x 30	325	RPC6636DD006W	3725	RPC6636DD006G	3725	"M" Option N/A	

**2 SELECT A FINISH**

"W" Veneer	"G" HPL	"M" TFL	
WAC	GAC	-	Amber Cherry
WRC	-	-	Caramel Cherry
WIC	GIC	-	Crimson Cherry
WEC	-	-	Ebony Cherry
WHC	GHC	-	Honey Cherry
WOC	GOC	-	KoKo Cherry
WSC	-	-	Scotch Cherry
WEW	GEW	-	Executive Walnut
WRW	GRW	-	Gray Luster Walnut
WGW	-	-	Gunstock Walnut
WJW	-	-	Judicial Walnut
WNW	GNW	-	Natural Walnut
WTW	GTW	-	Studio Teak Walnut

**3 SELECT AN EDGE**



**5 OPTIONS**

**ACCESSORIES**  
- K28: Articulating Keyboard w/ Mouse (removes center drawer) - \$375

**DRAWER**  
- P6: Modify Box/Box/File to File/File - \$50 per pedestal  
- P33: Wood Drawer Upgrade - \$40 per drawer

**GROMMETS (STANDARD LOCATION)**  
Specify Color and Location Right/Left - \$45 ea.  
- Black: TM30-R (Right), TM30-L (Left)  
- Silver: TM31-R (Right), TM31-L (Left)  
- Antique Brass: TM33-R (Right), TM33-L (Left)

**GROMMETS (NON-STANDARD LOCATION)**  
Provide drawing w/ Grommet Location and Specify Color - \$90 ea.  
- Black: TM30-NS  
- Silver: TM31-NS  
- Antique Brass: TM33-NS

**MOLDING**  
- DSM1: Delete Molding - Deduct \$95

**4 SELECT HARDWARE**



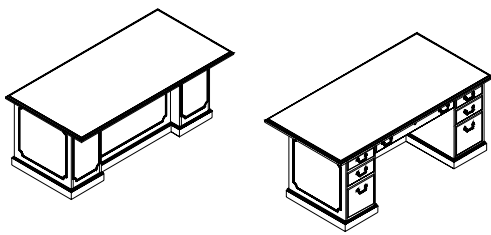

**CONFERENCE OVERHANG BREAKFRONT CHASSIS**

**STANDARD FEATURES**

- Box/Box/File
- Decorative molding
- Drawer fronts w/ profile edges
- Full extension drawers - locking
- Full fixed modesty w/ base
- Pull out writing shelf
- Soft close suspension drawer(s)

**NOTES**

- 6" overhang on approach

[CLICK HERE TO VIEW PRODUCT INDEX](#)

**1 SELECT A STYLE**

DIMENSIONS		STYLE NUMBER	LIST PRICE	STYLE NUMBER	LIST PRICE	STYLE NUMBER	LIST PRICE
W" x D" x H"	WGT	"W" Veneer Top Veneer Chassis		"G" HPL High Pressure Laminate Top Veneer Chassis		"M" TFL Thermally Fused Laminate Top Thermally Fused Laminate Chassis	
<b>72 x 30 Chassis</b>							
84 x 36 x 30	330	RPC8436DD037W	3750	RPC8436DD037G	3750	"M" Option N/A	
<b>66 x 30 Chassis</b>							
72 x 36 x 30	300	RPC7236DD037W	3283	RPC7236DD037G	3283	"M" Option N/A	
<b>60 x 30 Chassis</b>							
66 x 36 x 30	275	RPC6636DD037W	3203	RPC6636DD037G	3203	"M" Option N/A	
<b>60 x 24 Chassis</b>							
66 x 30 x 30	250	RPC6630DD037W	2824	RPC6630DD037G	2824	"M" Option N/A	

**2 SELECT A FINISH**

"W" Veneer	"G" HPL	"M" TFL	
WAC	GAC	-	Amber Cherry
WRC	-	-	Caramel Cherry
WIC	GIC	-	Crimson Cherry
WEC	-	-	Ebony Cherry
WHC	GHC	-	Honey Cherry
WOC	GOC	-	KoKo Cherry
WSC	-	-	Scotch Cherry
WEW	GEW	-	Executive Walnut
WRW	GRW	-	Gray Luster Walnut
WGW	-	-	Gunstock Walnut
WJW	-	-	Judicial Walnut
WNW	GNW	-	Natural Walnut
WTW	GTW	-	Studio Teak Walnut

**3 SELECT AN EDGE**



**5 OPTIONS**

- ACCESSORIES**
- K28: Articulating Keyboard w/ Mouse (removes center drawer) - \$375
- DRAWER**
- P6: Modify Box/Box/File to File/File - \$50 per pedestal
  - P33: Wood Drawer Upgrade - \$40 per drawer
- GROMMETS (STANDARD LOCATION)**
- Specify Color and Location Right/Left - \$45 ea.
- Black: TM30-R (Right), TM30-L (Left)
  - Silver: TM31-R (Right), TM31-L (Left)
  - Antique Brass: TM33-R (Right), TM33-L (Left)
- GROMMETS (NON-STANDARD LOCATION)**
- Provide drawing w/ Grommet Location and Specify Color - \$90 ea.
- Black: TM30-NS
  - Silver: TM31-NS
  - Antique Brass: TM33-NS
- MOLDING**
- DSM1: Delete Molding - Deduct \$95

**4 SELECT HARDWARE**



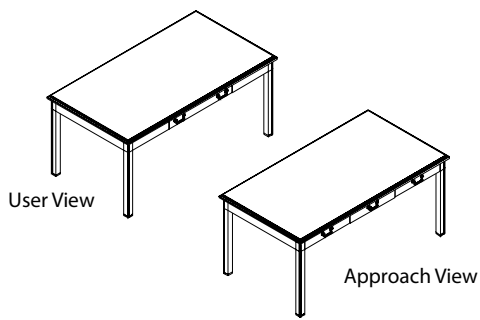

**TABLE DESK**

**STANDARD FEATURES**

- Approach side has 3 section appearance w/ pulls
- Full extension drawers - Full extension drawers
- locking
- Hardwood post legs w/ corner applique
- Metal ferrule toe - finish matches pull

[CLICK HERE TO VIEW PRODUCT INDEX](#)

**1 SELECT A STYLE**

DIMENSIONS		STYLE NUMBER	LIST PRICE	STYLE NUMBER	LIST PRICE	STYLE NUMBER	LIST PRICE
W" x D" x H"	WGT	"W" Veneer Top Veneer Chassis		"G" High Pressure Laminate Top Veneer Chassis		"M" Thermally Fused Laminate Top Thermally Fused Laminate Chassis	
72 x 36 x 30	150	RPC7236DT107W	2226	RPC7236DT107G	2226	"M" Option N/A	
66 x 36 x 30	140	RPC6636DT107W	2164	RPC6636DT107G	2164	"M" Option N/A	
66 x 30 x 30	130	RPC6630DT107W	2090	RPC6630DT107G	2090	"M" Option N/A	
60 x 30 x 30	120	RPC6030DT107W	1971	RPC6030DT107G	1971	"M" Option N/A	

**2 SELECT A FINISH**

"W" Veneer	"G" HPL	"M" TFL	
WAC	GAC	-	Amber Cherry
WRC	-	-	Caramel Cherry
WIC	GIC	-	Crimson Cherry
WEC	-	-	Ebony Cherry
WHC	GHC	-	Honey Cherry
WOC	GOC	-	KoKo Cherry
WSC	-	-	Scotch Cherry
WEW	GEW	-	Executive Walnut
WRW	GRW	-	Gray Luster Walnut
WGW	-	-	Gunstock Walnut
WJW	-	-	Judicial Walnut
WNW	GNW	-	Natural Walnut
WTW	GTW	-	Studio Teak Walnut

**3 SELECT AN EDGE**



**5 OPTIONS**

- DRAWER**
- P33: Wood Drawer Upgrade - \$40 per drawer
- GROMMETS (STANDARD LOCATION)**
- Specify Color and Location Right/Left - \$45 ea.
- Black: TM30-R (Right), TM30-L (Left)
  - Silver: TM31-R (Right), TM31-L (Left)
  - Antique Brass: TM33-R (Right), TM33-L (Left)
- GROMMETS (NON-STANDARD LOCATION)**
- Provide drawing w/ Grommet Location and Specify Color - \$90 ea.
- Black: TM30-NS
  - Silver: TM31-NS
  - Antique Brass: TM33-NS

**4 SELECT HARDWARE**



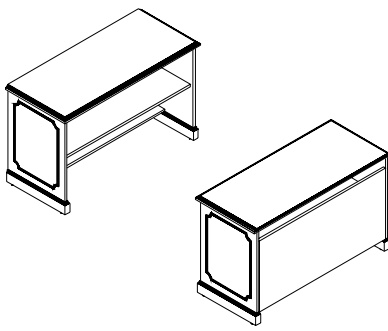

**CRT DESK / PRINTER**

**STANDARD FEATURES**

- 6" Storage foot shelf
- Adjustable shelf
- End panel molding
- Wire/Paper access back

[CLICK HERE TO VIEW PRODUCT INDEX](#)

**1 SELECT A STYLE**

DIMENSIONS		STYLE NUMBER	LIST PRICE	STYLE NUMBER	LIST PRICE	STYLE NUMBER	LIST PRICE
W" x D" x H"	WGT	"W" Veneer Veneer Top Veneer Chassis		"G" HPL High Pressure Laminate Top Veneer Chassis		"M" TFL Thermally Fused Laminate Top Thermally Fused Laminate Chassis	
48 x 24 x 30	130	RPC4824AU225W	1810	RPC4824AU225G	1810	"M" Option N/A	
42 x 24 x 30	120	RPC4224AU225W	1747	RPC4224AU225G	1747	"M" Option N/A	
36 x 24 x 30	110	RPC3624AU225W	1704	RPC3624AU225G	1704	"M" Option N/A	

**2 SELECT A FINISH**

"W" Veneer	"G" HPL	"M" TFL	
WAC	GAC	-	Amber Cherry
WRC	-	-	Caramel Cherry
WIC	GIC	-	Crimson Cherry
WEC	-	-	Ebony Cherry
WHC	GHC	-	Honey Cherry
WOC	GOC	-	KoKo Cherry
WSC	-	-	Scotch Cherry
WEW	GEW	-	Executive Walnut
WRW	GRW	-	Gray Luster Walnut
WGW	-	-	Gunstock Walnut
WJW	-	-	Judicial Walnut
WNW	GNW	-	Natural Walnut
WTW	GTW	-	Studio Teak Walnut

**3 SELECT AN EDGE**



**5 OPTIONS**

- GROMMETS (STANDARD LOCATION)**  
Specify Color - \$45 ea.  
- Black: TM30-C (Center)  
- Silver: TM31-C (Center)  
- Antique Brass: TM33-C (Center)
- GROMMETS (NON-STANDARD LOCATION)**  
Provide drawing w/ Grommet Location and Specify Color - \$90 ea.  
- Black: TM30-NS  
- Silver: TM31-NS  
- Antique Brass: TM33-NS
- GROMMETS (VERTICAL SURFACE)**  
Standard Location - \$45 ea.  
- Black Plastic Vertical Surface: TM50-C (Bottom Center)  
Non-Standard Location - \$90 ea.  
- Black Plastic Vertical Surface: TM50-NS
- MOLDING**  
- DSM2: Delete molding - Deduct \$50

**4 SELECT HARDWARE**

Hardware  
Option Not  
Available



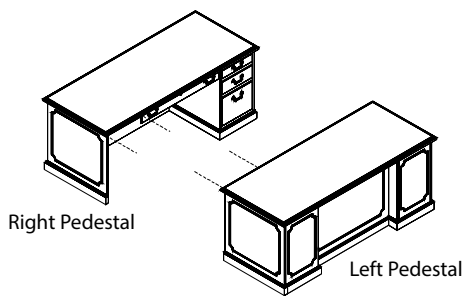

**EXECUTIVE BREAKFRONT CHASSIS SINGLE PEDESTAL DESK**

**STANDARD FEATURES**

- Box/Box/File
- Drawer fronts w/ profile edges
- Full extension drawers - Full extension drawers
- locking
- Full fixed modesty w/ base
- Hookup hardware
- Pull out writing shelf
- Soft close suspension drawer(s)

[CLICK HERE TO VIEW PRODUCT INDEX](#)

**1 SELECT A STYLE**

DIMENSIONS		STYLE NUMBER	LIST PRICE	STYLE NUMBER	LIST PRICE	STYLE NUMBER	LIST PRICE
W" x D" x H"	WGT	"W" Veneer Top Veneer Chassis		"G" HPL High Pressure Laminate Top Veneer Chassis		"M" TFL Thermally Fused Laminate Top Thermally Fused Laminate Chassis	
<b>Left Pedestal</b>							
84 x 36 x 30	330	RPC8436DS009W	3396	RPC8436DS009G	3396	"M" Option N/A	
72 x 36 x 30	290	RPC7236DS009W	3066	RPC7236DS009G	3066	"M" Option N/A	
72 x 30 x 30	255	RPC7230DS009W	3035	RPC7230DS009G	3035	"M" Option N/A	
66 x 36 x 30	275	RPC6636DS009W	2991	RPC6636DS009G	2991	"M" Option N/A	
66 x 30 x 30	250	RPC6630DS009W	2911	RPC6630DS009G	2911	"M" Option N/A	
62 x 30 x 30	230	RPC6230DS009W	2891	RPC6230DS009G	2891	"M" Option N/A	
<b>Right Pedestal</b>							
84 x 36 x 30	330	RPC8436DS010W	3396	RPC8436DS010G	3396	"M" Option N/A	
72 x 36 x 30	290	RPC7236DS010W	3066	RPC7236DS010G	3066	"M" Option N/A	
72 x 30 x 30	255	RPC7230DS010W	3035	RPC7230DS010G	3035	"M" Option N/A	
66 x 36 x 30	275	RPC6636DS010W	2991	RPC6636DS010G	2991	"M" Option N/A	
66 x 30 x 30	250	RPC6630DS010W	2911	RPC6630DS010G	2911	"M" Option N/A	
62 x 30 x 30	230	RPC6230DS010W	2891	RPC6230DS010G	2891	"M" Option N/A	

**2 SELECT A FINISH**

"W" Veneer	"G" HPL	"M" TFL	
WAC	GAC	-	Amber Cherry
WRC	-	-	Caramel Cherry
WIC	GIC	-	Crimson Cherry
WEC	-	-	Ebony Cherry
WHC	GHC	-	Honey Cherry
WOC	GOC	-	KoKo Cherry
WSC	-	-	Scotch Cherry
WEW	GEW	-	Executive Walnut
WRW	GRW	-	Gray Luster Walnut
WGW	-	-	Gunstock Walnut
WJW	-	-	Judicial Walnut
WNW	GNW	-	Natural Walnut
WTW	GTW	-	Studio Teak Walnut

**3 SELECT AN EDGE**



**5 OPTIONS**

- DRAWER**
- P33: Wood Drawer Upgrade - \$40 per drawer
- GROMMETS (STANDARD LOCATION)**
- Specify Color and Location Right/Left - \$45 ea.
- Black: TM30-R (Right), TM30-L (Left)
  - Silver: TM31-R (Right), TM31-L (Left)
  - Antique Brass: TM33-R (Right), TM33-L (Left)
- GROMMETS (NON-STANDARD LOCATION)**
- Provide drawing w/ Grommet Location and Specify Color - \$90 ea.
- Black: TM30-NS
  - Silver: TM31-NS
  - Antique Brass: TM33-NS
- MOLDING**
- DSM1: Delete molding - Deduct \$95

**4 SELECT HARDWARE**



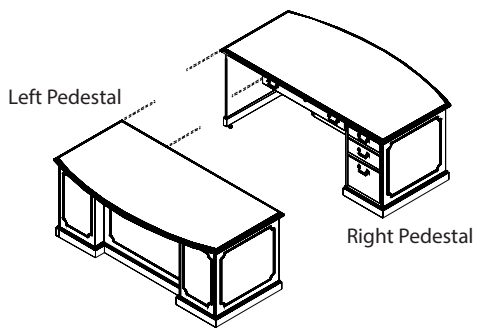

**BOWFRONT / BREAKFRONT EXECUTIVE CHASSIS SINGLE PEDESTAL DESK**

**STANDARD FEATURES**

- 6" Overhang on approach
- Box/Box/File
- Drawer fronts w/ profile edges
- Full extension drawers - Full extension drawers
  - locking
- Full fixed modesty w/ base
- Hookup hardware
- Pull out writing shelf
- Soft close suspension drawer(s)

[CLICK HERE TO VIEW PRODUCT INDEX](#)

**1 SELECT A STYLE**

DIMENSIONS		STYLE NUMBER	LIST PRICE	STYLE NUMBER	LIST PRICE	STYLE NUMBER	LIST PRICE
W" x D" x H"	WGT	"W" Veneer Top Veneer Chassis		"G" HPL High Pressure Laminate Top Veneer Chassis		"M" TFL Thermally Fused Laminate Top Thermally Fused Laminate Chassis	
<b>Left Pedestal</b>							
84 x 36/42 x 30	350	RPC8442DS017W	3613	RPC8442DS017G	3613	"M" Option N/A	
72 x 36/42 x 30	315	RPC7242DS017W	3396	RPC7242DS017G	3396	"M" Option N/A	
72 x 30/36 x 30	295	RPC7236DS017W	3352	RPC7236DS017G	3352	"M" Option N/A	
66 x 36/42 x 30	285	RPC6642DS017W	3321	RPC6642DS017G	3321	"M" Option N/A	
66 x 30/36 x 30	275	RPC6636DS017W	3228	RPC6636DS017G	3228	"M" Option N/A	
<b>Right Pedestal</b>							
84 x 36/42 x 30	350	RPC8442DS018W	3613	RPC8442DS018G	3613	"M" Option N/A	
72 x 36/42 x 30	315	RPC7242DS018W	3396	RPC7242DS018G	3396	"M" Option N/A	
72 x 30/36 x 30	295	RPC7236DS018W	3352	RPC7236DS018G	3352	"M" Option N/A	
66 x 36/42 x 30	285	RPC6642DS018W	3321	RPC6642DS018G	3321	"M" Option N/A	
66 x 30/36 x 30	275	RPC6636DS018W	3228	RPC6636DS018G	3228	"M" Option N/A	

**2 SELECT A FINISH**

"W" Veneer	"G" HPL	"M" TFL	
WAC	GAC	-	Amber Cherry
WRC	-	-	Caramel Cherry
WIC	GIC	-	Crimson Cherry
WEC	-	-	Ebony Cherry
WHC	GHC	-	Honey Cherry
WOC	GOC	-	KoKo Cherry
WSC	-	-	Scotch Cherry
WEW	GEW	-	Executive Walnut
WRW	GRW	-	Gray Luster Walnut
WGW	-	-	Gunstock Walnut
WJW	-	-	Judicial Walnut
WNW	GNW	-	Natural Walnut
WTW	GTW	-	Studio Teak Walnut

**3 SELECT AN EDGE**



**5 OPTIONS**

- DRAWER**
- K28: Articulating Keyboard w/ Mouse - \$375
  - P6: Modify Box/Box/File to File/File - \$50 per pedestal
  - P33: Wood Drawer Upgrade - \$40 per drawer
- GROMMETS (STANDARD LOCATION)**  
Specify Color and Location Right/Left - \$45 ea.
- Black: TM30-R (Right), TM30-L (Left)
  - Silver: TM31-R (Right), TM31-L (Left)
  - Antique Brass: TM33-R (Right), TM33-L (Left)
- GROMMETS (NON-STANDARD LOCATION)**  
Provide drawing w/ Grommet Location and Specify Color - \$90 ea.
- Black: TM30-NS
  - Silver: TM31-NS
  - Antique Brass: TM33-NS
- MOLDING**
- DSM1: Delete molding - Deduct \$95

**4 SELECT HARDWARE**



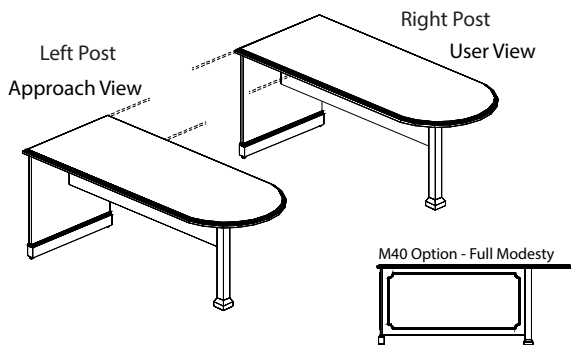

**BULLET CONFERENCE DESK**

**STANDARD FEATURES**

- 12" Modesty panel standard
- End panel w/ solid hardwood base
- Solid hardwood square post

**NOTES**

- "P" Tops and Bullets are not intended to be freestanding

[CLICK HERE TO VIEW PRODUCT INDEX](#)

**1 SELECT A STYLE**

DIMENSIONS		STYLE NUMBER	LIST PRICE	STYLE NUMBER	LIST PRICE	STYLE NUMBER	LIST PRICE
W" x D" x H"	WGT	"W" Veneer Veneer Top Veneer Chassis		"G" HPL High Pressure Laminate Top Veneer Chassis		"M" TFL Thermally Fused Laminate Top Thermally Fused Laminate Chassis	
<b>Left Post</b>							
72 x 36 x 30	160	RPC7236DC716W	2413	RPC7236DC716G	2413	"M" Option N/A	
72 x 30 x 30	150	RPC7230DC716W	2338	RPC7230DC716G	2338	"M" Option N/A	
66 x 36 x 30	155	RPC6636DC716W	2338	RPC6630DC716G	2338	"M" Option N/A	
66 x 30 x 30	140	RPC6630DC716W	2252	RPC6636DC716G	2252	"M" Option N/A	
60 x 30 x 30	125	RPC6030DC716W	2183	RPC6030DC716G	2183	"M" Option N/A	
<b>Right Post</b>							
72 x 36 x 30	160	RPC7236DC715W	2413	RPC7236DC715G	2413	"M" Option N/A	
72 x 30 x 30	150	RPC7230DC715W	2338	RPC7230DC715G	2338	"M" Option N/A	
66 x 36 x 30	155	RPC6636DC715W	2338	RPC6636DC715G	2338	"M" Option N/A	
66 x 30 x 30	140	RPC6630DC715W	2252	RPC6630DC715G	2252	"M" Option N/A	
60 x 30 x 30	125	RPC6030DC715W	2183	RPC6030DC715G	2183	"M" Option N/A	

**2 SELECT A FINISH**

"W" Veneer	"G" HPL	"M" TFL	
WAC	GAC	-	Amber Cherry
WRC	-	-	Caramel Cherry
WIC	GIC	-	Crimson Cherry
WEC	-	-	Ebony Cherry
WHC	GHC	-	Honey Cherry
WOC	GOC	-	KoKo Cherry
WSC	-	-	Scotch Cherry
WEW	GEW	-	Executive Walnut
WRW	GRW	-	Gray Luster Walnut
WGW	-	-	Gunstock Walnut
WJW	-	-	Judicial Walnut
WNW	GNW	-	Natural Walnut
WTW	GTW	-	Studio Teak Walnut

**3 SELECT AN EDGE**



**5 OPTIONS**

- ACCESSORIES**
- K28: Articulating Keyboard w/ Mouse - \$375
  - K30: Traditional Center Drawer - \$195
- GROMMETS (STANDARD LOCATION)**
- Specify Color - \$45 ea.
- Black: TM30-C (Center)
  - Silver: TM31-C (Center)
  - Antique Brass: TM33-C (Center)
- GROMMETS (NON-STANDARD LOCATION)**
- Provide drawing w/ Grommet Location and Specify Color - \$90 ea.
- Black: TM30-NS
  - Silver: TM31-NS
  - Antique Brass: TM33-NS
- MODESTY**
- M40: Fixed Full Modesty - \$195

**4 SELECT HARDWARE**

Hardware Option Not Available

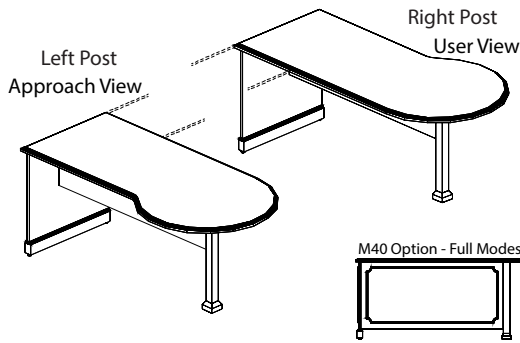

**"P" CONFERENCE DESK**

**STANDARD FEATURES**

- 12" Modesty panel
- End panel w/ solid hardwood base
- Solid hardwood square post

**NOTES**

- "P" Tops and Bullets are not intended to be freestanding

[CLICK HERE TO VIEW PRODUCT INDEX](#)

**1 SELECT A STYLE**

DIMENSIONS		STYLE NUMBER	LIST PRICE	STYLE NUMBER	LIST PRICE	STYLE NUMBER	LIST PRICE
W" x D" x H"	WGT	"W" Veneer Veneer Top Veneer Chassis		"G" HPL High Pressure Laminate Top Veneer Chassis		"M" TFL Thermally Fused Laminate Top Thermally Fused Laminate Chassis	
<b>Left Post</b>							
72 x 36/42 x 30	185	RPC7242DC028W	2575	RPC7242DC028G	2575	"M" Option N/A	
72 x 30/36 x 30	165	RPC7236DC028W	2513	RPC7236DC028G	2513	"M" Option N/A	
66 x 36/42 x 30	170	RPC6642DC028W	2513	RPC6642DC028G	2513	"M" Option N/A	
66 x 30/36 x 30	155	RPC6636DC028W	2338	RPC6636DC028G	2338	"M" Option N/A	
<b>Right Post</b>							
72 x 36/42 x 30	185	RPC7242DC027W	2575	RPC7242DC027G	2575	"M" Option N/A	
72 x 30/36 x 30	165	RPC7236DC027W	2513	RPC7236DC027G	2513	"M" Option N/A	
66 x 36/42 x 30	170	RPC6642DC027W	2513	RPC6642DC027G	2513	"M" Option N/A	
66 x 30/36 x 30	155	RPC6636DC027W	2338	RPC6636DC027G	2338	"M" Option N/A	

**2 SELECT A FINISH**

"W" Veneer	"G" HPL	"M" TFL	
WAC	GAC	-	Amber Cherry
WRC	-	-	Caramel Cherry
WIC	GIC	-	Crimson Cherry
WEC	-	-	Ebony Cherry
WHC	GHC	-	Honey Cherry
WOC	GOC	-	KoKo Cherry
WSC	-	-	Scotch Cherry
WEW	GEW	-	Executive Walnut
WRW	GRW	-	Gray Luster Walnut
WGW	-	-	Gunstock Walnut
WJW	-	-	Judicial Walnut
WNW	GNW	-	Natural Walnut
WTW	GTW	-	Studio Teak Walnut

**3 SELECT AN EDGE**



**5 OPTIONS**

**ACCESSORIES**

- K28: Articulating Keyboard w/ Mouse - \$375
- K30: Traditional Center Drawer - \$195

**GROMMETS (STANDARD LOCATION)**

- Specify Color - \$45 ea.
- Black: TM30-C (Center)
- Silver: TM31-C (Center)
- Antique Brass: TM33-C (Center)

**GROMMETS (NON-STANDARD LOCATION)**

- Provide drawing w/ Grommet Location and Specify Color - \$90 ea.
- Black: TM30-NS
- Silver: TM31-NS
- Antique Brass: TM33-NS

**MODESTY**

- M40: Fixed Full Modesty - \$195

**4 SELECT HARDWARE**

Hardware  
Option Not  
Available

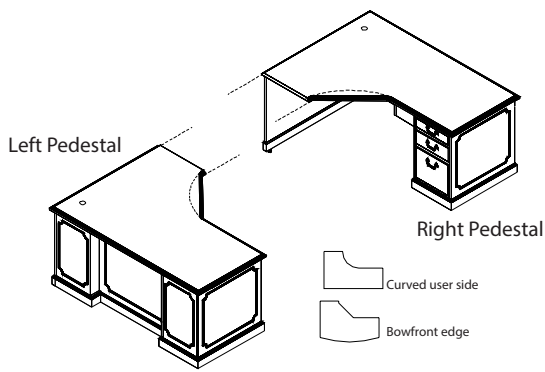

**BREAKFRONT BOX / BOX / FILE SERVICE DESK**

**STANDARD FEATURES**

- 1 Standard grommet - matches pull finish or specify black TM30, silver TM31 or antique brass TM33
- Box/Box/File
- Drawer fronts w/ profile edges
- Full fixed modesty w/ base
- Pull out writing shelf
- Soft close suspension drawer(s)

- Service Desk Can Be Used w/ Returns
- Use With Service Credenza For "U" Workstations

**NOTES**

[CLICK HERE TO VIEW PRODUCT INDEX](#)

**1 SELECT A STYLE**

DIMENSIONS		STYLE NUMBER	LIST PRICE	STYLE NUMBER	LIST PRICE	STYLE NUMBER	LIST PRICE
W" x D" x H"	WGT	"W" Veneer Veneer Top Veneer Chassis		"G" HPL High Pressure Laminate Top Veneer Chassis		"M" TFL Thermally Fused Laminate Top Thermally Fused Laminate Chassis	
<b>Left Pedestal</b>							
72 x 30/48 x 30	305	RPC7248DS754W	4309	RPC7248DS754G	4309	"M" Option N/A	
66 x 30/48 x 30	295	RPC6648DS754W	4223	RPC6648DS754G	4223	"M" Option N/A	
66 x 24/42 x 30	275	RPC6642DS754W	3880	RPC6642DS754G	3880	"M" Option N/A	
<b>Right Pedestal</b>							
72 x 30/48 x 30	305	RPC7248DS753W	4309	RPC7248DS753G	4309	"M" Option N/A	
66 x 30/48 x 30	295	RPC6648DS753W	4223	RPC6648DS753G	4223	"M" Option N/A	
66 x 24/42 x 30	275	RPC6642DS753W	3880	RPC6642DS753G	3880	"M" Option N/A	

**2 SELECT A FINISH**

"W" Veneer	"G" HPL	"M" TFL	
WAC	GAC	-	Amber Cherry
WRC	-	-	Caramel Cherry
WIC	GIC	-	Crimson Cherry
WEC	-	-	Ebony Cherry
WHC	GHC	-	Honey Cherry
WOC	GOC	-	KoKo Cherry
WSC	-	-	Scotch Cherry
WEW	GEW	-	Executive Walnut
WRW	GRW	-	Gray Luster Walnut
WGW	-	-	Gunstock Walnut
WJW	-	-	Judicial Walnut
WNW	GNW	-	Natural Walnut
WTW	GTW	-	Studio Teak Walnut

**3 SELECT AN EDGE**



**5 OPTIONS**

**ACCESSORIES**

- K28: Articulating Keyboard w/ Mouse - \$375

**DRAWER**

- P6: Modify Box/Box/File to File/File - \$50 per pedestal
- P33: Wood Drawer Upgrade - \$40 per drawer

**GROMMETS (NON-STANDARD LOCATION)**

Provide drawing w/ Grommet Location and Specify Color - \$90 ea.

- Black: TM30-NS
- Silver: TM31-NS
- Antique Brass: TM33-NS

**MOLDING**

- DSM1: Delete molding - Deduct \$95

**TOP**

- T80: MDF Edge Curve User Side - \$95
- T81: MDF Edge Approach Side Bowfront Edge - \$295

**4 SELECT HARDWARE**



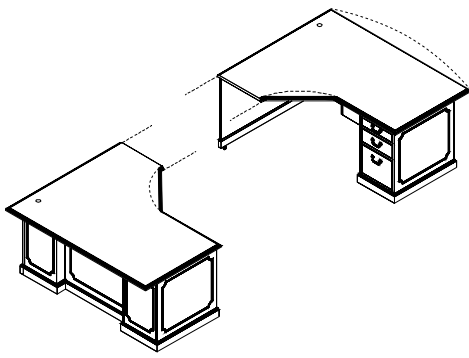

**OVERHANG BREAKFRONT BOX / BOX / FILE SERVICE DESK**

**STANDARD FEATURES**

- 1 Standard grommet - matches pull finish or specify black TM30, silver TM31 or antique brass TM33
- Box/Box/File
- Drawer fronts w/ profile edges
- Full fixed modesty w/ base
- Pull out writing shelf
- Soft close suspension drawer(s)

- 6" overhang on approach
- Service Desk Can Be Used w/ Returns
- Use With Service Credenza For "U" Workstations

**NOTES**

[CLICK HERE TO VIEW PRODUCT INDEX](#)

**1 SELECT A STYLE**

DIMENSIONS		STYLE NUMBER	LIST PRICE	STYLE NUMBER	LIST PRICE	STYLE NUMBER	LIST PRICE
W" x D" x H"	WGT	"W" Veneer Top Veneer Chassis		"G" High Pressure Laminate Top Veneer Chassis		"M" Thermally Fused Laminate Top Thermally Fused Laminate Chassis	
<b>Left Pedestal</b>							
72 x 36/54 x 30	355	RPC7254DS758W	4626	RPC7254DS758G	4626	"M" Option N/A	
66 x 36/54 x 30	340	RPC6654DS758W	4533	RPC6654DS758G	4533	"M" Option N/A	
66 x 30/48 x 30	310	RPC6648DS758W	4142	RPC6648DS758G	4142	"M" Option N/A	
<b>Right Pedestal</b>							
72 x 36/54 x 30	355	RPC7254DS757W	4626	RPC7254DS757G	4626	"M" Option N/A	
66 x 36/54 x 30	340	RPC6654DS757W	4533	RPC6654DS757G	4533	"M" Option N/A	
66 x 30/48 x 30	310	RPC6648DS757W	4142	RPC6648DS757G	4142	"M" Option N/A	

**2 SELECT A FINISH**

"W" Veneer	"G" HPL	"M" TFL	
WAC	GAC	-	Amber Cherry
WRC	-	-	Caramel Cherry
WIC	GIC	-	Crimson Cherry
WEC	-	-	Ebony Cherry
WHC	GHC	-	Honey Cherry
WOC	GOC	-	KoKo Cherry
WSC	-	-	Scotch Cherry
WEW	GEW	-	Executive Walnut
WRW	GRW	-	Gray Luster Walnut
WGW	-	-	Gunstock Walnut
WJW	-	-	Judicial Walnut
WNW	GNW	-	Natural Walnut
WTW	GTW	-	Studio Teak Walnut

**3 SELECT AN EDGE**



**5 OPTIONS**

- ACCESSORIES**
- K28: Articulating Keyboard w/ Mouse - \$375
  - K30: Traditional Center Drawer - \$195
- DRAWER**
- P6: Modify Box/Box/File to File/File - \$50 per pedestal
  - P33: Wood Drawer Upgrade - \$40 per drawer
- GROMMETS (NON-STANDARD LOCATION)**
- Provide drawing w/ Grommet Location and Specify Color - \$90 ea.
- Black: TM30-NS
  - Silver: TM31-NS
  - Antique Brass: TM33-NS
- MOLDING**
- DSM1: Delete molding - Deduct \$95
- TOP**
- T80: MDF Edge Curve User Side - \$95
  - T81: MDF Edge Approach Side Bowfront Edge - \$295

**4 SELECT HARDWARE**



Left Pedestal

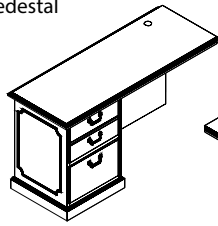

Right Pedestal

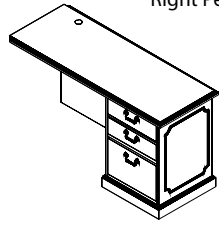

**BOX / BOX / FILE**

**STANDARD FEATURES**

- 1 Standard grommet - matches pull finish or specify black TM30, silver TM31 or antique brass TM33
- Drawer fronts w/ profile edges
- Full extension drawers - locking
- Full fixed modesty
- Soft close suspension drawer(s)

[CLICK HERE TO VIEW PRODUCT INDEX](#)

**1 SELECT A STYLE**

DIMENSIONS		STYLE NUMBER	LIST PRICE	STYLE NUMBER	LIST PRICE	STYLE NUMBER	LIST PRICE
W" x D" x H"	WGT	"W" Veneer Veneer Top Veneer Chassis		"G" HPL High Pressure Laminate Top Veneer Chassis		"M" TFL Thermally Fused Laminate Top Thermally Fused Laminate Chassis	
<b>Left Pedestal</b>							
60 x 24 x 30	165	RPC6024RE207W	2320	RPC6024RE207G	2320	"M" Option N/A	
54 x 24 x 30	155	RPC5424RE207W	2226	RPC5424RE207G	2226	"M" Option N/A	
48 x 24 x 30	145	RPC4824RE207W	2139	RPC4824RE207G	2139	"M" Option N/A	
42 x 24 x 30	135	RPC4224RE207W	2090	RPC4224RE207G	2090	"M" Option N/A	
<b>Right Pedestal</b>							
60 x 24 x 30	165	RPC6024RE209W	2320	RPC6024RE209G	2320	"M" Option N/A	
54 x 24 x 30	155	RPC5424RE209W	2226	RPC5424RE209G	2226	"M" Option N/A	
48 x 24 x 30	145	RPC4824RE209W	2139	RPC4824RE209G	2139	"M" Option N/A	
42 x 24 x 30	135	RPC4224RE209W	2090	RPC4224RE209G	2090	"M" Option N/A	

**2 SELECT A FINISH**

"W" Veneer	"G" HPL	"M" TFL	
WAC	GAC	-	Amber Cherry
WRC	-	-	Caramel Cherry
WIC	GIC	-	Crimson Cherry
WEC	-	-	Ebony Cherry
WHC	GHC	-	Honey Cherry
WOC	GOC	-	KoKo Cherry
WSC	-	-	Scotch Cherry
WEW	GEW	-	Executive Walnut
WRW	GRW	-	Gray Luster Walnut
WGW	-	-	Gunstock Walnut
WJW	-	-	Judicial Walnut
WNW	GNW	-	Natural Walnut
WTW	GTW	-	Studio Teak Walnut

**3 SELECT AN EDGE**



**5 OPTIONS**

- ACCESSORIES**
- K28: Articulating Keyboard w/ Mouse - \$375
- DRAWER**
- P33: Wood Drawer Upgrade - \$40 per drawer
  - P40B: extra Box/Box/File or File/File to Kneespace - \$985
- FLUSH CUT**
- FC-L: Flush Unit Left (Facing) for Ganging - \$95
  - FC-R: Flush Unit Right(Facing) for Ganging - \$95
- GROMMETS (NON-STANDARD LOCATION)**
- Provide drawing w/ Grommet Location and Specify Color - \$90 ea.
- Black: TM30-NS
  - Silver: TM31-NS
  - Antique Brass: TM33-NS
- MODESTY**
- M34T: "W" "G" Style Drop Door Tech Modesty - \$125
  - M51: Open Back Modesty with Wire Mgmt Rail - Deduct \$95
- MOLDING**
- DSM2: Delete molding - Deduct \$50

**4 SELECT HARDWARE**



Left Pedestal

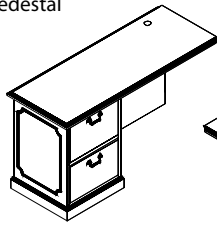

Right Pedestal

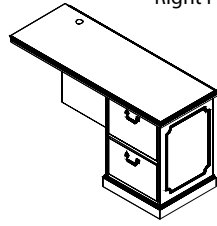

**FILE / FILE**

**STANDARD FEATURES**

- 1 Standard grommet - matches pull finish or specify black TM30, silver TM31 or antique brass TM33
- Drawer fronts w/ profile edges
- Full extension drawers - locking
- Full fixed modesty
- Soft close suspension drawer(s)

[CLICK HERE TO VIEW PRODUCT INDEX](#)

**1 SELECT A STYLE**

DIMENSIONS		STYLE NUMBER	LIST PRICE	STYLE NUMBER	LIST PRICE	STYLE NUMBER	LIST PRICE
W" x D" x H"	WGT	"W" Veneer Veneer Top Veneer Chassis		"G" HPL High Pressure Laminate Top Veneer Chassis		"M" TFL Thermally Fused Laminate Top Thermally Fused Laminate Chassis	
<b>Left Pedestal</b>							
60 x 24 x 30	165	RPC6024RE195W	2320	RPC6024RE195G	2320	"M" Option N/A	
54 x 24 x 30	155	RPC5424RE195W	2226	RPC5424RE195G	2226	"M" Option N/A	
48 x 24 x 30	145	RPC4824RE195W	2139	RPC4824RE195G	2139	"M" Option N/A	
42 x 24 x 30	135	RPC4224RE195W	2090	RPC4224RE195G	2090	"M" Option N/A	
<b>Right Pedestal</b>							
60 x 24 x 30	165	RPC6024RE196W	2320	RPC6024RE196G	2320	"M" Option N/A	
54 x 24 x 30	155	RPC5424RE196W	2226	RPC5424RE196G	2226	"M" Option N/A	
48 x 24 x 30	145	RPC4824RE196W	2139	RPC4824RE196G	2139	"M" Option N/A	
42 x 24 x 30	135	RPC4224RE196W	2090	RPC4224RE196G	2090	"M" Option N/A	

**2 SELECT A FINISH**

"W" Veneer	"G" HPL	"M" TFL	
WAC	GAC	-	Amber Cherry
WRC	-	-	Caramel Cherry
WIC	GIC	-	Crimson Cherry
WEC	-	-	Ebony Cherry
WHC	GHC	-	Honey Cherry
WOC	GOC	-	KoKo Cherry
WSC	-	-	Scotch Cherry
WEW	GEW	-	Executive Walnut
WRW	GRW	-	Gray Luster Walnut
WGW	-	-	Gunstock Walnut
WJW	-	-	Judicial Walnut
WNW	GNW	-	Natural Walnut
WTW	GTW	-	Studio Teak Walnut

**3 SELECT AN EDGE**



**5 OPTIONS**

- ACCESSORIES**
- K28: Articulating Keyboard w/ Mouse - \$375
- DRAWER**
- P33: Wood Drawer Upgrade - \$40 per drawer
  - P40B: extra Box/Box/File or File/File to Kneespace - \$985
- FLUSH CUT**
- FC-L: Flush Unit Left (Facing) for Ganging - \$95
  - FC-R: Flush Unit Right(Facing) for Ganging - \$95
- GROMMETS (NON-STANDARD LOCATION)**
- Provide drawing w/ Grommet Location and Specify Color - \$90 ea.
- Black: TM30-NS
  - Silver: TM31-NS
  - Antique Brass: TM33-NS
- MODESTY**
- M34T: "W" "G" Style Drop Door Tech Modesty - \$125
  - M51: Open Back Modesty with Wire Mgmt Rail - Deduct \$95
- MOLDING**
- DSM2: Delete molding - Deduct \$50

**4 SELECT HARDWARE**





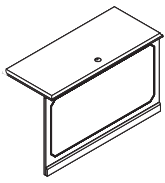

**BRIDGE W/ FIXED FULL MODESTY**

**STANDARD FEATURES**

- Full modesty panel with base
- Top cope shaped for flush surface
- Top grommet

**NOTES**

- 36" bridge for use with service "U" or Corner Unit

[CLICK HERE TO VIEW PRODUCT INDEX](#)

**1 SELECT A STYLE**

DIMENSIONS		STYLE NUMBER	LIST PRICE	STYLE NUMBER	LIST PRICE	STYLE NUMBER	LIST PRICE
W" x D" x H"	WGT	"W" Veneer Veneer Top Veneer Chassis		"G" HPL High Pressure Laminate Top Veneer Chassis		"M" TFL Thermally Fused Laminate Top Thermally Fused Laminate Chassis	
<b>24" Deep Bridge</b>							
60 x 24 x 30	105	RPC6024BR150W	1139	RPC6024BR150G	1139	"M" Option N/A	
54 x 24 x 30	95	RPC5424BR150W	1089	RPC5424BR150G	1089	"M" Option N/A	
48 x 24 x 30	90	RPC4824BR150W	1014	RPC4824BR150G	1014	"M" Option N/A	
42 x 24 x 30	85	RPC4224BR150W	989	RPC4224BR150G	989	"M" Option N/A	
<b>19" Deep Bridge</b>							
48 x 19 x 30	75	RPC4819BR150W	940	RPC4819BR150G	940	"M" Option N/A	
42 x 19 x 30	70	RPC4219BR150W	914	RPC4219BR150G	914	"M" Option N/A	

**2 SELECT A FINISH**

"W" Veneer	"G" HPL	"M" TFL	
WAC	GAC	-	Amber Cherry
WRC	-	-	Caramel Cherry
WIC	GIC	-	Crimson Cherry
WEC	-	-	Ebony Cherry
WHC	GHC	-	Honey Cherry
WOC	GOC	-	KoKo Cherry
WSC	-	-	Scotch Cherry
WEW	GEW	-	Executive Walnut
WRW	GRW	-	Gray Luster Walnut
WGW	-	-	Gunstock Walnut
WJW	-	-	Judicial Walnut
WNW	GNW	-	Natural Walnut
WTW	GTW	-	Studio Teak Walnut

**3 SELECT AN EDGE**



**5 OPTIONS**

- ACCESSORIES**
- K28: Articulating Keyboard w/ Mouse - \$375
- DRAWER**
- P40B: extra Box/Box/File or File/File to Kneespace - \$985
- MODESTY**
- M34T: "W" "G" Style Drop Door Tech Modesty - \$125
  - M37: "W" "G" Style Fixed Full Modesty - \$125
- MOLDING**
- DSM1: Delete molding - Deduct \$95

**4 SELECT HARDWARE**

Hardware Option Not Available

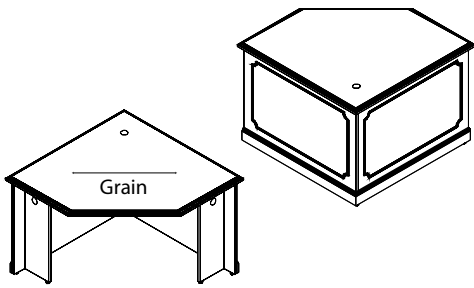

**WORKSTATION 45 DEGREE CORNER UNIT**

**STANDARD FEATURES**

- 1 Standard grommet - matches pull finish or specify black TM30, silver TM31 or antique brass TM33
- Full base
- Non-handed

**NOTES**

- For Use w/ 24" D Bridges and Returns Only
- Left pedestal gets right grommet
- Right pedestal gets left grommet

[CLICK HERE TO VIEW PRODUCT INDEX](#)

**1 SELECT A STYLE**

DIMENSIONS		STYLE NUMBER	LIST PRICE	STYLE NUMBER	LIST PRICE	STYLE NUMBER	LIST PRICE
W" x D" x H"	WGT	<b>"W"</b> Veneer Top Veneer Chassis		<b>"G"</b> High Pressure Laminate Top Veneer Chassis		<b>"M"</b> Thermally Fused Laminate Top Thermally Fused Laminate Chassis	
42 x 42 x 30	180	RPC4242CU228W	1891	RPC4242CU228G	1891	"M" Option N/A	
36 x 36 x 30	145	RPC3636CU228W	1716	RPC3636CU228G	1716	"M" Option N/A	

**2 SELECT A FINISH**

<b>"W"</b> Veneer	<b>"G"</b> HPL	<b>"M"</b> TFL	
WAC	GAC	-	Amber Cherry
WRC	-	-	Caramel Cherry
WIC	GIC	-	Crimson Cherry
WEC	-	-	Ebony Cherry
WHC	GHC	-	Honey Cherry
WOC	GOC	-	KoKo Cherry
WSC	-	-	Scotch Cherry
WEW	GEW	-	Executive Walnut
WRW	GRW	-	Gray Luster Walnut
WGW	-	-	Gunstock Walnut
WJW	-	-	Judicial Walnut
WNW	GNW	-	Natural Walnut
WTW	GTW	-	Studio Teak Walnut

**3 SELECT AN EDGE**



**5 OPTIONS**

- ACCESSORIES**
- K28: Articulating Keyboard w/ Mouse - \$375
- GROMMETS (NON-STANDARD LOCATION)**
- Provide drawing w/ Grommet Location and Specify Color - \$90 ea.
- Black: TM30-NS
  - Silver: TM31-NS
  - Antique Brass: TM33-NS
- MOLDING**
- DSM2: Delete molding - Deduct \$50

**4 SELECT HARDWARE**

Hardware  
Option Not  
Available

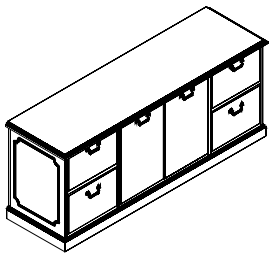

**STORAGE CREDENZA**

**STANDARD FEATURES**

- Black adjustable shelf behind door set
- Drawer fronts w/ profile edges
- File/File
- Full continuous base under cabinets
- Soft close suspension drawer(s)

**NOTES**

- Unit not designed for open plan use. Select OPB Option for Open Plan application

[CLICK HERE TO VIEW PRODUCT INDEX](#)

**1 SELECT A STYLE**

DIMENSIONS		STYLE NUMBER	LIST PRICE	STYLE NUMBER	LIST PRICE	STYLE NUMBER	LIST PRICE
W" x D" x H"	WGT	"W" Veneer Top Veneer Chassis		"G" HPL High Pressure Laminate Top Veneer Chassis		"M" TFL Thermally Fused Laminate Top Thermally Fused Laminate Chassis	
<b>File/ File</b>							
72 x 24 x 30	280	RPC7224CA050W	3035	RPC7224CA050G	3035	"M" Option N/A	
66 x 24 x 30	265	RPC6624CA050W	2911	RPC6624CA050G	2911	"M" Option N/A	
<b>Lateral File</b>							
95 x 24 x 30	350	RPC9524CA651W	5417	RPC9524CA651G	5417	"M" Option N/A	
89 x 24 x 30	325	RPC8924CA651W	5155	RPC8924CA651G	5155	"M" Option N/A	

**2 SELECT A FINISH**

"W" Veneer	"G" HPL	"M" TFL	
WAC	GAC	-	Amber Cherry
WRC	-	-	Caramel Cherry
WIC	GIC	-	Crimson Cherry
WEC	-	-	Ebony Cherry
WHC	GHC	-	Honey Cherry
WOC	GOC	-	KoKo Cherry
WSC	-	-	Scotch Cherry
WEW	GEW	-	Executive Walnut
WRW	GRW	-	Gray Luster Walnut
WGW	-	-	Gunstock Walnut
WJW	-	-	Judicial Walnut
WNW	GNW	-	Natural Walnut
WTW	GTW	-	Studio Teak Walnut

**3 SELECT AN EDGE**



**5 OPTIONS**

- DOOR**
- D2: Door Lock - \$95 per Door Set
  - D6A: "W" "G" Styles - Delete Doors and replace black laminate shelf with finished shelf - n/c
  - D9SC: Soft Close Door Hinges - \$15 per Door
- DRAWER**
- P6: Modify File/File to Box/Box/File - \$50 per pedestal
  - P33: Wood Drawer Upgrade - \$40 per drawer
- FLUSH CUT**
- FC-B: Flush Unit Both Sides(Facing) for Ganging - \$95
  - FC-L: Flush Unit Left (Facing) for Ganging - \$95
  - FC-R: Flush Unit Right(Facing) for Ganging - \$95
- GROMMETS (STANDARD LOCATION)**
- Specify Color and Location (Right/Left/Center) - \$45 ea.
- Black: TM30-R (Right), TM30-L (Left), TM30-C (Center)
  - Silver: TM31-R (Right), TM31-L (Left), TM31-C (Center)
  - Antique Brass: TM33-R (Right), TM33-L (Left), TM33-C (Center)
- GROMMETS (NON-STANDARD LOCATION)**
- Provide drawing w/ Grommet Location and Specify Color - \$90 ea.
- Black: TM30-NS
  - Silver: TM31-NS
  - Antique Brass: TM33-NS
- MOLDING**
- DSM2: Delete molding - Deduct \$50
- OPEN PLAN**
- OPB: "W" "G" Style - Modify Unit for Open Plan Application - \$295
- SHELVES**
- S25: Replace Black Laminate Shelf with Finished Shelf - \$75 per Shelf

**4 SELECT HARDWARE**

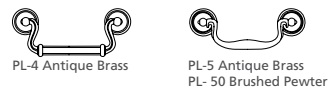

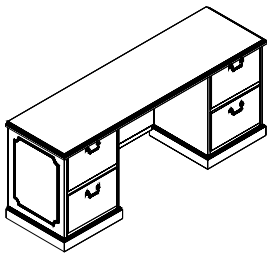

**KNEESPACE CREDENZA**

**STANDARD FEATURES**

- Drawer fronts w/ profile edges
- File/File
- Full fixed modesty
- Soft close suspension drawer(s)

**NOTES**

- Unit not designed for open plan use. Select OPB Option for Open Plan application

[CLICK HERE TO VIEW PRODUCT INDEX](#)

**1 SELECT A STYLE**

DIMENSIONS		STYLE NUMBER	LIST PRICE	STYLE NUMBER	LIST PRICE	STYLE NUMBER	LIST PRICE
W" x D" x H"	WGT	"W" Veneer Top Veneer Chassis		"G" High Pressure Laminate Top Veneer Chassis		"M" Thermally Fused Laminate Top Thermally Fused Laminate Chassis	
72 x 24 x 30	250	RPC7224CA054W	2675	RPC7224CA054G	2675	"M" Option N/A	
66 x 24 x 30	235	RPC6624CA054W	2513	RPC6624CA054G	2513	"M" Option N/A	
60 x 24 x 30	225	RPC6024CA054W	2338	RPC6024CA054G	2338	"M" Option N/A	

**2 SELECT A FINISH**

"W" Veneer	"G" HPL	"M" TFL	
WAC	GAC	-	Amber Cherry
WRC	-	-	Caramel Cherry
WIC	GIC	-	Crimson Cherry
WEC	-	-	Ebony Cherry
WHC	GHC	-	Honey Cherry
WOC	GOC	-	KoKo Cherry
WSC	-	-	Scotch Cherry
WEW	GEW	-	Executive Walnut
WRW	GRW	-	Gray Luster Walnut
WGW	-	-	Gunstock Walnut
WJW	-	-	Judicial Walnut
WNW	GNW	-	Natural Walnut
WTW	GTW	-	Studio Teak Walnut

**3 SELECT AN EDGE**



**5 OPTIONS**

- ACCESSORIES**
- K28: Articulating Keyboard w/ Mouse - \$375
- DRAWER**
- P6: Modify File/File to Box/Box/File - \$50 per pedestal
  - P33: Wood Drawer Upgrade - \$40 per drawer
- FLUSH CUT**
- FC-B: Flush Unit Both Sides(Facing) for Ganging - \$95
  - FC-L: Flush Unit Left (Facing) for Ganging - \$95
  - FC-R: Flush Unit Right(Facing) for Ganging - \$95
- GROMMETS (STANDARD LOCATION)**
- Specify Color - \$45 ea.
- Black: TM30-C (Center)
  - Silver: TM31-C (Center)
  - Antique Brass: TM33-C (Center)
- GROMMETS (NON-STANDARD LOCATION)**
- Provide drawing w/ Grommet Location and Specify Color - \$90 ea.
- Black: TM30-NS
  - Silver: TM31-NS
  - Antique Brass: TM33-NS
- MODESTY**
- M34T: "W" "G" Style Drop Door Tech Modesty - \$125
  - M51: Open Back Modesty with Wire Mgmt Rail - Deduct \$95
- MOLDING**
- DSM2: Delete molding - Deduct \$50
- OPEN PLAN**
- OPB: "W" "G" Style - Modify Unit for Open Plan Application - \$295

**4 SELECT HARDWARE**



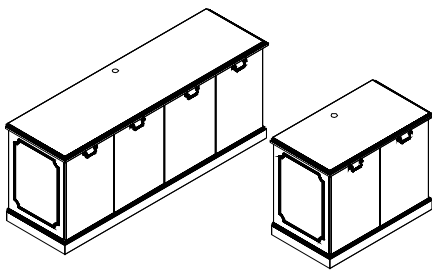

**STORAGE CREDENZA**

**STANDARD FEATURES**

- Black adjustable shelf behind door set
- Door fronts w/ profile edges
- Full continuous base under cabinets

**NOTES**

- Unit not designed for open plan use. Select OPB Option for Open Plan application

[CLICK HERE TO VIEW PRODUCT INDEX](#)

**1 SELECT A STYLE**

DIMENSIONS		STYLE NUMBER	LIST PRICE	STYLE NUMBER	LIST PRICE	STYLE NUMBER	LIST PRICE
W" x D" x H"	WGT	"W" Veneer Top Veneer Chassis		"G" HPL High Pressure Laminate Top Veneer Chassis		"M" TFL Thermally Fused Laminate Top Thermally Fused Laminate Chassis	
72 x 24 x 30	260	RPC7224CA125W	2973	RPC7224CA125G	2973	"M" Option N/A	
60 x 24 x 30	230	RPC6024CA125W	2836	RPC6024CA125G	2836	"M" Option N/A	
37 x 24 x 30	160	RPC3724CA125W	1697	RPC3724CA125G	1697	"M" Option N/A	
31 x 24 x 30	150	RPC3124CA125W	1642	RPC3124CA125G	1642	"M" Option N/A	

**2 SELECT A FINISH**

"W" Veneer	"G" HPL	"M" TFL	
WAC	GAC	-	Amber Cherry
WRC	-	-	Caramel Cherry
WIC	GIC	-	Crimson Cherry
WEC	-	-	Ebony Cherry
WHC	GHC	-	Honey Cherry
WOC	GOC	-	KoKo Cherry
WSC	-	-	Scotch Cherry
WEW	GEW	-	Executive Walnut
WRW	GRW	-	Gray Luster Walnut
WGW	-	-	Gunstock Walnut
WJW	-	-	Judicial Walnut
WNW	GNW	-	Natural Walnut
WTW	GTW	-	Studio Teak Walnut

**3 SELECT AN EDGE**



**5 OPTIONS**

- DOOR**
- D2: Door Lock - \$95 per Door Set
  - D6A: "W" "G" Styles - Delete Doors and replace black laminate shelf with finished shelf - n/c
  - D95C: Soft Close Door Hinges - \$15 per Door
- FLUSH CUT**
- FC-B: Flush Unit Both Sides(Facing) for Ganging - \$95
  - FC-L: Flush Unit Left (Facing) for Ganging - \$95
  - FC-R: Flush Unit Right(Facing) for Ganging - \$95
- GROMMETS (STANDARD LOCATION)**
- Specify Color and Location (Right/Left/Center) - \$45 ea.
- Black: TM30-R (Right), TM30-L (Left), TM30-C (Center)
  - Silver: TM31-R (Right), TM31-L (Left), TM31-C (Center)
  - Antique Brass: TM33-R (Right), TM33-L (Left), TM33-C (Center)
- GROMMETS (NON-STANDARD LOCATION)**
- Provide drawing w/ Grommet Location and Specify Color - \$90 ea.
- Black: TM30-NS
  - Silver: TM31-NS
  - Antique Brass: TM33-NS
- MOLDING**
- DSM2: Delete molding - Deduct \$50
- OPEN PLAN**
- OPB: "W" "G" Style - Modify Unit for Open Plan Application - \$295
- SHELVES**
- S25: Replace Black Laminate Shelf with Finished Shelf - \$75 per Shelf

**4 SELECT HARDWARE**



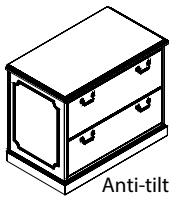

Anti-tilt Safety Drawer Lock

**HORIZONTAL LATERAL FILE - 2/4**

**STANDARD FEATURES**

- Anti-tilt safety drawer lock
- Drawer fronts w/ profile edges
- Full extension drawers - locking
- Legal/Double letter filing
- Soft close suspension drawer(s)

**NOTES**

- Unit not designed for open plan use. Select OPB Option for Open Plan application

[CLICK HERE TO VIEW PRODUCT INDEX](#)

**1 SELECT A STYLE**

DIMENSIONS		STYLE NUMBER	LIST PRICE	STYLE NUMBER	LIST PRICE	STYLE NUMBER	LIST PRICE
W" x D" x H"	WGT	"W" Veneer Top Veneer Chassis		"G" HPL High Pressure Laminate Top Veneer Chassis		"M" TFL Thermally Fused Laminate Top Thermally Fused Laminate Chassis	
<b>4 Drawer</b>							
72 x 24 x 30	300	RPC7224CA104W	3283	RPC7224CA104G	3283	"M" Option N/A	
60 x 24 x 30	275	RPC6024CA104W	3073	RPC6024CA104G	3073	"M" Option N/A	
<b>2 Drawer</b>							
43 x 24 x 30	175	RPC4324CA104W	1992	RPC4324CA104G	1992	"M" Option N/A	
37 x 24 x 30	165	RPC3724CA104W	1791	RPC3724CA104G	1791	"M" Option N/A	
31 x 24 x 30	155	RPC3124CA104W	1730	RPC3124CA104G	1730	"M" Option N/A	

**2 SELECT A FINISH**

"W" Veneer	"G" HPL	"M" TFL	
WAC	GAC	-	Amber Cherry
WRC	-	-	Caramel Cherry
WIC	GIC	-	Crimson Cherry
WEC	-	-	Ebony Cherry
WHC	GHC	-	Honey Cherry
WOC	GOC	-	KoKo Cherry
WSC	-	-	Scotch Cherry
WEW	GEW	-	Executive Walnut
WRW	GRW	-	Gray Luster Walnut
WGW	-	-	Gunstock Walnut
WJW	-	-	Judicial Walnut
WNW	GNW	-	Natural Walnut
WTW	GTW	-	Studio Teak Walnut

**3 SELECT AN EDGE**



**5 OPTIONS**

- DRAWER**  
- P33: Wood Drawer Upgrade - \$40 per drawer
- FLUSH CUT**  
- FC-B: Flush Unit Both Sides(Facing) for Ganging - \$95  
- FC-L: Flush Unit Left (Facing) for Ganging - \$95  
- FC-R: Flush Unit Right(Facing) for Ganging - \$95
- GROMMETS (STANDARD LOCATION)**  
Specify Color and Location (Right/Left/Center) - \$45 ea.  
- Black: TM30-R (Right), TM30-L (Left), TM30-C (Center)  
- Silver: TM31-R (Right), TM31-L (Left), TM31-C (Center)  
- Antique Brass: TM33-R (Right), TM33-L (Left), TM33-C (Center)
- GROMMETS (NON-STANDARD LOCATION)**  
Provide drawing w/ Grommet Location and Specify Color - \$90 ea.  
- Black: TM30-NS  
- Silver: TM31-NS  
- Antique Brass: TM33-NS
- MOLDING**  
- DSM2: Delete molding - Deduct \$50
- OPEN PLAN**  
- OPB: "W" "G" Style - Modify Unit for Open Plan Application - \$295

**4 SELECT HARDWARE**



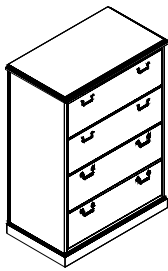

Anti-tilt Safety Drawer Lock

**VERTICAL LATERAL FILE**

**STANDARD FEATURES**

- Anti-tilt safety drawer lock
- Full extension drawers - Full extension drawers
  - locking
- Legal/Double letter filing
- Soft close suspension drawer(s)

**NOTES**

- Unit not designed for open plan use. Select OPB Option for Open Plan application

[CLICK HERE TO VIEW PRODUCT INDEX](#)

**1 SELECT A STYLE**

DIMENSIONS		STYLE NUMBER	LIST PRICE	STYLE NUMBER	LIST PRICE	STYLE NUMBER	LIST PRICE
W" x D" x H"	WGT	"W" Veneer Top Veneer Chassis		"G" HPL High Pressure Laminate Top Veneer Chassis		"M" TFL Thermally Fused Laminate Top Thermally Fused Laminate Chassis	
43 x 24 x 52	300	RPC4324FI111W	3939	RPC4324FI111G	3939	"M" Option N/A	
37 x 24 x 52	275	RPC3724FI111W	3358	RPC3724FI111G	3358	"M" Option N/A	
31 x 24 x 52	245	RPC3124FI111W	3278	RPC3124FI111G	3278	"M" Option N/A	

**2 SELECT A FINISH**

"W" Veneer	"G" HPL	"M" TFL	
WAC	GAC	-	Amber Cherry
WRC	-	-	Caramel Cherry
WIC	GIC	-	Crimson Cherry
WEC	-	-	Ebony Cherry
WHC	GHC	-	Honey Cherry
WOC	GOC	-	KoKo Cherry
WSC	-	-	Scotch Cherry
WEW	GEW	-	Executive Walnut
WRW	GRW	-	Gray Luster Walnut
WGW	-	-	Gunstock Walnut
WJW	-	-	Judicial Walnut
WNW	GNW	-	Natural Walnut
WTW	GTW	-	Studio Teak Walnut

**3 SELECT AN EDGE**



**5 OPTIONS**

- DRAWER**
- P33: Wood Drawer Upgrade - \$40 per drawer
- FLUSH CUT**
- FC-B: Flush Unit Both Sides(Facing) for Ganging - \$95
  - FC-L: Flush Unit Left (Facing) for Ganging - \$95
  - FC-R: Flush Unit Right(Facing) for Ganging - \$95
- OPEN PLAN**
- OPB: "W" "G" Style - Modify Unit for Open Plan Application - \$295

**4 SELECT HARDWARE**



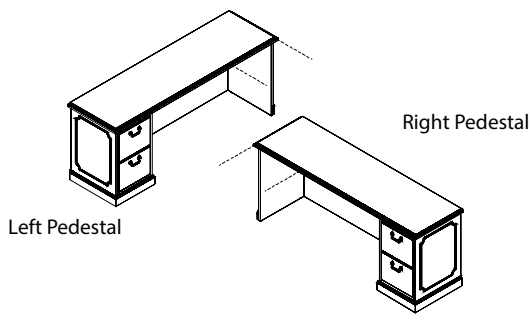

**FILE / FILE**

**STANDARD FEATURES**

- Drawer fronts w/ profile edges
- File/File
- Full fixed modesty
- Full extension drawers - locking
- Soft close suspension drawer(s)

**NOTES**

- Unit not designed for open plan use. Select OPB Option for Open Plan application

[CLICK HERE TO VIEW PRODUCT INDEX](#)

**1 SELECT A STYLE**

DIMENSIONS		STYLE NUMBER	LIST PRICE	STYLE NUMBER	LIST PRICE	STYLE NUMBER	LIST PRICE
W" x D" x H"	WGT	"W" Veneer Top Veneer Chassis		"G" HPL High Pressure Laminate Top Veneer Chassis		"M" TFL Thermally Fused Laminate Top Thermally Fused Laminate Chassis	
<b>Left Pedestal</b>							
89 x 24 x 30	200	RPC8924CA086W	2650	RPC8924CA086G	2650	"M" Option N/A	
72 x 24 x 30	180	RPC7224CA086W	2387	RPC7224CA086G	2387	"M" Option N/A	
66 x 24 x 30	170	RPC6624CA086W	2314	RPC6624CA086G	2314	"M" Option N/A	
<b>Right Pedestal</b>							
89 x 24 x 30	200	RPC8924CA087W	2650	RPC8924CA087G	2650	"M" Option N/A	
72 x 24 x 30	180	RPC7224CA087W	2387	RPC7224CA087G	2387	"M" Option N/A	
66 x 24 x 30	170	RPC6624CA087W	2314	RPC6624CA087G	2314	"M" Option N/A	

**2 SELECT A FINISH**

"W" Veneer	"G" HPL	"M" TFL	
WAC	GAC	-	Amber Cherry
WRC	-	-	Caramel Cherry
WIC	GIC	-	Crimson Cherry
WEC	-	-	Ebony Cherry
WHC	GHC	-	Honey Cherry
WOC	GOC	-	KoKo Cherry
WSC	-	-	Scotch Cherry
WEW	GEW	-	Executive Walnut
WRW	GRW	-	Gray Luster Walnut
WGW	-	-	Gunstock Walnut
WJW	-	-	Judicial Walnut
WNW	GNW	-	Natural Walnut
WTW	GTW	-	Studio Teak Walnut

**3 SELECT AN EDGE**



**5 OPTIONS**

- ACCESSORIES**
- K28: Articulating Keyboard w/ Mouse - \$375
- DRAWER**
- P6: Modify File/File to Box/Box/File - \$50 per pedestal
  - P33: Wood Drawer Upgrade - \$40 per drawer
  - P40B: extra Box/Box/File or File/File to Kneespace - \$985

- FLUSH CUT**
- FC-B: Flush Unit Both Sides(Facing) for Ganging - \$95
  - FC-L: Flush Unit Left (Facing) for Ganging - \$95
  - FC-R: Flush Unit Right(Facing) for Ganging - \$95

- GROMMETS (STANDARD LOCATION)**
- Specify Color - \$45 ea.
- Black: TM30-C (Center)
  - Silver: TM31-C (Center)
  - Antique Brass: TM33-C (Center)

- GROMMETS (NON-STANDARD LOCATION)**
- Provide drawing w/ Grommet Location and Specify Color - \$90 ea.
- Black: TM30-NS
  - Silver: TM31-NS
  - Antique Brass: TM33-NS

- MODESTY**
- M34T: "W" "G" Style Drop Door Tech Modesty - \$125
  - M51: Open Back Modesty with Wire Mgmt Rail - Deduct \$95

- MOLDING**
- DSM2: Delete molding - Deduct \$50

- OPEN PLAN**
- OPB: "W" "G" Style - Modify Unit for Open Plan Application - \$295

**4 SELECT HARDWARE**





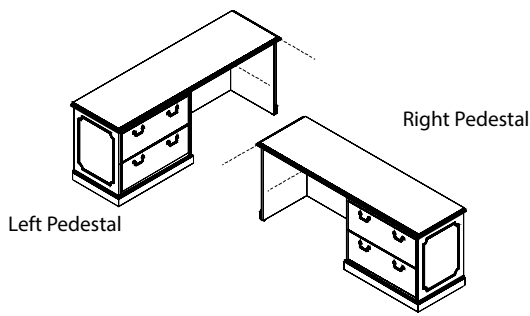

**LATERAL FILE**

**STANDARD FEATURES**

- Drawer fronts w/ profile edges
- Full fixed modesty
- Full extension drawers - locking
- Soft close suspension drawer(s)

**NOTES**

- Keyboard not available on 66" and 72"
- Unit not designed for open plan use. Select OPB Option for Open Plan application

[CLICK HERE TO VIEW PRODUCT INDEX](#)

**1 SELECT A STYLE**

DIMENSIONS		STYLE NUMBER	LIST PRICE	STYLE NUMBER	LIST PRICE	STYLE NUMBER	LIST PRICE
W" x D" x H"	WGT	"W" Veneer Top Veneer Chassis		"G" High Pressure Laminate Top Veneer Chassis		"M" Thermally Fused Laminate Top Thermally Fused Laminate Chassis	
<b>Left Pedestal</b>							
95 x 24 x 30	250	RPC9524CA066W	3015	RPC9524CA066G	3015	"M" Option N/A	
89 x 24 x 30	240	RPC8924CA066W	2755	RPC8924CA066G	2755	"M" Option N/A	
72 x 24 x 30	220	RPC7224CA066W	2493	RPC7224CA066G	2493	"M" Option N/A	
66 x 24 x 30	210	RPC6624CA066W	2418	RPC6624CA066G	2418	"M" Option N/A	
<b>Right Pedestal</b>							
95 x 24 x 30	250	RPC9524CA067W	3015	RPC9524CA067G	3015	"M" Option N/A	
89 x 24 x 30	240	RPC8924CA067W	2755	RPC8924CA067G	2755	"M" Option N/A	
72 x 24 x 30	220	RPC7224CA067W	2493	RPC7224CA067G	2493	"M" Option N/A	
66 x 24 x 30	210	RPC6624CA067W	2418	RPC6624CA067G	2418	"M" Option N/A	

**2 SELECT A FINISH**

"W" Veneer	"G" HPL	"M" TFL	
WAC	GAC	-	Amber Cherry
WRC	-	-	Caramel Cherry
WIC	GIC	-	Crimson Cherry
WEC	-	-	Ebony Cherry
WHC	GHC	-	Honey Cherry
WOC	GOC	-	KoKo Cherry
WSC	-	-	Scotch Cherry
WEW	GEW	-	Executive Walnut
WRW	GRW	-	Gray Luster Walnut
WGW	-	-	Gunstock Walnut
WJW	-	-	Judicial Walnut
WNW	GNW	-	Natural Walnut
WTW	GTW	-	Studio Teak Walnut

**3 SELECT AN EDGE**



**5 OPTIONS**

**ACCESSORIES**

- K28: Articulating Keyboard w/ Mouse - \$375

**DRAWER**

- P33: Wood Drawer Upgrade - \$40 per drawer
- P40B: extra Box/Box/File or File/File to Kneespace - \$985

**FLUSH CUT**

- FC-B: Flush Unit Both Sides(Facing) for Ganging - \$95
- FC-L: Flush Unit Left (Facing) for Ganging - \$95
- FC-R: Flush Unit Right(Facing) for Ganging - \$95

**GROMMETS (STANDARD LOCATION)**

- Specify Color - \$45 ea.
- Black: TM30-C (Center)
- Silver: TM31-C (Center)
- Antique Brass: TM33-C (Center)

**GROMMETS (NON-STANDARD LOCATION)**

- Provide drawing w/ Grommet Location and Specify Color - \$90 ea.
- Black: TM30-NS
- Silver: TM31-NS
- Antique Brass: TM33-NS

**MODESTY**

- M34T: "W" "G" Style Drop Door Tech Modesty - \$125
- M51: Open Back Modesty with Wire Mgmt Rail - Deduct \$95

**MOLDING**

- DSM2: Delete molding - Deduct \$50

**OPEN PLAN**

- OPB: "W" "G" Style - Modify Unit for Open Plan Application - \$295

**4 SELECT HARDWARE**



Left Pedestal

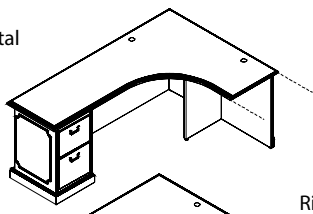

Right Pedestal

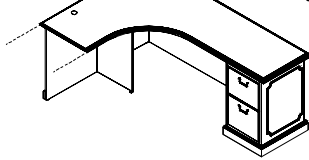

**FILE / FILE**

**STANDARD FEATURES**

- 2 Standard grommets - matches pull finish  
or specify black TM30, silver TM31 or antique brass TM33
- Drawer fronts w/ profile edges
- Full extension drawers - locking
- Soft close suspension drawer(s)

**NOTES**

- Unit not designed for open plan use. Select OPB Option for Open Plan application

[CLICK HERE TO VIEW PRODUCT INDEX](#)

**1 SELECT A STYLE**

DIMENSIONS		STYLE NUMBER	LIST PRICE	STYLE NUMBER	LIST PRICE	STYLE NUMBER	LIST PRICE
W" x D" x H"	WGT	"W" Veneer Top Veneer Chassis		"G" HPL High Pressure Laminate Top Veneer Chassis		"M" TFL Thermally Fused Laminate Top Thermally Fused Laminate Chassis	
<b>Left Pedestal</b>							
89 x 24/48 x 30	275	RPC8948CA813W	3805	RPC8948CA813G	3805	"M" Option N/A	
72 x 24/48 x 30	245	RPC7248CA813W	3545	RPC7248CA813G	3545	"M" Option N/A	
66 x 24/48 x 30	225	RPC6648CA813W	3413	RPC6648CA813G	3413	"M" Option N/A	
<b>Right Pedestal</b>							
89 x 24/48 x 30	275	RPC8948CA814W	3805	RPC8948CA814G	3805	"M" Option N/A	
72 x 24/48 x 30	245	RPC7248CA814W	3545	RPC7248CA814G	3545	"M" Option N/A	
66 x 24/48 x 30	225	RPC6648CA814W	3413	RPC6648CA814G	3413	"M" Option N/A	

**2 SELECT A FINISH**

"W" Veneer	"G" HPL	"M" TFL	
WAC	GAC	-	Amber Cherry
WRC	-	-	Caramel Cherry
WIC	GIC	-	Crimson Cherry
WEC	-	-	Ebony Cherry
WHC	GHC	-	Honey Cherry
WOC	GOC	-	KoKo Cherry
WSC	-	-	Scotch Cherry
WEW	GEW	-	Executive Walnut
WRW	GRW	-	Gray Luster Walnut
WGW	-	-	Gunstock Walnut
WJW	-	-	Judicial Walnut
WNW	GNW	-	Natural Walnut
WTW	GTW	-	Studio Teak Walnut

**3 SELECT AN EDGE**



**5 OPTIONS**

- DRAWER**
- P6: Modify File/File to Box/Box/File - \$50 per pedestal
  - P33: Wood Drawer Upgrade - \$40 per drawer
- FLUSH CUT**
- FC-B: Flush Unit Both Sides(Facing) for Ganging - \$95
  - FC-L: Flush Unit Left (Facing) for Ganging - \$95
  - FC-R: Flush Unit Right(Facing) for Ganging - \$95
- GROMMETS (NON-STANDARD LOCATION)**
- Provide drawing w/ Grommet Location and Specify Color - \$90 ea.
- Black: TM30-NS
  - Silver: TM31-NS
  - Antique Brass: TM33-NS
- MODESTY**
- M34T: "W" "G" Style Drop Door Tech Modesty - \$125
  - M51: Open Back Modesty with Wire Mgmt Rail - Deduct \$95
- MOLDING**
- DSM2: Delete molding - Deduct \$50
- OPEN PLAN**
- OPB: "W" "G" Style - Modify Unit for Open Plan Application - \$295

**4 SELECT HARDWARE**



Left Pedestal

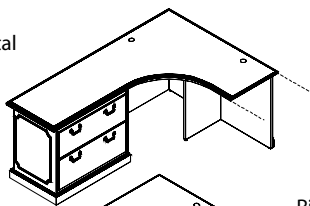

Right Pedestal

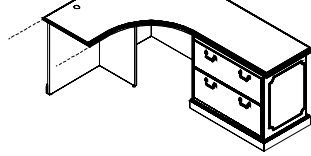

**LATERAL FILE**

**STANDARD FEATURES**

- 2 Standard grommets - matches pull finish or specify black TM30, silver TM31 or antique brass TM33
- Drawer fronts w/ profile edges
- Full extension drawers - locking
- Soft close suspension drawer(s)

**NOTES**

- Unit not designed for open plan use. Select OPB Option for Open Plan application

[CLICK HERE TO VIEW PRODUCT INDEX](#)

**1 SELECT A STYLE**

DIMENSIONS		STYLE NUMBER	LIST PRICE	STYLE NUMBER	LIST PRICE	STYLE NUMBER	LIST PRICE
W" x D" x H"	WGT	"W" Veneer Top Veneer Chassis		"G" HPL High Pressure Laminate Top Veneer Chassis		"M" TFL Thermally Fused Laminate Top Thermally Fused Laminate Chassis	
<b>Left Pedestal</b>							
89 x 24/48 x 30	325	RPC8948CA815W	4068	RPC8948CA815G	4068	"M" Option N/A	
72 x 24/48 x 30	295	RPC7248CA815W	3805	RPC7248CA815G	3805	"M" Option N/A	
66 x 24/48 x 30	275	RPC6648CA815W	3675	RPC6648CA815G	3675	"M" Option N/A	
<b>Right Pedestal</b>							
89 x 24/48 x 30	325	RPC8948CA816W	4068	RPC8948CA816G	4068	"M" Option N/A	
72 x 24/48 x 30	295	RPC7248CA816W	3805	RPC7248CA816G	3805	"M" Option N/A	
66 x 24/48 x 30	275	RPC6648CA816W	3675	RPC6648CA816G	3675	"M" Option N/A	

**2 SELECT A FINISH**

"W" Veneer	"G" HPL	"M" TFL	
WAC	GAC	-	Amber Cherry
WRC	-	-	Caramel Cherry
WIC	GIC	-	Crimson Cherry
WEC	-	-	Ebony Cherry
WHC	GHC	-	Honey Cherry
WOC	GOC	-	KoKo Cherry
WSC	-	-	Scotch Cherry
WEW	GEW	-	Executive Walnut
WRW	GRW	-	Gray Luster Walnut
WGW	-	-	Gunstock Walnut
WJW	-	-	Judicial Walnut
WNW	GNW	-	Natural Walnut
WTW	GTW	-	Studio Teak Walnut

**3 SELECT AN EDGE**



**5 OPTIONS**

- DRAWER**  
- P33: Wood Drawer Upgrade - \$40 per drawer
- FLUSH CUT**  
- FC-B: Flush Unit Both Sides(Facing) for Ganging - \$95  
- FC-L: Flush Unit Left (Facing) for Ganging - \$95  
- FC-R: Flush Unit Right(Facing) for Ganging - \$95
- GROMMETS (NON-STANDARD LOCATION)**  
Provide drawing w/ Grommet Location and Specify Color - \$90 ea.  
- Black: TM30-NS  
- Silver: TM31-NS  
- Antique Brass: TM33-NS
- MODESTY**  
- M34T: "W" "G" Style Drop Door Tech Modesty - \$125  
- M51: Open Back Modesty with Wire Mgmt Rail - Deduct \$95
- MOLDING**  
- DSM2: Delete molding - Deduct \$50
- OPEN PLAN**  
- OPB: "W" "G" Style - Modify Unit for Open Plan Application - \$295

**4 SELECT HARDWARE**



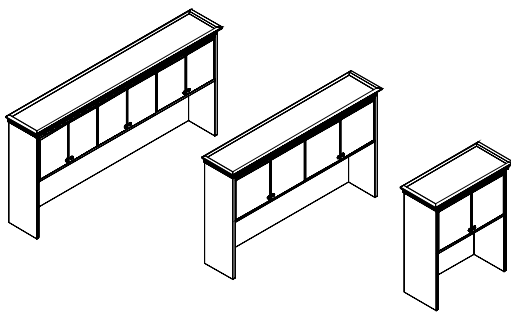

**FREESTANDING - PANEL DOOR**

**STANDARD FEATURES**

- 2.5" Cornice top
- Door fronts w/ profile edges
- Interior cabinet depth 12.5"
- Scalloped edge doors
- Tasklight grommet(s)
- Top profile shaped 3 sides
- Veneer back

- for Open Plan use. Select OPB Option for Open Plan application
- Left pedestal gets right grommet
- Right pedestal gets left grommet

**NOTES**

- Unit has black back panel and is not designed

[CLICK HERE TO VIEW PRODUCT INDEX](#)

**1 SELECT A STYLE**

DIMENSIONS		STYLE NUMBER	LIST PRICE	STYLE NUMBER	LIST PRICE	STYLE NUMBER	LIST PRICE
W" x D" x H"	WGT	"W" Veneer Top Veneer Chassis		"G" HPL High Pressure Laminate Top Veneer Chassis		"M" TFL Thermally Fused Laminate Top Thermally Fused Laminate Chassis	
<b>6 Door / 3 Section</b>							
95 x 15 x 44	315	RPC95440H325W	3659	"G" Option N/A		"M" Option N/A	
89 x 15 x 44	285	RPC89440H325W	3284	"G" Option N/A		"M" Option N/A	
<b>4 Door / 2 Section</b>							
85 x 15 x 44	275	RPC85440H325W	3159	"G" Option N/A		"M" Option N/A	
78 x 15 x 44	255	RPC78440H325W	3034	"G" Option N/A		"M" Option N/A	
72 x 15 x 44	240	RPC72440H325W	2784	"G" Option N/A		"M" Option N/A	
66 x 15 x 44	225	RPC66440H325W	2461	"G" Option N/A		"M" Option N/A	
60 x 15 x 44	210	RPC60440H325W	2647	"G" Option N/A		"M" Option N/A	
<b>2 Door / 1 Section</b>							
37 x 15 x 44	120	RPC37440H325W	1784	"G" Option N/A		"M" Option N/A	
31 x 15 x 44	105	RPC31440H325W	1761	"G" Option N/A		"M" Option N/A	

**2 SELECT A FINISH**

"W" Veneer	"G" HPL	"M" TFL	Finish
WAC	-	-	Amber Cherry
WRC	-	-	Caramel Cherry
WIC	-	-	Crimson Cherry
WEC	-	-	Ebony Cherry
WHC	-	-	Honey Cherry
WOC	-	-	KoKo Cherry
WSC	-	-	Scotch Cherry
WEW	-	-	Executive Walnut
WRW	GRW	-	Gray Luster Walnut
WGW	-	-	Gunstock Walnut
WJW	-	-	Judicial Walnut
WNW	-	-	Natural Walnut
WTW	-	-	Studio Teak Walnut

**3 SELECT AN EDGE**

Edge Profile  
Option Not Available

**5 OPTIONS**

**DOOR**

- D2: Door Lock - \$95 per Door
- D6: Delete Doors - n/c
- D9SC: Soft Close Door Hinges - \$15 per Door

**FLUSH CUT**

- FC-B: Flush Unit Both Sides(Facing) for Ganging - \$95
- FC-L: Flush Unit Left (Facing) for Ganging - \$95
- FC-R: Flush Unit Right(Facing) for Ganging - \$95

**GROMMETS (VERTICAL SURFACE)**

- Standard Location - \$45 ea.
- Black Plastic Vertical Surface: TM50-C (Bottom Center)
- Non-Standard Location - \$90 ea.
- Black Plastic Vertical Surface: TM50-NS

**OPEN PLAN**

- OPB: "W" "G" Style - Modify Unit for Open Plan Application - \$395

**TASK LIGHT**

- LT-LED24: 24" LED Tasklight - \$90
- LT-LED48: 48" LED Tasklight - \$165
- LT-LED60: 60" LED Tasklight - \$180
- LC22: 20" LT-LED Tasklight Linking Cable - \$20

**4 SELECT HARDWARE**



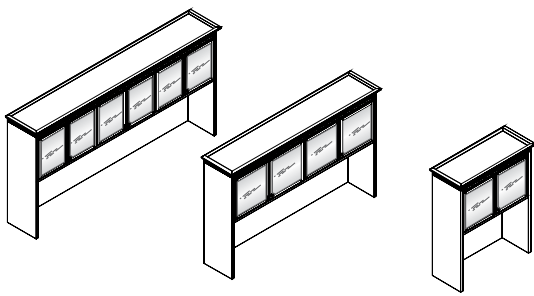

**FREESTANDING WOOD FRAME DOOR W/ STANDARD GLASS**

**STANDARD FEATURES**

- 2.5" Cornice top
- Frame door with beveled glass inserts
- Interior cabinet depth 12.5"
- Scalloped edge doors
- Tasklight grommet(s)
- Top profile shaped 3 sides
- Veneer back

for Open Plan use. Select OPB Option for Open Plan application

**NOTES**

- Unit has black back panel and is not designed

[CLICK HERE TO VIEW PRODUCT INDEX](#)

**1 SELECT A STYLE**

DIMENSIONS		STYLE NUMBER	LIST PRICE	STYLE NUMBER	LIST PRICE	STYLE NUMBER	LIST PRICE
W" x D" x H"	WGT	"W" Veneer Veneer Top Veneer Chassis		"G" HPL High Pressure Laminate Top Veneer Chassis		"M" TFL Thermally Fused Laminate Top Thermally Fused Laminate Chassis	
<b>6 Door / 3 Section</b>							
95 x 15 x 44	315	RPC95440H447W	4783	"G" Option N/A		"M" Option N/A	
89 x 15 x 44	285	RPC89440H447W	4408	"G" Option N/A		"M" Option N/A	
<b>4 Door / 2 Section</b>							
85 x 15 x 44	275	RPC85440H447W	3907	"G" Option N/A		"M" Option N/A	
78 x 15 x 44	255	RPC78440H447W	3783	"G" Option N/A		"M" Option N/A	
72 x 15 x 44	240	RPC72440H447W	3534	"G" Option N/A		"M" Option N/A	
66 x 15 x 44	225	RPC66440H447W	3456	"G" Option N/A		"M" Option N/A	
60 x 15 x 44	210	RPC60440H447W	3396	"G" Option N/A		"M" Option N/A	
<b>2 Door / 1 Section</b>							
37 x 15 x 44	120	RPC37440H447W	2159	"G" Option N/A		"M" Option N/A	
31 x 15 x 44	105	RPC31440H447W	2136	"G" Option N/A		"M" Option N/A	

**2 SELECT A FINISH**

"W" Veneer	"G" HPL	"M" TFL	Finish
WAC	-	-	Amber Cherry
WRC	-	-	Caramel Cherry
WIC	-	-	Crimson Cherry
WEC	-	-	Ebony Cherry
WHC	-	-	Honey Cherry
WOC	-	-	KoKo Cherry
WSC	-	-	Scotch Cherry
WEW	-	-	Executive Walnut
WRW	GRW	-	Gray Luster Walnut
WGW	-	-	Gunstock Walnut
WJW	-	-	Judicial Walnut
WNW	-	-	Natural Walnut
WTW	-	-	Studio Teak Walnut

**3 SELECT AN EDGE**

Edge Profile  
Option Not Available

**5 OPTIONS**

**DOOR**

- D2: Door Lock - \$95 per Door Set
- D9SC: Soft Close Door Hinges - \$15 per Door
- D35: Wood panel insert - \$30 each

**FLUSH CUT**

- FC-B: Flush Unit Both Sides(Facing) for Ganging - \$95
- FC-L: Flush Unit Left (Facing) for Ganging - \$95
- FC-R: Flush Unit Right(Facing) for Ganging - \$95

**GROMMETS (VERTICAL SURFACE)**

- Standard Location - \$45 ea.
- Black Plastic Vertical Surface: TM50-C (Bottom Center)
- Non-Standard Location - \$90 ea.
- Black Plastic Vertical Surface: TM50-NS

**INTERIOR CABINET LIGHTING**

- LEDPK starter kit includes Infeed, 1 Puck Interior Light and the ability to daisy chain up to 6 total Puck Lights
- LEDPK: LED Puck Starter Kit - \$295
- PK: 1 LED Interior Light - \$125

**OPEN PLAN**

- OPB: "W" "G" Style - Modify Unit for Open Plan Application - \$395

**TASK LIGHT**

- LT-LED24: 24" LED Tasklight - \$90
- LT-LED48: 48" LED Tasklight - \$165
- LT-LED60: 60" LED Tasklight - \$180
- LC22: 20" LT-LED Tasklight Linking Cable - \$20

**4 SELECT HARDWARE**



OVERHEAD CONSOLES W/ PAPER ORGANIZER

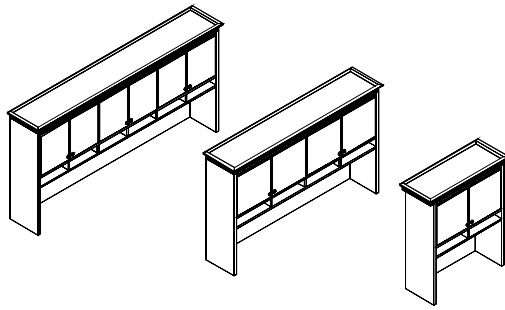

**FREESTANDING CONSOLE - PANEL DOOR W/ PAPER ORGANIZER**

**STANDARD FEATURES**

- 2.5" Cornice top
- Interior cabinet depth 12.5"
- Scalloped edge doors
- Tasklight grommet(s)
- Top profile shaped 3 sides
- Veneer back

Plan application

**NOTES**

- Unit has black back panel and is not designed for Open Plan use. Select OPB Option for Open

[CLICK HERE TO VIEW PRODUCT INDEX](#)

**1 SELECT A STYLE**

DIMENSIONS		STYLE NUMBER	LIST PRICE	STYLE NUMBER	LIST PRICE	STYLE NUMBER	LIST PRICE
W" x D" x H"	WGT	"W" Veneer Top Veneer Chassis		"G" HPL High Pressure Laminate Top Veneer Chassis		"M" TFL Thermally Fused Laminate Top Thermally Fused Laminate Chassis	
<b>6 Door / 3 Section</b>							
95 x 15 x 44	315	RPC9544OH326W	4158	"G" Option N/A		"M" Option N/A	
89 x 15 x 44	285	RPC8944OH326W	3783	"G" Option N/A		"M" Option N/A	
<b>4 Door / 2 Section</b>							
85 x 15 x 44	275	RPC8544OH326W	3534	"G" Option N/A		"M" Option N/A	
78 x 15 x 44	255	RPC7844OH326W	3408	"G" Option N/A		"M" Option N/A	
72 x 15 x 44	240	RPC7244OH326W	3159	"G" Option N/A		"M" Option N/A	
66 x 15 x 44	225	RPC6644OH326W	3082	"G" Option N/A		"M" Option N/A	
60 x 15 x 44	210	RPC6044OH326W	3022	"G" Option N/A		"M" Option N/A	
<b>2 Door / 1 Section</b>							
37 x 15 x 44	120	RPC3744OH326W	2535	"G" Option N/A		"M" Option N/A	
31 x 15 x 44	105	RPC3144OH326W	2011	"G" Option N/A		"M" Option N/A	

**2 SELECT A FINISH**

"W" Veneer	"G" HPL	"M" TFL	Finish
WAC	-	-	Amber Cherry
WRC	-	-	Caramel Cherry
WIC	-	-	Crimson Cherry
WEC	-	-	Ebony Cherry
WHC	-	-	Honey Cherry
WOC	-	-	KoKo Cherry
WSC	-	-	Scotch Cherry
WEW	-	-	Executive Walnut
WRW	GRW	-	Gray Luster Walnut
WGW	-	-	Gunstock Walnut
WJW	-	-	Judicial Walnut
WNW	-	-	Natural Walnut
WTW	-	-	Studio Teak Walnut

**3 SELECT AN EDGE**

Edge Profile  
Option Not Available

**5 OPTIONS**

**DOOR**

- D2: Door Lock - \$95 per Door
- D6: Delete Doors - n/c
- D95C: Soft Close Door Hinges - \$15 per Door

**FLUSH CUT**

- FC-B: Flush Unit Both Sides(Facing) for Ganging - \$95
- FC-L: Flush Unit Left (Facing) for Ganging - \$95
- FC-R: Flush Unit Right(Facing) for Ganging - \$95

**GROMMETS (VERTICAL SURFACE)**

- Standard Location - \$45 ea.
- Black Plastic Vertical Surface: TM50-C (Bottom Center)
- Non-Standard Location - \$90 ea.
- Black Plastic Vertical Surface: TM50-NS

**OPEN PLAN**

- OPB: "W" "G" Style - Modify Unit for Open Plan Application - \$395

**TASK LIGHT**

- LT-LED24: 24" LED Tasklight - \$90
- LT-LED48: 48" LED Tasklight - \$165
- LT-LED60: 60" LED Tasklight - \$180
- LC22: 20" LT-LED Tasklight Linking Cable - \$20

**4 SELECT HARDWARE**



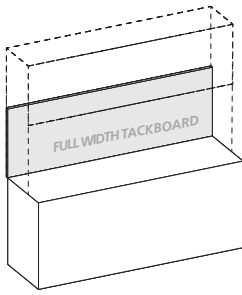

**FULL WIDTH TACKBOARDS**

**STANDARD FEATURES**

- Constructed of .5" thick fiberboard
- Fabric is precisely aligned and fitted to the tackboard
- Adhered to the rigid hardboard with staples

**NOTES**

- Fabric Tack Panels are raised 3" from bottom edge when TM50 grommet is ordered.

PRODUCT WIDTH	DIMENSIONS	SKU	COM	1	2	3	4	5	6	7	8	9	10	11/L1	12	13/L2
95	91 x .5 x 21	FTOC9121	364	465	516	567	618	669	720	771	822	873	924	975	1,026	1,128
89	85 x .5 x 21	FTOC8521	344	435	483	531	579	627	675	723	771	819	867	915	963	1,059
85	81 x .5 x 21	FTOC8121	323	415	461	507	553	599	645	691	737	783	829	875	921	1,013
78	74 x .5 x 21	FTOC7421	297	380	423	466	509	552	595	638	681	724	767	810	853	939
72	68 x .5 x 21	FTOC6821	271	350	390	430	470	510	550	590	630	670	710	750	790	870
66	62 x .5 x 21	FTOC6221	246	320	356	392	428	464	500	536	572	608	644	680	716	788
60	56 x .5 x 21	FTOC5621	225	290	322	354	386	418	450	482	514	546	578	610	642	706
49	45 x .5 x 21	FTOC4521	180	235	262	289	316	343	370	397	424	451	478	505	532	586
37	33 x .5 x 21	FTOC3321	136	175	195	215	235	255	275	295	315	335	355	375	395	435
31	27 x .5 x 21	FTOC2721	108	145	162	179	196	213	230	247	264	281	298	315	332	366

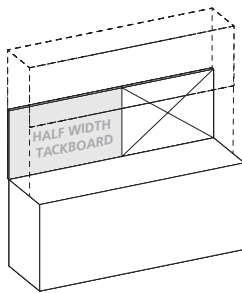

**OVERHEAD TACKBOARDS**

**HALF WIDTH TACKBOARDS**

**STANDARD FEATURES**

- Constructed of .5" thick fiberboard
- Fabric is precisely aligned and fitted to the tackboard
- Adhered to the rigid hardboard with staples

**Notes**

- Half width tackboards can be specified and combined with a Veneer Panel, Marker Board, Slat Wall or Glass Board. See "Half Width" items under product width.
- Must specify Right or left facing tackboard
- Fabric Tack Panels are raised 3" from bottom edge when TM50 grommet is ordered.

PRODUCT WIDTH	DIMENSIONS	SKU	COM	1	2	3	4	5	6	7	8	9	10	11/L1	12	13/L2
95 Half Width	45.5 x .5 x 21	FTOC4521	182	233	258	284	309	335	360	386	411	437	462	488	513	564
89 Half Width	42.5 x .5 x 21	FTOC4221	172	218	242	266	290	314	338	362	386	410	434	458	482	530
85 Half Width	40.5 x .5 x 21	FTOC4021	162	208	231	254	277	300	323	346	369	392	415	438	461	507
78 Half Width	37 x .5 x 21	FTOC3721	149	190	212	233	255	276	298	319	341	362	384	405	427	470
72 Half Width	34 x .5 x 21	FTOC3421	136	175	195	215	235	255	275	295	315	335	355	375	395	435
66 Half Width	31 x .5 x 21	FTOC3121	123	160	178	196	214	232	250	268	286	304	322	340	358	394

**OVERHEAD DRY MARKER BOARD**

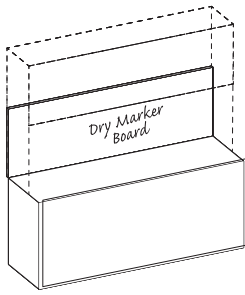

**FULL WIDTH DRY MARKER BOARD**

**STANDARD FEATURES**

- Dry marker panel has edge trim molding
- Standard magnetic surface

PRODUCT WIDTH	PANEL DIMENSION	SKU	LIST
95	91 x .5 x 21	DMOC9121	1092
89	85 x .5 x 21	DMOC8521	1020
85	81 x .5 x 21	DMOC8121	972
78	74 x .5 x 21	DMOC7421	888
72	68 x .5 x 21	DMOC6821	816
66	62 x .5 x 21	DMOC6221	744
60	56 x .5 x 21	DMOC5621	672
49	45 x .5 x 21	DMOC4521	564
37	33 x .5 x 21	DMOC3321	420
31	27 x .5 x 21	DMOC2721	324

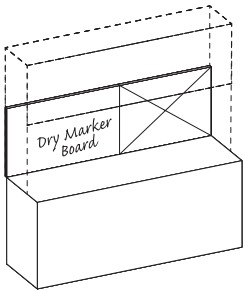

**OVERHEAD DRY MARKER BOARD**

**HALF WIDTH DRY MARKER BOARD**

**STANDARD FEATURES**

- Dry marker panel has edge trim molding
- Standard magnetic surface

**Notes**

- Half width dry marker boards can be specified and combined with a Tackboard, Veneer Panel, Slat Wall or Glass Board. See "Half Width" items under product width.
- Must specify Right or left facing dry marker board

PRODUCT WIDTH	PANEL DIMENSION	SKU	LIST
95 Half Width	45.5 x .5 x 21	DMOC4521	534
89 Half Width	42.5 x .5 x 21	DMOC4221	498
85 Half Width	40.5 x .5 x 21	DMOC4021	474
78 Half Width	37 x .5 x 21	DMOC3721	432
72 Half Width	34 x .5 x 21	DMOC3421	420
66 Half Width	31 x .5 x 21	DMOC3121	360



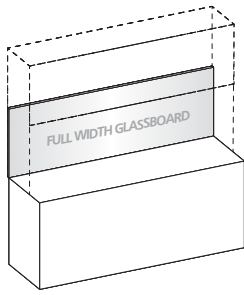

**FULL WIDTH GLASSBOARD**

**STANDARD FEATURES**

- 4 mm tempered glass
- Use glass cleaner or alcohol to clean
- Standard dry erase markers may be used
- Earth magnets are required to hold items securely in place
- Hung with Z-Strip mounting system

PRODUCT WIDTH	PANEL DIMENSION	SKU	LIST
95	91 x .5 x 21	GBOC9121	2290
89	85 x .5 x 21	GBOC8521	2150
85	81 x .5 x 21	GBOC8121	2056
78	74 x .5 x 21	GBOC7421	1893
72	68 x .5 x 21	GBOC6821	1752
66	62 x .5 x 21	GBOC6221	1612
60	56 x .5 x 21	GBOC5621	1472
49	45 x .5 x 21	GBOC4521	1215
37	33 x .5 x 21	GBOC3321	935
31	27 x .5 x 21	GBOC2721	794

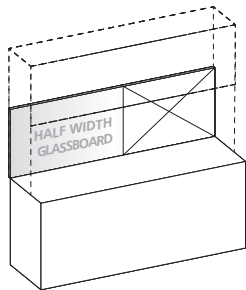

**OVERHEAD GLASSBOARD**

**HALF WIDTH GLASSBOARD**

**STANDARD FEATURES**

- 4 mm tempered glass
- Use glass cleaner or alcohol to clean
- Standard dry erase markers may be used
- Earth magnets are required to hold items securely in place
- Hung with Z-Strip mounting system

**Notes**

- Half width glassboards can be specified and combined with a Tackboard, Veneer panel, Marker Board or Slat Wall. See "Half Width" items under product width.
- Must specify Right or left facing glassboard

PRODUCT WIDTH	PANEL DIMENSION	SKU	LIST
95 Half Width	45.5 x .5 x 21	GBOC4521	1203
89 Half Width	42.5 x .5 x 21	GBOC4221	1133
85 Half Width	40.5 x .5 x 21	GBOC4021	1086
78 Half Width	37 x .5 x 21	GBOC3721	947
72 Half Width	34 x .5 x 21	GBOC3421	935
66 Half Width	31 x .5 x 21	GBOC3121	864

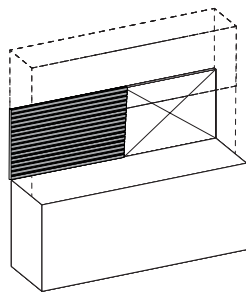

**HALF WIDTH SLAT WALL**

**STANDARD FEATURES**

- Available in silver or black
- For use on 42"/43" height consoles
- Specify Left or Right Position

**Notes**

- Half width slat walls can be specified and combined with a Tackboard, Veneer panel, Marker Board or Glassboard. See "Half Width" items under product width.
- Must specify Right or left facing slat wall

PRODUCT WIDTH	PANEL DIMENSION	SKU	LIST
95 Half Width	45.5 x .5 x 21	SWOC4521	445
89 Half Width	42.5 x .5 x 21	SWOC4221	415
85 Half Width	40.5 x .5 x 21	SWOC4021	395
78 Half Width	37 x .5 x 21	SWOC3721	360
72 Half Width	34 x .5 x 21	SWOC3421	330
66 Half Width	31 x .5 x 21	SWOC3121	300

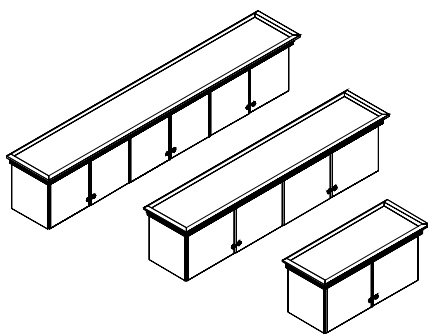

**PANEL DOORS - 6/4/2 DOOR**

**STANDARD FEATURES**

- 2.5" Cornice top
- Door fronts w/ profile edges
- Interior cabinet depth 12.5"
- Mounting wall rail included
- Scalloped edge doors
- Tasklight concealment apron rail
- Top profile shaped 3 sides
- Veneer interior

**NOTES**

- Proper installation is critical to ensure safety from possible falling cabinets. The factory assumes no liability for damage or injury from the following: Installation into non-load bearing walls. Improper fasteners used in installation. Overloading of cabinets resulting in failures of wall and surrounding structures, fasteners, or cabinet construction. Misuse of cabinets for intended purposes.
- Unit has black back panel and is not designed for Open Plan use. Select OPB Option for Open Plan application

[CLICK HERE TO VIEW PRODUCT INDEX](#)

**1 SELECT A STYLE**

DIMENSIONS		STYLE NUMBER	LIST PRICE	STYLE NUMBER	LIST PRICE	STYLE NUMBER	LIST PRICE
W" x D" x H"	WGT	"W" Veneer Veneer Top Veneer Chassis		"G" HPL High Pressure Laminate Top Veneer Chassis		"M" TFL Thermally Fused Laminate Top Thermally Fused Laminate Chassis	
<b>6 Door / 3 Section</b>							
95 x 15 x 20	200	RPC9520WH330W	3596	"G" Option N/A		"M" Option N/A	
89 x 15 x 20	185	RPC8920WH330W	3471	"G" Option N/A		"M" Option N/A	
<b>4 Door / 2 Section</b>							
85 x 15 x 20	175	RPC8520WH330W	3067	"G" Option N/A		"M" Option N/A	
78 x 15 x 20	165	RPC7820WH330W	2940	"G" Option N/A		"M" Option N/A	
72 x 15 x 20	155	RPC7220WH330W	2816	"G" Option N/A		"M" Option N/A	
66 x 15 x 20	140	RPC6620WH330W	2638	"G" Option N/A		"M" Option N/A	
60 x 15 x 20	130	RPC6020WH330W	2406	"G" Option N/A		"M" Option N/A	
49 x 15 x 20	115	RPC4920WH330W	2132	"G" Option N/A		"M" Option N/A	
<b>2 Door</b>							
37 x 15 x 20	75	RPC3720WH330W	1645	"G" Option N/A		"M" Option N/A	
31 x 15 x 20	65	RPC3120WH330W	1615	"G" Option N/A		"M" Option N/A	

**2 SELECT A FINISH**

"W" Veneer	"G" HPL	"M" TFL	
WAC	-	-	Amber Cherry
WRC	-	-	Caramel Cherry
WIC	-	-	Crimson Cherry
WEC	-	-	Ebony Cherry
WHC	-	-	Honey Cherry
WOC	-	-	KoKo Cherry
WSC	-	-	Scotch Cherry
WEW	-	-	Executive Walnut
WRW	GRW	-	Gray Luster Walnut
WGW	-	-	Gunstock Walnut
WJW	-	-	Judicial Walnut
WNW	-	-	Natural Walnut
WTW	-	-	Studio Teak Walnut

**3 SELECT AN EDGE**

Edge Profile  
Option Not Available

**5 OPTIONS**

**DOOR**

- D2: Door Lock - \$95 per Door
- D6: Delete Doors - n/c
- D9SC: Soft Close Door Hinges - \$15 per Door

**FLUSH CUT**

- FC-B: Flush Unit Both Sides(Facing) for Ganging - \$95
- FC-L: Flush Unit Left (Facing) for Ganging - \$95
- FC-R: Flush Unit Right(Facing) for Ganging - \$95

**TASK LIGHT**

- LT-LED24: 24" LED Tasklight - \$90
- LT-LED48: 48" LED Tasklight - \$165
- LT-LED60: 60" LED Tasklight - \$180
- LC22: 20" LT-LED Tasklight Linking Cable - \$20
- WAR-D: Delete Tasklight Concealment Apron Rail - Deduct \$175

**4 SELECT HARDWARE**



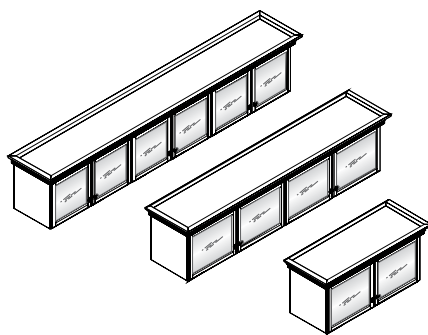

**WOOD FRAME DOOR W/ GLASS - 6/4/2 DOOR**

**STANDARD FEATURES**

- 2.5" Cornice top
- Hardwood frame door w/ beveled glass insert
- Interior cabinet depth 12.5"
- Mounting wall rail included
- Panel Door w/ Profile Edge
- Tasklight concealment apron rail
- Top profile shaped 3 sides
- Veneer interior

possible falling cabinets. The factory assumes no liability for damage or injury from the following: Installation into non-load bearing walls. Improper fasteners used in installation. Overloading of cabinets resulting in failures of wall and surrounding structures, fasteners, or cabinet construction. Misuse of cabinets for intended purposes.

- Unit has black back panel and is not designed for Open Plan use. Select OPB Option for Open Plan application

**NOTES**

- Proper installation is critical to ensure safety from

[CLICK HERE TO VIEW PRODUCT INDEX](#)

**1 SELECT A STYLE**

DIMENSIONS		STYLE NUMBER	LIST PRICE	STYLE NUMBER	LIST PRICE	STYLE NUMBER	LIST PRICE
W" x D" x H"	WGT	"W" Veneer Veneer Top Veneer Chassis		"G" HPL High Pressure Laminate Top Veneer Chassis		"M" TFL Thermally Fused Laminate Top Thermally Fused Laminate Chassis	
<b>6 Door / 3 Section</b>							
95 x 15 x 20	200	RPC9520WH329W	4619	"G" Option N/A		"M" Option N/A	
89 x 15 x 20	185	RPC8920WH329W	4494	"G" Option N/A		"M" Option N/A	
<b>4 Door / 2 Section</b>							
85 x 15 x 20	175	RPC8520WH329W	3720	"G" Option N/A		"M" Option N/A	
78 x 15 x 20	165	RPC7820WH329W	3596	"G" Option N/A		"M" Option N/A	
72 x 15 x 20	155	RPC7220WH329W	3471	"G" Option N/A		"M" Option N/A	
66 x 15 x 20	140	RPC6620WH329W	3298	"G" Option N/A		"M" Option N/A	
60 x 15 x 20	130	RPC6020WH329W	3067	"G" Option N/A		"M" Option N/A	
49 x 15 x 20	115	RPC4920WH329W	2786	"G" Option N/A		"M" Option N/A	
<b>2 Door</b>							
37 x 15 x 20	75	RPC3720WH329W	1959	"G" Option N/A		"M" Option N/A	
31 x 15 x 20	65	RPC3120WH329W	1930	"G" Option N/A		"M" Option N/A	

**2 SELECT A FINISH**

"W" Veneer	"G" HPL	"M" TFL	Finish
WAC	-	-	Amber Cherry
WRC	-	-	Caramel Cherry
WIC	-	-	Crimson Cherry
WEC	-	-	Ebony Cherry
WHC	-	-	Honey Cherry
WOC	-	-	KoKo Cherry
WSC	-	-	Scotch Cherry
WEW	-	-	Executive Walnut
WRW	GRW	-	Gray Luster Walnut
WGW	-	-	Gunstock Walnut
WJW	-	-	Judicial Walnut
WNW	-	-	Natural Walnut
WTW	-	-	Studio Teak Walnut

**3 SELECT AN EDGE**

Edge Profile  
Option Not Available

**5 OPTIONS**

- DOOR**
- D2: Door Lock - \$95 per Door Set
  - D9SC: Soft Close Door Hinges - \$15 per Door
  - D35: Replace glass panel insert with veneer panel insert - \$30 per door
- FLUSH CUT**
- FC-B: Flush Unit Both Sides(Facing) for Ganging - \$95
  - FC-L: Flush Unit Left (Facing) for Ganging - \$95
  - FC-R: Flush Unit Right(Facing) for Ganging - \$95
- INTERIOR CABINET LIGHTING**
- LEDPK starter kit includes Infeed, 1 Puck Interior Light and the ability to daisy chain up to 6 total Puck Lights
- LEDPK: LED Puck Starter Kit - \$295
  - PK: 1 LED Interior Light - \$125
- TASK LIGHT**
- LT-LED24: 24" LED Tasklight - \$90
  - LT-LED48: 48" LED Tasklight - \$165
  - LT-LED60: 60" LED Tasklight - \$180
  - LC22: 20" LT-LED Tasklight Linking Cable - \$20
  - WAR-D: Delete Tasklight Concealment Apron Rail - Deduct \$175

**4 SELECT HARDWARE**



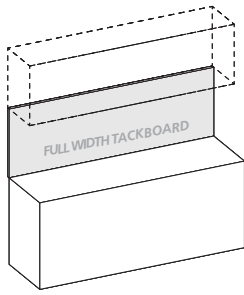

**FULL WIDTH TACKBOARDS**

**STANDARD FEATURES**

- Constructed of .5" thick fiberboard
- Fabric is precisely aligned and fitted to the tackboard
- Adhered to the rigid hardboard with staples

PRODUCT WIDTH	PANEL DIMENSION	SKU	COM	1	2	3	4	5	6	7	8	9	10	11/L1	12	13/L2
95	93 x .75 x 24	FTWH9324	447	558	609	660	711	762	813	864	915	966	1,017	1,068	1,119	1,221
89	87 x .75 x 24	FTWH8724	431	522	570	618	666	714	762	810	858	906	954	1,002	1,050	1,146
85	83 x .75 x 24	FTWH8324	406	498	544	590	636	682	728	774	820	866	912	958	1,004	1,096
78	76 x .75 x 24	FTWH7624	373	456	499	542	585	628	671	714	757	800	843	886	929	1,015
72	70 x .75 x 24	FTWH7024	341	420	460	500	540	580	620	660	700	740	780	820	860	940
66	64 x .75 x 24	FTWH6424	310	384	420	456	492	528	564	600	636	672	708	744	780	852
60	58 x .75 x 24	FTWH5824	283	348	380	412	444	476	508	540	572	604	636	668	700	764
49	47 x .75 x 24	FTWH4724	227	282	309	336	363	390	417	444	471	498	525	552	579	633
37	35 x .75 x 24	FTWH3524	169	210	230	250	270	290	310	330	350	370	390	410	430	470
31	29 x .75 x 24	FTWH2924	137	174	191	208	225	242	259	276	293	310	327	344	361	395

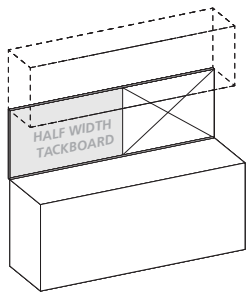

**WALL HUNG TACKBOARDS**

**HALF WIDTH TACKBOARDS**

**STANDARD FEATURES**

- Constructed of .5" thick fiberboard
- Fabric is precisely aligned and fitted to the tackboard
- Adhered to the rigid hardboard with staples

**Notes**

- Half width tackboards can be specified and combined with a Veneer Panel, Marker Board, Slat Wall or Glass Board. See "Half Width" items under product width.
- Must specify Right or left facing tackboard

PRODUCT WIDTH	PANEL DIMENSION	SKU	COM	1	2	3	4	5	6	7	8	9	10	11/L1	12	13/L2
95 Half Width	46.5 x .75 x 24	FTWH4624	224	279	305	330	356	381	407	432	458	483	509	534	560	611
89 Half Width	43.5 x .75 x 24	FTWH4324	216	261	285	309	333	357	381	405	429	453	477	501	525	573
85 Half Width	41.5 x .75 x 24	FTWH4124	203	249	272	295	318	341	364	387	410	433	456	479	502	548
78 Half Width	38 x .75 x 24	FTWH3824	187	228	250	271	293	314	336	357	379	400	422	443	465	508
72 Half Width	35 x .75 x 24	FTWH3524	171	210	230	250	270	290	310	330	350	370	390	410	430	470
66 Half Width	32 x .75 x 24	FTWH3224	155	192	210	228	246	264	282	300	318	336	354	372	390	426

**WALL HUNG DRY MARKER BOARD**

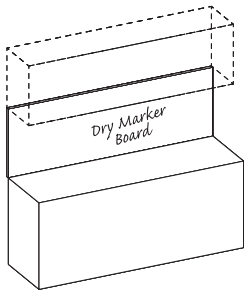

**FULL WIDTH DRY MARKER BOARD**

**STANDARD FEATURES**

- Dry marker panel has edge trim molding
- Standard magnetic surface

PRODUCT WIDTH	PANEL DIMENSION	SKU	LIST
95	93 x .75 x 24	DMWH9324	1116
89	87 x .75 x 24	DMWH8724	1044
85	83 x .75 x 24	DMWH8324	984
78	76 x .5 x 24	DMWH7624	912
72	70 x .75 x 24	DMWH7024	840
66	64 x .75 x 24	DMWH6424	768
60	58 x .75 x 24	DMWH5824	696
49	47 x .75 x 24	DMWH4724	564
37	35 x .75 x 24	DMWH3524	420
31	29 x .75 x 24	DMWH2924	348

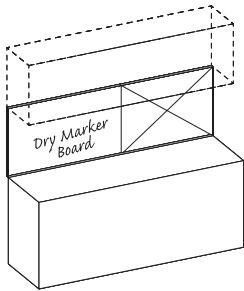

**WALL HUNG DRY MARKER BOARD**

**HALF WIDTH DRY MARKER BOARD**

**STANDARD FEATURES**

- Dry marker panel has edge trim molding
- Standard magnetic surface

**Notes**

- Half width dry marker boards can be specified and combined with a Tackboard, Veneer Panel, Slat Wall or Glass Board. See "Half Width" items under product width.
- Must specify Right or left facing dry marker board

PRODUCT WIDTH	PANEL DIMENSION	SKU	LIST
95 Half Width	46.5 x .75 x 24	DMWH4624	558
89 Half Width	43.5 x .75 x 24	DMWH4324	522
85 Half Width	41.5 x .75 x 24	DMWH4124	498
78 Half Width	38 x .75 x 24	DMWH3824	456
72 Half Width	35 x .75 x 24	DMWH3524	420
66 Half Width	32 x .75 x 24	DMWH3224	384

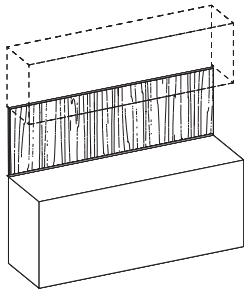

**FULL WIDTH VENEER PANEL**

**STANDARD FEATURES**

- Can be used with or without overhead cabinet.
- Required for other accessory panels.
- Veneer edges.
- Vertical wire channels on back for task light cords.
- Steel mounting wall channel is recessed for flush mounting.

PRODUCT WIDTH	PANEL DIMENSION	SKU	LIST
95	93 x .75 x 24	VPWH9324	930
89	87 x .75 x 24	VPWH8724	870
85	83 x .75 x 24	VPWH8324	820
78	76 x .75 x 24	VPWH7624	760
72	70 x .75 x 24	VPWH7024	700
66	64 x .75 x 24	VPWH6424	640
60	58 x .75 x 24	VPWH5824	580
49	47 x .75 x 24	VPWH4724	470
37	35 x .75 x 24	VPWH3524	350
31	29 x .75 x 24	VPWH2924	290

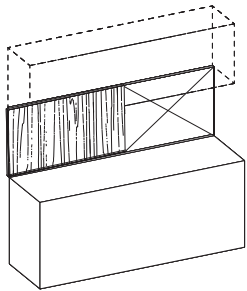

**WALL HUNG VENEER PANEL**

**HALF WIDTH VENEER PANEL**

**STANDARD FEATURES**

- Can be used with or without overhead cabinet.
- Required for other accessory panels.
- Veneer edges.
- Vertical wire channels on back for task light cords.
- Steel mounting wall channel is recessed for flush mounting.

**Notes**

- Half width veneer panels can be specified and combined with a Tackboard, Marker Board, Slat Wall or Glass Board. See "Half Width" items under product width.
- Must specify Right or left facing veneer panel

PRODUCT WIDTH	PANEL DIMENSION	SKU	LIST
95 Half Width	46.5 x .75 x 24	VPWH4624	465
89 Half Width	43.5 x .75 x 24	VPWH4324	435
85 Half Width	41.5 x .75 x 24	VPWH4124	415
78 Half Width	38 x .75 x 24	VPWH3824	380
72 Half Width	35 x .75 x 24	VPWH3524	350
66 Half Width	32 x .75 x 24	VPWH3224	320

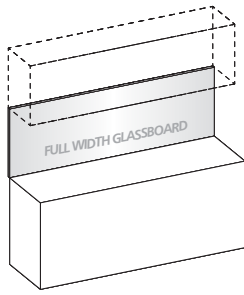

**FULL WIDTH TACKBOARDS**

**STANDARD FEATURES**

- 4 mm tempered glass
- Use glass cleaner or alcohol to clean
- Standard dry erase markers may be used
- Earth magnets are required to hold items securely in place
- Hung with Z-Strip mounting system

PRODUCT WIDTH	PANEL DIMENSION	SKU	LIST
95	93 x .75 x 24	GBWH9324	2647
89	87 x .75 x 24	GBWH8724	2487
85	83 x .75 x 24	GBWH8324	2380
78	76 x .75 x 24	GBWH7624	2193
72	70 x .75 x 24	GBWH7024	2033
66	64 x .75 x 24	GBWH6424	1873
60	58 x .75 x 24	GBWH5824	1712
49	47 x .75 x 24	GBWH4724	1419
37	35 x .75 x 24	GBWH3524	1098
31	29 x .75 x 24	GBWH2924	938

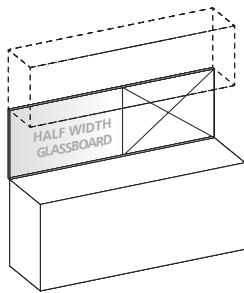

**WALL HUNG GLASSBOARD**

**HALF WIDTH TACKBOARDS**

**STANDARD FEATURES**

- 4 mm tempered glass
- Use glass cleaner or alcohol to clean
- Standard dry erase markers may be used
- Earth magnets are required to hold items securely in place
- Hung with Z-Strip mounting system

**Notes**

- Half width glassboards can be specified and combined with a Tackboard, Veneer panel, Marker Board or Slat Wall. See "Half Width" items under product width.
- Must specify Right or left facing glassboard

PRODUCT WIDTH	PANEL DIMENSION	SKU	LIST
95 Half Width	46.5 x .75 x 24	GBWH4624	1405
89 Half Width	43.5 x .75 x 24	GBWH4324	1325
85 Half Width	41.5 x .75 x 24	GBWH4124	1272
78 Half Width	38 x .75 x 24	GBWH3824	1185
72 Half Width	35 x .75 x 24	GBWH3524	1098
66 Half Width	32 x .75 x 24	GBWH3224	1018



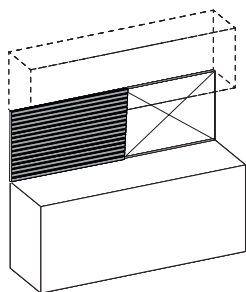

**HALF WIDTH SLAT WALL**

**STANDARD FEATURES**

- Available in silver or black
- For use on 42"/43" height consoles

**Notes**

- Half width slat walls can be specified and combined with a Tackboard, Veneer panel, Marker Board or Glassboard. See "Half Width" items under product width.
- Must specify Right or left facing slat wall

PRODUCT WIDTH	PANEL DIMENSION	SKU	LIST
95 Half Width	46.5 x .75 x 24	SWWH4624	465
89 Half Width	43.5 x .75 x 24	SWWH4324	435
85 Half Width	41.5 x .75 x 24	SWWH4124	415
78 Half Width	38 x .75 x 24	SWWH3824	380
72 Half Width	35 x .75 x 24	SWWH3524	350
66 Half Width	32 x .75 x 24	SWWH3224	320

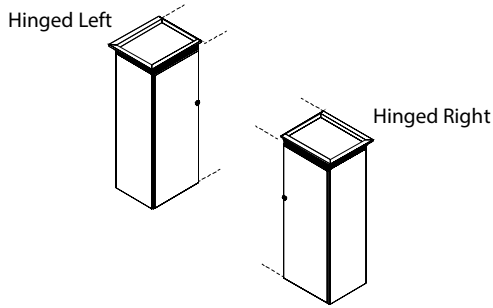

**PANEL DOOR**

**STANDARD FEATURES**

- 2 Black adjustable shelves
- 2.5" Cornice top (flat on ganging end)
- Doors w/ profile edges
- Interior shelf depth 12"

Plan application

**NOTES**

- Door Hinged Left (Flush on right for ganging)
- Door Hinged Right (Flush on Left for Ganging)
- Unit has black back panel and is not designed for Open Plan use. Select OPB Option for Open

[CLICK HERE TO VIEW PRODUCT INDEX](#)

**1 SELECT A STYLE**

DIMENSIONS		STYLE NUMBER	LIST PRICE	STYLE NUMBER	LIST PRICE	STYLE NUMBER	LIST PRICE
W" x D" x H"	WGT	"W" Veneer Top Veneer Chassis		"G" High Pressure Laminate Top HPL Veneer Chassis		"M" Thermally Fused Laminate Top Thermally Fused Laminate Chassis	
<b>Hinged Left</b>							
17.5 x 15 x 44	80	RPC1744OH340W	1719	"G" Option N/A		"M" Option N/A	
14.5 x 15 x 44	75	RPC1444OH340W	1660	"G" Option N/A		"M" Option N/A	
<b>Hinged Right</b>							
17.5 x 15 x 44	80	RPC1744OH341W	1719	"G" Option N/A		"M" Option N/A	
14.5 x 15 x 44	75	RPC1444OH341W	1660	"G" Option N/A		"M" Option N/A	

**2 SELECT A FINISH**

"W" Veneer	"G" HPL	"M" TFL	Finish
WAC	-	-	Amber Cherry
WRC	-	-	Caramel Cherry
WIC	-	-	Crimson Cherry
WEC	-	-	Ebony Cherry
WHC	-	-	Honey Cherry
WOC	-	-	KoKo Cherry
WSC	-	-	Scotch Cherry
WEW	-	-	Executive Walnut
WRW	GRW	-	Gray Luster Walnut
WGW	-	-	Gunstock Walnut
WJW	-	-	Judicial Walnut
WNW	-	-	Natural Walnut
WTW	-	-	Studio Teak Walnut

**3 SELECT AN EDGE**

Edge Profile  
Option Not Available

**5 OPTIONS**

**DOOR**

- D2: Door Lock - \$95 per Door Set
- D6: Delete Doors - n/c
- D9SC: Soft Close Door Hinges - \$15 per Door

**FLUSH CUT**

- FC-B: Flush Unit Both Sides(Facing) for Ganging - \$95

**OPEN PLAN**

- OPB: "W" "G" Style - Modify Unit for Open Plan Application - \$395

**SHELF**

- GS14H: Replace Standard Shelves with Glass Shelves - \$65 per Shelf

**4 SELECT HARDWARE**



**GANGING OVERHEAD EXTENSION TOWERS**

Hinged Left

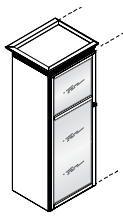

Hinged Right

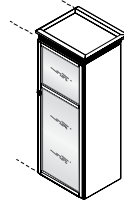

**WOOD FRAME DOOR W/ GLASS**

**STANDARD FEATURES**

- 2 Black adjustable shelves
- 2.5" Cornice top, flat on ganging end
- Doors w/ profile edges
- Hardwood frame doors w/ glass inserts
- Interior shelf depth 12"

**NOTES**

- Door Hinged Left (Flush on right for ganging)
- Door Hinged Right (Flush on Left for Ganging)

[CLICK HERE TO VIEW PRODUCT INDEX](#)

**1 SELECT A STYLE**

DIMENSIONS		STYLE NUMBER	LIST PRICE	STYLE NUMBER	LIST PRICE	STYLE NUMBER	LIST PRICE
W" x D" x H"	WGT	"W" Veneer Top Veneer Chassis		"G" High Pressure Laminate Top Veneer Chassis		"M" Thermally Fused Laminate Top Thermally Fused Laminate Chassis	
<b>Hinged Left</b>							
17.5 x 15 x 44	80	RPC1744OH342W	1969	"G" Option N/A		"M" Option N/A	
14.5 x 15 x 44	75	RPC1444OH342W	1910	"G" Option N/A		"M" Option N/A	
<b>Hinged Right</b>							
17.5 x 15 x 44	80	RPC1744OH343W	1969	"G" Option N/A		"M" Option N/A	
14.5 x 15 x 44	75	RPC1444OH343W	1910	"G" Option N/A		"M" Option N/A	

**2 SELECT A FINISH**

"W" Veneer	"G" HPL	"M" TFL	Finish
WAC	-	-	Amber Cherry
WRC	-	-	Caramel Cherry
WIC	-	-	Crimson Cherry
WEC	-	-	Ebony Cherry
WHC	-	-	Honey Cherry
WOC	-	-	KoKo Cherry
WSC	-	-	Scotch Cherry
WEW	-	-	Executive Walnut
WRW	GRW	-	Gray Luster Walnut
WGW	-	-	Gunstock Walnut
WJW	-	-	Judicial Walnut
WNW	-	-	Natural Walnut
WTW	-	-	Studio Teak Walnut

**3 SELECT AN EDGE**

Edge Profile  
Option Not Available

**5 OPTIONS**

**DOOR**

- D2: Door Lock - \$95 per Door Set
- D9SC: Soft Close Door Hinges - \$15 per Door
- D35: Wood panel insert - \$30 per panel

**FLUSH CUT**

- FC-B: Flush Unit Both Sides(Facing) for Ganging - \$95
- FC-L: Flush Unit Left (Facing) for Ganging - \$95
- FC-R: Flush Unit Right(Facing) for Ganging - \$95

**INTERIOR CABINET LIGHTING**

- LEDPK starter kit includes Infeed, 1 Puck Interior Light and the ability to daisy chain up to 6 total Puck Lights
- LEDPK: LED Puck Starter Kit - \$295
- PK: 1 LED Interior Light - \$125

**OPEN PLAN**

- OPB: "W" "G" Style - Modify Unit for Open Plan Application - \$395

**SHELF**

- GS14H: Replace Standard Shelves with Glass Shelves - \$65 per Shelf

**4 SELECT HARDWARE**



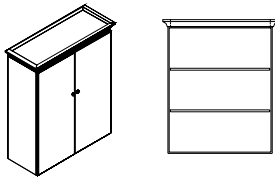

**PANEL DOOR**

**STANDARD FEATURES**

- 2 Adjustable shelves
- 2.5" Cornice top
- Doors w/ profile edges
- Interior shelf depth 12"
- Top profile shaped 3 sides

**NOTES**

- Unit has black back panel and is not designed for Open Plan use. Select OPB Option for Open Plan application

[CLICK HERE TO VIEW PRODUCT INDEX](#)

**1 SELECT A STYLE**

DIMENSIONS		STYLE NUMBER	LIST PRICE	STYLE NUMBER	LIST PRICE	STYLE NUMBER	LIST PRICE
W" x D" x H"	WGT	<b>"W"</b> Veneer Top Veneer Chassis		<b>"G"</b> HPL Top Veneer Chassis		<b>"M"</b> TFL Top Thermally Fused Laminate Chassis	
37 x 15 x 44.5	140	RPC3744OH383W	2005	"G" Option N/A		"M" Option N/A	
31 x 15 x 44.5	130	RPC3144OH383W	1915	"G" Option N/A		"M" Option N/A	

**2 SELECT A FINISH**

"W"	"G"	"M"	
Veneer	HPL	TFL	
WAC	-	-	Amber Cherry
WRC	-	-	Caramel Cherry
WIC	-	-	Crimson Cherry
WEC	-	-	Ebony Cherry
WHC	-	-	Honey Cherry
WOC	-	-	KoKo Cherry
WSC	-	-	Scotch Cherry
WEW	-	-	Executive Walnut
WRW	GRW	-	Gray Luster Walnut
WGW	-	-	Gunstock Walnut
WJW	-	-	Judicial Walnut
WNW	-	-	Natural Walnut
WTW	-	-	Studio Teak Walnut

**3 SELECT AN EDGE**

Edge Profile  
Option Not Available

**5 OPTIONS**

**DOOR**

- D2: Door Lock - \$95 per Door
- D6: Delete Doors - n/c
- D9SC: Soft Close Door Hinges - \$15 per Door

**FLUSH CUT**

- FC-B: Flush Unit Both Sides(Facing) for Ganging - \$95
- FC-L: Flush Unit Left (Facing) for Ganging - \$95
- FC-R: Flush Unit Right(Facing) for Ganging - \$95

**OPEN PLAN**

- OPB: "W" "G" Style - Modify Unit for Open Plan Application - \$395

**SHELF**

- GS14F: Replace Standard Shelves with Glass Shelves - \$85 per Shelf
- S714F: Heavy Duty Lumber 1" Shelves - \$75 per Shelf

**4 SELECT HARDWARE**



**ASSEMBLED OVERHEAD BOOKCASE / HUTCH**

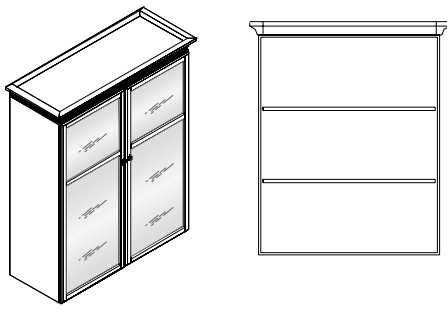

**WOOD FRAME DOOR W/ GLASS INSERT**

**STANDARD FEATURES**

- 2 Adjustable shelves
- 2.5" Cornice top
- Doors w/ profile edges
- Interior shelf depth 12"
- Top profile shaped 3 sides
- Wood frame doors w/ beveled glass inserts

Plan application

**NOTES**

- Unit has black back panel and is not designed for Open Plan use. Select OPB Option for Open

[CLICK HERE TO VIEW PRODUCT INDEX](#)

**1 SELECT A STYLE**

DIMENSIONS		STYLE NUMBER	LIST PRICE	STYLE NUMBER	LIST PRICE	STYLE NUMBER	LIST PRICE
W" x D" x H"	WGT	<b>"W"</b> Veneer Top Veneer Chassis		<b>"G"</b> High Pressure Laminate Top Veneer Chassis		<b>"M"</b> Thermally Fused Laminate Top Thermally Fused Laminate Chassis	
37 x 15 x 44.5	140	RPC3744OH381W	2386	"G" Option N/A		"M" Option N/A	
31 x 15 x 44.5	130	RPC3144OH381W	2296	"G" Option N/A		"M" Option N/A	

**2 SELECT A FINISH**

"W"	"G"	"M"	
Veneer	HPL	TFL	
WAC	-	-	Amber Cherry
WRC	-	-	Caramel Cherry
WIC	-	-	Crimson Cherry
WEC	-	-	Ebony Cherry
WHC	-	-	Honey Cherry
WOC	-	-	KoKo Cherry
WSC	-	-	Scotch Cherry
WEW	-	-	Executive Walnut
WRW	GRW	-	Gray Luster Walnut
WGW	-	-	Gunstock Walnut
WJW	-	-	Judicial Walnut
WNW	-	-	Natural Walnut
WTW	-	-	Studio Teak Walnut

**3 SELECT AN EDGE**

Edge Profile  
Option Not Available

**5 OPTIONS**

**DOOR**

- D2: Door Lock - \$95 per Door
- D9SC: Soft Close Door Hinges - \$15 per Door

**FLUSH CUT**

- FC-B: Flush Unit Both Sides(Facing) for Ganging - \$95
- FC-L: Flush Unit Left (Facing) for Ganging - \$95
- FC-R: Flush Unit Right(Facing) for Ganging - \$95

**INTERIOR CABINET LIGHTING**

- LEDPK starter kit includes Infeed, 1 Puck Interior Light and the ability to daisy chain up to 6 total Puck Lights
- LEDPK: LED Puck Starter Kit - \$295
- PK: 1 LED Interior Light - \$125

**OPEN PLAN**

- OPB: "W" "G" Style - Modify Unit for Open Plan Application - \$395

**SHELF**

- GS14F: Replace Standard Shelves with Glass Shelves - \$85 per Shelf
- S714F: Heavy Duty Lumber 1" Shelves - \$75 per Shelf

**4 SELECT HARDWARE**



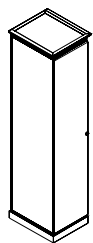

Hinged Left

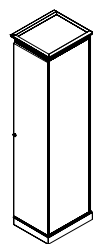
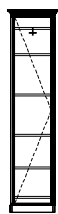

Hinged Right

**WARDROBE / STORAGE**

**STANDARD FEATURES**

- 2.5" Cornice top
- 3 Adjustable shelves / 1 Fixed
- 3.5" Traditional base
- Door fronts w/ profile edges
- Top profile shaped 3 sides
- Wardrobe w/ coat rod & hook

for Open Plan use. Select OPB Option for Open Plan application

**NOTES**

- Adjustable shelves shaded
- Unit has black back panel and is not designed

[CLICK HERE TO VIEW PRODUCT INDEX](#)

**1 SELECT A STYLE**

DIMENSIONS		STYLE NUMBER	LIST PRICE	STYLE NUMBER	LIST PRICE	STYLE NUMBER	LIST PRICE
W" x D" x H"	WGT	<b>"W"</b> Veneer Top Veneer Chassis		<b>"G"</b> HPL High Pressure Laminate Top Veneer Chassis		<b>"M"</b> TFL Thermally Fused Laminate Top Thermally Fused Laminate Chassis	
<b>Hinged Left</b>							
17.75 x 24 x 77	160	RPC1777TW283W	2713	"G" Option N/A		"M" Option N/A	
<b>Hinged Right</b>							
17.75 x 24 x 77	160	RPC1777TW284W	2713	"G" Option N/A		"M" Option N/A	

**2 SELECT A FINISH**

<b>"W"</b> Veneer	<b>"G"</b> HPL	<b>"M"</b> TFL	
WAC	-	-	Amber Cherry
WRC	-	-	Caramel Cherry
WIC	-	-	Crimson Cherry
WEC	-	-	Ebony Cherry
WHC	-	-	Honey Cherry
WOC	-	-	KoKo Cherry
WSC	-	-	Scotch Cherry
WEW	-	-	Executive Walnut
WRW	GRW	-	Gray Luster Walnut
WGW	-	-	Gunstock Walnut
WJW	-	-	Judicial Walnut
WNW	-	-	Natural Walnut
WTW	-	-	Studio Teak Walnut

**3 SELECT AN EDGE**

Edge Profile  
Option Not Available

**5 OPTIONS**

**DOOR**

- D2: Door Lock - \$95 per Door
- D9SC: Soft Close Door Hinges - \$15 per Door

**FLUSH CUT**

- FC-B: Flush Unit Both Sides(Facing) for Ganging - \$95
- FC-L: Flush Unit Left (Facing) for Ganging - \$95
- FC-R: Flush Unit Right(Facing) for Ganging - \$95

**OPEN PLAN**

- OPB: "W" "G" Style - Modify Unit for Open Plan Application - \$395

**4 SELECT HARDWARE**



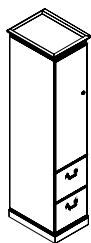

Hinged Left

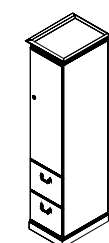
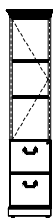

Hinged Right

**STORAGE / FILE/FILE**

**STANDARD FEATURES**

- 2 Adjustable shelves
- 2.5" Cornice top
- 3.5" Traditional base
- Door/Drawer fronts w/ profile edges
- File drawer - Full extension drawers - locking
- Soft close suspension drawer(s)
- Top profile shaped 3 sides

for Open Plan use. Select OPB Option for Open Plan application

**NOTES**

- Unit has black back panel and is not designed

[CLICK HERE TO VIEW PRODUCT INDEX](#)

**1 SELECT A STYLE**

DIMENSIONS	STYLE NUMBER	LIST PRICE	STYLE NUMBER	LIST PRICE	STYLE NUMBER	LIST PRICE
W" x D" x H"	"W" Veneer Top Veneer Chassis		"G" HPL High Pressure Laminate Top Veneer Chassis		"M" TFL Thermally Fused Laminate Top Thermally Fused Laminate Chassis	
<b>Hinged Left / Ganging Left</b>						
17.75 x 24 x 77	RPC1777TW291W	2962	"G" Option N/A		"M" Option N/A	
<b>Hinged Right / Ganging Right</b>						
17.75 x 24 x 77	RPC1777TW292W	2962	"G" Option N/A		"M" Option N/A	

**2 SELECT A FINISH**

"W" Veneer	"G" HPL	"M" TFL	
WAC	-	-	Amber Cherry
WRC	-	-	Caramel Cherry
WIC	-	-	Crimson Cherry
WEC	-	-	Ebony Cherry
WHC	-	-	Honey Cherry
WOC	-	-	KoKo Cherry
WSC	-	-	Scotch Cherry
WEW	-	-	Executive Walnut
WRW	GRW	-	Gray Luster Walnut
WGW	-	-	Gunstock Walnut
WJW	-	-	Judicial Walnut
WNW	-	-	Natural Walnut
WTW	-	-	Studio Teak Walnut

**3 SELECT AN EDGE**

Edge Profile  
Option Not Available

**5 OPTIONS**

- DOOR**
- D2: Door Lock - \$95 per Door
  - D6: Delete Doors - n/c
  - D9SC: Soft Close Door Hinges - \$15 per Door
- DRAWER**
- P6: Modify File/File to Box/Box/File - \$50 per pedestal
  - P33: Wood Drawer Upgrade - \$40 per drawer
- FLUSH CUT**
- FC-B: Flush Unit Both Sides(Facing) for Ganging - \$95
  - FC-L: Flush Unit Left (Facing) for Ganging - \$95
  - FC-R: Flush Unit Right(Facing) for Ganging - \$95
- OPEN PLAN**
- OPB: "W" "G" Style - Modify Unit for Open Plan Application - \$395

**4 SELECT HARDWARE**

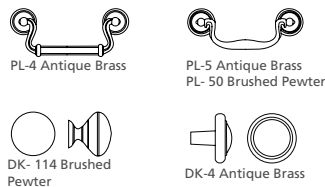

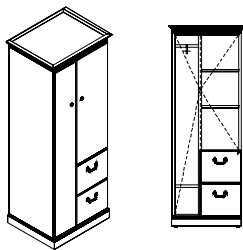

**STORAGE / FILE/FILE WITH MINI-WARDROBE**

**STANDARD FEATURES**

- 2 Adjustable shelves
- 2.5" Cornice top
- 3.5" Traditional base
- Door/Drawer fronts w/ profile edges
- File drawer - Full extension drawers - locking
- Soft close suspension drawer(s)
- Top profile shaped 3 sides

- Unit has black back panel and is not designed for Open Plan use. Select OPB Option for Open Plan application

**NOTES**

- Adjustable shelves shaded

[CLICK HERE TO VIEW PRODUCT INDEX](#)

**1 SELECT A STYLE**

DIMENSIONS		STYLE NUMBER	LIST PRICE	STYLE NUMBER	LIST PRICE	STYLE NUMBER	LIST PRICE
W" x D" x H"	WGT	<b>"W"</b> Veneer Top Veneer Chassis		<b>"G"</b> HPL High Pressure Laminate Top Veneer Chassis		<b>"M"</b> TFL Thermally Fused Laminate Top Thermally Fused Laminate Chassis	
<b>Left Wardrobe</b>							
28 x 24 x 77	220	RPC2877TW293W	4212	"G" Option N/A		"M" Option N/A	
<b>Right Wardrobe</b>							
28 x 24 x 77	220	RPC2877TW294W	4212	"G" Option N/A		"M" Option N/A	

**2 SELECT A FINISH**

<b>"W"</b> Veneer	<b>"G"</b> HPL	<b>"M"</b> TFL	
WAC	-	-	Amber Cherry
WRC	-	-	Caramel Cherry
WIC	-	-	Crimson Cherry
WEC	-	-	Ebony Cherry
WHC	-	-	Honey Cherry
WOC	-	-	KoKo Cherry
WSC	-	-	Scotch Cherry
WEW	-	-	Executive Walnut
WRW	GRW	-	Gray Luster Walnut
WGW	-	-	Gunstock Walnut
WJW	-	-	Judicial Walnut
WNW	-	-	Natural Walnut
WTW	-	-	Studio Teak Walnut

**3 SELECT AN EDGE**

Edge Profile  
Option Not Available

**5 OPTIONS**

**DOOR**

- D2: Door Lock - \$95 per Door
- D9SC: Soft Close Door Hinges - \$15 per Door

**DRAWER**

- P6: Modify File/File to Box/Box/File - \$50 per pedestal
- P33: Wood Drawer Upgrade - \$40 per drawer

**FLUSH CUT**

- FC-B: Flush Unit Both Sides(Facing) for Ganging - \$95
- FC-L: Flush Unit Left (Facing) for Ganging - \$95
- FC-R: Flush Unit Right(Facing) for Ganging - \$95

**OPEN PLAN**

- OPB: "W" "G" Style - Modify Unit for Open Plan Application - \$395

**4 SELECT HARDWARE**



PL-4 Antique Brass



PL-5 Antique Brass  
PL-50 Brushed Pewter



DK-114 Brushed  
Pewter



DK-4 Antique Brass



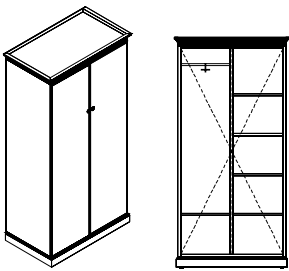

**FREESTANDING WARDROBE / STORAGE**

**STANDARD FEATURES**

- 2.5" Cornice top
- 3 Adjustable shelves
- 3.5" Traditional base
- Doors w/ profile edges
- Top profile shaped 3 sides
- Wardrobe w/ coat rod & hook

and 1-5/8" from the edge.

- Unit has black back panel and is not designed for Open Plan use. Select OPB Option for Open Plan application

**NOTES**

- Adjustable shelves shaded
- Pulls are located 26" from the top of the door

[CLICK HERE TO VIEW PRODUCT INDEX](#)

**1 SELECT A STYLE**

DIMENSIONS		STYLE NUMBER	LIST PRICE	STYLE NUMBER	LIST PRICE	STYLE NUMBER	LIST PRICE
W" x D" x H"	WGT	<b>"W"</b> Veneer Top Veneer Chassis		<b>"G"</b> HPL High Pressure Laminate Top Veneer Chassis		<b>"M"</b> TFL Thermally Fused Laminate Top Thermally Fused Laminate Chassis	
38.5 x 24 x 77	260	RPC3877TW275W	4027	"G" Option N/A		"M" Option N/A	
32.5 x 24 x 77	210	RPC3277TW275W	3777	"G" Option N/A		"M" Option N/A	

**2 SELECT A FINISH**

<b>"W"</b> Veneer	<b>"G"</b> HPL	<b>"M"</b> TFL	
WAC	-	-	Amber Cherry
WRC	-	-	Caramel Cherry
WIC	-	-	Crimson Cherry
WEC	-	-	Ebony Cherry
WHC	-	-	Honey Cherry
WOC	-	-	KoKo Cherry
WSC	-	-	Scotch Cherry
WEW	-	-	Executive Walnut
WRW	GRW	-	Gray Luster Walnut
WGW	-	-	Gunstock Walnut
WJW	-	-	Judicial Walnut
WNW	-	-	Natural Walnut
WTW	-	-	Studio Teak Walnut

**3 SELECT AN EDGE**

Edge Profile  
Option Not  
Available

**5 OPTIONS**

- DELETE CENTER PARTITION**
- MOD31OP: Delete Center Partition / Add (3) Full Width Adj. Shelves & (1) Fixed - \$295
- DOOR**
- D2: Door Lock - \$95 per Door
  - D9SC: Soft Close Door Hinges - \$15 per Door
- FLUSH CUT**
- FC-B: Flush Unit Both Sides(Facing) for Ganging - \$95
  - FC-L: Flush Unit Left (Facing) for Ganging - \$95
  - FC-R: Flush Unit Right(Facing) for Ganging - \$95
- OPEN PLAN**
- OPB: "W" "G" Style - Modify Unit for Open Plan Application - \$395

**4 SELECT HARDWARE**



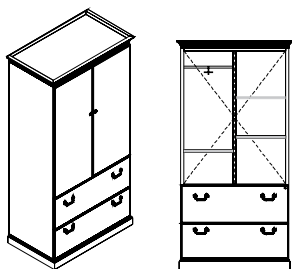

**FREESTANDING LATERAL FILE / STORAGE**

**STANDARD FEATURES**

- 2.5" Cornice top
- 3 Adjustable shelves
- 3.5" Traditional base
- Door/Drawer fronts w/ profile edges
- Legal/Double letter filing
- Soft close suspension drawer(s)
- Top profile shaped 3 sides
- Wardrobe w/ coat rod & hook

- Adjustable shelves shaded
- Unit has black back panel and is not designed for Open Plan use. Select OPB Option for Open Plan application

**NOTES**

[CLICK HERE TO VIEW PRODUCT INDEX](#)

**1 SELECT A STYLE**

DIMENSIONS		STYLE NUMBER	LIST PRICE	STYLE NUMBER	LIST PRICE	STYLE NUMBER	LIST PRICE
W" x D" x H"	WGT	"W" Veneer Top Veneer Chassis		"G" High Pressure Laminate Top Veneer Chassis		"M" Thermally Fused Laminate Top Thermally Fused Laminate Chassis	
38.5 x 24 x 77	280	RPC3877TW281W	4277	"G" Option N/A		"M" Option N/A	
32.5 x 24 x 77	220	RPC3277TW281W	4027	"G" Option N/A		"M" Option N/A	

**2 SELECT A FINISH**

"W" Veneer	"G" HPL	"M" TFL	Finish
WAC	-	-	Amber Cherry
WRC	-	-	Caramel Cherry
WIC	-	-	Crimson Cherry
WEC	-	-	Ebony Cherry
WHC	-	-	Honey Cherry
WOC	-	-	KoKo Cherry
WSC	-	-	Scotch Cherry
WEW	-	-	Executive Walnut
WRW	GRW	-	Gray Luster Walnut
WGW	-	-	Gunstock Walnut
WJW	-	-	Judicial Walnut
WNW	-	-	Natural Walnut
WTW	-	-	Studio Teak Walnut

**3 SELECT AN EDGE**

Edge Profile  
Option Not Available

**5 OPTIONS**

- DELETE CENTER PARTITION**  
- MOD30OP: Delete Center Partition / Add 3 Full Width Adj. Shelves & 1 Fixed - \$295
- DOOR**  
- D2: Door Lock - \$95 per Door  
- D9SC: Soft Close Door Hinges - \$15 per Door
- DRAWER**  
- P33: Wood Drawer Upgrade - \$40 per drawer
- FLUSH CUT**  
- FC-B: Flush Unit Both Sides(Facing) for Ganging - \$95  
- FC-L: Flush Unit Left (Facing) for Ganging - \$95  
- FC-R: Flush Unit Right(Facing) for Ganging - \$95
- OPEN PLAN**  
- OPB: "W" "G" Style - Modify Unit for Open Plan Application - \$395

**4 SELECT HARDWARE**

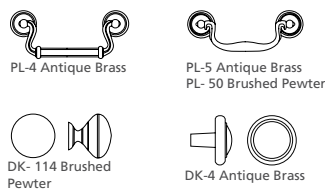

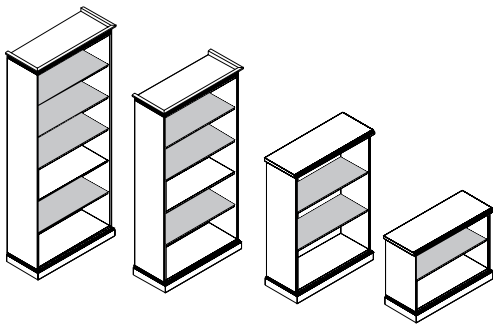

**OPEN BOOKCASE**

**STANDARD FEATURES**

- .75" Thick veneer back w/ dowel joint
- 2.5" Cornice top
- Adjustable glides
- Interior shelf depth 12"
- Veneer Top for 53" and 30" height
- Top profile shaped 3 sides
- "W" styles - 30", 53" H units finished top, 74", 86" H units black painted top

- Base Height 3.5"
- Glides adjust 1"
- Unit has black back panel and is not designed for Open Plan use. Select OPB Option for Open Plan application
- 31.75" H Open Bookcases are NOT meant to gang with desks, returns and credenzas. Unit is higher than regular worksurfaces to allow double binder storage. If matching height is desired, choose RPC3724CA125W or RPC3124CA125W with D6A option

**NOTES**

- Adjustable shelves are shaded

[CLICK HERE TO VIEW PRODUCT INDEX](#)

**1 SELECT A STYLE**

DIMENSIONS		STYLE NUMBER	LIST PRICE	STYLE NUMBER	LIST PRICE	STYLE NUMBER	LIST PRICE
W" x D" x H"	WGT	"W" Veneer Top Veneer Chassis		"G" HPL High Pressure Laminate Top Veneer Chassis		"M" TFL Thermally Fused Laminate Top Thermally Fused Laminate Chassis	
<b>Cornice Top and Base</b>							
37 x 16 x 86	205	RPC3786BK250W	2600	"G" Option N/A		"M" Option N/A	
37 x 16 x 74	185	RPC3774BK250W	2345	"G" Option N/A		"M" Option N/A	
31 x 16 x 86	200	RPC3186BK250W	2413	"G" Option N/A		"M" Option N/A	
31 x 16 x 74	180	RPC3174BK250W	2159	"G" Option N/A		"M" Option N/A	
<b>Veneer Top and Base</b>							
37 x 15 x 53	205	RPC3753BK250W	2177	RPC3753BK250G	2177	"M" Option N/A	
37 x 15 x 31.75	185	RPC3731BK250W	1965	RPC3731BK250G	1965	"M" Option N/A	
31 x 15 x 53	200	RPC3153BK250W	1998	RPC3153BK250G	1998	"M" Option N/A	
31 x 15 x 31.75	180	RPC3131BK250W	1866	RPC3131BK250G	1866	"M" Option N/A	

**2 SELECT A FINISH**

"W" Veneer	"G" HPL	"M" TFL	
WAC	-	-	Amber Cherry
WRC	-	-	Caramel Cherry
WIC	-	-	Crimson Cherry
WEC	-	-	Ebony Cherry
WHC	-	-	Honey Cherry
WOC	-	-	KoKo Cherry
WSC	-	-	Scotch Cherry
WEW	-	-	Executive Walnut
WRW	GRW	-	Gray Luster Walnut
WGW	-	-	Gunstock Walnut
WJW	-	-	Judicial Walnut
WNW	-	-	Natural Walnut
WTW	-	-	Studio Teak Walnut

**3 SELECT AN EDGE**



**5 OPTIONS**

**FLUSH CUT**

- FC-B: Flush Unit Both Sides(Facing) for Ganging - \$95
- FC-R: Flush Unit Right(Facing) for Ganging - \$95
- FC-L: Flush Unit Left (Facing) for Ganging - \$95

**INTERIOR CABINET LIGHTING**

- LEDPK starter kit includes Infeed, 1 Puck Interior Light and the ability to daisy chain up to 6 total Puck Lights
- LEDPK: LED Puck Starter Kit - \$295
- PK: 1 LED Interior Light - \$125

**OPEN PLAN**

- OPB: "W" "G" Style - Modify Unit for Open Plan Application - \$395

**SHELF**

- GS14F: Replace Standard Shelves with Glass Shelves - \$85 per Shelf
- S714F: Heavy Duty Lumber 1" Shelves - \$75 per Shelf

**4 SELECT HARDWARE**

Hardware Option Not Available

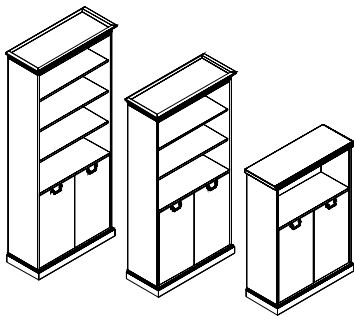

**BOOKCASE W/ DOORS - CORNICE TOP AND BASE**

**STANDARD FEATURES**

- .75" Thick veneer back w/ dowel joint
- 2.5" Cornice top
- Interior shelf depth 12"
- "W" styles - 30", 53" H units finished top, 74", 86" H units black painted top

for Open Plan use. Select OPB Option for Open Plan application

**NOTES**

- Adjustable shelves above doors
- Base Height 3.5"
- Unit has black back panel and is not designed

[CLICK HERE TO VIEW PRODUCT INDEX](#)

**1 SELECT A STYLE**

DIMENSIONS		STYLE NUMBER	LIST PRICE	STYLE NUMBER	LIST PRICE	STYLE NUMBER	LIST PRICE
W" x D" x H"	WGT	<b>"W"</b> Veneer Top Veneer Chassis		<b>"G"</b> HPL High Pressure Laminate Top Veneer Chassis		<b>"M"</b> TFL Thermally Fused Laminate Top Thermally Fused Laminate Chassis	
<b>Cornice Top and Base</b>							
37 x 16 x 86	205	RPC3786BK251W	2860	"G" Option N/A		"M" Option N/A	
37 x 16 x 74	185	RPC3774BK251W	2579	"G" Option N/A		"M" Option N/A	
31 x 16 x 86	200	RPC3186BK251W	2654	"G" Option N/A		"M" Option N/A	
31 x 16 x 74	180	RPC3174BK251W	2375	"G" Option N/A		"M" Option N/A	
<b>Veneer Top and Base</b>							
37 x 15 x 53	110	RPC3753BK251W	2394	"G" Option N/A		"M" Option N/A	
31 x 15 x 53	105	RPC3153BK251W	2198	"G" Option N/A		"M" Option N/A	

**2 SELECT A FINISH**

<b>"W"</b> Veneer	<b>"G"</b> HPL	<b>"M"</b> TFL	
WAC	-	-	Amber Cherry
WRC	-	-	Caramel Cherry
WIC	-	-	Crimson Cherry
WEC	-	-	Ebony Cherry
WHC	-	-	Honey Cherry
WOC	-	-	KoKo Cherry
WSC	-	-	Scotch Cherry
WEW	-	-	Executive Walnut
WRW	GRW	-	Gray Luster Walnut
WGW	-	-	Gunstock Walnut
WJW	-	-	Judicial Walnut
WNW	-	-	Natural Walnut
WTW	-	-	Studio Teak Walnut

**3 SELECT AN EDGE**



**5 OPTIONS**

- FLUSH CUT**
- FC-B: Flush Unit Both Sides(Facing) for Ganging - \$95
  - FC-R: Flush Unit Right(Facing) for Ganging - \$95
  - FC-L: Flush Unit Left (Facing) for Ganging - \$95
- DOOR**
- D9SC: Soft Close Door Hinges - \$15 per Door
- INTERIOR CABINET LIGHTING**
- LEDPK starter kit includes Infeed, 1 Puck Interior Light and the ability to daisy chain up to 6 total Puck Lights
- LEDPK: LED Puck Starter Kit - \$295
  - PK: 1 LED Interior Light - \$125
- OPEN PLAN**
- OPB: "W" "G" Style - Modify Unit for Open Plan Application - \$395
- SHELF**
- GS14F: Replace Standard Shelves with Glass Shelves - \$85 per Shelf
  - S714F: Heavy Duty Lumber 1" Shelves - \$75 per Shelf

**4 SELECT HARDWARE**



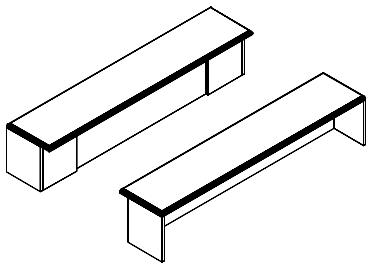

**FREESTANDING TRANSACTION COUNTER**

**STANDARD FEATURES**

- 1.25" Veneer countertop w/ profile edge all sides
- 3" Front overhang
- Adhesive tape secures sit-on panels to surface

**NOTES**

- Designed For Use On Standard Work surface Components

[CLICK HERE TO VIEW PRODUCT INDEX](#)

**1 SELECT A STYLE**

DIMENSIONS		STYLE NUMBER	LIST PRICE	STYLE NUMBER	LIST PRICE	STYLE NUMBER	LIST PRICE
W" x D" x H"	WGT	"W" Veneer Veneer Top Veneer Chassis		"G" HPL High Pressure Laminate Top Veneer Chassis		"M" TFL Thermally Fused Laminate Top Thermally Fused Laminate Chassis	
72 x 15 x 15	75	RPC7215RP916W	1542	RPC7215RP916G	1542	"M" Option N/A	
66 x 15 x 15	70	RPC6615RP916W	1511	RPC6615RP916G	1511	"M" Option N/A	
60 x 15 x 15	65	RPC6015RP916W	1481	RPC6015RP916G	1481	"M" Option N/A	

**C157R: Reception Counter Fabric (Choose Grade Below/Pricing Applies to All Sizes)**

COM	COL	1	2	3	4	5	6	7	8	9	10	11/ L1	12	13/ L2
201	N/A	280	320	360	400	440	480	520	560	600	640	680	720	800

**2 SELECT A FINISH | 3 SELECT AN EDGE | 5 OPTIONS**

"W" Veneer	"G" HPL	"M" TFL	
WAC	GAC	-	Amber Cherry
WRC	-	-	Caramel Cherry
WIC	GIC	-	Crimson Cherry
WEC	-	-	Ebony Cherry
WHC	GHC	-	Honey Cherry
WOC	GOC	-	KoKo Cherry
WSC	-	-	Scotch Cherry
WEW	GEW	-	Executive Walnut
WRW	GRW	-	Gray Luster Walnut
WGW	-	-	Gunstock Walnut
WJW	-	-	Judicial Walnut
WNW	GNW	-	Natural Walnut
WTW	GTW	-	Studio Teak Walnut



**4 SELECT HARDWARE**

Hardware Option Not Available

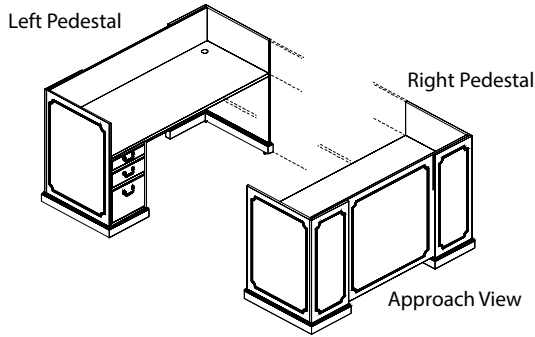

**SINGLE PEDESTAL - BOX/BOX/FILE**

**STANDARD FEATURES**

- 2 Standard grommets - matches pull finish or specify black TM30, silver TM31 or antique brass TM33
- 2.5"H Full hardwood base w/ mitred corners
- Breakfront modesty design
- Full extension drawers - Full extension drawers
  - locking
- Molding
- Soft close suspension drawer(s)

**NOTES**

- Order Countertops Separately

[CLICK HERE TO VIEW PRODUCT INDEX](#)

**1 SELECT A STYLE**

DIMENSIONS		STYLE NUMBER	LIST PRICE	STYLE NUMBER	LIST PRICE	STYLE NUMBER	LIST PRICE
W" x D" x H"	WGT	"W" Veneer Veneer Top Veneer Chassis		"G" HPL High Pressure Laminate Top Veneer Chassis		"M" TFL Thermally Fused Laminate Top Thermally Fused Laminate Chassis	
<b>Left Pedestal</b>							
84 x 30 x 42	395	RPC8442RP925W	5050	RPC8442RP925G	5050	"M" Option N/A	
72 x 30 x 42	350	RPC7242RP925W	4658	RPC7242RP925G	4658	"M" Option N/A	
66 x 30 x 42	320	RPC6642RP925W	4528	RPC6642RP925G	4528		
<b>Right Pedestal</b>							
84 x 30 x 42	395	RPC8442RP924W	5050	RPC8442RP924G	5050	"M" Option N/A	
72 x 30 x 42	350	RPC7242RP924W	4658	RPC7242RP924G	4658	"M" Option N/A	
66 x 30 x 42	320	RPC6642RP924W	4528	RPC6642RP924G	4528	"M" Option N/A	

**C157R: Reception Counter Fabric (Choose Grade Below/Pricing Applies to All Sizes)**

COM	COL	1	2	3	4	5	6	7	8	9	10	11/ L1	12	13/ L2
201	N/A	280	320	360	400	440	480	520	560	600	640	680	720	800

**2 SELECT A FINISH**

"W" Veneer	"G" HPL	"M" TFL	
WAC	GAC	-	Amber Cherry
WRC	-	-	Caramel Cherry
WIC	GIC	-	Crimson Cherry
WEC	-	-	Ebony Cherry
WHC	GHC	-	Honey Cherry
WOC	GOC	-	KoKo Cherry
WSC	-	-	Scotch Cherry
WEW	GEW	-	Executive Walnut
WRW	GRW	-	Gray Luster Walnut
WGW	-	-	Gunstock Walnut
WJW	-	-	Judicial Walnut
WNW	GNW	-	Natural Walnut
WTW	GTW	-	Studio Teak Walnut

**3 SELECT AN EDGE**

Edge Profile  
Option Not Available

**5 OPTIONS**

**ACCESSORIES**

- K28: Articulating Keyboard w/ Mouse - \$375
- K30: Traditional Center Drawer - \$195

**DRAWER**

- P6: Modify Box/Box/File to File/File - \$50 per pedestal
- P33: Wood Drawer Upgrade - \$40 per drawer

**MOLDING**

- DSM1: Delete molding - Deduct \$95

**GROMMETS (NON-STANDARD LOCATION)**

- Provide drawing w/ Grommet Location and Specify Color - \$90 ea.
- Black: TM30-NS
  - Silver: TM31-NS
  - Antique Brass: TM33-NS

**4 SELECT HARDWARE**



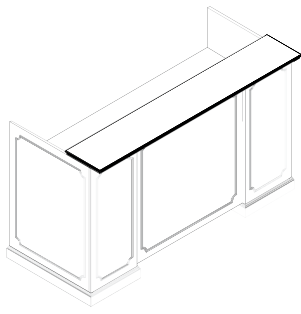

**12" RECTANGLE OVERHANG COUNTER**

STANDARD FEATURES

- 3" Overhang
- Veneer countertop w/ profile edge all sides

[CLICK HERE TO VIEW PRODUCT INDEX](#)

**1 SELECT A STYLE**

DIMENSIONS		STYLE NUMBER	LIST PRICE	STYLE NUMBER	LIST PRICE	STYLE NUMBER	LIST PRICE
W" x D" x H"	WGT	"W" Veneer Top Veneer Chassis		"G" HPL High Pressure Laminate Top Veneer Chassis		"M" TFL Thermally Fused Laminate Top Thermally Fused Laminate Chassis	
<b>Counter Top</b>							
84 x 12	40	RPC8412TC510W-RVC	976	RPC8412TC510G-RLC	976	"M" Option N/A	
72 x 12	35	RPC7212TC510W-RVC	845	RPC7212TC510G-RLC	845	"M" Option N/A	
66 x 12	30	RPC6612TC510W-RVC	815	RPC6612TC510G-RLC	815	"M" Option N/A	

**2 SELECT A FINISH**

"W" Veneer	"G" HPL	"M" TFL	
WAC	GAC	-	Amber Cherry
WRC	-	-	Caramel Cherry
WIC	GIC	-	Crimson Cherry
WEC	-	-	Ebony Cherry
WHC	GHC	-	Honey Cherry
WOC	GOC	-	KoKo Cherry
WSC	-	-	Scotch Cherry
WEW	GEW	-	Executive Walnut
WRW	GRW	-	Gray Luster Walnut
WGW	-	-	Gunstock Walnut
WJW	-	-	Judicial Walnut
WNW	GNW	-	Natural Walnut
WTW	GTW	-	Studio Teak Walnut

**3 SELECT AN EDGE**

Edge Profile  
Option Not Available

**5 OPTIONS**

No Options Available

**4 SELECT HARDWARE**

Hardware  
Option Not Available

Left Pedestal

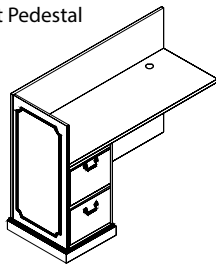

Right Pedestal

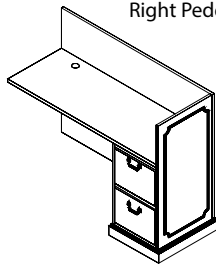

**FILE / FILE**

**STANDARD FEATURES**

- 1 Standard grommet - matches pull finish or specify black TM30, silver TM31 or antique brass TM33
- 2.5"H Full hardwood base w/ mitred corners
- Full extension drawers - Full extension drawers
  - locking
- Molding
- Soft close suspension drawer(s)

[CLICK HERE TO VIEW PRODUCT INDEX](#)

**1 SELECT A STYLE**

DIMENSIONS		STYLE NUMBER	LIST PRICE	STYLE NUMBER	LIST PRICE	STYLE NUMBER	LIST PRICE
W" x D" x H"	WGT	"W" Veneer Top Veneer Chassis		"G" High Pressure Laminate Top Veneer Chassis		"M" Thermally Fused Laminate Top Thermally Fused Laminate Chassis	
<b>Left Pedestal</b>							
60 x 24 x 42	155	RPC6042RP930W	3053	RPC6042RP930G	3053	"M" Option N/A	
54 x 24 x 42	145	RPC5442RP930W	3004	RPC5442RP930G	3004	"M" Option N/A	
48 x 24 x 42	140	RPC4842RP930W	2941	RPC4842RP930G	2941	"M" Option N/A	
42 x 24 x 42	135	RPC4242RP930W	2898	RPC4242RP930G	2898	"M" Option N/A	
<b>Right Pedestal</b>							
60 x 24 x 42	155	RPC6042RP931W	3053	RPC6042RP931G	3053	"M" Option N/A	
54 x 24 x 42	145	RPC5442RP931W	3004	RPC5442RP931G	3004	"M" Option N/A	
48 x 24 x 42	140	RPC4842RP931W	2941	RPC4842RP931G	2941	"M" Option N/A	
42 x 24 x 42	135	RPC4242RP931W	2898	RPC4242RP931G	2898	"M" Option N/A	

**C154R: Reception Counter Fabric (Choose Grade Below/Pricing Applies to All Sizes)**

COM	COL	1	2	3	4	5	6	7	8	9	10	11/ L1	12	13/ L2
167	N/A	232	264	296	328	360	392	424	456	488	520	552	584	648

**2 SELECT A FINISH**

"W" Veneer	"G" HPL	"M" TFL	
WAC	GAC	-	Amber Cherry
WRC	-	-	Caramel Cherry
WIC	GIC	-	Crimson Cherry
WEC	-	-	Ebony Cherry
WHC	GHC	-	Honey Cherry
WOC	GOC	-	KoKo Cherry
WSC	-	-	Scotch Cherry
WEW	GEW	-	Executive Walnut
WRW	GRW	-	Gray Luster Walnut
WGW	-	-	Gunstock Walnut
WJW	-	-	Judicial Walnut
WNW	GNW	-	Natural Walnut
WTW	GTW	-	Studio Teak Walnut

**3 SELECT AN EDGE**



**5 OPTIONS**

**ACCESSORIES**

- K28: Articulating Keyboard w/ Mouse - \$375

**DRAWER**

- P6: Modify File/File to Box/Box/File - \$50 per pedestal  
 - P33: Wood Drawer Upgrade - \$40 per drawer

**MOLDING**

- DSM2: Delete molding - Deduct \$50

**GROMMETS (NON-STANDARD LOCATION)**

Provide drawing w/ Grommet Location and Specify Color - \$90 ea.

- Black: TM30-NS
- Silver: TM31-NS
- Antique Brass: TM33-NS

**4 SELECT HARDWARE**





**BASE MODIFICATIONS**

**RUNOFF SLEIGH BASE**

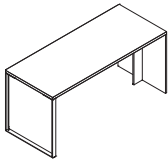

STYLE NUMBER	LIST PRICE	SPECIFICATIONS
<b>24" Metal Sleigh Base</b> SSB24	450	- Metal Sleigh base - standard in silver finish
<b>30" Metal Sleigh Base</b> SSB30	475	
<b>36" Metal Sleigh Base</b> SSB36	495	

Available: - Central, NOT SO square, Spaces

**COMPUTER SUPPORT**

**DELUXE SINGLE MONITOR ARM W/ USB POST**



STYLE NUMBER	LIST PRICE	SPECIFICATIONS
MA1952	495	<ul style="list-style-type: none"> <li>- (4) 2.0 USB Ports</li> <li>- Post Length: 22-1/2"H, Post Base Requires 80mm Dia. Hole</li> <li>- Spring Assist - Full Movement Arm, Arm Extends Up To 13 - 3/8"</li> <li>- Supports Screens Up To 24", Swivels 180 degrees - Mount Plate Tilts 85 degrees</li> <li>- Arm: Die Cast Aluminum</li> </ul> <p><b>Notes</b></p> <ul style="list-style-type: none"> <li>- Surface Factory Bored / Ready To Install</li> </ul>

Available: - All DARRAN Collections

**COMPUTER SUPPORT**

**DELUXE DOUBLE MONITOR ARM W/ USB POST**



STYLE NUMBER	LIST PRICE	SPECIFICATIONS
MA2952	795	<ul style="list-style-type: none"> <li>- (4) 2.0 USB Ports</li> <li>- Post Length: 22-1/2"H, Post Base Requires 80mm Dia. Hole</li> <li>- Spring Assist - Full Movement Arm, Arm Extends Up To 13 - 3/8"</li> <li>- Supports Screens Up To 24", Swivels 180 degrees - Mount Plate Tilts 85 degrees</li> <li>- Arm: Die Cast Aluminum</li> </ul> <p><b>Notes</b></p> <ul style="list-style-type: none"> <li>- Surface Factory Bored / Ready To Install</li> <li>- Can Accommodate Up To 4 Monitors By Ordering Extra Double Arms.</li> <li>1 Extra Arm and 1 Double Clamp - Add\$305</li> </ul>

Available: - All DARRAN Collections

**COMPUTER SUPPORT**

**CPU RETRACTABLE CRADLE**

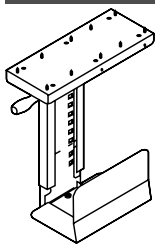

STYLE NUMBER	LIST PRICE	SPECIFICATIONS
K18	195	<ul style="list-style-type: none"> <li>- Black Metal CPU Carriage</li> <li>- Full 360° swivel capability allows easy access to rear of CPU for cables / wires</li> <li>- Track allows 8- 1/2" extension</li> <li>- Width Adjustment 5-1/2" to 9-1/4"</li> <li>- Height adjustment 14- 5/8" to 20- 1/2"</li> <li>- Black epoxy finish</li> </ul> <p><b>Notes</b></p> <ul style="list-style-type: none"> <li>- Factory Installed</li> </ul>

Available: - All DARRAN Collections

COMPUTER SUPPORT

ARTICULATING KEYBOARD TRAY

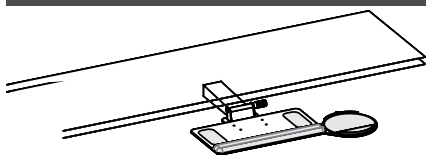

STYLE NUMBER

*Factory Installed*

K28

*Field Installed*

K28F

LIST PRICE

375

395

SPECIFICATIONS

- Adjusts effortlessly - A simple one-handed motion allows the keyboard to be repositioned instantly, without the use of locks or levers
- Encourages low-risk postures - Maximizes adjustability within a safe operating range.
- Will last a lifetime - Exceeds all applicable BIFMA Standards and comes with a lifetime guarantee.

Notes

- Factory Installed (standard)
- FIELD INSTALL - \$395

Available: - All DARRAN Collections

COMPUTER SUPPORT

TRADITIONAL PULL-OUT DRAWER WITH KEYBOARD TRAY

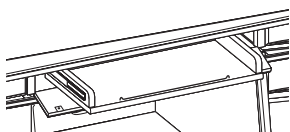

STYLE NUMBER

K21

LIST PRICE

450

SPECIFICATIONS

- Traditional Pull-out Drawer w/Keyboard Tray

Available: - Jamestown

CONFERENCE DESK SUPPORT POST OPTIONS

WOOD DRUM



STYLE NUMBER

*6" Diameter Drum*

B6

LIST PRICE

395

SPECIFICATIONS

- Available in Walnut / Cherry / Maple
- Adjustable levelers
- Replaces standard metal round legs

Notes

- Specify Finish

Available: - Central Park, NOT SO square

CONFERENCE DESK SUPPORT POST OPTIONS

WOOD HALF DRUM

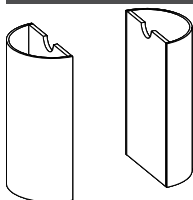

STYLE NUMBER

*8" Half Drum*

HC08

*16" Diameter Drum*

HC16

LIST PRICE

695

895

SPECIFICATIONS

- Available in Walnut / Cherry / Maple
- Adjustable levelers

Notes

- Specify Finish

Available: - Central Park, NOT SO square, Richmond Park

CONFERENCE DESK SUPPORT POST OPTIONS

METAL OVAL "T" BASE



STYLE NUMBER

*Silver*

32MOTS

*Black*

32MOTB

LIST PRICE

595

595

SPECIFICATIONS

- 3" x 1" Aluminum square extrusion
- Leveler adjustment
- Oval Post

Available: - Silver or Black

DOOR MODIFICATIONS

SOFT CLOSE DOOR HINGE



STYLE NUMBER

D9SC

LIST PRICE

15 Per Door

SPECIFICATIONS

- Snap onto standard door hinge
- Requires (1) per door
- Max door height 43"
- Factory installed where specified
- Individually shipped for field installation

Notes

- Specify Each Item To Have Slow Close Feature

Available: - All DARRAN Collections

DOOR MODIFICATIONS

DELETE DOORS

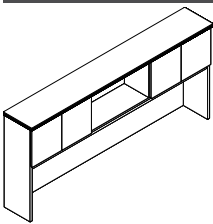

STYLE NUMBER

D6

LIST PRICE

N/C

SPECIFICATIONS

- Standard Door overheads and cabinets can have door deleted for open access. Modification of hinge rails and structural components are made face ready.

Available: - All DARRAN Collections

DOOR MODIFICATIONS

- REPLACE GLASS PANEL INSERT WITH VENEER PANEL INSERT



Glass Door

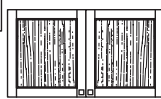

Wood Door

STYLE NUMBER

D35

LIST PRICE

30 per door

SPECIFICATIONS

- Replace glass panel insert with veneer panel insert

Notes

- Not Available on "M" skus
- Glass door has beveled glass
- Wood door w/ veneer insert - only available on "W" style

Available: - Capitol Park, Jamestown, Prado, Richmond Park

**DOOR MODIFICATIONS**

**DELETE DOORS/REPLACE BLACK LAMINATE SHELF W/ FINISHED SHELF**

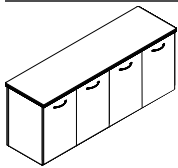

**STYLE NUMBER**  
D6A

**LIST PRICE**  
N/C

**SPECIFICATIONS**  
- Delete doors and replace black laminate shelf with finished shelf

Available: - All Storage Credenzas ("W"/"G" Styles ).  
Excludes Rail.

**DOOR MODIFICATIONS**

**PANEL DOOR LOCK**

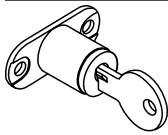

**STYLE NUMBER**  
D2

**LIST PRICE**  
95 Per Door Set

**SPECIFICATIONS**  
- Door Locks - 1 Door w/ Lock, Other Door w/ Catch Latch  
- Contact Customer Service regarding limited lock locations and keying.

Available: - Panel Doors, Wood Frame Doors, and Silverluma doors

**DOOR MODIFICATIONS**

**GLASS DOOR LOCK**

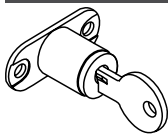

**STYLE NUMBER**  
D2-G

**LIST PRICE**  
195 Per Door Set

**SPECIFICATIONS**  
- Door Locks - 1 Door w/ Lock, Other Door w/ Catch Latch  
- Contact Customer Service regarding limited lock locations and keying.

Available: - Glass Doors

**DOOR MODIFICATIONS**

**BOX DRAWER ACCESSORIES**

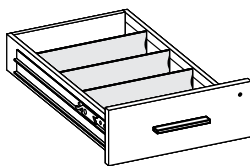

**STYLE NUMBER**  
*Wood Drawer Dividers w/ Clips*  
K-DIV  
*Single Tray - Utility Tray*  
K-Sut

**LIST PRICE**  
SET OF 3 - 30  
30 each

**SPECIFICATIONS**  
- K-DIV Extra Wood Drawer Dividers with Clips, Top Box drawers standard with 1 divider  
- K-SUT Single Tray - Utility Tray, Specify Legal or Letter drawer width

Available: - All DARRAN Collections. Excludes Rail.

**DRAWER OPTIONS**

**TRADITIONAL CENTER DRAWER**

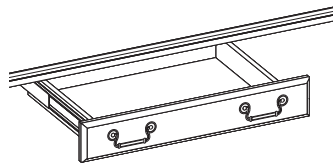

**STYLE NUMBER**  
K17  
*Add Skirt Option*  
K17-SK

**LIST PRICE**  
225  
  
325

**SPECIFICATIONS**  
- Standard on desks in Jamestown Collection. Optional center drawers available for bullet conference desk, kneespace credenzas and corner units. 3 ply hardwood drawer / dowel construction profile shaped drawer front. Specify pull choice.

Available: - Jamestown

**DRAWER OPTIONS**

**FINISHED TRADITIONAL CENTER DRAWER**

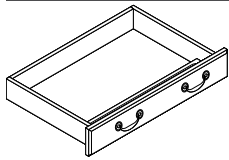

**STYLE NUMBER**  
K30  
*Add Skirt Option*  
K30-SK

**LIST PRICE**  
195  
  
295

**SPECIFICATIONS**  
- Veneer drawer front finished to match unit veneer. Edges are scalloped to match standard drawers.  
- Standard with matching wood grain pencil tray  
- Pulls selected to match unit installed

Available: - Richmond Park

**DRAWER OPTIONS**

**FINISHED CENTER DRAWER**

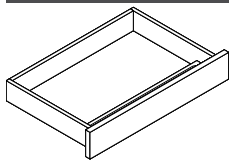

**STYLE NUMBER**  
K31  
*Add Skirt Option*  
K31-SK

**LIST PRICE**  
195  
  
295

**SPECIFICATIONS**  
- Veneer drawer front finished to match unit W or G style veneer.  
- Ball bearing smooth operation  
- Drawer has lifetime guarantee  
- Standard with matching wood grain pencil tray  
- Laminate drawer front to match laminate unit (M style)

Available: - Central Park, NOT SO square, Rail

**DRAWER OPTIONS**

**PRADO/SPACES CENTER DRAWER - VENEER BOTTOM**

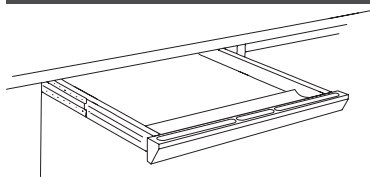

**STYLE NUMBER**  
*Factory Installed*  
K1  
*Field Installed*  
K1BVF

**LIST PRICE**  
275  
  
275

**SPECIFICATIONS**  
- Solid hardwood front beveled and rounded with recessed pencil tray.

Available: - Prado, Spaces

**DRAWER OPTIONS**

**CENTER DRAWER**

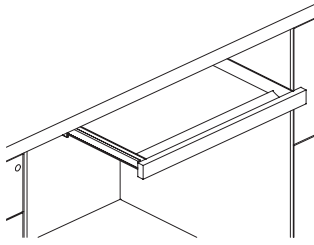

**STYLE NUMBER**

**LIST PRICE**

**SPECIFICATIONS**

*Factory Installed*

- Center Drawer - Factory Installed, Center Drawer - Field Installed

K1R

275

*Field Installed*

K1RF

275

Available: - Rift

**DRAWER OPTIONS**

**CENTER DRAWER WITH SKIRT**

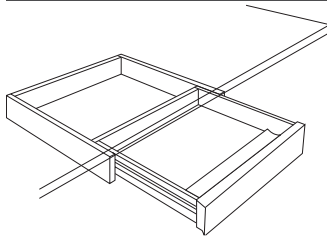

**STYLE NUMBER**

**LIST PRICE**

**SPECIFICATIONS**

*Factory Installed*

- Center Drawer - Factory Installed, Center Drawer - Field Installed

K2R

375

*Field Installed*

K2RF

375

*Add Skirt Option*

K2R-SK

475

Available: - Rift

**DRAWER OPTIONS - BOTTOM COVER**

**BLACK DURA-LEATHER DRAWER BOTTOM COVERS**

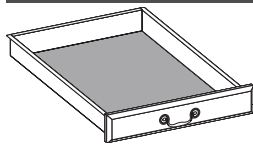

**STYLE NUMBER**

**LIST PRICE**

**SPECIFICATIONS**

P2

75

- Center drawer and Box/Tray drawers are covered in Black Duraleather that adds a prestigious touch.

Available: - Jamestown

**DRAWER OPTIONS - BOTTOM COVER**

**FELT BOTTOM CENTER DRAWER INSERT LINER**

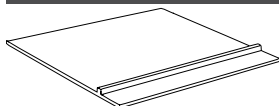

**STYLE NUMBER**

**LIST PRICE**

**SPECIFICATIONS**

K3

95

- Inserts into center drawer and features divider for open pen and pencil storage. Removable for easy cleaning.  
 - Adds a luxurious touch to center drawers.  
 - Color: Dark Brown Coal

Available: - All DARRAN Collections. Excludes Rail.

**DRAWER OPTIONS - UPGRADE**

**WOOD DRAWER UPGRADE**

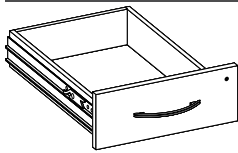

**STYLE NUMBER**  
P33

**LIST PRICE**  
40 Per Drawer

**SPECIFICATIONS**

- Dowel joint construction
- Hardwood veneer multi-ply drawer
- UV finish
- 1/4" Wood veneer bottoms
- File drawer bottoms are five block reinforced for heavy weight capacity
- Lifetime guaranteed

Available: - Central Park, Capitol Park, NOT SO square, Rail, Richmond Park

**LIGHTING**

**LT-LED TASK LIGHT**

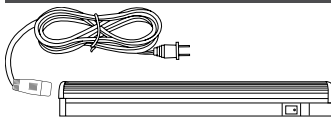

**STYLE NUMBER**  
*24" Tasklight*  
LT-LED24  
*48" Tasklight*  
LT-LED48  
*60" Tasklight*  
LT-LED60  
*Linking Cable*  
LC22

**LIST PRICE**  
90  
165  
180  
20

**SPECIFICATIONS**

- Anodized aluminum finish
- Tilting beam allows adjustability
- Switch with dimming control
- 50,000 hour life
- 12V power drive standard with each task light 30 watt max

**Notes**  
- LC22: 20" LT-LED Task light linking cable

Available: - All DARRAN Collections

**LIGHTING**

**DELETE TASK LIGHT CONCEALMENT APRON RAIL**

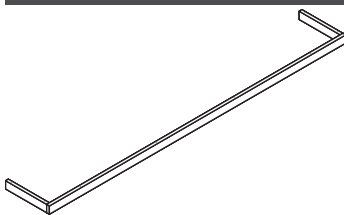

**STYLE NUMBER**  
WAR-D

**LIST PRICE**  
Deduct 125

**SPECIFICATIONS**  
- Delete Tasklight Concealment apron rail when a task light is not used on a wall hung unit

Available: - Wall Hung Units

**LIGHTING**

**SLIM LINE ALUMINUM LED TASK LIGHT**

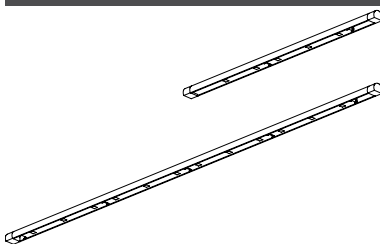

**STYLE NUMBER**  
*24" Tasklight*  
LED24  
*48" Tasklight*  
LED48  
*60" Tasklight*  
LED60  
*Linking Package*  
DPC

**LIST PRICE**  
315  
445  
555  
Deduct 85 per task light

**SPECIFICATIONS**

- Anodized aluminum finish
- Tilting beam allows adjustability
- Switch with dimming control
- 50,000 hour life
- 12V power drive standard with each task light 30 watt max

**Notes**  
- Link multiple tasklights up to 30W of power wattage. Deletes 1 power drive

Available: - Rift and Spaces

LIGHTING

LED INTERIOR CABINET PUCK LIGHT

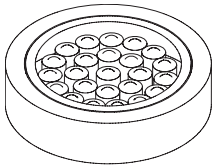

STYLE NUMBER

LIST PRICE

SPECIFICATIONS

**Starter Kit**

295

- Starter kit includes Infeed, 1 Puck Interior Light and the ability to daisy chain up to 6 total Puck Lights

LEDPK

**1 LED Interior Puck Light**

125

- (1) LED Puck Light with 30W power drive and switch  
- Recessed fixture  
- 12V linking cord 98"L  
- Silver finish  
- 50,000 hour life  
- 2 watt per light

Notes

- Power drive included, Light only

Available: - Overhead/Tower Units with glass doors or no doors

PEDESTAL MODIFICATIONS

BREAKFRONT PEDESTAL WITH WIRE MANAGEMENT CAVITY DOOR

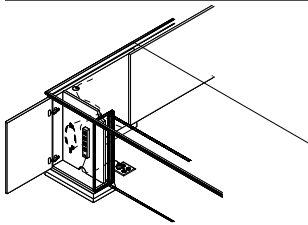

STYLE NUMBER

LIST PRICE

SPECIFICATIONS

PC10

95

- Hinged pedestal front door offers easy access for wire management

**Power Supply Cordset**

PD717

95

- Wire hooks provide wire coil storage  
- Wire access openings allow access to floor, cabinets interior and kneespace  
- Cabinet interior is black finish  
- Top grommet is positioned over cavity for access ease  
- (Power Strip Optional)

Notes

- Breakfront Chassis Only

Available: - All DARRAN Collections. Excludes Jamestown, Rail, Richmond, and Rift.

PEDESTAL MODIFICATIONS

BLACK LAMINATE PRINTER PULLOUT BOTTOM SHELF

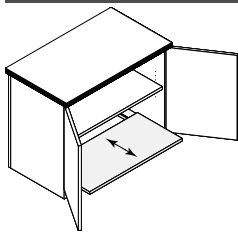

STYLE NUMBER

LIST PRICE

SPECIFICATIONS

PPOS

214

- Black Laminate pullout shelf on suspension  
- Black grommet  
- Adjustable Shelf

Available: - All DARRAN Collections. Excludes Rail.

PEDESTAL MODIFICATIONS

ADD VENEER KNEESPACE CABINETS - BASE

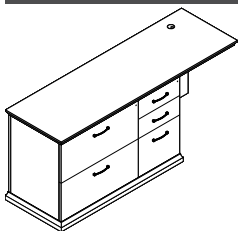

STYLE NUMBER

LIST PRICE

SPECIFICATIONS

**Add Box/Box/File or File/File**

985

- Multi-file specify Box/Box Left or Right

P40B

**Add Lateral File 29" W**

P41B

1205

Notes

- Add additional Standard Cabinets To Kneespace Area.

**Add Multi-File - 31"W**

P42B

1205

**Add Storage With Doors 29"W**

P43B

1095

**Add CPU /Printer Cabinet - Open**

P44B

1095

Available: - Capitol Park, Jamestown, Prado, Richmond Park



PEDESTAL MODIFICATIONS

ADD VENEER KNEESPACE CABINETS - NO BASE

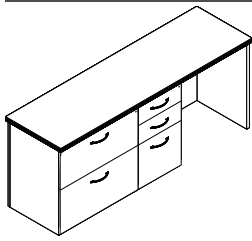

Available: - Central Park, NOT SO square

STYLE NUMBER	LIST PRICE
<i>Add Box/Box/File or File/File</i> P40W	875
<i>Add Lateral File 29" W</i> P41W	985
<i>Add Multi-File - 31"W</i> P42W	1095
<i>Add Storage With Doors 29"W</i> P43W	985
<i>Add CPU /Printer Cabinet - Open</i> P44W	985

**SPECIFICATIONS**  
- Multi-file specify Box/Box Left or Right

**Notes**  
- Add additional Standard Cabinets To Kneespace Area.

PEDESTAL MODIFICATIONS

ADD TECH VENEER KNEESPACE CABINETS - NO BASE

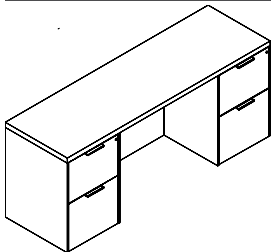

Available: - Rift

STYLE NUMBER	LIST PRICE
<i>Add Box/Box/File or File/File</i> P40T	1100
<i>Add Lateral File 29" W</i> P41T	1210
<i>Add Multi-File - 31"W</i> P42T	1320
<i>Add Storage With Doors 29"W</i> P43T	1210
<i>Add CPU /Printer Cabinet - Open</i> P44T	1210

**SPECIFICATIONS**  
- Multi-file specify Box/Box Left or Right

**Notes**  
- Add additional Standard Cabinets To Kneespace Area.

PEDESTAL MODIFICATIONS

ADD MELAMINE (TFL) KNEESPACE CABINETS - NO BASE

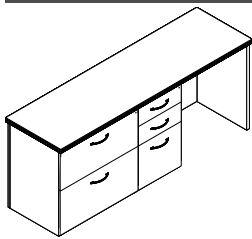

Available: - Central Park (TFL) and NOT SO square (TFL)

STYLE NUMBER	LIST PRICE
<i>Add Box/Box/File or File/File</i> P40M	688
<i>Add Lateral File 29" W</i> P41M	853
<i>Add Multi-File - 31"W</i> P42M	963
<i>Add Storage With Doors 29"W</i> P43M	765
<i>Add CPU /Printer Cabinet - Open</i> P44M	875

**SPECIFICATIONS**  
- Multi-file specify Box/Box Left or Right

**Notes**  
- Add additional Standard Cabinets To Kneespace Area.

PEDESTAL MODIFICATIONS

MODIFY DRAWER CONFIGURATIONS

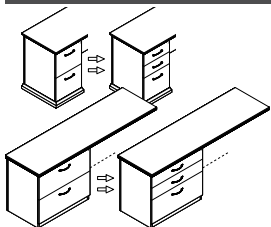

Available: - All DARRAN Collections. Excludes Rail.

STYLE NUMBER	LIST PRICE
<i>File/File to Box/Box/File</i> P6	50 per pedestal
<i>Box/Box/File to File/File</i> P6	50 per pedestal
<i>Lateral File to 2 Box Drawers</i> P8	95 per pedestal

**SPECIFICATIONS**  
- Modify File/File To Box/Box/File - Any Unit

**PEDESTAL MODIFICATIONS**

**MODIFY DRAWER CONFIGURATIONS**

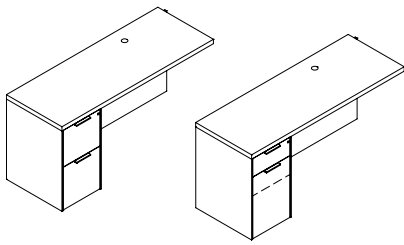

**STYLE NUMBER**

*File/File to Box/Box/File*

P6H

*Lateral File to 2 Box Drawers*

P8

**LIST PRICE**

95 per pedestal

95 per pedestal

**SPECIFICATIONS**

- Modify File/File To Box/Hidden Box/File - Any Unit

Available: - Rift

**POWER / DATA**

**POWER SUPPLY CORDSET**

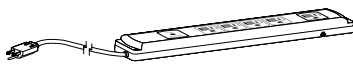

**STYLE NUMBER**

PD717

**LIST PRICE**

95

**SPECIFICATIONS**

- SIZE: 10.75"L x 2.0"W x 1.06"H

- (5) Outlets w/ 10' cord

- Surge suppression (720 Joules)

- 15 Amp breaker

- Available on: Vertical Panels, Cabinet Interiors, and under tops

Available: - All DARRAN Collections

**PRODUCT MODIFICATIONS**

**MODIFY WIDTH - OPEN KNEESPACE**

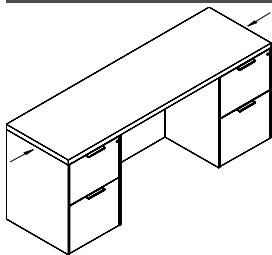

**STYLE NUMBER**

MOD-1

**LIST PRICE**

125

**SPECIFICATIONS**

- Modify width down on any unit with an open kneespace: desk, workstation credenza, bridge, return

Available: - All DARRAN Collections

**PRODUCT MODIFICATIONS**

**MODIFY WIDTH - OPEN/CLOSED STORAGE**

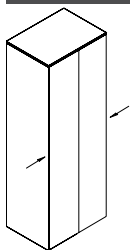

**STYLE NUMBER**

MOD-2

**LIST PRICE**

250

**SPECIFICATIONS**

- Modify width down on any unit with open or closed storage section: overheads, wall hung units, storage credenzas, towers

Available: - All DARRAN Collections

**PRODUCT MODIFICATIONS** **MODIFY WIDTH - OUTSIDE OF MOD-1, MOD-2**

STYLE NUMBER	LIST PRICE	SPECIFICATIONS
MOD-3	Contact Factory for Pricing	- Width modification outside of MOD-1 & MOD-2

Available: - All DARRAN Collections

**PRODUCT MODIFICATIONS** **MODIFY WIDTH - TACKBOARD, SLAT WALL, VENEER PANEL, OR A GLASSBOARD**

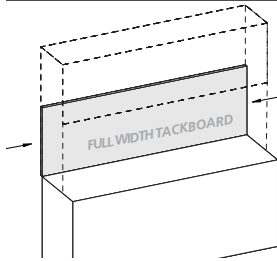

STYLE NUMBER	LIST PRICE	SPECIFICATIONS
MOD-4	50	- Modify width down on tackboard, slat wall, veneer panel, or a overhead glassboard

Available: - All DARRAN Collections

**PRODUCT MODIFICATIONS** **MODIFY DEPTH - DECREASE DEPTH**

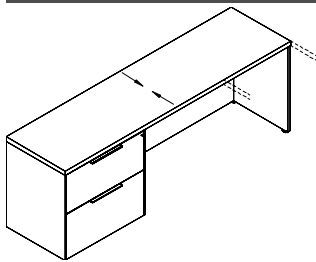

STYLE NUMBER	LIST PRICE	SPECIFICATIONS
MOD-5	125	- Modify depth down (minimum depth for a unit with drawers is 21"D)
<b>Notes</b>		
- Ex. 24" to 21", 30" to 24", and 36" to 30"		

Available: - All DARRAN Collections

**PRODUCT MODIFICATIONS** **MODIFY DEPTH - INCREASE DEPTH**

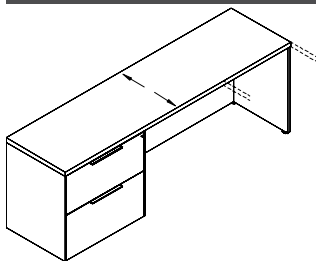

STYLE NUMBER	LIST PRICE	SPECIFICATIONS
MOD-6	Add 10%	- Increase depth
<b>Notes</b>		
- Ex. 24" to 30", 30" to 36", and 36" to 42"		

Available: - All DARRAN Collections. Excludes Rift.

**PRODUCT MODIFICATIONS**

**MODIFY HEIGHT**

**STYLE NUMBER**  
MOD-7

**LIST PRICE**  
Contact Factory  
for Pricing

**SPECIFICATIONS**  
- Modify height of a unit

Available: - All DARRAN Collections

**PRODUCT MODIFICATIONS**

**MODIFY CONFERENCE TABLE LENGTH AND WIDTH - 1 PIECE TOP**

**STYLE NUMBER**  
MOD-8

**LIST PRICE**  
125

**SPECIFICATIONS**  
- Modify length/width down on a 1 piece table top

Available: - Conferencing

**PRODUCT MODIFICATIONS**

**MODIFY CONFERENCE TABLE LENGTH AND WIDTH - 2/3 PIECE TOP**

**STYLE NUMBER**  
MOD-9

**LIST PRICE**  
250

**SPECIFICATIONS**  
- Modify length/width down on a 2 or 3 piece table top

Available: - Conferencing

**REFRIGERATOR MODIFICATION**

**REFRIGERATOR CABINET MODIFICATION**

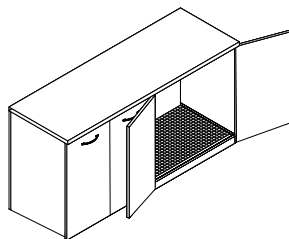

**STYLE NUMBER**  
REF01

**LIST PRICE**  
195

**SPECIFICATIONS**  
- Open back cutout for venting  
- Moisture sponge mat  
- Contaminate ledge  
- Contact customer service for maximum refrigerator size  
(Changes based on unit).

Available: - Storage Credenzas

**SHAPED TOPS** **OVERHEAD/WALL HUNG SHAPED TOP**

STYLE NUMBER	LIST PRICE	SPECIFICATIONS
<b>99"W - 105"W</b>		- Shaped tops for overheads and wall hungs
TOH-1	405	
<b>58"W - 93"W</b>		
TOH-2	315	
<b>29"W - 47"W</b>		
TOH-3	203	

Available: - Central Park, Rail

**SHAPED TOPS** **BOOKCASE SHAPED TOP**

STYLE NUMBER	LIST PRICE	SPECIFICATIONS
<b>29"W - 35"W x 15"D</b>		- 15" D Shaped tops for bookcases
TOH-4	203	- Shaped on front

Available: - Central Park, Rail

**SHAPED TOPS** **TOWER SHAPED TOP**

STYLE NUMBER	LIST PRICE	SPECIFICATIONS
<b>16" Single Width Tower</b>		- 24" deep shaped tops for towers
TOH-5	158	- Shaped on front
<b>29"W - 46"W Tower</b>		
TOH-6	203	

Available: - Central Park, Rail

**SHAPED TOPS** **WORKSURFACE SHAPED TOP**

STYLE NUMBER	LIST PRICE	SPECIFICATIONS
<b>Shape Four Sides</b>		- S4S Applies to desk, bridge or any freestanding unit. This adds shapes or copes to two sides (desk, bridges) or one side and back of units (returns).
S4S	50	
<b>Shape Three Sides</b>		- S3S Applies to credenza units. This adds shapes to the two sides.
S3S	50	- Credenzas are shaped front standard with flat back
		<b>Notes</b>
		- Desk, Freestanding and Credenza units will grow 1" in width due to adding shapes on ends of units.

Available: - Central Park

**SHAPED TOPS** **PREMIUM EDGE - SHAPED WORKSURFACE TOP**

STYLE NUMBER	LIST PRICE	SPECIFICATIONS
<i>Shape Four Sides Premium Edge</i>		
S4S-PE	Add 10%	- S4S-PE Applies to desk, bridge or any freestanding unit. This adds shapes or copes to two sides (desk, bridges) or one side and back with hardwood rims (returns).
<i>Shape Three Sides Premium Edge</i>		
S3S-PE	Add 10%	- S3S-PE Shape Three Sides Premium Edge. Applies to credenza units. This adds shape to the two sides with hardwood rims.
<b>Notes</b>		
- Desk, Freestanding and Credenza units will grow 1" in width due to adding shapes on ends of units.		

\* 10% Upcharge includes 5% for premium edge

Available: - Central Park

**SHELF MODIFICATIONS** **GLASS SHELVES - TEMPERED FULL WIDTH 26" - 35"**

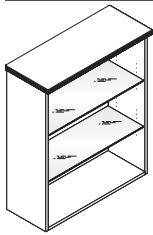

STYLE NUMBER	LIST PRICE	SPECIFICATIONS
<i>26"W - 35"W x 14"D Shelf</i>		
GS14F	85	- Glass Shelves Replace Wood Shelf In Open Or Glass Door Cabinet. Also Order Interior Cabinet Lighting.

Available: - All DARRAN Collections

**SHELF MODIFICATIONS** **TEMPERED GLASS SHELVES FOR HALF CABINET 17- 1/2" WIDTHS**

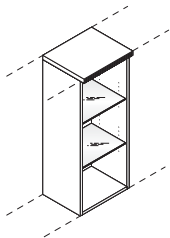

STYLE NUMBER	LIST PRICE	SPECIFICATIONS
<i>14-1/2"W - 17- 1/2"W x 14"D Shelf</i>		
GS14H	65 ea	- Glass Shelves Replace Wood Shelf In Open Or Glass Door Cabinet. Also Order Interior Cabinet Lighting.

**Notes**  
- Replace only adjustable shelves between cabinet light and fixed lower wood shelf.

Available: - All DARRAN Collections

**SHELF MODIFICATIONS** **CURVED CORNER GLASS SHELF**

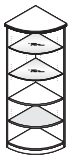

STYLE NUMBER	LIST PRICE	SPECIFICATIONS
GS14CC	85 ea	- Curved shelves feature glass retainer clips to prevent tipping

**Notes**  
- Replace only adjustable shelves between cabinet light and fixed lower wood shelf.

Available: - All DARRAN Collections. Excludes Rail.

**SHELF MODIFICATIONS**

**HEAVY DUTY SOLID WOOD BOOKCASE REPLACEMENT SHELVES**

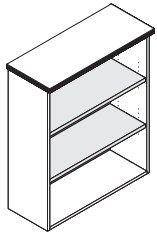

**STYLE NUMBER**  
**1" Wood Shelf 14" Deep**  
 S714F  
**1" Wood Shelf 24" Deep**  
 S714FX

**LIST PRICE**  
 75 ea  
 150 each

**SPECIFICATIONS**  
 - 1" Solid Lumber Core Shelves Replace Standard 3/4" Plywood  
 Adjustable And Fixed Shelves

Available: - All DARRAN Collections. Excludes Rail.

**SLAT WALL ACCESSORIES**

**SLAT WALL ACCESSORY TRAY**

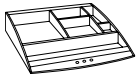

**STYLE NUMBER**  
 SWA9

**LIST PRICE**  
 45

**SPECIFICATIONS**  
 - Specify Black Or Matte Silver

Available: - All DARRAN Collections. Excludes Rail.

**SLAT WALL ACCESSORIES**

**SLAT WALL FOLDER TRAY**



**STYLE NUMBER**  
 SWA7

**LIST PRICE**  
 45

**SPECIFICATIONS**  
 - Specify Black Or Matte Silver

Available: - All DARRAN Collections. Excludes Rail.

**SLAT WALL ACCESSORIES**

**SLAT WALL PAPER TRAY**



**STYLE NUMBER**  
 SWA2

**LIST PRICE**  
 35

**SPECIFICATIONS**  
 - Specify Black Or Matte Silver

Available: - All DARRAN Collections. Excludes Rail.

SLAT WALL ACCESSORIES

SLAT WALL PENCIL HOLDER



**STYLE NUMBER**  
SWA4

**LIST PRICE**  
25

**SPECIFICATIONS**  
- Specify Black Or Matte Silver

Available: - All DARRAN Collections. Excludes Rail.

SPECIALTY VENEER ACCENTS

BLACK EBONY WOOD INLAY IN ONE PIECE CONFERENCE TOP

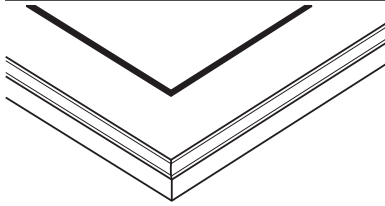

**STYLE NUMBER**  
*One Piece Conference Top*  
T30  
*Two Piece Conference Top*  
T31

**LIST PRICE**  
735  
  
1480

**SPECIFICATIONS**  
- Standard veneer top is routed for Ebony wood inlay 1/8" x 3/16" width line. Inlay wood is miter jointed in the corners, hand fitted, glued and sanded flush with top veneer. Inlay forms a 3" border to top edge

**Notes**  
- Hand fitted miter corner Black Ebony wood inlay installed in standard wood veneer tops

Available: - Conferencing Tops.

SPECIALTY VENEER ACCENTS

BLACK/WHITE/BLACK WOOD INLAY

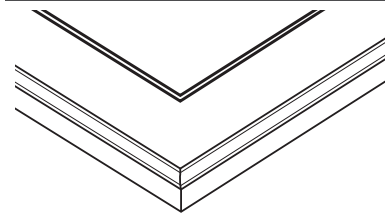

**STYLE NUMBER**  
*One Piece Top*  
T30BWB  
*Two Piece Top*  
T31BWB

**LIST PRICE**  
950  
  
1795

**SPECIFICATIONS**  
- Standard veneer top is routed for wood inlay 1/8" x 3/16" width line. Each color is 1/16" wide. White inlay line is finished over providing a subtle contrast to line detail

**Notes**  
- Hand fitted miter corner ebony-maple-ebony wood inlay installed in standard veneer top  
- The center white line can be masked off preventing color stains from penetrating. Final top coats are applied over the white line.

Available: - Conferencing Tops

SPECIALTY VENEER ACCENTS

BLACK EBONY WOOD INLAY W/ WOOD FAN DETAIL - 1 PIECE CONFERENCE TABLE TOP

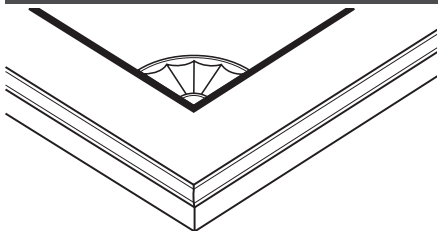

**STYLE NUMBER**  
*One Piece Top*  
T51  
*Two Piece Top*  
T52

**LIST PRICE**  
1160  
  
2110

**SPECIFICATIONS**  
- Standard veneer top is routed for wood inlay 1/8" x 3/16" width line. With each 90 degree corner routed for Quarter circle fan inlays. Inlay fans combined with solid black inlay preserves an old traditional appearance. Fans are handcrafted from teakwood, rosewood, mahogany, and other exotic woods. Each piece of veneer is shaded by burning and is hand fitted to a perfect fan shape - truly and old world craft  
- Conference tables: 4 fans, one in each corner per top section

**Notes**  
- Hand fitted miter corner wood inlay and fan installed in standard veneer top  
- Only available on square/ rectangle tops

Available: - Conferencing Tops



**SPECIALTY VENEER ACCENTS**

**CROTCH MAHOGANY INFIELD WITH MITERED BORDER**



**STYLE NUMBER**

- TCB-1 - 84 x 36/42
- TCB-2 - 72 x 36/42
- TCB-3 - 72 x 30/36

**LIST PRICE**

- 1895
- 1795
- 1695

**SPECIFICATIONS**

- Center balanced butt and book matched crotch mahogany
- 35 sheen non-rubbed finish ensures maximum durability

Available: - Jamestown, Prado

**SPECIALTY VENEER ACCENTS**

**CROTCH MAHOGANY DESK PEDESTAL FRONTS**

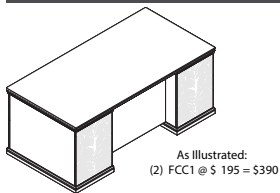

Desk Approach  
Pedestal Fronts

**STYLE NUMBER**

FCC1

**LIST PRICE**

195 per pedestal

**SPECIFICATIONS**

- Center balanced butt and book matched crotch mahogany
- 35 sheen non-rubbed finish ensures maximum durability

Available: - Jamestown, Prado

**SPECIALTY VENEER ACCENTS**

**CROTCH MAHOGANY DRAWER FRONTS**

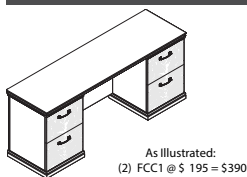

Box/Box/File or File/File  
Drawer Fronts

**STYLE NUMBER**

FCC1

**LIST PRICE**

195 per pedestal

**SPECIFICATIONS**

- Center balanced butt and book matched crotch mahogany
- 35 sheen non-rubbed finish ensures maximum durability

Available: - Jamestown, Prado

**SPECIALTY VENEER ACCENTS**

**CROTCH MAHOGANY DOUBLE WIDTH PANEL FRONTS**



All Three Illustrations Represent: (1) FCC2 @ \$395

30-32-36 Width  
FCC-2 \$395 per Panel Set

**STYLE NUMBER**

FCC2

**LIST PRICE**

395 per Panel Set

**SPECIFICATIONS**

- Center balanced butt and book matched crotch mahogany
- 35 sheen non-rubbed finish ensures maximum durability

Available: - Jamestown, Prado

**SPECIALTY VENEER ACCENTS**

**CROTCH MAHOGANY DOUBLE WIDTH/ DOUBLE HEIGHT FRONTS**



**STYLE NUMBER**  
FCC3

**LIST PRICE**  
895 per Panel Set

**SPECIFICATIONS**  
- Center balanced butt and book matched crotch mahogany  
- 35 sheen non-rubbed finish ensures maximum durability

Both Illustrations Represent:  
(1) FCC3 @ \$895 - Panel Set  
52" Center Balance Butt & Bookmatch  
30-36 Width  
FCC-3 \$895 per Panel Set

Available: - Jamestown, Prado

**SPECIALTY VENEER ACCENTS**

**RECTANGLE INLAY - RECESSES DURA-LEATHER WRITING SURFACE**

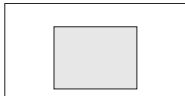

RECTANGLE INLAY

**STYLE NUMBER**  
RL-29A

**LIST PRICE**  
895

**SPECIFICATIONS**  
- Recessed inlay desk pads are covered with Alomost Leather from Paul Brayton Designs.  
- DARRAN will gladly custom quote other inlay materials ie: solid surfaces, biocomposites, metallic laminates, or genuine leather to match seating

Available: - All DARRAN Collections

**SPECIALTY VENEER ACCENTS**

**BOWFRONT INLAY - RECESSES DURA-LEATHER WRITING SURFACE**

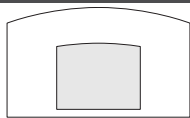

BOWFRONT INLAY

**STYLE NUMBER**  
RL-31A

**LIST PRICE**  
995

**SPECIFICATIONS**  
- Recessed inlay desk pads are covered with Alomost Leather from Paul Brayton Designs.  
- DARRAN will gladly custom quote other inlay materials ie: solid surfaces, biocomposites, metallic laminates, or genuine leather to match seating

Available: - All DARRAN Collections

**SPECIALTY VENEER ACCENTS**

**RECTANGLE INLAY - EBONY HARDWOOD INLAY DETAIL**

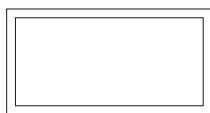

RECTANGLE INLAY

**STYLE NUMBER**  
T10SA

**LIST PRICE**  
895

**SPECIFICATIONS**  
- 3/16" x 3/16" thick hardwood ebony inlay is handfitted and glued into routed top and sanded flush with surface  
- Inlay is finished over with all finish steps

**Notes**  
- Ebony inlay not recommended in: Koko Cherry

Available: - All DARRAN Collections

**SPECIALTY VENEER ACCENTS**

**BOWFRONT INLAY - EBONY HARDWOOD INLAY DETAIL**

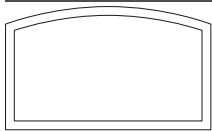

CURVED INLAY

**STYLE NUMBER**  
T11SA

**LIST PRICE**  
995

**SPECIFICATIONS**  
- 3/16" x 3/16" thick hardwood ebony inlay is handfitted and glued into routed top and sanded flush with surface  
- Inlay is finished over with all finish steps

**Notes**  
- Ebony inlay not recommended in: Koko Cherry

Available: - All DARRAN Collections

**TOOL CHANNEL ACCESSORIES**

**RECESSED ALUMINUM TOOL CHANNEL**

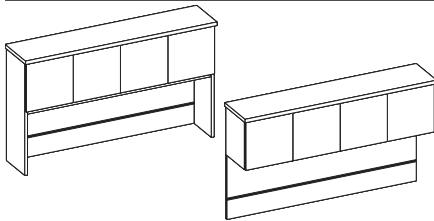

**STYLE NUMBER**  
ATB02

**LIST PRICE**  
5 per 1"W

**SPECIFICATIONS**  
- Anodized aluminum finish  
- Fully recessed  
- Finish matches anodized aluminum accessories  
- Can be specified with fabric tack surface mounted above channel

**Notes**  
- If using tool channel with wallhung overhead, a veneer panel must be specified.

Available: - All DARRAN Collections. Excludes Rail.

**TOOL CHANNEL ACCESSORIES**

**FILE HOLDER**



**STYLE NUMBER**  
ATB37

**LIST PRICE**  
105

**SPECIFICATIONS**  
- For Console/Wall Hung Back Panels With Optional Tool Bar  
- 18 Gauge Steel - Stamp Formed  
- Silver Powderdercoat Finish

Available: - All DARRAN Collections. Excludes Rail.

**TOOL CHANNEL ACCESSORIES**

**IPHONE HOLDER**



**STYLE NUMBER**  
ATB31

**LIST PRICE**  
120

**SPECIFICATIONS**  
- For Console/Wall Hung Back Panels With Optional Tool Bar  
- 18 Gauge Steel - Stamp Formed  
- Silver Powderdercoat Finish  
- 5" x 3 -3/4"W  
- Non-slip Neoprene pad

Available: - All DARRAN Collections. Excludes Rail.

**TOOL CHANNEL ACCESSORIES**

**LARGE SHELF**

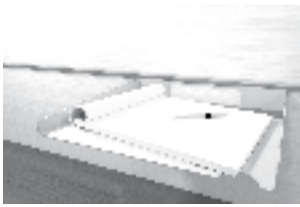

**STYLE NUMBER**  
ATB35

**LIST PRICE**  
125

**SPECIFICATIONS**  
- 12"W x 10"D

Available: - All DARRAN Collections. Excludes Rail.

**TOOL CHANNEL ACCESSORIES**

**PENCIL PEN HOLDER**



**STYLE NUMBER**  
ATB38

**LIST PRICE**  
115

**SPECIFICATIONS**  
- For Console/Wall Hung Back Panels With Optional Tool Bar  
- 18 Gauge Steel - Stamp Formed  
- Silver Powdercoat Finish  
- 5"H x 4"W x 4"D

Available: - All DARRAN Collections. Excludes Rail.

**TOOL CHANNEL ACCESSORIES**

**SMALL SHELF**



**STYLE NUMBER**  
ATB36

**LIST PRICE**  
110

**SPECIFICATIONS**  
- 12"W x 6 -3/4"D

Available: - All DARRAN Collections. Excludes Rail.

**TOOL CHANNEL ACCESSORIES**

**TABLET HOLDER**

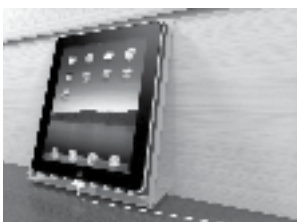

**STYLE NUMBER**  
ATB30

**LIST PRICE**  
135

**SPECIFICATIONS**  
- For Console/Wall Hung Back Panels With Optional Tool Bar  
- 18 Gauge Steel - Stamp Formed  
- Silver Powdercoat Finish  
- 10" x 8"W  
- Non-slip Neoprene pad

Available: - All DARRAN Collections. Excludes Rail.

TOP MODIFICATION

1/4" RECTANGLE SOFT ETCH GLASS RUNOFF WORKSURFACE

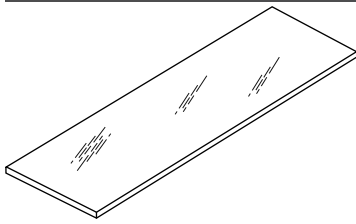

STYLE NUMBER

SEGW8436  
 SEGW8430  
 SEGW7836  
 SEGW7830  
 SEGW7230  
 SEGW6630  
 SEGW6030

LIST PRICE

2210  
 1870  
 2070  
 1750  
 1630  
 1515  
 1395

SPECIFICATIONS

- 1/4" Soft etch glass  
 - Back painted white glass

Notes

- Additional colors can be custom quoted. Contact factory for pricing.

Available: - Rift Runoff Worksurface

TOP MODIFICATION

TOP APRON RAIL

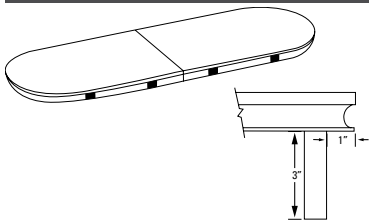

STYLE NUMBER

TAR

LIST PRICE

Add 10% to top price for apron only

SPECIFICATIONS

- 3 x 3/4 thick apron rail is set back under top 1"  
 - Apron rail is recommended for fixed port installation for power/data support.

Notes

- Select power/data support separately.  
 - See power options for available apron power: UDT2/VD-SM

Available: - Conferencing Tops Only

TOP MODIFICATION

TOP APRON RAIL

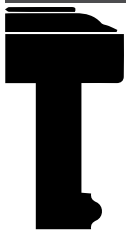

STYLE NUMBER

TAR-M

LIST PRICE

Add 15% (Apron rail with beltline detail)

SPECIFICATIONS

- Traditional with apron rail and molding - available in Cherry and Walnut.

Notes

- Select power/data support separately.  
 - See power options for available apron power: UDT2/VD-SM

Available: - Conference tops only

WIRE MANAGEMENT

HORIZONTAL J-CHANNEL WIRE MANAGEMENT RACEWAY

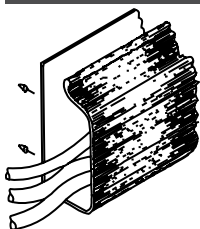

STYLE NUMBER

W1

LIST PRICE

75 Per 4 Foot Section

SPECIFICATIONS

- 4' section for field installation.  
 - The "J" shape black thermoplastic wire raceway may be added to specified worksurface tops to provide concealed channeling of wires to and from worksurface grommets. For use in open kneespace areas, raceway is attachable to top of back panel with pan head screws. Interior dimensions are 1" x 1- 1/2" providing ample storage for multiple wires and excess cable. Front of raceway flexes out for easy cord insertion.

Notes

- Units w/ Wire Channel Standard.  
 - Field Installation

Available: - All DARRAN Collections.

WIRE MANAGEMENT

HORIZONTAL U-CHANNEL WIRE MANAGEMENT RACEWAY



**STYLE NUMBER**  
W2A

**LIST PRICE**  
75 Per 4 Foot Section

**SPECIFICATIONS**  
- 4' section for field installation.

**Notes**  
- Units w/ Wire Channel Standard.  
- Field Installation

Available: - All DARRAN Collections.

WIRE MANAGEMENT

COIL WIRE MANAGER



**STYLE NUMBER**  
W18

**LIST PRICE**  
150

**SPECIFICATIONS**  
- Weighted Base, Table attachment plate  
- 39- 1/2" Length  
- Black

**Notes**  
- Location

Available: - All DARRAN Collections.

WIRE MANAGEMENT

STANDARD LOCATION GROMMETS - FACTORY INSTALLED

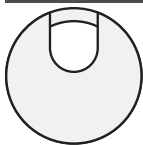

**STYLE NUMBER**  
*Standard Location Grommet*

**Black**  
TM30

**Silver**  
TM31

**Antique Brass**  
TM33

**White**  
TM34

**LIST PRICE**

45

45

45

45

45

**SPECIFICATIONS**  
- 1 -5/8" Metal Grommet

**Notes**  
- \*Units w/ Grommets Standard Are Noted Under Standard Features. Grommets Match Pull Finish - Standard (Unless Specified Otherwise)

Available: - All DARRAN Collections.

WIRE MANAGEMENT

NON-STANDARD LOCATION GROMMETS - FACTORY INSTALLED

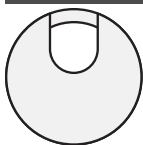

**STYLE NUMBER**  
*Non-Standard Location Grommet*

**Black**  
TM30 -NS

**Silver**  
TM31 -NS

**Antique Brass**  
TM33 -NS

**White**  
TM34 -NS

**LIST PRICE**

90

90

90

90

90

**SPECIFICATIONS**  
- 1 -5/8" Metal Grommet

**Notes**  
- \*Units w/ Grommets Standard Are Noted Under Standard Features. Grommets Match Pull Finish - Standard (Unless Specified Otherwise)

Available: - All DARRAN Collections

**WIRE MANAGEMENT**

**BLACK PLASTIC VERTICAL SURFACE GROMMETS - FACTORY INSTALLED**



STYLE NUMBER	LIST PRICE	SPECIFICATIONS
<i>Standard Location Grommet</i>		- 2 " Black Plastic Grommet
TM50-C	45	<b>Notes</b> - Standard Location is Bottom Center
<i>Non-Standard Location Grommet</i>		
TM50-NS	90	

Available: - All DARRAN Collections

**WORKSTATION**

**CLIENT PULLOUT WRITING SHELF**

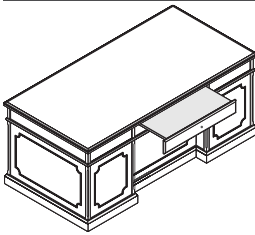

STYLE NUMBER	LIST PRICE	SPECIFICATIONS
CP-1	425	- CP-1: Client pull-out writing shelf for executive chassis desk
CP-2	625	- CP-2: Client pull-out writing shelf for conference desk

Available: - Jamestown

**AIRCHARGE WIRELESS CHARGING GROMMET**

STYLE NUMBER	LIST PRICE
 ACWG WIRELESS GROMMET	\$575
ACWR WIRELESS RECEIVER W/ LIGHTNING CABLE	\$170



**SPECIFICATIONS**

- AirCharge offers a convenient way to charge any Qi compatible smartphone or device without the need to carry charging cables or find an available power outlet. Devices not equipped with the Qi technology, can be adapted to accept a charge from the grommet with the AirCharge Wireless Receiver.
- Size: 3.33”DIA x .75”D
- Compatible with an Qi rated device, Contact Customer Service for compatibility list
- Non-Qi device can be adapted to accept AirCharge unit with an ACWR AirCharge Wireless Receiver (compatible with iPhone)
- Surface Mount
- 78” Cord
- Standard Black Aluminum Finish; Available in White Aluminum or Black Finish upon request

**AVAILABLE**

- All Darran Collections

AirCharge Wireless Grommet



iphone w/ ACWR



Black Aluminum



Black Finish



White Aluminum



## COVE POWER UNIT - NON-LINKING

STYLE NUMBER	LIST PRICE
 PD COVE PLUG Non-Linking Version	\$550

**SPECIFICATIONS**

- Size 5.75" L x 2.5" W
- (2) 15 Amp Receptacles and (2) USB charging ports
- Surface Mount
- 108" Cord
- Standard Silver Finish, Available in White or Black Finish upon request
- ETL Listed

**AVAILABLE**

- All Darran Collections



## COVE POWER UNIT WITH DAISYLINK

## STYLE NUMBER

## LIST PRICE

## STARTER UNITS



## COV-DCH HARDWIRED

\$710

Includes (1) Cove unit with Hardwire Infeed - 120"



## COV-DCP PLUG

\$800

Includes (1) Cove unit with Plug infeed - Includes 72" Cord and 32" Infeed Jumper for 104" total cord infeed

## ADDITIONAL LINKING UNITS

## COV-DCL

\$575 EACH

Includes Linking Cove unit and Jumper up to 96", cable length determined by the top size

## SPECIFICATIONS

- Size: 5.75" L x 2.5" W
- (2) 15 Amp Receptacles and (2) 2.1 Amp USB charging ports
- Surface Mount
- Max Daisy Chain - Hardwire - (9) units; Plug/Corded - (4) units
- Standard Silver Finish, Available in White or Black Finish upon request
- ETL Listed

## AVAILABLE

- All Darran Collections



**COVE CORDED SERIES**

**STYLE NUMBER**

**LIST PRICE**



PD-COVE-PKO

\$800



**SPECIFICATIONS**

- Size 9.5”L x 2.5”W x 3.18”D
- (2) Power Receptacles, (2) 2.1 Amp USB charging ports and (1) Telecom Plate Knockout
- Surface Mount
- 108” Cord
- Standard Silver Finish, Available in White or Black Finish upon request
- ETL Listed

**AVAILABLE**

- All Darran Collections

**TELECOM PLATES**



*THIS POD CAN HAVE UP TO 1 TOTAL PLATES*

**STYLE NUMBER**

**LIST PRICE**

RJ45 (1)	\$35
RJ45 (2)	\$70
RJ45 (3)	\$105
USB (1)	\$70
USB (2)	\$140
RJ11/RJ45	\$70
RJ45/USB	\$105
RJ45/HDMI	\$190
HDMI/DVI	\$325
HDMI/USB	\$205
HDMI/VGA	\$240
VGA/MINI-STEREO	\$155
VGA/USB	\$175

## PDFAA FLUSH DATA BAY ANODIZED ALUMINUM DOOR

STYLE NUMBER	LIST PRICE
 PDFAA-H Hardwired	\$1195
 PDFAA-C Plug	\$1195
 PDFAA-DC Daisy Chain	\$1395

Features convenience plug on bottom - Max Daisy chain (4) units  
 - Specify hardwired or plug for the first unit in series, daisy chained units will have a plug for connection through convenience plug.

## SPECIFICATIONS

- Size 13.75"L x 6.375"W x 2.85"D
- (4) 15 Amp receptacles
- Surface Mount
- Standard Interior Black Finish
- Specify up to (4) Telecom Plates; (2) on side and (2) on bottom
- Corded units are UL Listed and CSA Certified. Hardwired Units are CSA Certified



## AVAILABLE



- All Darran Collections
- Excludes Rail, Grove

## TELECOM PLATES

*THIS POD CAN HAVE UP TO 4 TOTAL PLATES*

STYLE NUMBER	LIST PRICE
RJ45 (1)	\$35
RJ45 (2)	\$70
RJ45 (3)	\$105
USB (1)	\$70
USB (2)	\$140
RJ11/RJ45	\$70
RJ45/USB	\$105
RJ45/HDMI	\$190
HDMI/DVI	\$325
HDMI/USB	\$205
HDMI/VGA	\$240
VGA/MINI-STEREO	\$155
VGA/USB	\$175

**PDFAF FLUSH DATA BAY FROSTED GLASS DOOR WITH DAISYLINK**

STYLE NUMBER	LIST PRICE
 PDFAF-H HARDWIRED	\$1095
 PDFAF-C PLUG	\$1095
 PDFAF-DC DAISY CHAIN	\$1295

Features convenience plug on bottom - Max Daisy chain (4) units  
 - Specify hardwired or plug for the first unit in series, daisy chained units will have a plug for connection through convenience plug.



**SPECIFICATIONS**

- Size 13.75”L x 6.375”W x 2.85”D
- (4) 15 Amp receptacles
- Surface Mount
- Standard Interior Black Finish
- Specify up to (4) Telecom Plates; (2) on side and (2) on bottom
- Corded units are UL Listed and CSA Certified. Hardwired Units are CSA Certified

**AVAILABLE**

- All Darran Collections
- Excludes Rail, Grove



**TELECOM PLATES**

*THIS POD CAN HAVE UP TO 4 TOTAL PLATES*

STYLE NUMBER	LIST PRICE
RJ45 (1)	\$35
RJ45 (2)	\$70
RJ45 (3)	\$105
USB (1)	\$70
USB (2)	\$140
RJ11/RJ45	\$70
RJ45/USB	\$105
RJ45/HDMI	\$190
HDMI/DVI	\$325
HDMI/USB	\$205
HDMI/VGA	\$240
VGA/MINI-STEREO	\$155
VGA/USB	\$175

**REEF POWER UNIT WITH DAISYLINK**

**STYLE NUMBER**

**LIST PRICE**



REF310 PLUG

\$1100

**SPECIFICATIONS**

- Size 16.1”L x 6.25”W x 4.89”D
- (3) 120V Receptacles, (2) USB charging ports and (2) Knockouts for RJ45 Data Ports
- Surface Mount
- 108” Cord
- Features Convenience Plug on bottom of unit that allows for max (3) Daisy Chain
- Standard Black Finish, Available in White or Silver Finish upon request
- Additional Telecom Plate Knockout
- When used with Grove Tables an additional \$350 LIST will apply for the special cutout required.
- RJ45 for Knockouts not required. If not ordered a small hole will be present in this this location
- ETL Listed

**AVAILABLE**

- Grove
- Conferencing



**TELECOM PLATES**

*THIS POD CAN HAVE UP TO 1 TOTAL PLATES*

STYLE NUMBER	LIST PRICE
RJ45 (1)	\$35
RJ45 (2)	\$70
RJ45 (3)	\$105
USB (1)	\$70
USB (2)	\$140
RJ11/RJ45	\$70
RJ45/USB	\$105
RJ45/HDMI	\$190
HDMI/DVI	\$325
HDMI/USB	\$205
HDMI/VGA	\$240
VGA/MINI-STEREO	\$155
VGA/USB	\$175



## SECLUSION CORDED POWER UNIT NON-LINKING

## STYLE NUMBER

## LIST PRICE



P2SECL

\$245

Choose from plate mount or clamp mount (seen in photo)

## SPECIFICATIONS

- Size: 3.5"L x 2.2"D x 2.5"H
- (2) Power Receptacles
- Worksurface Clamp Mount or Plate Under Surface Mount
- Clamp Accessory accommodates table thickness up to 2"
- 72" Cord
- Standard Silver Finish, Black Finish available upon request
- UL/UCL Listed

## AVAILABLE

- All Darran Collections



Clamp Mount

**UDT POWER UNIT - NON-LINKING**

STYLE NUMBER	LIST PRICE
 <b>UDT2/VD-SM PLUG</b> Non-Linking	\$350



**SPECIFICATIONS**

- Size 6.5"L x 2.81"D x 1.26"H
- (2) Power receptacles and (1) Telecom Plate Cutout
- Side Mount, if Top Mount is required contact customer service
- 72" Cord
- Standard Black Powdercoat Finish
- Used in Apron Rails
- UL Listed

**AVAILABLE**

- Conferencing Apron Rails

**TELECOM PLATES**

*THIS POD CAN HAVE UP TO 1 TOTAL PLATES*

STYLE NUMBER	LIST PRICE
RJ45 (1)	\$35
RJ45 (2)	\$70
RJ45 (3)	\$105
USB (1)	\$70
USB (2)	\$140
RJ11/RJ45	\$70
RJ45/USB	\$105
RJ45/HDMI	\$190
HDMI/DVI	\$325
HDMI/USB	\$205
HDMI/VGA	\$240
VGA/MINI-STEREO	\$155
VGA/USB	\$175



## VILLA POWER UNIT - NON-LINKING

STYLE NUMBER	LIST PRICE
 VIL-C PLUG Non-Linking	\$515

## SPECIFICATIONS

- Size: Top Grommet 5.68"L X 3.39"W; Under Top 12"L x 3.13"W x 3.08"D
- (2) Power receptacles; (2) USB charging ports and (1) Knockouts for RJ45 Data Ports
- Surface Mount
- 72" Cord (Longer cord available, contact Customer Service)
- Standard Silver Finish, Black Finish available upon request
- UL or ETL Certified

## AVAILABLE

- All Darran Collections
- Excludes Grove

## RJ45 KNOCKOUT

STYLE NUMBER	LIST PRICE
RJ45 (1)	\$35



**VILLA POWER UNIT WITH DAISYLINK**

**STYLE NUMBER LIST PRICE**

**STARTER UNITS**



**VIL-DCH HARDWIRED** \$600  
Includes (1) Villa unit with 120" Hardwire Infeed



**VIL-DCP PLUG** \$695  
Includes (1) Villa with Plug Infeed - Includes 72" Cord and 32" Infeed Jumper for 104" total cord infeed

**ADDITIONAL LINKING UNITS**

**VIL-DCL ADDITIONAL** \$590  
(Includes linking Villa and Jumper cable up to 96")



**SPECIFICATIONS**

- Size: Top Grommet 5.68" L X 3.39"W; Under Top 12"L x 3.13"W x 3.08"D
- (4) Power receptacles; (2) surface and (2) undersurface, (2) 2.1A USB charging ports and (1) Knockout for RJ45 Data Port
- Surface Mount
- Daisy Chain - Hardwire Max (10) Units, Plug/Corded Max (5) Units
- Standard Silver Finish, Black Finish available upon request
- UL or ETL Certified

**AVAILABLE**

- All Darran Collections
- Excludes Grove



**RJ45 KNOCKOUT**

STYLE NUMBER	LIST PRICE
RJ45 (1)	\$35