

DARREN

# NOT SO square Office

price list | effective January 2016 | updated 1.19.17



## NOT SO SQUARE OFFICE PRICE LIST REVISIONS

DATE	PAGE	MODIFICATION	DESCRIPTION
4.21.16	13	Finishes	Removed Toasted Coconut On Ash for "M" Thermally Fused Laminate
5.4.16	ALL	Removed K1, Added K31	All "K1: Center Drawer - \$275" options are now "K31: Center Drawer - \$195"
7.20.16	ALL	Discontinued finishes	Removed discontinued finishes MGS, WGA, WTA, WWA, GRC
7.20.16	ALL	Added finishes	Added new finishes MST and GST
7.29.16	13	Removed Flat Edge	Removed flat edge on HPL tops
8.26.16	N/A	Edited Tackboards	Half size overhead tackboard SKUs and sizes have been corrected
12.7.16	60	Added Product	Added PD423 Pedestal

**TABLE OF CONTENTS**

Product index ..... 2

General Information ..... 5

Limited Lifetime Warranty ..... 6

Damages | Returns | Reparis ..... 7

Ordering Information ..... 8

GSA Customer Information ..... 9

Freight..... 10

Features & Advantages ..... 11

Finishes | Specifications..... 13

Edges | Pulls ..... 14

Grommets | Grommet Reference ..... 15

Ganging | Height Reference ..... 16

Metal Legs ..... 18

Modesty Reference | Grain Direction..... 19

Drawer Dimensions | FILING Reference ..... 20

Double Pedestal Desk ..... 21

Table Desk..... 23

Single Pedestal Desk ..... 25

Conference Desk ..... 28

Runoff Desk ..... 33

Returns..... 39

Bridges ..... 43

Corner Units..... 44

Freestanding Crednezas..... 45

Workstation Credenzas..... 52

Bench Cabinets..... 58

Pedestals ..... 60

Single Height Freestanding Overheads ..... 61

Double Height Freestanding Overheads ..... 66

Overhead Accessories..... 68

Single Height Wall Hung Overheads ..... 72

Double Height Wall Hung Overheads ..... 75

Wall Hung Accessories ..... 78

Overhead Half Towers ..... 86

Overhead Bookcases ..... 90

Vertical Half Towers ..... 92

Vertical Full Towers ..... 94

Bookcases..... 98

Options ..... 100

Power and Data..... 123

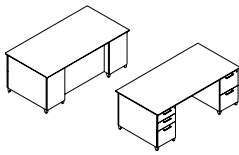

PAGE 21  
FREESTANDING DESKS

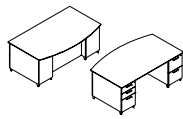

PAGE 22  
FREESTANDING DESKS

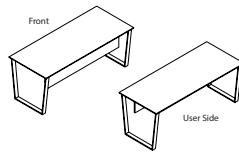

PAGE 23  
FREESTANDING DESKS

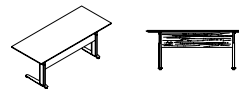

PAGE 24  
FREESTANDING DESKS

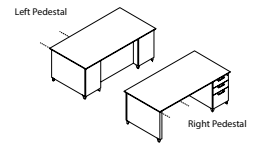

PAGE 25  
FREESTANDING WORKSTATION  
DESKS

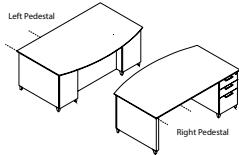

PAGE 26  
FREESTANDING WORKSTATION  
DESKS

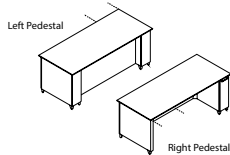

PAGE 27  
FREESTANDING WORKSTATION  
DESKS

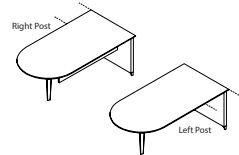

PAGE 28  
CONFERENCE WORKSTATION  
DESKS

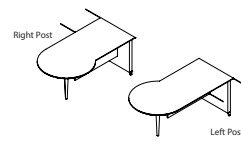

PAGE 29  
CONFERENCE WORKSTATION  
DESKS

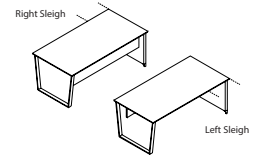

PAGE 30  
CONFERENCE WORKSTATION  
DESKS

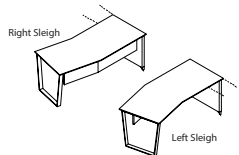

PAGE 31  
CONFERENCE WORKSTATION  
DESKS

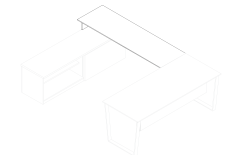

PAGE 32  
WORKSTATION BRIDGES

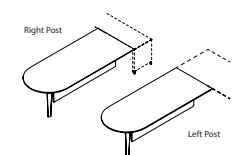

PAGE 33  
RUNOFF CONFERENCE  
WORKSTATION DESKS

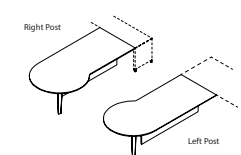

PAGE 34  
RUNOFF CONFERENCE  
WORKSTATION DESKS

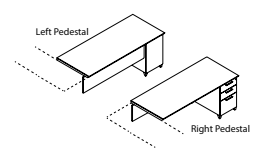

PAGE 35  
RUNOFF WORKSTATION DESKS

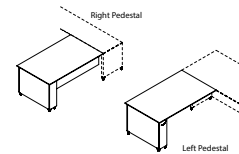

PAGE 36  
RUNOFF WORKSTATION DESKS

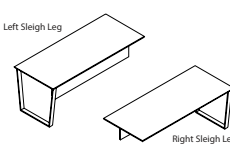

PAGE 37  
RUNOFF CONFERENCE  
WORKSTATION DESKS

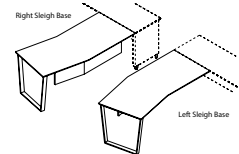

PAGE 38  
RUNOFF CONFERENCE  
WORKSTATION DESKS

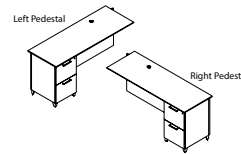

PAGE 39  
"L" WORKSTATION RETURNS

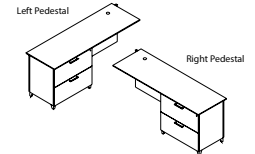

PAGE 40  
"L" WORKSTATION RETURNS

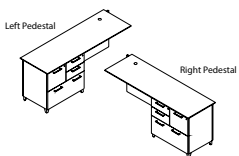

PAGE 41  
"L" WORKSTATION RETURNS

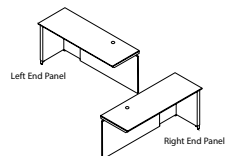

PAGE 42  
"L" WORKSTATION RETURNS

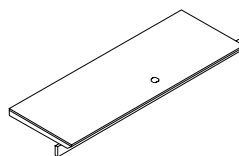

PAGE 43  
WORKSTATION BRIDGES

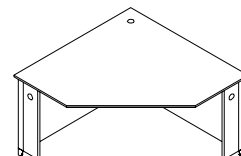

PAGE 44  
CORNER UNIT

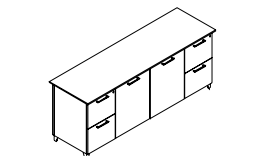

PAGE 45  
STORAGE CREDENZAS

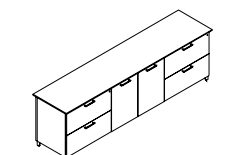

PAGE 46  
FREESTANDING LATERAL FILE  
CREDENZAS

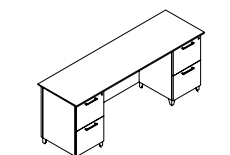

PAGE 47  
FILE CREDENZAS

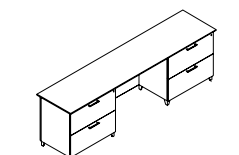

PAGE 48  
FREESTANDING LATERAL FILE  
CREDENZAS

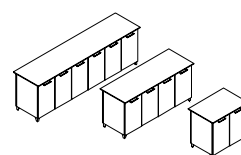

PAGE 49  
FREESTANDING STORAGE  
CREDENZAS

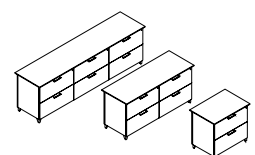

PAGE 50  
FREESTANDING LATERAL FILE  
CREDENZAS

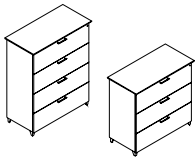

PAGE 51  
FREESTANDING LATERAL FILE  
CREDENZAS

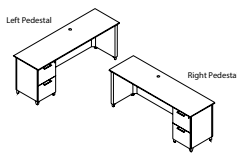

PAGE 52  
WORKSTATION CREDENZAS

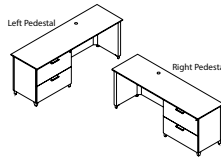

PAGE 53  
WORKSTATION CREDENZAS

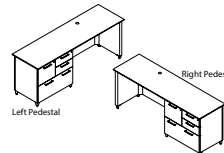

PAGE 54  
WORKSTATION CREDENZAS

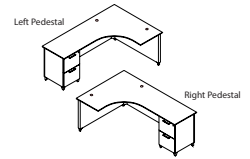

PAGE 55  
WORKSTATION CORNER  
CREDENZAS

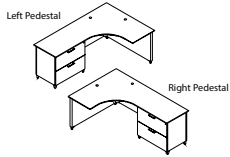

PAGE 56  
WORKSTATION CORNER  
CREDENZAS

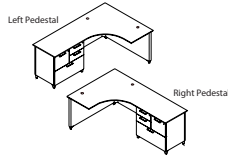

PAGE 57  
WORKSTATION CORNER  
CREDENZAS

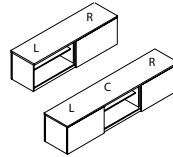

PAGE 58  
BENCH CABINETS

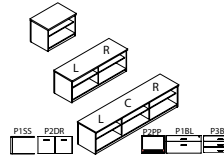

PAGE 59  
BENCH CABINETS

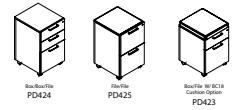

PAGE 60  
FREESTANDING MOBILE PEDESTAL

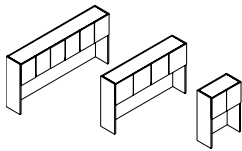

PAGE 61  
SINGLE STORAGE OVERHEAD  
CONSOLES

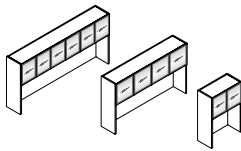

PAGE 62  
SINGLE STORAGE OVERHEAD  
CONSOLES

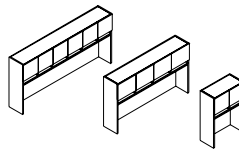

PAGE 63  
SINGLE STORAGE OVERHEAD  
CONSOLES

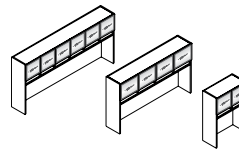

PAGE 64  
SINGLE STORAGE OVERHEAD  
CONSOLES

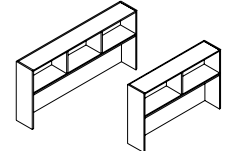

PAGE 65  
SINGLE STORAGE OVERHEAD  
CONSOLES

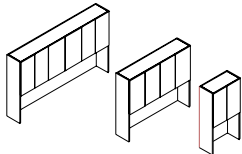

PAGE 66  
DOUBLE HEIGHT OVERHEAD  
CONSOLES

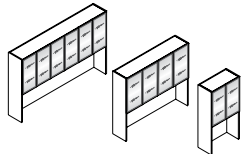

PAGE 67  
DOUBLE HEIGHT OVERHEAD  
CONSOLES

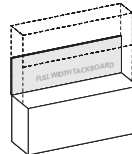

PAGE 68  
OVERHEAD TACKBOARDS

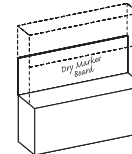

PAGE 69  
OVERHEAD DRY MARKER BOARDS

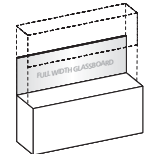

PAGE 70  
OVERHEAD GLASSBOARDS

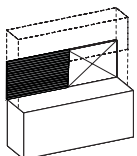

PAGE 71  
OVERHEAD SLAT WALL

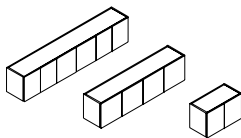

PAGE 72  
SINGLE HEIGHT WALL HUNG  
OVERHEADS

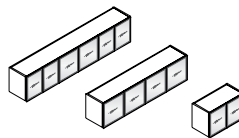

PAGE 73  
SINGLE HEIGHT WALL HUNG  
OVERHEADS

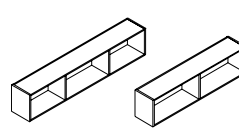

PAGE 74  
SINGLE HEIGHT WALL HUNG  
OVERHEADS

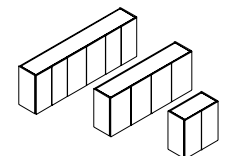

PAGE 75  
DOUBLE HEIGHT WALL HUNG  
OVERHEADS

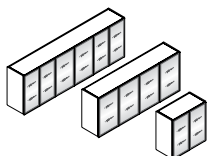

PAGE 76  
DOUBLE HEIGHT WALL HUNG  
OVERHEADS

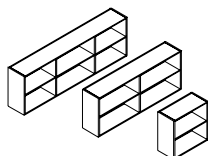

PAGE 77  
DOUBLE HEIGHT WALL HUNG  
OVERHEADS

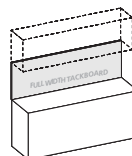

PAGE 78  
WALL HUNG TACKBOARDS

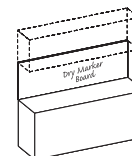

PAGE 79  
WALL HUNG DRY MARKER  
BOARDS

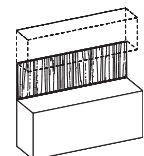

PAGE 80  
WALL HUNG VENEER PANELS

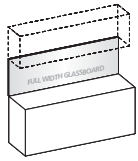

PAGE 81  
WALL HUNG GLASSBOARDS

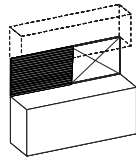

PAGE 82  
WALL HUNG SLAT WALL

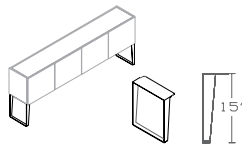

PAGE 83  
WALL HUNG ACCESSORY

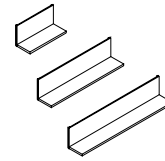

PAGE 84  
SINGLE HEIGHT WALL HUNG  
OVERHEADS

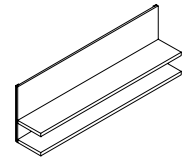

PAGE 85  
DOUBLE HEIGHT WALL HUNG  
OVERHEADS

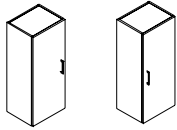

Hinged Left Hinged Right  
PAGE 86  
OVERHEAD HALF TOWERS

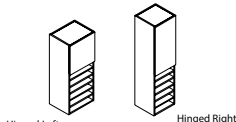

Hinged Left Hinged Right  
PAGE 87  
OVERHEAD HALF TOWERS

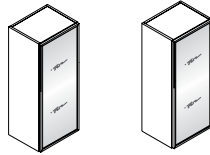

PAGE 88  
OVERHEAD HALF TOWERS

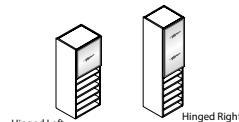

Hinged Left Hinged Right  
PAGE 89  
OVERHEAD HALF TOWERS

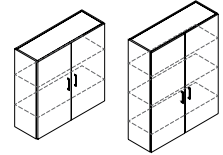

PAGE 90  
OVERHEAD BOOKCASES

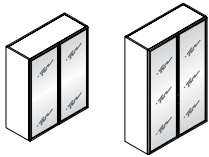

PAGE 91  
OVERHEAD BOOKCASES

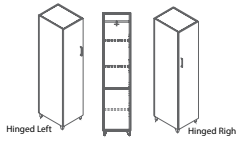

Hinged Left Hinged Right  
PAGE 92  
FREESTANDING HALF TOWERS

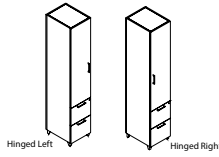

Hinged Left Hinged Right  
PAGE 93  
FREESTANDING HALF TOWERS

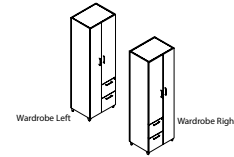

Wardrobe Left Wardrobe Right  
PAGE 94  
FREESTANDING TOWERS

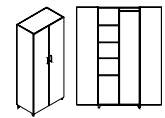

PAGE 95  
FREESTANDING TOWERS



PAGE 96  
FREESTANDING TOWERS



PAGE 97  
FREESTANDING VERTICAL FULL  
TOWERS

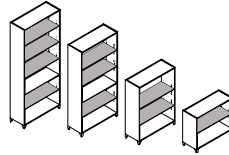

PAGE 98  
OPEN BOOKCASES

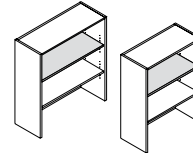

PAGE 99  
OPEN BOOKCASES



All DARRAN products are proudly manufactured in the U.S.A.

**BUILT TO ORDER**

Manufactured per order the way you want it, including modifications.

**FULLY ASSEMBLED**

Unless otherwise noted, all products are fully assembled and ready to use, including add-on options.

**PERFORMANCE TESTED**

All products are tested to ensure performance exceeds BIFMA / ANSI standards.



**GREEN CERTIFIED**

DARRAN has been committed to improving indoor air quality of office buildings since 1996. Since then, finish technology has allowed our commitment to continue with products that are air quality Certified Green.

DARRAN is proud to announce that all in veneer, laminate, and guest seating are MAS Certified Green for complying with the ANSI/BIFMA X 7.1 standard / LEED 4.5 Standard for low –VOC emitting Furniture.

MAS is an independent emission testing laboratory that is ISO 17025 compliant using ASTM, ANSI and CEN methods. MAS is a true 3rd party certification through NSF International to BIFMA standards and California’s ARB formaldehyde standard. Certification of compliance under the Low – VOC emitting Furniture testing, qualifies products for LEED 4.5 credits.



**FINISH TECHNOLOGY**

DARRAN has continued its partnership with AkzoNobel Chemicals ([www.akzonobel.com](http://www.akzonobel.com)) to develop a new finish technology further improving indoor air quality with a coating that meets today’s environmental standards and supports LEED buildings.

ENVI-CT (Environmental Coatings Technology) utilizes advanced European finish technology to deliver a high-end furniture coating with superior performance in appearance and durability, allowing DARRAN to deliver more sustainable products to our customers.

*ENVI-CT Advantages:*

- › ENVI-CT is a re-engineered high performance Coatings Top Coat
- › Exceptional hardness and clarity
- › Highly resistant to solvents and chemicals
- › Plasticizer Migration resistant
- › Excellent UV inhibitors for maximum color resistance
- › Exceeds current and proposed future Federal and State air quality requirements
- › Field Repairable
- › Dynamic chamber emissions tested and certified compliant to ANSI/BIFMA X 7.1 Standard / LEED 4.5 Standard for low – VOC emitting furniture.
- › Standard with Anti-microbial additive.

**ADVANTAGES**

DARRAN has upgraded the standard Anti-microbial protection, to , the latest in Silver Ion Technology. DARRAN collaborated with the world’s leader in finishing materials, to formulate an additive that will inhibit the growth of mold, mildew, fungus and bacteria on wood surfaces. This additive infuses Silver Ions into DARRAN’s ENVI-CT (Environmental Coatings Finish Technology), creating a protective surface for the life of the furniture. The best part - is standard on all DARRAN Caseloads for no additional fee.



## LIMITED LIFETIME WARRANTY

DARRAN Furniture Industries, Inc. ("DARRAN") warrants that each piece of furniture manufactured in its North Carolina Facilities will be free from defects in material and workmanship for as long as the original purchaser owns and uses the product. Subject to the limitations and exclusions herein, DARRAN, at its discretion and as the sole remedy under the DARRAN Limited Lifetime Warranty, will replace or repair a defective product or components with comparable product or components free of charge. This warranty is made only to the original purchaser from an authorized DARRAN dealer, for as long as that original purchaser owns and uses the product.

### LIMITATIONS: USE / CARE

- › Warranty is limited to normal single shift use.
- › Warranty is limited to generally accepted care and maintenance of natural wood products and environments.
- › Natural wood surfaces are subject to denting, scratching, and gauging if not properly used and cared for. Warranty is subject to use and care in accordance with the use and care instructions provided in the Product Care section of this site (including, but not limited to, the care and maintenance guide downloads linked thereon), available at [www.darran.com/product-care](http://www.darran.com/product-care), which are incorporated herein by reference.

### LIMITATIONS: MATERIALS / COMPONENTS

- › Laminates, Veneers / Finishes - 10 Years
- › Electrical lamps, Ballasts, Transformers - 5 Years
- › Fabrics, Pneumatic lifts, Foam - 5 Years
- › Custom products built to customers specifications - 3 Years

### WARRANTY EXCLUSIONS

*Damage identified as carrier or installer related.*

- › Normal wear and tear of wood products during course of ownership.
- › Color, grain, or texture of natural wood materials, laminates, and other covering materials.
- › Damages or failures resulting from misuse, abuse, negligence, improper care, modifications, or relocation.
- › Non Commercial use or locations.
- › So-called "ghost" indentions and similar damage caused by the failure to use appropriate desk or writing pads.

All Warranty Claims are subject to DARRAN-approved inspections. Disputes may involve independent third-party evaluation

### QUALITY ASSURANCE

DARRAN manufactures in accordance with the standards set by Architectural Woodwork Institute (AWI) for Quality Standards.

Every unit produced at DARRAN is completely inspected by an independent quality control team located within each plant whose emphasis is on assembly, finish, and final inspections with empowerment to stop any unit not meeting DARRAN's high quality standards.

### LIGHT AND NATURAL FINISHES

The beauty of veneer and all wood products comes from the variations created by nature including color, grain, and texture.

These variations are not considered defects and DARRAN's Limited Lifetime Warranty does not cover color, grain and texture variations associated with natural wood and grain seen in any finish color. DARRAN sets standards for veneer selections; however, variations, especially apparent in light/natural finishes, will occur from one piece to another even if they are finished at the same time.

Finishes such as Clear Maple, Light/Gunstock Walnut, and Clear/Caramel Cherry will display more natural characteristics due to their light stain. Grain, pattern and color from unit to unit are not guaranteed or warranted and products will not be replaced due to these variations. Exposure to light and age will cause darkening of natural wood products; therefore DARRAN cannot guarantee or warrant finish match of new products being placed with existing products in the field.

### GLASS

Use of glass overlays on surfaces will void DARRAN's Limited Lifetime Warranty, unless the overlay is installed and maintained in strict accordance with DARRAN's instructions. If an overlay is to be used, please contact DARRAN for installation and maintenance instructions.

### GENERAL

Performance questions will be tested to generally accepted practices and AWI guidelines and standards for wood veneer furniture. To obtain performance of the Limited Lifetime Warranty, the purchaser should contact in writing the authorized DARRAN representatives or current dealer who sold the product to the purchaser or mail the warranty claim to:

Warranty Department  
DARRAN Furniture Industries, Inc.  
P.O. Box 7614  
High Point, NC 27264  
Telephone: 336-861-2400      Toll Free: 800-334-7891  
email: [warranty@darran.com](mailto:warranty@darran.com)

EXCEPT FOR THE LIMITED LIFETIME WARRANTY EXPRESSLY DESCRIBED HEREIN, DARRAN MAKES NO OTHER REPRESENTATION OR WARRANTY OF ANY KIND, EXPRESS OR IMPLIED. DARRAN MAKES NO WARRANTY OF MERCHANTABILITY OR FITNESS FOR A PARTICULAR PURPOSE, AND DARRAN WILL NOT UNDER ANY CIRCUMSTANCES BE LIABLE FOR ANY INCIDENTAL OR CONSEQUENTIAL DAMAGES, OR ANY INDIRECT OR SPECIAL DAMAGES.

### THE WARRANTY AS STATED ABOVE, SUPERSEDES ALL PREVIOUS WARRANTIES



**NO HASSLE FREIGHT DAMAGED MERCHANDISE**

DARRAN products are packed in specially designed cartons and padding that protects all edges and corners from damage. This is proven by an industry low damage rate of .0030% per total pieces shipped.

For qualified freight damage claims DARRAN will take responsibility for the claim and remedy processes including assuming total cost coverage from claim settlements.

(Some items may not qualify. Contact Factory for specific details.)

**QUALIFIED CLAIM CONDITIONS****VISIBLE CARTON DAMAGE**

1. Take digital pictures of the damaged carton and damaged furniture if visible damage is found upon delivery at the dock
2. Open all cartons with puncture or crushed corner damage.
3. Note any damage to the goods on the Carrier's freight bill as number of pieces damaged.

**CONCEALED DAMAGE**

1. Take digital pictures of the furniture as it sits partially unpacked. Also, photograph external and internal carton materials that correspond with the damaged area on the product.
2. Carton and damaged unit(s) must be located at the location matching the original delivery address for Carrier inspection.
3. Digital pictures must be provided of the damaged furniture and carton materials

For qualified claims per above contact DARRAN Customer Service Department at 1-800-334-7891 or complete DARRAN's online warranty report form within the 15 day limit. [www.darran.com/warrantyreport](http://www.darran.com/warrantyreport)

**NON-QUALIFIED CLAIM CONDITIONS**

1. Deliveries made to non-dock locations
2. Claims made after furniture is installed and/or removed from original delivery location
3. Carton and padding has been discarded
4. Carrier used was not DARRAN approved
5. Inspection reveals questionable damages

**REPLACEMENT ORDERS**

Replacement orders entered without replacement tagging or factory authorization is considered a new order without dispute, therefore full payment is expected and will be collected.

**RETURN SHIPMENTS**

DARRAN will not accept return of merchandise without a signed RA (return authorization) form.

DARRAN will specify the carrier to be used. Return bills of lading must be marked "Class 125" freight rate and a copy of the RA should be used as a packing list. All returns must be received by DARRAN within 30 days of the RA date or the products will be considered accepted by the customer.

All products being returned must be properly packed and protected to avoid freight damage. Whenever possible, use the original cartons in which the merchandise was shipped. Freight

damage, signs of usage, missing parts, etc., will result in an adjustment of any credit to be issued.

DARRAN will issue RA's for the following reasons:

1. Manufacturing defect (inspection required)
2. Order processing error by DARRAN
3. Shipping error
4. Mismarked carton / merchandise

**SPECIFICATION CHANGES**

We reserve the right to change without notice any dimension, style, or specification of any model in the DARRAN line. Dimensions shown in the price list are nominal. It is the buyer's responsibility to read specification carefully when matching existing goods is desired.

**MANUFACTURING DEFECTS**

Claims of manufacturing defects will not be entertained without prior consultation with DARRAN's warranty department. Unauthorized deduction in payment of invoices will not be allowed without prior factory approval. Unapproved deductions are subject to factor's late payment charges.

**DAMAGE CLAIMS**

Claims of manufacturing damage or freight damage reported as nicks, dents, scratches, etc. after installation of furniture will not be covered under warranty or freight claim.

**ATTENTION:** Damage claims involving glass or stone components must be inspected and damage noted on delivering freight bill to qualify for replacement.

**REPAIR CHARGES**

Factory authorization must be secured from DARRAN's warranty department prior to incurring repair charges. Warranty will utilize DARRAN's National Repair Service through the Furniture Medic Franchise ([www.furnituremedic.com](http://www.furnituremedic.com)).

Repair charge authorizations are based on:

- › Set travel rate
- › Average regional job rate
- › Factory set maximum repair time
- › Falsely reported defect claims are subject to local service charges being charged to dealer/distributor.

**FINISH MAINTENANCE**

Wood office furniture and wood finishes can retain their natural beauty for life if proper care is taken and a stable environment is provided. Fluctuations in humidity and temperature cause panels and solid wood components to expand and contract and may lead to panel warpage and finish "checking" or cracking. Prolonged exposure of furniture to dry heat during winter months should be avoided. Careful examination of interior wood trim may indicate a damaging dry environment. If open joints, splits and cracks are appearing in trimwork consult with a HVAC professional for appropriate remedy.

DARRAN finishes are field repairable should damage occur. Professional furniture repair services are recommended. Regular cleaning with a non-silicone polish is recommended.

**ORDERING**

All orders should be emailed, mailed or transmitted by fax to:

DARRAN Furniture Industries, Inc.  
P.O. Box 7614  
High Point, NC 27264  
email: orders@darran.com  
Fax: 336-861-6485

DARRAN will only accept orders from authorized Dealers. All orders must be accurate and detailed. All Quick Ship orders must contain Quick Ship product ONLY. Orders should be separated and submitted according to lead time. Orders must contain Quick Ship code "QS" or have designated Quick Ship lead time to ensure correct order entry. Orders that contain multiple lead time products will be entered as one order and scheduled with the most extended lead time.

List product by office and tag accordingly. DARRAN will key alike all products under the office tag. Failure to assign and tag may result in random key number assignments. Keying is field changeable.

**CREDIT APPROVAL**

All orders are subject to credit approval for open account. All new accounts must be approved by a local DARRAN Sales Representative and should submit current financial information and trade references to:

DARRAN Furniture Industries, Inc. ATTN: Credit Department  
P.O. Box 7614  
High Point, NC 27264  
Telephone: 336-861-2400 Toll Free: 800-334-7891  
Fax: 336-861-2512

Orders submitted without accounts pre-approval or credit approval are subject to acceptance with lead times scheduled only after approval dates.

**LEAD TIME SCHEDULE**

DARRAN cannot assign a firm lead time until Credit approval and order accuracy are complete. Extended lead times due to credit or information delays are the responsibility of the Buyer.

**ORDER DELAY / HOLD**

Due to the committed manufacturing cost on Quick Ship processes, DARRAN cannot delay or hold orders, either in process or after completion.

**CANCELLATION AND ORDER CHANGES - FEES**

Acknowledged orders are considered firm orders and therefore not subject to cancellation or change. However, in the event we are able to stop an order prior to manufacturing process, we will consider cancellation or changes with a reprocessing fee of \$40.00 Net. Exceptions: Quickship orders cannot be changed or canceled after the 3rd business date after acknowledgment. Qualified changes/cancellations will be assessed a \$40.00 Net processing fee.

Changes or cancellation of order with special options or custom quoted items are also subject to additional material and vendor fee costs, plus a DARRAN special/custom reprocessing fee of \$100 NET.

**ORDER MOVEUPS**

Should an original scheduled ship date need to be improved, the Factory must be contacted 15 business days prior to the desired ship date. Move ups are subject to schedule availability.

**ORDER ACKNOWLEDGMENT**

Upon credit approval your order will be acknowledged and identified by an order number. When making reference to your order, please use this order number. Your acknowledgment is a detailed description of our interpretation of your order, pricing, shipping information, and estimated delivery date.

If you have not received an Acknowledgment within 10 Days of order issue, contact Customer Service immediately. All Quick Ship order acknowledgments will be faxed or emailed upon request to speed processing. Please read your acknowledgment carefully for correctness and notify DARRAN immediately of any discrepancies. Failure to notify relieves DARRAN from error liability.

Order acknowledgment is the final agreement between DARRAN and the customer superseding all previous communications regarding the order. DARRAN will not be responsible for errors made on orders placed by phone without written confirmation.

**SELLING INFORMATION**

Possession of this price list does not in itself constitute the right to sell DARRAN products. DARRAN products are sold and distributed through authorized dealerships. Contact factory for a listing of local representatives and dealerships.

**INVOICE TERMS**

Standard terms are NET 30 days. Finance charges of 1-1/2% will be added to delinquent accounts after 45 Days and for each 30 Days thereafter until paid.

Complaints involving newly received merchandise must be reported within 10 days from receipt to qualify for full invoice remittance suspension or term extension. Otherwise only items in dispute can be suspended from payment of invoice within terms.

**WAREHOUSE/STORAGE**

DARRAN will determine order warehousing approvals on a case by case basis. Orders that can be accommodated will be limited to a max of 30 days storage and must be invoiced at time of storage. Orders that exceed factory storage capacity will be transferred to local storage facilities subject to current storage rates and handling-transit charges. Storage charges must be paid prior to order release to shipping.

**EXECUTIVE OFFICE & CONFERENCE ROOM  
FURNITURE**

**November 3, 2015 through November 2, 2020**

FSC Group 71

GSA CONTRACT NUMBER: GS-27F-001DA

Business Classification:

WBENC Certified Woman-Owned Small Business

DARRAN FURNITURE INDUSTRIES

2402 SHORE DRIVE

HIGH POINT, NC 27263

336.861.2400 FAX 336.861.6485

Business Classification:

Woman-Owned Small Business

On-line access to contract ordering information, terms and conditions, up-to-date pricing, and the option to create an electronic delivery order are available through GSA Advantage!, a menu driven database system. The INTERNET address for GSA Advantage is <http://www.fss.gsa.gov>

For more information on ordering from Federal Supply Schedules click on the FSS Schedules button at <http://www.fss.gsa.gov>

**1a. Special Item Number**

711-8: Executive Office Furniture

711-9: Executive Conference Room Furniture

711-11: Tables and Accessories

711-16: Upholstered Seating

711-18: Multi-purpose Seating

**2. Maximum Order Limitations:**

711-8 \$500,000

711-9 \$500,000

711-11 \$500,000

711-16 \$300,000

711-18 \$200,000

**3. Minimum Order: \$100**

**4. Geographic Coverage:** 48 Contiguous States and the District of Columbia

**5. Point of Production:** High Point, North Carolina (Randolph County)

**6. Discount:** Prices shown herein are List (Discount is 56.9% Off List)

**7. Quantity Discounts:**

• \$467,837 List to \$1,000,000 List = 59.70%

• \$1,000,001 List to \$1,315,789 List = 61.70%

**8. Payment Terms:** ½% - Net 15 Days, Net 30 Days

**8a. Terms and Conditions of Government Credit Card Acceptance:**

a. No discount allowed for payment by Government Purchase Card

b. Provide commercial credit card number

c. Provide commercial credit card expiration date

d. Provide individual's name as it appears on

credit card

e. Provide telephone number of individual to whom credit is issued

**9a. Government Purchase Cards are accepted below the Micro Purchase Threshold.**

**9b. Government Purchase Cards are accepted above the Micro Purchase Threshold.**

**10. Foreign Terms:** None

**11a. Time of Delivery:** Regular Product: 60 - 90 days after receipt of order

Quick Ship Program: Contact DARRAN

**11b. Quick Ship Program:** Items available for expedited delivery are included in main Price Lists.

**11c. Overnight and 2-day delivery:** N/A

**11d. Urgent Requirements:** Will be considered on an individual basis. Contact DARRAN for details.

**12. FOB Point:** All destinations are limited to Commercial docks only. Carriers may refuse non-dock deliveries.

**12a. Freight Prices:**

a. All prices shown are suggested list prices with freight included where indicated.

b. Freight allows delivery to one qualified destination.

c. Within the Continental USA, all orders above \$1,500 net are shipped FOB factory, freight prepaid and allowed. All orders less than \$1,500 net will be subject to a \$100 net freight charge.

**13. Ordering Address:**

DARRAN Furniture Industries

P.O. Box 7614

High Point, NC 27264

Ph: 800.334.7891

Fax: 336.861.6485

**13a. Payment Address:**

BB&T

P.O. Box 890011

Charlotte, NC 28289-0011

**14. Warranty Provision:** Limited Lifetime (Contact DARRAN for details)

**15. Export Packing Charges:** Quoted on request

**13. Terms and Conditions: Order Cancellation / Changes.**

Restocking/Returns: No merchandise may be returned without a return authorization and shipping instructions. No credit or allowance will be given for repairs to defective materials unless DARRAN has given authority to make such repairs. A restocking charge of 25% will apply.

Cancellation: No cost prior to production. After

## GSA CUSTOMER INFORMATION

production has begun, only actual cost incurred will be billed to the Government that cannot be recovered through resale in 6 months

**14. Terms and Condition of Rental, Maintenance and Repair: Consult the Factory.**

**15. Terms and Conditions of Installation:** Installation by a Third party to be quoted on a per job basis. The ordering must specify what ranges of installation services are required.

**16. Terms and Conditions of Repair Parts:** Contact DARRAN for details.

**17. List of Service and distribution points:** Contact DARRAN for details..

**18. Preventative Maintenance:** Information enclosed with product.

**19. List of Participating Dealers:** Contact DARRAN for details.

**23. Environmental Attributes:** DARRAN is compliant with EPA standards. All plywood core material is CARB 2 compliant and contains recycled content. All DARRAN Casegood Products are BIFMA Level 2 Certified. DARRAN is FSC CoC Certified and our products are MAS Certified for Indoor Air Quality.

**23a. Recyclable and Recycled Content Packaging:**

The corrugated packaging that is supplied to DARRAN, meets the federal mandate that requires the paperboard to be composed of 30%-50% recycled paper, and in some cases the recycled content is close to 100%.

**23b. Chemical Emission:** DARRAN finishes its products in an ENVI-CT Finish. (Environmental Coatings Technology). DARRAN's seating is finished with a low VOC Conversion Varnish and the casegoods are finished with a formaldehyde free, low VOC Urethane finish. These ENVI-CT finishes allow DARRAN's products to be MAS Certified Green under the ANSI BIFMA X7.1 Standard. Products assist with LEED 4.5 Credit.

**23c. Vapor Emissions:** DARRAN's ENVI-CT finishes use the latest environmental coatings technology to provide lasting durability and exceptional clarity with BACGUARD Silver anti-microbial protection built-in. The ENVI-CT finishes allows DARRAN casegoods to be MAS Certified Green meeting LEED Credit 4.5.

**24a. Duns Number:** 08-363-5318

**24b. Cage Code:** 0Y-6B6

**24c. Federal ID Number:** 56-117-1971

**24d. NAICS Code:** 337211

**25. SAM Network:** DARRAN is registered

## SHIPPING SCHEDULE

When requested, DARRAN will assist in locating special express carriers that may have short transit times. These services may exceed our prepaid freight costs; therefore, pricing is limited to the Freight Excluded formula with special express charges added to the invoice.

For special deliveries, DARRAN will make every effort to meet the appointed time; however DARRAN will not be responsible for any additional charges for late deliveries beyond our control.

## PRICES

- › All prices shown are suggested list prices with freight included where indicated.
- › Freight allows delivery to one qualified destination.
- › Within the Continental USA, all orders above \$1,500 net are shipped FOB factory, freight prepaid and allowed. All orders less than \$1,500 net will be subject to a \$100 net freight charge.

## CALL BEFORE DELIVERY REQUEST

DARRAN will arrange for carriers to call before delivery when requested.

Important Non-Qualified Destinations DARRAN Prepaid Freight Pricing does not include delivery to:

- › Residential Areas
- › Restricted Commercial Areas
- › No Dock Locations
- › Inside delivery/setup service

Orders received and installed without professional Furniture Installers voids all Warranty Coverage.

## CARRIER SELECTION

DARRAN selects and uses only carriers specialized in furniture transportation. Customer requested carriers can be authorized using Freight Excluded pricing with invoice add-on.

## SPECIFIC DELIVERY TIMES

DARRAN will assist in coordinating a requested delivery time from a carrier. DARRAN makes no guarantees and accepts no responsibility for such services as DARRAN has no control over possible carrier hazards. To ensure specific time arrival, we recommend arranging single stop, designated load carriers. Less than trailer load (LTL) shipments cannot be coordinated for a guaranteed delivery time.

## EXPRESS CARRIERS

When requested DARRAN will assist in locating special express carriers that may have short transit times. These services exceed our prepaid freight cost, therefore, pricing is limited to the Freight Excluded formula with special express charges added to invoice.

## FEATURES & ADVANTAGES

### VENEER AND HPL TOPS

Wood veneer tops and high-pressure laminate tops feature a M2 Grade, CARB2 MDF Core with balanced 3-ply construction. Tops are 1-5/16" thick on all veneer and HPL products except for the Rift Collection, which features 1-1/2" thick primary work surfaces. Tops are connected to chassis with steel angle brackets, wood cleats and dowels. DARRAN only uses HPVA A Grade Flat Cut Cherry, Maple, and Walnut Veneers that are book-matched and slip-matched. Rift-Cut White Oak and Quarter-Cut Ash are available as premium veneers. DARRAN's Rift Collection features a double-cut veneer in a rift-cut pattern for a clean linear aesthetic. Veneer tops feature shapeable MDF edges, 3/4", 1", or 3mm external solid hardwood bands based on collection and edge selection. HPL tops feature a laminate self edge, shapeable MDF edge, or a 3mm solid wood edge based on edge selection.

### TFL TOPS

Thermally Fused Laminate tops feature M2 Grade, CARB2 MDF Core with 3-ply balanced construction. Tops are 1-1/8" thick and feature a 2mm flat PVC edge band providing high impact durability. Tops are connected to chassis with steel angle brackets and dowels.

### CHASSIS & PEDESTAL CONSTRUCTION

All pedestals and chassis are constructed with 3/4" thick balanced 3-ply panels. Panels are securely fastened together using rails that are bored and doweled, glued, metal reinforcement brackets and wood cleat construction. Thick end panels are pre-bored to accept a tee nut for the adjustable glide and are reinforced with pvc banding to prevent glide tear out. Glue blocks are used where 3/4" thick panels are joined, bored for tee nut to accept adjustable glide.

### OVERHEAD CABINET CONSTRUCTION

(FREESTANDING AND WALL MOUNT)

Freestanding Overhead storage cabinets are constructed of 1" and 3/4" thick balanced 3-ply panels. Panels are attached with cam fasteners in conjunction with dowels securely adhered with PVAc (white polyvinyl acetate) glue. All surface mount cabinets connect to work surface with anti-slip tape. Wall mount cabinets are mounted to the wall with steel "z" bracket attachment method using 5mm euro screws to attach to the back of the cabinet. All units ship with a steel "z" bracket. This bracket is mounted to the wall by field installers. Installers are responsible for selecting and supplying appropriate fasteners for wall conditions.

### BOOKCASE CONSTRUCTION

All chassis (sides, back, top and bottom panels) are constructed with 3/4" thick balanced 3-ply panels. Panels are attached with cam fasteners in conjunction with dowels securely adhered with PVAc (white polyvinyl acetate) glue. Shelves on all units are 3/4" thick balance 3 ply panels. Optional heavy duty shelves are 1" thick lumber core balanced 5 ply construction.

### TACKBOARDS

Wall mount tackboards are constructed of .75" thick fiberboard.

The fabric is precisely aligned and fitted to the tackboard with a sock on cover.

Overhead storage tackboards are constructed of .5" thick fiberboard. The fabric is precisely aligned and fitted to the tackboard and adhered to the rigid hardboard with staples.

### ADJUSTABLE GLIDES

Glides provide 1" of vertical leveling adjustment. Glide bottom is durable metal.

### DRAWERS

All drawers are constructed of four sides and a bottom, which are attached to a drawer front with screws for easy removal. Drawer fronts feature vertically matched veneer within each pedestal. Pencil trays are standard in all box drawers. Jamestown, Prado, Rift, and Spaces feature maple veneer 1/2" thick material for drawer sides, fronts and backs with a UV finish for maximum durability. Drawer bottoms are 7/32" thick 3-ply maple veneer. Drawer boxes are assemble at each corner with dowel joinery for maximum drawer strength. Capitol Park, Central Park, NSsq, Reception Park, and Richmond Park feature drawers that are 1/2" thick wood grained wrapped 5 sided miter-folded construction with 1/8" thick hardboard bottoms.

### SUSPENSIONS

All casegoods utilize cold rolled steel zinc plated high-grade drawer suspensions. All suspensions are warranted for the lifetime of the product. Box and File drawers are full extension, featuring steel ball bearings for a smoother quieter range of motion with soft close operation and are rated 100lbs. Lateral file drawers are a progressive action full extension suspension with the soft close operation and is rated at 150lbs. Lateral files include anti tip mechanism that will allow only one drawer at a time to be opened.

### HINGES

Units with doors include 95 degree swing hinges.

### FILING

Capitol Park, Central Park, NSsq, Reception Park, and Richmond Park feature a highly durable black plastic extrusion that is securely fastened into a route on top of the drawer.

Desk drawers are provided with a cross bar that allows for adjustability for letter or legal filing side to side, letter width filing front to back without the use of a cross bar. Credenza and Return filing is letter width front to back and legal width side to side without the use of a cross bar, letter width side to side with the use of a cross bar. Lateral files feature legal with filing side to side and two rows of letter width front to back with the use of cross bars.

Jamestown, Prado, Rift, and Spaces feature metal file frames around the perimeter of the drawers with cross bars. Desk drawers are provided with a cross bar that allows for adjustability for letter or legal filing side to side, letter width filing front to back without the use of a cross bar. . Legal width drawers are specified on desks 72" and larger, and filing is legal front to back or two rows letter side to side. Credenza and Return filing is letter width front to back and legal width side to side without the use of a cross bar, letter width side to side with the use of a cross bar. Lateral files feature legal with filing

side to side and two rows of letter width front to back with the use of cross bars.

**LOCKS**

Silver, black or bronze face locks are standard on all desks, credenzas, returns, and modular pedestals and match the color of the pull selection. Locks are optional on door storage, overhead storage, towers with doors and all door units. Each drawer pedestal is independently locked. Lock plugs are factory or field installed.

**KEYING**

Keying is available either factory or field installed. Factory installed keying is random.

**WIRE MANAGEMENT**

Wire management capabilities include standard and optional worksurface grommets. When grommets are standard or specified in a unit, wire channels under the surface are provided for organization and management of all communication wires and cords.

**GROMMETS**

Metal grommets are provided to match the drawer pull selection. Grommet is available in black, silver, or white. Must specify standard or non-standard location. Black plastic grommets are available as an option for vertical applications.

**POWERPORTS**

A large selection of powerports are available and handle power, data, docking stations and communication. See options section for selection.

**LED TASKLIGHTS**

LED task lighting provides high efficiency, low energy lighting with long life. LED lights are encased in a silver aluminum alloy material with built in switch to turn the light on/off. Lights are factory installed.

*Product specifications listed below:*

- Diffuser creates a softer light and eliminates hot spots.
- Built in switch with dimmer control.
- 30w 12Vdc 120V (UL approved) power supply
- Can be "daisy chained" up to 30W
- 50,000 hour life

SIZE	VOLTAGE	WATTAGE	COLOR TEMP.	CRI
24" light	12Vdc	6.4	5000K	90
48" light	12Vdc	12.8	5000K	90
60" light	12Vdc	16	5000K	90

**FINISHES**

<b>"W" VENEER</b>	<b>"G" LAMINATE HPL TOPS</b>	<b>"M" THERMALLY FUSED LAMINATE</b>
WAC Amber Cherry .....	GAC Amber Cherry .....	N/A
WRC Caramel Cherry.....	N/A .....	N/A
WIC Crimson Cherry .....	GIC Crimson Cherry.....	N/A
WEC Ebony Cherry .....	N/A .....	N/A
WHC Honey Cherry.....	GHC Honey Cherry .....	MHC Honey Cherry
WOC KoKo Cherry .....	GOC KoKo Cherry .....	MOC KoKo Cherry
WSC Scotch Cherry .....	N/A .....	N/A
WAM Alabaster Maple .....	GAM Alabaster Maple .....	N/A
WCM Clear Maple .....	GCM Clear Maple .....	N/A
WWM Wheat Maple.....	GWM Wheat Maple .....	N/A
WEW Executive Walnut.....	GEW Executive Walnut.....	N/A
WRW Gray Luster Walnut .....	GRW Gray Luster Walnut.....	N/A
WGW Gunstock Walnut.....	N/A .....	MGW Gunstock Walnut
WJW Judicial Walnut.....	N/A .....	N/A
WNW Natural Walnut.....	GNW Natural Walnut .....	N/A
WTW Studio Teak Walnut.....	GTW Studio Teak Walnut .....	MTW Studio Teak Walnut
WWP Full Fill Designer White .....	GWL Designer White .....	MWL Designer White

Send 3x3 or larger finish chip for color match. Custom finish upcharge is 3% or \$250 Net (whichever is greater).

**FINISH**

ENVI-CT Green Certified European Technology Coatings Finish with Anti-microbial protection.

**VENEER AND HPL TOPS**

Wood veneer tops and high-pressure laminate tops feature a M2 Grade, CARB2 MDF Core with balanced 3-ply construction. Tops are 1-5/16" thick on all veneer and HPL products except for the Rift Collection, which features 1-1/2" thick primary worksurfaces. Tops are connected to chassis with steel angle brackets, wood cleats and dowels. DARRAN only uses HPVA A Grade Flat Cut Cherry, Maple, and Walnut Veneers that are book-matched and slip-matched. Rift-Cut White Oak and Quarter-Cut Ash are available as premium veneers. DARRAN's Rift Collection features a double-cut veneer in a rift-cut pattern for a clean linear aesthetic. Veneer tops feature shapeable MDF edges, 3/4", 1", or 3mm external solid hardwood bands based on collection and edge selection. HPL tops feature a laminate self edge, shapeable MDF edge, or a 3mm solid wood edge based on edge selection.

**TFL TOPS**

Thermally Fused Laminate tops feature M2 Grade, CARB2 MDF Core with 3-ply balanced construction. Tops are 1-1/8" thick and feature a 2mm flat PVC edge band providing high impact durability. Tops are connected to chassis with steel angle brackets and dowels.

**CHASSIS**

3/4" thick core, Medium Density Fiberboard (MDF) rated EPP/SCS/CARB-II material with 3 ply balanced construction. Pedestal and cabinets feature dowel construction reinforced with steel bracket plates, wood cleats, screws and glue. Exposed interiors feature finished veneer of same species as exterior faces. Panel molding standard on approach and end panels of all worksurface height units.

NOTE: All units are standard with 1" adjustable glides that allow for leveling of units.

**DRAWER FRONTS**

Drawer fronts are vertically matched in balanced sets. Doors feature vertical veneer bookmatched horizontally in sets of 2 / 4 and 6 doors. All drawers and doors have traditional scallop profile edge shape. All tower fronts matched in vertical sets.

**DRAWERS**

Drawers feature mitre joint / dowel construction with a natural maple finish. All drawers extend 100% for full access on steel ball bearing slides with cushion in-out stops. Drawers have been tested and passed BIFMA 50,000 cycle test. File drawers feature 1/4" bottoms reinforced for heavy weight capacity. All drawers are guaranteed lifetime with free replacement warranty.

**OPTIONAL WOOD DRAWERS**

Optional hardwood veneer plywood drawers feature banded top and bottom edges for smoothness. Drawers are dowel joint construction with a UV cured finish over maple veneers, plus a lifetime free replacement guarantee.

Optional Wood Drawer (Any Size) – Option Code P33...\$40 List Price Per Drawer

**RANDOM LOCKS & KEYING (STANDARD)**

Locks are standard on all storage units below the worksurface. Random lock cores are installed at the factory. Some units may be shipped with the same key number. Locks are Silver, Black or Bronze and match pull finish unless specified.

- SRK: Random Silver Random Key - n/c
- BRK: Random Black Random Key - n/c
- ZRK: Random Bronze Random Key - n/c

**FIELD INSTALLED LOCKS & KEYING (OPTION)**

Field installed lock option can be selected, each unit is shipped with an empty lock cylinder. A separate line item must be ordered to receive the numbered lock cores for field installation. Field installed locks are available at no additional charge. Specify Silver or Black Locks.

- SFK: Field Installed Silver Random Key - n/c
- BFK: Field Installed Black Random Key - n/c
- ZFK: Field Installed Bronze Random Key - n/c

**EDGE PROFILE**

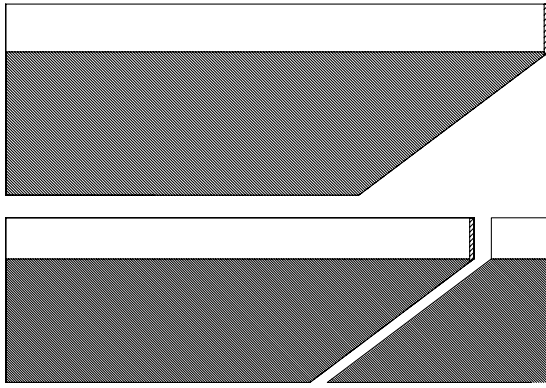

**PVC EDGEBAND**

NSS Bevel edge overhang profile is standard on all exposed undersurface edges and black bevel to provide a floating appearance.

**BRIDGE / RETURN HOOKUP EDGE**

Hookup tops feature reverse cope shaping for custom flush surface appearance and improved use.

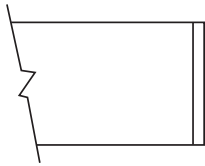

**FLAT**

3mm solid  
hardwood band

Available on Occasional tables & bench cabinets

**PULLS/KNOBS**

Factory Installed

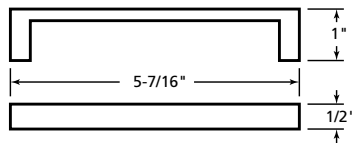

PL-115 Matte Black  
PL-116 Matte Nickel

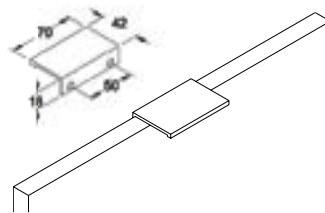

PL-260 Anodized Aluminum  
PL-261 White  
(Drawers Only)

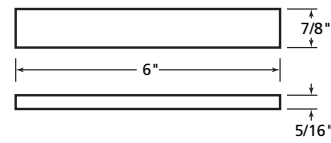

PL-210 Anodized Aluminum

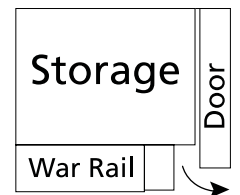

Finger Pull



**OPTIONAL GROMMETS**

Factory Installed

Grommets (Standard Location)

Specify Color and Left/Right/Center - \$45 ea.

- Black: TM30-R (Right), TM30-L (Left), TM30-C (Center)
- Silver: TM31-R (Right), TM31-L (Left), TM31-C (Center)
- Antique Brass: TM33-R (Right), TM33-L (Left), TM33-C (Center)

Grommets (Non-Standard Location)

Provide drawing w/ Grommet Location and Specify Color - \$90 ea.

- Black: TM30-NS
- Silver: TM31-NS
- Antique Brass: TM33-NS

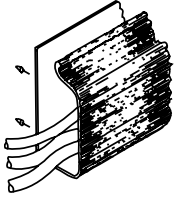

W1

Horizontal J-Channel wire management (Sku: W-1) is sold separately to conceal wire under worksurfaces.

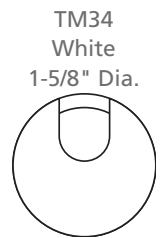

**GROMMETS (VERTICAL SURFACE)**

Standard Location - \$45 ea.

- Black Plastic Vertical Surface: TM50-C (Bottom Center)

Non-Standard Location - \$90 ea.

- Black Plastic Vertical Surface: TM50-NS

**STANDARD GROMMET LOCATION REFERENCE**

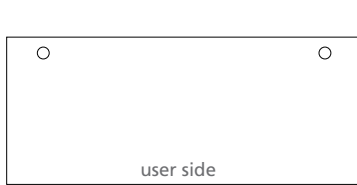

Desk  
Specify Right or Left Grommet



6" Overhang Desk  
Specify Right or Left Grommet

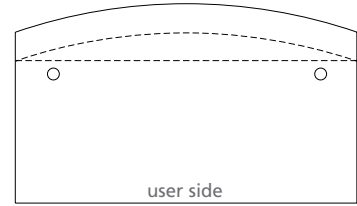

6" /12" Bow Front Desk  
Specify Right or Left Grommet



Bullet Conference Desk (Right Post)  
Center Grommet

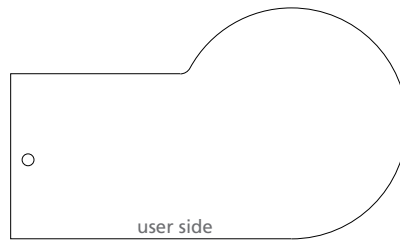

P Conference Desk (Right Post)  
Center Grommet

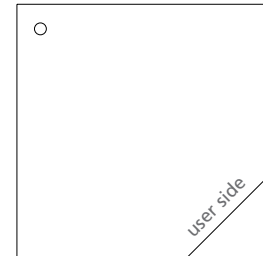

Corner  
Center Grommet



Bridge  
Center Grommet



Return (Left Pedestal Shown)  
Right Pedestal - Left Grommet  
Left Pedestal - Right Grommet

**GANGING – FLUSH CUT MODIFICATION**

30" H Casework Worksurface & Base Ganging Modifications

To gang two casework units, each unit end to be ganged must be flush cut modified for gapless surfaces and cabinet chassis.

Order Option:

- FC-B: Flush Unit Both Sides(Facing) for Ganging - \$50
- FC-L: Flush Unit Left (Facing) for Ganging - \$50
- FC-R: Flush Unit Right (Facing) for Ganging - \$50

Flush cut modification per unit includes all modifications to gang to one end or both ends when units are ganged. Modification includes tops, base and molding. Modification reduces width size approximately 1" per end.

Overhead consoles and towers are offered freestanding and ganging – inclusive of flush cut modifications.

Example:

NSS3121100W Two Drawer Lateral File (Left) Flush Cut Right – FC-R...\$50

NSS7221054 Kneespace Credenza (Right) Flush Cut Left – FC-L...\$50

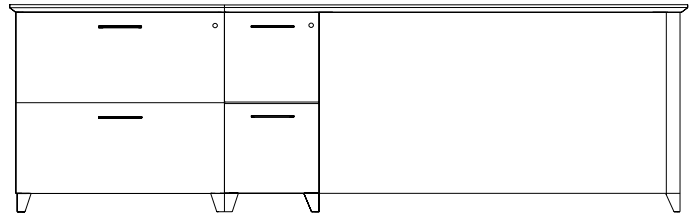

**HEIGHT REFERENCE**

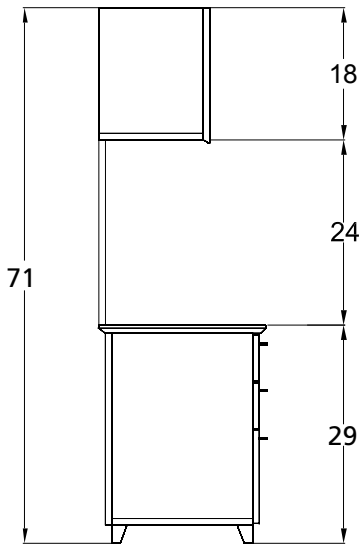

Typical Single Height Side Profile Wall Hung Overhead

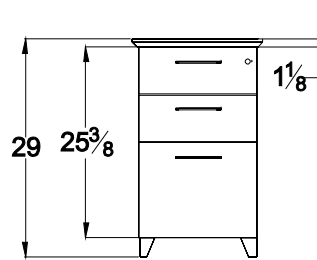

Pedestal Front Profile Box/Box/File

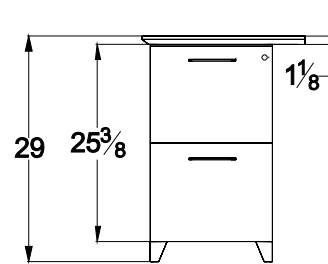

Pedestal Front Profile File/File

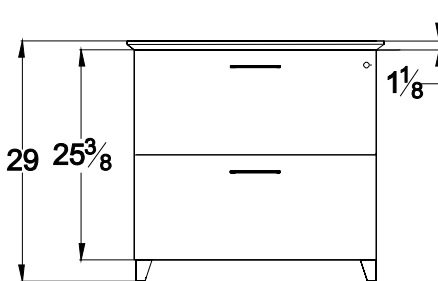

Pedestal Front Profile Lateral File

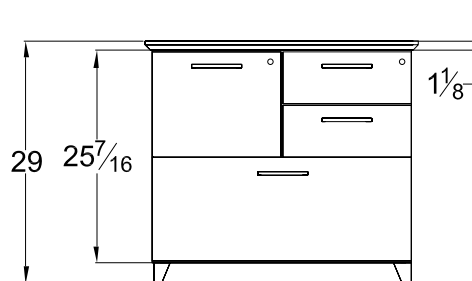

Pedestal Front Profile Multi-File

**CREDENZAS, OVERHEADS AND TOWERS**

Towers and overheads are standard flat top for easy ganging. No modification needed.

Credenza must be specified for flush cut ends when ganging to towers.

Credenza width matches overhead width when both credenza ends are flush cut.

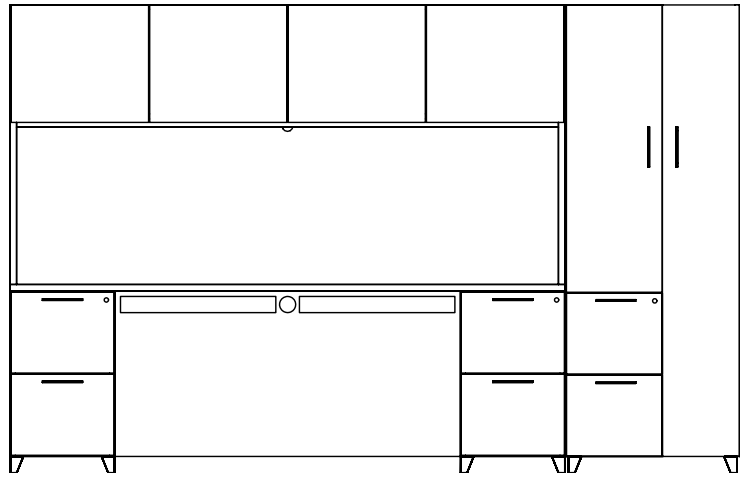

Order Option Number: FCG2 Flush Cut Modification. . . \$50 Per Unit.  
A drawing must be submitted to specify if one or both sides are to be flush cut.

METAL LEG OFFERING

CABINET ANGULAR FOOT  
Cast Angular Foot

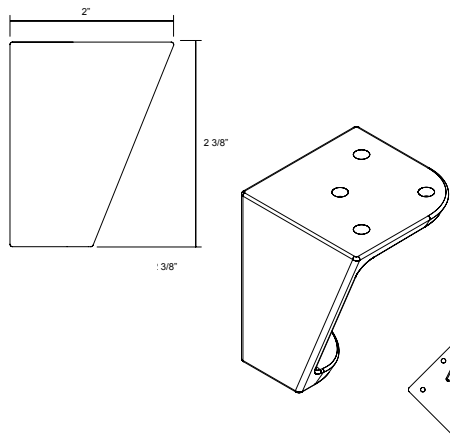

DESK ANGULAR POST

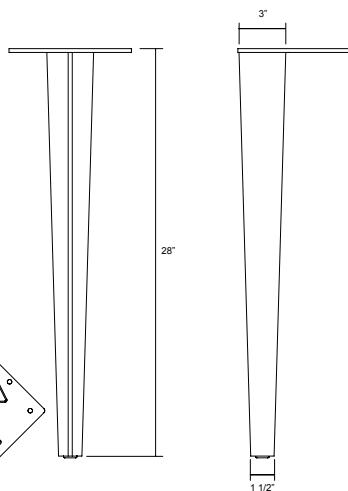

DESK ANGULAR SLEIGH BASE

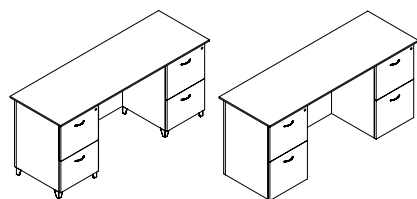
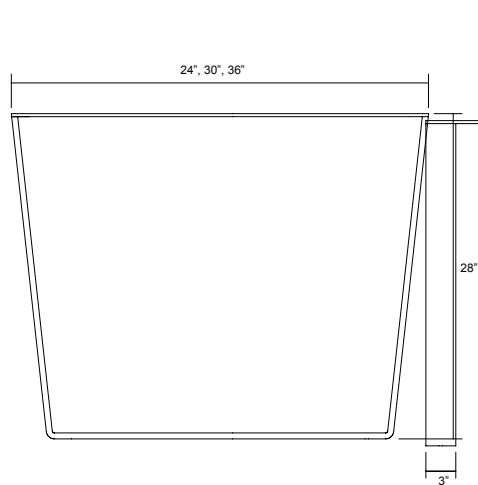

Option: Delete Feet/Extended Fronts

Standard metal feet can be deleted on any unit. Delete foot option extends chassis cabinets to floor. Drawer/Door fronts are extended to within 3/8" of full cabinet height when delete foot option is specified.

Delete Foot Chassis Modification Option: D8. . .deduct \$50

MODESTY REFERENCE

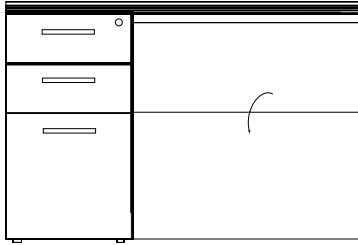

Top View

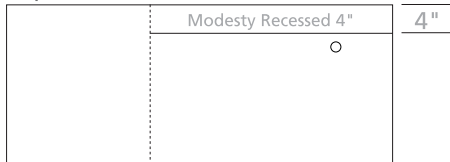

**M34**  
Drop Door Tech Modesty

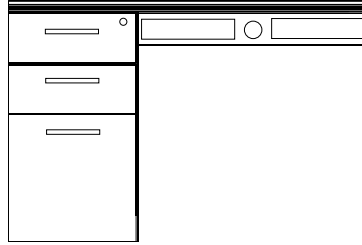

**M51**  
Open Back Modesty with 4" Wire Management Rail

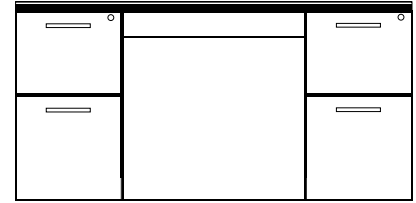

**M37**  
Fixed Full Modesty

GRAIN DIRECTION



Desk

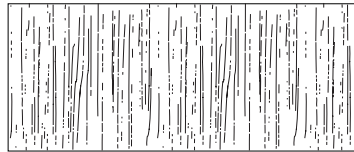

Runoff Desk  
Grain Direction on TFL Units  
Above 66" runs end to end

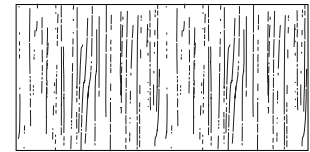

Bridge  
Grain Direction on TFL Units  
Above 66" runs end to end



Credenza

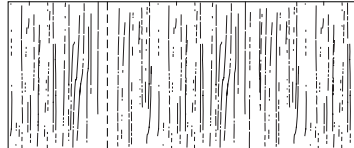

Return  
Grain Direction on TFL Units  
Above 66" runs end to end

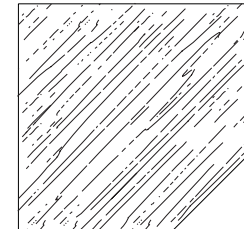

Corner

**INTERIOR DRAWER DIMENSIONS**

UNIT DEPTH	DRAWER TYPE	OVERALL DIMENSIONS			INTERIOR DRAWER DIMENSIONS			NOTES
		W	D	H	W	D	H	
15-5/8" Letter	36" Box	13-1/8	19-11/16	4	12-1/8	18-11/16	3-7/16	Units less than 72"
	36" File	13-1/8	19-11/16	9-13/16	12-1/8	18-11/16	9-5/16	Units less than 72"
	30" Box	13-1/8	19-11/16	4	12-1/8	18-11/16	3-7/16	Units less than 72"
	30" File	13-1/8	19-11/16	9-13/16	12-1/8	18-11/16	9-5/16	Units less than 72"
	24" Box	13-1/8	16-1/16	4	12-1/8	15-1/16	3-7/16	Units less than 72"
	24" File	13-1/8	16-1/16	9-13/16	12-1/8	15-1/16	9-5/16	Units less than 72"
29" Lateral	24" Box	26-1/2	16-1/16	4	25-1/2	15-1/16	3-7/16	Workstation Credenzas less than 82"
	24" File	26-1/2	16-1/16	9-13/16	25-1/2	15-1/16	9-5/16	Workstation Credenzas less than 82"
31" Lateral	24" File	28-9/16	16-1/16	9-13/16	27-9/16	15-1/16	9-5/16	Multi-File Lateral File
35" Lateral	24" Box	32-1/2	16-1/16	4	31-1/2	15-1/16	3-7/16	Workstation Credenzas over 83"
	24" File	32-1/2	16-1/16	9-13/16	31-1/2	15-1/16	9-5/16	Workstation Credenzas over 83"
41" Lateral	24" File	38-1/2	16-1/16	9-13/16	37-1/2	15-1/16	9-5/16	Wood Drawer Only

**FILING REFERENCE**

**FILING FOR 24" DEPTH UNITS**

13" Wide File Drawer - 16" Deep

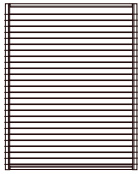

Letter Front to Back

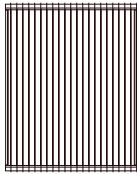

Legal Side to Side with File Rail

**FILING FOR 30" & 36" DEPTH UNITS**

13" Wide File Drawer - 20" Deep

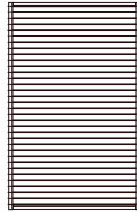

Letter Front to Back

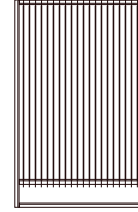

Legal Side to Side with File Rail

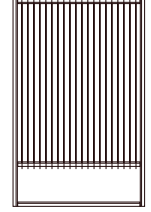

Letter Side to Side with File Rail

**29" LATERAL FILE DRAWER**

26-1/2" Wide File Drawer - 16-1/16" Deep

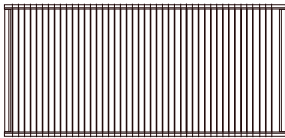

Legal Side to Side

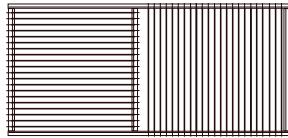

Legal Side to Side Letter Front to Back with File Rail

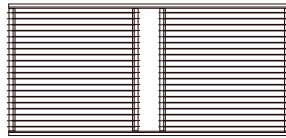

Letter Front to Back with File Rail

**35" LATERAL FILE DRAWER**

32-1/2" Wide File Drawer - 16-1/16" Deep

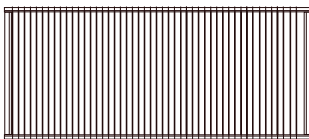

Legal Side to Side

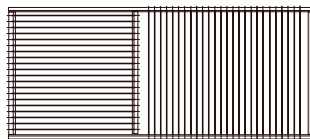

Legal Side to Side Letter Front to Back with File Rail

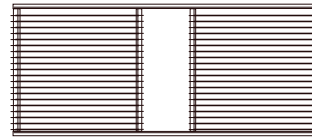

Letter Front to Back with File Rail

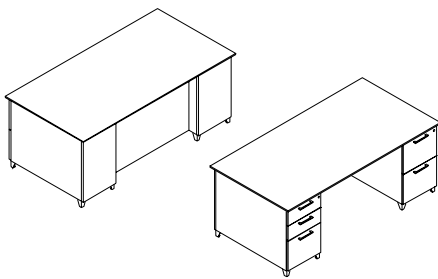

**BREAKFRONT - FULL PEDESTAL WITH MODESTY PANEL**

**STANDARD FEATURES**

- 6" recessed modesty
- Breakfront modesty
- Locking drawers
- Soft close suspension drawer(s)
- Standard Silver Feet (optional White, Black)

[CLICK HERE TO VIEW PRODUCT INDEX](#)

**1 SELECT A STYLE**

DIMENSIONS		STYLE NUMBER	LIST PRICE	STYLE NUMBER	LIST PRICE	STYLE NUMBER	LIST PRICE
"W" x "D" x "H"	WGT	"W" Veneer Veneer Top Veneer Chassis		"G" HPL High Pressure Laminate Top Veneer Chassis		"M" TFL Thermally Fused Laminate Top Thermally Fused Laminate Chassis	
84 x 36 x 29	350	NSS8436DD000W	3640	NSS8436DD000G	3640	NSS8436DD000M	2463
72 x 36 x 29	315	NSS7236DD000W	3385	NSS7236DD000G	3385	NSS7236DD000M	2375
72 x 30 x 29	295	NSS7230DD000W	3230	NSS7230DD000G	3230	NSS7230DD000M	2343
66 x 30 x 29	270	NSS6630DD000W	3200	NSS6630DD000G	3200	NSS6630DD000M	2292

**2 SELECT A FINISH**

"W" Veneer	"G" HPL	"M" TFL	Finish
WAC	GAC	-	Amber Cherry
WRC	-	-	Caramel Cherry
WIC	GIC	-	Crimson Cherry
WEC	-	-	Ebony Cherry
WHC	GHC	MHC	Honey Cherry
WOC	GOC	MOC	KoKo Cherry
WSC	-	-	Scotch Cherry
WAM	GAM	-	Alabaster Maple
WCM	GCM	-	Clear Maple
WWM	GWM	-	Wheat Maple
WEW	GEW	-	Executive Walnut
WRW	GRW	-	Gray Luster Walnut
WGW	-	MGW	Gunstock Walnut
WJW	-	-	Judicial Walnut
WNW	GNW	-	Natural Walnut
WTW	GTW	MTW	Studio Teak Walnut
WWP	GWL	MWL	Designer White

**METAL FINISHES**

MFB	-	-	Black (Premium Finish)
MFS	-	-	Silver
MFW	-	-	White (Premium Finish)

**3 SELECT AN EDGE**

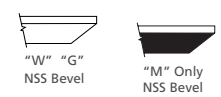

**4 SELECT HARDWARE**

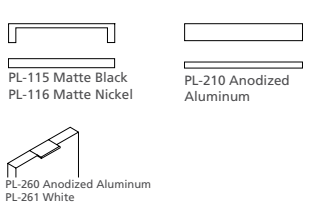

**5 OPTIONS**

- ACCESSORIES**
- K28: Articulating Keyboard w/ Mouse - \$375
  - K31: Center Drawer w/out Pull - \$195
- CHASSIS**
- MODCX: Modify breakfront chassis to flush front chassis - N/C
- DRAWER**
- P6: Modify File/File to Box/Box/File - \$50 per pedestal
  - P33: Wood Drawer Upgrade - \$40 per drawer
  - WPD3061: Full fill designer white - \$75 per pedestal
- FEET**
- D8: Delete feet (extend fronts to floor) - n/c
- FLUSH FRONT CHASSIS**
- MODCX: Breakfront chassis converted to flush front chassis - N/C
- GROMMETS (STANDARD LOCATION)**
- Specify Color and Location Right/Left - \$45 ea.
- Black: TM30-R (Right), TM30-L (Left)
  - Silver: TM31-R (Right), TM31-L (Left)
  - White: TM34-R (Right), TM34-L (Left)
- GROMMETS (NON-STANDARD LOCATION)**
- Provide drawing w/ Grommet Location and Specify Color - \$90 ea.
- Black: TM30-NS
  - Silver: TM31-NS
  - White: TM34-NS
- MODESTY**
- HM51: Half Modesty - \$195
  - HM39: SilverLuma frame/frost (Half Modesty) - \$325
  - MODCX: Flush Front Chassis w/ Overhang - n/c
- PREMIUM FINISH OPTION**
- MFB: Black metal finish - \$25 per foot
  - MFW: White metal finish - \$25 per foot

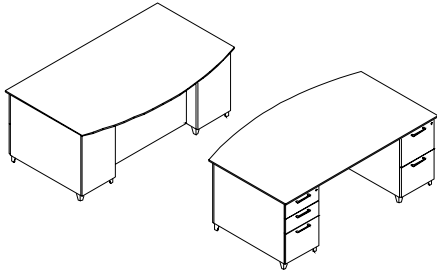

**BREAKFRONT - BOWFRONT FULL PEDESTAL**

**STANDARD FEATURES**

- 6" recessed modesty
- Breakfront modesty
- Locking drawers
- Soft close suspension drawer(s)
- Standard Silver Feet (optional White, Black)

[CLICK HERE TO VIEW PRODUCT INDEX](#)

**1 SELECT A STYLE**

DIMENSIONS		STYLE NUMBER		LIST PRICE	STYLE NUMBER		LIST PRICE	STYLE NUMBER		LIST PRICE
W" x D" x H"	WGT	"W" Veneer	Veneer Top Veneer Chassis		"G" HPL	High Pressure Laminate Top Veneer Chassis		"M" TFL	Thermally Fused Laminate Top Thermally Fused Laminate Chassis	
84 x 36/42 x 29	360	NSS8442DD006W		3805	NSS8442DD006G		3805	NSS8442DD006M		2567
72 x 36/42 x 29	325	NSS7242DD006W		3510	NSS7242DD006G		3510	NSS7242DD006M		2479
72 x 30/36 x 29	305	NSS7236DD006W		3355	NSS7236DD006G		3355	NSS7236DD006M		2448

**2 SELECT A FINISH**

"W" Veneer	"G" HPL	"M" TFL	Finish
WAC	GAC	-	Amber Cherry
WRC	-	-	Caramel Cherry
WIC	GIC	-	Crimson Cherry
WEC	-	-	Ebony Cherry
WHC	GHC	MHC	Honey Cherry
WOC	GOC	MOC	KoKo Cherry
WSC	-	-	Scotch Cherry
WAM	GAM	-	Alabaster Maple
WCM	GCM	-	Clear Maple
WWM	GWM	-	Wheat Maple
WEW	GEW	-	Executive Walnut
WRW	GRW	-	Gray Luster Walnut
WGW	-	MGW	Gunstock Walnut
WJW	-	-	Judicial Walnut
WNW	GNW	-	Natural Walnut
WTW	GTW	MTW	Studio Teak Walnut
WWP	GWL	MWL	Designer White

**METAL FINISHES**

MFB	-	-	Black (Premium Finish)
MFS	-	-	Silver
MFW	-	-	White (Premium Finish)

**3 SELECT AN EDGE**

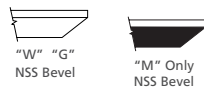

**4 SELECT HARDWARE**

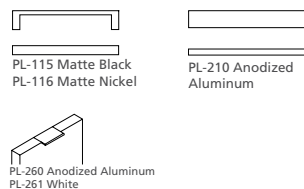

**5 OPTIONS**

**ACCESSORIES**

- K28: Articulating Keyboard w/ Mouse - \$375
- K31: Center Drawer w/out Pull - \$195

**CHASSIS**

- MODCX: Modify breakfront chassis to flush front chassis - N/C

**DRAWER**

- P6: Modify File/File to Box/Box/File - \$50 per pedestal
- P33: Wood Drawer Upgrade - \$40 per drawer
- WPD3061: Full fill designer white - \$75 per pedestal

**FEET**

- D8: Delete feet (extend fronts to floor) - n/c

**GROMMETS (STANDARD LOCATION)**

- Specify Color and Location Right/Left - \$45 ea.
- Black: TM30-R (Right), TM30-L (Left)
  - Silver: TM31-R (Right), TM31-L (Left)
  - White: TM34-R (Right), TM34-L (Left)

**GROMMETS (NON-STANDARD LOCATION)**

- Provide drawing w/ Grommet Location and Specify Color - \$90 ea.
- Black: TM30-NS
  - Silver: TM31-NS
  - White: TM34-NS

**MODESTY**

- HM51: Half Modesty - \$195
- HM39: SilverLuma frame/frost (Half Modesty) - \$325
- MODCX: Flush Front Chassis w/ Overhang - n/c

**PREMIUM FINISH OPTION**

- MFB: Black metal finish - \$25 per foot
- MFW: White metal finish - \$25 per foot



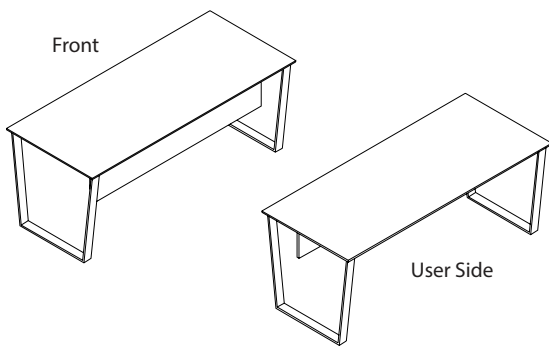

TABLE DESK WITH SLEIGH BASE

STANDARD FEATURES

- Half modesty panel standard
- Freestanding use
- Standard table desk sleigh base is silver metal finish (optional white or black)

[CLICK HERE TO VIEW PRODUCT INDEX](#)

1 SELECT A STYLE

DIMENSIONS		STYLE NUMBER	LIST PRICE	STYLE NUMBER	LIST PRICE	STYLE NUMBER	LIST PRICE
W" x D" x H"	WGT	"W" Veneer Top Veneer Chassis		"G" HPL High Pressure Laminate Top Veneer Chassis		"M" TFL Thermally Fused Laminate Top Thermally Fused Laminate Chassis	
72 x 36 x 29	150	NSS7236DT107W	3150	NSS7236DT107G	3150	NSS7236DT107M	1882
72 x 30 x 29	135	NSS7230DT107W	3015	NSS7230DT107G	3015	NSS7230DT107M	1818
66 x 30 x 29	125	NSS6630DT107W	2975	NSS6630DT107G	2975	NSS6630DT107M	1752

2 SELECT A FINISH

"W" Veneer	"G" HPL	"M" TFL	Finish
WAC	GAC	-	Amber Cherry
WRC	-	-	Caramel Cherry
WIC	GIC	-	Crimson Cherry
WEC	-	-	Ebony Cherry
WHC	GHC	MHC	Honey Cherry
WOC	GOC	MOC	KoKo Cherry
WSC	-	-	Scotch Cherry
WAM	GAM	-	Alabaster Maple
WCM	GCM	-	Clear Maple
WWM	GWM	-	Wheat Maple
WEW	GEW	-	Executive Walnut
WRW	GRW	-	Gray Luster Walnut
WGW	-	MGW	Gunstock Walnut
WJW	-	-	Judicial Walnut
WNW	GNW	-	Natural Walnut
WTW	GTW	MTW	Studio Teak Walnut
WWP	GWL	MWL	Designer White

METAL FINISHES

MFB	-	-	Black (Premium Finish)
MFS	-	-	Silver
MFW	-	-	White (Premium Finish)

3 SELECT AN EDGE

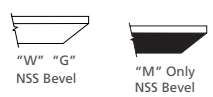

5 OPTIONS

- ACCESSORIES**
- K28: Articulating Keyboard w/ Mouse - \$375
  - K31: Center Drawer w/out Pull - \$195
  - W17: Wire Mgmt. Cover for Leg - \$55
- GROMMETS (STANDARD LOCATION)**  
Specify Color and Location Right/Left - \$45 ea.
- Black: TM30-R (Right), TM30-L (Left)
  - Silver: TM31-R (Right), TM31-L (Left)
  - White: TM34-R (Right), TM34-L (Left)
- GROMMETS (NON-STANDARD LOCATION)**  
Provide drawing w/ Grommet Location and Specify Color - \$90 ea.
- Black: TM30-NS
  - Silver: TM31-NS
  - White: TM34-NS
- PREMIUM FINISH OPTION**
- MFB: Black metal finish - \$95 per base
  - MFW: White metal finish - \$95 per base

4 SELECT HARDWARE

Hardware Option Not Available

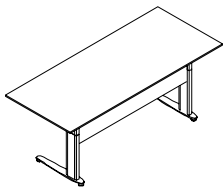

**ADJUSTABLE DESK / MOTORIZED**

**STANDARD FEATURES**

- Adjustable height base - silver
- Electronic mechanism with programmable lift

**NOTES**

- Shipped KD

[CLICK HERE TO VIEW PRODUCT INDEX](#)

**1 SELECT A STYLE**

DIMENSIONS		STYLE NUMBER	LIST PRICE	STYLE NUMBER	LIST PRICE	STYLE NUMBER	LIST PRICE
W" x D" x H"	WGT	"W" Veneer Veneer Top Veneer Chassis		"G" HPL High Pressure Laminate Top Veneer Chassis		"M" TFL Thermally Fused Laminate Top Thermally Fused Laminate Chassis	
72 x 30 x 29-48	230	NSS7230DT090W	4180	NSS7230DT090G	4180	NSS7230DT090M	2796
66 x 30 x 29-48	215	NSS6630DT090W	4155	NSS6630DT090G	4155	NSS6630DT090M	2735
60 x 30 x 29-48	200	NSS6030DT090W	4120	NSS6030DT090G	4120	NSS6030DT090M	2663

**2 SELECT A FINISH**

"W" Veneer	"G" HPL	"M" TFL	Finish
WAC	GAC	-	Amber Cherry
WRC	-	-	Caramel Cherry
WIC	GIC	-	Crimson Cherry
WEC	-	-	Ebony Cherry
WHC	GHC	MHC	Honey Cherry
WOC	GOC	MOC	KoKo Cherry
WSC	-	-	Scotch Cherry
WAM	GAM	-	Alabaster Maple
WCM	GCM	-	Clear Maple
WWM	GWM	-	Wheat Maple
WEW	GEW	-	Executive Walnut
WRW	GRW	-	Gray Luster Walnut
WGW	-	MGW	Gunstock Walnut
WJW	-	-	Judicial Walnut
WNW	GNW	-	Natural Walnut
WTW	GTW	MTW	Studio Teak Walnut
WWP	GWL	MWL	Designer White

**3 SELECT AN EDGE**

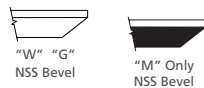

**4 SELECT HARDWARE**

Hardware Option Not Available

**5 OPTIONS**

**ACCESSORIES**

- K28: Articulating Keyboard w/ Mouse - \$375
- K31: Center Drawer w/out Pull - \$195
- W18: Coil Cable Manager - \$150

**GROMMETS (STANDARD LOCATION)**

Specify Color and Location Right/Left - \$45 ea.

- Black: TM30-R (Right), TM30-L (Left)
- Silver: TM31-R (Right), TM31-L (Left)
- White: TM34-R (Right), TM34-L (Left)

**GROMMETS (NON-STANDARD LOCATION)**

Provide drawing w/ Grommet Location and Specify Color - \$90 ea.

- Black: TM30-NS
- Silver: TM31-NS
- White: TM34-NS

**MODESTY**

- HM3: Veneer Half Modesty - \$250 (For "W" and "G")
- HM3M: Melamine Half Modesty - \$195 (For "M")

Left Pedestal

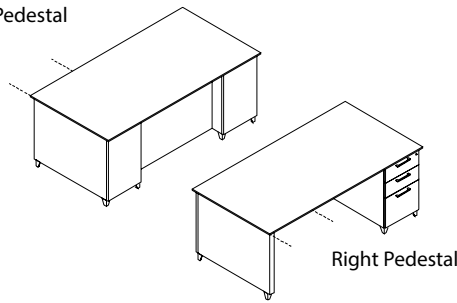

**BREAKFRONT SINGLE PEDESTAL**

**STANDARD FEATURES**

- 6" recessed modesty
- Full extension drawers - locking
- Soft close suspension drawer(s)
- Standard Silver Feet (optional White, Black)

[CLICK HERE TO VIEW PRODUCT INDEX](#)

**1 SELECT A STYLE**

DIMENSIONS		STYLE NUMBER		LIST PRICE	STYLE NUMBER		LIST PRICE	STYLE NUMBER		LIST PRICE
W" x D" x H"	WGT	"W" Veneer	Veneer Top Veneer Chassis		"G" HPL	High Pressure Laminate Top Veneer Chassis		"M" TFL	Thermally Fused Laminate Top Thermally Fused Laminate Chassis	
<b>Left Pedestal</b>										
84 x 36 x 29	325	NSS8436DS009W		3550	NSS8436DS009G		3550	NSS8436DS009M		2079
72 x 36 x 29	300	NSS7236DS009W		3305	NSS7236DS009G		3305	NSS7236DS009M		2000
72 x 30 x 29	270	NSS7230DS009W		3155	NSS7230DS009G		3155	NSS7230DS009M		1951
66 x 30 x 29	260	NSS6630DS009W		3130	NSS6630DS009G		3130	NSS6630DS009M		1913
<b>Right Pedestal</b>										
84 x 36 x 29	325	NSS8436DS010W		3550	NSS8436DS010G		3550	NSS8436DS010M		2079
72 x 36 x 29	300	NSS7236DS010W		3305	NSS7236DS010G		3305	NSS7236DS010M		2000
72 x 30 x 29	270	NSS7230DS010W		3155	NSS7230DS010G		3155	NSS7230DS010M		1951
66 x 30 x 29	260	NSS6630DS010W		3130	NSS6630DS010G		3130	NSS6630DS010M		1913

**2 SELECT A FINISH**

"W" Veneer	"G" HPL	"M" TFL	Finish
WAC	GAC	-	Amber Cherry
WRC	-	-	Caramel Cherry
WIC	GIC	-	Crimson Cherry
WEC	-	-	Ebony Cherry
WHC	GHC	MHC	Honey Cherry
WOC	GOC	MOC	KoKo Cherry
WSC	-	-	Scotch Cherry
WAM	GAM	-	Alabaster Maple
WCM	GCM	-	Clear Maple
WWM	GWM	-	Wheat Maple
WEW	GEW	-	Executive Walnut
WRW	GRW	-	Gray Luster Walnut
WGW	-	MGW	Gunstock Walnut
WJW	-	-	Judicial Walnut
WNW	GNW	-	Natural Walnut
WTW	GTW	MTW	Studio Teak Walnut
WWP	GWL	MWL	Designer White
<b>METAL FINISHES</b>			
MFB	-	-	Black (Premium Finish)
MFS	-	-	Silver
MFW	-	-	White (Premium Finish)

**3 SELECT AN EDGE**

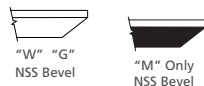

**4 SELECT HARDWARE**

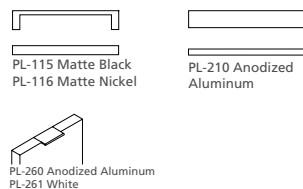

**5 OPTIONS**

- ACCESSORIES**
- K28: Articulating Keyboard w/ Mouse - \$375
  - K31: Center Drawer - \$195
- CHASSIS**
- MODCX: Modify breakfront chassis to flush front chassis - N/C
- DRAWER**
- P33: Wood Drawer Upgrade - \$40 per drawer
  - WPD3061: Full fill designer white - \$75 per pedestal
- FEET**
- D8: Delete feet (extend fronts to floor) - n/c
- FLUSH FRONT CHASSIS**
- MODCX: Breakfront chassis converted to flush front chassis - N/C
- GROMMETS (STANDARD LOCATION)**
- Specify Color and Location Right/Left - \$45 ea.
- Black: TM30-R (Right), TM30-L (Left)
  - Silver: TM31-R (Right), TM31-L (Left)
  - White: TM34-R (Right), TM34-L (Left)
- GROMMETS (NON-STANDARD LOCATION)**
- Provide drawing w/ Grommet Location and Specify Color - \$90 ea.
- Black: TM30-NS
  - Silver: TM31-NS
  - White: TM34-NS
- MODESTY**
- HM39: SilverLuma frame/frost (Half Modesty) - \$325
  - HM51: Half Modesty - \$195
  - MODCX: Flush Front Chassis w/ Overhang - n/c
- PREMIUM FINISH OPTION**
- MFB: Black metal finish - \$25 per foot
  - MFW: White metal finish - \$25 per foot

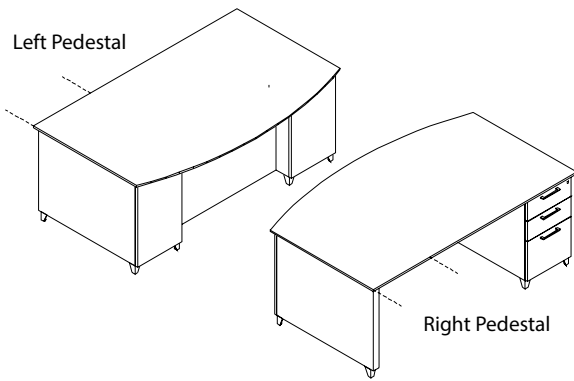

**BOWFRONT BREAKFRONT SINGLE PEDESTAL**

**STANDARD FEATURES**

- 12" recessed modesty from work surface edge
- Full extension drawers - locking
- Soft close suspension drawer(s)
- Standard Silver Feet (optional White, Black)

[CLICK HERE TO VIEW PRODUCT INDEX](#)

**1 SELECT A STYLE**

DIMENSIONS		STYLE NUMBER	LIST PRICE	STYLE NUMBER	LIST PRICE	STYLE NUMBER	LIST PRICE
W" x D" x H"	WGT	"W" Veneer Veneer Top Veneer Chassis		"G" HPL High Pressure Laminate Top Veneer Chassis		"M" TFL Thermally Fused Laminate Top Thermally Fused Laminate Chassis	
<b>Left Pedestal</b>							
84 x 36/42 x 29	360	NSS8442DS017W	3715	NSS8442DS017G	3715	NSS8442DS017M	2203
72 x 36/42 x 29	340	NSS7242DS017W	3430	NSS7242DS017G	3430	NSS7242DS017M	2130
72 x 30/36 x 29	315	NSS7236DS017W	3280	NSS7236DS017G	3280	NSS7236DS017M	2085
<b>Right Pedestal</b>							
84 x 36/42 x 29	360	NSS8442DS018W	3715	NSS8442DS018G	3715	NSS8442DS018M	2203
72 x 36/42 x 29	340	NSS7242DS018W	3430	NSS7242DS018G	3430	NSS7242DS018M	2130
72 x 30/36 x 29	315	NSS7236DS018W	3280	NSS7236DS018G	3280	NSS7236DS018M	2085

**2 SELECT A FINISH**

"W" Veneer	"G" HPL	"M" TFL	Finish
WAC	GAC	-	Amber Cherry
WRC	-	-	Caramel Cherry
WIC	GIC	-	Crimson Cherry
WEC	-	-	Ebony Cherry
WHC	GHC	MHC	Honey Cherry
WOC	GOC	MOC	KoKo Cherry
WSC	-	-	Scotch Cherry
WAM	GAM	-	Alabaster Maple
WCM	GCM	-	Clear Maple
WWM	GWM	-	Wheat Maple
WEW	GEW	-	Executive Walnut
WRW	GRW	-	Gray Luster Walnut
WGW	-	MGW	Gunstock Walnut
WJW	-	-	Judicial Walnut
WNW	GNW	-	Natural Walnut
WTW	GTW	MTW	Studio Teak Walnut
WWP	GWL	MWL	Designer White
<b>METAL FINISHES</b>			
MFB	-	-	Black (Premium Finish)
MFS	-	-	Silver
MFW	-	-	White (Premium Finish)

**3 SELECT AN EDGE**

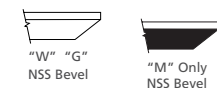

**4 SELECT HARDWARE**

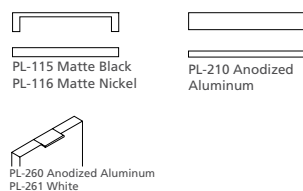

**5 OPTIONS**

- ACCESSORIES**
- K28: Articulating Keyboard w/ Mouse - \$375
  - K31: Center Drawer - \$195
- CHASSIS**
- MODCX: Modify breakfront chassis to flush front chassis - N/C
- DRAWER**
- P33: Wood Drawer Upgrade - \$40 per drawer
  - WPD3061: Full fill designer white - \$75 per pedestal
- FEET**
- D8: Delete feet (extend fronts to floor) - n/c
- GROMMETS (STANDARD LOCATION)**
- Specify Color and Location Right/Left - \$45 ea.
- Black: TM30-R (Right), TM30-L (Left)
  - Silver: TM31-R (Right), TM31-L (Left)
  - White: TM34-R (Right), TM34-L (Left)
- GROMMETS (NON-STANDARD LOCATION)**
- Provide drawing w/ Grommet Location and Specify Color - \$90 ea.
- Black: TM30-NS
  - Silver: TM31-NS
  - White: TM34-NS
- MODESTY**
- HM39: SilverLuma frame/frost (Half Modesty) - \$325
  - HM51: Half Modesty - \$195
  - MODCX: Flush Front Chassis w/ Overhang - n/c
- PREMIUM FINISH OPTION**
- MFB: Black metal finish - \$25 per foot
  - MFW: White metal finish - \$25 per foot

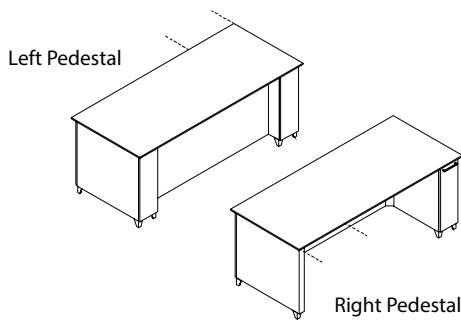

**ORGANIZER DESK**

**STANDARD FEATURES**

- 6" recessed modesty
- Standard Silver Feet (optional White, Black)

**NOTES**

- Organizer Pedestal Detail: 8"W Pullout cabinet drawer features: Pencil tray, CD tray, hanging folder rack, utility tray & shelves. Non locking.

[CLICK HERE TO VIEW PRODUCT INDEX](#)

**1 SELECT A STYLE**

DIMENSIONS		STYLE NUMBER		LIST PRICE	STYLE NUMBER		LIST PRICE	STYLE NUMBER		LIST PRICE
W" x D" x H"	WGT	"W" Veneer	Veneer Top Veneer Chassis		"G" HPL	High Pressure Laminate Top Veneer Chassis		"M" TFL	Thermally Fused Laminate Top Thermally Fused Laminate Chassis	
<b>Left Pedestal</b>										
72 x 30 x 29	215	NSS7230DS704W		3470	NSS7230DS704G		3470	NSS7230DS704M		2149
66 x 30 x 29	200	NSS6630DS704W		3435	NSS6630DS704G		3435	NSS6630DS704M		2099
60 x 30 x 29	190	NSS6030DS704W		3400	NSS6030DS704G		3400	NSS6030DS704M		2043
<b>Right Pedestal</b>										
72 x 30 x 29	215	NSS7230DS703W		3470	NSS7230DS703G		3470	NSS7230DS703M		2149
66 x 30 x 29	200	NSS6630DS703W		3435	NSS6630DS703G		3435	NSS6630DS703M		2099
60 x 30 x 29	190	NSS6030DS703W		3400	NSS6030DS703G		3400	NSS6030DS703M		2043

**2 SELECT A FINISH**

"W" Veneer	"G" HPL	"M" TFL	Finish
WAC	GAC	-	Amber Cherry
WRC	-	-	Caramel Cherry
WIC	GIC	-	Crimson Cherry
WEC	-	-	Ebony Cherry
WHC	GHC	MHC	Honey Cherry
WOC	GOC	MOC	KoKo Cherry
WSC	-	-	Scotch Cherry
WAM	GAM	-	Alabaster Maple
WCM	GCM	-	Clear Maple
WWM	GWM	-	Wheat Maple
WEW	GEW	-	Executive Walnut
WRW	GRW	-	Gray Luster Walnut
WGW	-	MGW	Gunstock Walnut
WJW	-	-	Judicial Walnut
WNW	GNW	-	Natural Walnut
WTW	GTW	MTW	Studio Teak Walnut
WWP	GWL	MWL	Designer White
<b>METAL FINISHES</b>			
MFB	-	-	Black (Premium Finish)
MFS	-	-	Silver
MFW	-	-	White (Premium Finish)

**3 SELECT AN EDGE**

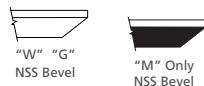

**4 SELECT HARDWARE**

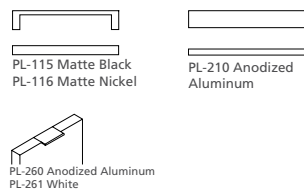

**5 OPTIONS**

**ACCESSORIES**

- K28: Articulating Keyboard w/ Mouse - \$375
- K31: Center Drawer - \$195

**CHASSIS**

- MODCX: Modify breakfront chassis to flush front chassis - N/C

**FEET**

- D8: Delete feet (extend fronts to floor) - n/c

**FLUSH FRONT CHASSIS**

- MODCX: Breakfront chassis converted to flush front chassis - N/C

**GROMMETS (STANDARD LOCATION)**

Specify Color and Location Right/Left - \$45 ea.

- Black: TM30-R (Right), TM30-L (Left)
- Silver: TM31-R (Right), TM31-L (Left)
- White: TM34-R (Right), TM34-L (Left)

**GROMMETS (NON-STANDARD LOCATION)**

Provide drawing w/ Grommet Location and Specify Color - \$90 ea.

- Black: TM30-NS
- Silver: TM31-NS
- White: TM34-NS

**MODESTY**

- HM39: SilverLuma frame/frost (Half Modesty) - \$325
- HM51: Half Modesty - \$195
- MODCX: Flush Front Chassis w/ Overhang - n/c

**PREMIUM FINISH OPTION**

- MFB: Black metal finish - \$25 per foot
- MFW: White metal finish - \$25 per foot

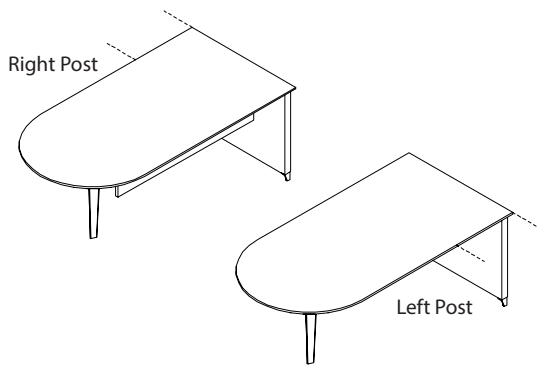

**BULLET TOP WITH TAPERED METAL LEG**

**STANDARD FEATURES**

- 2" thick end panel
- Half modesty
- Standard silver tapered metal leg
- Standard Silver Feet

**NOTES**

- K28 and K31 will not fit on 24" deep units w/ half modesty
- "P" Tops and Bullets are not intended to be freestanding

[CLICK HERE TO VIEW PRODUCT INDEX](#)

**1 SELECT A STYLE**

DIMENSIONS		STYLE NUMBER	LIST PRICE	STYLE NUMBER	LIST PRICE	STYLE NUMBER	LIST PRICE
W" x D" x H"	WGT	"W" Veneer Top Veneer Chassis		"G" HPL High Pressure Laminate Top Veneer Chassis		"M" TFL Thermally Fused Laminate Top Thermally Fused Laminate Chassis	
<b>Left Post</b>							
84 x 36 x 29	195	NSS8436DC716W	3160	NSS8436DC716G	3160	NSS8436DC716M	1514
72 x 36 x 29	165	NSS7236DC716W	2865	NSS7236DC716G	2865	NSS7236DC716M	1437
72 x 30 x 29	145	NSS7230DC716W	2745	NSS7230DC716G	2745	NSS7230DC716M	1342
66 x 30 x 29	125	NSS6630DC716W	2715	NSS6630DC716G	2715	NSS6630DC716M	1294
60 x 24 x 29	115	NSS6024DC716W	1720	NSS6024DC716G	1720	NSS6024DC716M	1260
54 x 24 x 29	105	NSS5424DC716W	1700	NSS5424DC716G	1700	NSS5424DC716M	1225
<b>Right Post</b>							
84 x 36 x 29	195	NSS8436DC715W	3160	NSS8436DC715G	3160	NSS8436DC715M	1514
72 x 36 x 29	165	NSS7236DC715W	2865	NSS7236DC715G	2865	NSS7236DC715M	1437
72 x 30 x 29	145	NSS7230DC715W	2745	NSS7230DC715G	2745	NSS7230DC715M	1342
66 x 30 x 29	125	NSS6630DC715W	2715	NSS6630DC715G	2715	NSS6630DC715M	1294
60 x 24 x 29	115	NSS6024DC715W	1720	NCC6024DC715G	1720	NSS6024DC715M	1260
54 x 24 x 29	105	NSS5424DC715W	1700	NSS5424DC715G	1700	NSS5424DC715M	1225

**2 SELECT A FINISH**

"W" Veneer	"G" HPL	"M" TFL	Finish
WAC	GAC	-	Amber Cherry
WRC	-	-	Caramel Cherry
WIC	GIC	-	Crimson Cherry
WEC	-	-	Ebony Cherry
WHC	GHC	MHC	Honey Cherry
WOC	GOC	MOC	KoKo Cherry
WSC	-	-	Scotch Cherry
WAM	GAM	-	Alabaster Maple
WCM	GCM	-	Clear Maple
WWM	GWM	-	Wheat Maple
WEW	GEW	-	Executive Walnut
WRW	GRW	-	Gray Luster Walnut
WGW	-	MGW	Gunstock Walnut
WJW	-	-	Judicial Walnut
WNW	GNW	-	Natural Walnut
WTW	GTW	MTW	Studio Teak Walnut
WWP	GWL	MWL	Designer White

**3 SELECT AN EDGE**



**5 OPTIONS**

- ACCESSORIES**
- K31: Center Drawer - \$195
  - K28: Articulating Keyboard w/ Mouse - \$375
- GROMMETS (STANDARD LOCATION)**
- Specify Color - \$45 ea.
- Black: TM30-C (Center)
  - Silver: TM31-C (Center)
  - White: TM34-C (Center)
- GROMMETS (NON-STANDARD LOCATION)**
- Provide drawing w/ Grommet Location and Specify Color - \$90 ea.
- Black: TM30-NS
  - Silver: TM31-NS
  - White: TM34-NS
- MODESTY**
- DM: Delete half modesty - n/c
  - HM45: SilverLuma frame/frost insert (half modesty) - \$395

**4 SELECT HARDWARE**

Hardware Option Not Available

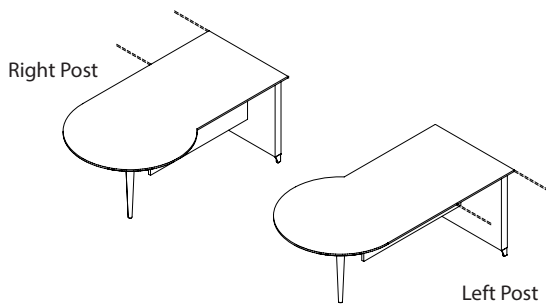

**"P" TOP WITH TAPERED METAL LEG**

**STANDARD FEATURES**

- 2" thick end panel
- Half modesty
- Standard silver tapered metal leg
- Standard Silver Feet

**NOTES**

- "P" Tops and Bullets are not intended to be freestanding

[CLICK HERE TO VIEW PRODUCT INDEX](#)

**1 SELECT A STYLE**

DIMENSIONS		STYLE NUMBER	LIST PRICE	STYLE NUMBER	LIST PRICE	STYLE NUMBER	LIST PRICE
W" x D" x H"	WGT	"W" Veneer Veneer Top Veneer Chassis		"G" HPL High Pressure Laminate Top Veneer Chassis		"M" TFL Thermally Fused Laminate Top Thermally Fused Laminate Chassis	
<b>Left Post</b>							
84 x 36/42 x 29	225	NSS8442DC028W	3290	NSS8442DC028G	3290	NSS8442DC028M	1812
72 x 36 /42 x 29	200	NSS7242DC028W	2985	NSS7242DC028G	2985	NSS7242DC028M	1739
72 x 30/36 x 29	175	NSS7236DC028W	2885	NSS7236DC028G	2885	NSS7236DC028M	1646
66 x 30/36 x 29	145	NSS6636DC028W	2855	NSS6636DC028G	2855	NSS6636DC028M	1590
<b>Right Post</b>							
84 x 36/42 x 29	225	NSS8442DC027W	3290	NSS8442DC027G	3290	NSS8442DC027M	1812
72 x 36/42 x 29	200	NSS7242DC027W	2985	NSS7242DC027G	2985	NSS7242DC027M	1739
72 x 30/36 x 29	175	NSS7236DC027W	2885	NSS7236DC027G	2885	NSS7236DC027M	1646
66 x 30/36 x 29	145	NSS6636DC027W	2855	NSS6636DC027G	2855	NSS6636DC027M	1590

**2 SELECT A FINISH**

"W" Veneer	"G" HPL	"M" TFL	Finish
WAC	GAC	-	Amber Cherry
WRC	-	-	Caramel Cherry
WIC	GIC	-	Crimson Cherry
WEC	-	-	Ebony Cherry
WHC	GHC	MHC	Honey Cherry
WOC	GOC	MOC	KoKo Cherry
WSC	-	-	Scotch Cherry
WAM	GAM	-	Alabaster Maple
WCM	GCM	-	Clear Maple
WWM	GWM	-	Wheat Maple
WEW	GEW	-	Executive Walnut
WRW	GRW	-	Gray Luster Walnut
WGW	-	MGW	Gunstock Walnut
WJW	-	-	Judicial Walnut
WNW	GNW	-	Natural Walnut
WTW	GTW	MTW	Studio Teak Walnut
WWP	GWL	MWL	Designer White

**3 SELECT AN EDGE**

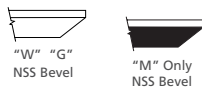

**5 OPTIONS**

- ACCESSORIES**
- K31: Center Drawer - \$195
  - K28: Articulating Keyboard w/ Mouse - \$375
- GROMMETS (STANDARD LOCATION)**
- Specify Color - \$45 ea.
- Black: TM30-C (Center)
  - Silver: TM31-C (Center)
  - White: TM34-C (Center)
- GROMMETS (NON-STANDARD LOCATION)**
- Provide drawing w/ Grommet Location and Specify Color - \$90 ea.
- Black: TM30-NS
  - Silver: TM31-NS
  - White: TM34-NS
- MODESTY**
- DM: Delete half modesty - n/c
  - HM45: SilverLuma frame/frost insert (half modesty) - \$395

**4 SELECT HARDWARE**

Hardware Option Not Available

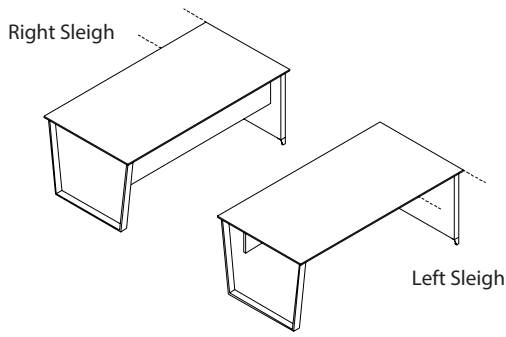

**RECTANGLE TOP WITH SLEIGH BASE**

**STANDARD FEATURES**

- 2" thick end panel
- Angular silver metal sleigh base
- Half modesty
- Standard Silver Feet and Base (optional White, Black)

**NOTES**

- K28 and K31 will not fit on 24" deep units w/ half modesty

[CLICK HERE TO VIEW PRODUCT INDEX](#)

**1 SELECT A STYLE**

DIMENSIONS		STYLE NUMBER	LIST PRICE	STYLE NUMBER	LIST PRICE	STYLE NUMBER	LIST PRICE
W" x D" x H"	WGT	"W" Veneer Veneer Top Veneer Chassis		"G" HPL High Pressure Laminate Top Veneer Chassis		"M" TFL Thermally Fused Laminate Top Thermally Fused Laminate Chassis	
		<b>Right Sleigh Leg</b>					
84 x 36 x 29	195	NSS8436DC766W	3305	NSS8436DC766G	3305	NSS8436DC766M	1892
72 x 36 x 29	165	NSS7236DC766W	3010	NSS7236DC766G	3010	NSS7236DC766M	1810
72 x 30 x 29	145	NSS7230DC766W	2875	NSS7230DC766G	2875	NSS7230DC766M	1706
66 x 30 x 29	125	NSS6630DC766W	2845	NSS6630DC766G	2845	NSS6630DC766M	1654
60 x 24 x 29	115	NSS6024DC766W	1850	NSS6024DC766G	1850	NSS6024DC766M	1617
54 x 24 x 29	105	NSS5424DC766W	1830	NSS5424DC766G	1830	NSS5424DC766M	1580
<b>Left Sleigh Leg</b>							
84 x 36 x 29	195	NSS8436DC767W	3305	NSS8436DC767G	3305	NSS8436DC767M	1892
72 x 36 x 29	165	NSS7236DC767W	3010	NSS7236DC767G	3010	NSS7236DC767M	1810
72 x 30 x 29	145	NSS7230DC767W	2875	NSS7230DC767G	2875	NSS7230DC767M	1706
66 x 30 x 29	125	NSS6630DC767W	2845	NSS6630DC767G	2845	NSS6630DC767M	1654
60 x 24 x 29	115	NSS6024DC767W	1850	NSS6024DC767G	1850	NSS6024DC767M	1617
54 x 24 x 29	105	NSS5424DC767W	1830	NSS5424DC767G	1830	NSS5424DC767M	1580

**2 SELECT A FINISH**

"W" Veneer	"G" HPL	"M" TFL	Finish
WAC	GAC	-	Amber Cherry
WRC	-	-	Caramel Cherry
WIC	GIC	-	Crimson Cherry
WEC	-	-	Ebony Cherry
WHC	GHC	MHC	Honey Cherry
WOC	GOC	MOC	KoKo Cherry
WSC	-	-	Scotch Cherry
WAM	GAM	-	Alabaster Maple
WCM	GCM	-	Clear Maple
WWM	GWM	-	Wheat Maple
WEW	GEW	-	Executive Walnut
WRW	GRW	-	Gray Luster Walnut
WGW	-	MGW	Gunstock Walnut
WJW	-	-	Judicial Walnut
WNW	GNW	-	Natural Walnut
WTW	GTW	MTW	Studio Teak Walnut
WWP	GWL	MWL	Designer White
<b>METAL FINISHES</b>			
MFB	-	-	Black (Premium Finish)
MFS	-	-	Silver
MFW	-	-	White (Premium Finish)

**3 SELECT AN EDGE**



**4 SELECT HARDWARE**

Hardware Option Not Available

**5 OPTIONS**

**ACCESSORIES**

- K31: Center Drawer - \$195
- K28: Articulating Keyboard w/ Mouse - \$375
- W17: Wire Mgmt. Cover for Leg - \$55

**FEET**

- D8: Delete feet (extend fronts to floor) - n/c

**GROMMETS (STANDARD LOCATION)**

- Specify Color - \$45 ea.
- Black: TM30-C (Center)
- Silver: TM31-C (Center)
- White: TM34-C (Center)

**GROMMETS (NON-STANDARD LOCATION)**

- Provide drawing w/ Grommet Location and Specify Color - \$90 ea.
- Black: TM30-NS
- Silver: TM31-NS
- White: TM34-NS

**MODESTY**

- DM: Delete half modesty - n/c
- HM45: SilverLuma frame/frost insert (half modesty) - \$395

**PREMIUM FINISH OPTION**

- MFB: Black metal finish - \$25 per foot, \$95 per base
- MFW: White metal finish - \$25 per foot, \$95 per base



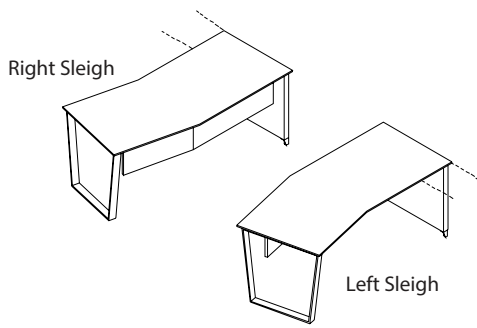

ANGULAR TOP WITH SLEIGH BASE

STANDARD FEATURES

- 2" thick end panel with metal legs
- Angled half modesty
- Standard Silver Feet and Base (optional White, Black)

[CLICK HERE TO VIEW PRODUCT INDEX](#)

1 SELECT A STYLE

DIMENSIONS		STYLE NUMBER	LIST PRICE	STYLE NUMBER	LIST PRICE	STYLE NUMBER	LIST PRICE
W" x D" x H"	WGT	"W" Veneer Veneer Top Veneer Chassis		"G" HPL High Pressure Laminate Top Veneer Chassis		"M" TFL Thermally Fused Laminate Top Thermally Fused Laminate Chassis	
<b>Left Sleigh leg</b>							
84 x 30/36 x 29	180	NSS8436DC785W	3355	NSS8436DC785G	3355	NSS8436DC785M	2297
72 x 30/36 x 29	155	NSS7236DC785W	3060	NSS7236DC785G	3060	NSS7236DC785M	2138
<b>Right Sleigh leg</b>							
84 x 30/36 x 29	180	NSS8436DC784W	3355	NSS8436DC784G	3355	NSS8436DC784M	2297
72 x 30/36 x 29	155	NSS7236DC784W	3060	NSS7236DC784G	3060	NSS7236DC784M	2138

2 SELECT A FINISH

"W" Veneer	"G" HPL	"M" TFL	Finish
WAC	GAC	-	Amber Cherry
WRC	-	-	Caramel Cherry
WIC	GIC	-	Crimson Cherry
WEC	-	-	Ebony Cherry
WHC	GHC	MHC	Honey Cherry
WOC	GOC	MOC	KoKo Cherry
WSC	-	-	Scotch Cherry
WAM	GAM	-	Alabaster Maple
WCM	GCM	-	Clear Maple
WWM	GWM	-	Wheat Maple
WEW	GEW	-	Executive Walnut
WRW	GRW	-	Gray Luster Walnut
WGW	-	MGW	Gunstock Walnut
WJW	-	-	Judicial Walnut
WNW	GNW	-	Natural Walnut
WTW	GTW	MTW	Studio Teak Walnut
WWP	GWL	MWL	Designer White
<b>METAL FINISHES</b>			
MFB	-	-	Black (Premium Finish)
MFS	-	-	Silver
MFW	-	-	White (Premium Finish)

3 SELECT AN EDGE

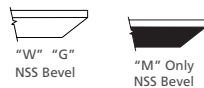

5 OPTIONS

- ACCESSORIES**
- K31: Center Drawer - \$195
  - K28: Articulating Keyboard w/ Mouse - \$375
  - W17: Wire Mgmt. Cover for Leg - \$55
- GROMMETS (STANDARD LOCATION)**  
Specify Color - \$45 ea.
- Black: TM30-C (Center)
  - Silver: TM31-C (Center)
  - White: TM34-C (Center)
- GROMMETS (NON-STANDARD LOCATION)**  
Provide drawing w/ Grommet Location and Specify Color - \$90 ea.
- Black: TM30-NS
  - Silver: TM31-NS
  - White: TM34-NS
- MODESTY**
- DM: Delete half modesty - n/c
- PREMIUM FINISH OPTION**
- MFB: Black metal finish - \$25 per foot, \$95 per base
  - MFW: White metal finish - \$25 per foot, \$95 per base

4 SELECT HARDWARE

Hardware Option Not Available

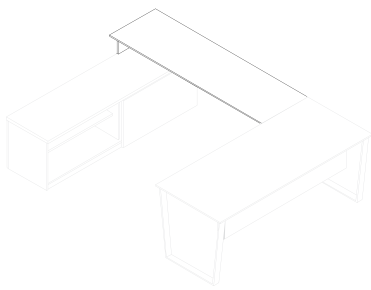

**DESK TO BENCH BRIDGE TOP**

**STANDARD FEATURES**

- Bench Support
- Hookup edge cope shaped
- Support end, flat edge

[CLICK HERE TO VIEW PRODUCT INDEX](#)

**1 SELECT A STYLE**

DIMENSIONS		STYLE NUMBER	LIST PRICE	STYLE NUMBER	LIST PRICE	STYLE NUMBER	LIST PRICE
W" x D" x H"	WGT	"W" Veneer Veneer Top Veneer Chassis		"G" HPL High Pressure Laminate Top Veneer Chassis		"M" TFL Thermally Fused Laminate Top Thermally Fused Laminate Chassis	
72 x 22 x 6	75	NSS7222BR171W	845	NSS7222BR171G	845	NSS7222BR171M	578
66 x 22 x 6	70	NSS6622BR171W	795	NSS6622BR171G	795	NSS6622BR171M	545

**2 SELECT A FINISH**

"W" Veneer	"G" HPL	"M" TFL	Finish
WAC	GAC	-	Amber Cherry
WRC	-	-	Caramel Cherry
WIC	GIC	-	Crimson Cherry
WEC	-	-	Ebony Cherry
WHC	GHC	MHC	Honey Cherry
WOC	GOC	MOC	KoKo Cherry
WSC	-	-	Scotch Cherry
WAM	GAM	-	Alabaster Maple
WCM	GCM	-	Clear Maple
WWM	GWM	-	Wheat Maple
WEW	GEW	-	Executive Walnut
WRW	GRW	-	Gray Luster Walnut
WGW	-	MGW	Gunstock Walnut
WJW	-	-	Judicial Walnut
WNW	GNW	-	Natural Walnut
WTW	GTW	MTW	Studio Teak Walnut
WWP	GWL	MWL	Designer White

**3 SELECT AN EDGE**

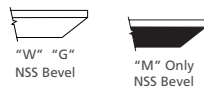

**5 OPTIONS**

- ACCESSORIES**
- K28: Articulating Keyboard w/ Mouse - \$375
- GROMMETS (STANDARD LOCATION)**
- Specify Color and Location (Right/Left/Center) - \$45 ea.
- Black: TM30-R (Right), TM30-L (Left), TM30-C (Center)
  - Silver: TM31-R (Right), TM31-L (Left), TM31-C (Center)
  - White: TM34-R (Right), TM34-L (Left), TM34-C (Center)
- GROMMETS (NON-STANDARD LOCATION)**
- Provide drawing w/ Grommet Location and Specify Color - \$90 ea.
- Black: TM30-NS
  - Silver: TM31-NS
  - White: TM34-NS

**4 SELECT HARDWARE**

Hardware Option Not Available

**RUNOFF CONFERENCE WORKSTATION DESKS**

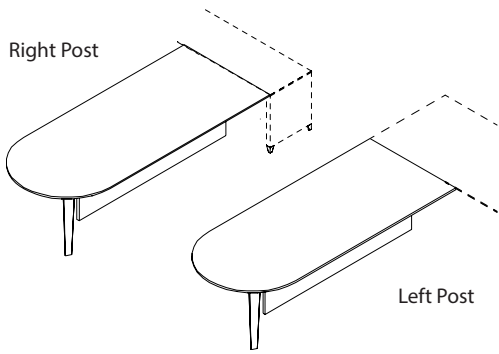

**BULLET RUNOFF DESK WITH TAPERED METAL LEG**

**STANDARD FEATURES**

- Half modesty standard
- Standard Silver Feet
- Tapered post leg silver

Credenzas, You Must: Specify Runoff Desk Bench Support.

**NOTES**

- K28 and K31 will not fit on 24" deep units w/ half modesty
- "P" Tops and Bullets are not intended to be freestanding
- When Specifying Runoff Desk w/ Bench

[CLICK HERE TO VIEW PRODUCT INDEX](#)

**1 SELECT A STYLE**

DIMENSIONS		STYLE NUMBER	LIST PRICE	STYLE NUMBER	LIST PRICE	STYLE NUMBER	LIST PRICE
W" x D" x H"	WGT	"W" Veneer Veneer Top Veneer Chassis		"G" HPL High Pressure Laminate Top Veneer Chassis		"M" TFL Thermally Fused Laminate Top Thermally Fused Laminate Chassis	
<b>Left Post</b>							
90 x 30 x 29	125	NSS9030DR745W	2620	NSS9030DR745G	2620	NSS9030DR745M	1355
84 x 30 x 29	115	NSS8430DR745W	2600	NSS8430DR745G	2600	NSS8430DR745M	1249
72 x 30 x 29	95	NSS7230DR745W	2450	NSS7230DR745G	2450	NSS7230DR745M	1163
66 x 30 x 29	85	NSS6630DR745W	2430	NSS6630DR745G	2430	NSS6630DR745M	1085
60 x 30 x 29	75	NSS6030DR745W	2410	NSS6030DR745G	2410	NSS6030DR745M	1046
54 x 24 x 29	70	NSS5424DR745W	1495	NSS5424DR745G	1495	NSS5424DR745M	992
48 x 24 x 29	60	NSS4824DR745W	1470	NSS4824DR745G	1470	NSS4824DR745M	939
<b>Right Post</b>							
90 x 30 x 29	125	NSS9030DR744W	2620	NSS9030DR744G	2620	NSS9030DR744M	1355
84 x 30 x 29	115	NSS8430DR744W	2600	NSS8430DR744G	2600	NSS8430DR744M	1249
72 x 30 x 29	95	NSS7230DR744W	2450	NSS7230DR744G	2450	NSS7230DR744M	1163
66 x 30 x 29	85	NSS6630DR744W	2430	NSS6630DR744G	2430	NSS6630DR744M	1085
60 x 30 x 29	75	NSS6030DR744W	2410	NSS6030DR744G	2410	NSS6030DR744M	1046
54 x 24 x 29	70	NSS5424DR744W	1495	NSS5424DR744G	1495	NSS5424DR744M	992
48 x 24 x 29	60	NSS4824DR744W	1470	NSS4824DR744G	1470	NSS4824DR744M	939

**2 SELECT A FINISH**

"W" Veneer	"G" HPL	"M" TFL	Finish
WAC	GAC	-	Amber Cherry
WRC	-	-	Caramel Cherry
WIC	GIC	-	Crimson Cherry
WEC	-	-	Ebony Cherry
WHC	GHC	MHC	Honey Cherry
WOC	GOC	MOC	KoKo Cherry
WSC	-	-	Scotch Cherry
WAM	GAM	-	Alabaster Maple
WCM	GCM	-	Clear Maple
WWM	GWM	-	Wheat Maple
WEW	GEW	-	Executive Walnut
WRW	GRW	-	Gray Luster Walnut
WGW	-	MGW	Gunstock Walnut
WJW	-	-	Judicial Walnut
WNW	GNW	-	Natural Walnut
WTW	GTW	MTW	Studio Teak Walnut
WWP	GWL	MWL	Designer White

**3 SELECT AN EDGE**



**5 OPTIONS**

**ACCESSORIES**

- K31: Center Drawer - \$195
- K28: Articulating Keyboard w/ Mouse - \$375

**BENCH SUPPORT**

- 23BRL30: 30" Bench Support - "W" and "G" \$195 - "M" \$125
- 23BRL24: 24" Bench Support - "W" and "G" \$155 - "M" \$110

**GROMMETS (STANDARD LOCATION)**

- Specify Color - \$45 ea.
- Black: TM30-C (Center)
- Silver: TM31-C (Center)
- White: TM34-C (Center)

**GROMMETS (NON-STANDARD LOCATION)**

- Provide drawing w/ Grommet Location and Specify Color - \$90 ea.
- Black: TM30-NS
- Silver: TM31-NS
- White: TM34-NS

**MODESTY**

- DM: Delete half modesty - n/c
- HM45: SilverLuma frame/frost insert (half modesty) - \$395

**4 SELECT HARDWARE**

Hardware Option Not Available

**RUNOFF CONFERENCE WORKSTATION DESKS**

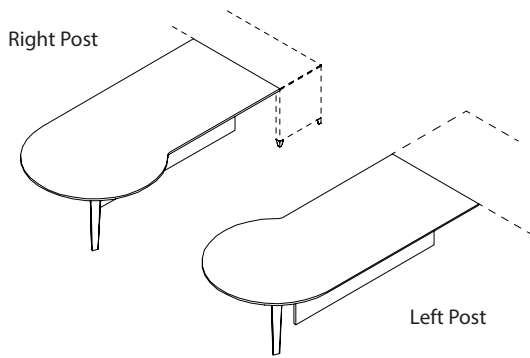

**"P" RUNOFF DESK WITH TAPERED METAL LEG**

**STANDARD FEATURES**

- Half modesty standard
- Tapered post leg silver

Bench Support.

**NOTES**

- K28 and K31 will not fit on 24" deep units w/ half modesty
- "P" Tops and Bullets are not intended to be freestanding
- When Specifying Runoff Desk w/ Bench Credenzas, You Must: Specify Runoff Desk

[CLICK HERE TO VIEW PRODUCT INDEX](#)

**1 SELECT A STYLE**

DIMENSIONS		STYLE NUMBER	LIST PRICE	STYLE NUMBER	LIST PRICE	STYLE NUMBER	LIST PRICE
W" x D" x H"	WGT	"W" Veneer Top Veneer Chassis		"G" HPL High Pressure Laminate Top Veneer Chassis		"M" TFL Thermally Fused Laminate Top Thermally Fused Laminate Chassis	
<b>Left Post</b>							
90 x 30/36 x 29	130	NSS9036DR747W	2870	NSS9036DR747G	2870	NSS9036DR747M	1459
84 x 30/36 x 29	120	NSS8436DR747W	2850	NSS8436DR747G	2850	NSS8436DR747M	1351
72 x 30/36 x 29	100	NSS7236DR747W	2540	NSS7236DR747G	2540	NSS7236DR747M	1265
66 x 30/36 x 29	90	NSS6636DR747W	2520	NSS6636DR747G	2520	NSS6636DR747M	1187
60 x 30/36 x 29	80	NSS6036DR747W	2500	NSS6036DR747G	2500	NSS6036DR747M	1150
54 x 30/36 x 29	75	NSS5436DR747W	2480	NSS5436DR747G	2480	NSS5436DR747M	1076
<b>Right Post</b>							
90 x 30/36 x 29	130	NSS9036DR746W	2870	NSS9036DR746G	2870	NSS9036DR746M	1459
84 x 30/36 x 29	120	NSS8436DR746W	2850	NSS8436DR746G	2850	NSS8436DR746M	1351
72 x 30/36 x 29	100	NSS7236DR746W	2540	NSS7236DR746G	2540	NSS7236DR746M	1265
66 x 30/36 x 29	90	NSS6636DR746W	2520	NSS6636DR746G	2520	NSS6636DR746M	1187
60 x 30/36 x 29	80	NSS6036DR746W	2500	NSS6036DR746G	2500	NSS6036DR746M	1150
54 x 30/36 x 29	75	NSS5436DR746W	2480	NSS5436DR746G	2480	NSS5436DR746M	1076

**2 SELECT A FINISH**

"W" Veneer	"G" HPL	"M" TFL	Finish
WAC	GAC	-	Amber Cherry
WRC	-	-	Caramel Cherry
WIC	GIC	-	Crimson Cherry
WEC	-	-	Ebony Cherry
WHC	GHC	MHC	Honey Cherry
WOC	GOC	MOC	KoKo Cherry
WSC	-	-	Scotch Cherry
WAM	GAM	-	Alabaster Maple
WCM	GCM	-	Clear Maple
WWM	GWM	-	Wheat Maple
WEW	GEW	-	Executive Walnut
WRW	GRW	-	Gray Luster Walnut
WGW	-	MGW	Gunstock Walnut
WJW	-	-	Judicial Walnut
WNW	GNW	-	Natural Walnut
WTW	GTW	MTW	Studio Teak Walnut
WWP	GWL	MWL	Designer White

**3 SELECT AN EDGE**

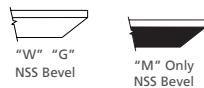

**5 OPTIONS**

**ACCESSORIES**

- K31: Center Drawer - \$195
- K28: Articulating Keyboard w/ Mouse - \$375

**BENCH SUPPORT**

- 23BRL30: 30" Bench Support - "W" and "G" \$195 - "M" \$125
- 23BRL24: 24" Bench Support - "W" and "G" \$155 - "M" \$110

**GROMMETS (STANDARD LOCATION)**

- Specify Color - \$45 ea.
- Black: TM30-C (Center)
- Silver: TM31-C (Center)
- White: TM34-C (Center)

**GROMMETS (NON-STANDARD LOCATION)**

- Provide drawing w/ Grommet Location and Specify Color - \$90 ea.
- Black: TM30-NS
- Silver: TM31-NS
- White: TM34-NS

**MODESTY**

- DM: Delete half modesty - n/c
- HM45: SilverLuma frame/frost insert (half modesty) - \$395

**4 SELECT HARDWARE**

Hardware Option Not Available

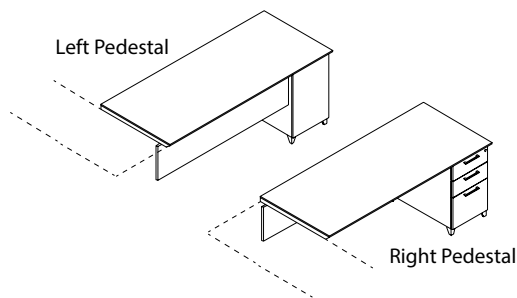

**BREAKFRONT FULL SINGLE PEDESTAL**

**STANDARD FEATURES**

- Half modesty standard
- Full extension drawers - locking
- Soft close suspension drawer(s)
- Standard Silver Feet (optional White, Black)

**NOTES**

- When Specifying Runoff Desk w/ Bench Credenzas, You Must: Specify Runoff Desk Bench Support, Verify Desk Knee space on sizes under 66"W

[CLICK HERE TO VIEW PRODUCT INDEX](#)

**1 SELECT A STYLE**

DIMENSIONS		STYLE NUMBER	LIST PRICE	STYLE NUMBER	LIST PRICE	STYLE NUMBER	LIST PRICE
W" x D" x H"	WGT	"W" Veneer Veneer Top Veneer Chassis		"G" HPL High Pressure Laminate Top Veneer Chassis		"M" TFL Thermally Fused Laminate Top Thermally Fused Laminate Chassis	
<b>Left Pedestal</b>							
90 x 30 x 29	250	NSS9030DR019W	2930	NSS9030DR019G	2930	NSS9030DR019M	1786
84 x 30 x 29	240	NSS8430DR019W	2875	NSS8430DR019G	2875	NSS8430DR019M	1707
72 x 30 x 29	220	NSS7230DR019W	2775	NSS7230DR019G	2775	NSS7230DR019M	1632
66 x 30 x 29	210	NSS6630DR019W	2745	NSS6630DR019G	2745	NSS6630DR019M	1601
60 x 30 x 29	200	NSS6030DR019W	2695	NSS6030DR019G	2695	NSS6030DR019M	1546
54 x 30 x 29	190	NSS5430DR019W	2665	NSS5430DR019G	2665	NSS5430DR019M	1489
48 x 24 x 29	170	NSS4824DR019W	2540	NSS4824DR019G	2540	NSS4824DR019M	1449
<b>Right Pedestal</b>							
90 x 30 x 29	250	NSS9030DR020W	2930	NSS9030DR020G	2930	NSS9030DR020M	1786
84 x 30 x 29	240	NSS8430DR020W	2875	NSS8430DR020G	2875	NSS8430DR020M	1707
72 x 30 x 29	220	NSS7230DR020W	2775	NSS7230DR020G	2775	NSS7230DR020M	1632
66 x 30 x 29	210	NSS6630DR020W	2745	NSS6630DR020G	2745	NSS6630DR020M	1601
60 x 30 x 29	200	NSS6030DR020W	2695	NSS6030DR020G	2695	NSS6030DR020M	1546
54 x 30 x 29	190	NSS5430DR020W	2665	NSS5430DR020G	2665	NSS5430DR020M	1489
48 x 24 x 29	170	NSS4824DR020W	2540	NSS4824DR020G	2540	NSS4824DR020M	1449

**2 SELECT A FINISH**

"W" Veneer	"G" HPL	"M" TFL	Finish
WAC	GAC	-	Amber Cherry
WRC	-	-	Caramel Cherry
WIC	GIC	-	Crimson Cherry
WEC	-	-	Ebony Cherry
WHC	GHC	MHC	Honey Cherry
WOC	GOC	MOC	KoKo Cherry
WSC	-	-	Scotch Cherry
WAM	GAM	-	Alabaster Maple
WCM	GCM	-	Clear Maple
WWM	GWM	-	Wheat Maple
WEW	GEW	-	Executive Walnut
WRW	GRW	-	Gray Luster Walnut
WGW	-	MGW	Gunstock Walnut
WJW	-	-	Judicial Walnut
WNW	GNW	-	Natural Walnut
WTW	GTW	MTW	Studio Teak Walnut
WWP	GWL	MWL	Designer White
<b>METAL FINISHES</b>			
MFB	-	-	Black (Premium Finish)
MFS	-	-	Silver
MFW	-	-	White (Premium Finish)

**3 SELECT AN EDGE**

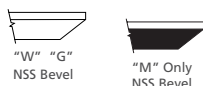

**4 SELECT HARDWARE**

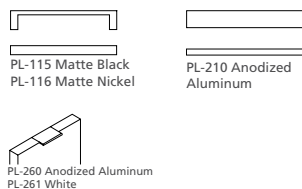

**5 OPTIONS**

- ACCESSORIES**
- K28: Articulating Keyboard w/ Mouse - \$375
  - K31: Center Drawer - \$195
- BENCH SUPPORT**
- 23BRL30: 30" Bench Support - "W" and "G" \$195 - "M" \$125
  - 23BRL24: 24" Bench Support - "W" and "G" \$155 - "M" \$110
- DRAWER**
- P6: Modify Box/Box/File to File/File - \$50 per pedestal
  - P33: Wood Drawer Upgrade - \$40 per drawer
  - WPD3061: Full fill designer white - \$75 per pedestal
- FEET**
- D8: Delete feet (extend fronts to floor) - n/c
- GROMMETS (STANDARD LOCATION)**
- Specify Color and Location Right/Left - \$45 ea.
- Black: TM30-R (Right), TM30-L (Left)
  - Silver: TM31-R (Right), TM31-L (Left)
  - White: TM34-R (Right), TM34-L (Left)
- GROMMETS (NON-STANDARD LOCATION)**
- Provide drawing w/ Grommet Location and Specify Color - \$90 ea.
- Black: TM30-NS
  - Silver: TM31-NS
  - White: TM34-NS
- MODESTY**
- DM: Delete Half Modesty - n/c
  - HM39: SilverLuma frame/frost (Half Modesty) - \$325
- PREMIUM FINISH OPTION**
- MFB: Black metal finish - \$25 per foot
  - MFW: White metal finish - \$25 per foot

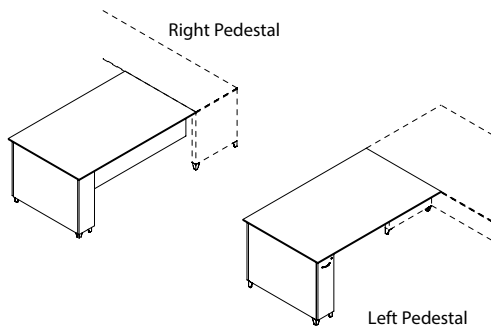

**RUNOFF ORGANIZER DESK**

**STANDARD FEATURES**

- 6" recessed modesty
- Half modesty standard
- Standard Silver Feet (optional White, Black)

- When Specifying Runoff Desk w/ Bench Credenzas, You Must: Specify Runoff Desk Bench Support

**NOTES**

- K28 and K31 will not fit on 24" deep units w/ half modesty
- Organizer Pedestal Detail: 8"W Pullout cabinet drawer features: Pencil tray, CD tray, hanging folder rack, utility tray & shelves. Non locking.

[CLICK HERE TO VIEW PRODUCT INDEX](#)

**1 SELECT A STYLE**

DIMENSIONS		STYLE NUMBER	LIST PRICE	STYLE NUMBER	LIST PRICE	STYLE NUMBER	LIST PRICE
W" x D" x H"	WGT	"W" Veneer Top Veneer Chassis		"G" High Pressure Laminate Top Veneer Chassis		"M" Thermally Fused Laminate Top Thermally Fused Laminate Chassis	
<b>Left Pedestal</b>							
90 x 30 x 29	195	NSS9030DR708W	3250	NSS9030DR708G	3250	NSS9030DR708M	1977
84 x 30 x 29	180	NSS8430DR708W	3195	NSS8430DR708G	3195	NSS8430DR708M	1892
72 x 30 x 29	160	NSS7230DR708W	3090	NSS7230DR708G	3090	NSS7230DR708M	1818
66 x 30 x 29	150	NSS6630DR708W	3065	NSS6630DR708G	3065	NSS6630DR708M	1772
60 x 30 x 29	140	NSS6030DR708W	3015	NSS6030DR708G	3015	NSS6030DR708M	1715
54 x 30 x 29	130	NSS5430DR708W	2985	NSS5430DR708G	2985	NSS5430DR708M	1660
48 x 24 x 29	110	NSS4824DR708W	2045	NSS4824DR708G	2045	NSS4824DR708M	1537
<b>Right Pedestal</b>							
90 x 30 x 29	195	NSS9030DR707W	3250	NSS9030DR707G	3250	NSS9030DR707M	1977
84 x 30 x 29	180	NSS8430DR707W	3195	NSS8430DR707G	3195	NSS8430DR707M	1892
72 x 30 x 29	160	NSS7230DR707W	3090	NSS7230DR707G	3090	NSS7230DR707M	1818
66 x 30 x 29	150	NSS6630DR707W	3065	NSS6630DR707G	3065	NSS6630DR707M	1772
60 x 30 x 29	140	NSS6030DR707W	3015	NSS6030DR707G	3015	NSS6030DR707M	1715
54 x 30 x 29	130	NSS5430DR707W	2985	NSS5430DR707G	2985	NSS5430DR707M	1660
48 x 24 x 29	110	NSS4824DR707W	2045	NSS4824DR707G	2045	NSS4824DR707M	1537

**2 SELECT A FINISH**

"W" Veneer	"G" HPL	"M" TFL	Finish
WAC	GAC	-	Amber Cherry
WRC	-	-	Caramel Cherry
WIC	GIC	-	Crimson Cherry
WEC	-	-	Ebony Cherry
WHC	GHC	MHC	Honey Cherry
WOC	GOC	MOC	KoKo Cherry
WSC	-	-	Scotch Cherry
WAM	GAM	-	Alabaster Maple
WCM	GCM	-	Clear Maple
WWM	GWM	-	Wheat Maple
WEW	GEW	-	Executive Walnut
WRW	GRW	-	Gray Luster Walnut
WGW	-	MGW	Gunstock Walnut
WJW	-	-	Judicial Walnut
WNW	GNW	-	Natural Walnut
WTW	GTW	MTW	Studio Teak Walnut
WWP	GWL	MWL	Designer White

**METAL FINISHES**

MFB	-	-	Black (Premium Finish)
MFS	-	-	Silver
MFW	-	-	White (Premium Finish)

**3 SELECT AN EDGE**

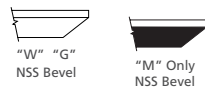

**5 OPTIONS**

**ACCESSORIES**

- K28: Articulating Keyboard w/ Mouse - \$375
- K31: Center Drawer - \$195

**BENCH SUPPORT**

- 23BRL30: 30" Bench Support - "W" and "G" \$195 - "M" \$125
- 23BRL24: 24" Bench Support - "W" and "G" \$155 - "M" \$110

**FEET**

- D8: Delete feet (extend fronts to floor) - n/c

**GROMMETS (STANDARD LOCATION)**

- Specify Color and Location Right/Left - \$45 ea.
- Black: TM30-R (Right), TM30-L (Left)
- Silver: TM31-R (Right), TM31-L (Left)
- White: TM34-R (Right), TM34-L (Left)

**GROMMETS (NON-STANDARD LOCATION)**

- Provide drawing w/ Grommet Location and Specify Color - \$90 ea.
- Black: TM30-NS
- Silver: TM31-NS
- White: TM34-NS

**MODESTY**

- DM: Delete Half Modesty - n/c
- HM39: SilverLuma frame/frost (Half Modesty) - \$325

**PREMIUM FINISH OPTION**

- MFB: Black metal finish - \$25 per foot
- MFW: White metal finish - \$25 per foot

**4 SELECT HARDWARE**

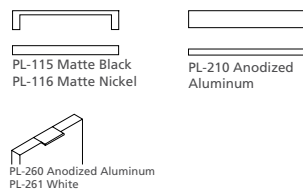

Left Sleigh Leg

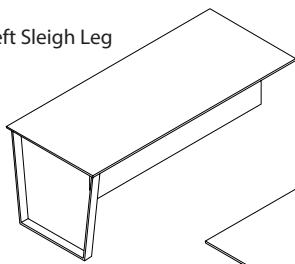

Right Sleigh Leg

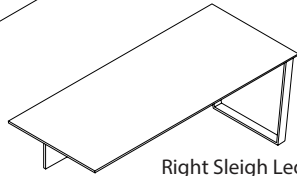

RECTANGLE RUNOFF DESK WITH SLEIGH BASE

STANDARD FEATURES

- Half modesty standard
- Standard Silver Base (optional White, Black)

NOTES

- When Specifying Runoff Desk w/ Bench Credenzas, You Must: Specify Runoff Desk Bench Support.
- K28 and K31 will not fit on 24" deep units w/ half modesty

[CLICK HERE TO VIEW PRODUCT INDEX](#)

1 SELECT A STYLE

DIMENSIONS		STYLE NUMBER	LIST PRICE	STYLE NUMBER	LIST PRICE	STYLE NUMBER	LIST PRICE
W" x D" x H"	WGT	"W" Veneer Veneer Top Veneer Chassis		"G" HPL High Pressure Laminate Top Veneer Chassis		"M" TFL Thermally Fused Laminate Top Thermally Fused Laminate Chassis	
<b>Right Sleigh Leg</b>							
90 x 30 x 29	125	NSS9030DR770W	2755	NSS9030DR770G	2755	NSS9030DR770M	1488
84 x 30 x 29	115	NSS8430DR770W	2740	NSS8430DR770G	2740	NSS8430DR770M	1371
72 x 30 x 29	95	NSS7230DR770W	2580	NSS7230DR770G	2580	NSS7230DR770M	1277
66 x 30 x 29	85	NSS6630DR770W	2560	NSS6630DR770G	2560	NSS6630DR770M	1191
60 x 30 x 29	75	NSS6030DR770W	2540	NSS6030DR770G	2540	NSS6030DR770M	1151
54 x 24 x 29	70	NSS5424DR770W	1630	NSS5424DR770G	1630	NSS5424DR770M	1091
48 x 24 x 29	60	NSS4824DR770W	1600	NSS4824DR770G	1600	NSS4824DR770M	1034
<b>Left Sleigh Leg</b>							
90 x 30 x 29	125	NSS9030DR771W	2755	NSS9030DR771G	2755	NSS9030DR771M	1488
84 x 30 x 29	115	NSS8430DR771W	2740	NSS8430DR771G	2740	NSS8430DR771M	1371
72 x 30 x 29	95	NSS7230DR771W	2580	NSS7230DR771G	2580	NSS7230DR771M	1277
66 x 30 x 29	85	NSS6630DR771W	2560	NSS6630DR771G	2560	NSS6630DR771M	1191
60 x 30 x 29	75	NSS6030DR771W	2540	NSS6030DR771G	2540	NSS6030DR771M	1151
54 x 24 x 29	70	NSS5424DR771W	1630	NSS5424DR771G	1630	NSS5424DR771M	1091
48 x 24 x 29	60	NSS4824DR771W	1600	NSS4824DR771G	1600	NSS4824DR771M	1034

2 SELECT A FINISH

"W" Veneer	"G" HPL	"M" TFL	Finish
WAC	GAC	-	Amber Cherry
WRC	-	-	Caramel Cherry
WIC	GIC	-	Crimson Cherry
WEC	-	-	Ebony Cherry
WHC	GHC	MHC	Honey Cherry
WOC	GOC	MOC	KoKo Cherry
WSC	-	-	Scotch Cherry
WAM	GAM	-	Alabaster Maple
WCM	GCM	-	Clear Maple
WWM	GWM	-	Wheat Maple
WEW	GEW	-	Executive Walnut
WRW	GRW	-	Gray Luster Walnut
WGW	-	MGW	Gunstock Walnut
WJW	-	-	Judicial Walnut
WNW	GNW	-	Natural Walnut
WTW	GTW	MTW	Studio Teak Walnut
WWP	GWL	MWL	Designer White
<b>METAL FINISHES</b>			
MFB	-	-	Black (Premium Finish)
MFS	-	-	Silver
MFW	-	-	White (Premium Finish)

3 SELECT AN EDGE

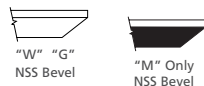

5 OPTIONS

- ACCESSORIES**
- K28: Articulating Keyboard w/ Mouse - \$375
  - K31: Center Drawer - \$195
  - W17: Wire Mgmt. Cover for Leg - \$55
- BENCH SUPPORT**
- 23BRL30: 30" Bench Support - "W" and "G" \$195 - "M" \$125
  - 23BRL24: 24" Bench Support - "W" and "G" \$155 - "M" \$110
- GROMMETS (STANDARD LOCATION)**
- Specify Color - \$45 ea.
- Black: TM30-C (Center)
  - Silver: TM31-C (Center)
  - White: TM34-C (Center)
- GROMMETS (NON-STANDARD LOCATION)**
- Provide drawing w/ Grommet Location and Specify Color - \$90 ea.
- Black: TM30-NS
  - Silver: TM31-NS
  - White: TM34-NS
- MODESTY**
- DM: Delete Half Modesty - n/c
  - HM45: SilverLuma frame/frost insert (half modesty) - \$395
- PREMIUM FINISH OPTION**
- MFB: Black metal finish - \$95 per base
  - MFW: White metal finish - \$95 per base

4 SELECT HARDWARE

Hardware Option Not Available

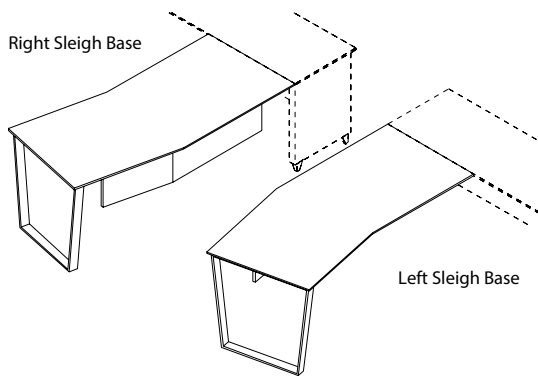

ANGULAR RUNOFF DESK WITH SLEIGH BASE

STANDARD FEATURES

- Angled half modesty standard
- Silver sleigh base standard (optional White, Black)

NOTES

- When Specifying Runoff Desk w/ Bench Credenzas, You Must: Specify Runoff Desk Bench Support.

[CLICK HERE TO VIEW PRODUCT INDEX](#)

1 SELECT A STYLE

DIMENSIONS		STYLE NUMBER	LIST PRICE	STYLE NUMBER	LIST PRICE	STYLE NUMBER	LIST PRICE
W" x D" x H"	WGT	"W" Veneer Veneer Top Veneer Chassis		"G" HPL High Pressure Laminate Top Veneer Chassis		"M" TFL Thermally Fused Laminate Top Thermally Fused Laminate Chassis	
<b>Right Sleigh Leg</b>							
90 x 30/36 x 29	130	NSS9036DR776W	3005	NSS9036DR776G	3005	NSS9036DR776M	1766
84 x 30/36 x 29	120	NSS8436DR776W	2990	NSS8436DR776G	2990	NSS8436DR776M	1648
72 x 30/36 x 29	100	NSS7236DR776W	2670	NSS7236DR776G	2670	NSS7236DR776M	1553
66 x 30/36 x 29	90	NSS6636DR776W	2650	NSS6636DR776G	2650	NSS6636DR776M	1470
60 x 30/36 x 29	80	NSS6036DR776W	2630	NSS6036DR776G	2630	NSS6036DR776M	1427
54 x 30/36 x 29	75	NSS5436DR776W	2610	NSS5436DR776G	2610	NSS5436DR776M	1348
<b>Left Sleigh Leg</b>							
90 x 30/36 x 29	130	NSS9036DR777W	3005	NSS9036DR777G	3005	NSS9036DR777M	1766
84 x 30/36 x 29	120	NSS8436DR777W	2990	NSS8436DR777G	2990	NSS8436DR777M	1648
72 x 30/36 x 29	100	NSS7236DR777W	2670	NSS7236DR777G	2670	NSS7236DR777M	1553
66 x 30/36 x 29	90	NSS6636DR777W	2650	NSS6636DR777G	2650	NSS6636DR777M	1470
60 x 30/36 x 29	80	NSS6036DR777W	2630	NSS6036DR777G	2630	NSS6036DR777M	1427
54 x 30/36 x 29	75	NSS5436DR777W	2610	NSS5436DR777G	2610	NSS5436DR777M	1357

2 SELECT A FINISH

"W" Veneer	"G" HPL	"M" TFL	Finish
WAC	GAC	-	Amber Cherry
WRC	-	-	Caramel Cherry
WIC	GIC	-	Crimson Cherry
WEC	-	-	Ebony Cherry
WHC	GHC	MHC	Honey Cherry
WOC	GOC	MOC	KoKo Cherry
WSC	-	-	Scotch Cherry
WAM	GAM	-	Alabaster Maple
WCM	GCM	-	Clear Maple
WWM	GWM	-	Wheat Maple
WEW	GEW	-	Executive Walnut
WRW	GRW	-	Gray Luster Walnut
WGW	-	MGW	Gunstock Walnut
WJW	-	-	Judicial Walnut
WNW	GNW	-	Natural Walnut
WTW	GTW	MTW	Studio Teak Walnut
WWP	GWL	MWL	Designer White
<b>METAL FINISHES</b>			
MFB	-	-	Black (Premium Finish)
MFS	-	-	Silver
MFW	-	-	White (Premium Finish)

3 SELECT AN EDGE



5 OPTIONS

- ACCESSORIES**
- K28: Articulating Keyboard w/ Mouse - \$375
  - K31: Center Drawer - \$195
  - W17: Wire Mgmt. Cover for Leg - \$55
- BENCH SUPPORT**
- 23BRL30: 30" Bench Support - "W" and "G" \$195 - "M" \$125
  - 23BRL24: 24" Bench Support - "W" and "G" \$155 - "M" \$110
- GROMMETS (STANDARD LOCATION)**
- Specify Color - \$45 ea.
- Black: TM30-C (Center)
  - Silver: TM31-C (Center)
  - White: TM34-C (Center)
- GROMMETS (NON-STANDARD LOCATION)**
- Provide drawing w/ Grommet Location and Specify Color - \$90 ea.
- Black: TM30-NS
  - Silver: TM31-NS
  - White: TM34-NS
- MODESTY**
- DM: Delete half modesty - n/c
- PREMIUM FINISH OPTION**
- MFB: Black metal finish - \$95 per base
  - MFW: White metal finish - \$95 per base

4 SELECT HARDWARE

Hardware Option Not Available



Left Pedestal

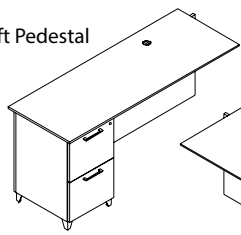

Right Pedestal

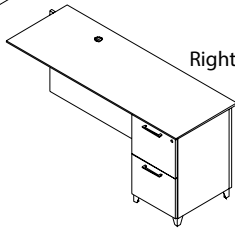

**FILE/FILE**

**STANDARD FEATURES**

- All drawers lock
- Standard full fixed modesty panel
- Standard metal grommet matches pull finish
- Standard silver feet (optional White, Black)
- Soft close suspension drawer(s)

- automatically have wire channel and outfeed holes in back.
- Unit not designed for open plan use. Select OPB for Open Plan application
- Left pedestal gets right grommet
- Right pedestal gets left grommet

**NOTES**

- Laminate version "M" standard w/ open plan back
- Returns with Grommets in top will

[CLICK HERE TO VIEW PRODUCT INDEX](#)

**1 SELECT A STYLE**

DIMENSIONS		STYLE NUMBER	LIST PRICE	STYLE NUMBER	LIST PRICE	STYLE NUMBER	LIST PRICE
W" x D" x H"	WGT	"W" Veneer Veneer Top Veneer Chassis		"G" HPL High Pressure Laminate Top Veneer Chassis		"M" TFL Thermally Fused Laminate Top Thermally Fused Laminate Chassis	
<b>Left Pedestal</b>							
60 x 22 x 29	160	NSS6022RE195W	2565	NSS6022RE195G	2565	NSS6022RE195M	1399
54 x 22 x 29	145	NSS5422RE195W	2550	NSS5422RE195G	2550	NSS5422RE195M	1332
48 x 22 x 29	135	NSS4822RE195W	2455	NSS4822RE195G	2455	NSS4822RE195M	1280
42 x 22 x 29	125	NSS4222RE195W	2420	NSS4222RE195G	2420	NSS4222RE195M	1247
<b>Right Pedestal</b>							
60 x 22 x 29	160	NSS6022RE196W	2565	NSS6022RE196G	2565	NSS6022RE196M	1399
54 x 22 x 29	145	NSS5422RE196W	2550	NSS5422RE196G	2550	NSS5422RE196M	1332
48 x 22 x 29	135	NSS4822RE196W	2455	NSS4822RE196G	2455	NSS4822RE196M	1280
42 x 22 x 29	125	NSS4222RE196W	2420	NSS4222RE196G	2420	NSS4222RE196M	1247

**2 SELECT A FINISH**

"W" Veneer	"G" HPL	"M" TFL	
WAC	GAC	-	Amber Cherry
WRC	-	-	Caramel Cherry
WIC	GIC	-	Crimson Cherry
WEC	-	-	Ebony Cherry
WHC	GHC	MHC	Honey Cherry
WOC	GOC	MOC	KoKo Cherry
WSC	-	-	Scotch Cherry
WAM	GAM	-	Alabaster Maple
WCM	GCM	-	Clear Maple
WWM	GWM	-	Wheat Maple
WEW	GEW	-	Executive Walnut
WRW	GRW	-	Gray Luster Walnut
WGW	-	MGW	Gunstock Walnut
WJW	-	-	Judicial Walnut
WNW	GNW	-	Natural Walnut
WTW	GTW	MTW	Studio Teak Walnut
WWP	GWL	MWL	Designer White
<b>METAL FINISHES</b>			
MFB	-	-	Black (Premium Finish)
MFS	-	-	Silver
MFW	-	-	White (Premium Finish)

**3 SELECT AN EDGE**

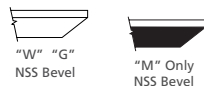

**5 OPTIONS**

- ACCESSORIES**
- K28: Articulating Keyboard w/ Mouse - \$375
- DRAWER**
- P6: Modify File/File to Box/Box/File - \$50 per pedestal
  - P33: Wood Drawer Upgrade - \$40 per drawer
  - P40W: extra Box/Box/File or File/File to Knee space - \$875
  - P40M: extra Box/Box/File or File/File to Knee space - \$688
  - WPD3061: Full fill designer white - \$75 per pedestal
- FEET**
- D8: Delete feet (extend fronts to floor) - n/c
- FLUSH CUT**
- FC-L: Flush Unit Left (Facing) for Ganging - \$50
  - FC-R: Flush Unit Right(Facing) for Ganging - \$50
- GROMMETS (NON-STANDARD LOCATION)**
- Provide drawing w/ Grommet Location and Specify Color - \$90 ea.
- Black: TM30-NS
  - Silver: TM31-NS
  - White: TM34-NS
- MODESTY**
- M34T: "W" "G" Style Drop Door Tech Modesty - \$125
  - M34TM: "M" Style Drop Door Tech Modesty - \$125
  - M51: Open Back Modesty with Wire Mgmt Rail - Deduct \$95
- PREMIUM FINISH OPTION**
- MFB: Black metal finish - \$25 per foot
  - MFW: White metal finish - \$25 per foot

**4 SELECT HARDWARE**

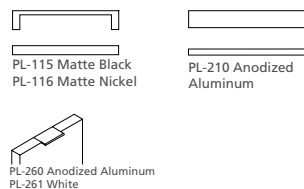

Left Pedestal

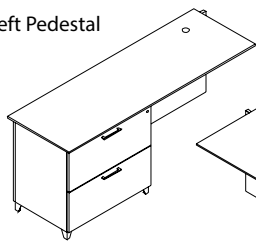

Right Pedestal

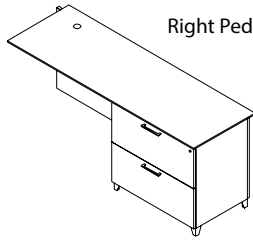

**LATERAL FILE**

**STANDARD FEATURES**

- Full modesty panel
- Full extension drawers - locking
- Standard metal grommet matches pull finish
- Soft close suspension drawer(s)
- Standard Silver Feet (optional White, Black)

holes in back.

- Laminate version "M" standard w/ open plan back
- Unit not designed for open plan use. Select OPB for Open Plan application
- Left pedestal gets right grommet
- Right pedestal gets left grommet

**NOTES**

- Keyboard not available on noted 48" /54" units. Returns with Grommets in top will automatically have wire channel and outfeed

[CLICK HERE TO VIEW PRODUCT INDEX](#)

**1 SELECT A STYLE**

DIMENSIONS		STYLE NUMBER	LIST PRICE	STYLE NUMBER	LIST PRICE	STYLE NUMBER	LIST PRICE
W" x D" x H"	WGT	"W" Veneer Veneer Top Veneer Chassis		"G" HPL High Pressure Laminate Top Veneer Chassis		"M" TFL Thermally Fused Laminate Top Thermally Fused Laminate Chassis	
<b>Left Pedestal</b>							
72 x 22 x 29	200	NSS7222RE187W	2725	NSS7222RE187G	2725	NSS7222RE187M	1634
66 x 22 x 29	190	NSS6622RE187W	2700	NSS6622RE187G	2700	NSS6622RE187M	1569
60 x 22 x 29	180	NSS6022RE187W	2660	NSS6022RE187G	2660	NSS6022RE187M	1504
54 x 22 x 29	170	NSS5422RE187W	2635	NSS5422RE187G	2635	NSS5422RE187M	1444
<b>Right Pedestal</b>							
72 x 22 x 29	200	NSS7222RE188W	2725	NSS7222RE188G	2725	NSS7222RE188M	1634
66 x 22 x 29	190	NSS6622RE188W	2700	NSS6622RE188G	2700	NSS6622RE188M	1569
60 x 22 x 29	180	NSS6022RE188W	2660	NSS6022RE188G	2660	NSS6022RE188M	1504
54 x 22 x 29	170	NSS5422RE188W	2635	NSS5422RE188G	2635	NSS5422RE188M	1444
48 x 22 x 29	165	NSS4822RE188W	2570	NSS4822RE188G	2570	NSS4822RE188M	1398

**2 SELECT A FINISH**

"W" Veneer	"G" HPL	"M" TFL	Finish
WAC	GAC	-	Amber Cherry
WRC	-	-	Caramel Cherry
WIC	GIC	-	Crimson Cherry
WEC	-	-	Ebony Cherry
WHC	GHC	MHC	Honey Cherry
WOC	GOC	MOC	KoKo Cherry
WSC	-	-	Scotch Cherry
WAM	GAM	-	Alabaster Maple
WCM	GCM	-	Clear Maple
WWM	GWM	-	Wheat Maple
WEW	GEW	-	Executive Walnut
WRW	GRW	-	Gray Luster Walnut
WGW	-	MGW	Gunstock Walnut
WJW	-	-	Judicial Walnut
WNW	GNW	-	Natural Walnut
WTW	GTW	MTW	Studio Teak Walnut
WWP	GWL	MWL	Designer White
<b>METAL FINISHES</b>			
MFB	-	-	Black (Premium Finish)
MFS	-	-	Silver
MFW	-	-	White (Premium Finish)

**3 SELECT AN EDGE**

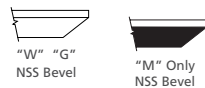

**5 OPTIONS**

- ACCESSORIES**
- K28: Articulating Keyboard w/ Mouse - \$375
- DRAWER**
- P33: Wood Drawer Upgrade - \$40 per drawer
  - P40W: extra Box/Box/File or File/File to Knee space - \$875
  - P40M: extra Box/Box/File or File/File to Knee space - \$688
  - WPD3061: Full fill designer white - \$75 per pedestal
- FEET**
- D8: Delete feet (extend fronts to floor) - n/c
- FLUSH CUT**
- FC-L: Flush Unit Left (Facing) for Ganging - \$50
  - FC-R: Flush Unit Right(Facing) for Ganging - \$50
- GROMMETS (NON-STANDARD LOCATION)**
- Provide drawing w/ Grommet Location and Specify Color - \$90 ea.
- Black: TM30-NS
  - Silver: TM31-NS
  - White: TM34-NS
- MODESTY**
- M34T: "W" "G" Style Drop Door Tech Modesty - \$125
  - M34TM: "M" Style Drop Door Tech Modesty - \$125
  - M51: Open Back Modesty with Wire Mgmt Rail - Deduct \$95
- PREMIUM FINISH OPTION**
- MFB: Black metal finish - \$25 per foot
  - MFW: White metal finish - \$25 per foot

**4 SELECT HARDWARE**

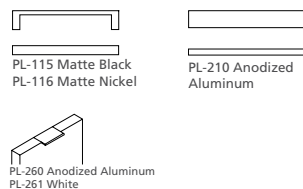

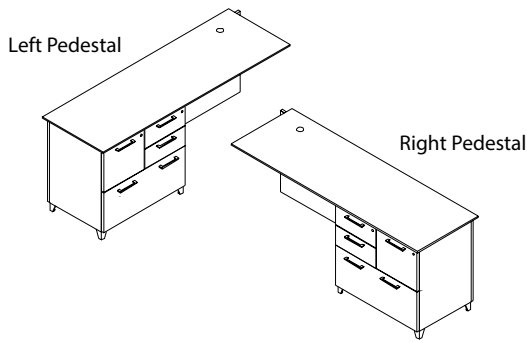

**MULTI-FILE**

**STANDARD FEATURES**

- Full modesty panel
- Full extension drawers - locking
- Pedestal is 31" W
- Soft close suspension drawer(s)
- Standard metal grommet matches pull finish
- Standard Silver Feet (optional White, Black)

- automatically have wire channel and outfeed holes in back.
- Laminate version "M" standard w/ open plan back
- Unit not designed for open plan use. Select OPB for Open Plan application
- Left pedestal gets right grommet
- Right pedestal gets left grommet

**NOTES**

- Keyboard not available on noted 48" /54" units. Returns with Grommets in top will

[CLICK HERE TO VIEW PRODUCT INDEX](#)

**1 SELECT A STYLE**

DIMENSIONS		STYLE NUMBER	LIST PRICE	STYLE NUMBER	LIST PRICE	STYLE NUMBER	LIST PRICE
W" x D" x H"	WGT	"W" Veneer Veneer Top Veneer Chassis		"G" HPL High Pressure Laminate Top Veneer Chassis		"M" TFL Thermally Fused Laminate Top Thermally Fused Laminate Chassis	
<b>Left Pedestal</b>							
72 x 22 x 29	200	NSS7222RE218W	2800	NSS7222RE218G	2800	NSS7222RE218M	1727
66 x 22 x 29	190	NSS6622RE218W	2775	NSS6622RE218G	2775	NSS6622RE218M	1662
60 x 22 x 29	180	NSS6022RE218W	2735	NSS6022RE218G	2735	NSS6022RE218M	1597
54 x 22 x 29	170	NSS5422RE218W	2710	NSS5422RE218G	2710	NSS5422RE218M	1538
48 x 22 x 29	165	NSS4822RE218W	2645	NSS4822RE218G	2645	NSS4822RE218M	1491
<b>Right Pedestal</b>							
72 x 22 x 29	200	NSS7222RE219W	2800	NSS7222RE219G	2800	NSS7222RE219M	1727
66 x 22 x 29	190	NSS6622RE219W	2775	NSS6622RE219G	2775	NSS6622RE219M	1662
60 x 22 x 29	180	NSS6022RE219W	2735	NSS6022RE219G	2735	NSS6022RE219M	1597
54 x 22 x 29	170	NSS5422RE219W	2710	NSS5422RE219G	2710	NSS5422RE219M	1538
48 x 22 x 29	165	NSS4822RE219W	2645	NSS4822RE219G	2645	NSS4822RE219M	1491

**2 SELECT A FINISH**

"W" Veneer	"G" HPL	"M" TFL	Finish
WAC	GAC	-	Amber Cherry
WRC	-	-	Caramel Cherry
WIC	GIC	-	Crimson Cherry
WEC	-	-	Ebony Cherry
WHC	GHC	MHC	Honey Cherry
WOC	GOC	MOC	KoKo Cherry
WSC	-	-	Scotch Cherry
WAM	GAM	-	Alabaster Maple
WCM	GCM	-	Clear Maple
WWM	GWM	-	Wheat Maple
WEW	GEW	-	Executive Walnut
WRW	GRW	-	Gray Luster Walnut
WGW	-	MGW	Gunstock Walnut
WJW	-	-	Judicial Walnut
WNW	GNW	-	Natural Walnut
WTW	GTW	MTW	Studio Teak Walnut
WWP	GWL	MWL	Designer White
<b>METAL FINISHES</b>			
MFB	-	-	Black (Premium Finish)
MFS	-	-	Silver
MFW	-	-	White (Premium Finish)

**3 SELECT AN EDGE**

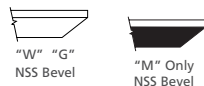

**5 OPTIONS**

- ACCESSORIES**
- K28: Articulating Keyboard w/ Mouse - \$375
- DRAWER**
- P33: Wood Drawer Upgrade - \$40 per drawer
  - P40W: extra Box/Box/File or File/File to Knee space - \$875
  - P40M: extra Box/Box/File or File/File to Knee space - \$688
  - WPD3061: Full fill designer white - \$75 per pedestal
- FEET**
- D8: Delete feet (extend fronts to floor) - n/c
- FLUSH CUT**
- FC-B: Flush Unit Both Sides(Facing) for Ganging - \$50
  - FC-L: Flush Unit Left (Facing) for Ganging - \$50
  - FC-R: Flush Unit Right(Facing) for Ganging - \$50
- GROMMETS (NON-STANDARD LOCATION)**
- Provide drawing w/ Grommet Location and Specify Color - \$90 ea.
- Black: TM30-NS
  - Silver: TM31-NS
  - White: TM34-NS
- MODESTY**
- M34T: "W" "G" Style Drop Door Tech Modesty - \$125
  - M34TM: "M" Style Drop Door Tech Modesty - \$125
  - M51: Open Back Modesty with Wire Mgmt Rail - Deduct \$95
- PREMIUM FINISH OPTION**
- MFB: Black metal finish - \$25 per foot
  - MFW: White metal finish - \$25 per foot

**4 SELECT HARDWARE**

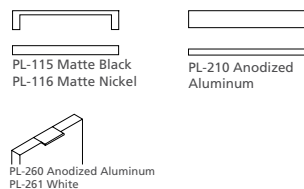

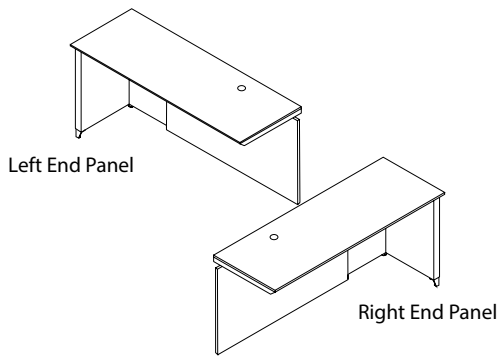

**RETURN SHELL**

**STANDARD FEATURES**

- 2" thick end panel with metal legs
- Full fixed modesty
- Standard full fixed modesty panel
- Standard metal grommet (As shown)
- Standard silver feet (optional White, Black)

- Unit not designed for open plan use. Select OPB for Open Plan application

**NOTES**

- Returns with Grommets in top will automatically have wire channel and outfeed holes in back.

[CLICK HERE TO VIEW PRODUCT INDEX](#)

**1 SELECT A STYLE**

DIMENSIONS		STYLE NUMBER	LIST PRICE	STYLE NUMBER	LIST PRICE	STYLE NUMBER	LIST PRICE
W" x D" x H"	WGT	"W" Veneer Veneer Top Veneer Chassis		"G" HPL High Pressure Laminate Top Veneer Chassis		"M" TFL Thermally Fused Laminate Top Thermally Fused Laminate Chassis	
<b>Left Panel</b>							
60 x 22 x 29	105	NSS6022RE216W	1590	NSS6022RE216G	1590	NSS6022RE216M	1049
54 x 22 x 29	100	NSS5422RE216W	1565	NSS5422RE216G	1565	NSS5422RE216M	992
48 x 22 x 29	95	NSS4822RE216W	1495	NSS4822RE216G	1495	NSS4822RE216M	943
42 x 22 x 29	90	NSS4222RE216W	1470	NSS4222RE216G	1470	NSS4222RE216M	915
<b>Right Panel</b>							
60 x 22 x 29	105	NSS6022RE217W	1590	NSS6022RE217G	1590	NSS6022RE217M	1049
54 x 22 x 29	100	NSS5422RE217W	1565	NSS5422RE217G	1565	NSS5422RE217M	992
48 x 22 x 29	95	NSS4822RE217W	1495	NSS4822RE217G	1495	NSS4822RE217M	943
42 x 22 x 29	90	NSS4222RE217W	1470	NSS4222RE217G	1470	NSS4222RE217M	915

**2 SELECT A FINISH**

"W" Veneer	"G" HPL	"M" TFL	Finish
WAC	GAC	-	Amber Cherry
WRC	-	-	Caramel Cherry
WIC	GIC	-	Crimson Cherry
WEC	-	-	Ebony Cherry
WHC	GHC	MHC	Honey Cherry
WOC	GOC	MOC	KoKo Cherry
WSC	-	-	Scotch Cherry
WAM	GAM	-	Alabaster Maple
WCM	GCM	-	Clear Maple
WWM	GWM	-	Wheat Maple
WEW	GEW	-	Executive Walnut
WRW	GRW	-	Gray Luster Walnut
WGW	-	MGW	Gunstock Walnut
WJW	-	-	Judicial Walnut
WNW	GNW	-	Natural Walnut
WTW	GTW	MTW	Studio Teak Walnut
WWP	GWL	MWL	Designer White

METAL FINISHES

MFB	-	-	Black (Premium Finish)
MFS	-	-	Silver
MFW	-	-	White (Premium Finish)

**3 SELECT AN EDGE**

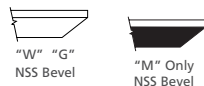

**5 OPTIONS**

- ACCESSORIES**
- K28: Articulating Keyboard w/ Mouse - \$375
- FEET**
- D8: Delete feet (extend fronts to floor) - n/c
- FLUSH CUT**
- FC-L: Flush Unit Left (Facing) for Ganging - \$50
  - FC-R: Flush Unit Right(Facing) for Ganging - \$50
- GROMMETS (NON-STANDARD LOCATION)**
- Provide drawing w/ Grommet Location and Specify Color - \$90 ea.
- Black: TM30-NS
  - Silver: TM31-NS
  - White: TM34-NS
- MODESTY**
- M34T: "W" "G" Style Drop Door Tech Modesty - \$125
  - M34TM: "M" Style Drop Door Tech Modesty - \$125
  - M51: Open Back Modesty with Wire Mgmt Rail - Deduct \$95
- PREMIUM FINISH OPTION**
- MFB: Black metal finish - \$25 per foot
  - MFW: White metal finish - \$25 per foot

**4 SELECT HARDWARE**

Hardware Option Not Available

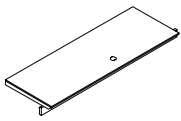

**OPEN BACK BRIDGE**

**STANDARD FEATURES**

- Metal grommet matches pull finish

[CLICK HERE TO VIEW PRODUCT INDEX](#)

**1 SELECT A STYLE**

DIMENSIONS		STYLE NUMBER	LIST PRICE	STYLE NUMBER	LIST PRICE	STYLE NUMBER	LIST PRICE
W" x D" x H"	WGT	"W" Veneer Veneer Top Veneer Chassis		"G" HPL High Pressure Laminate Top Veneer Chassis		"M" TFL Thermally Fused Laminate Top Thermally Fused Laminate Chassis	
60 x 22 x 29	65	NSS6022BR151W	720	NSS6022BR151G	720	NSS6022BR151M	495
54 x 22 x 29	60	NSS5422BR151W	630	NSS5422BR151G	630	NSS5422BR151M	473
48 x 22 x 29	55	NSS4822BR151W	540	NSS4822BR151G	540	NSS4822BR151M	452
42 x 22 x 29	391	NSS4222BR151W	510	NSS4222BR151G	510	NSS4222BR151M	430
36 x 22 x 29	363	NSS3622BR151W	485	NSS3622BR151G	485	NSS3622BR151M	399

**2 SELECT A FINISH**

"W" Veneer	"G" HPL	"M" TFL	Finish
WAC	GAC	-	Amber Cherry
WRC	-	-	Caramel Cherry
WIC	GIC	-	Crimson Cherry
WEC	-	-	Ebony Cherry
WHC	GHC	MHC	Honey Cherry
WOC	GOC	MOC	KoKo Cherry
WSC	-	-	Scotch Cherry
WAM	GAM	-	Alabaster Maple
WCM	GCM	-	Clear Maple
WWM	GWM	-	Wheat Maple
WEW	GEW	-	Executive Walnut
WRW	GRW	-	Gray Luster Walnut
WGW	-	MGW	Gunstock Walnut
WJW	-	-	Judicial Walnut
WNW	GNW	-	Natural Walnut
WTW	GTW	MTW	Studio Teak Walnut
WWP	GWL	MWL	Designer White

**3 SELECT AN EDGE**

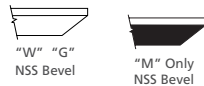

**5 OPTIONS**

- ACCESSORIES**
- K28: Articulating Keyboard w/ Mouse - \$375
  - K31: Center Drawer - \$195
- GROMMETS (NON-STANDARD LOCATION)**
- Provide drawing w/ Grommet Location and Specify Color - \$90 ea.
- Black: TM30-NS
  - Silver: TM31-NS
  - White: TM34-NS
- MODESTY**
- M34T: "W" "G" Style Drop Door Tech Modesty - \$125
  - M34TM: "M" Style Drop Door Tech Modesty - \$125
  - M37: "W" "G" Style Fixed Full Modesty - \$125
  - M37M: "M" Style Fixed Full Modesty - \$75

**4 SELECT HARDWARE**

Hardware Option Not Available

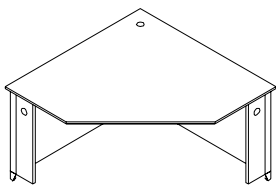

**CORNER UNIT**

**STANDARD FEATURES**

- Metal grommet matches pull finish in top
- Grommets in end panels
- Outfeed hole standard (specify left or right)
- Standard silver feet (optional White, Black)

OPB for Open Plan application

**NOTES**

- If using as freestanding, grommet hole will be visible on end
- Unit not designed for open plan use. Select

[CLICK HERE TO VIEW PRODUCT INDEX](#)

**1 SELECT A STYLE**

DIMENSIONS		STYLE NUMBER	LIST PRICE	STYLE NUMBER	LIST PRICE	STYLE NUMBER	LIST PRICE
W" x D" x H"	WGT	"W" Veneer Veneer Top Veneer Chassis		"G" HPL High Pressure Laminate Top Veneer Chassis		"M" TFL Thermally Fused Laminate Top Thermally Fused Laminate Chassis	
48 x 48 x 29	195	NSS4848CU228W	3190	NSS4848CU228G	3190	NSS4848CU228M	1692
42 x 42 x 29	170	NSS4242CU228W	3055	NSS4242CU228G	3055	NSS4242CU228M	1621
36 x 36 x 29	140	NSS3636CU228W	2890	NSS3636CU228G	2890	NSS3636CU228M	1547

**2 SELECT A FINISH**

"W" Veneer	"G" HPL	"M" TFL	Finish
WAC	GAC	-	Amber Cherry
WRC	-	-	Caramel Cherry
WIC	GIC	-	Crimson Cherry
WEC	-	-	Ebony Cherry
WHC	GHC	MHC	Honey Cherry
WOC	GOC	MOC	KoKo Cherry
WSC	-	-	Scotch Cherry
WAM	GAM	-	Alabaster Maple
WCM	GCM	-	Clear Maple
WWM	GWM	-	Wheat Maple
WEW	GEW	-	Executive Walnut
WRW	GRW	-	Gray Luster Walnut
WGW	-	MGW	Gunstock Walnut
WJW	-	-	Judicial Walnut
WNW	GNW	-	Natural Walnut
WTW	GTW	MTW	Studio Teak Walnut
WWP	GWL	MWL	Designer White

**3 SELECT AN EDGE**



**5 OPTIONS**

- ACCESSORIES**
- K28: Articulating Keyboard w/ Mouse - \$375
- GROMMETS (NON-STANDARD LOCATION)**
- Provide drawing w/ Grommet Location and Specify Color - \$90 ea.
- Black: TM30-NS
  - Silver: TM31-NS
  - White: TM34-NS
- PREMIUM FINISH OPTION**
- MFB: Black metal finish - \$25 per foot
  - MFW: White metal finish - \$25 per foot

**4 SELECT HARDWARE**

Hardware Option Not Available

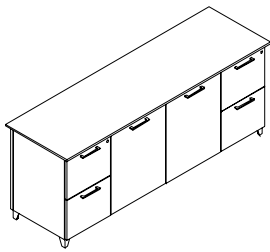

**FILE/FILE/STORAGE CREDENZA**

**STANDARD FEATURES**

- Full height storage has 1 black laminate adjustable shelf
- Full extension drawers - locking
- Soft close suspension drawer(s)
- Standard Silver Feet (optional White, Black)

**NOTES**

- Unit not designed for open plan use. Select OPB for Open Plan application

[CLICK HERE TO VIEW PRODUCT INDEX](#)

**1 SELECT A STYLE**

DIMENSIONS		STYLE NUMBER	LIST PRICE	STYLE NUMBER	LIST PRICE	STYLE NUMBER	LIST PRICE
W" x D" x H"	WGT	"W" Veneer Veneer Top Veneer Chassis		"G" HPL High Pressure Laminate Top Veneer Chassis		"M" TFL Thermally Fused Laminate Top Thermally Fused Laminate Chassis	
72 x 22 x 29	270	NSS7222CA050W	3270	NSS7222CA050G	3270	NSS7222CA050M	2138
66 x 22 x 29	255	NSS6622CA050W	3200	NSS6622CA050G	3200	NSS6622CA050M	2097
60 x 22 x 29	240	NSS6022CA050W	3130	NSS6022CA050G	3130	NSS6022CA050M	2064

**2 SELECT A FINISH**

"W" Veneer	"G" HPL	"M" TFL	Finish
WAC	GAC	-	Amber Cherry
WRC	-	-	Caramel Cherry
WIC	GIC	-	Crimson Cherry
WEC	-	-	Ebony Cherry
WHC	GHC	MHC	Honey Cherry
WOC	GOC	MOC	KoKo Cherry
WSC	-	-	Scotch Cherry
WAM	GAM	-	Alabaster Maple
WCM	GCM	-	Clear Maple
WWM	GWM	-	Wheat Maple
WEW	GEW	-	Executive Walnut
WRW	GRW	-	Gray Luster Walnut
WGW	-	MGW	Gunstock Walnut
WJW	-	-	Judicial Walnut
WNW	GNW	-	Natural Walnut
WTW	GTW	MTW	Studio Teak Walnut
WWP	GWL	MWL	Designer White

**METAL FINISHES**

MFB	-	-	Black (Premium Finish)
MFS	-	-	Silver
MFW	-	-	White (Premium Finish)

**3 SELECT AN EDGE**

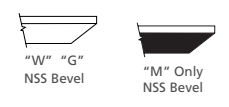

**4 SELECT HARDWARE**

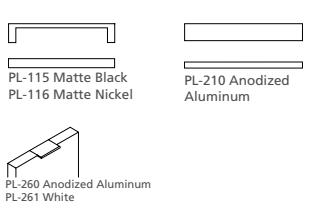

**5 OPTIONS**

- DOOR**
- D2: Door Lock - \$95 per Door Set
  - D6A: "W"/"G" Styles - Delete Doors and replace black laminate shelf with finished shelf - n/c
  - D9SC: Soft Close Door Hinges - \$15 per Door
- DRAWER**
- P6: Modify File/File to Box/Box/File - \$50 per pedestal
  - P33: Wood Drawer Upgrade - \$40 per drawer
  - WPD3061: Full fill designer white - \$75 per pedestal
- FEET**
- D8: Delete feet (extend fronts to floor) - n/c
- FLUSH CUT**
- FC-B: Flush Unit Both Sides(Facing) for Ganging - \$50
  - FC-L: Flush Unit Left (Facing) for Ganging - \$50
  - FC-R: Flush Unit Right(Facing) for Ganging - \$50
- GROMMETS (STANDARD LOCATION)**
- Specify Color and Location (Right/Left/Center) - \$45 ea.
- Black: TM30-R (Right), TM30-L (Left), TM30-C (Center)
  - Silver: TM31-R (Right), TM31-L (Left), TM31-C (Center)
  - White: TM34-R (Right), TM34-L (Left), TM34-C (Center)
- GROMMETS (NON-STANDARD LOCATION)**
- Provide drawing w/ Grommet Location and Specify Color - \$90 ea.
- Black: TM30-NS
  - Silver: TM31-NS
  - White: TM34-NS
- OPEN PLAN**
- OPB: "W" "G" Style - Modify Unit for Open Plan Application - \$295
- SHELF**
- S714F: Heavy Duty Lumber 1" Shelves - \$75 per Shelf ("M" Styles - n/a)
- PREMIUM FINISH OPTION**
- MFB: Black metal finish - \$25 per foot

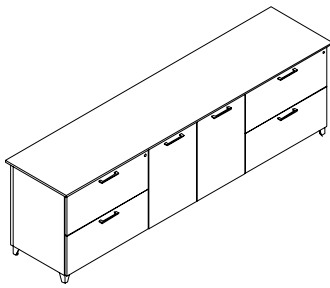

**LATERAL FILE/STORAGE**

**STANDARD FEATURES**

- Full height storage has black laminate adjustable shelf
- Full extension drawers - locking
- Soft close suspension drawer(s)
- Standard Silver Feet (optional White, Black)

**NOTES**

- Unit not designed for open plan use. Select OPB for Open Plan application

[CLICK HERE TO VIEW PRODUCT INDEX](#)

**1 SELECT A STYLE**

DIMENSIONS		STYLE NUMBER	LIST PRICE	STYLE NUMBER	LIST PRICE	STYLE NUMBER	LIST PRICE
W" x D" x H"	WGT	"W" Veneer Veneer Top Veneer Chassis		"G" HPL High Pressure Laminate Top Veneer Chassis		"M" TFL Thermally Fused Laminate Top Thermally Fused Laminate Chassis	
96 x 22 x 29	350	NSS9622CA651W	3970	NSS9622CA651G	3970	NSS9622CA651M	3049
90 x 22 x 29	330	NSS9022CA651W	3910	NSS9022CA651G	3910	NSS9022CA651M	2955

**2 SELECT A FINISH**

"W" Veneer	"G" HPL	"M" TFL	Finish
WAC	GAC	-	Amber Cherry
WRC	-	-	Caramel Cherry
WIC	GIC	-	Crimson Cherry
WEC	-	-	Ebony Cherry
WHC	GHC	MHC	Honey Cherry
WOC	GOC	MOC	KoKo Cherry
WSC	-	-	Scotch Cherry
WAM	GAM	-	Alabaster Maple
WCM	GCM	-	Clear Maple
WWM	GWM	-	Wheat Maple
WEW	GEW	-	Executive Walnut
WRW	GRW	-	Gray Luster Walnut
WGW	-	MGW	Gunstock Walnut
WJW	-	-	Judicial Walnut
WNW	GNW	-	Natural Walnut
WTW	GTW	MTW	Studio Teak Walnut
WWP	GWL	MWL	Designer White

**METAL FINISHES**

MFB	-	-	Black (Premium Finish)
MFS	-	-	Silver
MFW	-	-	White (Premium Finish)

**3 SELECT AN EDGE**

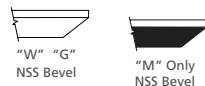

**4 SELECT HARDWARE**

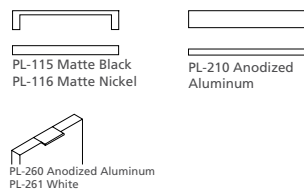

**5 OPTIONS**

- DOOR**
- D2: Door Lock per Door Set - \$95
  - D6A: "W"/"G" Styles - Delete Doors and replace black laminate shelf with finished shelf - n/c
  - D95C: Soft Close Door Hinges - \$15 per Door
- DRAWER**
- P33: Wood Drawer Upgrade - \$40 per drawer
  - WPD3061: Full fill designer white - \$75 per pedestal
- FEET**
- D8: Delete feet (extend fronts to floor) - n/c
- FLUSH CUT**
- FC-B: Flush Unit Both Sides(Facing) for Ganging - \$50
  - FC-L: Flush Unit Left (Facing) for Ganging - \$50
  - FC-R: Flush Unit Right(Facing) for Ganging - \$50
- GROMMETS (STANDARD LOCATION)**
- Specify Color and Location (Right/Left/Center) - \$45 ea.
- Black: TM30-R (Right), TM30-L (Left), TM30-C (Center)
  - Silver: TM31-R (Right), TM31-L (Left), TM31-C (Center)
  - White: TM34-R (Right), TM34-L (Left), TM34-C (Center)
- GROMMETS (NON-STANDARD LOCATION)**
- Provide drawing w/ Grommet Location and Specify Color - \$90 ea.
- Black: TM30-NS
  - Silver: TM31-NS
  - White: TM34-NS
- OPEN PLAN**
- OPB: "W" "G" Style - Modify Unit for Open Plan Application - \$295
- SHELF**
- S714F: Heavy Duty Lumber 1" Shelves - \$75 per Shelf ("M" Styles - n/a)
- PREMIUM FINISH OPTION**
- MFB: Black metal finish - \$25 per foot
  - MFW: White metal finish - \$25 per foot



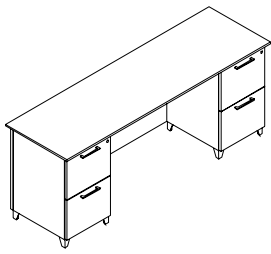

**FILE/FILE/KNEESPACE**

**STANDARD FEATURES**

- Full modesty back
- Full extension drawers - locking
- Soft close suspension drawer(s)
- Standard Silver Feet (optional White, Black)

OPB for Open Plan application

**NOTES**

- If a grommet is located in top surface over open knee space, an outfeed hole will be provided in modesty panel
- Unit not designed for open plan use. Select

[CLICK HERE TO VIEW PRODUCT INDEX](#)

**1 SELECT A STYLE**

DIMENSIONS		STYLE NUMBER	LIST PRICE	STYLE NUMBER	LIST PRICE	STYLE NUMBER	LIST PRICE
W" x D" x H"	WGT	"W" Veneer Veneer Top Veneer Chassis		"G" HPL High Pressure Laminate Top Veneer Chassis		"M" TFL Thermally Fused Laminate Top Thermally Fused Laminate Chassis	
84 x 22 x 29	240	NSS8422CA054W	3165	NSS8422CA054G	3165	NSS8422CA054M	2085
72 x 22 x 29	220	NSS7222CA054W	2930	NSS7222CA054G	2930	NSS7222CA054M	1949
66 x 24 x 29	210	NSS6622CA054W	2900	NSS6622CA054G	2900	NSS6622CA054M	1911
60 x 24 x 29	200	NSS6022CA054W	2870	NSS6022CA054G	2870	NSS6022CA054M	1883

**2 SELECT A FINISH**

"W" Veneer	"G" HPL	"M" TFL	Finish
WAC	GAC	-	Amber Cherry
WRC	-	-	Caramel Cherry
WIC	GIC	-	Crimson Cherry
WEC	-	-	Ebony Cherry
WHC	GHC	MHC	Honey Cherry
WOC	GOC	MOC	KoKo Cherry
WSC	-	-	Scotch Cherry
WAM	GAM	-	Alabaster Maple
WCM	GCM	-	Clear Maple
WWM	GWM	-	Wheat Maple
WEW	GEW	-	Executive Walnut
WRW	GRW	-	Gray Luster Walnut
WGW	-	MGW	Gunstock Walnut
WJW	-	-	Judicial Walnut
WNW	GNW	-	Natural Walnut
WTW	GTW	MTW	Studio Teak Walnut
WWP	GWL	MWL	Designer White

**METAL FINISHES**

MFB	-	-	Black (Premium Finish)
MFS	-	-	Silver
MFW	-	-	White (Premium Finish)

**3 SELECT AN EDGE**

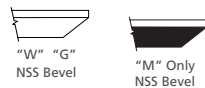

**4 SELECT HARDWARE**

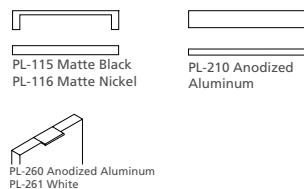

**5 OPTIONS**

- ACCESSORIES**
- K28: Articulating Keyboard w/ Mouse - \$375
- DRAWER**
- P6: Modify File/File to Box/Box/File - \$50 per pedestal
  - P33: Wood Drawer Upgrade - \$40 per drawer
  - WPD3061: Full fill designer white - \$75 per pedestal
- FEET**
- D8: Delete feet (extend fronts to floor) - n/c
- FLUSH CUT**
- FC-B: Flush Unit Both Sides(Facing) for Ganging - \$50
  - FC-L: Flush Unit Left (Facing) for Ganging - \$50
  - FC-R: Flush Unit Right(Facing) for Ganging - \$50
- GROMMETS (STANDARD LOCATION)**
- Specify Color - \$45 ea.
- Black: TM30-C (Center)
  - Silver: TM31-C (Center)
  - White: TM34-C (Center)
- GROMMETS (NON-STANDARD LOCATION)**
- Provide drawing w/ Grommet Location and Specify Color - \$90 ea.
- Black: TM30-NS
  - Silver: TM31-NS
  - White: TM34-NS
- MODESTY**
- M34T: "W" "G" Style Drop Door Tech Modesty - \$125
  - M34TM: "M" Style Drop Door Tech Modesty - \$125
  - M51: Open Back Modesty with Wire Mgmt Rail - Deduct \$95
- OPEN PLAN**
- OPB: "W" "G" Style - Modify Unit for Open Plan Application - \$295
- PREMIUM FINISH OPTION**
- MFB: Black metal finish - \$25 per foot
  - MFW: White metal finish - \$25 per foot

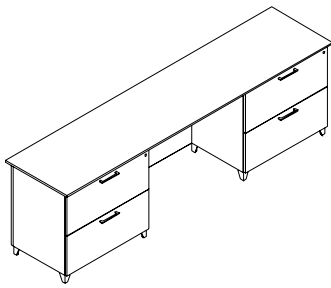

**LATERAL FILE/KNEESPACE**

**STANDARD FEATURES**

- Full modesty back
- Full extension drawers - locking
- Soft close suspension drawer(s)
- Standard Silver Feet (optional White, Black)

OPB for Open Plan application

**NOTES**

- If a grommet is located in top surface over open knee space, an outfeed hole will be provided in modesty panel
- Unit not designed for open plan use. Select

[CLICK HERE TO VIEW PRODUCT INDEX](#)

**1 SELECT A STYLE**

DIMENSIONS		STYLE NUMBER	LIST PRICE	STYLE NUMBER	LIST PRICE	STYLE NUMBER	LIST PRICE
W" x D" x H"	WGT	"W" Veneer Veneer Top Veneer Chassis		"G" HPL High Pressure Laminate Top Veneer Chassis		"M" TFL Thermally Fused Laminate Top Thermally Fused Laminate Chassis	
96 x 22 x 29	325	NSS9622CA052W	3455	NSS9622CA052G	3455	NSS9622CA052M	2642
90 x 22 x 29	210	NSS9022CA052W	3420	NSS9022CA052G	3420	NSS9022CA052M	2581

**2 SELECT A FINISH**

"W" Veneer	"G" HPL	"M" TFL	Finish
WAC	GAC	-	Amber Cherry
WRC	-	-	Caramel Cherry
WIC	GIC	-	Crimson Cherry
WEC	-	-	Ebony Cherry
WHC	GHC	MHC	Honey Cherry
WOC	GOC	MOC	KoKo Cherry
WSC	-	-	Scotch Cherry
WAM	GAM	-	Alabaster Maple
WCM	GCM	-	Clear Maple
WWM	GWM	-	Wheat Maple
WEW	GEW	-	Executive Walnut
WRW	GRW	-	Gray Luster Walnut
WGW	-	MGW	Gunstock Walnut
WJW	-	-	Judicial Walnut
WNW	GNW	-	Natural Walnut
WTW	GTW	MTW	Studio Teak Walnut
WWP	GWL	MWL	Designer White

**METAL FINISHES**

MFB	-	-	Black (Premium Finish)
MFS	-	-	Silver
MFW	-	-	White (Premium Finish)

**3 SELECT AN EDGE**

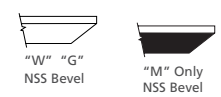

**4 SELECT HARDWARE**

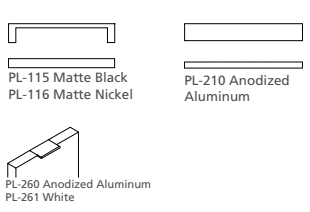

**5 OPTIONS**

- ACCESSORIES**
- K28: Articulating Keyboard w/ Mouse - \$375
- DRAWER**
- P33: Wood Drawer Upgrade - \$40 per drawer
  - WPD3061: Full fill designer white - \$75 per pedestal
- FEET**
- D8: Delete feet (extend fronts to floor) - n/c
- FLUSH CUT**
- FC-B: Flush Unit Both Sides(Facing) for Ganging - \$50
  - FC-L: Flush Unit Left (Facing) for Ganging - \$50
  - FC-R: Flush Unit Right(Facing) for Ganging - \$50
- GROMMETS (STANDARD LOCATION)**
- Specify Color - \$45 ea.
- Black: TM30-C (Center)
  - Silver: TM31-C (Center)
  - White: TM34-C (Center)
- GROMMETS (NON-STANDARD LOCATION)**
- Provide drawing w/ Grommet Location and Specify Color - \$90 ea.
- Black: TM30-NS
  - Silver: TM31-NS
  - White: TM34-NS
- MODESTY**
- M34T: "W" "G" Style Drop Door Tech Modesty - \$125
  - M34TM: "M" Style Drop Door Tech Modesty - \$125
  - M51: Open Back Modesty with Wire Mgmt Rail - Deduct \$95
- OPEN PLAN**
- OPB: "W" "G" Style - Modify Unit for Open Plan Application - \$295
- PREMIUM FINISH OPTION**
- MFB: Black metal finish - \$25 per foot
  - MFW: White metal finish - \$25 per foot

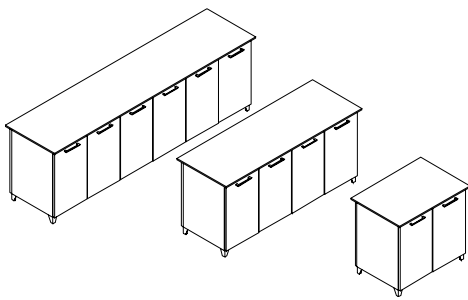

**STORAGE**

**STANDARD FEATURES**

- Full height storage has 1 adjustable black laminate shelf per section
- Standard Silver Feet (optional White, Black)

**NOTES**

- Unit not designed for open plan use. Select OPB for Open Plan application

[CLICK HERE TO VIEW PRODUCT INDEX](#)

**1 SELECT A STYLE**

DIMENSIONS		STYLE NUMBER		LIST PRICE	STYLE NUMBER		LIST PRICE	STYLE NUMBER		LIST PRICE
W" x D" x H"	WGT	"W" Veneer	Veneer Top Veneer Chassis		"G" HPL	High Pressure Laminate Top Veneer Chassis		"M" TFL	Thermally Fused Laminate Top Thermally Fused Laminate Chassis	
<b>3 Section</b>										
95 x 22 x 29	325	NSS9522CA125W		3825	NSS9522CA125G		3825	NSS9522CA125M		2674
89 x 22 x 29	300	NSS8922CA125W		3760	NSS8922CA125G		3760	NSS8922CA125M		2605
<b>2 Section</b>										
72 x 22 x 29	275	NSS7222CA125W		3070	NSS7222CA125G		3070	NSS7222CA125M		1967
60 x 22 x 29	250	NSS6022CA125W		2980	NSS6022CA125G		2980	NSS6022CA125M		1916
<b>1 Section</b>										
37 x 22 x 29	145	NSS3722CA125W		1640	NSS3722CA125G		1640	NSS3722CA125M		1055
31 x 22 x 29	135	NSS3122CA125W		1550	NSS3122CA125G		1550	NSS3122CA125M		1026

**2 SELECT A FINISH**

"W" Veneer	"G" HPL	"M" TFL	Finish
WAC	GAC	-	Amber Cherry
WRC	-	-	Caramel Cherry
WIC	GIC	-	Crimson Cherry
WEC	-	-	Ebony Cherry
WHC	GHC	MHC	Honey Cherry
WOC	GOC	MOC	KoKo Cherry
WSC	-	-	Scotch Cherry
WAM	GAM	-	Alabaster Maple
WCM	GCM	-	Clear Maple
WWM	GWM	-	Wheat Maple
WEW	GEW	-	Executive Walnut
WRW	GRW	-	Gray Luster Walnut
WGW	-	MGW	Gunstock Walnut
WJW	-	-	Judicial Walnut
WNW	GNW	-	Natural Walnut
WTW	GTW	MTW	Studio Teak Walnut
WWP	GWL	MWL	Designer White
<b>METAL FINISHES</b>			
MFB	-	-	Black (Premium Finish)
MFS	-	-	Silver
MFW	-	-	White (Premium Finish)

**3 SELECT AN EDGE**

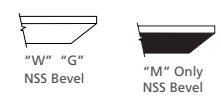

**4 SELECT HARDWARE**

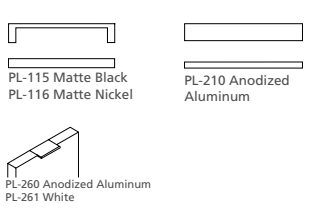

**5 OPTIONS**

- DOOR**
- D2: Door lock (Panel Door Only) - \$95 per Door Set
  - D6A: "W"/"G" Styles - Delete Doors and replace black laminate shelf with finished shelf - n/c
  - D9SC: Soft Close Door Hinges - \$15 per Door
  - WPD3061: Full fill designer white - \$75 per door
- FEET**
- D8: Delete feet (extend fronts to floor) - n/c
- FLUSH CUT**
- FC-B: Flush Unit Both Sides(Facing) for Ganging - \$50
  - FC-L: Flush Unit Left (Facing) for Ganging - \$50
  - FC-R: Flush Unit Right(Facing) for Ganging - \$50
- GROMMETS (STANDARD LOCATION)**
- Specify Color and Location (Right/Left/Center) - \$45 ea.
- Black: TM30-R (Right), TM30-L (Left), TM30-C (Center)
  - Silver: TM31-R (Right), TM31-L (Left), TM31-C (Center)
  - White: TM34-R (Right), TM34-L (Left), TM34-C (Center)
- GROMMETS (NON-STANDARD LOCATION)**
- Provide drawing w/ Grommet Location and Specify Color - \$90 ea.
- Black: TM30-NS
  - Silver: TM31-NS
  - White: TM34-NS
- GROMMETS (VERTICAL SURFACE)**
- Standard Location - \$45 ea.
- Black Plastic Vertical Surface: TM50-C (Bottom Center)
- Non-Standard Location - \$90 ea.
- Black Plastic Vertical Surface: TM50-NS
- OPEN PLAN**
- OPB: "W" "G" Style - Modify Unit for Open Plan Application - \$295
- PREMIUM FINISH OPTION**
- MFB: Black metal finish - \$25 per foot
  - MFW: White metal finish - \$25 per foot

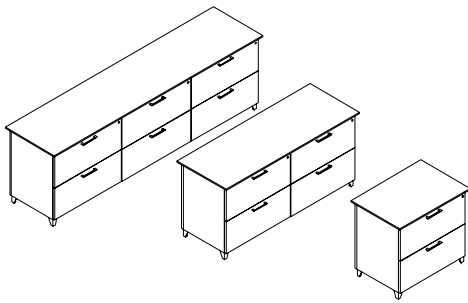

**HORIZONTAL LATERAL FILE**

**STANDARD FEATURES**

- Anti-tip safety feature (31"-72")
- Full extension drawers - locking
- Soft close suspension drawer(s)
- Standard Silver Feet (optional White, Black)

**NOTES**

- Unit not designed for open plan use. Select OPB for Open Plan application

[CLICK HERE TO VIEW PRODUCT INDEX](#)

**1 SELECT A STYLE**

DIMENSIONS		STYLE NUMBER		LIST PRICE	STYLE NUMBER		LIST PRICE	STYLE NUMBER		LIST PRICE
W" x D" x H"	WGT	"W" Veneer	Veneer Top Veneer Chassis		"G" HPL	High Pressure Laminate Top Veneer Chassis		"M" TFL	Thermally Fused Laminate Top Thermally Fused Laminate Chassis	
<b>6 Drawer</b>										
95 x 22 x 29	370	NSS9522CA104W		4040	NSS9522CA104G		4040	NSS9522CA104M		3044
89 x 22 x 29	350	NSS8922CA104W		3985	NSS8922CA104G		3985	NSS8922CA104M		3016
<b>4 Drawer</b>										
72 x 22 x 29	315	NSS7222CA104W		3210	NSS7222CA104G		3210	NSS7222CA104M		2308
60 x 22 x 29	275	NSS6022CA104W		3120	NSS6022CA104G		3120	NSS6022CA104M		2244
<b>2 Drawer</b>										
43 x 22 x 29	175	NSS4322CA104W		1870	NSS4322CA104G		1870	NSS4322CA104M		1460
37 x 22 x 29	160	NSS3722CA104W		1705	NSS3722CA104G		1705	NSS3722CA104M		1350
31 x 22 x 29	150	NSS3122CA104W		1640	NSS3122CA104G		1640	NSS3122CA104M		1312

**2 SELECT A FINISH**

"W" Veneer	"G" HPL	"M" TFL	Finish
WAC	GAC	-	Amber Cherry
WRC	-	-	Caramel Cherry
WIC	GIC	-	Crimson Cherry
WEC	-	-	Ebony Cherry
WHC	GHC	MHC	Honey Cherry
WOC	GOC	MOC	KoKo Cherry
WSC	-	-	Scotch Cherry
WAM	GAM	-	Alabaster Maple
WCM	GCM	-	Clear Maple
WWM	GWM	-	Wheat Maple
WEW	GEW	-	Executive Walnut
WRW	GRW	-	Gray Luster Walnut
WGW	-	MGW	Gunstock Walnut
WJW	-	-	Judicial Walnut
WNW	GNW	-	Natural Walnut
WTW	GTW	MTW	Studio Teak Walnut
WWP	GWL	MWL	Designer White

**METAL FINISHES**

MFB	-	-	Black (Premium Finish)
MFS	-	-	Silver
MFW	-	-	White (Premium Finish)

**3 SELECT AN EDGE**

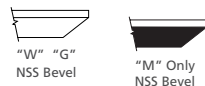

**5 OPTIONS**

- DRAWER**
- P33: Wood Drawer Upgrade - \$40 per drawer
  - WPD3061: Full fill designer white - \$75 per pedestal
- FEET**
- D8: Delete feet (extend fronts to floor) - n/c
- FLUSH CUT**
- FC-B: Flush Unit Both Sides(Facing) for Ganging - \$50
  - FC-L: Flush Unit Left (Facing) for Ganging - \$50
  - FC-R: Flush Unit Right(Facing) for Ganging - \$50
- OPEN PLAN**
- OPB: "W" "G" Style - Modify Unit for Open Plan Application - \$295
- PREMIUM FINISH OPTION**
- MFB: Black metal finish - \$25 per foot
  - MFW: White metal finish - \$25 per foot

**4 SELECT HARDWARE**

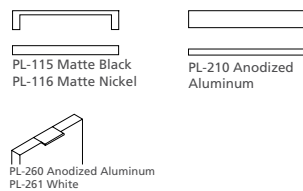

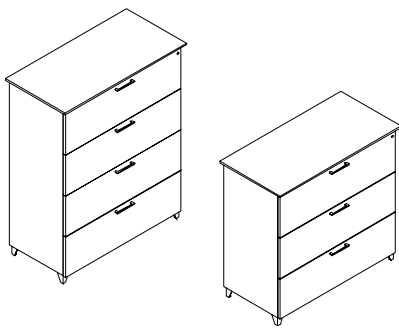

**VERTICAL LATERAL FILE**

**STANDARD FEATURES**

- Anti-tip safety feature
- Full extension drawers - locking
- Soft close suspension drawer(s)
- Standard Silver Feet (optional White, Black)

**NOTES**

- Unit not designed for open plan use. Select OPB for Open Plan application

[CLICK HERE TO VIEW PRODUCT INDEX](#)

**1 SELECT A STYLE**

DIMENSIONS		STYLE NUMBER	LIST PRICE	STYLE NUMBER	LIST PRICE	STYLE NUMBER	LIST PRICE
W" x D" x H"	WGT	"W" Veneer Top Veneer Chassis		"G" HPL High Pressure Laminate Top Veneer Chassis		"M" TFL Thermally Fused Laminate Top Thermally Fused Laminate Chassis	
<b>4 Drawer</b>							
43 x 22 x 54	290	NSS4322FI111W	3430	NSS4322FI111G	3430	NSS4322FI111M	2197
37 x 22 x 54	270	NSS3722FI111W	3240	NSS3722FI111G	3240	NSS3722FI111M	2010
31 x 22 x 54	245	NSS3122FI111W	3120	NSS3122FI111G	3120	NSS3122FI111M	1950
<b>3 Drawer</b>							
43 x 22 x 42	255	NSS4322FI112W	3190	NSS4322FI112G	3190	NSS4322FI112M	1998
37 x 22 x 42	235	NSS3722FI112W	3010	NSS3722FI112G	3010	NSS3722FI112M	1811
31 x 22 x 42	215	NSS3122FI112W	2900	NSS3122FI112G	2900	NSS3122FI112M	1755

**2 SELECT A FINISH**

"W" Veneer	"G" HPL	"M" TFL	Finish
WAC	GAC	-	Amber Cherry
WRC	-	-	Caramel Cherry
WIC	GIC	-	Crimson Cherry
WEC	-	-	Ebony Cherry
WHC	GHC	MHC	Honey Cherry
WOC	GOC	MOC	KoKo Cherry
WSC	-	-	Scotch Cherry
WAM	GAM	-	Alabaster Maple
WCM	GCM	-	Clear Maple
WWM	GWM	-	Wheat Maple
WEW	GEW	-	Executive Walnut
WRW	GRW	-	Gray Luster Walnut
WGW	-	MGW	Gunstock Walnut
WJW	-	-	Judicial Walnut
WNW	GNW	-	Natural Walnut
WTW	GTW	MTW	Studio Teak Walnut
WWP	GWL	MWL	Designer White

**METAL FINISHES**

MFB	-	-	Black (Premium Finish)
MFS	-	-	Silver
MFW	-	-	White (Premium Finish)

**3 SELECT AN EDGE**

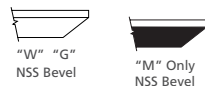

**5 OPTIONS**

- DRAWER**
- P33: Wood Drawer Upgrade - \$40 per drawer
  - WPD3061: Full fill designer white - \$75 per pedestal
- FEET**
- D8: Delete feet (extend fronts to floor) - n/c
- FLUSH CUT**
- FC-B: Flush Unit Both Sides(Facing) for Ganging - \$50
  - FC-L: Flush Unit Left (Facing) for Ganging - \$50
  - FC-R: Flush Unit Right(Facing) for Ganging - \$50
- OPEN PLAN**
- OPB: "W" "G" Style - Modify Unit for Open Plan Application - \$295
- PREMIUM FINISH OPTION**
- MFB: Black metal finish - \$25 per foot
  - MFW: White metal finish - \$25 per foot

**4 SELECT HARDWARE**

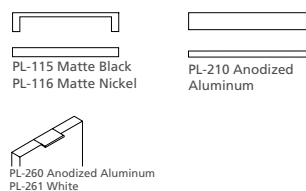

Left Pedestal

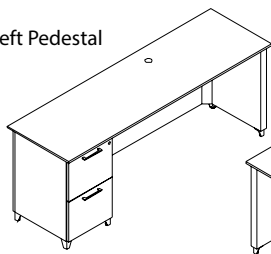

Right Pedestal

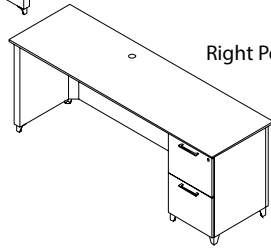

**FILE/FILE**

**STANDARD FEATURES**

- Full modesty back
- Full extension drawers - locking
- Outfeed hole standard in back of credenza
- Soft close suspension drawer(s)
- Standard metal grommet matches pull finish
- Standard Silver Feet (optional White, Black)
- Wire management channel standard

back

- Unit not designed for open plan use. Select OPB for Open Plan application

**NOTES**

- Laminate version "M" standard w/ open plan

[CLICK HERE TO VIEW PRODUCT INDEX](#)

**1 SELECT A STYLE**

DIMENSIONS		STYLE NUMBER	LIST PRICE	STYLE NUMBER	LIST PRICE	STYLE NUMBER	LIST PRICE
W" x D" x H"	WGT	"W" Veneer Veneer Top Veneer Chassis		"G" HPL High Pressure Laminate Top Veneer Chassis		"M" TFL Thermally Fused Laminate Top Thermally Fused Laminate Chassis	
<b>Left Pedestal</b>							
90 x 22 x 29	220	NSS9022CA086W	3060	NSS9022CA086G	3060	NSS9022CA086M	1948
84 x 22 x 29	210	NSS8422CA086W	3010	NSS8422CA086G	3010	NSS8422CA086M	1815
72 x 22 x 29	200	NSS7222CA086W	2780	NSS7222CA086G	2780	NSS7222CA086M	1681
66 x 22 x 29	190	NSS6622CA086W	2750	NSS6622CA086G	2750	NSS6622CA086M	1639
<b>Right Pedestal</b>							
90 x 22 x 29	220	NSS9022CA087W	3060	NSS9022CA087G	3060	NSS9022CA087M	1948
84 x 22 x 29	210	NSS8422CA087W	3010	NSS8422CA087G	3010	NSS8422CA087M	1815
72 x 22 x 29	200	NSS7222CA087W	2780	NSS7222CA087G	2780	NSS7222CA087M	1681
66 x 22 x 29	190	NSS6622CA087W	2750	NSS6622CA087G	2750	NSS6622CA087M	1639

**2 SELECT A FINISH**

"W" Veneer	"G" HPL	"M" TFL	
WAC	GAC	-	Amber Cherry
WRC	-	-	Caramel Cherry
WIC	GIC	-	Crimson Cherry
WEC	-	-	Ebony Cherry
WHC	GHC	MHC	Honey Cherry
WOC	GOC	MOC	KoKo Cherry
WSC	-	-	Scotch Cherry
WAM	GAM	-	Alabaster Maple
WCM	GCM	-	Clear Maple
WWM	GWM	-	Wheat Maple
WEW	GEW	-	Executive Walnut
WRW	GRW	-	Gray Luster Walnut
WGW	-	MGW	Gunstock Walnut
WJW	-	-	Judicial Walnut
WNW	GNW	-	Natural Walnut
WTW	GTW	MTW	Studio Teak Walnut
WWP	GWL	MWL	Designer White
<b>METAL FINISHES</b>			
MFB	-	-	Black (Premium Finish)
MFS	-	-	Silver
MFW	-	-	White (Premium Finish)

**3 SELECT AN EDGE**

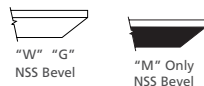

**4 SELECT HARDWARE**

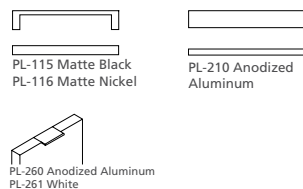

**5 OPTIONS**

**ACCESSORIES**

- K28: Articulating Keyboard w/ Mouse - \$375

**DRAWER**

- P6: Modify File/File to Box/Box/File - \$50 per pedestal
- P33: Wood Drawer Upgrade - \$40 per drawer
- P40W: extra Box/Box/File or File/File to Knee space - \$875
- P40M: extra Box/Box/File or File/File to Knee space - \$688
- WPD3061: Full fill designer white - \$75 per door

**FEET**

- D8: Delete feet (extend fronts to floor) - n/c

**FLUSH CUT**

- FC-B: Flush Unit Both Sides(Facing) for Ganging - \$50
- FC-L: Flush Unit Left (Facing) for Ganging - \$50
- FC-R: Flush Unit Right(Facing) for Ganging - \$50

**GROMMETS (NON-STANDARD LOCATION)**

Provide drawing w/ Grommet Location and Specify Color - \$90 ea.

- Black: TM30-NS
- Silver: TM31-NS
- White: TM34-NS

**MODESTY**

- M34T: "W" "G" Style Drop Door Tech Modesty - \$125
- M34TM: "M" Style Drop Door Tech Modesty - \$125
- M51: Open Back Modesty with Wire Mgmt Rail - Deduct \$95

**OPEN PLAN**

- OPB: "W" "G" Style - Modify Unit for Open Plan Application - \$195

**PREMIUM FINISH OPTION**

- MFB: Black metal finish - \$25 per foot
- MFW: White metal finish - \$25 per foot

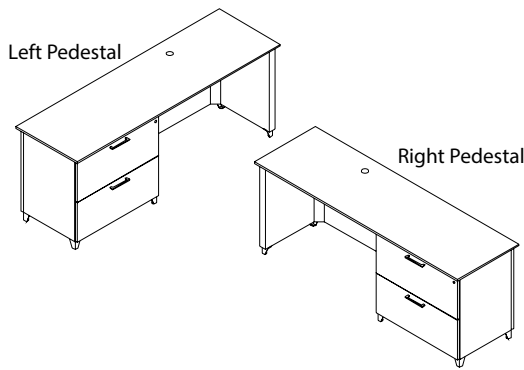

LATERAL FILE

STANDARD FEATURES

- All drawers lock
- File drawers extend 100% with cushion in-out stops - full access
- Full modesty back
- Outfeed hole standard in back of credenza
- Soft close suspension drawer(s)
- Standard metal grommet matches pull finish
- Standard Silver Feet (optional White, Black)
- Wire management channel standard

NOTES

- 96, 90, 84 W units have 35W lateral
- 72 and 66 W units have 29W lateral
- (\*) Keyboard not available on 66"W Lateral File/Multi-File Units
- Unit not designed for open plan use. Select OPB for Open Plan application

[CLICK HERE TO VIEW PRODUCT INDEX](#)

1 SELECT A STYLE

DIMENSIONS		STYLE NUMBER	LIST PRICE	STYLE NUMBER	LIST PRICE	STYLE NUMBER	LIST PRICE
W" x D" x H"	WGT	"W" Veneer Veneer Top Veneer Chassis		"G" HPL High Pressure Laminate Top Veneer Chassis		"M" TFL Thermally Fused Laminate Top Thermally Fused Laminate Chassis	
<b>Left Pedestal</b>							
96 x 22 x 29	265	NSS9622CA066W	3215	NSS9622CA066G	3215	NSS9622CA066M	2145
90 x 22 x 29	250	NSS9022CA066W	3180	NSS9022CA066G	3180	NSS9022CA066M	2039
84 x 22 x 29	240	NSS8422CA066W	3080	NSS8422CA066G	3080	NSS8422CA066M	1914
72 x 22 x 29	230	NSS7222CA066W	2880	NSS7222CA066G	2880	NSS7222CA066M	1789
66 x 22 x 29	215	NSS6622CA066W	2850	NSS6622CA066G	2850	NSS6622CA066M	1747
<b>Right Pedestal</b>							
96 x 22 x 29	265	NSS9622CA067W	3215	NSS9622CA067G	3215	NSS9622CA067M	2145
90 x 22 x 29	250	NSS9022CA067W	3180	NSS9022CA067G	3180	NSS9022CA067M	2039
84 x 22 x 29	240	NSS8422CA067W	3080	NSS8422CA067G	3080	NSS8422CA067M	1914
72 x 22 x 29	230	NSS7222CA067W	2880	NSS7222CA067G	2880	NSS7222CA067M	1789
66 x 22 x 29	215	NSS6622CA067W	2850	NSS6622CA067G	2850	NSS6622CA067M	1747

2 SELECT A FINISH

"W" Veneer	"G" HPL	"M" TFL	Finish
WAC	GAC	-	Amber Cherry
WRC	-	-	Caramel Cherry
WIC	GIC	-	Crimson Cherry
WEC	-	-	Ebony Cherry
WHC	GHC	MHC	Honey Cherry
WOC	GOC	MOC	KoKo Cherry
WSC	-	-	Scotch Cherry
WAM	GAM	-	Alabaster Maple
WCM	GCM	-	Clear Maple
WWM	GWM	-	Wheat Maple
WEW	GEW	-	Executive Walnut
WRW	GRW	-	Gray Luster Walnut
WGW	-	MGW	Gunstock Walnut
WJW	-	-	Judicial Walnut
WNW	GNW	-	Natural Walnut
WTW	GTW	MTW	Studio Teak Walnut
WWP	GWL	MWL	Designer White
<b>METAL FINISHES</b>			
MFB	-	-	Black (Premium Finish)
MFS	-	-	Silver
MFW	-	-	White (Premium Finish)

3 SELECT AN EDGE

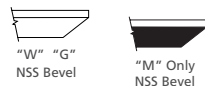

5 OPTIONS

- ACCESSORIES**
- K28: Articulating Keyboard w/ Mouse - \$375
- DRAWER**
- P33: Wood Drawer Upgrade - \$40 per drawer
  - P40W: extra Box/Box/File or File/File to Knee space - \$875 (n/a on 66")
  - P40M: extra Box/Box/File or File/File to Knee space - \$688 (n/a on 66")
  - WPD3061: Full fill designer white - \$75 per door
- FEET**
- D8: Delete feet (extend fronts to floor) - n/c
- FLUSH CUT**
- FC-B: Flush Unit Both Sides(Facing) for Ganging - \$50
  - FC-L: Flush Unit Left (Facing) for Ganging - \$50
  - FC-R: Flush Unit Right(Facing) for Ganging - \$50
- GROMMETS (NON-STANDARD LOCATION)**
- Provide drawing w/ Grommet Location and Specify Color - \$90 ea.
  - Black: TM30-NS
  - Silver: TM31-NS
  - White: TM34-NS
- MODESTY**
- M34T: "W" "G" Style Drop Door Tech Modesty - \$125
  - M34TM: "M" Style Drop Door Tech Modesty - \$125
  - M51: Open Back Modesty with Wire Mgmt Rail - Deduct \$95
- OPEN PLAN**
- OPB: "W" "G" Style - Modify Unit for Open Plan Application - \$195
- PREMIUM FINISH OPTION**
- MFB: Black metal finish - \$25 per foot
  - MFW: White metal finish - \$25 per foot

4 SELECT HARDWARE

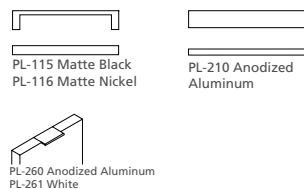

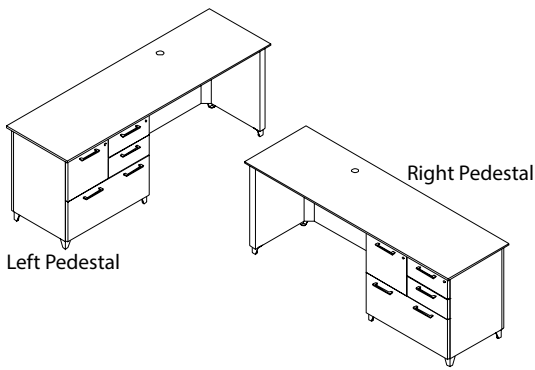

**MULTI-FILE**

**STANDARD FEATURES**

- Full modesty back
- Full extension drawers - locking
- Outfeed hole standard in back of credenza
- Soft close suspension drawer(s)
- Standard metal grommet matches pull finish
- Standard Silver Feet (optional White, Black)
- Wire management channel standard

File/Multi-File Units

- Unit not designed for open plan use. Select OPB for Open Plan application

**NOTES**

- (\*) Keyboard not available on 66"W Lateral

[CLICK HERE TO VIEW PRODUCT INDEX](#)

**1 SELECT A STYLE**

DIMENSIONS		STYLE NUMBER	LIST PRICE	STYLE NUMBER	LIST PRICE	STYLE NUMBER	LIST PRICE
W" x D" x H"	WGT	"W" Veneer Veneer Top Veneer Chassis		"G" HPL High Pressure Laminate Top Veneer Chassis		"M" TFL Thermally Fused Laminate Top Thermally Fused Laminate Chassis	
<b>Left Pedestal</b>							
96 x 22 x 29	265	NSS9622CA667W	3290	NSS9622CA667G	3290	NSS9622CA667M	2165
90 x 22 x 29	250	NSS9022CA667W	3255	NSS9022CA667G	3255	NSS9022CA667M	2136
84 x 22 x 29	240	NSS8422CA667W	3155	NSS8422CA667G	3155	NSS8422CA667M	2012
72 x 22 x 29	230	NSS7222CA667W	2955	NSS7222CA667G	2955	NSS7222CA667M	1885
*66 x 22 x 29	215	NSS6622CA667W	2925	NSS6622CA667G	2925	NSS6622CA667M	1844
<b>Right Pedestal</b>							
96 x 22 x 29	265	NSS9622CA668W	3290	NSS9622CA668G	3290	NSS9622CA668M	2165
90 x 22 x 29	250	NSS9022CA668W	3255	NSS9022CA668G	3255	NSS9022CA668M	2136
84 x 22 x 29	240	NSS8422CA668W	3155	NSS8422CA668G	3155	NSS8422CA668M	2012
72 x 22 x 29	230	NSS7222CA668W	2955	NSS7222CA668G	2955	NSS7222CA668M	1885
*66 x 22 x 29	215	NSS6622CA668W	2925	NSS6622CA668G	2925	NSS6622CA668M	1844

**2 SELECT A FINISH**

"W" Veneer	"G" HPL	"M" TFL	Finish
WAC	GAC	-	Amber Cherry
WRC	-	-	Caramel Cherry
WIC	GIC	-	Crimson Cherry
WEC	-	-	Ebony Cherry
WHC	GHC	MHC	Honey Cherry
WOC	GOC	MOC	KoKo Cherry
WSC	-	-	Scotch Cherry
WAM	GAM	-	Alabaster Maple
WCM	GCM	-	Clear Maple
WWM	GWM	-	Wheat Maple
WEW	GEW	-	Executive Walnut
WRW	GRW	-	Gray Luster Walnut
WGW	-	MGW	Gunstock Walnut
WJW	-	-	Judicial Walnut
WNW	GNW	-	Natural Walnut
WTW	GTW	MTW	Studio Teak Walnut
WWP	GWL	MWL	Designer White
<b>METAL FINISHES</b>			
MFB	-	-	Black (Premium Finish)
MFS	-	-	Silver
MFW	-	-	White (Premium Finish)

**3 SELECT AN EDGE**



**4 SELECT HARDWARE**

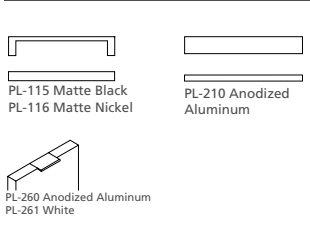

**5 OPTIONS**

- ACCESSORIES**
- K28: Articulating Keyboard w/ Mouse - \$375
- DRAWER**
- P33: Wood Drawer Upgrade - \$40 per drawer
  - P40W: extra Box/Box/File or File/File to Knee space - \$875 (n/a on 66")
  - P40M: extra Box/Box/File or File/File to Knee space - \$688 (n/a on 66")
  - WPD3061: Full fill designer white - \$75 per door
- FEET**
- D8: Delete feet (extend fronts to floor) - n/c
- FLUSH CUT**
- FC-B: Flush Unit Both Sides(Facing) for Ganging - \$50
  - FC-L: Flush Unit Left (Facing) for Ganging - \$50
  - FC-R: Flush Unit Right(Facing) for Ganging - \$50
- GROMMETS (NON-STANDARD LOCATION)**
- Provide drawing w/ Grommet Location and Specify Color - \$90 ea.
  - Black: TM30-NS
  - Silver: TM31-NS
  - White: TM34-NS
- MODESTY**
- M34T: "W" "G" Style Drop Door Tech Modesty - \$125
  - M34TM: "M" Style Drop Door Tech Modesty - \$125
  - M51: Open Back Modesty with Wire Mgmt Rail - Deduct \$95
- OPEN PLAN**
- OPB: "W" "G" Style - Modify Unit for Open Plan Application - \$195
- PREMIUM FINISH OPTION**
- MFB: Black metal finish - \$25 per foot
  - MFW: White metal finish - \$25 per foot



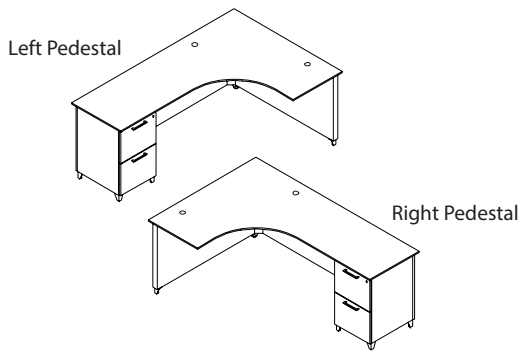

**FILE/FILE**

**STANDARD FEATURES**

- Full extension drawers - locking
- Full modesty back
- Outfeed hole standard in back of credenza
- Soft close suspension drawer(s)
- Standard metal grommet matches pull finish
- Standard Silver Feet (optional White, Black)
- Wire management channel standard

- Unit not designed for open plan use. Select OPB for Open Plan application

**NOTES**

- P40W and P40M are not available in 66" width

[CLICK HERE TO VIEW PRODUCT INDEX](#)

**1 SELECT A STYLE**

DIMENSIONS		STYLE NUMBER	LIST PRICE	STYLE NUMBER	LIST PRICE	STYLE NUMBER	LIST PRICE
W" x D" x H"	WGT	"W" Veneer Veneer Top Veneer Chassis		"G" HPL High Pressure Laminate Top Veneer Chassis		"M" TFL Thermally Fused Laminate Top Thermally Fused Laminate Chassis	
<b>Left Pedestal</b>							
72 x 22/48 x 29	250	NSS7248CA813W	3255	NSS7248CA813G	3255	NSS7248CA813M	1796
66 x 22/48 x 29	225	NSS6648CA813W	3225	NSS6648CA813G	3225	NSS6648CA813M	1731
<b>Right Pedestal</b>							
72 x 22/48 x 29	250	NSS7248CA814W	3255	NSS7248CA814G	3255	NSS7248CA814M	1796
66 x 22/48 x 29	225	NSS6648CA814W	3225	NSS6648CA814G	3225	NSS6648CA814M	1731

**2 SELECT A FINISH**

"W" Veneer	"G" HPL	"M" TFL	Finish
WAC	GAC	-	Amber Cherry
WRC	-	-	Caramel Cherry
WIC	GIC	-	Crimson Cherry
WEC	-	-	Ebony Cherry
WHC	GHC	MHC	Honey Cherry
WOC	GOC	MOC	KoKo Cherry
WSC	-	-	Scotch Cherry
WAM	GAM	-	Alabaster Maple
WCM	GCM	-	Clear Maple
WWM	GWM	-	Wheat Maple
WEW	GEW	-	Executive Walnut
WRW	GRW	-	Gray Luster Walnut
WGW	-	MGW	Gunstock Walnut
WJW	-	-	Judicial Walnut
WNW	GNW	-	Natural Walnut
WTW	GTW	MTW	Studio Teak Walnut
WWP	GWL	MWL	Designer White

**METAL FINISHES**

MFB	-	-	Black (Premium Finish)
MFS	-	-	Silver
MFW	-	-	White (Premium Finish)

**3 SELECT AN EDGE**

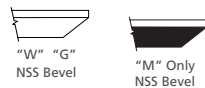

**4 SELECT HARDWARE**

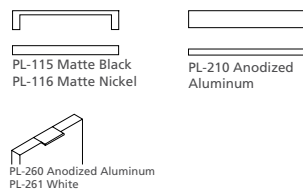

**5 OPTIONS**

**ACCESSORIES**

- K28: Articulating Keyboard w/ Mouse - \$375

**DRAWER**

- P6: Modify File/File to Box/Box/File - \$50 per pedestal
- P33: Wood Drawer Upgrade - \$40 per drawer
- P40W: extra Box/Box/File or File/File to Knee space - \$875
- P40M: extra Box/Box/File or File/File to Knee space - \$688
- WPD3061: Full fill designer white - \$75 per door

**FEET**

- D8: Delete feet (extend fronts to floor) - n/c

**FLUSH CUT**

- FC-L: Flush Unit Left (Facing) for Ganging - \$50
- FC-R: Flush Unit Right(Facing) for Ganging - \$50

**GROMMETS (NON-STANDARD LOCATION)**

- Provide drawing w/ Grommet Location and Specify Color - \$90 ea.
- Black: TM30-NS
- Silver: TM31-NS
- White: TM34-NS

**MODESTY**

- M34T: "W" "G" Style Drop Door Tech Modesty - \$125
- M34TM: "M" Style Drop Door Tech Modesty - \$125
- M51: Open Back Modesty with Wire Mgmt Rail - Deduct \$95

**OPEN PLAN**

- OPB: "W" "G" Style - Modify Unit for Open Plan Application - \$195

**PREMIUM FINISH OPTION**

- MFB: Black metal finish - \$25 per foot
- MFW: White metal finish - \$25 per foot

Left Pedestal

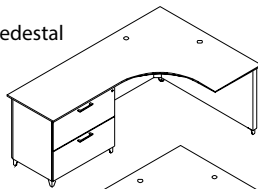

Right Pedestal

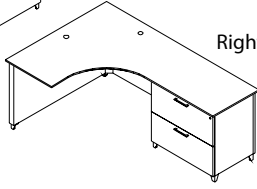

**LATERAL FILE**

**STANDARD FEATURES**

- Full modesty back
- Full extension drawers - locking
- Outfeed hole standard in back of credenza
- Soft close suspension drawer(s)
- Standard metal grommet matches pull finish
- Standard Silver Feet (optional White, Black)
- Wire management channel standard

**File units**

- Unit not designed for open plan use. Select OPB for Open Plan application

**NOTES**

- (\*) Keyboard not available on 66"W Lateral

[CLICK HERE TO VIEW PRODUCT INDEX](#)

**1 SELECT A STYLE**

DIMENSIONS		STYLE NUMBER	LIST PRICE	STYLE NUMBER	LIST PRICE	STYLE NUMBER	LIST PRICE
W" x D" x H"	WGT	"W" Veneer Veneer Top Veneer Chassis		"G" HPL High Pressure Laminate Top Veneer Chassis		"M" TFL Thermally Fused Laminate Top Thermally Fused Laminate Chassis	
<b>Left Pedestal</b>							
72 x 22/48 x 29	310	NSS7248CA815W	3385	NSS7248CA815G	3385	NSS7248CA815M	1955
*66 x 22/48 x 29	290	NSS6648CA815W	3350	NSS6648CA815G	3350	NSS6648CA815M	1894
<b>Right Pedestal</b>							
72 x 22/48 x 29	310	NSS7248CA816W	3385	NSS7248CA816G	3385	NSS7248CA816M	1955
*66 x 22/48 x 29	290	NSS6648CA816W	3350	NSS6648CA816G	3350	NSS6648CA816M	1894

**2 SELECT A FINISH**

"W" Veneer	"G" HPL	"M" TFL	
WAC	GAC	-	Amber Cherry
WRC	-	-	Caramel Cherry
WIC	GIC	-	Crimson Cherry
WEC	-	-	Ebony Cherry
WHC	GHC	MHC	Honey Cherry
WOC	GOC	MOC	KoKo Cherry
WSC	-	-	Scotch Cherry
WAM	GAM	-	Alabaster Maple
WCM	GCM	-	Clear Maple
WWM	GWM	-	Wheat Maple
WEW	GEW	-	Executive Walnut
WRW	GRW	-	Gray Luster Walnut
WGW	-	MGW	Gunstock Walnut
WJW	-	-	Judicial Walnut
WNW	GNW	-	Natural Walnut
WTW	GTW	MTW	Studio Teak Walnut
WWP	GWL	MWL	Designer White
<b>METAL FINISHES</b>			
MFB	-	-	Black (Premium Finish)
MFS	-	-	Silver
MFW	-	-	White (Premium Finish)

**3 SELECT AN EDGE**



**4 SELECT HARDWARE**

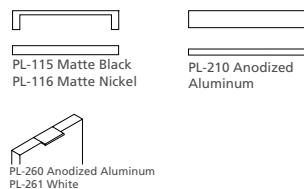

**5 OPTIONS**

**ACCESSORIES**

- K28: Articulating Keyboard w/ Mouse - \$375

**DRAWER**

- P33: Wood Drawer Upgrade - \$40 per drawer
- WPD3061: Full fill designer white - \$75 per door

**FEET**

- D8: Delete feet (extend fronts to floor) - n/c

**FLUSH CUT**

- FC-L: Flush Unit Left (Facing) for Ganging - \$50
- FC-R: Flush Unit Right(Facing) for Ganging - \$50

**GROMMETS (NON-STANDARD LOCATION)**

- Provide drawing w/ Grommet Location and Specify Color - \$90 ea.
- Black: TM30-NS
- Silver: TM31-NS
- White: TM34-NS

**MODESTY**

- M34T: "W" "G" Style Drop Door Tech Modesty - \$125
- M34TM: "M" Style Drop Door Tech Modesty - \$125
- M51: Open Back Modesty with Wire Mgmt Rail - Deduct \$95

**OPEN PLAN**

- OPB: "W" "G" Style - Modify Unit for Open Plan Application - \$195

**PREMIUM FINISH OPTION**

- MFB: Black metal finish - \$25 per foot
- MFW: White metal finish - \$25 per foot

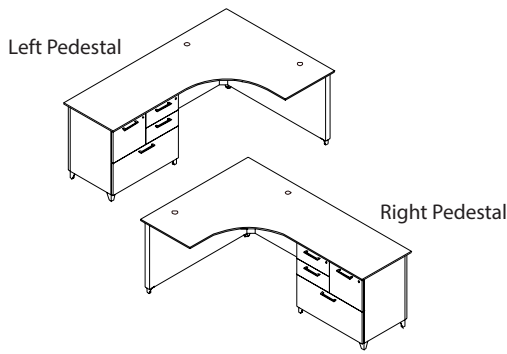

**MULTI-FILE**

**STANDARD FEATURES**

- Full modesty back
- Full extension drawers - locking
- Outfeed hole standard in back of credenza
- Soft close suspension drawer(s)
- Standard Silver Feet (optional White, Black)
- Standard metal grommet matches pull finish
- Wire management channel standard

**Units**

- Multi-file 31W
- Unit not designed for open plan use. Select OPB for Open Plan application

**NOTES**

- (\*) Keyboard not available on 66"W Multi-File

[CLICK HERE TO VIEW PRODUCT INDEX](#)

**1 SELECT A STYLE**

DIMENSIONS		STYLE NUMBER	LIST PRICE	STYLE NUMBER	LIST PRICE	STYLE NUMBER	LIST PRICE
W" x D" x H"	WGT	"W" Veneer Veneer Top Veneer Chassis		"G" HPL High Pressure Laminate Top Veneer Chassis		"M" TFL Thermally Fused Laminate Top Thermally Fused Laminate Chassis	
<b>Left Pedestal</b>							
72 x 22/48 x 29	310	NSS7248CA805W	3460	NSS7248CA805G	3460	NSS7248CA805M	2041
66 x 22/48 x 29	290	NSS6648CA805W	3425	NSS6648CA805G	3425	NSS6648CA805M	1980
<b>Right Pedestal</b>							
72 x 22/48 x 29	310	NSS7248CA806W	3460	NSS7248CA806G	3460	NSS7248CA806M	2041
66 x 22/48 x 29	290	NSS6648CA806W	3425	NSS6648CA806G	3425	NSS6648CA806M	1980

**2 SELECT A FINISH**

"W" Veneer	"G" HPL	"M" TFL	Finish
WAC	GAC	-	Amber Cherry
WRC	-	-	Caramel Cherry
WIC	GIC	-	Crimson Cherry
WEC	-	-	Ebony Cherry
WHC	GHC	MHC	Honey Cherry
WOC	GOC	MOC	KoKo Cherry
WSC	-	-	Scotch Cherry
WAM	GAM	-	Alabaster Maple
WCM	GCM	-	Clear Maple
WWM	GWM	-	Wheat Maple
WEW	GEW	-	Executive Walnut
WRW	GRW	-	Gray Luster Walnut
WGW	-	MGW	Gunstock Walnut
WJW	-	-	Judicial Walnut
WNW	GNW	-	Natural Walnut
WTW	GTW	MTW	Studio Teak Walnut
WWP	GWL	MWL	Designer White

**METAL FINISHES**

MFB	-	-	Black (Premium Finish)
MFS	-	-	Silver
MFW	-	-	White (Premium Finish)

**3 SELECT AN EDGE**

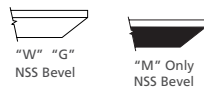

**5 OPTIONS**

- ACCESSORIES**
- K28: Articulating Keyboard w/ Mouse - \$375
- DRAWER**
- P33: Wood Drawer Upgrade - \$40 per drawer
  - WPD3061: Full fill designer white - \$75 per door
- FEET**
- D8: Delete feet (extend fronts to floor) - n/c
- FLUSH CUT**
- FC-L: Flush Unit Left (Facing) for Ganging - \$50
  - FC-R: Flush Unit Right(Facing) for Ganging - \$50
- GROMMETS (NON-STANDARD LOCATION)**
- Provide drawing w/ Grommet Location and Specify Color - \$90 ea.
- Black: TM30-NS
  - Silver: TM31-NS
  - White: TM34-NS
- MODESTY**
- M34T: "W" "G" Style Drop Door Tech Modesty - \$125
  - M51: Open Back Modesty with Wire Mgmt Rail - Deduct \$95
- OPEN PLAN**
- OPB: "W" "G" Style - Modify Unit for Open Plan Application - \$195
  - OPBM: "M" Style - Modify Unit for Open Plan Application - \$95
- PREMIUM FINISH OPTION**
- MFB: Black metal finish - \$25 per foot
  - MFW: White metal finish - \$25 per foot

**4 SELECT HARDWARE**

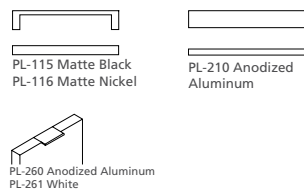

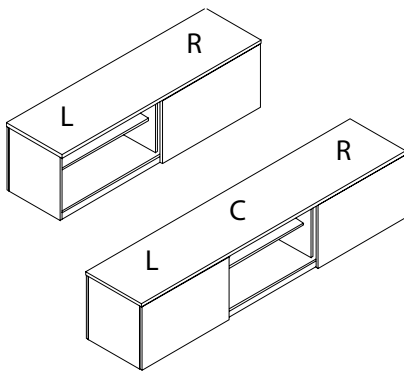

**TWO / THREE SECTION SLIDING DOOR STORAGE**

**STANDARD FEATURES**

- 1 1/8" top with flat edges
- Adjustable Shelves
- Open plan - back
- Standard open storage with shelves

- Unit not designed for open plan use. Select OPB for Open Plan application

**NOTES**

- To use Runoff Desk with Bench Cabinets, order Bench Runoff Support Ends: see Runoff Desk
- Bench Cushion Top factory installed as specified
- Standard without legs

[CLICK HERE TO VIEW PRODUCT INDEX](#)

**1 SELECT A STYLE**

DIMENSIONS		STYLE NUMBER	LIST PRICE	STYLE NUMBER	LIST PRICE	STYLE NUMBER	LIST PRICE
W" x D" x H"	WGT	"W" Veneer Veneer Top Veneer Chassis		"G" HPL High Pressure Laminate Top Veneer Chassis		"M" TFL Thermally Fused Laminate Top Thermally Fused Laminate Chassis	
<b>Three Section</b>							
93.5 x 20 x 23	320	NSS9320CA661W	3435	NSS9320CA661G	3435	NSS9320CA661M	2241
87.5 x 20 x 23	310	NSS8720CA661W	3180	NSS8720CA661G	3180	NSS8720CA661M	2021
<b>Two Section</b>							
70.5 x 20 x 23	235	NSS7020CA661W	2240	NSS7020CA661G	2240	NSS7020CA661M	1682
58.5 x 20 x 23	220	NSS5820CA661W	2140	NSS5820CA661G	2140	NSS5820CA661M	1563

**BC22 Bench Cushion Option Graded Pricing**

COM	COL	1	2	3	4	5	6	7	8	9	10	11/ L1	12	13/ L2
240	270	300	320	340	360	380	400	420	440	460	480	500	520	560

**2 SELECT A FINISH**      **3 SELECT AN EDGE**      **5 OPTIONS**

"W" Veneer	"G" HPL	"M" TFL	Finish
WAC	GAC	-	Amber Cherry
WRC	-	-	Caramel Cherry
WIC	GIC	-	Crimson Cherry
WEC	-	-	Ebony Cherry
WHC	GHC	MHC	Honey Cherry
WOC	GOC	MOC	KoKo Cherry
WSC	-	-	Scotch Cherry
WAM	GAM	-	Alabaster Maple
WCM	GCM	-	Clear Maple
WWM	GWM	-	Wheat Maple
WEW	GEW	-	Executive Walnut
WRW	GRW	-	Gray Luster Walnut
WGW	-	MGW	Gunstock Walnut
WJW	-	-	Judicial Walnut
WNW	GNW	-	Natural Walnut
WTW	GTW	MTW	Studio Teak Walnut
WWP	GWL	MWL	Designer White



Hardware Option Not Available

**4 SELECT HARDWARE**

- DRAWER**  
- WPD3061: Full fill designer white - \$75 per door
- CUSHION**  
- Specify location, number of cushions and fabric grade.  
- Cushions sold individually w/a max width 35" (to match storage section depth) (See graded pricing)  
- BC22: Bench Cushion
- FEET**  
- MTL50: Metal Feet (4) - \$195
- GROMMETS (STANDARD LOCATION)**  
Specify Color and Location (Right/Left/Center) - \$45 ea.  
- Black: TM30-R (Right), TM30-L (Left), TM30-C (Center)  
- Silver: TM31-R (Right), TM31-L (Left), TM31-C (Center)  
- White: TM34-R (Right), TM34-L (Left), TM34-C (Center)
- GROMMETS (NON-STANDARD LOCATION)**  
Provide drawing w/ Grommet Location and Specify Color - \$90 ea.  
- Black: TM30-NS  
- Silver: TM31-NS  
- White: TM34-NS
- GROMMETS (VERTICAL SURFACE)**  
- TM50: Black grommet in back panel - \$45
- SHELF**  
- S714F: Heavy Duty Lumber 1" Shelves - \$75 per Shelf ("M" Styles - n/a)

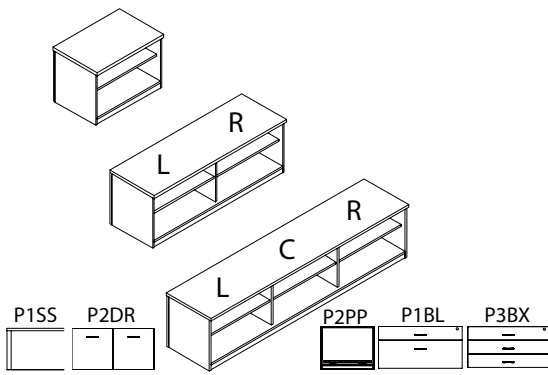

ONE / TWO / THREE SECTION STORAGE

STANDARD FEATURES

- 1 1/8" top with flat edges
- Open plan - back
- Standard open storage with shelves

options below

- Unit not designed for open plan use. Select OPB for Open Plan application

NOTES

- To use Runoff Desk with Bench Cabinets, order Bench Runoff Support Ends: see Runoff Desk
- Bench Cushion Top factory installed as specified
- Standard without legs
- For drawers, storage and printer cabinets select

[CLICK HERE TO VIEW PRODUCT INDEX](#)

1 SELECT A STYLE

DIMENSIONS		STYLE NUMBER	LIST PRICE	STYLE NUMBER	LIST PRICE	STYLE NUMBER	LIST PRICE
W" x D" x H"	WGT	"W" Veneer Veneer Top Veneer Chassis		"G" HPL High Pressure Laminate Top Veneer Chassis		"M" TFL Thermally Fused Laminate Top Thermally Fused Laminate Chassis	
<b>Three Section</b>							
93.5 x 20 x 23	300	NSS9320CA063W	3145	NSS9320CA063G	3145	NSS9320CA063M	2050
87.5 x 20 x 23	290	NSS8720CA063W	2910	NSS8720CA063G	2910	NSS8720CA063M	1849
<b>Two Section</b>							
70.5 x 20 x 23	225	NSS7020CA063W	2080	NSS7020CA063G	2080	NSS7020CA063M	1543
58.5 x 20 x 23	210	NSS5820CA063W	1960	NSS5820CA063G	1960	NSS5820CA063M	1433
<b>One Section</b>							
35.5 x 20 x 23	95	NSS3520CA063W	1095	NSS3520CA063G	1095	NSS3520CA063M	631
29.5 x 20 x 23	90	NSS2920CA063W	1065	NSS2920CA063G	1065	NSS2920CA063M	603

BC22 Bench Cushion Option Graded Pricing

COM	COL	1	2	3	4	5	6	7	8	9	10	11/ L1	12	13/ L2
240	270	300	320	340	360	380	400	420	440	460	480	500	520	560

2 SELECT A FINISH      3 SELECT AN EDGE      5 OPTIONS

"W" Veneer	"G" HPL	"M" TFL	Finish
WAC	GAC	-	Amber Cherry
WRC	-	-	Caramel Cherry
WIC	GIC	-	Crimson Cherry
WEC	-	-	Ebony Cherry
WHC	GHC	MHC	Honey Cherry
WOC	GOC	MOC	KoKo Cherry
WSC	-	-	Scotch Cherry
WAM	GAM	-	Alabaster Maple
WCM	GCM	-	Clear Maple
WWM	GWM	-	Wheat Maple
WEW	GEW	-	Executive Walnut
WRW	GRW	-	Gray Luster Walnut
WGW	-	MGW	Gunstock Walnut
WJW	-	-	Judicial Walnut
WNW	GNW	-	Natural Walnut
WTW	GTW	MTW	Studio Teak Walnut
WWP	GWL	MWL	Designer White



4 SELECT HARDWARE

Hardware Option Not Available

- CABINET**
- P1SS: Delete Cabinet for stool storage- Deduct \$75
  - P1BL - Box/Lateral File - \$300
  - P2DR: Storage Door - \$175
  - P2PP: Open Printer Pullout - \$225
  - P3BX: Three Box Drawers - \$300
- CUSHION**
- Specify location, number of cushions and fabric grade.
  - Cushions sold individually w/a max width 35" (to match storage section depth) (See graded pricing)
  - BC22: Bench Cushion
- FEET**
- MTL50: 4 Silver Feet - \$195
- GROMMETS (STANDARD LOCATION)**
- Specify Color and Location (Right/Left/Center) - \$45 ea.
- Black: TM30-R (Right), TM30-L (Left), TM30-C (Center)
  - Silver: TM31-R (Right), TM31-L (Left), TM31-C (Center)
  - White: TM34-R (Right), TM34-L (Left), TM34-C (Center)
- GROMMETS (NON-STANDARD LOCATION)**
- Provide drawing w/ Grommet Location and Specify Color - \$90 ea.
- Black: TM30-NS
  - Silver: TM31-NS
  - White: TM34-NS
- GROMMETS (VERTICAL SURFACE)**
- Standard Location - \$45 ea.
- Black Plastic Vertical Surface: TM50-C (Bottom Center)
- Non-Standard Location - \$90 ea.
- Black Plastic Vertical Surface: TM50-NS
- SHELF**
- S714F: Heavy Duty Lumber 1" Shelves - \$75 per Shelf ("M" Styles - n/a)



Box/Box/File  
PD424

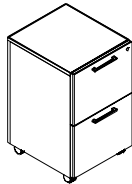

File/File  
PD425

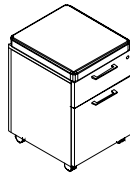

Box/File W/BC18  
Cushion Option  
PD423

MOBILE PEDESTAL - UNDER SURFACE

STANDARD FEATURES

- Anti-tip safety feature
- For open plan use under surfaces
- Full extension drawers - locking
- Soft close suspension drawer(s)

NOTES

- Pedestal Cushion can be specified on all pedestals, but on Box/ Box/ File and File/File unit will not fit under work surface w/ cushion.

[CLICK HERE TO VIEW PRODUCT INDEX](#)

1 SELECT A STYLE

DIMENSIONS		STYLE NUMBER	LIST PRICE	STYLE NUMBER	LIST PRICE	STYLE NUMBER	LIST PRICE
W" x D" x H"	WGT	"W" Veneer Veneer Top Veneer Chassis		"G" HPL High Pressure Laminate Top Veneer Chassis		"M" TFL Thermally Fused Laminate Top Thermally Fused Laminate Chassis	
<b>Box/Box/File</b>							
16 x 18 x 27	90	NSS1618PD424W	1040	"G" Style N/A		NSS1618PD424M	910
<b>File/File</b>							
16 x 18 x 27	90	NSS1618PD425W	1040	"G" Style N/A		NSS1618PD425M	910
<b>BOX/FILE</b>							
16 x 18 x 27	90	NSS1618PD423W	960	"G" Style N/A		NSS1618PD423M	840

BC16 Bench Cushion Option Graded Pricing

COM	COL	1	2	3	4	5	6	7	8	9	10	11/ L1	12	13/ L2
190	210	235	250	265	280	295	310	325	340	355	370	385	400	430

2 SELECT A FINISH      3 SELECT AN EDGE      5 OPTIONS

"W" Veneer	"G" HPL	"M" TFL	
WAC	-	-	Amber Cherry
WRC	-	-	Caramel Cherry
WIC	-	-	Crimson Cherry
WEC	-	-	Ebony Cherry
WHC	-	MHC	Honey Cherry
WOC	-	MOC	KoKo Cherry
WSC	-	-	Scotch Cherry
WAM	-	-	Alabaster Maple
WCM	-	-	Clear Maple
WWM	-	-	Wheat Maple
WEW	-	-	Executive Walnut
WRW	GRW	-	Gray Luster Walnut
WGW	-	MGW	Gunstock Walnut
WJW	-	-	Judicial Walnut
WNW	-	-	Natural Walnut
WTW	-	MTW	Studio Teak Walnut
WWP	-	MWL	Designer White

  

METAL FINISHES	
MFB	- - Black (Premium Finish)
MFS	- - Silver
MFW	- - White (Premium Finish)

Edge Profile  
Option Not Available

- CUSHION**
- Specify location, number of cushions and fabric grade.
  - Cushions sold individually w/a max width 35" (to match storage section depth) (See graded pricing)
  - BC16: Bench Cushion
- DRAWER**
- P33: Wood Drawer Upgrade - \$40 per drawer
  - WPD3061: Full fill designer white - \$75 per pedestal
- PREMIUM FINISH OPTION**
- MFB: Black metal finish - \$25 per foot
  - MFW: White metal finish - \$25 per foot

4 SELECT HARDWARE

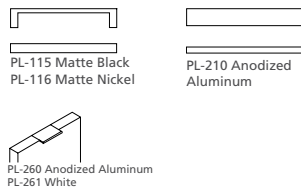

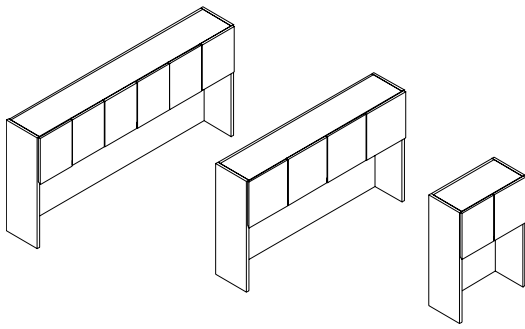

PANEL DOOR - 6/4/2 DOOR

STANDARD FEATURES

- Finished top
- Interior cabinet depth 12.5"
- Panel doors with concealed finger pull
- Tasklight grommet hole standard in top back panel (2 in 87" and 93" units)

NOTES

- Unit has black back panel and is not designed for Open Plan use. Select OPB Option for Open Plan application

[CLICK HERE TO VIEW PRODUCT INDEX](#)

**1** SELECT A STYLE

DIMENSIONS		STYLE NUMBER	LIST PRICE	STYLE NUMBER	LIST PRICE	STYLE NUMBER	LIST PRICE
W" x D" x H"	WGT	"W" Veneer Veneer Top Veneer Chassis		"G" HPL High Pressure Laminate Top Veneer Chassis		"M" TFL Thermally Fused Laminate Top Thermally Fused Laminate Chassis	
<b>6 Door / 3 Section</b>							
93 x 14 x 42	315	NSS9342OH325W	3185	"G" Style N/A		NSS9342OH325M	2125
87 x 14 x 42	285	NSS8742OH325W	3070	"G" Style N/A		NSS8742OH325M	2008
<b>4 Door / 2 Section</b>							
83 x 14 x 42	275	NSS8342OH325W	2790	"G" Style N/A		NSS8342OH325M	1634
76 x 14 x 42	255	NSS7642OH325W	2600	"G" Style N/A		NSS7642OH325M	1571
70 x 14 x 42	240	NSS7042OH325W	2410	"G" Style N/A		NSS7042OH325M	1342
64 x 14 x 42	225	NSS6442OH325W	2350	"G" Style N/A		NSS6442OH325M	1284
58 x 14 x 42	210	NSS5842OH325W	2290	"G" Style N/A		NSS5842OH325M	1234
47 x 14 x 42	190	NSS4742OH325W	2170	"G" Style N/A		NSS4742OH325M	1125
<b>2 Door / 1 Section</b>							
35 x 14 x 42	120	NSS3542OH325W	1420	"G" Style N/A		NSS3542OH325M	722
29 x 14 x 42	105	NSS2942OH325W	1380	"G" Style N/A		NSS2942OH325M	686

**2** SELECT A FINISH

"W" Veneer	"G" HPL	"M" TFL	
WAC	-	-	Amber Cherry
WRC	-	-	Caramel Cherry
WIC	-	-	Crimson Cherry
WEC	-	-	Ebony Cherry
WHC	-	MHC	Honey Cherry
WOC	-	MOC	KoKo Cherry
WSC	-	-	Scotch Cherry
WAM	-	-	Alabaster Maple
WCM	-	-	Clear Maple
WWM	-	-	Wheat Maple
WEW	-	-	Executive Walnut
WRW	GRW	-	Gray Luster Walnut
WGW	-	MGW	Gunstock Walnut
WJW	-	-	Judicial Walnut
WNV	-	-	Natural Walnut
WTW	-	MTW	Studio Teak Walnut
WWP	-	MWL	Designer White

**3** SELECT AN EDGE

Edge Profile  
Option Not Available

**4** SELECT HARDWARE

Hardware  
Option Not Available

**5** OPTIONS

DOOR

- D2: Door Lock - \$95 per Door Set
- D6: Delete Doors - n/c
- D9SC: Soft Close Door Hinges - \$15 per Door
- WPD3061: Full fill designer white - \$75 per door

GROMMETS (VERTICAL SURFACE)

- Standard Location - \$45 ea.
- Black Plastic Vertical Surface: TM50-C (Bottom Center)
- Non-Standard Location - \$90 ea.
- Black Plastic Vertical Surface: TM50-NS

INTERIOR CABINET LIGHTING

- LEDPK starter kit includes Infeed, 1 Puck Interior Light and the ability to daisy chain up to 6 total Puck Lights
- LED Puck Starter Kit - \$295
- PK: 1 LED Interior Light - \$125

TASK LIGHTING

- LT-LED24: 24" LED Tasklight - \$90
- LT-LED48: 48" LED Tasklight - \$165
- LT-LED60: 60" LED Tasklight - \$180
- LC22: 20" LT-LED Tasklight Linking Cable - \$20

OPEN PLAN

- OPB: "W" "G" Style - Modify Unit for Open Plan Application - \$295
- OPBM: "M" Style - Modify Unit for Open Plan Application - \$95

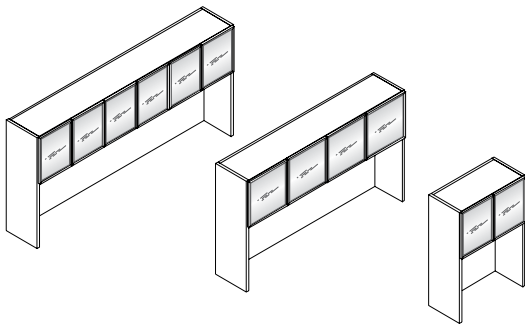

SILVERLUMA FRAME DOORS / 6/4/2 DOOR

STANDARD FEATURES

- Finished top
- Interior cabinet depth 12.5"
- SilverLuma frame doors with frosted acrylic inserts
- Tasklight grommet hole standard in top back panel (2 in 87" and 93" units)

Plan application

NOTES

- Unit has black back panel and is not designed for Open Plan use. Select OPB Option for Open

[CLICK HERE TO VIEW PRODUCT INDEX](#)

1 SELECT A STYLE

DIMENSIONS		STYLE NUMBER	LIST PRICE	STYLE NUMBER	LIST PRICE	STYLE NUMBER	LIST PRICE
W" x D" x H"	WGT	"W" Veneer Veneer Top Veneer Chassis		"G" HPL High Pressure Laminate Top Veneer Chassis		"M" TFL Thermally Fused Laminate Top Thermally Fused Laminate Chassis	
<b>6 Door / 3 Section</b>							
93 x 14 x 42	315	NSS9342OH321W	3575	"G" Style N/A		NSS9342OH321M	2455
87 x 14 x 42	285	NSS8742OH321W	3485	"G" Style N/A		NSS8742OH321M	2338
<b>4 Door / 2 Section</b>							
83 x 14 x 42	275	NSS8342OH321W	3440	"G" Style N/A		NSS8342OH321M	1852
76 x 14 x 42	255	NSS7642OH321W	2990	"G" Style N/A		NSS7642OH321M	1790
70 x 14 x 42	240	NSS7042OH321W	2780	"G" Style N/A		NSS7042OH321M	1562
64 x 14 x 42	225	NSS6442OH321W	2670	"G" Style N/A		NSS6442OH321M	1504
58 x 14 x 42	210	NSS5842OH321W	2600	"G" Style N/A		NSS5842OH321M	1454
47 x 14 x 42	190	NSS4742OH321W	2505	"G" Style N/A		NSS4742OH321M	1345
<b>2 Door / 1 Section</b>							
35 x 14 x 42	120	NSS3542OH321W	1610	"G" Style N/A		NSS3542OH321M	832
29 x 14 x 42	105	NSS2942OH321W	1515	"G" Style N/A		NSS2942OH321M	796

2 SELECT A FINISH

"W" Veneer	"G" HPL	"M" TFL	
WAC	-	-	Amber Cherry
WRC	-	-	Caramel Cherry
WIC	-	-	Crimson Cherry
WEC	-	-	Ebony Cherry
WHC	-	MHC	Honey Cherry
WOC	-	MOC	KoKo Cherry
WSC	-	-	Scotch Cherry
WAM	-	-	Alabaster Maple
WCM	-	-	Clear Maple
WWM	-	-	Wheat Maple
WEW	-	-	Executive Walnut
WRW	GRW	-	Gray Luster Walnut
WGW	-	MGW	Gunstock Walnut
WJW	-	-	Judicial Walnut
WNW	-	-	Natural Walnut
WTW	-	MTW	Studio Teak Walnut
WWP	-	MWL	Designer White

3 SELECT AN EDGE

Edge Profile  
Option Not Available

5 OPTIONS

DOOR

- D2: Door Lock - \$95 per Door Set
- D6: Delete Doors - n/c
- D9SC: Soft Close Door Hinges - \$15 per Door
- WPD3061: Full fill designer white - \$75 per door

GROMMETS (VERTICAL SURFACE)

- Standard Location - \$45 ea.
- Black Plastic Vertical Surface: TM50-C (Bottom Center)
- Non-Standard Location - \$90 ea.
- Black Plastic Vertical Surface: TM50-NS

INTERIOR CABINET LIGHTING

- LEDPK starter kit includes Infeed, 1 Puck Interior Light and the ability to daisy chain up to 6 total Puck Lights
- LED Puck Starter Kit - \$295
- PK: 1 LED Interior Light - \$125

TASK LIGHTING

- LT-LED24: 24" LED Tasklight - \$90
- LT-LED48: 48" LED Tasklight - \$165
- LT-LED60: 60" LED Tasklight - \$180
- LC22: 20" LT-LED Tasklight Linking Cable - \$20

OPEN PLAN

- OPB: "W" "G" Style - Modify Unit for Open Plan Application - \$295
- OPBM: "M" Style - Modify Unit for Open Plan Application - \$95

4 SELECT HARDWARE

Hardware  
Option Not Available



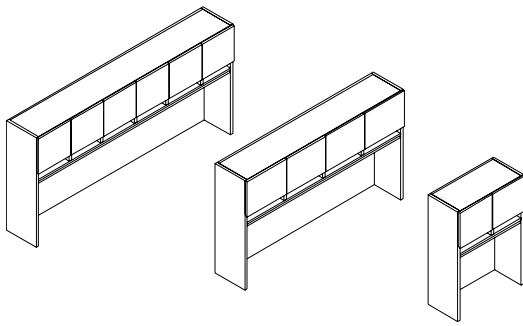

PANEL DOOR / PAPER ORGANIZER - 6/4/2 DOOR

STANDARD FEATURES

- Finished top
- Interior cabinet depth 12.5"
- Panel doors with concealed finger pull
- Tasklight grommet hole standard in top back panel (2 in 87" and 93" units)

- Unit has black back panel and is not designed for Open Plan use. Select OPB Option for Open Plan application

NOTES

- Paper organizer reduces interior clearance to 12"H x 11 - 1/4"D
- Paper slots are 3" H

[CLICK HERE TO VIEW PRODUCT INDEX](#)

1 SELECT A STYLE

DIMENSIONS		STYLE NUMBER	LIST PRICE	STYLE NUMBER	LIST PRICE	STYLE NUMBER	LIST PRICE
W" x D" x H"	WGT	"W" Veneer Veneer Top Veneer Chassis		"G" HPL High Pressure Laminate Top Veneer Chassis		"M" TFL Thermally Fused Laminate Top Thermally Fused Laminate Chassis	
<b>6 Door / 3 Section</b>							
93 x 14 x 42	315	NSS9342OH326W	3665	"G" Style N/A		NSS9342OH326M	2492
87 x 14 x 42	285	NSS8742OH326W	3530	"G" Style N/A		NSS8742OH326M	2374
<b>4 Door / 2 Section</b>							
83 x 14 x 42	275	NSS8342OH326W	3210	"G" Style N/A		NSS8342OH326M	1862
76 x 14 x 42	255	NSS7642OH326W	2990	"G" Style N/A		NSS7642OH326M	1799
70 x 14 x 42	240	NSS7042OH326W	2770	"G" Style N/A		NSS7042OH326M	1572
64 x 14 x 42	225	NSS6442OH326W	2705	"G" Style N/A		NSS6442OH326M	1513
58 x 14 x 42	210	NSS5842OH326W	2635	"G" Style N/A		NSS5842OH326M	1463
47 x 14 x 42	190	NSS4742OH326W	2495	"G" Style N/A		NSS4742OH326M	1354
<b>2 Door / 1 Section</b>							
35 x 14 x 42	120	NSS3542OH326W	1635	"G" Style N/A		NSS3542OH326M	836
29 x 14 x 42	105	NSS2942OH326W	1590	"G" Style N/A		NSS2942OH326M	801

2 SELECT A FINISH

"W" Veneer	"G" HPL	"M" TFL	Finish
WAC	-	-	Amber Cherry
WRC	-	-	Caramel Cherry
WIC	-	-	Crimson Cherry
WEC	-	-	Ebony Cherry
WHC	-	MHC	Honey Cherry
WOC	-	MOC	KoKo Cherry
WSC	-	-	Scotch Cherry
WAM	-	-	Alabaster Maple
WCM	-	-	Clear Maple
WWM	-	-	Wheat Maple
WEW	-	-	Executive Walnut
WRW	GRW	-	Gray Luster Walnut
WGW	-	MGW	Gunstock Walnut
WJW	-	-	Judicial Walnut
WNW	-	-	Natural Walnut
WTW	-	MTW	Studio Teak Walnut
WWP	-	MWL	Designer White

3 SELECT AN EDGE

Edge Profile  
Option Not Available

4 SELECT HARDWARE

Hardware  
Option Not Available

5 OPTIONS

DOOR

- D2: Door Lock - \$95 per Door Set
- D6: Delete Doors - n/c
- D9SC: Soft Close Door Hinges - \$15 per Door
- WPD3061: Full fill designer white - \$75 per door

GROMMETS (VERTICAL SURFACE)

- Standard Location - \$45 ea.
- Black Plastic Vertical Surface: TM50-C (Bottom Center)
- Non-Standard Location - \$90 ea.
- Black Plastic Vertical Surface: TM50-NS

INTERIOR CABINET LIGHTING

- LEDPK starter kit includes Infeed, 1 Puck Interior Light and the ability to daisy chain up to 6 total Puck Lights
- LED Puck Starter Kit - \$295
- PK: 1 LED Interior Light - \$125

TASK LIGHTING

- LT-LED24: 24" LED Tasklight - \$90
- LT-LED48: 48" LED Tasklight - \$165
- LT-LED60: 60" LED Tasklight - \$180
- LC22: 20" LT-LED Tasklight Linking Cable - \$20

OPEN PLAN

- OPB: "W" "G" Style - Modify Unit for Open Plan Application - \$295
- OPBM: "M" Style - Modify Unit for Open Plan Application - \$95

SINGLE STORAGE OVERHEAD CONSOLES

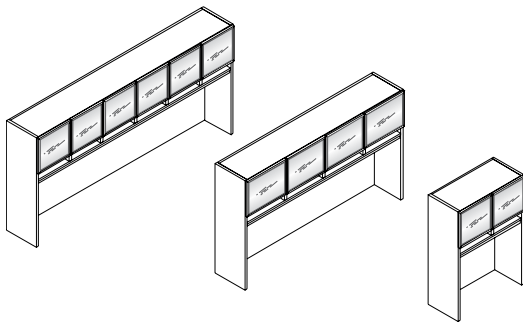

SILVERLUMA FRAME DOORS / PAPER ORGANIZER - 6/4/2 DOOR

STANDARD FEATURES

- Finished top
- Interior cabinet depth 12.5"
- SilverLuma frame doors with frosted acrylic inserts
- Tasklight grommet hole standard in top back panel

- Paper slots are 3" H

- Unit has black back panel and is not designed for Open Plan use. Select OPB Option for Open Plan application

NOTES

- Paper organizer reduces interior clearance to 12"H x 11 - 1/4"D

[CLICK HERE TO VIEW PRODUCT INDEX](#)

1 SELECT A STYLE

DIMENSIONS		STYLE NUMBER	LIST PRICE	STYLE NUMBER	LIST PRICE	STYLE NUMBER	LIST PRICE
W" x D" x H"	WGT	"W" Veneer Veneer Top Veneer Chassis		"G" HPL High Pressure Laminate Top Veneer Chassis		"M" TFL Thermally Fused Laminate Top Thermally Fused Laminate Chassis	
<b>6 Door / 3 Section</b>							
93 x 14 x 42	315	NSS9342OH322W	4111	"G" Style N/A		NSS9342OH322M	2822
87 x 14 x 42	285	NSS8742OH322W	4008	"G" Style N/A		NSS8742OH322M	2704
<b>4 Door / 2 Section</b>							
83 x 14 x 42	275	NSS8342OH322W	3646	"G" Style N/A		NSS8342OH322M	2082
76 x 14 x 42	255	NSS7642OH322W	3439	"G" Style N/A		NSS7642OH322M	2019
70 x 14 x 42	240	NSS7042OH322W	3197	"G" Style N/A		NSS7042OH322M	1791
64 x 14 x 42	225	NSS6442OH322W	3071	"G" Style N/A		NSS6442OH322M	1733
58 x 14 x 42	210	NSS5842OH322W	2990	"G" Style N/A		NSS5842OH322M	1683
47 x 14 x 42	190	NSS4742OH322W	2881	"G" Style N/A		NSS4742OH322M	1574
<b>2 Door / 1 Section</b>							
35 x 14 x 42	120	NSS3542OH322W	1852	"G" Style N/A		NSS3542OH322M	946
29 x 14 x 42	105	NSS2942OH322W	1742	"G" Style N/A		NSS2942OH322M	910

2 SELECT A FINISH

"W" Veneer	"G" HPL	"M" TFL	Finish
WAC	-	-	Amber Cherry
WRC	-	-	Caramel Cherry
WIC	-	-	Crimson Cherry
WEC	-	-	Ebony Cherry
WHC	-	MHC	Honey Cherry
WOC	-	MOC	KoKo Cherry
WSC	-	-	Scotch Cherry
WAM	-	-	Alabaster Maple
WCM	-	-	Clear Maple
WWM	-	-	Wheat Maple
WEW	-	-	Executive Walnut
WRW	GRW	-	Gray Luster Walnut
WGW	-	MGW	Gunstock Walnut
WJW	-	-	Judicial Walnut
WNV	-	-	Natural Walnut
WTW	-	MTW	Studio Teak Walnut
WWP	-	MWL	Designer White

3 SELECT AN EDGE

Edge Profile  
Option Not Available

5 OPTIONS

DOOR

- D2: Door Lock - \$95 per pair door
- D6: Delete Doors - n/c
- D9SC: Soft Close Door Hinges - \$15 per Door
- WPD3061: Full fill designer white - \$75 per door

GROMMETS (VERTICAL SURFACE)

- Standard Location - \$45 ea.
- Black Plastic Vertical Surface: TM50-C (Bottom Center)
- Non-Standard Location - \$90 ea.
- Black Plastic Vertical Surface: TM50-NS

INTERIOR CABINET LIGHTING

- LEDPK starter kit includes Infeed, 1 Puck Interior Light and the ability to daisy chain up to 6 total Puck Lights
- LED Puck Starter Kit - \$295
- PK: 1 LED Interior Light - \$125

TASK LIGHTING

- LT-LED24: 24" LED Tasklight - \$90
- LT-LED48: 48" LED Tasklight - \$165
- LT-LED60: 60" LED Tasklight - \$180
- LC22: 20" LT-LED Tasklight Linking Cable - \$20

OPEN PLAN

- OPB: "W" "G" Style - Modify Unit for Open Plan Application - \$295
- OPBM: "M" Style - Modify Unit for Open Plan Application - \$95

4 SELECT HARDWARE

Hardware  
Option Not Available

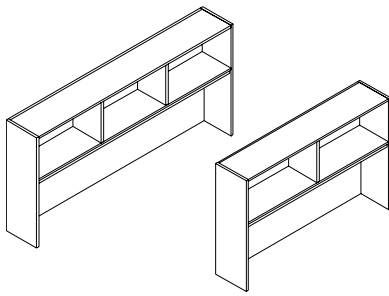

**OPEN STORAGE CONSOLE**

**STANDARD FEATURES**

- Finished top
- Interior cabinet depth 12.5"
- Tasklight grommet hole standard in top back panel

Plan application

**NOTES**

- 1 or 2 optional door available
- Sliding Doors Will Not Pass Each Other
- Unit has black back panel and is not designed for Open Plan use. Select OPB Option for Open

[CLICK HERE TO VIEW PRODUCT INDEX](#)

**1 SELECT A STYLE**

DIMENSIONS		STYLE NUMBER	LIST PRICE	STYLE NUMBER	LIST PRICE	STYLE NUMBER	LIST PRICE
W" x D" x H"	WGT	"W" Veneer Top Veneer Chassis		"G" High Pressure Laminate Top Veneer Chassis		"M" Thermally Fused Laminate Top Thermally Fused Laminate Chassis	
<b>3 Section</b>							
93 x 14 x 42	310	NSS9342OH346W	2910	"G" Style N/A		NSS9342OH346M	1846
87 x 14 x 42	280	NSS8742OH346W	2880	"G" Style N/A		NSS8742OH346M	1729
83 x 14 x 42	265	NSS8342OH346W	2855	"G" Style N/A		NSS8342OH346M	1350
76 x 14 x 42	250	NSS7642OH346W	2460	"G" Style N/A		NSS7642OH346M	1291
<b>2 Section</b>							
70 x 14 x 42	240	NSS7042OH346W	2270	"G" Style N/A		NSS7042OH346M	1159
64 x 14 x 42	225	NSS6442OH346W	2215	"G" Style N/A		NSS6442OH346M	1101
58 x 14 x 42	205	NSS5842OH346W	2180	"G" Style N/A		NSS5842OH346M	1047

**2 SELECT A FINISH**

"W" Veneer	"G" HPL	"M" TFL	Finish
WAC	-	-	Amber Cherry
WRC	-	-	Caramel Cherry
WIC	-	-	Crimson Cherry
WEC	-	-	Ebony Cherry
WHC	-	MHC	Honey Cherry
WOC	-	MOC	KoKo Cherry
WSC	-	-	Scotch Cherry
WAM	-	-	Alabaster Maple
WCM	-	-	Clear Maple
WWM	-	-	Wheat Maple
WEW	-	-	Executive Walnut
WRW	GRW	-	Gray Luster Walnut
WGW	-	MGW	Gunstock Walnut
WJW	-	-	Judicial Walnut
WNV	-	-	Natural Walnut
WTW	-	MTW	Studio Teak Walnut
WWP	-	MWL	Designer White

**3 SELECT AN EDGE**

Edge Profile  
Option Not Available

**5 OPTIONS**

**GROMMETS (VERTICAL SURFACE)**

- Standard Location - \$45 ea.
- Black Plastic Vertical Surface: TM50-C (Bottom Center)
- Non-Standard Location - \$90 ea.
- Black Plastic Vertical Surface: TM50-NS

**INTERIOR CABINET LIGHTING**

- LEDPK starter kit includes Infeed, 1 Puck Interior Light and the ability to daisy chain up to 6 total Puck Lights
- LED Puck Starter Kit - \$295
- PK: 1 LED Interior Light - \$125

**OPEN PLAN**

- OPB: "W" "G" Style - Modify Unit for Open Plan Application - \$295
- OPBM: "M" Style - Modify Unit for Open Plan Application - \$95

**SLIDING DOOR**

- SLD17LD: Laminate Door - \$195 Per Door
- SLD17FD: SilverLuma / Frost Door - \$350 Per Door
- SLD17WD: Wood Door - \$250 Per Door

**TASK LIGHTING**

- LT-LED24: 24" LED Tasklight - \$90
- LT-LED48: 48" LED Tasklight - \$165
- LT-LED60: 60" LED Tasklight - \$180
- LC22: 20" LT-LED Tasklight Linking Cable - \$20

**4 SELECT HARDWARE**

Hardware  
Option Not Available

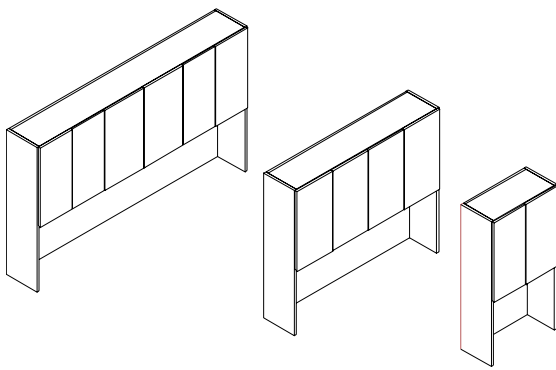

**PANEL DOOR**

**STANDARD FEATURES**

- Finished top
- 1 Adjustable shelf behind each door section
- Interior cabinet depth 12.5"
- Interior shelf depth 12"
- Panel doors with concealed finger pull
- Tasklight grommet hole standard in top back panel (2 in 87" and 93" units)

for Open Plan use. Select OPB Option for Open Plan application.

**NOTES**

- Unit has black back panel and is not designed

[CLICK HERE TO VIEW PRODUCT INDEX](#)

**1 SELECT A STYLE**

DIMENSIONS		STYLE NUMBER	LIST PRICE	STYLE NUMBER	LIST PRICE	STYLE NUMBER	LIST PRICE
W" x D" x H"	WGT	"W" Veneer Veneer Top Veneer Chassis		"G" HPL High Pressure Laminate Top Veneer Chassis		"M" TFL Thermally Fused Laminate Top Thermally Fused Laminate Chassis	
<b>6 Door / 3 Section</b>							
93 x 14 x 54	300	NSS9354OH325W	3620	"G" Style N/A		NSS9354OH325M	2588
87 x 14 x 54	290	NSS8754OH325W	3510	"G" Style N/A		NSS8754OH325M	2488
83 x 14 x 54	280	NSS8354OH325W	3460	"G" Style N/A		NSS8354OH325M	2003
<b>4 Door / 2 Section</b>							
70 x 14 x 54	250	NSS7054OH325W	2945	"G" Style N/A		NSS7054OH325M	1808
64 x 14 x 54	230	NSS6454OH325W	2780	"G" Style N/A		NSS6454OH325M	1746
58 x 14 x 54	215	NSS5854OH325W	2700	"G" Style N/A		NSS5854OH325M	1508
<b>2 Door / 1 Section</b>							
35 x 14 x 54	160	NSS3554OH325W	1658	"G" Style N/A		NSS3554OH325M	985
29 x 14 x 54	150	NSS2954OH325W	1600	"G" Style N/A		NSS2954OH325M	954

**2 SELECT A FINISH**

"W" Veneer	"G" HPL	"M" TFL	
WAC	-	-	Amber Cherry
WRC	-	-	Caramel Cherry
WIC	-	-	Crimson Cherry
WEC	-	-	Ebony Cherry
WHC	-	MHC	Honey Cherry
WOC	-	MOC	KoKo Cherry
WSC	-	-	Scotch Cherry
WAM	-	-	Alabaster Maple
WCM	-	-	Clear Maple
WWM	-	-	Wheat Maple
WEW	-	-	Executive Walnut
WRW	GRW	-	Gray Luster Walnut
WGW	-	MGW	Gunstock Walnut
WJW	-	-	Judicial Walnut
WNW	-	-	Natural Walnut
WTW	-	MTW	Studio Teak Walnut
WWP	-	MWL	Designer White

**3 SELECT AN EDGE**

Edge Profile  
Option Not Available

**4 SELECT HARDWARE**

Hardware  
Option Not Available

**5 OPTIONS**

**DOOR**

- D2: Door Lock - \$95 per Door Set
- D6: Delete Doors - n/c
- D9SC: Soft Close Door Hinges - \$15 per Door
- WPD3061: Full fill designer white - \$75 per door

**GROMMETS (VERTICAL SURFACE)**

- Standard Location - \$45 ea.
- Black Plastic Vertical Surface: TM50-C (Bottom Center)
- Non-Standard Location - \$90 ea.
- Black Plastic Vertical Surface: TM50-NS

**INTERIOR CABINET LIGHTING**

- LEDPK starter kit includes Infeed, 1 Puck Interior Light and the ability to daisy chain up to 6 total Puck Lights
- LED Puck Starter Kit - \$295
- PK: 1 LED Interior Light - \$125

**TASK LIGHTING**

- LT-LED24: 24" LED Tasklight - \$90
- LT-LED48: 48" LED Tasklight - \$165
- LT-LED60: 60" LED Tasklight - \$180
- LC22: 20" LT-LED Tasklight Linking Cable - \$20

**OPEN PLAN**

- OPB: "W" "G" Style - Modify Unit for Open Plan Application - \$295
- OPBM: "M" Style - Modify Unit for Open Plan Application - \$95

**SHELF**

- GS14H: Replace Standard Shelves with Glass Shelves - \$65 per Shelf
- S714F: Heavy Duty Lumber 1" Shelves - \$75 per Shelf ("M" Styles - n/a)

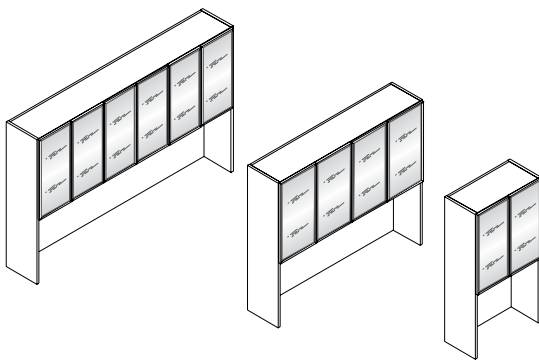

**SILVERLUMA FRAME 6/4/2 DOORS**

**STANDARD FEATURES**

- Finished top
- 1 Adjustable shelf per section standard
- Interior cabinet depth 12.5"
- Interior shelf depth 12"
- Silverluma doors w/ frosted acrylic inserts
- Tasklight grommet hole standard in top back panel

for Open Plan use. Select OPB Option for Open Plan application.

**NOTES**

- Unit has black back panel and is not designed

[CLICK HERE TO VIEW PRODUCT INDEX](#)

**1 SELECT A STYLE**

DIMENSIONS		STYLE NUMBER	LIST PRICE	STYLE NUMBER	LIST PRICE	STYLE NUMBER	LIST PRICE
W" x D" x H"	WGT	"W" Veneer Top Veneer Chassis		"G" High Pressure Laminate Top Veneer Chassis		"M" Thermally Fused Laminate Top Thermally Fused Laminate Chassis	
<b>6 Door / 3 Section</b>							
93 x 14 x 54	300	NSS9354OH321W	4440	"G" Style N/A		NSS9354OH321M	3137
87 x 14 x 54	290	NSS8754OH321W	4260	"G" Style N/A		NSS8754OH321M	3037
<b>4 Door / 2 Section</b>							
70 x 14 x 54	250	NSS7054OH321W	3700	"G" Style N/A		NSS7054OH321M	2175
64 x 14 x 54	230	NSS6454OH321W	3275	"G" Style N/A		NSS6454OH321M	2112
58 x 14 x 54	215	NSS5854OH321W	3125	"G" Style N/A		NSS5854OH321M	1874
<b>2 Door / 1 Section</b>							
35 x 14 x 54	160	NSS3554OH321W	1980	"G" Style N/A		NSS3554OH321M	1168
29 x 14 x 54	150	NSS2954OH321W	1850	"G" Style N/A		NSS2954OH321M	1136

**2 SELECT A FINISH**

"W" Veneer	"G" HPL	"M" TFL	
WAC	-	-	Amber Cherry
WRC	-	-	Caramel Cherry
WIC	-	-	Crimson Cherry
WEC	-	-	Ebony Cherry
WHC	-	MHC	Honey Cherry
WOC	-	MOC	KoKo Cherry
WSC	-	-	Scotch Cherry
WAM	-	-	Alabaster Maple
WCM	-	-	Clear Maple
WWM	-	-	Wheat Maple
WEW	-	-	Executive Walnut
WRW	GRW	-	Gray Luster Walnut
WGW	-	MGW	Gunstock Walnut
WJW	-	-	Judicial Walnut
WNV	-	-	Natural Walnut
WTW	-	MTW	Studio Teak Walnut
WWP	-	MWL	Designer White

**3 SELECT AN EDGE**

Edge Profile  
Option Not Available

**4 SELECT HARDWARE**

Hardware  
Option Not Available

**5 OPTIONS**

**DOOR**

- D2: Door Lock - \$95 per Door Set
- D6: Delete Doors - n/c
- D9SC: Soft Close Door Hinges - \$15 per Door
- WPD3061: Full fill designer white - \$75 per door

**GROMMETS (VERTICAL SURFACE)**

- Standard Location - \$45 ea.
- Black Plastic Vertical Surface: TM50-C (Bottom Center)
- Non-Standard Location - \$90 ea.
- Black Plastic Vertical Surface: TM50-NS

**INTERIOR CABINET LIGHTING**

- LEDPK starter kit includes Infeed, 1 Puck Interior Light and the ability to daisy chain up to 6 total Puck Lights
- LED Puck Starter Kit - \$295
- PK: 1 LED Interior Light - \$125

**TASK LIGHTING**

- LT-LED24: 24" LED Tasklight - \$90
- LT-LED48: 48" LED Tasklight - \$165
- LT-LED60: 60" LED Tasklight - \$180
- LC22: 20" LT-LED Tasklight Linking Cable - \$20

**OPEN PLAN**

- OPB: "W" "G" Style - Modify Unit for Open Plan Application - \$295
- OPBM: "M" Style - Modify Unit for Open Plan Application - \$95

**SHELF**

- GS14F: Replace Standard Shelves with Glass Shelves - \$85 per Shelf
- S714F: Heavy Duty Lumber 1" Shelves - \$75 per Shelf ("M" Styles - n/a)

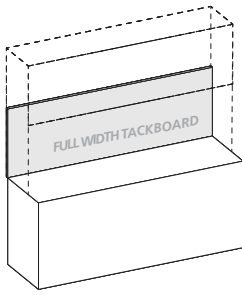

**FULL WIDTH TACKBOARDS**

**STANDARD FEATURES**

- Constructed of .5" thick fiberboard
- Fabric is precisely aligned and fitted to the tackboard
- Adhered to the rigid hardboard with staples

**NOTES**

- Fabric Tack Panels are raised 3" from bottom edge when TM50 grommet is ordered.

PRODUCT WIDTH	PANEL DIMENSION	SKU	COM	1	2	3	4	5	6	7	8	9	10	11/L1	12	13/L2
93	91 x .5 x 21	FTOC9121	364	465	516	567	618	669	720	771	822	873	924	975	1,026	1,128
87	85 x .5 x 21	FTOC8521	344	435	483	531	579	627	675	723	771	819	867	915	963	1,059
83	81 x .5 x 21	FTOC8121	323	415	461	507	553	599	645	691	737	783	829	875	921	1,013
76	74 x .5 x 21	FTOC7421	297	380	423	466	509	552	595	638	681	724	767	810	853	939
70	68 x .5 x 21	FTOC6821	271	350	390	430	470	510	550	590	630	670	710	750	790	870
64	62 x .5 x 21	FTOC6221	246	320	356	392	428	464	500	536	572	608	644	680	716	788
58	56 x .5 x 21	FTOC5621	225	290	322	354	386	418	450	482	514	546	578	610	642	706
47	45 x .5 x 21	FTOC4521	180	235	262	289	316	343	370	397	424	451	478	505	532	586
35	33 x .5 x 21	FTOC3321	136	175	195	215	235	255	275	295	315	335	355	375	395	435
29	27 x .5 x 21	FTOC2721	108	145	162	179	196	213	230	247	264	281	298	315	332	366

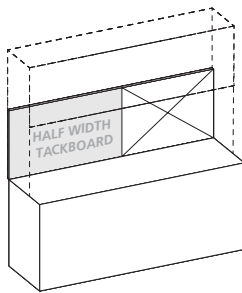

OVERHEAD TACKBOARDS

**HALF WIDTH TACKBOARDS**

**STANDARD FEATURES**

- Constructed of .5" thick fiberboard
- Fabric is precisely aligned and fitted to the tackboard
- Adhered to the rigid hardboard with staples

**Notes**

- Half width tackboards can be specified and combined with a Veneer Panel, Marker Board, Slat Wall or Glass Board. See "Half Width" items under product width.
- Must specify Right or left facing tackboard
- Fabric Tack Panels are raised 3" from bottom edge when TM50 grommet is ordered.

PRODUCT WIDTH	PANEL DIMENSION	SKU	COM	1	2	3	4	5	6	7	8	9	10	11/L1	12	13/L2
93 Half Width	45.5 x .5 x 21	FTOC4521	182	233	258	284	309	335	360	386	411	437	462	488	513	564
87 Half Width	42.5 x .5 x 21	FTOC4221	172	218	242	266	290	314	338	362	386	410	434	458	482	530
83 Half Width	40.5 x .5 x 21	FTOC4021	162	208	231	254	277	300	323	346	369	392	415	438	461	507
76 Half Width	37 x .5 x 21	FTOC3721	149	190	212	233	255	276	298	319	341	362	384	405	427	470
70 Half Width	34 x .5 x 21	FTOC3421	136	175	195	215	235	255	275	295	315	335	355	375	395	435
64 Half Width	31 x .5 x 21	FTOC3121	123	160	178	196	214	232	250	268	286	304	322	340	358	394

**OVERHEAD DRY MARKER BOARD**

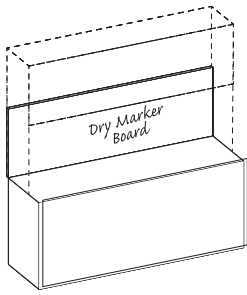

**FULL WIDTH DRY MARKER BOARD**

**STANDARD FEATURES**

- Dry marker panel has edge trim molding
- Standard magnetic surface

PRODUCT WIDTH	PANEL DIMENSION	SKU	LIST
93	91 x .5 x 21	DMOC9121	1092
87	85 x .5 x 21	DMOC8521	1020
83	81 x .5 x 21	DMOC8121	972
76	74 x .5 x 21	DMOC7421	888
70	68 x .5 x 21	DMOC6821	816
64	62 x .5 x 21	DMOC6221	744
58	56 x .5 x 21	DMOC5621	672
47	45 x .5 x 21	DMOC4521	564
35	33 x .5 x 21	DMOC3321	420
29	27 x .5 x 21	DMOC2721	324

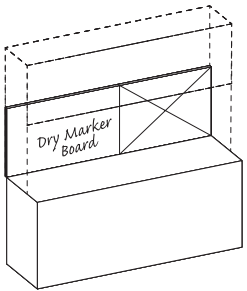

**OVERHEAD DRY MARKER BOARD**

**HALF WIDTH DRY MARKER BOARD**

**STANDARD FEATURES**

- Dry marker panel has edge trim molding
- Standard magnetic surface

**Notes**

- Half width dry marker boards can be specified and combined with a Tackboard, Veneer Panel, Slat Wall or Glass Board. See "Half Width" items under product width.
- Must specify Right or left facing dry marker board

PRODUCT WIDTH	PANEL DIMENSION	SKU	LIST
93 Half Width	45.5 x .5 x 21	DMOC4521	534
87 Half Width	42.5 x .5 x 21	DMOC4221	498
83 Half Width	40.5 x .5 x 21	DMOC4021	474
76 Half Width	37 x .5 x 21	DMOC3721	432
70 Half Width	34 x .5 x 21	DMOC3421	420
64 Half Width	31 x .5 x 21	DMOC3121	360

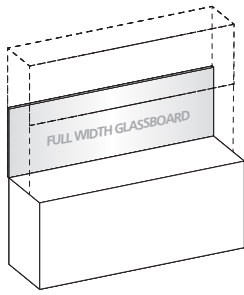

**FULL WIDTH GLASSBOARD**

**STANDARD FEATURES**

- 4 mm tempered glass
- Use glass cleaner or alcohol to clean
- Standard dry erase markers may be used
- Earth magnets are required to hold items securely in place
- Hung with Z-Strip mounting system

PRODUCT WIDTH	PANEL DIMENSION	SKU	LIST
93	91 x .5 x 21	GBOC9121	2290
87	85 x .5 x 21	GBOC8521	2150
83	81 x .5 x 21	GBOC8121	2056
76	74 x .5 x 21	GBOC7421	1893
70	68 x .5 x 21	GBOC6821	1752
64	62 x .5 x 21	GBOC6221	1612
58	56 x .5 x 21	GBOC5621	1472
47	45 x .5 x 21	GBOC4521	1215
35	33 x .5 x 21	GBOC3321	935
29	27 x .5 x 21	GBOC2721	794

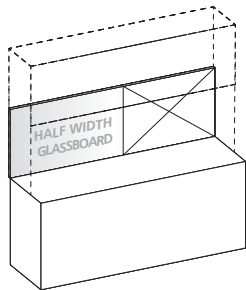

OVERHEAD GLASSBOARD

**HALF WIDTH GLASSBOARD**

**STANDARD FEATURES**

- 4 mm tempered glass
- Use glass cleaner or alcohol to clean
- Standard dry erase markers may be used
- Earth magnets are required to hold items securely in place
- Hung with Z-Strip mounting system

**Notes**

- Half width glassboards can be specified and combined with a Tackboard, Veneer panel, Marker Board or Slat Wall. See "Half Width" items under product width.
- Must specify Right or left facing glassboard

PRODUCT WIDTH	PANEL DIMENSION	SKU	LIST
93 Half Width	45.5 x .5 x 21	GBOC4521	1203
87 Half Width	42.5 x .5 x 21	GBOC4221	1133
83 Half Width	40.5 x .5 x 21	GBOC4021	1086
76 Half Width	37 x .5 x 21	GBOC3721	947
70 Half Width	34 x .5 x 21	GBOC3421	935
64 Half Width	31 x .5 x 21	GBOC3121	864



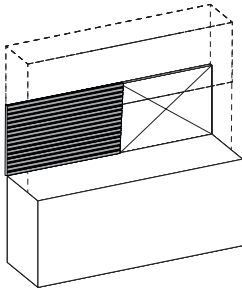

**HALF WIDTH SLAT WALL**

**STANDARD FEATURES**

- Available in silver or black
- For use on 42"/43" height consoles
- Specify Left or Right Position

**Notes**

- Half width slat walls can be specified and combined with a Tackboard, Veneer panel, Marker Board or Glassboard. See "Half Width" items under product width.
- Must specify Right or left facing slat wall

PRODUCT WIDTH	PANEL DIMENSION	SKU	LIST
93 Half Width	45.5 x .5 x 21	SWOC4521	445
87 Half Width	42.5 x .5 x 21	SWOC4221	415
83 Half Width	40.5 x .5 x 21	SWOC4021	395
76 Half Width	37 x .5 x 21	SWOC3721	360
70 Half Width	34 x .5 x 21	SWOC3421	330
64 Half Width	31 x .5 x 21	SWOC3121	300

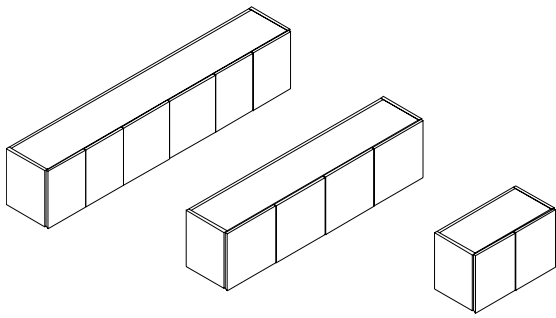

**PANEL DOORS**

**STANDARD FEATURES**

- Finished top
- Interior cabinet depth 12.5"
- Mounting wall rail included
- Panel doors with concealed finger pull
- Tasklight Concealment Apron Rail

from The following: installation into non-load bearing walls. Improper fasteners used in installation. Overloading of cabinets resulting in failures of wall and surrounding structures, fasteners, or cabinet construction. Misuse of cabinets for intended purposes.

**NOTES**

- Proper installation is critical to ensure safety from possible falling cabinets. The factory assumes no liability for damage or injury

[CLICK HERE TO VIEW PRODUCT INDEX](#)

**1 SELECT A STYLE**

DIMENSIONS		STYLE NUMBER	LIST PRICE	STYLE NUMBER	LIST PRICE	STYLE NUMBER	LIST PRICE
W" x D" x H"	WGT	"W" Veneer Veneer Top Veneer Chassis		"G" HPL High Pressure Laminate Top Veneer Chassis		"M" TFL Thermally Fused Laminate Top Thermally Fused Laminate Chassis	
<b>6 Door / 3 Section</b>							
93 x 14 x 18	240	NSS9318WH330W	2975	"G" Style N/A		NSS9318WH330M	2095
87 x 14 x 18	225	NSS8718WH330W	2860	"G" Style N/A		NSS8718WH330M	1980
<b>4 Door / 2 Section</b>							
83 x 14 x 18	210	NSS8318WH330W	2795	"G" Style N/A		NSS8318WH330M	1560
76 x 14 x 18	195	NSS7618WH330W	2745	"G" Style N/A		NSS7618WH330M	1445
70 x 14 x 18	180	NSS7018WH330W	2295	"G" Style N/A		NSS7018WH330M	1335
64 x 14 x 18	160	NSS6418WH330W	2260	"G" Style N/A		NSS6418WH330M	1295
58 x 14 x 18	135	NSS5818WH330W	2225	"G" Style N/A		NSS5818WH330M	1255
47 x 14 x 18	125	NSS4718WH330W	1700	"G" Style N/A		NSS4718WH330M	1195
<b>2 Door / 1 Section</b>							
35 x 14 x 18	75	NSS3518WH330W	1275	"G" Style N/A		NSS3518WH330M	850
29 x 14 x 18	65	NSS2918WH330W	1255	"G" Style N/A		NSS2918WH330M	815

**2 SELECT A FINISH**

"W" Veneer	"G" HPL	"M" TFL	
WAC	-	-	Amber Cherry
WRC	-	-	Caramel Cherry
WIC	-	-	Crimson Cherry
WEC	-	-	Ebony Cherry
WHC	-	MHC	Honey Cherry
WOC	-	MOC	KoKo Cherry
WSC	-	-	Scotch Cherry
WAM	-	-	Alabaster Maple
WCM	-	-	Clear Maple
WWM	-	-	Wheat Maple
WEW	-	-	Executive Walnut
WRW	GRW	-	Gray Luster Walnut
WGW	-	MGW	Gunstock Walnut
WJW	-	-	Judicial Walnut
WNW	-	-	Natural Walnut
WTW	-	MTW	Studio Teak Walnut
WWP	-	MWL	Designer White

**3 SELECT AN EDGE**

Edge Profile  
Option Not Available

**5 OPTIONS**

**DOOR**

- D2: Door Lock - \$95 per Door Set
- D6: Delete Doors - n/c
- D9SC: Soft Close Door Hinges - \$15 per Door
- WPD3061: Full fill designer white - \$75 per door

**INTERIOR CABINET LIGHTING**

- LEDPK starter kit includes Infeed, 1 Puck Interior Light and the ability to daisy chain up to 6 total Puck Lights
- LED Puck Starter Kit - \$295
- PK: 1 LED Interior Light - \$125

**TASK LIGHTING**

- LT-LED24: 24" LED Tasklight - \$90
- LT-LED48: 48" LED Tasklight - \$165
- LT-LED60: 60" LED Tasklight - \$180
- LC22: 20" LT-LED Tasklight Linking Cable - \$20
- WAR-D: Delete Tasklight Concealment Apron Rail - Deduct \$125

**4 SELECT HARDWARE**

Hardware  
Option Not Available

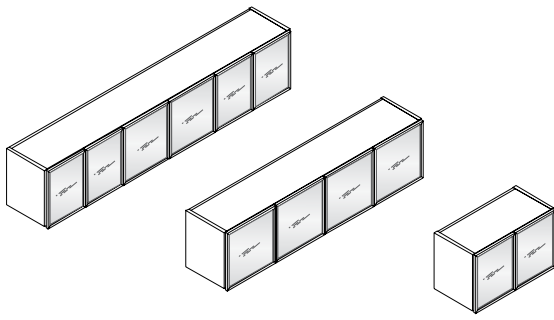

**SILVERLUMA FRAME / DOORS**

**STANDARD FEATURES**

- Finished top
- Interior cabinet depth 12.5"
- Mounting wall rail included
- Silverluma doors w/ frosted acrylic inserts
- Tasklight Concealment Apron Rail

from The following: installation into non-load bearing walls. Improper fasteners used in installation. Overloading of cabinets resulting in failures of wall and surrounding structures, fasteners, or cabinet construction. Misuse of cabinets for intended purposes.

**NOTES**

- Proper installation is critical to ensure safety from possible falling cabinets. The factory assumes no liability for damage or injury

[CLICK HERE TO VIEW PRODUCT INDEX](#)

**1 SELECT A STYLE**

DIMENSIONS		STYLE NUMBER	LIST PRICE	STYLE NUMBER	LIST PRICE	STYLE NUMBER	LIST PRICE
W" x D" x H"	WGT	"W" Veneer Top Veneer Chassis		"G" HPL High Pressure Laminate Top Veneer Chassis		"M" TFL Thermally Fused Laminate Top Thermally Fused Laminate Chassis	
<b>6 Door / 3 Section</b>							
93 x 15 x 18	240	NSS9318WH331W	3365	"G" Style N/A		NSS9318WH331M	2460
87 x 15 x 18	225	NSS8718WH331W	3300	"G" Style N/A		NSS8718WH331M	2345
<b>4 Door / 2 Section</b>							
83 x 15 x 18	210	NSS8318WH331W	3230	"G" Style N/A		NSS8318WH331M	1805
76 x 15 x 18	195	NSS7618WH331W	3185	"G" Style N/A		NSS7618WH331M	1690
70 x 15 x 18	180	NSS7018WH331W	2660	"G" Style N/A		NSS7018WH331M	1575
64 x 15 x 18	160	NSS6418WH331W	2575	"G" Style N/A		NSS6418WH331M	1535
58 x 15 x 18	135	NSS5818WH331W	2495	"G" Style N/A		NSS5818WH331M	1495
47 x 15 x 18	125	NSS4718WH331W	1908	"G" Style N/A		NSS4718WH331M	1440
<b>2 Door / 1 Section</b>							
35 x 15 x 18	75	NSS3518WH331W	1455	"G" Style N/A		NSS3518WH331M	950
29 x 15 x 18	65	NSS2918WH331W	1390	"G" Style N/A		NSS2918WH331M	915

**2 SELECT A FINISH**

"W" Veneer	"G" HPL	"M" TFL	Finish
WAC	-	-	Amber Cherry
WRC	-	-	Caramel Cherry
WIC	-	-	Crimson Cherry
WEC	-	-	Ebony Cherry
WHC	-	MHC	Honey Cherry
WOC	-	MOC	KoKo Cherry
WSC	-	-	Scotch Cherry
WAM	-	-	Alabaster Maple
WCM	-	-	Clear Maple
WWM	-	-	Wheat Maple
WEW	-	-	Executive Walnut
WRW	GRW	-	Gray Luster Walnut
WGW	-	MGW	Gunstock Walnut
WJW	-	-	Judicial Walnut
WNW	-	-	Natural Walnut
WTW	-	MTW	Studio Teak Walnut
WWP	-	MWL	Designer White

**3 SELECT AN EDGE**

Edge Profile  
Option Not Available

**5 OPTIONS**

- DOOR**
- D2: Door Lock - \$95 per Door Set
  - D6: Delete Doors - n/c
  - D9SC: Soft Close Door Hinges - \$15 per Door
  - WPD3061: Full fill designer white - \$75 per door
- INTERIOR CABINET LIGHTING**
- LEDPK starter kit includes Infeed, 1 Puck Interior Light and the ability to daisy chain up to 6 total Puck Lights
- LED Puck Starter Kit - \$295
  - PK: 1 LED Interior Light - \$125
- TASK LIGHTING**
- LT-LED24: 24" LED Tasklight - \$90
  - LT-LED48: 48" LED Tasklight - \$165
  - LT-LED60: 60" LED Tasklight - \$180
  - LC22: 20" LT-LED Tasklight Linking Cable - \$20
  - WAR-D: Delete Tasklight Concealment Apron Rail - Deduct \$125

**4 SELECT HARDWARE**

Hardware  
Option Not Available

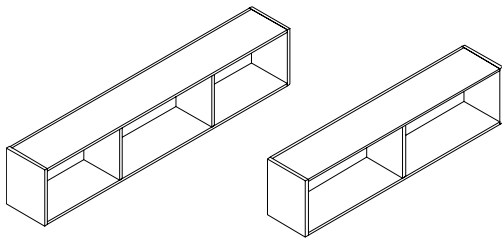

**OPEN STORAGE CABINET**

**STANDARD FEATURES**

- Finished top
- Interior cabinet depth 12.5"
- Mounting wall rail included
- Tasklight Concealment Apron Rail

bearing walls. Improper fasteners used in installation. Overloading of cabinets resulting in failures of wall and surrounding structures, fasteners, or cabinet construction. Misuse of cabinets for intended purposes.  
- Sliding doors will not pass each other

**NOTES**

- Proper installation is critical to ensure safety from possible falling cabinets. The factory assumes no liability for damage or injury from The following: installation into non-load

[CLICK HERE TO VIEW PRODUCT INDEX](#)

**1 SELECT A STYLE**

DIMENSIONS		STYLE NUMBER	LIST PRICE	STYLE NUMBER	LIST PRICE	STYLE NUMBER	LIST PRICE
W" x D" x H"	WGT	"W" Veneer Veneer Top Veneer Chassis		"G" HPL High Pressure Laminate Top Veneer Chassis		"M" TFL Thermally Fused Laminate Top Thermally Fused Laminate Chassis	
<b>3 Section</b>							
93 x 14 x 18	225	NSS9318WH332W	2740	"G" Style N/A		NSS9318WH332M	1776
87 x 14 x 18	210	NSS8718WH332W	2715	"G" Style N/A		NSS8718WH332M	1662
83 x 14 x 18	200	NSS8318WH332W	2690	"G" Style N/A		NSS8318WH332M	1246
76 x 14 x 18	185	NSS7618WH332W	2660	"G" Style N/A		NSS7618WH332M	1183
<b>2 Section</b>							
70 x 14 x 18	170	NSS7018WH332W	2175	"G" Style N/A		NSS7018WH332M	1121
64 x 14 x 18	150	NSS6418WH332W	2140	"G" Style N/A		NSS6418WH332M	1084
58 x 14 x 18	125	NSS5818WH332W	2110	"G" Style N/A		NSS5818WH332M	1042
47 x 14 x 18	115	NSS4718WH332W	1575	"G" Style N/A		NSS4718WH332M	982
<b>1 Section</b>							
35 x 14 x 18	60	NSS3518WH332W	1185	"G" Style N/A		NSS3518WH332M	733
29 x 14 x 18	50	NSS2918WH332W	1170	"G" Style N/A		NSS2918WH332M	699

**2 SELECT A FINISH**

"W" Veneer	"G" HPL	"M" TFL	Finish
WAC	-	-	Amber Cherry
WRC	-	-	Caramel Cherry
WIC	-	-	Crimson Cherry
WEC	-	-	Ebony Cherry
WHC	-	MHC	Honey Cherry
WOC	-	MOC	KoKo Cherry
WSC	-	-	Scotch Cherry
WAM	-	-	Alabaster Maple
WCM	-	-	Clear Maple
WWM	-	-	Wheat Maple
WEW	-	-	Executive Walnut
WRW	GRW	-	Gray Luster Walnut
WGW	-	MGW	Gunstock Walnut
WJW	-	-	Judicial Walnut
WNW	-	-	Natural Walnut
WTW	-	MTW	Studio Teak Walnut
WWP	-	MWL	Designer White

**3 SELECT AN EDGE**

Edge Profile  
Option Not Available

**5 OPTIONS**

- SLIDING DOOR**
- SLD17LD: Laminate Door - \$195 Per Door
  - SLD17FD: SilverLuma / Frost Door - \$350 Per Door
  - SLD17WD: Wood Door - \$250 Per Door
- INTERIOR CABINET LIGHTING**
- LEDPK starter kit includes Infeed, 1 Puck Interior Light and the ability to daisy chain up to 6 total Puck Lights
- LED Puck Starter Kit - \$295
  - PK: 1 LED Interior Light - \$125
- TASK LIGHTING**
- LT-LED24: 24" LED Tasklight - \$90
  - LT-LED48: 48" LED Tasklight - \$165
  - LT-LED60: 60" LED Tasklight - \$180
  - LC22: 20" LT-LED Tasklight Linking Cable - \$20
  - WAR-D: Delete Tasklight Concealment Apron Rail - Deduct \$125

**4 SELECT HARDWARE**

Hardware  
Option Not Available

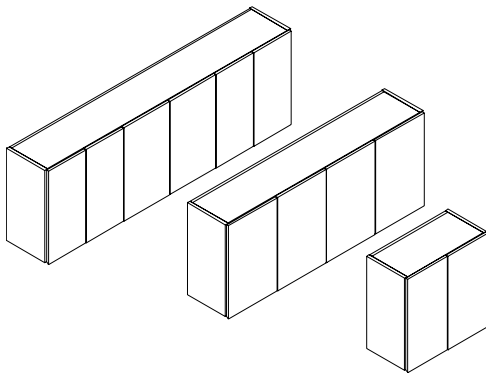

**PANEL DOORS**

**STANDARD FEATURES**

- 1 Adjustable shelf per section standard
- Black painted top
- Interior cabinet depth 12.5"
- Interior shelf depth 12"
- Mounting rails included
- Panel doors with concealed finger pull
- Tasklight Concealment Apron Rail

from possible falling cabinets. The factory assumes no liability for damage or injury from the following: installation into non-load bearing walls. Improper fasteners used in installation. Overloading of cabinets resulting in failures of wall and surrounding structures, fasteners, or cabinet construction. Misuse of cabinets for intended purposes.

**NOTES**

- Proper installation is critical to ensure safety

[CLICK HERE TO VIEW PRODUCT INDEX](#)

**1 SELECT A STYLE**

DIMENSIONS		STYLE NUMBER	LIST PRICE	STYLE NUMBER	LIST PRICE	STYLE NUMBER	LIST PRICE
W" x D" x H"	WGT	"W" Veneer Veneer Top Veneer Chassis		"G" HPL High Pressure Laminate Top Veneer Chassis		"M" TFL Thermally Fused Laminate Top Thermally Fused Laminate Chassis	
<b>6 Door / 3 Section</b>							
93 x 14 x 29	265	NSS9329WH330W	3460	"G" Style N/A		NSS9329WH330M	2574
87 x 14 x 29	250	NSS8729WH330W	3405	"G" Style N/A		NSS8729WH330M	2460
<b>4 Door / 2 Section</b>							
83 x 14 x 29	235	NSS8329WH330W	3355	"G" Style N/A		NSS8329WH330M	1820
70 x 14 x 29	220	NSS7029WH330W	2830	"G" Style N/A		NSS7029WH330M	1725
64 x 14 x 29	200	NSS6429WH330W	2805	"G" Style N/A		NSS6429WH330M	1688
58 x 14 x 29	180	NSS5829WH330W	2750	"G" Style N/A		NSS5829WH330M	1620
<b>2 Door / 1 Section</b>							
35 x 14 x 29	85	NSS3529WH330W	1485	"G" Style N/A		NSS3529WH330M	1160
29 x 14 x 29	75	NSS2929WH330W	1450	"G" Style N/A		NSS2929WH330M	1125

**2 SELECT A FINISH**

"W" Veneer	"G" HPL	"M" TFL	Finish
WAC	-	-	Amber Cherry
WRC	-	-	Caramel Cherry
WIC	-	-	Crimson Cherry
WEC	-	-	Ebony Cherry
WHC	-	MHC	Honey Cherry
WOC	-	MOC	KoKo Cherry
WSC	-	-	Scotch Cherry
WAM	-	-	Alabaster Maple
WCM	-	-	Clear Maple
WWM	-	-	Wheat Maple
WEW	-	-	Executive Walnut
WRW	GRW	-	Gray Luster Walnut
WGW	-	MGW	Gunstock Walnut
WJW	-	-	Judicial Walnut
WNV	-	-	Natural Walnut
WTW	-	MTW	Studio Teak Walnut
WWP	-	MWL	Designer White

**3 SELECT AN EDGE**

Edge Profile  
Option Not Available

**5 OPTIONS**

**DOOR**

- D2: Door Lock - \$95 per Door Set
- D6: Delete Doors - n/c
- D9SC: Soft Close Door Hinges - \$15 per Door
- WPD3061: Full fill designer white - \$75 per door

**INTERIOR CABINET LIGHTING**

- LEDPK starter kit includes Infeed, 1 Puck Interior Light and the ability to daisy chain up to 6 total Puck Lights
- LED Puck Starter Kit - \$295
- PK: 1 LED Interior Light - \$125

**TASK LIGHTING**

- LT-LED24: 24" LED Tasklight - \$90
- LT-LED48: 48" LED Tasklight - \$165
- LT-LED60: 60" LED Tasklight - \$180
- LC22: 20" LT-LED Tasklight Linking Cable - \$20
- WAR-D: Delete Tasklight Concealment Apron Rail - Deduct \$125

**SHELF**

- GS14F: Replace Standard Shelves with Glass Shelves - \$85 per Shelf
- S714F: Heavy Duty Lumber 1" Shelves - \$75 per Shelf ("M" Styles - n/a)

**4 SELECT HARDWARE**

Hardware  
Option Not Available

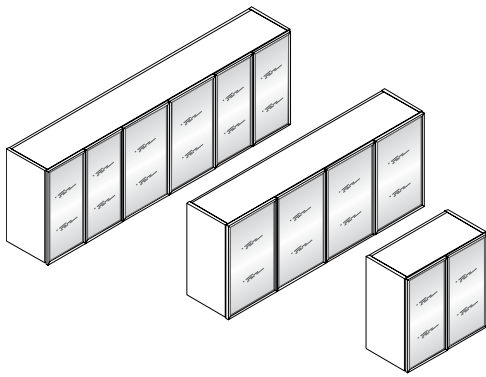

**SILVERLUMA FRAME / DOORS**

**STANDARD FEATURES**

- Black painted top
- Interior cabinet depth 12.5"
- Interior shelf depth 12"
- Mounting rails included
- Silverluma doors w/ frosted acrylic inserts
- Tasklight Concealment Apron Rail

from possible falling cabinets. The factory assumes no liability for damage or injury from the following: installation into non-load bearing walls. Improper fasteners used in installation. Overloading of cabinets resulting in failures of wall and surrounding structures, fasteners, or cabinet construction. Misuse of cabinets for intended purposes.

**NOTES**

- 1 Adjustable Shelf per section
- Proper installation is critical to ensure safety

[CLICK HERE TO VIEW PRODUCT INDEX](#)

**1 SELECT A STYLE**

DIMENSIONS		STYLE NUMBER	LIST PRICE	STYLE NUMBER	LIST PRICE	STYLE NUMBER	LIST PRICE
W" x D" x H"	WGT	"W" Veneer Top Veneer Chassis		"G" High Pressure Laminate Top Veneer Chassis		"M" Thermally Fused Laminate Top Thermally Fused Laminate Chassis	
<b>6 Door / 3 Section</b>							
93 x 14 x 29	265	NSS9329WH331W	4275	"G" Style N/A		NSS9329WH331M	3181
87 x 14 x 29	250	NSS8729WH331W	4145	"G" Style N/A		NSS8729WH331M	3067
<b>4 Door / 2 Section</b>							
70 x 14 x 29	220	NSS7029WH331W	3395	"G" Style N/A		NSS7029WH331M	1955
64 x 14 x 29	200	NSS6429WH331W	3305	"G" Style N/A		NSS6429WH331M	2092
58 x 14 x 29	180	NSS5829WH331W	3175	"G" Style N/A		NSS5829WH331M	2025
<b>2 Door / 1 Section</b>							
35 x 14 x 29	85	NSS3529WH331W	1800	"G" Style N/A		NSS3529WH331M	1356
29 x 14 x 29	75	NSS2929WH331W	1700	"G" Style N/A		NSS2929WH331M	1328

**2 SELECT A FINISH**

"W" Veneer	"G" HPL	"M" TFL	Finish
WAC	-	-	Amber Cherry
WRC	-	-	Caramel Cherry
WIC	-	-	Crimson Cherry
WEC	-	-	Ebony Cherry
WHC	-	MHC	Honey Cherry
WOC	-	MOC	KoKo Cherry
WSC	-	-	Scotch Cherry
WAM	-	-	Alabaster Maple
WCM	-	-	Clear Maple
WWM	-	-	Wheat Maple
WEW	-	-	Executive Walnut
WRW	GRW	-	Gray Luster Walnut
WGW	-	MGW	Gunstock Walnut
WJW	-	-	Judicial Walnut
WNW	-	-	Natural Walnut
WTW	-	MTW	Studio Teak Walnut
WWP	-	MWL	Designer White

**3 SELECT AN EDGE**

Edge Profile  
Option Not Available

**5 OPTIONS**

**DOOR**

- D2: Door Lock - \$95 per Door Set
- D6: Delete Doors - n/c
- D9SC: Soft Close Door Hinges - \$15 per Door
- WPD3061: Full fill designer white - \$75 per door

**INTERIOR CABINET LIGHTING**

- LEDPK starter kit includes Infeed, 1 Puck Interior Light and the ability to daisy chain up to 6 total Puck Lights
- LED Puck Starter Kit - \$295
- PK: 1 LED Interior Light - \$125

**TASK LIGHTING**

- LT-LED24: 24" LED Tasklight - \$90
- LT-LED48: 48" LED Tasklight - \$165
- LT-LED60: 60" LED Tasklight - \$180
- LC22: 20" LT-LED Tasklight Linking Cable - \$20
- WAR-D: Delete Tasklight Concealment Apron Rail - Deduct \$125

**SHELF**

- GS14F: Replace Standard Shelves with Glass Shelves - \$85 per Shelf
- S714F: Heavy Duty Lumber 1" Shelves - \$75 per Shelf ("M" Styles - n/a)

**4 SELECT HARDWARE**

Hardware  
Option Not Available

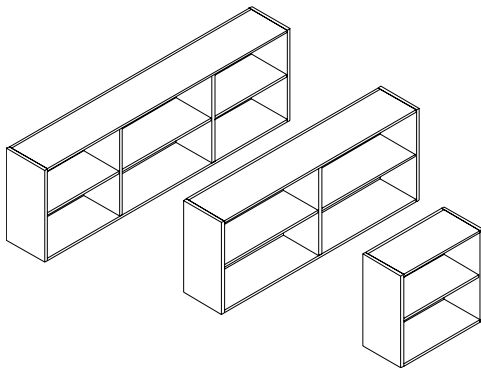

**OPEN STORAGE CABINET**

**STANDARD FEATURES**

- 1 Adjustable shelf per section
- Black painted top
- Interior cabinet depth 12.5"
- Interior shelf depth 12"
- Mounting rails included
- Tasklight Concealment Apron Rail

**NOTES**

- 1 or 2 Optional Doors Available
- Sliding doors will not pass each other

[CLICK HERE TO VIEW PRODUCT INDEX](#)

**1 SELECT A STYLE**

DIMENSIONS		STYLE NUMBER		LIST PRICE	STYLE NUMBER		LIST PRICE	STYLE NUMBER		LIST PRICE
W" x D" x H"	WGT	"W" Veneer	Veneer Top Veneer Chassis		"G" HPL	High Pressure Laminate Top Veneer Chassis		"M" TFL	Thermally Fused Laminate Top Thermally Fused Laminate Chassis	
<b>3 Section</b>										
93 x 14 x 29	215	NSS9329WH332W		3130	"G" Style N/A			NSS9329WH332M		2076
87 x 14 x 29	200	NSS8729WH332W		3070	"G" Style N/A			NSS8729WH332M		1961
83 x 14 x 29	190	NSS8329WH332W		3015	"G" Style N/A			NSS8329WH332M		1491
<b>2 Section</b>										
70 x 14 x 29	180	NSS7029WH332W		2575	"G" Style N/A			NSS7029WH332M		1387
64 x 14 x 29	170	NSS6429WH332W		2525	"G" Style N/A			NSS6429WH332M		1359
58 x 14 x 29	150	NSS5829WH332W		2465	"G" Style N/A			NSS5829WH332M		1292
<b>1 Section</b>										
35 x 14 x 29	70	NSS3529WH332W		1375	"G" Style N/A			NSS3529WH332M		995
29 x 14 x 29	60	NSS2929WH332W		1345	"G" Style N/A			NSS2929WH332M		960

**2 SELECT A FINISH**

"W" Veneer	"G" HPL	"M" TFL	Finish
WAC	-	-	Amber Cherry
WRC	-	-	Caramel Cherry
WIC	-	-	Crimson Cherry
WEC	-	-	Ebony Cherry
WHC	-	MHC	Honey Cherry
WOC	-	MOC	KoKo Cherry
WSC	-	-	Scotch Cherry
WAM	-	-	Alabaster Maple
WCM	-	-	Clear Maple
WWM	-	-	Wheat Maple
WEW	-	-	Executive Walnut
WRW	GRW	-	Gray Luster Walnut
WGW	-	MGW	Gunstock Walnut
WJW	-	-	Judicial Walnut
WNW	-	-	Natural Walnut
WTW	-	MTW	Studio Teak Walnut
WWP	-	MWL	Designer White

**3 SELECT AN EDGE**

Edge Profile  
Option Not Available

**5 OPTIONS**

- SLIDING DOOR**
- SLD29LD: Laminate Door - \$250 Per Door
  - SLD29FD: SilverLuma / Frost Door - \$395 Per Door
  - SLD29WD: Wood Door - \$295 Per Door
- TASK LIGHTING**
- LT-LED24: 24" LED Tasklight - \$90
  - LT-LED48: 48" LED Tasklight - \$165
  - LT-LED60: 60" LED Tasklight - \$180
  - LC22: 20" LT-LED Tasklight Linking Cable - \$20
  - WAR-D: Delete Tasklight Concealment Apron Rail - Deduct \$125
- SHELF**
- GS14F: Replace Standard Shelves with Glass Shelves - \$85 per Shelf
  - S714F: Heavy Duty Lumber 1" Shelves - \$75 per Shelf ("M" Styles - n/a)

**4 SELECT HARDWARE**

Hardware  
Option Not Available

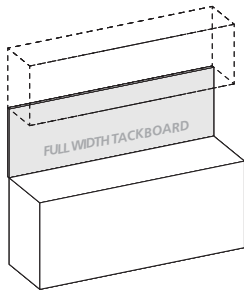

**FULL WIDTH TACKBOARDS**

**STANDARD FEATURES**

- Constructed of .5" thick fiberboard
- Fabric is precisely aligned and fitted to the tackboard
- Adhered to the rigid hardboard with staples

PRODUCT WIDTH	PANEL DIMENSION	SKU	COM	1	2	3	4	5	6	7	8	9	10	11/L1	12	13/L2
93"	93 x .75 x 24	FTWH9324	447	558	609	660	711	762	813	864	915	966	1,017	1,068	1,119	1,221
87"	87 x .75 x 24	FTWH8724	431	522	570	618	666	714	762	810	858	906	954	1,002	1,050	1,146
83"	83 x .75 x 24	FTWH8324	406	498	544	590	636	682	728	774	820	866	912	958	1,004	1,096
76"	76 x .75 x 24	FTWH7624	373	456	499	542	585	628	671	714	757	800	843	886	929	1,015
70"	70 x .75 x 24	FTWH7024	341	420	460	500	540	580	620	660	700	740	780	820	860	940
64"	64 x .75 x 24	FTWH6424	310	384	420	456	492	528	564	600	636	672	708	744	780	852
58"	58 x .75 x 24	FTWH5824	283	348	380	412	444	476	508	540	572	604	636	668	700	764
47"	47 x .75 x 24	FTWH4724	227	282	309	336	363	390	417	444	471	498	525	552	579	633
35"	35 x .75 x 24	FTWH3524	169	210	230	250	270	290	310	330	350	370	390	410	430	470
29"	29 x .75 x 24	FTWH2924	137	174	191	208	225	242	259	276	293	310	327	344	361	395

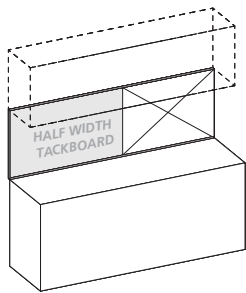

WALL HUNG TACKBOARDS

**HALF WIDTH TACKBOARDS**

**STANDARD FEATURES**

- Constructed of .5" thick fiberboard
- Fabric is precisely aligned and fitted to the tackboard
- Adhered to the rigid hardboard with staples

**Notes**

- Half width tackboards can be specified and combined with a Veneer Panel, Marker Board, Slat Wall or Glass Board. See "Half Width" items under product width.
- Must specify Right or left facing tackboard

PRODUCT WIDTH	PANEL DIMENSION	SKU	COM	1	2	3	4	5	6	7	8	9	10	11/L1	12	13/L2
93 Half Width	46.5 x .75 x 24	FTWH4624	224	279	305	330	356	381	407	432	458	483	509	534	560	611
87 Half Width	43.5 x .75 x 24	FTWH4324	216	261	285	309	333	357	381	405	429	453	477	501	525	573
83 Half Width	41.5 x .75 x 24	FTWH4124	203	249	272	295	318	341	364	387	410	433	456	479	502	548
76 Half Width	38 x .75 x 24	FTWH3824	187	228	250	271	293	314	336	357	379	400	422	443	465	508
70 Half Width	35 x .75 x 24	FTWH3524	171	210	230	250	270	290	310	330	350	370	390	410	430	470
64 Half Width	32 x .75 x 24	FTWH3224	155	192	210	228	246	264	282	300	318	336	354	372	390	426



**WALL HUNG DRY MARKER BOARD**

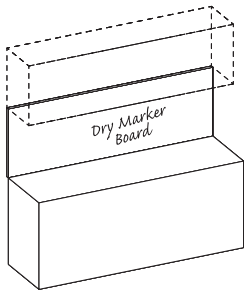

**FULL WIDTH DRY MARKER BOARD**

**STANDARD FEATURES**

- Dry marker panel has edge trim molding
- Standard magnetic surface

PRODUCT WIDTH	PANEL DIMENSION	SKU	LIST
93	93 x .75 x 24	DMWH9324	1116
87	87 x .75 x 24	DMWH8724	1044
83	83 x .75 x 24	DMWH8324	984
76	76 x .75 x 24	DMWH7624	912
70	70 x .75 x 24	DMWH7024	840
64	64 x .75 x 24	DMWH6424	768
58	58 x .75 x 24	DMWH5824	696
47	47 x .75 x 24	DMWH4724	564
35	35 x .75 x 24	DMWH3524	420
29	29 x .75 x 24	DMWH2924	348

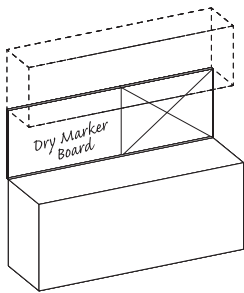

**WALL HUNG DRY MARKER BOARD**

**HALF WIDTH DRY MARKER BOARD**

**STANDARD FEATURES**

- Dry marker panel has edge trim molding
- Standard magnetic surface

**Notes**

- Half width dry marker boards can be specified and combined with a Tackboard, Veneer Panel, Slat Wall or Glass Board. See "Half Width" items under product width.
- Must specify Right or left facing dry marker board

PRODUCT WIDTH	PANEL DIMENSION	SKU	LIST
93 Half Width	46.5 x .75 x 24	DMWH4624	558
87 Half Width	43.5 x .75 x 24	DMWH4324	522
83 Half Width	41.5 x .75 x 24	DMWH4124	498
76 Half Width	38 x .75 x 24	DMWH3824	456
70 Half Width	35 x .75 x 24	DMWH3524	420
64 Half Width	32 x .75 x 24	DMWH3224	384

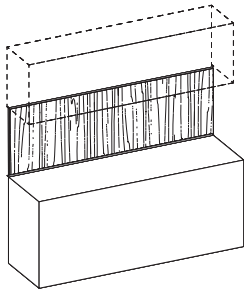

**FULL WIDTH VENEER PANEL**

**STANDARD FEATURES**

- Can be used with or without overhead cabinet.
- Required for other accessory panels.
- Veneer edges.
- Vertical wire channels on back for task light cords.
- Steel mounting wall channel is recessed for flush mounting.

PRODUCT WIDTH	PANEL DIMENSION	SKU	LIST
93	93 x .75 x 24	VPWH9324	930
87	87 x .75 x 24	VPWH8724	870
83	83 x .75 x 24	VPWH8324	820
76	76 x .75 x 24	VPWH7624	760
70	70 x .75 x 24	VPWH7024	700
64	64 x .75 x 24	VPWH6424	640
58	58 x .75 x 24	VPWH5824	580
47	47 x .75 x 24	VPWH4724	470
35	35 x .75 x 24	VPWH3524	350
29	29 x .75 x 24	VPWH2924	290

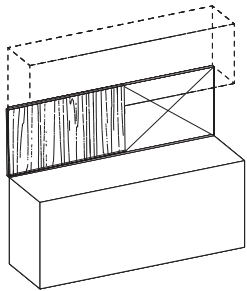

**WALL HUNG VENEER PANEL**

**HALF WIDTH VENEER PANEL**

**STANDARD FEATURES**

- Can be used with or without overhead cabinet.
- Required for other accessory panels.
- Veneer edges.
- Vertical wire channels on back for task light cords.
- Steel mounting wall channel is recessed for flush mounting.

**Notes**

- Half width veneer panels can be specified and combined with a Tackboard, Marker Board, Slat Wall or Glass Board. See "Half Width" items under product width.
- Must specify Right or left facing veneer panel

PRODUCT WIDTH	PANEL DIMENSION	SKU	LIST
93 Half Width	46.5 x .75 x 24	VPWH4624	465
87 Half Width	43.5 x .75 x 24	VPWH4324	435
83 Half Width	41.5 x .75 x 24	VPWH4124	415
76 Half Width	38 x .75 x 24	VPWH3824	380
70 Half Width	35 x .75 x 24	VPWH3524	350
64 Half Width	32 x .75 x 24	VPWH3224	320

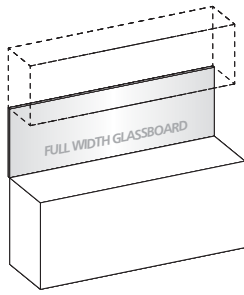

**FULL WIDTH TACKBOARDS**

**STANDARD FEATURES**

- 4 mm tempered glass
- Use glass cleaner or alcohol to clean
- Standard dry erase markers may be used
- Earth magnets are required to hold items securely in place
- Hung with Z-Strip mounting system

PRODUCT WIDTH	PANEL DIMENSION	SKU	LIST
93	93 x .75 x 24	GBWH9324	2647
87	87 x .75 x 24	GBWH8724	2487
83	83 x .75 x 24	GBWH8324	2380
76	76 x .75 x 24	GBWH7624	2193
70	70 x .75 x 24	GBWH7024	2033
64	64 x .75 x 24	GBWH6424	1873
58	58 x .75 x 24	GBWH5824	1712
47	47 x .75 x 24	GBWH4724	1419
35	35 x .75 x 24	GBWH3524	1098
29	29 x .75 x 24	GBWH2924	938

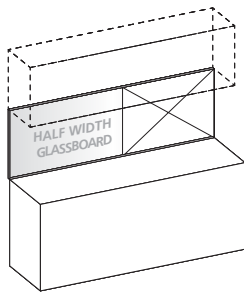

WALL HUNG GLASSBOARD

**HALF WIDTH TACKBOARDS**

**STANDARD FEATURES**

- 4 mm tempered glass
- Use glass cleaner or alcohol to clean
- Standard dry erase markers may be used
- Earth magnets are required to hold items securely in place
- Hung with Z-Strip mounting system

**Notes**

- Half width glassboards can be specified and combined with a Tackboard, Veneer panel, Marker Board or Slat Wall. See "Half Width" items under product width.
- Must specify Right or left facing glassboard

PRODUCT WIDTH	PANEL DIMENSION	SKU	LIST
93 Half Width	46.5 x .75 x 24	GBWH4624	1405
87 Half Width	43.5 x .75 x 24	GBWH4324	1325
83 Half Width	41.5 x .75 x 24	GBWH4124	1272
76 Half Width	38 x .75 x 24	GBWH3824	1185
70 Half Width	35 x .75 x 24	GBWH3524	1098
64 Half Width	32 x .75 x 24	GBWH3224	1018

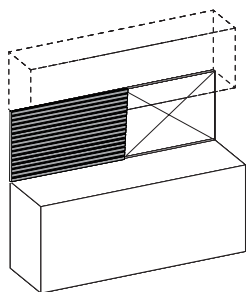

**HALF WIDTH SLAT WALL**

**STANDARD FEATURES**

- Available in silver or black
- For use on 42"/43" height consoles

**Notes**

- Half width slat walls can be specified and combined with a Tackboard, Veneer panel, Marker Board or Glassboard. See "Half Width" items under product width.
- Must specify Right or left facing slat wall

PRODUCT WIDTH	PANEL DIMENSION	SKU	LIST
93 Half Width	46.5 x .75 x 24	SWWH4624	465
87 Half Width	43.5 x .75 x 24	SWWH4324	435
83 Half Width	41.5 x .75 x 24	SWWH4124	415
76 Half Width	38 x .75 x 24	SWWH3824	380
70 Half Width	35 x .75 x 24	SWWH3524	350
64 Half Width	32 x .75 x 24	SWWH3224	320

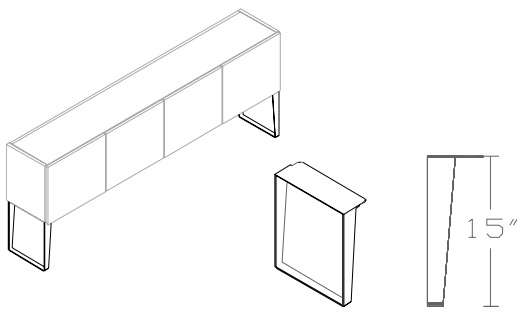

**METAL SLEIGH SUPPORT BASE FOR WALL HUNG**

**STANDARD FEATURES**

- Non-Slide cushion surface protector
- Standard Silver Base (optional White, Black)
- Sold as a set of 2 bases

**NOTES**

- Converts wall hung to sit on cabinet

[CLICK HERE TO VIEW PRODUCT INDEX](#)

**1 SELECT A STYLE**

DIMENSIONS		STYLE NUMBER	LIST PRICE	STYLE NUMBER	LIST PRICE	STYLE NUMBER	LIST PRICE
W" x D" x H"	WGT	"C" Comp Component					
<b>Standard (Set of Two Bases)</b>							
2 x 14 x 15	5	ASB15	495				

**2 SELECT A FINISH**

"C" Comp

METAL FINISHES

MFB	-	-	Black (Premium Finish)
MFS	-	-	Silver
MFW	-	-	White (Premium Finish)

**3 SELECT AN EDGE**

Edge Profile  
Option Not Available

**5 OPTIONS**

**PREMIUM FINISH OPTION**  
 - MFB: Black metal finish - \$95 per base  
 - MFW: White metal finish - \$95 per base

**4 SELECT HARDWARE**

Hardware  
Option Not Available

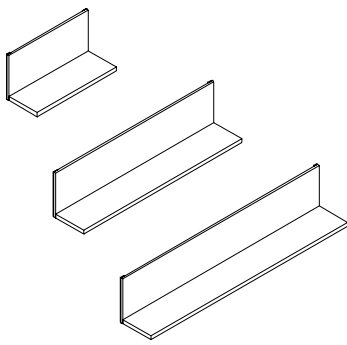

**OPEN ENDLESS SHELF SINGLE HEIGHT**

**STANDARD FEATURES**

- Mounting rails included
- Tasklight concealment apron rail

in failures of wall and surrounding structures, fasteners, or cabinet construction. Misuse of cabinets for intended purposes.  
- Max load per inch is 3lbs

**NOTES**

- Proper installation is critical to ensure safety from possible falling cabinets. The factory assumes no liability for damage or injury from the following: installation into non-load bearing walls. Improper fasteners used in installation. Overloading of cabinets resulting

[CLICK HERE TO VIEW PRODUCT INDEX](#)

**1 SELECT A STYLE**

DIMENSIONS		STYLE NUMBER	LIST PRICE	STYLE NUMBER	LIST PRICE	STYLE NUMBER	LIST PRICE
W" x D" x H"	WGT	"W" Veneer Top Veneer Chassis		"G" High Pressure Laminate Top HPL Veneer Chassis		"M" Thermally Fused Laminate Top Thermally Fused Laminate Chassis	
93 x 14 x 18	100	NSS9318WH336W	2410	"G" Style N/A		NSS9318WH336M	1460
87 x 14 x 18	95	NSS8718WH336W	2260	"G" Style N/A		NSS8718WH336M	1406
83 x 14 x 18	90	NSS8318WH336W	2160	"G" Style N/A		NSS8318WH336M	1361
76 x 14 x 18	85	NSS7618WH336W	1985	"G" Style N/A		NSS7618WH336M	1316
70 x 14 x 18	80	NSS7018WH336W	1835	"G" Style N/A		NSS7018WH336M	1285
64 x 14 x 18	75	NSS6418WH336W	1685	"G" Style N/A		NSS6418WH336M	1206
58 x 14 x 18	70	NSS5818WH336W	1535	"G" Style N/A		NSS5818WH336M	1150
48 x 14 x 18	50	NSS4818WH336W	1330	"G" Style N/A		NSS4818WH336M	930
35 x 14 x 18	35	NSS3518WH336W	1020	"G" Style N/A		NSS3518WH336M	765
29 x 14 x 18	30	NSS2918WH336W	870	"G" Style N/A		NSS2918WH336M	704

**2 SELECT A FINISH**

"W" Veneer	"G" HPL	"M" TFL	Finish
WAC	-	-	Amber Cherry
WRC	-	-	Caramel Cherry
WIC	-	-	Crimson Cherry
WEC	-	-	Ebony Cherry
WHC	-	MHC	Honey Cherry
WOC	-	MOC	KoKo Cherry
WSC	-	-	Scotch Cherry
WAM	-	-	Alabaster Maple
WCM	-	-	Clear Maple
WWM	-	-	Wheat Maple
WEW	-	-	Executive Walnut
WRW	GRW	-	Gray Luster Walnut
WGW	-	MGW	Gunstock Walnut
WJW	-	-	Judicial Walnut
WNW	-	-	Natural Walnut
WTW	-	MTW	Studio Teak Walnut
WWP	-	MWL	Designer White

**3 SELECT AN EDGE**

Edge Profile  
Option Not Available

**5 OPTIONS**

- TASK LIGHTING**
- LT-LED24: 24" LED Tasklight - \$90
  - LT-LED48: 48" LED Tasklight - \$165
  - LT-LED60: 60" LED Tasklight - \$180
  - LC22: 20" LT-LED Tasklight Linking Cable - \$20
  - WAR-D: Delete Tasklight Concealment Apron Rail - Deduct \$125

**4 SELECT HARDWARE**

Hardware  
Option Not Available

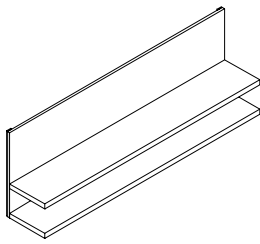

**OPEN ENDLESS SHELF DOUBLE HEIGHT**

**STANDARD FEATURES**

- Mounting rails included
- Tasklight concealment apron rail

in failures of wall and surrounding structures, fasteners, or cabinet construction. Misuse of cabinets for intended purposes.  
- Max load per inch is 6lbs

**NOTES**

- Proper installation is critical to ensure safety from possible falling cabinets. The factory assumes no liability for damage or injury from the following: installation into non-load bearing walls. Improper fasteners used in installation. Overloading of cabinets resulting

[CLICK HERE TO VIEW PRODUCT INDEX](#)

**1 SELECT A STYLE**

DIMENSIONS		STYLE NUMBER	LIST PRICE	STYLE NUMBER	LIST PRICE	STYLE NUMBER	LIST PRICE
W" x D" x H"	WGT	"W" Veneer Veneer Top Veneer Chassis		"G" HPL High Pressure Laminate Top Veneer Chassis		"M" TFL Thermally Fused Laminate Top Thermally Fused Laminate Chassis	
93 x 14 x 29	160	NSS9329WH336W	2855	"G" Style N/A		NSS9329WH336M	1719
87 x 14 x 29	150	NSS8729WH336W	2675	"G" Style N/A		NSS8729WH336M	1660
83 x 14 x 29	140	NSS8329WH336W	2555	"G" Style N/A		NSS8329WH336M	1601
76 x 14 x 29	130	NSS7629WH336W	2345	"G" Style N/A		NSS7629WH336M	1546
70 x 14 x 29	120	NSS7029WH336W	2165	"G" Style N/A		NSS7029WH336M	1509
64 x 14 x 29	110	NSS6429WH336W	1985	"G" Style N/A		NSS6429WH336M	1414
58 x 14 x 29	100	NSS5829WH336W	1805	"G" Style N/A		NSS5829WH336M	1347
48 x 14 x 29	80	NSS4829WH336W	1560	"G" Style N/A		NSS4829WH336M	1083
35 x 14 x 29	60	NSS3529WH336W	1190	"G" Style N/A		NSS3529WH336M	883
29 x 14 x 29	50	NSS2929WH336W	1010	"G" Style N/A		NSS2929WH336M	811

**2 SELECT A FINISH**

"W" Veneer	"G" HPL	"M" TFL	
WAC	-	-	Amber Cherry
WRC	-	-	Caramel Cherry
WIC	-	-	Crimson Cherry
WEC	-	-	Ebony Cherry
WHC	-	MHC	Honey Cherry
WOC	-	MOC	KoKo Cherry
WSC	-	-	Scotch Cherry
WAM	-	-	Alabaster Maple
WCM	-	-	Clear Maple
WWM	-	-	Wheat Maple
WEW	-	-	Executive Walnut
WRW	GRW	-	Gray Luster Walnut
WGW	-	MGW	Gunstock Walnut
WJW	-	-	Judicial Walnut
WNW	-	-	Natural Walnut
WTW	-	MTW	Studio Teak Walnut
WWP	-	MWL	Designer White

**3 SELECT AN EDGE**

Edge Profile  
Option Not Available

**5 OPTIONS**

- TASK LIGHTING**
- LT-LED24: 24" LED Tasklight - \$90
  - LT-LED48: 48" LED Tasklight - \$165
  - LT-LED60: 60" LED Tasklight - \$180
  - LC22: 20" LT-LED Tasklight Linking Cable - \$20
  - WAR-D: Delete Tasklight Concealment Apron Rail - Deduct \$125

**4 SELECT HARDWARE**

Hardware  
Option Not Available

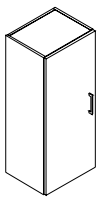

Hinged Left

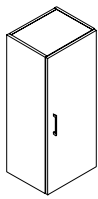

Hinged Right

PANEL DOORS / STORAGE

STANDARD FEATURES

- Adjustable finished shelves (Full Storage), 42" - 2 shelves, 54" - 3 shelves
- Interior shelf depth 12"
- "W" styles - 42" H units finished top, 54" H units black painted top

Plan application.

NOTES

- 1 Lock needed
- Unit has black back panel and is not designed for Open Plan use. Select OPB Option for Open

[CLICK HERE TO VIEW PRODUCT INDEX](#)

1 SELECT A STYLE

DIMENSIONS		STYLE NUMBER	LIST PRICE	STYLE NUMBER	LIST PRICE	STYLE NUMBER	LIST PRICE
W" x D" x H"	WGT	"W" Veneer Veneer Top Veneer Chassis		"G" HPL High Pressure Laminate Top Veneer Chassis		"M" TFL Thermally Fused Laminate Top Thermally Fused Laminate Chassis	
<b>Hinged Left</b>							
<b>42" Height</b>							
17.5 x 14 x 42	80	NSS1742OH340W	1320	"G" Style N/A		NSS1742OH340M	763
14.5 x 14 x 42	75	NSS1442OH340W	1260	"G" Style N/A		NSS1442OH340M	739
<b>54" Height</b>							
17.5 x 14 x 54	90	NSS1754OH340W	1465	"G" Style N/A		NSS1754OH340M	821
14.5 x 14 x 54	85	NSS1454OH340W	1405	"G" Style N/A		NSS1454OH340M	796
<b>Hinged Right</b>							
<b>42" Height</b>							
17.5 x 14 x 42	80	NSS1742OH341W	1320	"G" Style N/A		NSS1742OH341M	763
14.5 x 14 x 42	75	NSS1442OH341W	1260	"G" Style N/A		NSS1442OH341M	739
<b>54" Height</b>							
17.5 x 14 x 54	90	NSS1754OH341W	1465	"G" Style N/A		NSS1754OH341M	821
14.5 x 14 x 54	85	NSS1454OH341W	1405	"G" Style N/A		NSS1454OH341M	796

2 SELECT A FINISH

"W" Veneer	"G" HPL	"M" TFL	Finish
WAC	-	-	Amber Cherry
WRC	-	-	Caramel Cherry
WIC	-	-	Crimson Cherry
WEC	-	-	Ebony Cherry
WHC	-	MHC	Honey Cherry
WOC	-	MOC	KoKo Cherry
WSC	-	-	Scotch Cherry
WAM	-	-	Alabaster Maple
WCM	-	-	Clear Maple
WWM	-	-	Wheat Maple
WEW	-	-	Executive Walnut
WRW	GRW	-	Gray Luster Walnut
WGW	-	MGW	Gunstock Walnut
WJW	-	-	Judicial Walnut
WNV	-	-	Natural Walnut
WTW	-	MTW	Studio Teak Walnut
WWP	-	MWL	Designer White

3 SELECT AN EDGE

Edge Profile  
Option Not Available

5 OPTIONS

DOOR

- D2: Door Lock - \$95 per Door
- D6: Delete Doors - n/c
- D9SC: Soft Close Door Hinges - \$15 per Door
- WPD3061: Full fill designer white - \$75 per door

INTERIOR CABINET LIGHTING

- LEDPK starter kit includes Infeed, 1 Puck Interior Light and the ability to daisy chain up to 6 total Puck Lights
- LED Puck Starter Kit - \$295
- PK: 1 LED Interior Light - \$125

OPEN PLAN

- OPB: "W" "G" Style - Modify Unit for Open Plan Application - \$295
- OPBM: "M" Style - Modify Unit for Open Plan Application - \$95

SHELF

- GS14H: Replace Standard Shelves with Glass Shelves - \$65 per Shelf

4 SELECT HARDWARE



Touch Latch



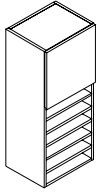

Hinged Left

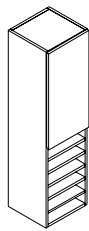

Hinged Right

**PANEL DOOR - STORAGE / ORGANIZER**

**STANDARD FEATURES**

- 54" unit has 1 adjustable shelf behind door
- Interior cabinet depth 12.5"
- Interior shelf depth 12"
- Organizer with 5 shelves
- Panel doors with concealed finger pull
- "W" styles - 42" H units finished top, 54" H units black painted top

- Unit has black back panel and is not designed for Open Plan use. Select OPB Option for Open Plan application.

**NOTES**

- 1 Lock needed

[CLICK HERE TO VIEW PRODUCT INDEX](#)

**1 SELECT A STYLE**

DIMENSIONS		STYLE NUMBER		LIST PRICE	STYLE NUMBER		LIST PRICE	STYLE NUMBER		LIST PRICE
W" x D" x H"	WGT	"W" Veneer	Veneer Top Veneer Chassis		"G" HPL	High Pressure Laminate Top Veneer Chassis		"M" TFL	Thermally Fused Laminate Top Thermally Fused Laminate Chassis	
<b>Hinged Left</b>										
<b>42" Height</b>										
17.5 x 14 x 42	80	NSS1742OH408W		1360	"G" Style N/A			NSS1742OH408M		861
14.5 x 14 x 42	75	NSS1442OH408W		1305	"G" Style N/A			NSS1442OH408M		837
<b>54" Height</b>										
17.5 x 14 x 54	90	NSS1754OH408W		1445	"G" Style N/A			NSS1754OH408M		919
14.5 x 14 x 54	85	NSS1454OH408W		1390	"G" Style N/A			NSS1454OH408M		894
<b>Hinged Right</b>										
<b>42" Height</b>										
17.5 x 14 x 42	80	NSS1742OH409W		1360	"G" Style N/A			NSS1742OH409M		861
14.5 x 14 x 42	75	NSS1442OH409W		1305	"G" Style N/A			NSS1442OH409M		837
<b>54" Height</b>										
17.5 x 14 x 54	90	NSS1754OH409W		1445	"G" Style N/A			NSS1754OH409M		919
14.5 x 14 x 54	85	NSS1454OH409W		1390	"G" Style N/A			NSS1454OH409M		894

**2 SELECT A FINISH**

"W" Veneer	"G" HPL	"M" TFL	
WAC	-	-	Amber Cherry
WRC	-	-	Caramel Cherry
WIC	-	-	Crimson Cherry
WEC	-	-	Ebony Cherry
WHC	-	MHC	Honey Cherry
WOC	-	MOC	KoKo Cherry
WSC	-	-	Scotch Cherry
WAM	-	-	Alabaster Maple
WCM	-	-	Clear Maple
WWM	-	-	Wheat Maple
WEW	-	-	Executive Walnut
WRW	GRW	-	Gray Luster Walnut
WGW	-	MGW	Gunstock Walnut
WJW	-	-	Judicial Walnut
WNV	-	-	Natural Walnut
WTW	-	MTW	Studio Teak Walnut
WWP	-	MWL	Designer White

**3 SELECT AN EDGE**

Edge Profile  
Option Not Available

**4 SELECT HARDWARE**

Hardware  
Option Not Available

**5 OPTIONS**

**DOOR**

- D2: Door Lock - \$95 per Door
- D6: Delete Doors - n/c
- D9SC: Soft Close Door Hinges - \$15 per Door
- WPD3061: Full fill designer white - \$75 per door

**INTERIOR CABINET LIGHTING**

- LEDPK starter kit includes Infeed, 1 Puck Interior Light and the ability to daisy chain up to 6 total Puck Lights
- LED Puck Starter Kit - \$295
- PK: 1 LED Interior Light - \$125

**OPEN PLAN**

- OPB: "W" "G" Style - Modify Unit for Open Plan Application - \$295
- OPBM: "M" Style - Modify Unit for Open Plan Application - \$95

**SHELF**

- GS14H: Replace Standard Shelves with Glass Shelves - \$65 per Shelf

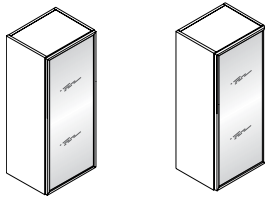

SILVERLUMA FRAME DOOR / STORAGE / ORGANIZER

STANDARD FEATURES

- Adjustable shelves (Full Storage), 42" - 2 shelves, 54" - 3 shelves
- Interior cabinet depth 12.5"
- Interior shelf depth 12"
- "W" styles - 42" H units finished top, 54" H units black painted top

for Open Plan use. Select OPB Option for Open Plan application.

NOTES

- 1 Lock needed
- Unit has black back panel and is not designed

[CLICK HERE TO VIEW PRODUCT INDEX](#)

**1 SELECT A STYLE**

DIMENSIONS		STYLE NUMBER	LIST PRICE	STYLE NUMBER	LIST PRICE	STYLE NUMBER	LIST PRICE
W" x D" x H"	WGT	"W" Veneer Veneer Top Veneer Chassis		"G" HPL High Pressure Laminate Top Veneer Chassis		"M" TFL Thermally Fused Laminate Top Thermally Fused Laminate Chassis	
<b>Hinged Left</b>							
<b>42" Height</b>							
17.5 x 14 x 42	85	NSS1742OH363W	1445	"G" Style N/A		NSS1742OH363M	908
14.5 x 14 x 42	80	NSS1442OH363W	1380	"G" Style N/A		NSS1442OH363M	883
<b>54" Height</b>							
17.5 x 14 x 54	95	NSS1754OH363W	1605	"G" Style N/A		NSS1754OH363M	965
14.5 x 14 x 54	90	NSS1454OH363W	1540	"G" Style N/A		NSS1454OH363M	941
<b>Hinged Right</b>							
<b>42" Height</b>							
17.5 x 14 x 42	85	NSS1742OH364W	1445	"G" Style N/A		NSS1742OH364M	908
14.5 x 14 x 42	80	NSS1442OH364W	1380	"G" Style N/A		NSS1442OH364M	883
<b>54" Height</b>							
17.5 x 14 x 54	95	NSS1754OH364W	1605	"G" Style N/A		NSS1754OH364M	965
14.5 x 14 x 54	90	NSS1454OH364W	1540	"G" Style N/A		NSS1454OH364M	941

**2 SELECT A FINISH**

"W" Veneer	"G" HPL	"M" TFL	Finish
WAC	-	-	Amber Cherry
WRC	-	-	Caramel Cherry
WIC	-	-	Crimson Cherry
WEC	-	-	Ebony Cherry
WHC	-	MHC	Honey Cherry
WOC	-	MOC	KoKo Cherry
WSC	-	-	Scotch Cherry
WAM	-	-	Alabaster Maple
WCM	-	-	Clear Maple
WWM	-	-	Wheat Maple
WEW	-	-	Executive Walnut
WRW	GRW	-	Gray Luster Walnut
WGW	-	MGW	Gunstock Walnut
WJW	-	-	Judicial Walnut
WNW	-	-	Natural Walnut
WTW	-	MTW	Studio Teak Walnut
WWP	-	MWL	Designer White

**3 SELECT AN EDGE**

Edge Profile  
Option Not Available

**5 OPTIONS**

DOOR

- D2: Door Lock for Glass Doors - \$95 per Door
- D6: Delete Doors - n/c
- D9SC: Soft Close Door Hinges - \$15 per Door
- WPD3061: Full fill designer white - \$75 per door

OPEN PLAN

- OPB: "W" "G" Style - Modify Unit for Open Plan Application - \$295
- OPBM: "M" Style - Modify Unit for Open Plan Application - \$95

INTERIOR CABINET LIGHTING

- LEDPK starter kit includes Infeed, 1 Puck Interior Light and the ability to daisy chain up to 6 total Puck Lights
- LED Puck Starter Kit - \$295
- PK: 1 LED Interior Light - \$125

SHELF

- GS14H: Replace Standard Shelves with Glass Shelves - \$65 per Shelf

**4 SELECT HARDWARE**



Touch Latch

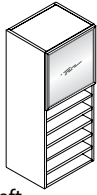

Hinged Left

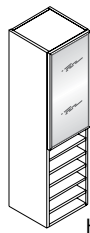

Hinged Right

SILVERLUMA FRAME DOOR / STORAGE / ORGANIZER

STANDARD FEATURES

- Organizer with 5 shelves
- 54" H unit has 1 adjustable shelf behind door
- Interior cabinet depth 12.5"
- Interior shelf depth 12"
- "W" styles - 42" H units finished top, 54" H units black painted top

for Open Plan use. Select OPB Option for Open Plan application.

NOTES

- 1 Lock needed
- Unit has black back panel and is not designed

[CLICK HERE TO VIEW PRODUCT INDEX](#)

1 SELECT A STYLE

DIMENSIONS		STYLE NUMBER	LIST PRICE	STYLE NUMBER	LIST PRICE	STYLE NUMBER	LIST PRICE
W" x D" x H"	WGT	"W" Veneer Veneer Top Veneer Chassis		"G" HPL High Pressure Laminate Top Veneer Chassis		"M" TFL Thermally Fused Laminate Top Thermally Fused Laminate Chassis	
<b>Hinged Left</b>							
<b>42" Height</b>							
17.5 x 14 x 42	85	NSS1742OH416W	1455	"G" Style N/A		NSS1742OH416M	938
14.5 x 14 x 42	80	NSS1442OH416W	1395	"G" Style N/A		NSS1442OH416M	914
<b>54" Height</b>							
17.5 x 14 x 54	95	NSS1754OH416W	1595	"G" Style N/A		NSS1754OH416M	997
14.5 x 14 x 54	90	NSS1454OH416W	1540	"G" Style N/A		NSS1454OH416M	972
<b>Hinged Right</b>							
<b>42" Height</b>							
17.5 x 14 x 42	85	NSS1742OH417W	1455	"G" Style N/A		NSS1742OH417M	938
14.5 x 14 x 42	80	NSS1442OH417W	1395	"G" Style N/A		NSS1442OH417M	914
<b>54" Height</b>							
17.5 x 14 x 54	95	NSS1754OH417W	1595	"G" Style N/A		NSS1754OH417M	997
14.5 x 14 x 54	90	NSS1454OH417W	1540	"G" Style N/A		NSS1454OH417M	972

2 SELECT A FINISH

"W" Veneer	"G" HPL	"M" TFL	
WAC	-	-	Amber Cherry
WRC	-	-	Caramel Cherry
WIC	-	-	Crimson Cherry
WEC	-	-	Ebony Cherry
WHC	-	MHC	Honey Cherry
WOC	-	MOC	KoKo Cherry
WSC	-	-	Scotch Cherry
WAM	-	-	Alabaster Maple
WCM	-	-	Clear Maple
WWM	-	-	Wheat Maple
WEW	-	-	Executive Walnut
WRW	GRW	-	Gray Luster Walnut
WGW	-	MGW	Gunstock Walnut
WJW	-	-	Judicial Walnut
WNW	-	-	Natural Walnut
WTW	-	MTW	Studio Teak Walnut
WWP	-	MWL	Designer White

3 SELECT AN EDGE

Edge Profile  
Option Not Available

5 OPTIONS

DOOR

- D2: Door Lock - \$95 per Door
- D9SC: Soft Close Door Hinges - \$15 per Door
- WPD3061: Full fill designer white - \$75 per door

INTERIOR CABINET LIGHTING

- LEDPK starter kit includes Infeed, 1 Puck Interior Light and the ability to daisy chain up to 6 total Puck Lights
- LED Puck Starter Kit - \$295
- PK: 1 LED Interior Light - \$125

OPEN PLAN

- OPB: "W" "G" Style - Modify Unit for Open Plan Application - \$295
- OPBM: "M" Style - Modify Unit for Open Plan Application - \$95

SHELF

- GS14H: Replace Standard Shelves with Glass Shelves - \$65 per Shelf

4 SELECT HARDWARE

Hardware  
Option Not Available

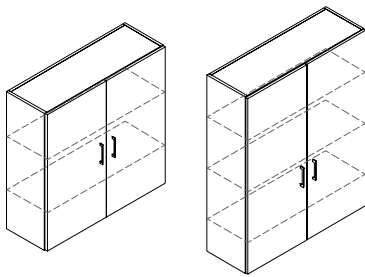

**PANEL DOORS / STORAGE**

**STANDARD FEATURES**

- 54" H unit has 1 adjustable shelf behind door
- Adjustable shelves (Full Storage), 42" - 2 shelves, 54" - 3 shelves
- Interior shelf depth 12"
- Interior cabinet depth 12.5"
- "W" styles - 42" H units finished top, 54" H units black painted top

- Unit has black back panel and is not designed for Open Plan use. Select OPB Option for Open Plan application.

**NOTES**

- 1 Lock needed

[CLICK HERE TO VIEW PRODUCT INDEX](#)

**1 SELECT A STYLE**

DIMENSIONS		STYLE NUMBER	LIST PRICE	STYLE NUMBER	LIST PRICE	STYLE NUMBER	LIST PRICE
W" x D" x H"	WGT	"W" Veneer Top Veneer Chassis		"G" HPL High Pressure Laminate Top Veneer Chassis		"M" TFL Thermally Fused Laminate Top Thermally Fused Laminate Chassis	
<b>42" Height</b>							
42 x 14 x 42	150	NSS4242OH383W	1880	"G" Style N/A		NSS4242OH383M	1057
35 x 14 x 42	130	NSS3542OH383W	1635	"G" Style N/A		NSS3542OH383M	992
29 x 14 x 42	120	NSS2942OH383W	1570	"G" Style N/A		NSS2942OH383M	965
<b>54" Height</b>							
42 x 14 x 54	165	NSS4254OH383W	2060	"G" Style N/A		NSS4254OH383M	1163
35 x 14 x 54	145	NSS3554OH383W	1795	"G" Style N/A		NSS3554OH383M	1098
29 x 14 x 54	135	NSS2954OH383W	1725	"G" Style N/A		NSS2954OH383M	1069

**2 SELECT A FINISH**

"W" Veneer	"G" HPL	"M" TFL	Finish
WAC	-	-	Amber Cherry
WRC	-	-	Caramel Cherry
WIC	-	-	Crimson Cherry
WEC	-	-	Ebony Cherry
WHC	-	MHC	Honey Cherry
WOC	-	MOC	KoKo Cherry
WSC	-	-	Scotch Cherry
WAM	-	-	Alabaster Maple
WCM	-	-	Clear Maple
WWM	-	-	Wheat Maple
WEW	-	-	Executive Walnut
WRW	GRW	-	Gray Luster Walnut
WGW	-	MGW	Gunstock Walnut
WJW	-	-	Judicial Walnut
WNW	-	-	Natural Walnut
WTW	-	MTW	Studio Teak Walnut
WWP	-	MWL	Designer White

**3 SELECT AN EDGE**

Edge Profile Option Not Available

**5 OPTIONS**

**DOOR**

- D2: Door Lock - \$95 per door set
- D6: Delete Doors - n/c
- D9SC: Soft Close Door Hinges - \$15 per Door
- WPD3061: Full fill designer white - \$75 per door

**INTERIOR CABINET LIGHTING**

- LEDPK starter kit includes Infeed, 1 Puck Interior Light and the ability to daisy chain up to 6 total Puck Lights
- LED Puck Starter Kit - \$295
- PK: 1 LED Interior Light - \$125

**OPEN PLAN**

- OPB: "W" "G" Style - Modify Unit for Open Plan Application - \$295
- OPBM: "M" Style - Modify Unit for Open Plan Application - \$95

**SHELF**

- S714F: Heavy Duty Lumber 1" Shelves - \$75 per Shelf ("M" Styles - n/a)
- GS14F: Replace Standard Shelves with Glass Shelves - \$85 per Shelf

**4 SELECT HARDWARE**

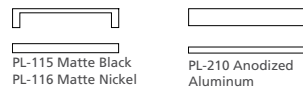

Touch Latch

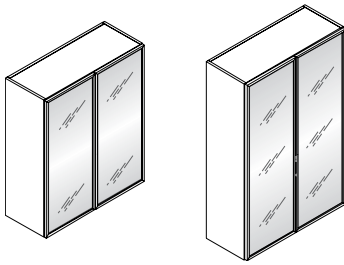

**SILVERLUMA FRAME / DOORS / STORAGE**

**STANDARD FEATURES**

- Adjustable shelves (Full Storage), 42" - 2 shelves, 54" - 3 shelves
- Interior cabinet depth 12.5"
- Interior shelf depth 12"
- "W" styles - 42" H units finished top, 54" H units black painted top

for Open Plan use. Select OPB Option for Open Plan application.

**NOTES**

- 1 Lock needed
- Unit has black back panel and is not designed

[CLICK HERE TO VIEW PRODUCT INDEX](#)

**1 SELECT A STYLE**

DIMENSIONS		STYLE NUMBER	LIST PRICE	STYLE NUMBER	LIST PRICE	STYLE NUMBER	LIST PRICE
W" x D" x H"	WGT	"W" Veneer Top Veneer Chassis		"G" HPL High Pressure Laminate Top Veneer Chassis		"M" TFL Thermally Fused Laminate Top Thermally Fused Laminate Chassis	
42" Height							
35 x 14 x 42	130	NSS3542OH382W	1885	"G" Style N/A		NSS3542OH382M	1283
29 x 14 x 42	120	NSS2942OH382W	1810	"G" Style N/A		NSS2942OH382M	1254
54" Height							
35 x 14 x 54	145	NSS3554OH382W	2075	"G" Style N/A		NSS3554OH382M	1387
29 x 14 x 54	135	NSS2954OH382W	1995	"G" Style N/A		NSS2954OH382M	1360

**2 SELECT A FINISH**

"W" Veneer	"G" HPL	"M" TFL	
WAC	-	-	Amber Cherry
WRC	-	-	Caramel Cherry
WIC	-	-	Crimson Cherry
WEC	-	-	Ebony Cherry
WHC	-	MHC	Honey Cherry
WOC	-	MOC	KoKo Cherry
WSC	-	-	Scotch Cherry
WAM	-	-	Alabaster Maple
WCM	-	-	Clear Maple
WWM	-	-	Wheat Maple
WEW	-	-	Executive Walnut
WRW	GRW	-	Gray Luster Walnut
WGW	-	MGW	Gunstock Walnut
WJW	-	-	Judicial Walnut
WNW	-	-	Natural Walnut
WTW	-	MTW	Studio Teak Walnut
WWP	-	MWL	Designer White

**3 SELECT AN EDGE**

Edge Profile Option Not Available

**5 OPTIONS**

**DOOR**

- D2: Door Lock for Glass Doors - \$95 per door set
- D9SC: Soft Close Door Hinges - \$15 per Door
- WPD3061: Full fill designer white - \$75 per door

**INTERIOR CABINET LIGHTING**

- LEDPK starter kit includes Infeed, 1 Puck Interior Light and the ability to daisy chain up to 6 total Puck Lights
- LED Puck Starter Kit - \$295
- PK: 1 LED Interior Light - \$125

**OPEN PLAN**

- OPB: "W" "G" Style - Modify Unit for Open Plan Application - \$295
- OPBM: "M" Style - Modify Unit for Open Plan Application - \$95

**PULL**

- Delete Pulls - Add Touch Latch - n/c

**SHELF**

- S714F: Heavy Duty Lumber 1" Shelves - \$75 per Shelf ("M" Styles - n/a)
- GS14F: Replace Standard Shelves with Glass Shelves - \$85 per Shelf

**4 SELECT HARDWARE**

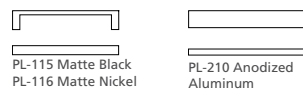

Touch Latch

# NOT SO SQUARE OFFICE FREESTANDING HALF TOWERS

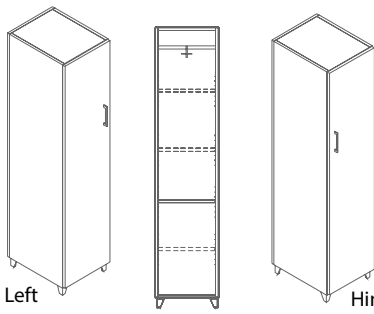

Hinged Left

Hinged Right

## WARDROBE / STORAGE

### STANDARD FEATURES

- Interior cabinet depth 12.5"
- Full extension drawers
- Locking drawers
- Standard fixed shelf with 3 adjustable shelves (83")
- Standard fixed shelf with 3 adjustable shelves (71")
- Standard Silver Feet (optional White, Black)
- "W" styles - 71" H units finished top, 83" H units black painted top

### NOTES

- Flush cut credenza ends when ganging towers to credenza
- Unit has black back panel and is not designed for Open Plan use. Select OPB Option for Open Plan application.

[CLICK HERE TO VIEW PRODUCT INDEX](#)

## 1 SELECT A STYLE

DIMENSIONS		STYLE NUMBER		LIST PRICE	STYLE NUMBER		LIST PRICE	STYLE NUMBER		LIST PRICE
W" x D" x H"	WGT	"W" Veneer	Veneer Top Veneer Chassis		"G" HPL	High Pressure Laminate Top Veneer Chassis		"M" TFL	Thermally Fused Laminate Top Thermally Fused Laminate Chassis	
<b>Door Hinged Left</b>										
16 x 21 x 83	180	NSS1683TW283W		2860	"G" Style N/A			NSS1683TW283M		1368
16 x 21 x 71	165	NSS1671TW283W		2720	"G" Style N/A			NSS1671TW283M		1212
<b>Door Hinged Right</b>										
16 x 21 x 83	180	NSS1683TW284W		2860	"G" Style N/A			NSS1683TW284M		1368
16 x 21 x 71	165	NSS1671TW284W		2720	"G" Style N/A			NSS1671TW284M		1212

## 2 SELECT A FINISH

"W" Veneer	"G" HPL	"M" TFL	
WAC	-	-	Amber Cherry
WRC	-	-	Caramel Cherry
WIC	-	-	Crimson Cherry
WEC	-	-	Ebony Cherry
WHC	-	MHC	Honey Cherry
WOC	-	MOC	KoKo Cherry
WSC	-	-	Scotch Cherry
WAM	-	-	Alabaster Maple
WCM	-	-	Clear Maple
WWM	-	-	Wheat Maple
WEW	-	-	Executive Walnut
WRW	GRW	-	Gray Luster Walnut
WGW	-	MGW	Gunstock Walnut
WJW	-	-	Judicial Walnut
WNW	-	-	Natural Walnut
WTW	-	MTW	Studio Teak Walnut
WWP	-	MWL	Designer White

METAL FINISHES

MFB	-	-	Black (Premium Finish)
MFS	-	-	Silver
MFW	-	-	White (Premium Finish)

## 3 SELECT AN EDGE

Edge Profile  
Option Not  
Available

## 4 SELECT HARDWARE

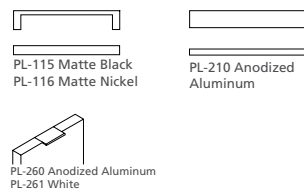

## 5 OPTIONS

### DOOR

- D2: Door Lock - \$95 per Door Set
- D6: Delete Doors - n/c
- D9SC: Soft Close Door Hinges - \$15 per Door
- WPD3061: Full fill designer white - \$75 per door

### FEET

- D8: Delete feet (extend fronts to floor) - n/c

### OPEN PLAN

- OPB: "W" "G" Style - Modify Unit for Open Plan Application - \$295
- OPBM: "M" Style - Modify Unit for Open Plan Application - \$95

### PREMIUM FINISH OPTION

- MFB: Black metal finish - \$25 per foot
- MFW: White metal finish - \$25 per foot

# NOT SO SQUARE OFFICE FREESTANDING HALF TOWERS

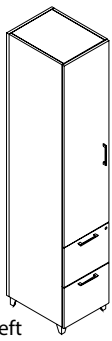

Hinged Left

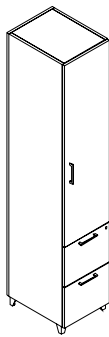

Hinged Right

## STORAGE / FILE

### STANDARD FEATURES

- Interior cabinet depth 12.5"
- Soft close suspension drawer(s)
- Standard fixed shelf with 2 adjustable shelves (71")
- Standard fixed shelf with 3 adjustable shelves (83")
- Standard Silver Feet (optional White, Black)
- "W" styles - 71" H units finished top, 83" H units black painted top

### NOTES

- Flush cut credenza ends when ganging towers to credenza
- Unit has black back panel and is not designed for Open Plan use. Select OPB Option for Open Plan application.

[CLICK HERE TO VIEW PRODUCT INDEX](#)

## 1 SELECT A STYLE

DIMENSIONS		STYLE NUMBER	LIST PRICE	STYLE NUMBER	LIST PRICE	STYLE NUMBER	LIST PRICE
W" x D" x H"	WGT	"W" Veneer Veneer Top Veneer Chassis		"G" HPL High Pressure Laminate Top Veneer Chassis		"M" TFL Thermally Fused Laminate Top Thermally Fused Laminate Chassis	
<b>Door Hinged Left</b>							
16 x 21 x 83	190	NSS1683TW291W	2980	"G" Style N/A		NSS1683TW291M	1652
16 x 21 x 71	175	NSS1671TW291W	2835	"G" Style N/A		NSS1671TW291M	1495
<b>Door Hinged Right</b>							
16 x 21 x 83	190	NSS1683TW292W	2980	"G" Style N/A		NSS1683TW292M	1652
16 x 21 x 71	175	NSS1671TW292W	2835	"G" Style N/A		NSS1671TW292M	1495

## 2 SELECT A FINISH

"W" Veneer	"G" HPL	"M" TFL	Finish
WAC	-	-	Amber Cherry
WRC	-	-	Caramel Cherry
WIC	-	-	Crimson Cherry
WEC	-	-	Ebony Cherry
WHC	-	MHC	Honey Cherry
WOC	-	MOC	KoKo Cherry
WSC	-	-	Scotch Cherry
WAM	-	-	Alabaster Maple
WCM	-	-	Clear Maple
WWM	-	-	Wheat Maple
WEW	-	-	Executive Walnut
WRW	GRW	-	Gray Luster Walnut
WGW	-	MGW	Gunstock Walnut
WJW	-	-	Judicial Walnut
WNW	-	-	Natural Walnut
WTW	-	MTW	Studio Teak Walnut
WWP	-	MWL	Designer White

METAL FINISHES

MFB	-	-	Black (Premium Finish)
MFS	-	-	Silver
MFW	-	-	White (Premium Finish)

## 3 SELECT AN EDGE

Edge Profile  
Option Not Available

## 4 SELECT HARDWARE

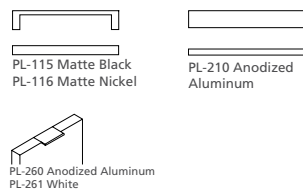

## 5 OPTIONS

### DOOR

- D2: Door Lock - \$95 per Door Set
- D6: Delete Doors - n/c
- D9SC: Soft Close Door Hinges - \$15 per Door
- WPD3061: Full fill designer white - \$75 per door

### DRAWER

- P6: Modify File/File to Box/Box/File - \$50 per pedestal
- P33: Wood Drawer Upgrade - \$40 per drawer

### FEET

- D8: Delete feet (extend fronts to floor) - n/c

### OPEN PLAN

- OPB: "W" "G" Style - Modify Unit for Open Plan Application - \$295
- OPBM: "M" Style - Modify Unit for Open Plan Application - \$95

### PREMIUM FINISH OPTION

- MFB: Black metal finish - \$25 per foot
- MFW: White metal finish - \$25 per foot

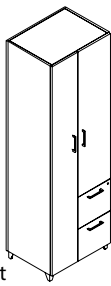

Wardrobe Left

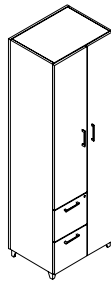

Wardrobe Right

**STORAGE / FILE- MINI-WARDROBE**

**STANDARD FEATURES**

- Interior cabinet depth 12.5"
- Full extension drawers
- Locking drawers
- Soft close suspension drawer(s)
- Standard fixed shelf with 2 adjustable shelves (71")
- Standard fixed shelf with 3 adjustable shelves (83")
- Standard Silver Feet (optional White, Black)
- "W" styles - 71" H units finished top, 83" H

units black painted top

**NOTES**

- Flush cut credenza ends when ganging towers to credenza

[CLICK HERE TO VIEW PRODUCT INDEX](#)

**1 SELECT A STYLE**

DIMENSIONS		STYLE NUMBER	LIST PRICE	STYLE NUMBER	LIST PRICE	STYLE NUMBER	LIST PRICE
W" x D" x H"	WGT	"W" Veneer Top Veneer Chassis		"G" HPL High Pressure Laminate Top Veneer Chassis		"M" TFL Thermally Fused Laminate Top Thermally Fused Laminate Chassis	
<b>Wardrobe Left</b>							
26 x 21 x 83	265	NSS2683TW293W	3580	"G" Style N/A		NSS2683TW293M	1892
26 x 21 x 71	240	NSS2671TW293W	3420	"G" Style N/A		NSS2671TW293M	1684
<b>Wardrobe Right</b>							
26 x 21 x 83	265	NSS2683TW294W	3580	"G" Style N/A		NSS2683TW294M	1892
26 x 21 x 71	240	NSS2671TW294W	3420	"G" Style N/A		NSS2671TW294M	1684

**2 SELECT A FINISH**

"W" Veneer	"G" HPL	"M" TFL	
WAC	-	-	Amber Cherry
WRC	-	-	Caramel Cherry
WIC	-	-	Crimson Cherry
WEC	-	-	Ebony Cherry
WHC	-	MHC	Honey Cherry
WOC	-	MOC	KoKo Cherry
WSC	-	-	Scotch Cherry
WAM	-	-	Alabaster Maple
WCM	-	-	Clear Maple
WWM	-	-	Wheat Maple
WEW	-	-	Executive Walnut
WRW	GRW	-	Gray Luster Walnut
WGW	-	MGW	Gunstock Walnut
WJW	-	-	Judicial Walnut
WNW	-	-	Natural Walnut
WTW	-	MTW	Studio Teak Walnut
WWP	-	MWL	Designer White

**METAL FINISHES**

MFB	-	-	Black (Premium Finish)
MFS	-	-	Silver
MFW	-	-	White (Premium Finish)

**3 SELECT AN EDGE**

Edge Profile Option Not Available

**5 OPTIONS**

**DOOR**

- D2: Door Lock - \$95 per Door Set
- D6: Delete Doors - n/c
- D9SC: Soft Close Door Hinges - \$15 per Door
- WPD3061: Full fill designer white - \$75 per door

**DRAWER**

- P6: Modify File/File to Box/Box/File - \$50 per pedestal
- P33: Wood Drawer Upgrade - \$40 per drawer

**FEET**

- D8: Delete feet (extend fronts to floor) - n/c

**OPEN PLAN**

- OPB: "W" "G" Style - Modify Unit for Open Plan Application - \$295
- OPBM: "M" Style - Modify Unit for Open Plan Application - \$95

**PREMIUM FINISH OPTION**

- MFB: Black metal finish - \$25 per foot
- MFW: White metal finish - \$25 per foot

**4 SELECT HARDWARE**

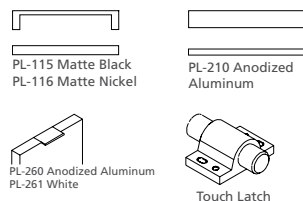



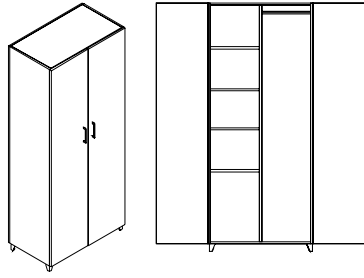

**WARDROBE / STORAGE FULL TOWER**

**STANDARD FEATURES**

- 3 adjustable shelves, 2 fixed
- Interior cabinet depth 12.5"
- Standard 2 fixed shelves with 2 adjustable shelves (71")
- Standard 2 fixed shelves with 3 adjustable shelves (83")
- Standard Silver Feet (optional White, Black)
- Wardrobe left, storage right
- "W" styles - 71" H units finished top, 83" H units black painted top

**NOTES**

- Flush cut credenza ends when ganging towers to credenza
- Unit has black back panel and is not designed for Open Plan use. Select OPB Option for Open Plan application.
- When specifying MOD310P, 1 lock needed

[CLICK HERE TO VIEW PRODUCT INDEX](#)

**1 SELECT A STYLE**

DIMENSIONS		STYLE NUMBER		LIST PRICE	STYLE NUMBER		LIST PRICE	STYLE NUMBER		LIST PRICE
W" x D" x H"	WGT	"W" Veneer Veneer Top Veneer Chassis			"G" HPL High Pressure Laminate Top Veneer Chassis			"M" TFL Thermally Fused Laminate Top Thermally Fused Laminate Chassis		
<b>83" Height</b>										
35 x 21 x 83	310	NSS3583TW275W		3840	"G" Style N/A			NSS3583TW275M		1883
29 x 21 x 83	265	NSS2983TW275W		3590	"G" Style N/A			NSS2983TW275M		1826
71" Height										
35 x 21 x 71	285	NSS3571TW275W		3435	"G" Style N/A			NSS3571TW275M		1676
29 x 21 x 71	240	NSS2971TW275W		3185	"G" Style N/A			NSS2971TW275M		1619

**2 SELECT A FINISH**

"W" Veneer	"G" HPL	"M" TFL	
WAC	-	-	Amber Cherry
WRC	-	-	Caramel Cherry
WIC	-	-	Crimson Cherry
WEC	-	-	Ebony Cherry
WHC	-	MHC	Honey Cherry
WOC	-	MOC	KoKo Cherry
WSC	-	-	Scotch Cherry
WAM	-	-	Alabaster Maple
WCM	-	-	Clear Maple
WWM	-	-	Wheat Maple
WEW	-	-	Executive Walnut
WRW	GRW	-	Gray Luster Walnut
WGW	-	MGW	Gunstock Walnut
WJW	-	-	Judicial Walnut
WNW	-	-	Natural Walnut
WTW	-	MTW	Studio Teak Walnut
WWP	-	MWL	Designer White

**METAL FINISHES**

MFB	-	-	Black (Premium Finish)
MFS	-	-	Silver
MFW	-	-	White (Premium Finish)

**3 SELECT AN EDGE**

Edge Profile Option Not Available

**5 OPTIONS**

**DOOR**

- D2: Door Lock - \$95 per Door Set
- D6: Delete Doors - n/c
- D9SC: Soft Close Door Hinges - \$15 per Door
- WPD3061: Full fill designer white - \$75 per door

**FEET**

- D8: Delete feet (extend fronts to floor) - n/c

**OPEN PLAN**

- OPB: "W" "G" Style - Modify Unit for Open Plan Application - \$295
- OPBM: "M" Style - Modify Unit for Open Plan Application - \$95

**SHELF**

- MOD310P: Delete Center Partition / Add (3 - 71" / 4 - 83") Full Width Adj. Shelves & (1) Fixed - \$295

**PREMIUM FINISH OPTION**

- MFB: Black metal finish - \$25 per foot
- MFW: White metal finish - \$25 per foot

**4 SELECT HARDWARE**

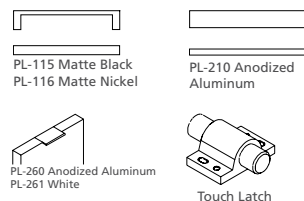

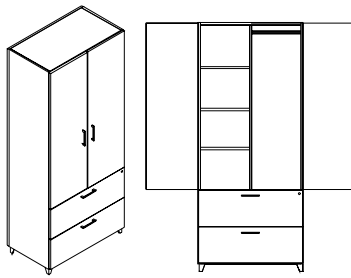

**STORAGE / FILE FULL TOWER**

**STANDARD FEATURES**

- 71" has 2 adj. shelves / 1 fixed shelf
- 83" has 3 adj. shelves / 1 fixed shelf
- Adjustable shelf per door section
- Full extension drawers
- Locking drawers
- Soft close suspension drawer(s)
- Standard Silver Feet (optional White, Black)
- "W" styles - 71" H units finished top, 83" H units black painted top
- Wardrobe left, storage right

**NOTES**

- Flush cut credenza ends when ganging towers to credenza
- Unit has black back panel and is not designed for Open Plan use. Select OPB Option for Open Plan application.

[CLICK HERE TO VIEW PRODUCT INDEX](#)

**1 SELECT A STYLE**

DIMENSIONS		STYLE NUMBER	LIST PRICE	STYLE NUMBER	LIST PRICE	STYLE NUMBER	LIST PRICE
"W" x "D" x "H"	WGT	"W" Veneer Top Veneer Chassis		"G" HPL High Pressure Laminate Top Veneer Chassis		"M" TFL Thermally Fused Laminate Top Thermally Fused Laminate Chassis	
<b>83" Height</b>							
35 x 21 x 83	350	NSS3583TW281W	4055	"G" Style N/A		NSS3583TW281M	2146
29 x 21 x 83	325	NSS2983TW281W	3850	"G" Style N/A		NSS2983TW281M	2107
<b>71" Height</b>							
35 x 21 x 71	325	NSS3571TW281W	3620	"G" Style N/A		NSS3571TW281M	1937
29 x 21 x 71	295	NSS2971TW281W	3440	"G" Style N/A		NSS2971TW281M	1893

**2 SELECT A FINISH**

"W" Veneer	"G" HPL	"M" TFL	
WAC	-	-	Amber Cherry
WRC	-	-	Caramel Cherry
WIC	-	-	Crimson Cherry
WEC	-	-	Ebony Cherry
WHC	-	MHC	Honey Cherry
WOC	-	MOC	KoKo Cherry
WSC	-	-	Scotch Cherry
WAM	-	-	Alabaster Maple
WCM	-	-	Clear Maple
WWM	-	-	Wheat Maple
WEW	-	-	Executive Walnut
WRW	GRW	-	Gray Luster Walnut
WGW	-	-	Gunstock Walnut
WJW	-	-	Judicial Walnut
WNW	-	-	Natural Walnut
WTW	-	MTW	Studio Teak Walnut
WWP	-	MWL	Designer White

  

METAL FINISHES		
MFB	-	Black (Premium Finish)
MFS	-	Silver
MFW	-	White (Premium Finish)

**3 SELECT AN EDGE**

Edge Profile Option Not Available

**4 SELECT HARDWARE**

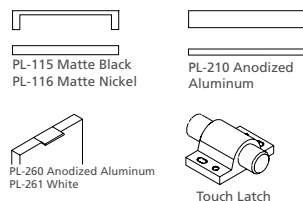

**5 OPTIONS**

**DOOR**

- D2: Door Lock - \$95 per Door Set
- D6: Delete Doors - n/c
- D9SC: Soft Close Door Hinges - \$15 per Door
- WPD3061: Full fill designer white - \$75 per door

**DRAWER**

- P33: Wood Drawer Upgrade - \$40 per drawer

**FEET**

- D8: Delete feet (extend fronts to floor) - n/c

**OPEN PLAN**

- OPB: "W" "G" Style - Modify Unit for Open Plan Application - \$295
- OPBM: "M" Style - Modify Unit for Open Plan Application - \$95

**SHELF**

- MOD300P: Delete Center Partition / Add 2 (71") or 3 (83") Full Width Adj. Shelves - \$295

**PREMIUM FINISH OPTION**

- MFB: Black metal finish - \$25 per foot
- MFW: White metal finish - \$25 per foot

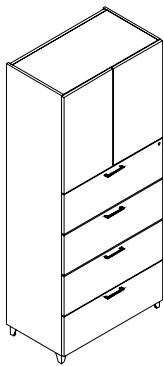

LATERAL FILE / STORAGE

STANDARD FEATURES

- Full extension drawers
- Full extension drawers - locking
- Soft close suspension drawer(s)
- Standard Silver Feet (optional White, Black)
- Upper storage doors standard with touch latch
- "W" styles - 71" H units finished top, 83" H units black painted top

- 83" H has 1 adjustable shelf
- Unit has black back panel and is not designed for Open Plan use. Select OPB Option for Open Plan application.

NOTES

- 71" H has no shelf

[CLICK HERE TO VIEW PRODUCT INDEX](#)

1 SELECT A STYLE

DIMENSIONS		STYLE NUMBER	LIST PRICE	STYLE NUMBER	LIST PRICE	STYLE NUMBER	LIST PRICE
W" x D" x H"	WGT	"W" Veneer Top Veneer Chassis		"G" High Pressure Laminate Top Veneer Chassis		"M" Thermally Fused Laminate Top Thermally Fused Laminate Chassis	
<b>83" Height</b>							
35 x 21 x 83	375	NSS3583TW276W	4255	"G" Style N/A		NSS3583TW276M	2355
29 x 21 x 83	350	NSS2983TW276W	4050	"G" Style N/A		NSS2983TW276M	2314
<b>71" Height</b>							
35 x 21 x 71	350	NSS3571TW276W	3820	"G" Style N/A		NSS3571TW276M	2146
29 x 21 x 71	315	NSS2971TW276W	3640	"G" Style N/A		NSS2971TW276M	2098

2 SELECT A FINISH

"W" Veneer	"G" HPL	"M" TFL	Finish
WAC	-	-	Amber Cherry
WRC	-	-	Caramel Cherry
WIC	-	-	Crimson Cherry
WEC	-	-	Ebony Cherry
WHC	-	MHC	Honey Cherry
WOC	-	MOC	KoKo Cherry
WSC	-	-	Scotch Cherry
WAM	-	-	Alabaster Maple
WCM	-	-	Clear Maple
WWM	-	-	Wheat Maple
WEW	-	-	Executive Walnut
WRW	GRW	-	Gray Luster Walnut
WGW	-	MGW	Gunstock Walnut
WJW	-	-	Judicial Walnut
WNW	-	-	Natural Walnut
WTW	-	MTW	Studio Teak Walnut
WWP	-	MWL	Designer White

  

METAL FINISHES		Finish
MFB	-	Black (Premium Finish)
MFS	-	Silver
MFW	-	White (Premium Finish)

3 SELECT AN EDGE

Edge Profile Option Not Available

4 SELECT HARDWARE

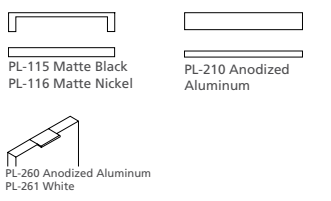

5 OPTIONS

- DOOR**
- D2: Door Lock - \$95 per Door Set
  - D6: Delete Doors - n/c
  - D9SC: Soft Close Door Hinges - \$15 per Door
  - WPD3061: Full fill designer white - \$75 per door
- DRAWER**
- P33: Wood Drawer Upgrade - \$40 per drawer
- FEET**
- D8: Delete feet (extend fronts to floor) - n/c
- OPEN PLAN**
- OPB: "W" "G" Style - Modify Unit for Open Plan Application - \$295
  - OPBM: "M" Style - Modify Unit for Open Plan Application - \$95
- SHELF**
- GS14F: Replace Standard Shelves with Glass Shelves - \$85 per Shelf
  - S714F: Heavy Duty Lumber 1" Shelves - \$75 per Shelf ("M" Styles - n/a)
- PREMIUM FINISH OPTION**
- MFB: Black metal finish - \$25 per foot
  - MFW: White metal finish - \$25 per foot

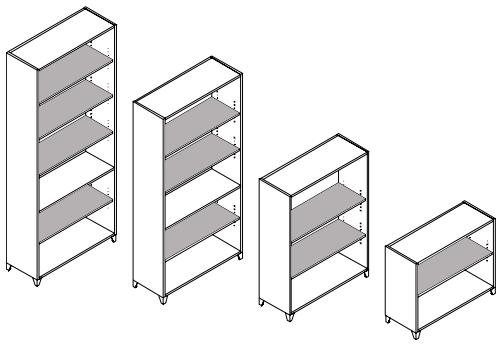

**FREESTANDING**

**STANDARD FEATURES**

- 3/4" thick back
- Interior shelf depth 12"
- Metal legs standard
- Standard Silver Feet (optional White, Black)
- "W" styles - 29", 48", 60", and 71" H units finished top, 83" H units black painted top

- specify storage Credenza on pg 13 and delete doors.
- Unit has black back panel and is not designed for Open Plan use. Select OPB Option for Open Plan application.

**NOTES**

- Adjustable shelves shaded in gray
- For bookcase unit to align w/ work surface

[CLICK HERE TO VIEW PRODUCT INDEX](#)

**1 SELECT A STYLE**

DIMENSIONS		STYLE NUMBER	LIST PRICE	STYLE NUMBER	LIST PRICE	STYLE NUMBER	LIST PRICE
"W" x "D" x "H"	WGT	"W" Veneer Top Veneer Chassis		"G" HPL High Pressure Laminate Top Veneer Chassis		"M" TFL Thermally Fused Laminate Top Thermally Fused Laminate Chassis	
<b>35" Width</b>							
35 x 14 x 83	195	NSS3583BK250W	2760	"G" Style N/A		NSS3583BK250M	1192
35 x 14 x 71	175	NSS3571BK250W	2485	"G" Style N/A		NSS3571BK250M	1104
35 x 14 x 60	155	NSS3560BK250W	2210	"G" Style N/A		NSS3560BK250M	1041
35 x 14 x 48	120	NSS3548BK250W	1505	"G" Style N/A		NSS3548BK250M	941
35 x 14 x 29	95	NSS3529BK250W	1335	"G" Style N/A		NSS3529BK250M	727
<b>29" Width</b>							
29 x 14 x 83	190	NSS2983BK250W	2565	"G" Style N/A		NSS2983BK250M	1169
29 x 14 x 71	170	NSS2971BK250W	2310	"G" Style N/A		NSS2971BK250M	1081
29 x 14 x 60	150	NSS2960BK250W	2055	"G" Style N/A		NSS2960BK250M	1018
29 x 14 x 48	115	NSS2948BK250W	2875	"G" Style N/A		NSS2948BK250M	917
29 x 14 x 29	90	NSS2929BK250W	1240	"G" Style N/A		NSS2929BK250M	1632

**2 SELECT A FINISH**

"W" Veneer	"G" HPL	"M" TFL	Finish
WAC	-	-	Amber Cherry
WRC	-	-	Caramel Cherry
WIC	-	-	Crimson Cherry
WEC	-	-	Ebony Cherry
WHC	-	MHC	Honey Cherry
WOC	-	MOC	KoKo Cherry
WSC	-	-	Scotch Cherry
WAM	-	-	Alabaster Maple
WCM	-	-	Clear Maple
WWM	-	-	Wheat Maple
WEW	-	-	Executive Walnut
WRW	GRW	-	Gray Luster Walnut
WGW	-	MGW	Gunstock Walnut
WJW	-	-	Judicial Walnut
WNW	-	-	Natural Walnut
WTW	-	MTW	Studio Teak Walnut
WWP	-	MWL	Designer White

METAL FINISHES

MFB	-	-	Black (Premium Finish)
MFS	-	-	Silver
MFW	-	-	White (Premium Finish)

**3 SELECT AN EDGE**

Edge Profile  
Option Not Available

**4 SELECT HARDWARE**

Hardware  
Option Not Available

**5 OPTIONS**

- FEET**  
- D8: Delete feet - n/c
- INTERIOR CABINET LIGHTING**  
LEDPK starter kit includes Infeed, 1 Puck Interior Light and the ability to daisy chain up to 6 total Puck Lights  
- LED Puck Starter Kit - \$295  
- PK: 1 LED Interior Light - \$125
- OPEN PLAN**  
- OPB: "W" "G" Style - Modify Unit for Open Plan Application - \$295  
- OPBM: "M" Style - Modify Unit for Open Plan Application - \$95
- SHELF**  
- GS14F: Replace Standard Shelves with Glass Shelves - \$85 per Shelf  
- S714F: Heavy Duty Lumber 1" Shelves - \$75 per Shelf ("M" Styles - n/a)
- PREMIUM FINISH OPTION**  
- MFB: Black metal finish - \$25 per foot  
- MFW: White metal finish - \$25 per foot

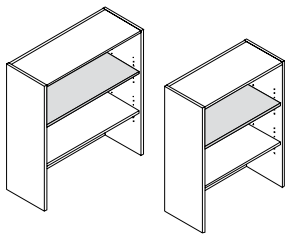

**SIT-ON OVERHEAD BOOKCASE**

**STANDARD FEATURES**

- 3/4" thick back
- 42" Height has 1 adj. shelf / 1 fixed shelf
- 54" Height has 2 adj. shelves / 1 fixed shelf
- Adjustable shelves shaded in gray
- Finished top
- Interior shelf depth 12"
- "W" styles - 42" H units finished top, 54" H units black painted top

- Adjustable shelves shaded in gray
- Unit has black back panel and is not designed for Open Plan use. Select OPB Option for Open Plan application.

**NOTES**

[CLICK HERE TO VIEW PRODUCT INDEX](#)

**1 SELECT A STYLE**

DIMENSIONS		STYLE NUMBER	LIST PRICE	STYLE NUMBER	LIST PRICE	STYLE NUMBER	LIST PRICE
W" x D" x H"	WGT	"W" Veneer Top Veneer Chassis		"G" HPL High Pressure Laminate Top Veneer Chassis		"M" TFL Thermally Fused Laminate Top Thermally Fused Laminate Chassis	
<b>35" Width</b>							
35 x 14 x 54	130	NSS3554OH380W	1535	"G" Style N/A		NSS3554OH380M	669
35 x 14 x 42	115	NSS3542OH380W	1410	"G" Style N/A		NSS3542OH380M	608
<b>29" Width</b>							
29 x 14 x 54	120	NSS2954OH380W	1470	"G" Style N/A		NSS2954OH380M	641
29 x 14 x 42	105	NSS2942OH380W	1350	"G" Style N/A		NSS2942OH380M	582

**2 SELECT A FINISH**

"W" Veneer	"G" HPL	"M" TFL	Finish
WAC	-	-	Amber Cherry
WRC	-	-	Caramel Cherry
WIC	-	-	Crimson Cherry
WEC	-	-	Ebony Cherry
WHC	-	MHC	Honey Cherry
WOC	-	MOC	KoKo Cherry
WSC	-	-	Scotch Cherry
WAM	-	-	Alabaster Maple
WCM	-	-	Clear Maple
WWM	-	-	Wheat Maple
WEW	-	-	Executive Walnut
WRW	GRW	-	Gray Luster Walnut
WGW	-	MGW	Gunstock Walnut
WJW	-	-	Judicial Walnut
WNW	-	-	Natural Walnut
WTW	-	MTW	Studio Teak Walnut
WWP	-	MWL	Designer White

**3 SELECT AN EDGE**

Edge Profile Option Not Available

**5 OPTIONS**

**INTERIOR CABINET LIGHTING**  
 LEDPK starter kit includes Infeed, 1 Puck Interior Light and the ability to daisy chain up to 6 total Puck Lights  
 - LED Puck Starter Kit - \$295  
 - PK: 1 LED Interior Light - \$125

**OPEN PLAN**  
 - OPB: "W" "G" Style - Modify Unit for Open Plan Application - \$295  
 - OPBM: "M" Style - Modify Unit for Open Plan Application - \$95

**SHELF**  
 - GS14F: Replace Standard Shelves with Glass Shelves - \$85 per Shelf  
 - S714F: Heavy Duty Lumber 1" Shelves - \$75 per Shelf ("M" Styles - n/a)

**4 SELECT HARDWARE**

Hardware Option Not Available

**BASE MODIFICATIONS**

**RUNOFF SLEIGH BASE**

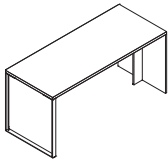

STYLE NUMBER	LIST PRICE	SPECIFICATIONS
<b>24" Metal Sleigh Base</b> SSB24	450	- Metal Sleigh base - standard in silver finish
<b>30" Metal Sleigh Base</b> SSB30	475	
<b>36" Metal Sleigh Base</b> SSB36	495	

Available: - Central, NOT SO square, Spaces

**COMPUTER SUPPORT**

**DELUXE SINGLE MONITOR ARM W/ USB POST**



STYLE NUMBER	LIST PRICE	SPECIFICATIONS
MA1952	495	<ul style="list-style-type: none"> <li>- (4) 2.0 USB Ports</li> <li>- Post Length: 22-1/2"H, Post Base Requires 80mm Dia. Hole</li> <li>- Spring Assist - Full Movement Arm, Arm Extends Up To 13 - 3/8"</li> <li>- Supports Screens Up To 24", Swivels 180 degrees - Mount Plate Tilts 85 degrees</li> <li>- Arm: Die Cast Aluminum</li> </ul> <p><b>Notes</b></p> <ul style="list-style-type: none"> <li>- Surface Factory Bored / Ready To Install</li> </ul>

Available: - All DARRAN Collections

**COMPUTER SUPPORT**

**DELUXE DOUBLE MONITOR ARM W/ USB POST**



STYLE NUMBER	LIST PRICE	SPECIFICATIONS
MA2952	795	<ul style="list-style-type: none"> <li>- (4) 2.0 USB Ports</li> <li>- Post Length: 22-1/2"H, Post Base Requires 80mm Dia. Hole</li> <li>- Spring Assist - Full Movement Arm, Arm Extends Up To 13 - 3/8"</li> <li>- Supports Screens Up To 24", Swivels 180 degrees - Mount Plate Tilts 85 degrees</li> <li>- Arm: Die Cast Aluminum</li> </ul> <p><b>Notes</b></p> <ul style="list-style-type: none"> <li>- Surface Factory Bored / Ready To Install</li> <li>- Can Accommodate Up To 4 Monitors By Ordering Extra Double Arms.</li> <li>1 Extra Arm and 1 Double Clamp - Add\$305</li> </ul>

Available: - All DARRAN Collections

**COMPUTER SUPPORT**

**CPU RETRACTABLE CRADLE**

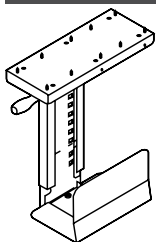

STYLE NUMBER	LIST PRICE	SPECIFICATIONS
K18	195	<ul style="list-style-type: none"> <li>- Black Metal CPU Carriage</li> <li>- Full 360° swivel capability allows easy access to rear of CPU for cables / wires</li> <li>- Track allows 8- 1/2" extension</li> <li>- Width Adjustment 5-1/2" to 9-1/4"</li> <li>- Height adjustment 14- 5/8" to 20- 1/2"</li> <li>- Black epoxy finish</li> </ul> <p><b>Notes</b></p> <ul style="list-style-type: none"> <li>- Factory Installed</li> </ul>

Available: - All DARRAN Collections

COMPUTER SUPPORT

ARTICULATING KEYBOARD TRAY

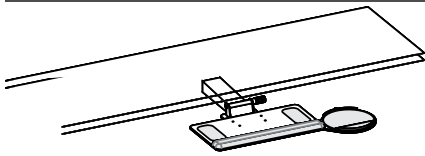

STYLE NUMBER

*Factory Installed*

K28

*Field Installed*

K28F

LIST PRICE

375

395

SPECIFICATIONS

- Adjusts effortlessly - A simple one-handed motion allows the keyboard to be repositioned instantly, without the use of locks or levers
- Encourages low-risk postures - Maximizes adjustability within a safe operating range.
- Will last a lifetime - Exceeds all applicable BIFMA Standards and comes with a lifetime guarantee.

Notes

- Factory Installed (standard)
- FIELD INSTALL - \$395

Available: - All DARRAN Collections

COMPUTER SUPPORT

TRADITIONAL PULL-OUT DRAWER WITH KEYBOARD TRAY

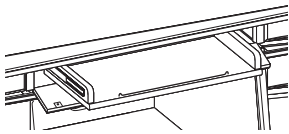

STYLE NUMBER

K21

LIST PRICE

450

SPECIFICATIONS

- Traditional Pull-out Drawer w/Keyboard Tray

Available: - Jamestown

CONFERENCE DESK SUPPORT POST OPTIONS

WOOD DRUM



STYLE NUMBER

*6" Diameter Drum*

B6

LIST PRICE

395

SPECIFICATIONS

- Available in Walnut / Cherry / Maple
- Adjustable levelers
- Replaces standard metal round legs

Notes

- Specify Finish

Available: - Central Park, NOT SO square

CONFERENCE DESK SUPPORT POST OPTIONS

WOOD HALF DRUM

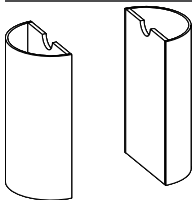

STYLE NUMBER

*8" Half Drum*

HC08

*16" Diameter Drum*

HC16

LIST PRICE

695

895

SPECIFICATIONS

- Available in Walnut / Cherry / Maple
- Adjustable levelers

Notes

- Specify Finish

Available: - Central Park, NOT SO square, Richmond Park

CONFERENCE DESK SUPPORT POST OPTIONS

METAL OVAL "T" BASE



STYLE NUMBER

*Silver*

32MOTS

*Black*

32MOTB

LIST PRICE

595

595

SPECIFICATIONS

- 3" x 1" Aluminum square extrusion
- Leveler adjustment
- Oval Post

Available: - Silver or Black

DOOR MODIFICATIONS

SOFT CLOSE DOOR HINGE



STYLE NUMBER

D9SC

LIST PRICE

15 Per Door

SPECIFICATIONS

- Snap onto standard door hinge
- Requires (1) per door
- Max door height 43"
- Factory installed where specified
- Individually shipped for field installation

Notes

- Specify Each Item To Have Slow Close Feature

Available: - All DARRAN Collections

DOOR MODIFICATIONS

DELETE DOORS

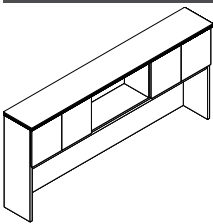

STYLE NUMBER

D6

LIST PRICE

N/C

SPECIFICATIONS

- Standard Door overheads and cabinets can have door deleted for open access. Modification of hinge rails and structural components are made face ready.

Available: - All DARRAN Collections

DOOR MODIFICATIONS

- REPLACE GLASS PANEL INSERT WITH VENEER PANEL INSERT



Glass Door

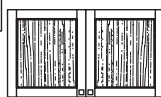

Wood Door

STYLE NUMBER

D35

LIST PRICE

30 per door

SPECIFICATIONS

- Replace glass panel insert with veneer panel insert

Notes

- Not Available on "M" skus
- Glass door has beveled glass
- Wood door w/ veneer insert - only available on "W" style

Available: - Capitol Park, Jamestown, Prado, Richmond Park



**DOOR MODIFICATIONS**

**DELETE DOORS/REPLACE BLACK LAMINATE SHELF W/ FINISHED SHELF**

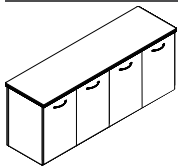

**STYLE NUMBER**  
D6A

**LIST PRICE**  
N/C

**SPECIFICATIONS**  
- Delete doors and replace black laminate shelf with finished shelf

Available: - All Storage Credenzas ("W"/"G" Styles ).  
Excludes Rail.

**DOOR MODIFICATIONS**

**PANEL DOOR LOCK**

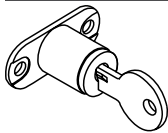

**STYLE NUMBER**  
D2

**LIST PRICE**  
95 Per Door Set

**SPECIFICATIONS**  
- Door Locks - 1 Door w/ Lock, Other Door w/ Catch Latch  
- Contact Customer Service regarding limited lock locations and keying.

Available: - Panel Doors, Wood Frame Doors, and Silverluma doors

**DOOR MODIFICATIONS**

**GLASS DOOR LOCK**

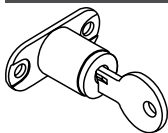

**STYLE NUMBER**  
D2-G

**LIST PRICE**  
195 Per Door Set

**SPECIFICATIONS**  
- Door Locks - 1 Door w/ Lock, Other Door w/ Catch Latch  
- Contact Customer Service regarding limited lock locations and keying.

Available: - Glass Doors

**DOOR MODIFICATIONS**

**BOX DRAWER ACCESSORIES**

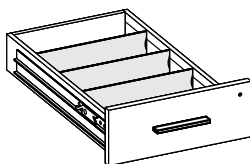

**STYLE NUMBER**  
*Wood Drawer Dividers w/ Clips*  
K-DIV  
*Single Tray - Utility Tray*  
K-Sut

**LIST PRICE**  
SET OF 3 - 30  
30 each

**SPECIFICATIONS**  
- K-DIV Extra Wood Drawer Dividers with Clips, Top Box drawers standard with 1 divider  
- K-SUT Single Tray - Utility Tray, Specify Legal or Letter drawer width

Available: - All DARRAN Collections. Excludes Rail.

**DRAWER OPTIONS**

**TRADITIONAL CENTER DRAWER**

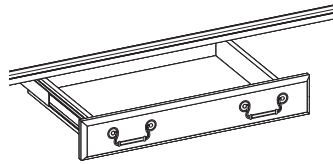

**STYLE NUMBER**  
K17  
*Add Skirt Option*  
K17-SK

**LIST PRICE**  
225  
  
325

**SPECIFICATIONS**  
- Standard on desks in Jamestown Collection. Optional center drawers available for bullet conference desk, kneespace credenzas and corner units. 3 ply hardwood drawer / dowel construction profile shaped drawer front. Specify pull choice.

Available: - Jamestown

**DRAWER OPTIONS**

**FINISHED TRADITIONAL CENTER DRAWER**

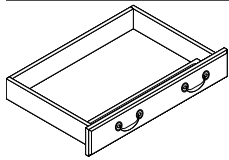

**STYLE NUMBER**  
K30  
*Add Skirt Option*  
K30-SK

**LIST PRICE**  
195  
  
295

**SPECIFICATIONS**  
- Veneer drawer front finished to match unit veneer. Edges are scalloped to match standard drawers.  
- Standard with matching wood grain pencil tray  
- Pulls selected to match unit installed

Available: - Richmond Park

**DRAWER OPTIONS**

**FINISHED CENTER DRAWER**

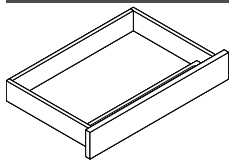

**STYLE NUMBER**  
K31  
*Add Skirt Option*  
K31-SK

**LIST PRICE**  
195  
  
295

**SPECIFICATIONS**  
- Veneer drawer front finished to match unit W or G style veneer.  
- Ball bearing smooth operation  
- Drawer has lifetime guarantee  
- Standard with matching wood grain pencil tray  
- Laminate drawer front to match laminate unit (M style)

Available: - Central Park, NOT SO square, Rail

**DRAWER OPTIONS**

**PRADO/SPACES CENTER DRAWER - VENEER BOTTOM**

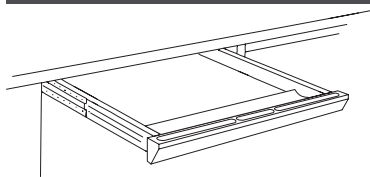

**STYLE NUMBER**  
*Factory Installed*  
K1  
*Field Installed*  
K1BVF

**LIST PRICE**  
275  
  
275

**SPECIFICATIONS**  
- Solid hardwood front beveled and rounded with recessed pencil tray.

Available: - Prado, Spaces

**DRAWER OPTIONS**

**CENTER DRAWER**

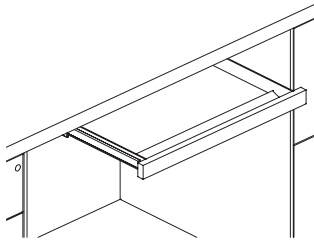

**STYLE NUMBER**

**LIST PRICE**

**SPECIFICATIONS**

*Factory Installed*

- Center Drawer - Factory Installed, Center Drawer - Field Installed

K1R

275

*Field Installed*

K1RF

275

Available: - Rift

**DRAWER OPTIONS**

**CENTER DRAWER WITH SKIRT**

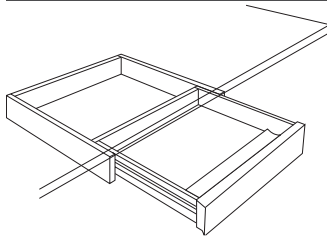

**STYLE NUMBER**

**LIST PRICE**

**SPECIFICATIONS**

*Factory Installed*

- Center Drawer - Factory Installed, Center Drawer - Field Installed

K2R

375

*Field Installed*

K2RF

375

*Add Skirt Option*

K2R-SK

475

Available: - Rift

**DRAWER OPTIONS - BOTTOM COVER**

**BLACK DURA-LEATHER DRAWER BOTTOM COVERS**

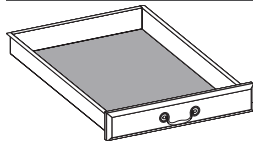

**STYLE NUMBER**

**LIST PRICE**

**SPECIFICATIONS**

P2

75

- Center drawer and Box/Tray drawers are covered in Black Duraleather that adds a prestigious touch.

Available: - Jamestown

**DRAWER OPTIONS - BOTTOM COVER**

**FELT BOTTOM CENTER DRAWER INSERT LINER**

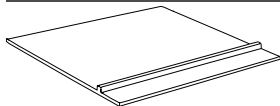

**STYLE NUMBER**

**LIST PRICE**

**SPECIFICATIONS**

K3

95

- Inserts into center drawer and features divider for open pen and pencil storage. Removable for easy cleaning.  
- Adds a luxurious touch to center drawers.  
- Color: Dark Brown Coal

Available: - All DARRAN Collections. Excludes Rail.

**DRAWER OPTIONS - UPGRADE**

**WOOD DRAWER UPGRADE**

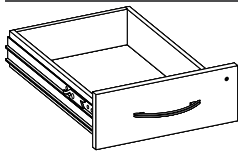

**STYLE NUMBER**  
P33

**LIST PRICE**  
40 Per Drawer

**SPECIFICATIONS**

- Dowel joint construction
- Hardwood veneer multi-ply drawer
- UV finish
- 1/4" Wood veneer bottoms
- File drawer bottoms are fiv block reinforced for heavy weight capacity
- Lifetime guaranteed

Available: - Central Park, Capitol Park, NOT SO square, Rail, Richmond Park

**LIGHTING**

**LT-LED TASK LIGHT**

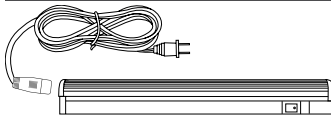

**STYLE NUMBER**  
*24" Tasklight*  
LT-LED24  
*48" Tasklight*  
LT-LED48  
*60" Tasklight*  
LT-LED60  
*Linking Cable*  
LC22

**LIST PRICE**  
90  
165  
180  
20

**SPECIFICATIONS**

- Anodized aluminum finish
- Tilting beam allows adjustability
- Switch with dimming control
- 50,000 hour life
- 12V power drive standard with each task light 30 watt max

**Notes**  
- LC22: 20" LT-LED Task light linking cable

Available: - All DARRAN Collections

**LIGHTING**

**DELETE TASK LIGHT CONCEALMENT APRON RAIL**

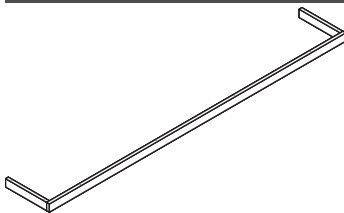

**STYLE NUMBER**  
WAR-D

**LIST PRICE**  
Deduct 125

**SPECIFICATIONS**  
- Delete Tasklight Concealment apron rail when a task light is not used on a wall hung unit

Available: - Wall Hung Units

**LIGHTING**

**SLIM LINE ALUMINUM LED TASK LIGHT**

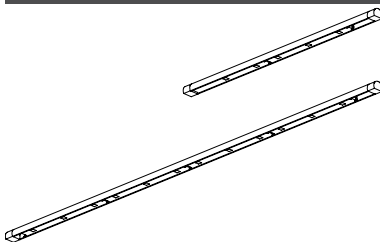

**STYLE NUMBER**  
*24" Tasklight*  
LED24  
*48" Tasklight*  
LED48  
*60" Tasklight*  
LED60  
*Linking Package*  
DPC

**LIST PRICE**  
315  
445  
555  
Deduct 85 per task light

**SPECIFICATIONS**

- Anodized aluminum finish
- Tilting beam allows adjustability
- Switch with dimming control
- 50,000 hour life
- 12V power drive standard with each task light 30 watt max

**Notes**  
- Link multiple tasklights up to 30W of power wattage. Deletes 1 power drive

Available: - Rift and Spaces

LIGHTING

LED INTERIOR CABINET PUCK LIGHT

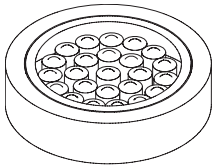

STYLE NUMBER

LIST PRICE

SPECIFICATIONS

**Starter Kit**  
LEDPK  
**1 LED Interior Puck Light**  
PK

295  
  
125

- Starter kit includes Infeed, 1 Puck Interior Light and the ability to daisy chain up to 6 total Puck Lights
- (1) LED Puck Light with 30W power drive and switch
- Recessed fixture
- 12V linking cord 98"L
- Silver finish
- 50,000 hour life
- 2 watt per light

Notes

- Power drive included, Light only

Available: - Overhead/Tower Units with glass doors or no doors

PEDESTAL MODIFICATIONS

BREAKFRONT PEDESTAL WITH WIRE MANAGEMENT CAVITY DOOR

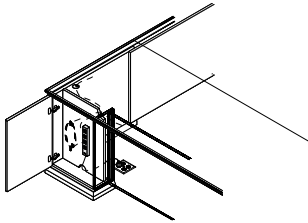

STYLE NUMBER

LIST PRICE

SPECIFICATIONS

PC10  
**Power Supply Cordset**  
PD717

95  
  
95

- Hinged pedestal front door offers easy access for wire management
- Wire hooks provide wire coil storage
- Wire access openings allow access to floor, cabinets interior and kneespace
- Cabinet interior is black finish
- Top grommet is positioned over cavity for access ease
- (Power Strip Optional)

Notes

- Breakfront Chassis Only

Available: - All DARRAN Collections. Excludes Jamestown, Rail, Richmond, and Rift.

PEDESTAL MODIFICATIONS

BLACK LAMINATE PRINTER PULLOUT BOTTOM SHELF

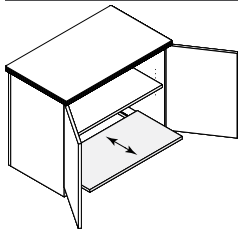

STYLE NUMBER

LIST PRICE

SPECIFICATIONS

PPOS

214

- Black Laminate pullout shelf on suspension
- Black grommet
- Adjustable Shelf

Available: - All DARRAN Collections. Excludes Rail.

PEDESTAL MODIFICATIONS

ADD VENEER KNEESPACE CABINETS - BASE

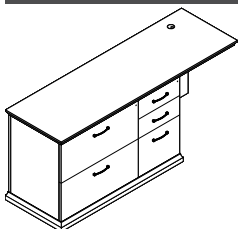

STYLE NUMBER

LIST PRICE

SPECIFICATIONS

**Add Box/Box/File or File/File**

P40B

985

- Multi-file specify Box/Box Left or Right

**Add Lateral File 29" W**

P41B

1205

Notes

- Add additional Standard Cabinets To Kneespace Area.

**Add Multi-File - 31"W**

P42B

1205

**Add Storage With Doors 29"W**

P43B

1095

**Add CPU /Printer Cabinet - Open**

P44B

1095

Available: - Capitol Park, Jamestown, Prado, Richmond Park

PEDESTAL MODIFICATIONS

ADD VENEER KNEESPACE CABINETS - NO BASE

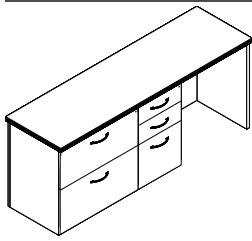

Available: - Central Park, NOT SO square

STYLE NUMBER	LIST PRICE
<i>Add Box/Box/File or File/File</i> P40W	875
<i>Add Lateral File 29" W</i> P41W	985
<i>Add Multi-File - 31"W</i> P42W	1095
<i>Add Storage With Doors 29"W</i> P43W	985
<i>Add CPU /Printer Cabinet - Open</i> P44W	985

**SPECIFICATIONS**  
- Multi-file specify Box/Box Left or Right

**Notes**  
- Add additional Standard Cabinets To Kneespace Area.

PEDESTAL MODIFICATIONS

ADD TECH VENEER KNEESPACE CABINETS - NO BASE

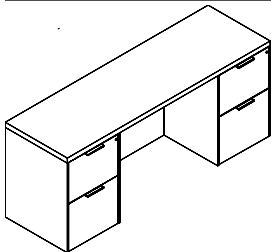

Available: - Rift

STYLE NUMBER	LIST PRICE
<i>Add Box/Box/File or File/File</i> P40T	1100
<i>Add Lateral File 29" W</i> P41T	1210
<i>Add Multi-File - 31"W</i> P42T	1320
<i>Add Storage With Doors 29"W</i> P43T	1210
<i>Add CPU /Printer Cabinet - Open</i> P44T	1210

**SPECIFICATIONS**  
- Multi-file specify Box/Box Left or Right

**Notes**  
- Add additional Standard Cabinets To Kneespace Area.

PEDESTAL MODIFICATIONS

ADD MELAMINE (TFL) KNEESPACE CABINETS - NO BASE

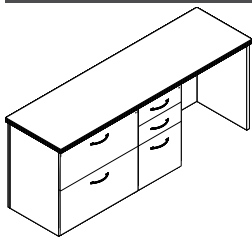

Available: - Central Park (TFL) and NOT SO square (TFL)

STYLE NUMBER	LIST PRICE
<i>Add Box/Box/File or File/File</i> P40M	688
<i>Add Lateral File 29" W</i> P41M	853
<i>Add Multi-File - 31"W</i> P42M	963
<i>Add Storage With Doors 29"W</i> P43M	765
<i>Add CPU /Printer Cabinet - Open</i> P44M	875

**SPECIFICATIONS**  
- Multi-file specify Box/Box Left or Right

**Notes**  
- Add additional Standard Cabinets To Kneespace Area.

PEDESTAL MODIFICATIONS

MODIFY DRAWER CONFIGURATIONS

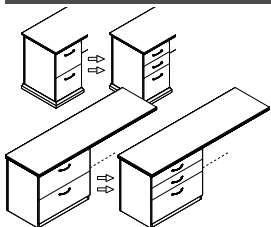

Available: - All DARRAN Collections. Excludes Rail.

STYLE NUMBER	LIST PRICE
<i>File/File to Box/Box/File</i> P6	50 per pedestal
<i>Box/Box/File to File/File</i> P6	50 per pedestal
<i>Lateral File to 2 Box Drawers</i> P8	95 per pedestal

**SPECIFICATIONS**  
- Modify File/File To Box/Box/File - Any Unit

**PEDESTAL MODIFICATIONS**

**MODIFY DRAWER CONFIGURATIONS**

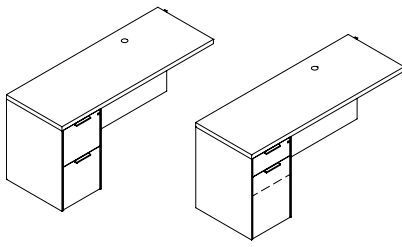

**STYLE NUMBER**

*File/File to Box/Box/File*

P6H

*Lateral File to 2 Box Drawers*

P8

**LIST PRICE**

95 per pedestal

95 per pedestal

**SPECIFICATIONS**

- Modify File/File To Box/Hidden Box/File - Any Unit

Available: - Rift

**POWER / DATA**

**POWER SUPPLY CORDSET**

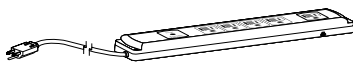

**STYLE NUMBER**

PD717

**LIST PRICE**

95

**SPECIFICATIONS**

- SIZE: 10.75"L x 2.0"W x 1.06"H

- (5) Outlets w/ 10' cord

- Surge suppression (720 Joules)

- 15 Amp breaker

- Available on: Vertical Panels, Cabinet Interiors, and under tops

Available: - All DARRAN Collections

**PRODUCT MODIFICATIONS**

**MODIFY WIDTH - OPEN KNEESPACE**

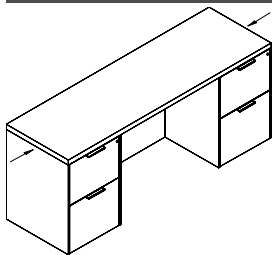

**STYLE NUMBER**

MOD-1

**LIST PRICE**

125

**SPECIFICATIONS**

- Modify width down on any unit with an open kneespace: desk, workstation credenza, bridge, return

Available: - All DARRAN Collections

**PRODUCT MODIFICATIONS**

**MODIFY WIDTH - OPEN/CLOSED STORAGE**

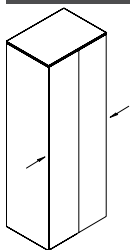

**STYLE NUMBER**

MOD-2

**LIST PRICE**

250

**SPECIFICATIONS**

- Modify width down on any unit with open or closed storage section: overheads, wall hung units, storage credenzas, towers

Available: - All DARRAN Collections

**PRODUCT MODIFICATIONS** **MODIFY WIDTH - OUTSIDE OF MOD-1, MOD-2**

STYLE NUMBER	LIST PRICE	SPECIFICATIONS
MOD-3	Contact Factory for Pricing	- Width modification outside of MOD-1 & MOD-2

Available: - All DARRAN Collections

**PRODUCT MODIFICATIONS** **MODIFY WIDTH - TACKBOARD, SLAT WALL, VENEER PANEL, OR A GLASSBOARD**

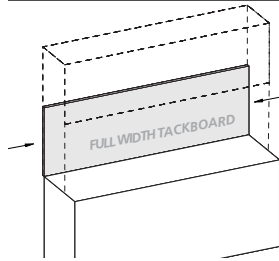

STYLE NUMBER	LIST PRICE	SPECIFICATIONS
MOD-4	50	- Modify width down on tackboard, slat wall, veneer panel, or a overhead glassboard

Available: - All DARRAN Collections

**PRODUCT MODIFICATIONS** **MODIFY DEPTH - DECREASE DEPTH**

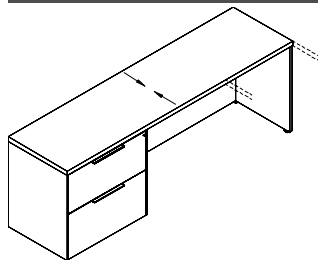

STYLE NUMBER	LIST PRICE	SPECIFICATIONS
MOD-5	125	- Modify depth down (minimum depth for a unit with drawers is 21"D)
<b>Notes</b>		
- Ex. 24" to 21", 30" to 24", and 36" to 30"		

Available: - All DARRAN Collections

**PRODUCT MODIFICATIONS** **MODIFY DEPTH - INCREASE DEPTH**

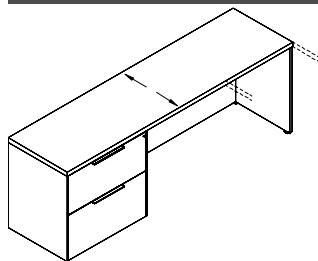

STYLE NUMBER	LIST PRICE	SPECIFICATIONS
MOD-6	Add 10%	- Increase depth
<b>Notes</b>		
- Ex. 24" to 30", 30" to 36", and 36" to 42"		

Available: - All DARRAN Collections. Excludes Rift.



**PRODUCT MODIFICATIONS**

**MODIFY HEIGHT**

**STYLE NUMBER**  
MOD-7

**LIST PRICE**  
Contact Factory  
for Pricing

**SPECIFICATIONS**  
- Modify height of a unit

Available: - All DARRAN Collections

**PRODUCT MODIFICATIONS**

**MODIFY CONFERENCE TABLE LENGTH AND WIDTH - 1 PIECE TOP**

**STYLE NUMBER**  
MOD-8

**LIST PRICE**  
125

**SPECIFICATIONS**  
- Modify length/width down on a 1 piece table top

Available: - Conferencing

**PRODUCT MODIFICATIONS**

**MODIFY CONFERENCE TABLE LENGTH AND WIDTH - 2/3 PIECE TOP**

**STYLE NUMBER**  
MOD-9

**LIST PRICE**  
250

**SPECIFICATIONS**  
- Modify length/width down on a 2 or 3 piece table top

Available: - Conferencing

**REFRIGERATOR MODIFICATION**

**REFRIGERATOR CABINET MODIFICATION**

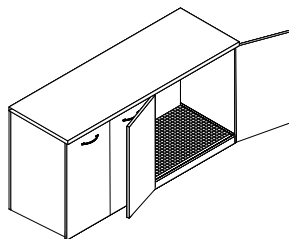

**STYLE NUMBER**  
REF01

**LIST PRICE**  
195

**SPECIFICATIONS**  
- Open back cutout for venting  
- Moisture sponge mat  
- Contaminate ledge  
- Contact customer service for maximum refrigerator size  
(Changes based on unit).

Available: - Storage Credenzas

**SHAPED TOPS** **OVERHEAD/WALL HUNG SHAPED TOP**

STYLE NUMBER	LIST PRICE	SPECIFICATIONS
<b>99"W - 105"W</b>		- Shaped tops for overheads and wall hungs
TOH-1	405	
<b>58"W - 93"W</b>		
TOH-2	315	
<b>29"W - 47"W</b>		
TOH-3	203	

Available: - Central Park, Rail

**SHAPED TOPS** **BOOKCASE SHAPED TOP**

STYLE NUMBER	LIST PRICE	SPECIFICATIONS
<b>29"W - 35"W x 15"D</b>		- 15" D Shaped tops for bookcases
TOH-4	203	- Shaped on front

Available: - Central Park, Rail

**SHAPED TOPS** **TOWER SHAPED TOP**

STYLE NUMBER	LIST PRICE	SPECIFICATIONS
<b>16" Single Width Tower</b>		- 24" deep shaped tops for towers
TOH-5	158	- Shaped on front
<b>29"W - 46"W Tower</b>		
TOH-6	203	

Available: - Central Park, Rail

**SHAPED TOPS** **WORKSURFACE SHAPED TOP**

STYLE NUMBER	LIST PRICE	SPECIFICATIONS
<b>Shape Four Sides</b>		- S4S Applies to desk, bridge or any freestanding unit. This adds shapes or copes to two sides (desk, bridges) or one side and back of units (returns).
S4S	50	
<b>Shape Three Sides</b>		- S3S Applies to credenza units. This adds shapes to the two sides.
S3S	50	- Credenzas are shaped front standard with flat back
		<b>Notes</b>
		- Desk, Freestanding and Credenza units will grow 1" in width due to adding shapes on ends of units.

Available: - Central Park

SHAPED TOPS

PREMIUM EDGE - SHAPED WORKSURFACE TOP

STYLE NUMBER	LIST PRICE	SPECIFICATIONS
<i>Shape Four Sides Premium Edge</i>		
S4S-PE	Add 10%	- S4S-PE Applies to desk, bridge or any freestanding unit. This adds shapes or copes to two sides (desk, bridges) or one side and back with hardwood rims (returns).
<i>Shape Three Sides Premium Edge</i>		
S3S-PE	Add 10%	- S3S-PE Shape Three Sides Premium Edge. Applies to credenza units. This adds shape to the two sides with hardwood rims.
<b>* 10% Upcharge includes 5% for premium edge</b>		<p><b>Notes</b></p> <ul style="list-style-type: none"> <li>- Desk, Freestanding and Credenza units will grow 1" in width due to adding shapes on ends of units.</li> </ul>

Available: - Central Park

SHELF MODIFICATIONS

GLASS SHELVES - TEMPERED FULL WIDTH 26" - 35"

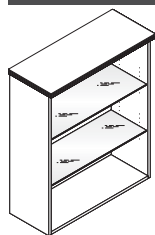

STYLE NUMBER	LIST PRICE	SPECIFICATIONS
<i>26"W - 35"W x 14"D Shelf</i>		
GS14F	85	- Glass Shelves Replace Wood Shelf In Open Or Glass Door Cabinet. Also Order Interior Cabinet Lighting.

Available: - All DARRAN Collections

SHELF MODIFICATIONS

TEMPERED GLASS SHELVES FOR HALF CABINET 17- 1/2" WIDTHS

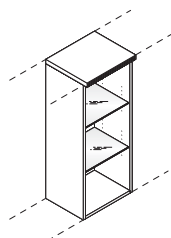

STYLE NUMBER	LIST PRICE	SPECIFICATIONS
<i>14-1/2"W - 17- 1/2"W x 14"D Shelf</i>		
GS14H	65 ea	- Glass Shelves Replace Wood Shelf In Open Or Glass Door Cabinet. Also Order Interior Cabinet Lighting.

**Notes**

- Replace only adjustable shelves between cabinet light and fixed lower wood shelf.

Available: - All DARRAN Collections

SHELF MODIFICATIONS

CURVED CORNER GLASS SHELF

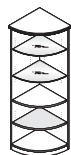

STYLE NUMBER	LIST PRICE	SPECIFICATIONS
GS14CC	85 ea	- Curved shelves feature glass retainer clips to prevent tipping

**Notes**

- Replace only adjustable shelves between cabinet light and fixed lower wood shelf.

Available: - All DARRAN Collections. Excludes Rail.

**SHELF MODIFICATIONS**

**HEAVY DUTY SOLID WOOD BOOKCASE REPLACEMENT SHELVES**

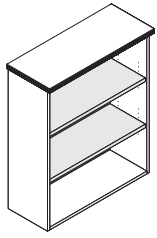

**STYLE NUMBER**  
**1" Wood Shelf 14" Deep**  
 S714F  
**1" Wood Shelf 24" Deep**  
 S714FX

**LIST PRICE**  
 75 ea  
 150 each

**SPECIFICATIONS**  
 - 1" Solid Lumber Core Shelves Replace Standard 3/4" Plywood  
 Adjustable And Fixed Shelves

Available: - All DARRAN Collections. Excludes Rail.

**SLAT WALL ACCESSORIES**

**SLAT WALL ACCESSORY TRAY**

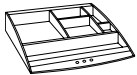

**STYLE NUMBER**  
 SWA9

**LIST PRICE**  
 45

**SPECIFICATIONS**  
 - Specify Black Or Matte Silver

Available: - All DARRAN Collections. Excludes Rail.

**SLAT WALL ACCESSORIES**

**SLAT WALL FOLDER TRAY**



**STYLE NUMBER**  
 SWA7

**LIST PRICE**  
 45

**SPECIFICATIONS**  
 - Specify Black Or Matte Silver

Available: - All DARRAN Collections. Excludes Rail.

**SLAT WALL ACCESSORIES**

**SLAT WALL PAPER TRAY**

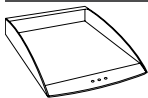

**STYLE NUMBER**  
 SWA2

**LIST PRICE**  
 35

**SPECIFICATIONS**  
 - Specify Black Or Matte Silver

Available: - All DARRAN Collections. Excludes Rail.

SLAT WALL ACCESSORIES

SLAT WALL PENCIL HOLDER



STYLE NUMBER  
SWA4

LIST PRICE  
25

SPECIFICATIONS  
- Specify Black Or Matte Silver

Available: - All DARRAN Collections. Excludes Rail.

SPECIALTY VENEER ACCENTS

BLACK EBONY WOOD INLAY IN ONE PIECE CONFERENCE TOP

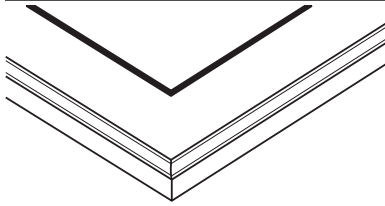

STYLE NUMBER  
*One Piece Conference Top*  
T30  
*Two Piece Conference Top*  
T31

LIST PRICE  
735  
1480

SPECIFICATIONS  
- Standard veneer top is routed for Ebony wood inlay 1/8" x 3/16" width line. Inlay wood is miter jointed in the corners, hand fitted, glued and sanded flush with top veneer. Inlay forms a 3" border to top edge

**Notes**  
- Hand fitted miter corner Black Ebony wood inlay installed in standard wood veneer tops

Available: - Conferencing Tops.

SPECIALTY VENEER ACCENTS

BLACK/WHITE/BLACK WOOD INLAY

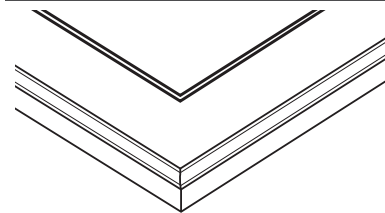

STYLE NUMBER  
*One Piece Top*  
T30BWB  
*Two Piece Top*  
T31BWB

LIST PRICE  
950  
1795

SPECIFICATIONS  
- Standard veneer top is routed for wood inlay 1/8" x 3/16" width line. Each color is 1/16" wide. White inlay line is finished over providing a subtle contrast to line detail

**Notes**  
- Hand fitted miter corner ebony-maple-ebony wood inlay installed in standard veneer top  
- The center white line can be masked off preventing color stains from penetrating. Final top coats are applied over the white line.

Available: - Conferencing Tops

SPECIALTY VENEER ACCENTS

BLACK EBONY WOOD INLAY W/ WOOD FAN DETAIL - 1 PIECE CONFERENCE TABLE TOP

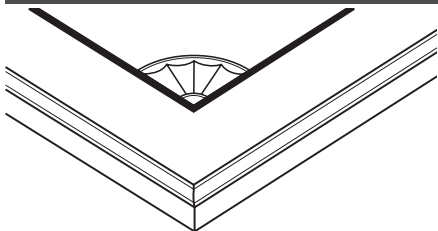

STYLE NUMBER  
*One Piece Top*  
T51  
*Two Piece Top*  
T52

LIST PRICE  
1160  
2110

SPECIFICATIONS  
- Standard veneer top is routed for wood inlay 1/8" x 3/16" width line. With each 90 degree corner routed for Quarter circle fan inlays. Inlay fans combined with solid black inlay preserves an old traditional appearance. Fans are handcrafted from teakwood, rosewood, mahogany, and other exotic woods. Each piece of veneer is shaded by burning and is hand fitted to a perfect fan shape - truly and old world craft  
- Conference tables: 4 fans, one in each corner per top section

**Notes**  
- Hand fitted miter corner wood inlay and fan installed in standard veneer top  
- Only available on square/ rectangle tops

Available: - Conferencing Tops

**SPECIALTY VENEER ACCENTS**

**CROTCH MAHOGANY INFIELD WITH MITERED BORDER**



**STYLE NUMBER**

- TCB-1 - 84 x 36/42
- TCB-2 - 72 x 36/42
- TCB-3 - 72 x 30/36

**LIST PRICE**

- 1895
- 1795
- 1695

**SPECIFICATIONS**

- Center balanced butt and book matched crotch mahogany
- 35 sheen non-rubbed finish ensures maximum durability

Available: - Jamestown, Prado

**SPECIALTY VENEER ACCENTS**

**CROTCH MAHOGANY DESK PEDESTAL FRONTS**

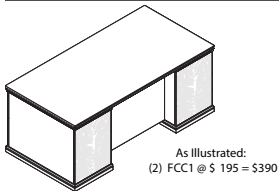

Desk Approach  
Pedestal Fronts

**STYLE NUMBER**

FCC1

**LIST PRICE**

195 per pedestal

**SPECIFICATIONS**

- Center balanced butt and book matched crotch mahogany
- 35 sheen non-rubbed finish ensures maximum durability

Available: - Jamestown, Prado

**SPECIALTY VENEER ACCENTS**

**CROTCH MAHOGANY DRAWER FRONTS**

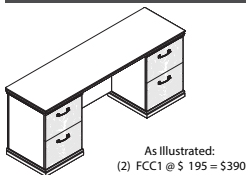

Box/Box/File or File/File  
Drawer Fronts

**STYLE NUMBER**

FCC1

**LIST PRICE**

195 per pedestal

**SPECIFICATIONS**

- Center balanced butt and book matched crotch mahogany
- 35 sheen non-rubbed finish ensures maximum durability

Available: - Jamestown, Prado

**SPECIALTY VENEER ACCENTS**

**CROTCH MAHOGANY DOUBLE WIDTH PANEL FRONTS**



All Three Illustrations Represent: (1) FCC2 @ \$395

30-32-36 Width  
FCC-2 \$395 per Panel Set

**STYLE NUMBER**

FCC2

**LIST PRICE**

395 per Panel Set

**SPECIFICATIONS**

- Center balanced butt and book matched crotch mahogany
- 35 sheen non-rubbed finish ensures maximum durability

Available: - Jamestown, Prado

**SPECIALTY VENEER ACCENTS**

**CROTCH MAHOGANY DOUBLE WIDTH/ DOUBLE HEIGHT FRONTS**



**STYLE NUMBER**  
FCC3

**LIST PRICE** 895 per Panel Set  
**SPECIFICATIONS**  
 - Center balanced butt and book matched crotch mahogany  
 - 35 sheen non-rubbed finish ensures maximum durability

Both Illustrations Represent:  
 (1) FCC3 @ \$895 - Panel Set  
 30-36 Width  
 FCC-3 \$895 per Panel Set

Available: - Jamestown, Prado

**SPECIALTY VENEER ACCENTS**

**RECTANGLE INLAY - RECESSES DURA-LEATHER WRITING SURFACE**

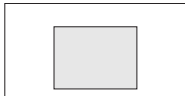

RECTANGLE INLAY

**STYLE NUMBER**  
RL-29A

**LIST PRICE** 895  
**SPECIFICATIONS**  
 - Recessed inlay desk pads are covered with Alomost Leather from Paul Brayton Designs.  
 - DARRAN will gladly custom quote other inlay materials ie: solid surfaces, biocomposites, metallic laminates, or genuine leather to match seating

Available: - All DARRAN Collections

**SPECIALTY VENEER ACCENTS**

**BOWFRONT INLAY - RECESSES DURA-LEATHER WRITING SURFACE**

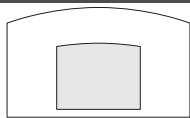

BOWFRONT INLAY

**STYLE NUMBER**  
RL-31A

**LIST PRICE** 995  
**SPECIFICATIONS**  
 - Recessed inlay desk pads are covered with Alomost Leather from Paul Brayton Designs.  
 - DARRAN will gladly custom quote other inlay materials ie: solid surfaces, biocomposites, metallic laminates, or genuine leather to match seating

Available: - All DARRAN Collections

**SPECIALTY VENEER ACCENTS**

**RECTANGLE INLAY - EBONY HARDWOOD INLAY DETAIL**

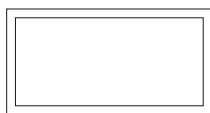

RECTANGLE INLAY

**STYLE NUMBER**  
T10SA

**LIST PRICE** 895  
**SPECIFICATIONS**  
 - 3/16" x 3/16" thick hardwood ebony inlay is handfitted and glued into routed top and sanded flush with surface  
 - Inlay is finished over with all finish steps

**Notes**  
 - Ebony inlay not recommended in: Koko Cherry

Available: - All DARRAN Collections

**SPECIALTY VENEER ACCENTS**

**BOWFRONT INLAY - EBONY HARDWOOD INLAY DETAIL**

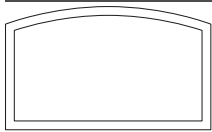

CURVED INLAY

**STYLE NUMBER**  
T11SA

**LIST PRICE**  
995

**SPECIFICATIONS**  
- 3/16" x 3/16" thick hardwood ebony inlay is handfitted and glued into routed top and sanded flush with surface  
- Inlay is finished over with all finish steps

**Notes**  
- Ebony inlay not recommended in: Koko Cherry

Available: - All DARRAN Collections

**TOOL CHANNEL ACCESSORIES**

**RECESSED ALUMINUM TOOL CHANNEL**

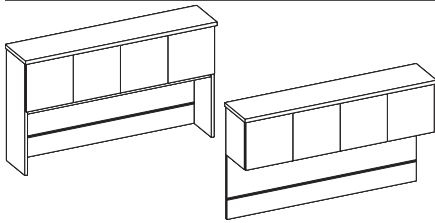

**STYLE NUMBER**  
ATB02

**LIST PRICE**  
5 per 1"W

**SPECIFICATIONS**  
- Anodized aluminum finish  
- Fully recessed  
- Finish matches anodized aluminum accessories  
- Can be specified with fabric tack surface mounted above channel

**Notes**  
- If using tool channel with wallhung overhead, a veneer panel must be specified.

Available: - All DARRAN Collections. Excludes Rail.

**TOOL CHANNEL ACCESSORIES**

**FILE HOLDER**

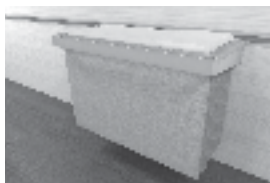

**STYLE NUMBER**  
ATB37

**LIST PRICE**  
105

**SPECIFICATIONS**  
- For Console/Wall Hung Back Panels With Optional Tool Bar  
- 18 Gauge Steel - Stamp Formed  
- Silver Powderdercoat Finish

Available: - All DARRAN Collections. Excludes Rail.

**TOOL CHANNEL ACCESSORIES**

**IPHONE HOLDER**



**STYLE NUMBER**  
ATB31

**LIST PRICE**  
120

**SPECIFICATIONS**  
- For Console/Wall Hung Back Panels With Optional Tool Bar  
- 18 Gauge Steel - Stamp Formed  
- Silver Powderdercoat Finish  
- 5" x 3 -3/4"W  
- Non-slip Neoprene pad

Available: - All DARRAN Collections. Excludes Rail.



**TOOL CHANNEL ACCESSORIES**

**LARGE SHELF**

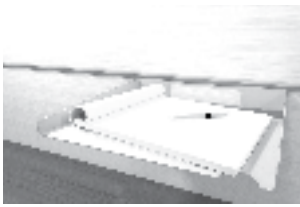

**STYLE NUMBER**  
ATB35

**LIST PRICE**  
125

**SPECIFICATIONS**  
- 12"W x 10"D

Available: - All DARRAN Collections. Excludes Rail.

**TOOL CHANNEL ACCESSORIES**

**PENCIL PEN HOLDER**



**STYLE NUMBER**  
ATB38

**LIST PRICE**  
115

**SPECIFICATIONS**  
- For Console/Wall Hung Back Panels With Optional Tool Bar  
- 18 Gauge Steel - Stamp Formed  
- Silver Powdercoat Finish  
- 5"H x 4"W x 4"D

Available: - All DARRAN Collections. Excludes Rail.

**TOOL CHANNEL ACCESSORIES**

**SMALL SHELF**



**STYLE NUMBER**  
ATB36

**LIST PRICE**  
110

**SPECIFICATIONS**  
- 12"W x 6 -3/4"D

Available: - All DARRAN Collections. Excludes Rail.

**TOOL CHANNEL ACCESSORIES**

**TABLET HOLDER**

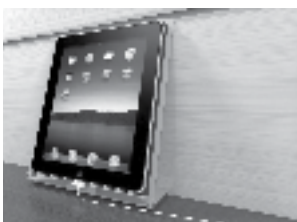

**STYLE NUMBER**  
ATB30

**LIST PRICE**  
135

**SPECIFICATIONS**  
- For Console/Wall Hung Back Panels With Optional Tool Bar  
- 18 Gauge Steel - Stamp Formed  
- Silver Powdercoat Finish  
- 10" x 8"W  
- Non-slip Neoprene pad

Available: - All DARRAN Collections. Excludes Rail.

TOP MODIFICATION

1/4" RECTANGLE SOFT ETCH GLASS RUNOFF WORKSURFACE

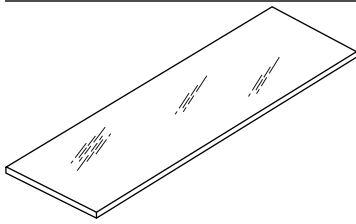

STYLE NUMBER

SEGW8436  
 SEGW8430  
 SEGW7836  
 SEGW7830  
 SEGW7230  
 SEGW6630  
 SEGW6030

LIST PRICE

2210  
 1870  
 2070  
 1750  
 1630  
 1515  
 1395

SPECIFICATIONS

- 1/4" Soft etch glass  
 - Back painted white glass

Notes

- Additional colors can be custom quoted. Contact factory for pricing.

Available: - Rift Runoff Worksurface

TOP MODIFICATION

TOP APRON RAIL

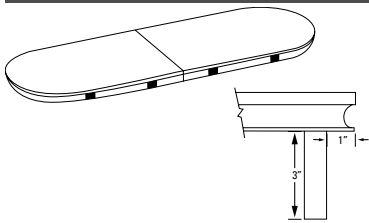

STYLE NUMBER

TAR

LIST PRICE

Add 10% to top price for apron only

SPECIFICATIONS

- 3 x 3/4 thick apron rail is set back under top 1".  
 - Apron rail is recommended for fixed port installation for power/data support.

Notes

- Select power/data support separately.  
 - See power options for available apron power: UDT2/VD-SM

Available: - Conferencing Tops Only

TOP MODIFICATION

TOP APRON RAIL

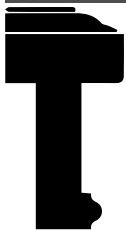

STYLE NUMBER

TAR-M

LIST PRICE

Add 15% (Apron rail with beltline detail)

SPECIFICATIONS

- Traditional with apron rail and molding - available in Cherry and Walnut.

Notes

- Select power/data support separately.  
 - See power options for available apron power: UDT2/VD-SM

Available: - Conference tops only

WIRE MANAGEMENT

HORIZONTAL J-CHANNEL WIRE MANAGEMENT RACEWAY

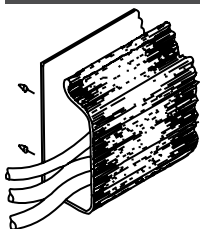

STYLE NUMBER

W1

LIST PRICE

75 Per 4 Foot Section

SPECIFICATIONS

- 4' section for field installation.  
 - The "J" shape black thermoplastic wire raceway may be added to specified worksurface tops to provide concealed channeling of wires to and from worksurface grommets. For use in open kneespace areas, raceway is attachable to top of back panel with pan head screws. Interior dimensions are 1" x 1- 1/2" providing ample storage for multiple wires and excess cable. Front of raceway flexes out for easy cord insertion.

Notes

- Units w/ Wire Channel Standard.  
 - Field Installation

Available: - All DARRAN Collections.

WIRE MANAGEMENT

HORIZONTAL U-CHANNEL WIRE MANAGEMENT RACEWAY



**STYLE NUMBER**  
W2A

**LIST PRICE**  
75 Per 4 Foot Section

**SPECIFICATIONS**  
- 4' section for field installation.

**Notes**  
- Units w/ Wire Channel Standard.  
- Field Installation

Available: - All DARRAN Collections.

WIRE MANAGEMENT

COIL WIRE MANAGER



**STYLE NUMBER**  
W18

**LIST PRICE**  
150

**SPECIFICATIONS**  
- Weighted Base, Table attachment plate  
- 39- 1/2" Length  
- Black

**Notes**  
- Location

Available: - All DARRAN Collections.

WIRE MANAGEMENT

STANDARD LOCATION GROMMETS - FACTORY INSTALLED

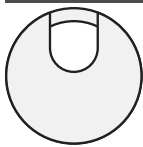

**STYLE NUMBER**  
*Standard Location Grommet*

**Black**  
TM30

**Silver**  
TM31

**Antique Brass**  
TM33

**White**  
TM34

**LIST PRICE**

45

45

45

45

45

**SPECIFICATIONS**  
- 1 -5/8" Metal Grommet

**Notes**  
- \*Units w/ Grommets Standard Are Noted Under Standard Features. Grommets Match Pull Finish - Standard (Unless Specified Otherwise)

Available: - All DARRAN Collections.

WIRE MANAGEMENT

NON-STANDARD LOCATION GROMMETS - FACTORY INSTALLED

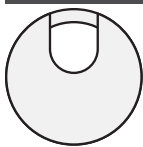

**STYLE NUMBER**  
*Non-Standard Location Grommet*

**Black**  
TM30 -NS

**Silver**  
TM31 -NS

**Antique Brass**  
TM33 -NS

**White**  
TM34 -NS

**LIST PRICE**

90

90

90

90

90

**SPECIFICATIONS**  
- 1 -5/8" Metal Grommet

**Notes**  
- \*Units w/ Grommets Standard Are Noted Under Standard Features. Grommets Match Pull Finish - Standard (Unless Specified Otherwise)

Available: - All DARRAN Collections

**WIRE MANAGEMENT**

**BLACK PLASTIC VERTICAL SURFACE GROMMETS - FACTORY INSTALLED**



STYLE NUMBER	LIST PRICE	SPECIFICATIONS
<i>Standard Location Grommet</i>		- 2 " Black Plastic Grommet
TM50-C	45	<b>Notes</b> - Standard Location is Bottom Center
<i>Non-Standard Location Grommet</i>		
TM50-NS	90	

Available: - All DARRAN Collections

**WORKSTATION**

**CLIENT PULLOUT WRITING SHELF**

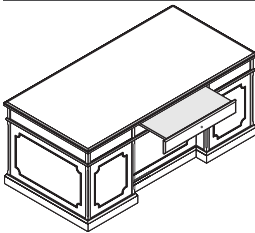

STYLE NUMBER	LIST PRICE	SPECIFICATIONS
CP-1	425	- CP-1: Client pull-out writing shelf for executive chassis desk
CP-2	625	- CP-2: Client pull-out writing shelf for conference desk

Available: - Jamestown

**AIRCHARGE WIRELESS CHARGING GROMMET**

STYLE NUMBER	LIST PRICE
ACWG WIRELESS GROMMET	\$575
ACWR WIRELESS RECEIVER W/ LIGHTNING CABLE	\$170



AirCharge Wireless Grommet

**SPECIFICATIONS**

- AirCharge offers a convenient way to charge any Qi compatible smartphone or device without the need to carry charging cables or find an available power outlet. Devices not equipped with the Qi technology, can be adapted to accept a charge from the grommet with the AirCharge Wireless Receiver.
- Size: 3.33" DIA x .75"D
- Compatible with an Qi rated device, Contact Customer Service for compatibility list
- Non-Qi device can be adapted to accept AirCharge unit with an ACWR AirCharge Wireless Receiver (compatible with iPhone)
- Surface Mount
- 78" Cord
- Standard Black Aluminum Finish; Available in White Aluminum or Black Finish upon request

**AVAILABLE**

- All Darran Collections



iphone w/ ACWR



Black Aluminum



Black Finish



White Aluminum

## COVE POWER UNIT - NON-LINKING

STYLE NUMBER	LIST PRICE
 PD COVE PLUG Non-Linking Version	\$550

**SPECIFICATIONS**

- Size 5.75" L x 2.5" W
- (2) 15 Amp Receptacles and (2) USB charging ports
- Surface Mount
- 108" Cord
- Standard Silver Finish, Available in White or Black Finish upon request
- ETL Listed

**AVAILABLE**

- All Darran Collections



## COVE POWER UNIT WITH DAISYLINK

### STYLE NUMBER

### LIST PRICE

#### STARTER UNITS



#### COV-DCH HARDWIRED

\$710

Includes (1) Cove unit with Hardwire Infeed - 120"



#### COV-DCP PLUG

\$800

Includes (1) Cove unit with Plug infeed - Includes 72" Cord and 32" Infeed Jumper for 104" total cord infeed

#### ADDITIONAL LINKING UNITS

#### COV-DCL

\$575 EACH

Includes Linking Cove unit and Jumper up to 96", cable length determined by the top size

### SPECIFICATIONS

- Size: 5.75" L x 2.5" W
- (2) 15 Amp Receptacles and (2) 2.1 Amp USB charging ports
- Surface Mount
- Max Daisy Chain - Hardwire - (9) units; Plug/Corded - (4) units
- Standard Silver Finish, Available in White or Black Finish upon request
- ETL Listed



### AVAILABLE

- All Darran Collections

## COVE CORDED SERIES

STYLE NUMBER	LIST PRICE
 PD-COVE-PKO	\$800

**SPECIFICATIONS**

- Size 9.5" L x 2.5" W x 3.18" D
- (2) Power Receptacles, (2) 2.1 Amp USB charging ports and (1) Telecom Plate Knockout
- Surface Mount
- 108" Cord
- Standard Silver Finish, Available in White or Black Finish upon request
- ETL Listed

**AVAILABLE**

- All Darran Collections



**TELECOM PLATES**

*THIS POD CAN HAVE UP TO 1 TOTAL PLATES*

STYLE NUMBER	LIST PRICE
RJ45 (1)	\$35
RJ45 (2)	\$70
RJ45 (3)	\$105
USB (1)	\$70
USB (2)	\$140
RJ11/RJ45	\$70
RJ45/USB	\$105
RJ45/HDMI	\$190
HDMI/DVI	\$325
HDMI/USB	\$205
HDMI/VGA	\$240
VGA/MINI-STEREO	\$155
VGA/USB	\$175



## PDFAA FLUSH DATA BAY ANODIZED ALUMINUM DOOR

	STYLE NUMBER	LIST PRICE
	PDFAA-H Hardwired	\$1195
	PDFAA-C Plug	\$1195
	PDFAA-DC Daisy Chain	\$1395

Features convenience plug on bottom - Max Daisy chain (4) units  
 - Specify hardwired or plug for the first unit in series, daisy chained units will have a plug for connection through convenience plug.

### SPECIFICATIONS

- Size 13.75"L x 6.375"W x 2.85"D
- (4) 15 Amp receptacles
- Surface Mount
- Standard Interior Black Finish
- Specify up to (4) Telecom Plates; (2) on side and (2) on bottom
- Cabled units are UL Listed and CSA Certified. Hardwired Units are CSA Certified



### AVAILABLE



- All Darran Collections
- Excludes Rail, Grove

### TELECOM PLATES

*THIS POD CAN HAVE UP TO 4 TOTAL PLATES*

STYLE NUMBER	LIST PRICE
RJ45 (1)	\$35
RJ45 (2)	\$70
RJ45 (3)	\$105
USB (1)	\$70
USB (2)	\$140
RJ11/RJ45	\$70
RJ45/USB	\$105
RJ45/HDMI	\$190
HDMI/DVI	\$325
HDMI/USB	\$205
HDMI/VGA	\$240
VGA/MINI-STEREO	\$155
VGA/USB	\$175

**PDFAF FLUSH DATA BAY FROSTED GLASS DOOR WITH DAISYLINK**

STYLE NUMBER	LIST PRICE
 PDFAF-H HARDWIRED	\$1095
 PDFAF-C PLUG	\$1095
 PDFAF-DC DAISY CHAIN	\$1295

Features convenience plug on bottom - Max Daisy chain (4) units  
 - Specify hardwired or plug for the first unit in series, daisy chained units will have a plug for connection through convenience plug.



**SPECIFICATIONS**

- Size 13.75”L x 6.375”W x 2.85”D
- (4) 15 Amp receptacles
- Surface Mount
- Standard Interior Black Finish
- Specify up to (4) Telecom Plates; (2) on side and (2) on bottom
- Corded units are UL Listed and CSA Certified. Hardwired Units are CSA Certified

**AVAILABLE**

- All Darran Collections
- Excludes Rail, Grove



**TELECOM PLATES**

*THIS POD CAN HAVE UP TO 4 TOTAL PLATES*

STYLE NUMBER	LIST PRICE
RJ45 (1)	\$35
RJ45 (2)	\$70
RJ45 (3)	\$105
USB (1)	\$70
USB (2)	\$140
RJ11/RJ45	\$70
RJ45/USB	\$105
RJ45/HDMI	\$190
HDMI/DVI	\$325
HDMI/USB	\$205
HDMI/VGA	\$240
VGA/MINI-STEREO	\$155
VGA/USB	\$175

**REEF POWER UNIT WITH DAISYLINK**

**STYLE NUMBER**

**LIST PRICE**



REF310 PLUG

\$1100

**SPECIFICATIONS**

- Size 16.1”L x 6.25”W x 4.89”D
- (3) 120V Receptacles, (2) USB charging ports and (2) Knockouts for RJ45 Data Ports
- Surface Mount
- 108” Cord
- Features Convenience Plug on bottom of unit that allows for max (3) Daisy Chain
- Standard Black Finish, Available in White or Silver Finish upon request
- Additional Telecom Plate Knockout
- When used with Grove Tables an additional \$350 LIST will apply for the special cutout required.
- RJ45 for Knockouts not required. If not ordered a small hole will be present in this this location
- ETL Listed

**AVAILABLE**

- Grove
- Conferencing



**TELECOM PLATES**

*THIS POD CAN HAVE UP TO 1 TOTAL PLATES*

STYLE NUMBER	LIST PRICE
RJ45 (1)	\$35
RJ45 (2)	\$70
RJ45 (3)	\$105
USB (1)	\$70
USB (2)	\$140
RJ11/RJ45	\$70
RJ45/USB	\$105
RJ45/HDMI	\$190
HDMI/DVI	\$325
HDMI/USB	\$205
HDMI/VGA	\$240
VGA/MINI-STEREO	\$155
VGA/USB	\$175



## SECLUSION CORDED POWER UNIT NON-LINKING

## STYLE NUMBER

## LIST PRICE



P2SECL

\$245

Choose from plate mount or clamp mount (seen in photo)

## SPECIFICATIONS

- Size: 3.5"L x 2.2"D x 2.5"H
- (2) Power Receptacles
- Worksurface Clamp Mount or Plate Under Surface Mount
- Clamp Accessory accommodates table thickness up to 2"
- 72" Cord
- Standard Silver Finish, Black Finish available upon request
- UL/UCL Listed

## AVAILABLE

- All Darran Collections



Clamp Mount

**UDT POWER UNIT - NON-LINKING**

STYLE NUMBER	LIST PRICE
 <b>UDT2/VD-SM PLUG</b> Non-Linking	\$350



**SPECIFICATIONS**

- Size 6.5" L x 2.81" D x 1.26" H
- (2) Power receptacles and (1) Telecom Plate Cutout
- Side Mount, if Top Mount is required contact customer service
- 72" Cord
- Standard Black Powdercoat Finish
- Used in Apron Rails
- UL Listed

**AVAILABLE**

- Conferencing Apron Rails

**TELECOM PLATES**

*THIS POD CAN HAVE UP TO 1 TOTAL PLATES*

STYLE NUMBER	LIST PRICE
RJ45 (1)	\$35
RJ45 (2)	\$70
RJ45 (3)	\$105
USB (1)	\$70
USB (2)	\$140
RJ11/RJ45	\$70
RJ45/USB	\$105
RJ45/HDMI	\$190
HDMI/DVI	\$325
HDMI/USB	\$205
HDMI/VGA	\$240
VGA/MINI-STEREO	\$155
VGA/USB	\$175

## VILLA POWER UNIT - NON-LINKING

STYLE NUMBER	LIST PRICE
 VIL-C PLUG Non-Linking	\$515

**SPECIFICATIONS**

- Size: Top Grommet 5.68"L X 3.39"W; Under Top 12"L x 3.13"W x 3.08"D
- (2) Power receptacles; (2) USB charging ports and (1) Knockouts for RJ45 Data Ports
- Surface Mount
- 72" Cord (Longer cord available, contact Customer Service)
- Standard Silver Finish, Black Finish available upon request
- UL or ETL Certified

**AVAILABLE**

- All Darran Collections
- Excludes Grove

**RJ45 KNOCKOUT**

STYLE NUMBER	LIST PRICE
RJ45 (1)	\$35



**VILLA POWER UNIT WITH DAISYLINK**

**STYLE NUMBER LIST PRICE**

**STARTER UNITS**



**VIL-DCH HARDWIRED** \$600  
Includes (1) Villa unit with 120" Hardwire Infeed



**VIL-DCP PLUG** \$695  
Includes (1) Villa with Plug Infeed - Includes 72" Cord and 32" Infeed Jumper for 104" total cord infeed

**ADDITIONAL LINKING UNITS**

**VIL-DCL ADDITIONAL** \$590  
(Includes linking Villa and Jumper cable up to 96")

**SPECIFICATIONS**

- Size: Top Grommet 5.68" L X 3.39"W; Under Top 12"L x 3.13"W x 3.08"D
- (4) Power receptacles; (2) surface and (2) undersurface, (2) 2.1A USB charging ports and (1) Knockout for RJ45 Data Port
- Surface Mount
- Daisy Chain - Hardwire Max (10) Units, Plug/Corded Max (5) Units
- Standard Silver Finish, Black Finish available upon request
- UL or ETL Certified

**AVAILABLE**

- All Darran Collections
- Excludes Grove



**RJ45 KNOCKOUT**

STYLE NUMBER	LIST PRICE
RJ45 (1)	\$35