

CRYSTALPLEAT® CELLULAR SHADES

TABLE OF CONTENTS

Features And Size Considerations	Page
Summary	2
Fabric Styles And Information: Cellular Shades	2
Light Control And Privacy	2
Size Considerations: Standard Cord Control	3
Size Considerations: Cordless Lift	4
Size Considerations: Continuous-loop Lift	5
Size Considerations: Perfect-Vue™ Standard Cord Control	6
Size Considerations: Perfect-Vue Cordless Lift	7
Size Considerations: Slide-Vue™ Shades	8

Options	Page
Summary	9
Standard Cord Control And Cordless Lift	10
Continuous-loop Lift	11
Motorized Lift	12
Top Down Only, Bottom Up/Top Down: Standard Cord Control	13
Bottom Up/Top Down: Cordless Lift	14
Sun Up/Sun Down: Standard Cord Control	15
Sun Up/Sun Down: Cordless Lift	16
Perfect-Vue: Standard Cord Control	17
Perfect-Vue: Cordless Lift	18
Multiple Shades On One Headrail	19-20
Corner And Bay Windows	21-22
Cut-out Shades, Specialty Shapes: Skylights, Premier Wood-Wrapped Rails	23
Wood Characteristics	24
Specialty Shapes: Arch Shades, Arch Over Standard Cord Control	25
Specialty Shapes: Octagon And Hexagon, Trapezoids, Angle Top/Angle Bottom	26
Making A Template For Specialty Windows, Using A Template Service	27

General Information	Page
Energy Performance, Energy Efficiency Ratings, UV Protection And Sound Absorption	29-30
Stack Height Chart: Standard Cord Control	31
Stack Width Chart: Slide-Vue™ And Standard Handle Location: Slide-Vue	32
Stack Height Chart: Perfect-Vue™	32
Cellular Shade Color Coordination Chart And Slide-Vue™ Rail Colors	33-35
Standard Cord Control Product Detail	36
Cordless Lift Product Detail	37
Continuous-loop Lift Product Detail	38
Bottom Up/Top Down: Standard Cord Control Product Detail	39
Bottom Up/Top Down: Cordless Lift Product Detail	40
Standard Cord Control Product Detail: Perfect-Vue	41
Cordless Lift Product Detail: Perfect-Vue	42
Arch Over Standard Cord Control Product Detail	43
Slide-Vue Product Detail	44

Price Charts And Options Pricing	Page
Price Group A: Translucence 3/8" (1.0 cm) Single Cell	45
Price Group B: Translucence 3/8" (1.0 cm) Double Cell And 3/4" (1.9 cm) Single Cell	46
Price Group C: Elegant Neutrals 3/8" (1.0 cm) Single Cell And 3/4" (1.9 cm) Single Cell; Garden Retreat 3/8" (1.0 cm) Single And Double Cell, 3/4" (1.9 cm) Single Cell	47
Price Group D: Night Sky 3/8" (1.0 cm) Single Cell, Scroll 3/4" (1.9 cm) Single Cell	48
Price Group E: Elegant Neutrals, Facets, Sala 3/8" (1.0 cm) Double Cell; Facets, Scroll FR 3/4" (1.9 cm) Single Cell	49
Price Group F: Cocoon 3/8" (1.0 cm) Single Cell And Double Cell	50
Price Group G: Valletta 3/8" (1.0 cm) Single Cell And 3/4" (1.9 cm) Single Cell	51
Price Group H: Cambridge 3/8" (1.0 cm) Single Cell, Simply Sheer 3/8" (1.0 cm) Single Cell, Simply Sheer 3/4" (1.9 cm) Single Cell, Solitude 3/8" (1.0 cm) Single Cell And 3/4" (1.9 cm) Single Cell	52
Price Group I: Translucence 3/8" (1.0 cm) Single Cell	53
Price Group J: Translucence 3/8" (1.0 cm) Double Cell And 3/4" (1.9 cm) Single Cell	53
Price Group K: Elegant Neutrals 3/8" (1.0 cm) Single Cell And 3/4" (1.9 cm) Single Cell; Garden Retreat 3/8" (1.0 cm) Single And Double Cell, 3/4" (1.9 cm) Single Cell	54
Price Group L: Night Sky 3/8" (1.0 cm) Single Cell, Scroll 3/4" (1.9 cm) Single Cell	55
Price Group M: Elegant Neutrals, Facets, Sala 3/8" (1.0 cm) Double Cell; Facets, Scroll FR 3/4" (1.9 cm) Single Cell	56
Price Group N: Cocoon 3/8" (1.0 cm) Single Cell And Double Cell	57
Price Group O: Valletta 3/8" (1.0 cm) Single Cell And 3/4" (1.9 cm) Single Cell	58
Price Group P: Cambridge 3/8" (1.0 cm) Single Cell, Simply Sheer 3/8" (1.0 cm) Single Cell, Simply Sheer 3/4" (1.9 cm) Single Cell, Solitude 3/8" (1.0 cm) Single Cell And 3/4" (1.9 cm) Single Cell	59
Perfect And Non-Perfect Arches Pricing	60
Options Pricing	61
Color Charts: Perfect-Vue Pleated	62-63
Color Charts: Perfect-Vue Cellular	64-66
How To Order And Price Perfect-Vue Shades	67-70



Features

Graber® CrystalPleat™ Cellular Shades are made from a variety of luxurious spunlace, point-bond or woven fabrics. These shades are highly energy efficient due to the pockets of air formed by the cellular design. The CrystalPleat collection is the perfect combination of function and fashion, providing energy efficiency while stylishly covering your windows.

- Highly energy efficient (see Energy Performance)
- Solutions for numerous privacy and light-control needs
- Offered in three cell sizes to match diverse decor styles
- Broad spectrum of on-trend colors to enhance every room
- All shade components are color coordinated

Fabric Styles And Information: Cellular Shades

Fabric Styles in. (cm)		Level of Light Control/Privacy	Fabric Content
Cambridge	⅜ (1.0) Single Cell	Light Filtering	100% Polyester Woven
Cocoon	⅜ (1.0) Double Cell	Blackout	100% Polyester Spunlace with Concealed Metallic Liner
	⅜ (1.0) Single Cell		
Elegant Neutrals	⅜ (1.0) Double Cell	Light Filtering	100% Polyester Spunlace
	¾ (1.9) Single Cell		
Facets	⅜ (1.0) Double Cell	Light Filtering and Room Darkening	100% Polyester Spunlace
	¾ (1.9) Single Cell		
Garden Retreat	⅜ (1.0) Double Cell	Light Filtering and Room Darkening	75% Polyester, 25% Wood Pulp, Spunlace
	⅜ (1.0) Single Cell		
	¾ (1.9) Single Cell		
Night Sky	⅜ (1.0) Single Cell	Blackout	100% Polyester Spunlace with White Blackout Liner
Sala	⅜ (1.0) Double Cell	Light Filtering and Room Darkening	100% Polyester Spunlace
Scroll	¾ (1.9) Single Cell	Light Filtering and Room Darkening	100% Polyester Spunlace
Scroll FR	¾ (1.9) Single Cell	Light Filtering and Room Darkening	100% Polyester Spunlace with FR Coating
Simply Sheer	⅜ (1.0) Single Cell	Sheer	100% Polyester Woven
	¾ (1.9) Single Cell		
Solitude	⅜ (1.0) Single Cell	Blackout	100% Polyester Spunlace with Metallic Liner
	¾ (1.9) Single Cell		
Translucence	⅜ (1.0) Double Cell	Light Filtering	100% Polyester Point Bond
	⅜ (1.0) Single Cell		
	¾ (1.9) Single Cell		
Valletta	⅜ (1.0) Single Cell	Light Filtering and Room Darkening	100% Polyester Woven
	¾ (1.9) Single Cell		

Light Control And Privacy

Sheer: Allows light to enter the room where light control and privacy are not a concern. Objects in the room can be seen quite clearly through shades.



Light Filtering*: Gently diffuses incoming light to provide some light control and moderate privacy.

Room Darkening*: Significantly dims light entering the room. Deeper fabric colors offer more light control and moderate privacy.

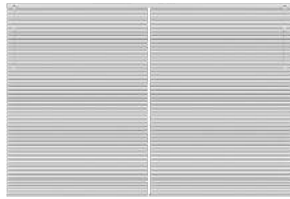

Blackout: Blocks all light from entering the room. All fabric colors provide maximum light control and complete privacy.

***These fabrics are translucent and their colors may be influenced by changing light conditions. Colors may appear to vary depending upon the time of day and type of lighting, as well as whether the shade is partially or fully lowered.**

Size Considerations



Standard Cord Control																
Fabric Styles in. (cm)		Price Group	Maximum Fabric Width in. (cm)													
				STANDARD CORD CONTROL SHADE in. (cm)				STANDARD CORD CONTROL MULTIPLE SHADES ON ONE HEADRAIL in. (cm)				STANDARD CORD CONTROL BOTTOM UP/TOP DOWN in. (cm)				
				WIDTH		HEIGHT		WIDTH		HEIGHT		WIDTH		HEIGHT		
				Min*	Max	Min	Max	Min Panel*	Max Panel	Max Shade	Min Shade	Max Shade	Min*	Max	Min	Max
Cambridge	¾ (1.0) Single Cell	H	144 (365.8)	9 (22.9)	144 (365.8)	9 (22.9)	144 (365.8)	9 (22.9)	144 (365.8)	192 (487.7)	9 (22.9)	144 (365.8)	9 (22.9)	96 (243.9)	9 (22.9)	96 (243.9)
Cocoon	¾ (1.0) Double Cell	F	86 (218.5)	9 (22.9)	86 (218.5)	9 (22.9)	96 (243.9)	9 (22.9)	86 (218.5)	192 (487.7)	9 (22.9)	96 (243.9)	12 (30.5)	86 (218.5)	12 (30.5)	80 (203.2)
	¾ (1.0) Single Cell	F	86 (218.5)	9 (22.9)	86 (218.5)	9 (22.9)	96 (243.9)	9 (22.9)	86 (218.5)	192 (487.7)	9 (22.9)	96 (243.9)	9 (22.9)	86 (218.5)	9 (22.9)	96 (243.9)
Elegant Neutrals	¾ (1.0) Double Cell	E														
	¾ (1.0) Single Cell	C	120 (304.8)	9 (22.9)	120 (304.8)	9 (22.9)	144 (365.8)	9 (22.9)	120 (304.8)	192 (487.7)	9 (22.9)	144 (365.8)	9 (22.9)	96 (243.9)	9 (22.9)	96 (243.9)
	¾ (1.9) Single Cell	C														
Facets	¾ (1.0) Double Cell	E	90 (228.6)	9 (22.9)	90 (228.6)	9 (22.9)	144 (365.8)	9 (22.9)	90 (228.6)	192 (487.7)	9 (22.9)	144 (365.8)	9 (22.9)	90 (228.6)	9 (22.9)	96 (243.9)
	¾ (1.9) Single Cell	E														
Garden Retreat	¾ (1.0) Double Cell	C														
	¾ (1.0) Single Cell	C	120 (304.8)	9 (22.9)	120 (304.8)	9 (22.9)	144 (365.8)	9 (22.9)	120 (304.8)	192 (487.7)	9 (22.9)	144 (365.8)	9 (22.9)	96 (243.9)	9 (22.9)	96 (243.9)
	¾ (1.9) Single Cell	C														
Night Sky	¾ (1.0) Single Cell	D	96 (243.9)	9 (22.9)	96 (243.9)	9 (22.9)	144 (365.8)	9 (22.9)	96 (243.9)	192 (487.7)	9 (22.9)	144 (365.8)	9 (22.9)	96 (243.9)	9 (22.9)	96 (243.9)
Sala	¾ (1.0) Double Cell	E	90 (228.6)	9 (22.9)	90 (228.6)	9 (22.9)	144 (365.8)	9 (22.9)	90 (228.6)	192 (487.7)	9 (22.9)	144 (365.8)	9 (22.9)	90 (228.6)	9 (22.9)	96 (243.9)
Scroll	¾ (1.9) Single Cell	D														
	¾ (1.9) Single Cell	E	144 (365.8)	9 (22.9)	144 (365.8)	9 (22.9)	144 (365.8)	9 (22.9)	144 (365.8)	192 (487.7)	9 (22.9)	144 (365.8)	9 (22.9)	96 (243.9)	9 (22.9)	96 (243.9)
Simply Sheer	¾ (1.0) Single Cell	H	144 (365.8)	9 (22.9)	144 (365.8)	9 (22.9)	144 (365.8)	9 (22.9)	144 (365.8)	192 (487.7)	9 (22.9)	144 (365.8)	9 (22.9)	96 (243.9)	9 (22.9)	96 (243.9)
	¾ (1.9) Single Cell	H														
Solitude	¾ (1.0) Single Cell	H	144 (365.8)	9 (22.9)	144 (365.8)	9 (22.9)	144 (365.8)	9 (22.9)	144 (365.8)	192 (487.7)	9 (22.9)	144 (365.8)	9 (22.9)	96 (243.9)	9 (22.9)	96 (243.9)
	¾ (1.9) Single Cell	H														
Translucence	¾ (1.0) Double Cell	B														
	¾ (1.0) Single Cell	A	96 (243.9)	9 (22.9)	96 (243.9)	9 (22.9)	144 (365.8)	9 (22.9)	96 (243.9)	192 (487.7)	9 (22.9)	144 (365.8)	9 (22.9)	96 (243.9)	9 (22.9)	96 (243.9)
	¾ (1.9) Single Cell	B														
Valletta	¾ (1.0) Single Cell	G	144 (365.8)	9 (22.9)	144 (365.8)	9 (22.9)	144 (365.8)	9 (22.9)	144 (365.8)	192 (487.7)	9 (22.9)	144 (365.8)	9 (22.9)	96 (243.9)	9 (22.9)	96 (243.9)
	¾ (1.9) Single Cell	G														

*For all inside mount applications, ¾" (1.0 cm) deduction is taken by manufacturer on overall width.

DEPTH REQUIREMENTS FOR INSIDE MOUNT				
	Cell Size	Headrail Dimensions	 Minimum Depth Mount	 Flush with Casing
Standard Cord Control	¾" (1.0 cm) Double and Single Cell	1 1/16" (1.8 cm) x 1 3/16" (4.0 cm)	¾" (1.6 cm)	1 7/8" (4.8 cm)
	¾" (1.9 cm) Single Cell	7/8" (2.3 cm) x 2" (5.1 cm)	1" (2.9 cm)	2 1/8" (5.4 cm)

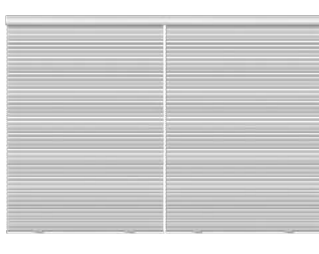

Size Considerations

Cordless Lift

Fabric Styles in. (cm)		Price Group	Maximum Fabric Width in. (cm)													
				CORDLESS LIFT SHADE in. (cm)				CORDLESS LIFT MULTIPLE SHADES ON ONE HEADRAIL in. (cm)				CORDLESS LIFT SHADE BOTTOM UP/TOP DOWN in. (cm)				
				WIDTH		HEIGHT		WIDTH		HEIGHT		WIDTH		HEIGHT		
				Min*	Max	Min	Max	Min Panel*	Max Panel	Max Shade	Min Shade	Max Shade	Min*	Max	Min	Max
Cambridge	3/8" (1.0) Single Cell	H	144 (365.8)	9 (22.9)	120 (304.8)	9 (22.9)	86 (218.5)	9 (22.9)	120 (304.8)	144 (365.8)	9 (22.9)	86 (218.5)	15 (38.1)	96 (243.9)	9 (22.9)	86 (218.5)
Cocoon	3/8" (1.0) Double Cell	F	86 (218.5)	12 (30.5)	48 (122.0)	9 (22.9)	64 (162.6)	12 (30.5)	48 (122.0)	144 (365.8)	9 (22.9)	64 (162.6)	15 (38.1)	48 (122.0)	9 (22.9)	64 (162.6)
	3/8" (1.0) Single Cell	F	86 (218.5)	9 (22.9)	86 (218.5)	9 (22.9)	86 (218.5)	9 (22.9)	86 (218.5)	144 (365.8)	9 (22.9)	86 (218.5)	15 (38.1)	86 (218.5)	9 (22.9)	86 (218.5)
Elegant Neutrals	3/8" (1.0) Double Cell	E														
	3/8" (1.0) Single Cell	C	120 (304.8)	9 (22.9)	120 (304.8)	9 (22.9)	86 (218.5)	9 (22.9)	120 (304.8)	144 (365.8)	9 (22.9)	86 (218.5)	15 (38.1)	96 (243.9)	9 (22.9)	86 (218.5)
Facets	3/4" (1.9) Single Cell	C														
	3/8" (1.0) Double Cell	E	90 (228.6)	9 (22.9)	90 (228.6)	9 (22.9)	86 (218.5)	9 (22.9)	90 (228.6)	144 (365.8)	9 (22.9)	86 (218.5)	15 (38.1)	90 (228.6)	9 (22.9)	86 (218.5)
Garden Retreat	3/8" (1.0) Double Cell	C														
	3/8" (1.0) Single Cell	C	120 (304.8)	9 (22.9)	120 (304.8)	9 (22.9)	86 (218.5)	9 (22.9)	120 (304.8)	144 (365.8)	9 (22.9)	86 (218.5)	15 (38.1)	96 (243.9)	9 (22.9)	86 (218.5)
Night Sky	3/4" (1.9) Single Cell	C														
	3/8" (1.0) Single Cell	D	96 (243.9)	9 (22.9)	96 (243.9)	9 (22.9)	86 (218.5)	9 (22.9)	96 (243.9)	144 (365.8)	9 (22.9)	86 (218.5)	15 (38.1)	96 (243.9)	9 (22.9)	86 (218.5)
Sala	3/8" (1.0) Double Cell	E	90 (228.6)	9 (22.9)	90 (228.6)	9 (22.9)	86 (218.5)	9 (22.9)	90 (228.6)	144 (365.8)	9 (22.9)	86 (218.5)	15 (38.1)	90 (228.6)	9 (22.9)	86 (218.5)
Scroll	3/4" (1.9) Single Cell	D														
Scroll FR	3/4" (1.9) Single Cell	E	144 (365.8)	9 (22.9)	120 (304.8)	9 (22.9)	86 (218.5)	9 (22.9)	120 (304.8)	144 (365.8)	9 (22.9)	86 (218.5)	15 (38.1)	96 (243.9)	9 (22.9)	86 (218.5)
Simply Sheer	3/8" (1.0) Single Cell	H	144 (365.8)	9 (22.9)	120 (304.8)	9 (22.9)	86 (218.5)	9 (22.9)	120 (304.8)	144 (365.8)	9 (22.9)	86 (218.5)	15 (38.1)	96 (243.9)	9 (22.9)	86 (218.5)
	3/4" (1.9) Single Cell	H														
Solitude	3/8" (1.0) Single Cell	H	144 (365.8)	9 (22.9)	120 (304.8)	9 (22.9)	86 (218.5)	9 (22.9)	120 (304.8)	144 (365.8)	9 (22.9)	86 (218.5)	15 (38.1)	96 (243.9)	9 (22.9)	86 (218.5)
	3/4" (1.9) Single Cell	H														
Translucence	3/8" (1.0) Double Cell	B														
	3/8" (1.0) Single Cell	A	96 (243.9)	9 (22.9)	96 (243.9)	9 (22.9)	86 (218.5)	9 (22.9)	96 (243.9)	144 (365.8)	9 (22.9)	86 (218.5)	15 (38.1)	96 (243.9)	9 (22.9)	86 (218.5)
	3/4" (1.9) Single Cell	B														
Valletta	3/8" (1.0) Single Cell	G	144 (365.8)	9 (22.9)	120 (304.8)	9 (22.9)	86 (218.5)	9 (22.9)	120 (304.8)	144 (365.8)	9 (22.9)	86 (218.5)	15 (38.1)	96 (243.9)	9 (22.9)	86 (218.5)
	3/4" (1.9) Single Cell	G														

*For all inside mount applications, 3/8" (1.0 cm) deduction is taken by manufacturer on overall width.

DEPTH REQUIREMENTS FOR INSIDE MOUNT

Cell Size	Headrail Dimensions			
		Minimum Depth Mount	Flush with Casing	
Cordless Lift Shade*	3/8" (1.0 cm) Double and Single Cell 3/4" (1.9 cm) Single Cell	1 1/2" (3.9 cm) x 2" (5.1 cm)	1/2" (1.3 cm)	2 5/8" (5.4 cm)

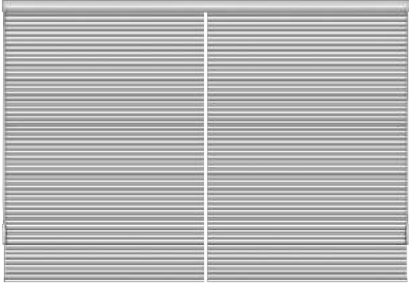

*The depth requirements for Cordless Lift shades also apply to motorized shades.

Size Considerations

Continuous-loop Lift													
Fabric Styles in. (cm)		Price Group	Maximum Fabric Width in. (cm)										
				CONTINUOUS-LOOP SHADE in. (cm)				CONTINUOUS-LOOP MULTIPLE SHADES ON ONE HEADRAIL in. (cm)					
				WIDTH		HEIGHT		WIDTH			HEIGHT		
				Min**	Max	Min	Max	Min Panel**	Max Panel	Max Shade Single Control	Max Shade Multiple Controls	Min Shade	Max Shade
Cambridge	3/8" (1.0) Single Cell	H	144 (365.8)	20 1/2" (52.1)	144 (365.8)	9 (22.9)	144 (365.8)	20 1/2" (52.1)	120 (304.8)	120 (304.8)	144 (365.8)	9 (22.9)	144 (365.8)
Cocoon	3/8" (1.0) Double Cell	F	86 (218.5)	17 (43.2)	86 (218.5)	9 (22.9)	96 (243.9)	17 (43.2)	86 (218.5)	120 (304.8)	144 (365.8)	9 (22.9)	96 (243.9)
	3/8" (1.0) Single Cell	F											
Elegant Neutrals	3/8" (1.0) Double Cell	E											
	3/8" (1.0) Single Cell	C	120 (304.8)	20 1/2" (52.1)	120 (304.8)	9 (22.9)	144 (365.8)	20 1/2" (52.1)	120 (304.8)	120 (304.8)	144 (365.8)	9 (22.9)	144 (365.8)
	3/4" (1.9) Single Cell	C											
Facets	3/8" (1.0) Double Cell	E	90 (228.6)	20 1/2" (52.1)	90 (228.6)	9 (22.9)	144 (365.8)	20 1/2" (52.1)	90 (228.6)	120 (304.8)	144 (365.8)	9 (22.9)	144 (365.8)
	3/4" (1.9) Single Cell	E											
Garden Retreat	3/8" (1.0) Double Cell	C											
	3/8" (1.0) Single Cell	C	120 (304.8)	20 1/2" (52.1)	120 (304.8)	9 (22.9)	144 (365.8)	20 1/2" (52.1)	120 (304.8)	120 (304.8)	144 (365.8)	9 (22.9)	144 (365.8)
	3/4" (1.9) Single Cell	C											
Night Sky	3/8" (1.0) Single Cell	D	96 (243.9)	20 1/2" (52.1)	96 (243.9)	9 (22.9)	144 (365.8)	20 1/2" (52.1)	96 (243.9)	120 (304.8)	144 (365.8)	9 (22.9)	144 (365.8)
Sala	3/8" (1.0) Double Cell	E	90 (228.6)	20 1/2" (52.1)	90 (228.6)	9 (22.9)	144 (365.8)	20 1/2" (52.1)	90 (228.6)	120 (304.8)	144 (365.8)	9 (22.9)	144 (365.8)
Scroll Scroll FR	3/4" (1.9) Single Cell	D	144 (365.8)	20 1/2" (52.1)	144 (365.8)	9 (22.9)	144 (365.8)	20 1/2" (52.1)	120 (304.8)	120 (304.8)	144 (365.8)	9 (22.9)	144 (365.8)
	3/4" (1.9) Single Cell	E											
Simply Sheer	3/8" (1.0) Single Cell	H	144 (365.8)	20 1/2" (52.1)	144 (365.8)	9 (22.9)	144 (365.8)	20 1/2" (52.1)	120 (304.8)	120 (304.8)	144 (365.8)	9 (22.9)	144 (365.8)
	3/4" (1.9) Single Cell	H											
Solitude	3/8" (1.0) Single Cell	H	144 (365.8)	20 1/2" (52.1)	144 (365.8)	9 (22.9)	144 (365.8)	20 1/2" (52.1)	120 (304.8)	120 (304.8)	144 (365.8)	9 (22.9)	144 (365.8)
	3/4" (1.9) Single Cell	H											
Translucence	3/8" (1.0) Double Cell	B											
	3/8" (1.0) Single Cell	A	96 (243.9)	20 1/2" (52.1)	96 (243.9)	9 (22.9)	144 (365.8)	20 1/2" (52.1)	96 (243.9)	120 (304.8)	144 (365.8)	9 (22.9)	144 (365.8)
	3/4" (1.9) Single Cell	B											
Valletta	3/8" (1.0) Single Cell	G	144 (365.8)	20 1/2" (52.1)	144 (365.8)	9 (22.9)	144 (365.8)	20 1/2" (52.1)	120 (304.8)	120 (304.8)	144 (365.8)	9 (22.9)	144 (365.8)
	3/4" (1.9) Single Cell	G											



*For all inside mount applications, 3/8" (1.0 cm) deduction is taken by manufacturer on overall width.

†Smaller width shades are available under Continuous-loop Lift in shade options.

DEPTH REQUIREMENTS FOR INSIDE MOUNT				
	Cell Size	Headrail Dimensions		
			Minimum Depth Mount	Flush with Casing
Continuous-loop Lift	3/8" (1.0 cm) Double and Single Cell 3/4" (1.9 cm) Single Cell	1 1/2" (3.9 cm) x 2" (5.1 cm)	1/2" (1.3 cm)	2 1/2" (5.4 cm)

Size Considerations

Perfect-Vue™ Standard Cord Control

Fabric Styles in. (cm)									
	STANDARD CORD CONTROL ALL CELLULAR FABRIC STYLE in. (cm)				STANDARD CORD CONTROL TWO SHADES ON ONE HEADRAIL ALL CELLULAR FABRIC STYLE in. (cm)				
	WIDTH		HEIGHT		WIDTH			HEIGHT	
	Min†	Max	Min	Max	Min Panel†	Max Panel	Max Shade	Min Shade	Max Shade

1" (2.6 cm) FashionPleat®

Allure	72 (182.9)									
Brighton	86 (218.5)									
Brighton FR	86 (218.5)									
Crossweave	72 (182.9)	12 (30.5)	72 (182.9)	12 (30.5)	96 (243.9)	12 (30.5)	72 (182.9)	144 (365.8)	12 (30.5)	96 (243.9)
Desert	72 (182.9)									
Geneva	72 (182.9)									
Sheer Linen	72 (182.9)									

1" (2.6 cm) EvenPleat®

Allure	72 (182.9)									
Brighton	86 (218.5)									
Brighton FR	86 (218.5)									
Crossweave	72 (182.9)	12 (30.5)	72 (182.9)	12 (30.5)	96 (243.9)	12 (30.5)	72 (182.9)	120 (304.8)	12 (30.5)	96 (243.9)
Desert	72 (182.9)									
Geneva	72 (182.9)									
Magnolia	88 (223.6)									
Marquis	76 (193.1)									
Mission	66 (167.7)	12 (30.5)	66 (167.7)	12 (30.5)	96 (243.9)	12 (30.5)	66 (167.7)	120 (304.8)	12 (30.5)	96 (243.9)
Prism	92 (233.7)									
Serendipity	92 (233.7)	12 (30.5)	72 (182.9)	12 (30.5)	96 (243.9)	12 (30.5)	72 (182.9)	120 (304.8)	12 (30.5)	96 (243.9)
Sheer Linen	72 (182.9)									
Visage	83 (210.9)									

2" (5.1 cm) EvenPleat



Cabana	72 (182.9)									
Crossweave	72 (182.9)									
Desert	72 (182.9)									
Geneva	72 (182.9)									
Grasscloth	72 (182.9)									
Magnolia	88 (223.6)									
Marquis	76 (193.1)	18 (45.8)	72 (182.9)	12 (30.5)	96 (243.9)	18 (45.8)	72 (182.9)	144 (365.8)	12 (30.5)	96 (243.9)
Orchestra	78 (198.2)									
Prism	92 (233.7)									
Serendipity	92 (233.7)									
Sheer Linen	72 (182.9)									
Tuvalu	72 (182.9)									

†For all inside mount applications, 5/8" (1.0 cm) deduction is taken by manufacturer on overall width.
Single shade maximum width with Cocoon Double Cell is 40" (101.6 cm), maximum height is 72" (182.9 cm).

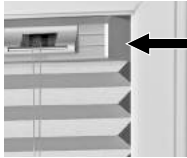
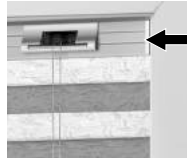
DEPTH REQUIREMENTS FOR INSIDE MOUNT

			Partially recessed headrail in window casing/molding		Fully recessed headrail in window casing/molding
	Standard Cord Control Shades Headrail Dimensions	Minimum Depth Mount		Flush with Casing	
1" (2.6 cm) Pleat	1 1/16" (1.8 cm) x 1 9/16" (4.0 cm)	5/8" (1.6 cm)		1 7/8" (4.8 cm)	
2" (5.1 cm) Pleat	7/8" (2.3 cm) x 2" (5.1 cm)	1 1/8" (2.9 cm)		2 1/8" (5.4 cm)	

Size Considerations

Perfect-Vue™ Cordless Lift																	
Fabric Styles in. (cm)	Fabric Width in. (cm)																
		CORDLESS LIFT ALL CELLULAR FABRIC STYLES EXCEPT COCOON DOUBLE CELL in. (cm)				CORDLESS LIFT COCOON DOUBLE CELL in. (cm)											
		WIDTH		HEIGHT		WIDTH		HEIGHT									
		Min†	Max	Min	Max	Min Panel†	Max Panel	Min Shade	Max Shade								
1" (2.6 cm) FashionPleat®																	
Allure	72 (182.9)	15 (38.1)	72 (182.9)	12 (30.5)	86 (218.5)	15 (38.1)	48 (122.0)	12 (30.5)	64 (162.6)								
Crossweave	72 (182.9)																
Desert	72 (182.9)																
Sheer Linen	72 (182.9)																
1" (2.6 cm) EvenPleat®																	
Allure	72 (182.9)	15 (38.1)	72 (182.9)	12 (30.5)	86 (218.5)	15 (38.1)	48 (122.0)	12 (30.5)	64 (162.6)								
Crossweave	72 (182.9)																
Desert	72 (182.9)																
Magnolia	88 (223.6)																
Marquis	76 (193.1)																
Mission	66 (167.7)																
Prism	92 (233.7)																
Serendipity	92 (233.7)																
Sheer Linen	72 (182.9)																
Visage	83 (210.9)																
2" (5.1 cm) EvenPleat																	
Cabana	72 (182.9)									15 (38.1)	72 (182.9)	12 (30.5)	86 (218.5)				
Crossweave	72 (182.9)																
Desert	72 (182.9)																
Grasscloth	72 (182.9)																
Magnolia	88 (223.6)																
Marquis	76 (193.1)																
Orchestra	78 (198.2)																
Prism	92 (233.7)																
Serendipity	92 (233.7)																
Sheer Linen	72 (182.9)																
Tuvalu	72 (182.9)																

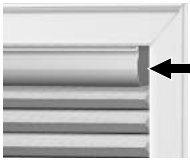

†For all inside mount applications, 3/8" (1.0 cm) deduction is taken by manufacturer on overall width.

DEPTH REQUIREMENTS FOR INSIDE MOUNT			
			Partially recessed headrail in window casing/molding
	Standard Cord Control Shades Headrail Dimensions	Minimum Depth Mount	Flush with Casing
1" (2.6 cm) and 2" (5.1 cm) Pleat	1½" (3.9 cm) x 2" (5.1 cm)	½" (1.3 cm)	2½" (5.4 cm)

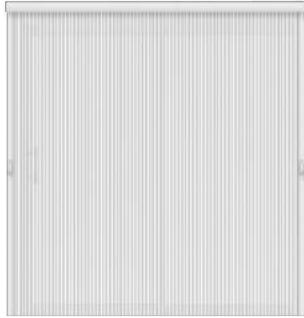
Size Considerations

Slide-Vue™ Shades							
Fabric Styles in. (cm)		Price Group	Maximum Shade Width in. (cm)	 SLIDE-VUE SHADES in. (cm)			
				WIDTH in. (cm)		HEIGHT in. (cm)	
				Min*	Max	Min	Max
Cambridge	3/8 (1.0) Single Cell	P	192 (487.7)	12 (30.5)	192 (487.7)	24 (61.0)	120 (304.8)
Cocoon	3/8 (1.0) Double Cell	N	156 (396.3)	12 (30.5)	156 (396.3)	24 (61.0)	88 (223.6)
	3/8 (1.0) Single Cell	N	192 (487.7)	12 (30.5)	192 (487.7)	24 (61.0)	88 (223.6)
Elegant Neutrals	3/8 (1.0) Double Cell	M					
	3/8 (1.0) Single Cell	K	192 (487.7)	12 (30.5)	192 (487.7)	24 (61.0)	120 (304.8)
	3/4 (1.9) Single Cell	K					
Facets	3/8 (1.0) Double Cell	M	192 (487.7)	12 (30.5)	192 (487.7)	24 (61.0)	92 (233.7)
	3/4 (1.9) Single Cell	M					
Garden Retreat	3/8 (1.0) Double Cell	K					
	3/8 (1.0) Single Cell	K	192 (487.7)	12 (30.5)	192 (487.7)	24 (61.0)	120 (304.8)
	3/4 (1.9) Single Cell	K					
Night Sky	3/8 (1.0) Single Cell	L	192 (487.7)	12 (30.5)	192 (487.7)	24 (61.0)	98 (249.0)
Sala	3/8 (1.0) Double Cell	M	192 (487.7)	12 (30.5)	192 (487.7)	24 (61.0)	92 (233.7)
Scroll	3/4 (1.9) Single Cell	L	192 (487.7)	12 (30.5)	192 (487.7)	24 (61.0)	120 (304.8)
Scroll FR	3/4 (1.9) Single Cell	M					
Simply Sheer	3/8 (1.0) Single Cell	P	192 (487.7)	12 (30.5)	192 (487.7)	24 (61.0)	120 (304.8)
	3/4 (1.9) Single Cell	P					
Solitude	3/8 (1.0) Single Cell	P	192 (487.7)	12 (30.5)	192 (487.7)	24 (61.0)	120 (304.8)
	3/4 (1.9) Single Cell	P					
Translucence	3/8 (1.0) Double Cell	J					
	3/8 (1.0) Single Cell	I	192 (487.7)	12 (30.5)	192 (487.7)	24 (61.0)	98 (249.0)
	3/4 (1.9) Single Cell	J					
Valletta	3/8 (1.0) Single Cell	O	192 (487.7)	12 (30.5)	192 (487.7)	24 (61.0)	120 (304.8)
	3/4 (1.9) Single Cell	O					

*For all inside mount applications, 1/4" (0.7 cm) deduction is taken by manufacturer on overall width and 3/8" (1.0 cm) deduction on height.

DEPTH REQUIREMENTS FOR INSIDE MOUNT				
	Cell Size	Headrail Dimensions	 Minimum Depth Mount	 Flush with Casing
Slide-Vue Shades	3/8" (1.0 cm) Double & Single Cell 3/4" (1.9 cm) Single Cell	2 5/16" (5.6 cm) x 2 1/2" (6.4 cm)	1 3/4" (4.5 cm)	2 7/8" (7.4 cm)

Options

Shade Options: For Surcharges And Pricing Refer To Pricing Section

The following is a list of options for Cellular Shades. Limitations will be based on fabric width.
(See detailed descriptions on the following pages.)

Control Type Options (see Price Charts for pricing and/or surcharges)

- Standard Cord Control
- Cordless Lift
- Continuous-loop Lift
- Motorized Lift (see Motorization Lift Tab)
- Slide-View™

Shade Options – NO CHARGE

- Cord Placement on Right or Left
- Corner or Bay Window
- Hold-down Brackets
- Projection Brackets:
 - With standard $\frac{3}{8}$ " (1.0 cm) Single and Double Cell, all Cordless, Continuous-loop and Motorized Lift:
 - Long (adds up to $2\frac{1}{2}$ " (6.4 cm) extension from wall)
 - Medium (adds up to $1\frac{5}{8}$ " (4.2 cm) extension from wall)
 - Short (adds up to 1" (2.6 cm) extension from wall)
 - With standard $\frac{3}{4}$ " (1.9 cm) Single Cell:
 - Long (adds up to $1\frac{3}{4}$ " (4.5 cm) extension from wall)
 - Medium (adds up to $\frac{7}{8}$ " (2.3 cm) extension from wall)
 - Short (adds up to $\frac{1}{4}$ " (0.7 cm) extension from wall)
 - With Slide-View:
 - Long (adds up to $2\frac{1}{4}$ " (5.8 cm) extension from wall)
 - Medium (adds up to $1\frac{1}{4}$ " (3.2 cm) extension from wall)
 - Short (adds up to $\frac{3}{4}$ " (1.9 cm) extension from wall)
- Rail color can be specified at the time of order
- Shims
- Side-mount Brackets – Inside Mount only
- Standard Cord Cleats – Clear

Specialty Shape Shade Options (see Price Charts for pricing and/or surcharges)

- Angled Top/Angled Bottom
- Arch over Standard Cord Control
- Arches
- Octagon, Hexagon or Trapezoid

Shade Options – SURCHARGE (see Price Charts for pricing and/or surcharges)

- Blackout Side Channels ($\frac{3}{8}$ " (1.0 cm) cell size with Standard Cord Control only)
- Bottom Up/Top Down—Standard Cord Control
- Bottom Up/Top Down—Cordless Lift
- Cord Winder
- Cut-outs
- Decorative Cord Cleats: Solid Brass, Antique Brass
- Multiple Shades on One Headrail
- Perfect-View™ Shade—Standard Cord Control
- Perfect-View Shade—Cordless Lift
- Premier Wood-Wrapped Rails—Cordless, Motorized and Continuous-loop Lift only
- Sky Pole
- Skylight Shades
- Sun Up/Sun Down—Standard Cord Control
- Sun Up/Sun Down—Cordless Lift
- Top Down Only—Continuous-loop Lift
- Wood Cornice (see Cornice and Valance Tab)

Options

Standard Cord Control

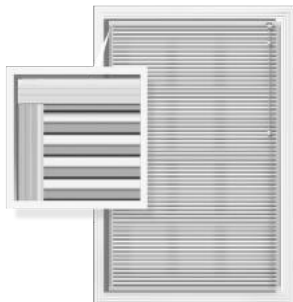

- **No charge**
- Standard Cord Control includes a color-coordinated cord
- Controls can be placed on the right (standard) or left side
- Cord management safety options keep the cord out of reach of children and pets to eliminate dangling cord hazards
- Available as multiple shades on one headrail (standard gap ½" (1.3 cm))
- Side mounts available up to 60" (152.4 cm) wide by 96" (243.9 cm) high
- Cord length is approximately ⅓ of the shade height
- Blackout side channels are available:
 - Surcharge: (see Options Pricing)
 - ⅜" (1.0 cm) Single and Double Cell only
 - Standard Cord Control only
 - Side channels are white satin 205 in color

Size Considerations	Minimum Width* in (cm)	Maximum Width in (cm)	Minimum Height in (cm)	Maximum Height in (cm)
All Fabric Styles except Cocoon Double Cell	9 (22.9)	144 (365.8) [†]	9 (22.9)	144 (365.8)
Cocoon	9 (22.9)	86 (218.5)	9 (22.9)	96 (243.9)

*For all inside mount applications, ⅜" (1.0 cm) deduction is taken by manufacturer on overall width.

[†]Based on fabric width.

Cordless Lift



- **For surcharge, see Price Charts**
- Safest window shade; ideal for homes with children or pets
- An optional sky pole is available for hard to reach shades 36" (91.5 cm) or less in width. Sky poles are not recommended over 36" (91.5 cm), however, if required, two sky poles should be ordered to ensure even operation
- Side mounts available up to 60" (152.4 cm) wide
- Available as multiple shades on one headrail (standard gap ⅜" (1.0 cm))

Size Considerations	Minimum Width* in (cm)	Maximum Width in (cm)	Minimum Height in (cm)	Maximum Height in (cm)
All Fabric Styles except Cocoon Double Cell	9 (22.9)	120 (304.8) [†]	9 (22.9)	86 (218.5)
Cocoon Double Cell	12 (30.5)	48 (122.0)	9 (22.9)	64 (162.6)

*For all inside mount applications, ⅜" (1.0 cm) deduction is taken by manufacturer on overall width.

[†]Based on fabric width.

NOTE: All Cordless Lift shades should be used on windows where the consumer can comfortably raise and lower the shade with their hand and have easy access. Very high windows should use Standard Cord Control shades rather than Cordless Lift.

Options

Continuous-loop Lift



- **For surcharges, see Price Charts**
- Recommended for larger, heavier shades
- The clutch mechanism in the color coordinated aluminum headrail assists in raising and lowering the shade, it stops the shade at any point and holds the bottomrail level
- A single continuous-loop cord raises and lowers the shade and keeps the cord the same length
- Five colors of continuous-loop cord available
- Tensioner device will coordinate with color of the loop
- Continuous-loop Lift stacks the fully raised shade more compactly than a Standard Cord Control and holds it more securely
- Safety tensioner device included, tensioner must be installed for shade operation
- Available as multiple shades on one headrail (standard gap ½" (1.3 cm))
- Available on Top Down Only specialty shades
- Side mounts available up to 60" (152.4 cm) wide by 96" (243.9 cm) high
- Shades over 5000 sq. in. (3.22 sq. m) on all single cell except Cocoon and over 4000 sq. in. (2.58 sq. m) on all double cell and Cocoon single cell use a larger clutch ratio for easier lifting, but additional pulls are required to raise the shade

Size Considerations	Minimum Width* in (cm)	Maximum Width in (cm)	Minimum Height in (cm)	Maximum Height in (cm)
All Fabric Styles except Cocoon	20½ (52.1)	144 (365.8)†	9 (22.9)	144 (365.8)
Cocoon	17 (43.2)	86 (218.5)	9 (22.9)	96 (243.9)

*For all inside mount applications, ⅜" (1.0 cm) deduction is taken by manufacturer on overall width.

†Based on fabric width.

Loop Cord and Tensioner Device Colors:

Coffee	079
Smokey Gray	026
Tender Taupe	103
Vanilla	100
White	00

For Shades Less Than Minimum Width:

If finished shade width is in (cm)	Maximum Height of Shade in (cm)
equal to 16⅝ (42.3) but less than 17 (43.2)	96⅝ (244.5)
equal to 17 (43.2) but less than 17½ (44.5)	100⅝ (256.3)
equal to 17½ (44.5) but less than 18 (45.8)	107⅝ (272.1)
equal to 18 (45.8) but less than 18½ (47.0)	113⅝ (288.3)
equal to 18½ (47.0) but less than 19 (48.3)	119⅝ (304.2)
equal to 19 (48.3) but less than 19½ (49.6)	126 (320.1)
equal to 19½ (49.6) but less than 20 (50.8)	132⅝ (336.3)
equal to 20 (50.8) but less than 20½ (52.1)	138⅝ (352.2)
20½ (52.1) or greater	144 (365.8)

Control length for Continuous-loop Lift shades varies based on finished shade height (see below). Optional cord loop length (sizes listed in chart) can be specified at the time of order.

Finished Shade Height in (cm)	Cord Loop Length in (cm)
12 (30.5) - 26 (66.1)	18 (45.8)
26⅝ (66.2) - 38 (96.6)	24 (61.0)
38⅝ (96.7) - 50 (127.0)	36 (91.5)
50⅝ (127.2) - 62 (157.5)	48 (122.0)
62⅝ (157.7) - 74 (188.0)	60 (152.4)
74⅝ (188.2) - 96 (243.9)	72 (182.9)
96⅝ (244.0) - 120 (304.8)	84 (213.4)
120⅝ (305.0) - 130 (330.2)	96 (243.9)
130⅝ (330.4) - 144 (365.8)	108 (274.4)

Optional cord lengths: 144" (365.8 cm) and 180" (457.2 cm)

Options

Motorized Lift



- Refer to **Motorization Cost and Reference Guide** for additional options, sizing and pricing
- Window treatments can be operated from virtually anywhere in the home
- Provides easy operation of hard-to-reach or large window coverings
- Efficiently manages energy (heat gain and loss)
- Operate multiple window treatments simultaneously or individually
- A safer alternative to accessible cords that are traditionally used to operate window coverings, ideal for homes with children and pets
- Easily integrated with home automation systems
- Low voltage motorization requires no costly electrical hard-wiring
- Multiple control options available



NOTE: Motorization components and accessories have a five-year limited warranty, excluding batteries.

Options

Top Down Only



- **For surcharge, see Options Pricing**
- Top Down only operates with the Continuous-loop Lift (Continuous-loop surcharge is included in the Top Down Only surcharge)
- Multiple shades on one headrail available, standard gap between shades is 1/2" (1.3 cm)
- Not available with Cut-outs
- Side mounts not available
- Bottomrail must be mounted

Size Considerations	Minimum Width* in (cm)	Maximum Width in (cm)	Minimum Height in (cm)	Maximum Height in (cm)
All Fabric Styles except Cocoon Double Cell	17 (43.2)	72 (182.9)	12 (30.5)	96 (243.9)
Cocoon Double Cell	17 (43.2)	61 (155.0)	12 (30.5)	73 (185.5)

*For all inside mount applications, 3/8" (1.0 cm) deduction is taken by manufacturer on overall width.

NOTE: Top Down Only shades that exceed the maximum width may be made as multiple shades on one headrail. However, an additional surcharge will be added if the total ordered width is less than or equal to the maximum fabric width.

Bottom Up/Top Down: Standard Cord Control



- **For surcharge, see Options Pricing**
- Multiple shades on one headrail available, standard gap between shades is 1/2" (1.3 cm)
- Standard control is right control - operates bottom up, while left control operates shade from the top down, this can be reversed
- Option allows for privacy yet lets natural light shine in
- Not available with cut-outs
- Midrail cord contains a cord release device
- Side mount brackets available up to 60" (152.4 cm) width on one shade, multiple shades maximum width is 42" (106.7 cm) with side mounts

Size Considerations	Minimum Width* in (cm)	Maximum Width in (cm)	Minimum Height in (cm)	Maximum Height in (cm)	Number of Cord Release Devices	
					1 Device in (cm)	2 Device in (cm)
All Fabric Styles except Cocoon Double Cell	9 (22.9)	96† (243.9)†	9 (22.9)	96 (243.9)	Up to 48 (122.0) wide	Over 48 (122.0) wide
Cocoon Double Cell	12 (30.5)	86 (218.5)	12 (30.5)	80 (203.2)	Up to 48 (122.0) wide	Over 48 (122.0) wide

*For all inside mount applications, 3/8" (1.0 cm) deduction is taken by manufacturer on overall width.

†Based on fabric width.

NOTE: Bottom Up/Top Down Standard Cord Control Shades that exceed the maximum width may be made as multiple shades on one headrail. However, an additional surcharge will be added if the total ordered width is less than or equal to the maximum fabric width.

Options

Bottom Up/Top Down: Cordless Lift



- **For surcharge, see Options Pricing**
- Option allows for privacy; lets in natural light
- Suggested use on windows where consumers can comfortably raise and lower the shade with their hand (Bottom Up/Top Down Standard Cord Control shade is recommended for hard-to-reach windows)
- Cordless Lift shades are a safer alternative to shades with accessible cords that are traditionally used to operated window coverings; ideal for homes with children and pets
- To operate shade, use both handles on each rail to raise and lower shade
- Side mounts available up to 60" (152.4 cm) wide
- Not available with cut-outs
- Not available with multiple shades on one headrail
- Sky poles are not recommended, however, if required, two sky poles should be ordered to ensure even operation

Size Considerations	Minimum Width* in (cm)	Maximum Width in (cm)	Minimum Height in (cm)	Maximum Height in (cm)
All Fabric Styles except Cocoon Double Cell	15 (38.1)	96 (243.9)	9 (22.9)	86 (218.5)
Cocoon Double Cell	15 (38.1)	48 (122.0)	9 (22.9)	64 (162.6)

*For all inside mount applications, 3/8" (1.0 cm) deduction is taken by manufacturer on overall width.

Options

Sun Up/Sun Down: Standard Cord Control



- **Price as two separate Standard Cord Control shades from price charts and combine the prices for total cost**
- Perfect for combining light controls of sheer or light filtering and blackout or room-darkening fabrics
- 3/8" (1.0 cm) Single Cell and 3/8" (1.0 cm) Double Cell fabrics can be combined
- 3/4" (1.9 cm) Single Cell cannot be combined with 3/8" (1.0 cm) Single Cell or Double Cell
- Headrail coordinates with top fabric
- Bottomrail coordinates with bottom fabric
- Midrail will match headrail as a default, can specify to match bottom rail at the time of order
- Standard control is right control — operates bottomrail, while left control operates intermediate rail (can be reversed)
- When combining Cocoon Double Cell with another fabric, refer to the size limitation for Cocoon Double Cell; Cocoon Double Cell must always be the top of the two fabrics
- Midrail cord contains a cord release device
- Available as Multiple Shades on One Headrail (standard gap 1/2" (1.3 cm))
- Side mounts available:
 - Single shade width: 60" (152.4 cm)
 - Multiple Shades on One Headrail: 42" (106.7 cm)

Size Considerations	Minimum Width* in (cm)	Maximum Width in (cm)	Minimum Height in (cm)	Maximum Height in (cm)	Number of Cord Release Devices	
					1 Device in (cm)	2 Device in (cm)
All Fabric Styles except Cocoon Double Cell	12 (30.5)	74 (188.0)	12 (30.5)	96 (243.9)	Up to 48(122.0) wide	Over 48 (122.0) wide
Cocoon Double Cell	12 (30.5)	40 (101.6)	12 (30.5)	72 (182.9)	Up to 48(122.0) wide	Over 48 (122.0) wide

*For all inside mount applications, 3/8" (1.0 cm) deduction is taken by manufacturer on overall width.

Options

Sun Up/Sun Down: Cordless Lift



- **Price as two separate Standard Cord Control shades from price charts and add one Cordless Lift surcharge for total cost**
- Perfect for combining light controls of sheer or light filtering and blackout or room-darkening
- Cordless Lift shades are a safer alternative to shades with accessible cords that are traditionally used to operated window coverings, ideal for homes with children and pets
- $\frac{3}{8}$ " (1.0 cm) Single Cell and $\frac{3}{8}$ " (1.0 cm) Double Cell fabrics can be combined
- $\frac{3}{4}$ " (1.9 cm) Single Cell cannot be combined with $\frac{3}{8}$ " (1.0 cm) Single Cell or Double Cell
- Headrail coordinates with top fabric
- Bottomrail coordinates with bottom fabric
- Midrail will match headrail as a default, can specify to match bottomrail at time of order
- To operate shade, use both handles on each rail to raise and lower shade
- When combining Cocoon Double Cell with another fabric, refer to the size limitation for Cocoon Double Cell
- Side mounts available—Single shade width: 60" (152.4 cm)
- Not available with Multiple Shades on One Headrail
- Sky poles are not recommended, however if required, two sky poles should be ordered to ensure even operation

Size Considerations	Minimum Width* in (cm)	Maximum Width in (cm)	Minimum Height in (cm)	Maximum Height in (cm)
All Fabric Styles except Cocoon Double Cell	15 (38.1)	96 (243.9)	12 (30.5)	86 (218.5)
Cocoon Double Cell	15 (38.1)	48 (122.0)	12 (30.5)	64 (162.6)

*For all inside mount applications, $\frac{3}{8}$ " (1.0 cm) deduction is taken by manufacturer on overall width.

Options

Perfect-Vue™: Standard Cord Control



- **For pricing, see Price Charts**
- Perfect for combining light controls of sheer light filtering pleated fabric with room darkening, or blackout cellular fabrics
- Standard control is right control — operates bottomrail, while left control operates intermediate rail (can be reversed)
- 1" (2.6 cm) pleated can be combined with 3/8" (1.0 cm) Double Cell and Single Cell cellular fabrics only
- 2" (5.1 cm) pleated can be combined with 3/4" (1.9 cm) Single Cell cellular fabric only
- Midrail cord includes a cord release device
- Headrail coordinates with top fabric
- Bottomrail coordinates with bottom cellular fabric
- Midrail will match headrail as default; however, can specify to match bottomrail at time of order
- Not available with Cut-outs, overlap or liners
- EvenPleat shades offer a unique back ladder support; pleats will not sag or flatten out for the life of the shade
- Available as Multiple Shades on One Headrail (standard gap 1/2" (1.3 cm))
- Side mounts available:
 - Single shade width: 60" (152.4 cm)
 - Multiple shades on one headrail: 42" (106.7 cm)

Size Considerations	Minimum Width* in (cm)	Maximum Width in (cm)	Minimum Height in (cm)	Maximum Height in (cm)	Number of Cord Release Devices	
					Up to 44 (111.8) wide in (cm)	Over 44 (111.8) wide in (cm)
1" (2.6 cm) FashionPleat®	12 (30.5)	72**† (182.9) as Single Shade 144" (365.8) as two on one	12 (30.5)†	96 (243.9)†	1	2
1" (2.6 cm) EvenPleat®	12 (30.5)	72**† (182.9) as Single Shade 120" (304.8) as two on one	12 (30.5)†	96 (243.9)†	1	2
2" (5.1 cm) EvenPleat	18 (45.8)	72** (182.9) as Single Shade 144 (365.8) as two on one	12 (30.5)	96 (243.9)	1	2

*For all inside mount applications, 3/8" (1.0 cm) deduction is taken by manufacturer on overall width.

**Maximum single shade width is 72" (182.9 cm) or maximum fabric width, whichever is smaller.

†Single shade maximum with Cocoon Double Cell is 40" (101.6 cm), maximum height is 72" (182.9 cm).

Options

Perfect-Vue™: Cordless Lift



- **For pricing, see Price Charts**
- Perfect for combining light controls of sheer light filtering pleated fabric, with room darkening, or blackout cellular fabrics
- Cordless Lift shades are a safer alternative to shades with accessible cords that are traditionally used to operated window coverings, ideal for homes with children and pets
- 1" (2.6 cm) pleated can be combined with 3/8" (1.0 cm) Double Cell and Single Cell cellular fabrics only
- 2" (5.1 cm) pleated can be combined with 3/4" (1.9 cm) Single Cell cellular fabric only
- Not available with Cut-outs, overlap or liners
- EvenPleat® shades offer a unique back ladder support; pleats will not sag or flatten out for the life of the shade
- Headrail coordinates with pleated top fabric
- Bottomrail coordinates with bottom cellular fabric
- Midrail will match headrail as default; however, can specify to match bottomrail at time of order
- Not available with Multiple Shades on One Headrail
- All Cordless Lift Perfect-Vue shades need to be used on windows where consumers can comfortably raise and lower the shade with their hands and have easy access. Very high windows should use the Standard Cord Control option, rather than Cordless Lift. Operation of shade requires both sets of handles be used to properly raise and lower rails
- Side mounts available: Single shade width: 60" (152.4 cm)
- Sky poles not recommended, however, if required, two sky poles should be ordered to ensure even operation.

Size Considerations		Minimum Width* in (cm)	Maximum Width in (cm)	Minimum Height in (cm)	Maximum Height in (cm)
1" (2.6 cm) Pleat	All Fabric Styles except Cocoon Double Cell	15 (38.1)	84 (213.4)**	12 (30.5)	86 (218.5)
1" (2.6 cm) Pleat	Cocoon Double Cell	15 (38.1)	48 (122.0)	12 (30.5)	64 (162.6)
2" (5.1 cm) Pleat	All Fabric Styles	15 (38.1)	84 (213.4)**	12 (30.5)	86 (218.5)

*For all inside mount applications, 3/8" (1.0 cm) deduction is taken by manufacturer on overall width.

**Maximum single shade width is 84" (213.4 cm) or maximum fabric width, whichever is smaller.

Options

Multiple Shades On One Headrail: Continuous-loop Lift

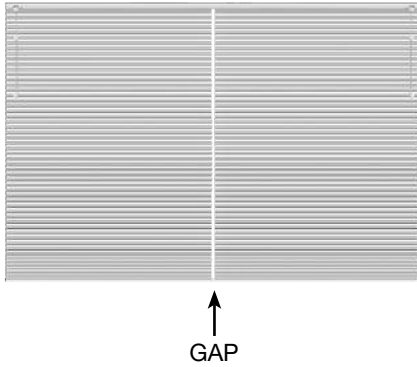

- For surcharge, see Price Charts or Options Pricing
- Available as two or three on one headrail
- Shade widths exceeding fabric width made as two or three shades on one headrail: No charge
- Side mount brackets available on shades 60" (152.4 cm) or smaller
- Bottom Up/Top Down and Sun Up/Sun Down Standard Cord Control multiple shades on one headrail: Side mounts available on shades 42" (106.7 cm) or smaller

Size Considerations	Maximum Overall Size For Multiple Shades* in (cm)	Maximum Size with Side Mount in (cm)	Control Locations	Gap in (cm)
Continuous-loop Lift Single Control Shade	120 (304.8) x 144 (365.8)	60 (152.4) x 96 (243.9)	Two-on-one: Common lift cord can be on right or left to operate both shades at the same time Three-on-one: Common lift cord can be on right or left to operate all shades at the same time	½ (1.3)
Continuous-loop Lift Multi Control Shade	144 (365.8) x 144 (365.8)	60 (152.4) x 96 (243.9)	Two-on-one: Left shade, left control Right shade, right control Three-on-one: Left shade, left control Right shade, right control Middle shade, common lift cord to right or left blind Continuous-loop Lift cannot be used in the middle of the headrail on multiple shades	½ (1.3)
Continuous-loop Lift Top Down Only-Single Control Shade	120 (304.8) x 96 (243.9)	NA	Two-on-one: Common lift cord can be on right or left to operate both shades at the same time Three-on-one: Common lift cord can be on right or left to operate all shades at the same time	½ (1.3)
Continuous-loop Lift Top Down Only-Multi Control Shade	144 (365.8) x 96 (243.9)	NA	Two-on-one: Left shade, left control Right shade, right control Three-on-one: Left shade, left control Right shade, right control Middle shade, common lift cord to right or left blind Continuous-loop Lift cannot be used in the middle of the headrail on multiple shades	½ (1.3)

*See Size Considerations section for the minimum and maximum panel widths.

Options

Multiple Shades On One Headrail

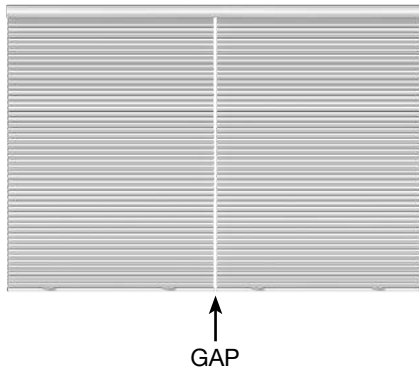

- For surcharge, see Price Charts or Options Pricing
- Available as two or three shades on one headrail
- Perfect-Vue™ Standard Cord Control Shades are only available as two on one headrail
- Shade widths exceeding fabric width made as two or three shades on one headrail: No charge
- Side mount brackets available on shades 60" (152.4 cm) or smaller.
- Bottom Up/Top Down and Sun Up/Sun Down Standard Cord Control multiple shades on one headrail: Side mounts available on shades 42" (106.7 cm) or smaller.

Size Considerations	Maximum Overall Size For Multiple Shades* in (cm)	Maximum Size with Side Mount in (cm)	Control Locations	Gap in (cm)
Cordless Lift†	144 (365.8) x 86 (218.5)	60 (152.4) x 86 (218.5)	Not applicable	3/8 (1.0)
Standard Cord Control	192 (487.7) x 144 (365.8)	60 (152.4) x 96 (243.9)	Two-on-one: Left shade, left control Right shade, right control Three-on-one: Left shade, left control Middle shade, right control Right shade, right control	1/2 (1.3)
Bottom Up/Top Down Standard Cord Control	192 (487.7) x 96 (243.9)	42 (106.7) x 96 (243.9)	Per panel: Right control operates bottom up; left control operates top down (can be reversed)	1/2 (1.3)
Sun Up/Sun Down Standard Cord Control	192 (487.7) x 96 (243.9)	42 (106.7) x 96 (243.9)	Per panel: Right control operates bottom up; left control operates top down (can be reversed)	1/2 (1.3)
EvenPleat® Perfect-Vue Standard Cord Control	120 (304.8) x 96 (243.9)	42 (106.7) x 96 (243.9)	Per panel: Right control operates bottom up; left control operates top down (can be reversed)	1/2 (1.3)
FashionPleat® Perfect-Vue Standard Cord Control	144 (365.8) x 96 (243.9)	42 (106.7) x 96 (243.9)	Per panel: Right control operates bottom up; left control operates top down (can be reversed)	1/2 (1.3)
Motorized Lift	Refer to Motorization Cost and Reference Guide.			

*See Size Considerations section for the minimum and maximum panel widths.

Options

Corner Windows

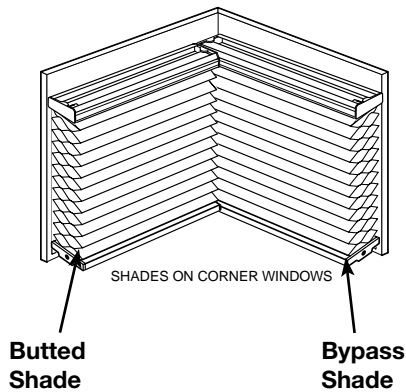

TOP VIEW

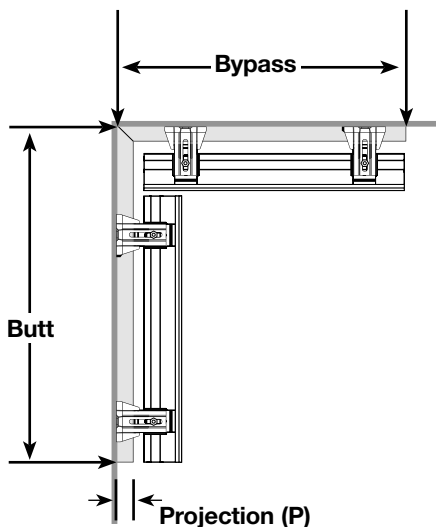
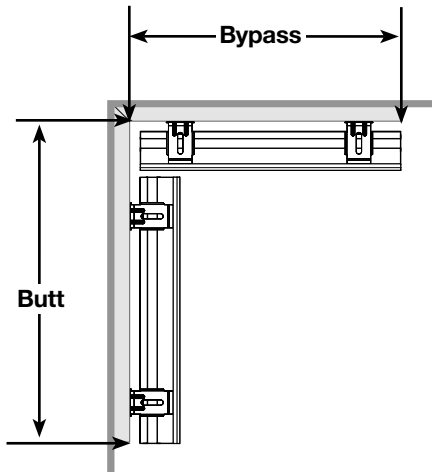

- **No charge**
- Made as individual shades
- Each shade will have its own control, we recommend opposite corners
- Indicate for each shade whether left or right and butt or bypass
- Bypass shade is mounted into the corner, butt shade is abutted to the other shade
- Manufacturer will take appropriate deductions for proper fit. **DO NOT** order as a Corner shade if you do not want manufacturer to take deductions.
- **Cornices are not available on corner windows**
- For Bottom Up/Top Down and Sun Up/Sun Down Standard Cord Control shades the corner controls will be hard to reach
- For Slide-View shades, the handles between the Bypass and Butt shades will be offset 3¾" (9.6 cm) from each other for ease of operation

Measuring Information

Mounting on a Wall or Molding

Measure the width of each window from the corner on the mounting surface (molding or wall) to the point you would like to cover.

Mounting Above the Molding:

Measure the width of each window from the corner on the mounting surface to the point you would like to cover.

Projection measurement is the distance needed to clear any molding or obstructions that the shade will be mounted above.

Note: The **Projection (P)** distance is needed to correctly calculate deductions for installations where the shades will use shims or projection brackets to clear molding. All projection distances must match for correct deductions to be calculated.

Options

Bay Windows

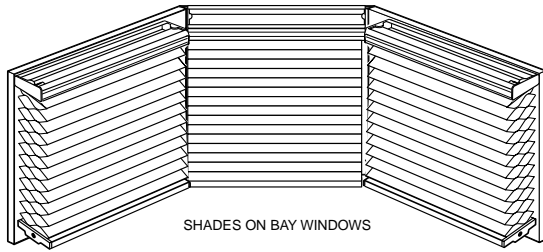

- No charge
- Made as individual shades
- Each section will have its own control
- Manufacturer will take appropriate deductions for proper fit. DO NOT order as a bay window shade if you do not want manufacturer to take deductions
- Cornices are not available on bay windows
- For Bottom Up/Top Down and Sun Up/Sun Down with Standard Cord Control the corner controls will be hard to reach
- For Slide-Vue shades there is a light gap between adjacent side rails

Measuring Information: Three-sided Bay Window

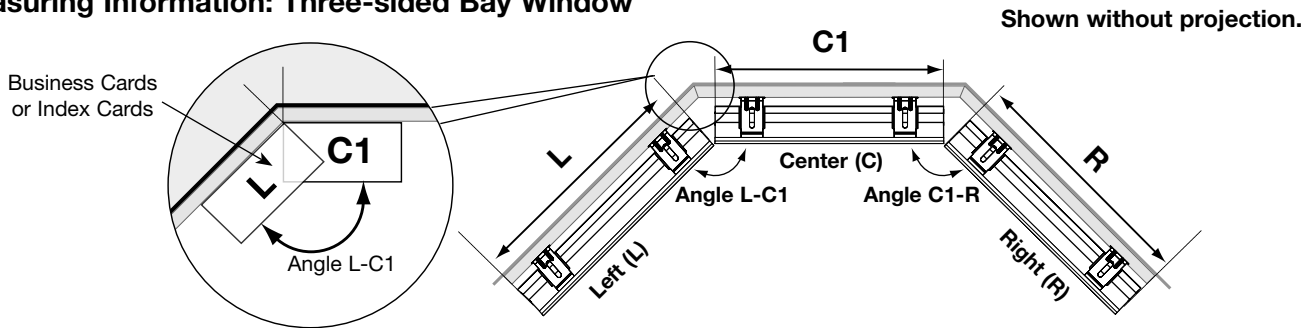

Measure:

- L and R:** Width of each side window from the corners on the mounting surface to the point you would like to cover.
- C1:** Width of the center window on the mounting surface from corner to corner.

- Angle L-C1:** Angle between the (L) and (C1) windows.
- Angle C1-R:** Angle between the (C1) and (R) windows.
- Projection:** If needed: The depth of the trim or molding the shade will be mounted above.

Measuring Information: Four-sided Bay Window

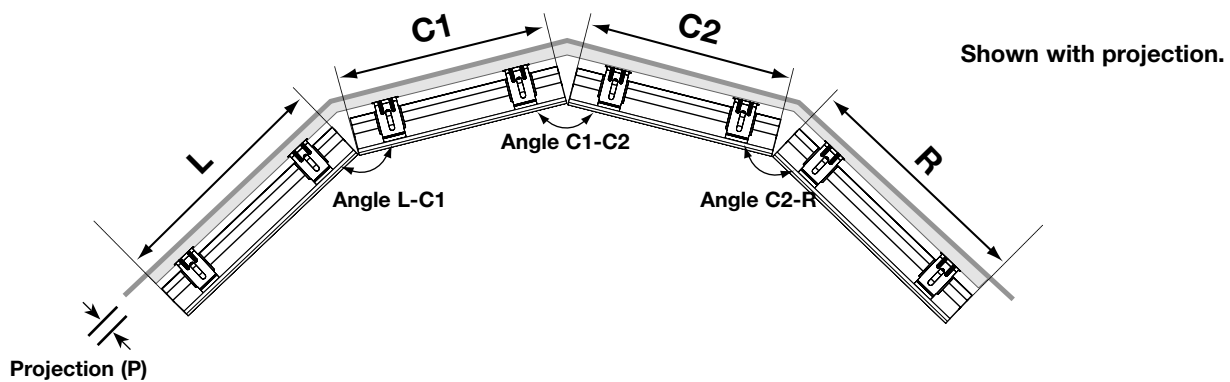

- L and R:** Width of each side window from the corners on the mounting surface to the point you would like to cover.
- C1, C2:** Width of each center window on the mounting surface from corner to corner.

- Angle L-C1:** Angle between the (L) and (C1) windows.
- Angle C1-C2:** Angle between the (C1) and (C2) windows.
- Angle C2-R:** Angle between the (C2) and (R) windows.
- Projection(P):** If needed: The depth of the trim or molding the shade will be mounted above.

Note: The **Projection (P)** distance is needed to correctly calculate deductions for installations where the shades will use shims or projection brackets to clear trim or molding. All projection distances must match for correct deductions to be calculated. For additional windows on bays with up to five sides continue with number progression for center shade sizes (C1, C2, C3, ...) and angles (Angle C1-C2, Angle C2-C3, ...) as needed.

Measure each bay angle using a protractor or angle finder or use two business cards in each bay corner as illustrated above, **trace on paper**, and fax to customer service.

The angle to use between adjacent center bay windows along a straight section of wall is 180° (degrees).

Options

Cut-out Shades



Without Intermediate Rail

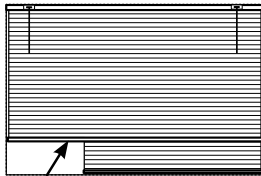

With Intermediate Rail

- **For surcharge, see Options Pricing**
- Only available with a Standard Cord Control shade
- If cut-out width exceeds 1" (2.6 cm) or cut-out height exceeds 6" (15.3 cm), there will be an intermediate bottomrail with a separate control to operate the bottom panel
- Maximum width cut-out for shades less than or equal to 48" (122.0 cm) is 25% of the shade width, maximum cut-out for shades over 48" (122.0 cm) is 12" (30.5 cm)
- When ordering cut-out on each side of shade, both cut-outs must be same width and height
- Available as bottom corner cut-out only
- Cut-outs are measured from the bottom up
- Side mounts available up to 60" (152.4 cm) wide exact

Size Considerations	Minimum Cut-out	Minimum Width*	Maximum Width†	Maximum Height
All Fabric Styles	1/8" (0.2 cm)	18" (45.8 cm)	144" (365.8 cm)	96" (243.9 cm)

*For all inside mount applications, 3/8" (1.0 cm) deduction is taken on overall width.

†Based on fabric width.

SkyTrack™ Skylight

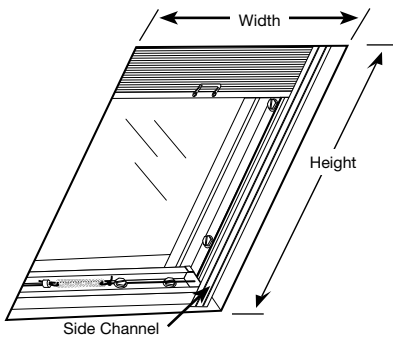

Side Channel



Sky Pole

Sizes available: 3 - 6½ ft. (91.5 cm - 198.2 cm)
and 5 - 9½ ft. (152.4 cm - 289.6 cm)

- **For surcharge, see Options Pricing**
- Widths over 30¾" (78.2 cm) will have a center cord visible when the shade is open
- Includes white aluminum side channels
- Operates with handle on center rail
- Brackets will be visible on an outside mount
- Skylight poles are telescoping and available upon request
- Side mounts not available
- Window top and bottom corners must be 90° (degrees)
- Not available with Continuous-loop Lift, Cordless Lift, Motorized Lift or ¾" (1.9 cm) Single Cell fabrics
- 90° (degree) corners at top and bottom are required for mounting

Size Considerations	Minimum Recess	Flush Mount
Mounting Depth	1½" (3.9 cm)	2" (5.1 cm)

Size Considerations	Minimum Width	Maximum Width*	Minimum Height	Maximum Height*
All Fabric Styles	12¾" (32.4 cm)	61" (155.0 cm)	12" (30.5 cm)	61" (155.0 cm)

*For a width of 30¾" (78.2 cm) or less, maximum shade height is 96" (243.9 cm).

Premier Wood-Wrapped Rails



- **For surcharge, see Options Pricing**
- Perfect for homes with stained wood trim. Improves transition from shade to window.
- Available on Cordless Lift, Motorized and Continuous-loop Lift only
- Available on Cellular and 2" (5.1 cm) EvenPleat fabrics only
- Not available as multiple shades on one headrail

Premier Wood-Wrapped Rails Color Chart	
Color	Color Number
Cherry Wood	1014
Golden Oak	1030
Natural	1007
Saddle Brown	1694
Walnut	1012
Wheat	1710

Options

Wood Characteristics

Wood used to manufacture Premier Wood-Wrapped Rails has many natural characteristics that make it truly unique; no two pieces of hardwood are alike. The following are all natural characteristics of wood, and we do not consider them to be defects:

- **Grain** – The direction, size, and appearance of wood fibers vary greatly depending on where the wood is cut within the tree
- **Tiger Striping** – Directional change in grain pattern
- **Burl** – Formed from an irregular growth on the outer edge of the tree
- **Bird's Eye** – Small area on the surface of the board where fibers are contorted to form circular figures that resemble birds' eyes
- **Mineral Marks** – Dark or discolored areas caused by minerals which the tree extracts from the soil; they can be either streaks or stains, usually blackish blue

Natural variations in color and grain effect are inherent in the beauty of wood. These variations are within established industry guidelines and should be expected. In addition, shutters may stain slightly darker or lighter than the samples shown.

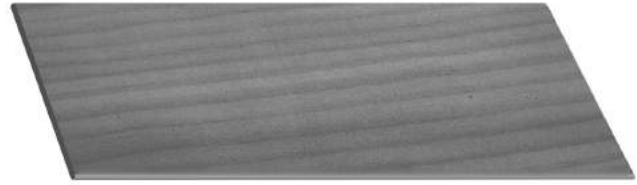

Flat Grain

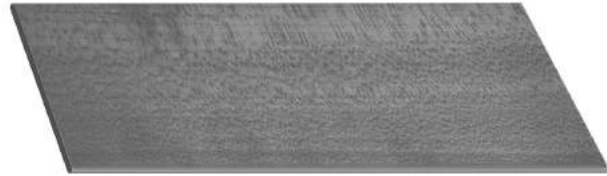

Grain Change

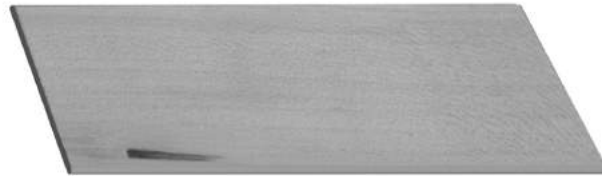

Mineral Marks



Tiger Striping

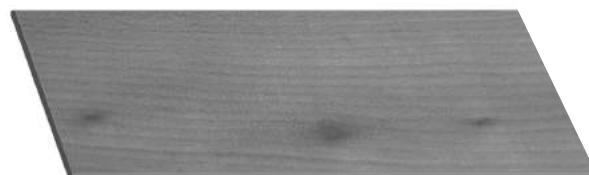

Burl/Bird's Eye

Options

Specialty Shapes: Arch Shades

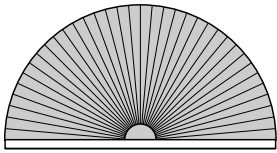

Perfect Arch: Half Circle

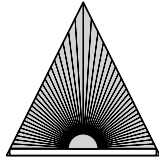

Triangle
(template required)

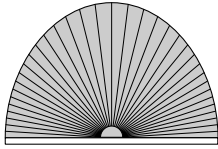

Palladian
(template required)
Illustration not to scale.

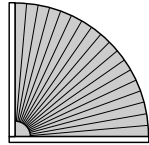

Quarter Circle
(template not required if perfect quarter)

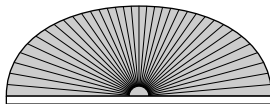

Eyebrow Arch
(template required)

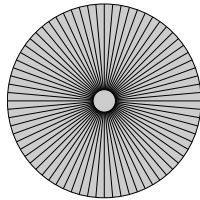

Full Circle
(template not required if perfect circle)

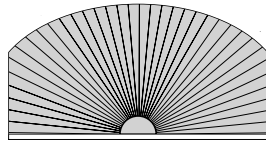

Elongated Arch
(arch with straight sides)
(template required)

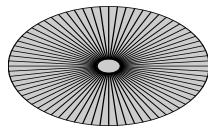

Non-perfect Circle
(=oval)

- For surcharge, see **Options Pricing**
- Include width and height measurements on all orders
- For inside mount, measure inside of window frame; for outside mount, add the desired amount of overlap to your measurements
- All arches are stationary
- Outside mount brackets will be visible
- Side mounts available up to 60" (152.4 cm) wide exact

PERFECT ARCHES are those in which the radius of the circle is constant at all points (height is exactly one-half the width).

PERFECT QUARTER CIRCLE AND FULL CIRCLE are those in which the width and the height are the same.

NON-PERFECT ARCHES are not constant at all points. Deviation of even 1/16" (0.2 cm) makes it imperfect. Non-perfect Quarter Circles and Circles are those where the width and height are different.

- All non-perfect arches require a template

SIZE CONSIDERATIONS

Specialty	Minimum Width* in (cm)	Maximum Width in (cm)	Minimum Height in (cm)	Maximum Height in (cm)
Half Circle	9 (22.9)	84 (213.4)	4½ (11.5)	42 (106.7)
Palladian, Elongated, Eyebrow and Triangle	9 (22.9)	84 (213.4)	20% of width; minimum 4½ (11.5)	60% of width
Quarter Circle	9 (22.9)	47 (119.4)	9 (22.9)	1.5 times width
Full Circle	9 (22.9)	36 (91.5) of width total	9 (22.9)	36 (91.5)

*For all inside mount applications—3/8" (1.0 cm) deduction is taken on overall width.

Recess Depth and Flush Mount in (cm)	Minimum Recess in (cm)	Flush Mount in (cm)
3/8" (1.0 cm) Cell Size	5/8" (1.6)	1 7/8" (4.8)
3/4" (1.9 cm) Cell Size	1 1/8" (2.9)	2 1/8" (5.4)

Specialty Shapes: Arch Over Standard Cord Control Shade

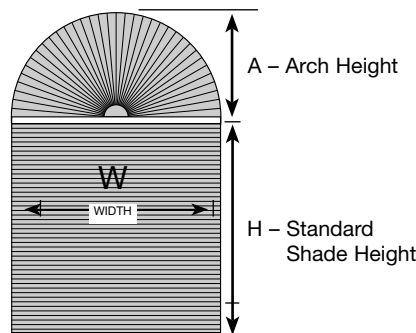

- For pricing of arches, see **Arch Pricing in pricing section**
- If you want a single shade to cover the arch and standard portion of the window (without a separation between), order the shade as an "Arch Over Standard"
- Arch Over Standard Cord Control shades are made as one shade with no light gap between the arch and standard shade portions of the window
- The arch portion is fixed while the standard portion operates normally
- When ordering, provide the three measurements W, H and A (shown to the left) along with a template of the arch portion if it is non-perfect
- Inside mount must be side mounted
- **Arch and standard portion must have same width**
- Template required for all Non Perfect Arch over Standard Cord Control shades
- Arch Over Standard Cord Control shades are only available as a Standard Cord Control shade or as a Bottom Up/Top Down Standard Cord Control shade

	Minimum Shade & Arch Width* in (cm)	Maximum Shade & Arch Width† in (cm)	Minimum Std Shade Height in (cm)	Maximum Height in (cm)	Minimum Arch Height in (cm)
Arch	12 (30.5)	60 (152.4)	9 (22.9)	96 (243.9)	20% of width; minimum 4½ (11.5)
Quarter Circle	12 (30.5)	47 (119.4)	9 (22.9)	96 (243.9)	20% of width; minimum 9 (22.9)

*For all inside mount applications—3/8" (1.0 cm) deduction is taken on overall width

Options

Specialty Shapes: Octagon And Hexagon

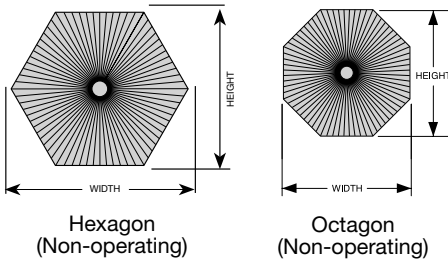

- For surcharge, see Options Pricing
- Provide width and height at center of shade
- Octagon and Hexagon require template
- Octagon and Hexagon are stationary (no controls)

	Minimum Total Width & Height in (cm)	Maximum Total Width & Height in (cm)
All Fabric Styles	9 (22.9)	36 (91.5)

Specialty Shapes: Trapezoids

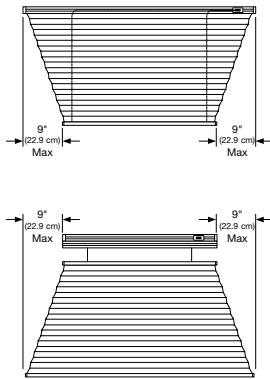

- For surcharge, see Options Pricing
- Only available with Standard Cord Control option
- Trapezoids only open in direction of the longest rail, longest rail will be fixed
- Trapezoids with one straight side are not available
- Must provide measurements of all four sides, diagram with all dimensions noted is required
- Side mounts not available

	Minimum Width & Height in (cm)	Maximum Width of Long Rail in (cm)	Max. Difference Between Long & Short Rails on Each Side in (cm)	Maximum Height in (cm)
All Fabric Styles	12 (30.5)	74 (188.0)	9 (22.9)	96 (243.9)

Specialty Shapes: Angle Top/Angle Bottom

Short Side 4" (10.2 cm) and Over:

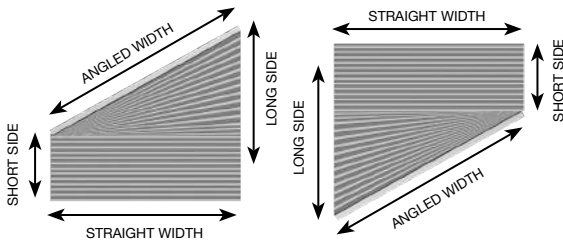

- For surcharge, see Options Pricing
- Only available with Standard Cord Control option
- Specify angle top or angle bottom when ordering
- Angle top control must always be on the low side
- Angle bottom control can be in either the left or right, must specify
- Angle top not available with side mount
- Angle bottom is available with side mount up to 41" (104.2 cm) wide
- Only operates to the intermediate rail, will not completely lift to full angle, depending on degree of an angle, shade may be difficult to operate

Short Side 0" (0.0 cm) – 4" (10.2 cm):

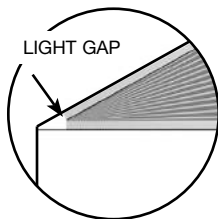

Size Considerations

	All Fabric Styles except Cocoon Double Cell in (cm)	Cocoon Double Cell in (cm)
Minimum Angled Width	12 (30.5)	12 (30.5)
Maximum Top Angle Width	90 (228.6)*	84 (213.4)
Minimum Short Side of Angle	0 (0.0)	0 (0.0)
Maximum Bottom Angle Width	41 (104.2)	30 (76.2)
Minimum Long Side Height	9 (22.9)	9 (22.9)
Maximum Long Side Height	96 (243.9)	91 (231.2)
Maximum Angle Top Degree	3/8 (1.0) Single and Double Cell: 60° (degrees) 3/4 (1.9) Single Cell: 45° (degrees)	60° (degrees)
Maximum Angle Bottom Degree	45° (degrees)	45° (degrees)

*Cocoon Single Cell is 84" (213.4 cm). Facets are 88" (223.6 cm).

NOTE: Angle top short side height of 4" (10.2 cm) or less will be stationary. As the short side measurement approaches 0" (0.0 cm) a light gap will exist to allow for the rails and fabrics to fit. Angle bottom not available on 3/4" (1.9 cm) Single Cell fabrics.

Options

Making A Template For Specialty Windows

1. Tape butcher paper or heavy brown wrapping paper over the window opening allowing plenty of overlap.
2. Being careful not to press against the template paper while tracing, draw an exact outline of the window opening. Pressing on the template paper may distort the paper and cause the wrong size to be made.
3. Remove the paper from the window opening. If the shade is an outside mount, add the desired amount of overlap to the window outline. Draw a second outline around it to match the shape of the finished shade. **Be sure to erase the inside line.**
4. Mark the dimensions on the template. Check that the template dimensions match your measurements of the actual window opening.

NOTE: Make sure the template is of the window opening, not the measurement of the glass only.

5. Cut the shape from the paper.
6. **PLACE THE TEMPLATE BACK INTO THE WINDOW OPENING TO CHECK FOR PROPER FIT.**
7. **Indicate on the template:**
 - "Room side" and "top"
 - Purchase order number
 - Customer's name
 - Your store name and account number
8. Attach a copy of your purchase order to the template.
9. Roll up template and place in a mailing tube.
DO NOT FOLD TEMPLATE.

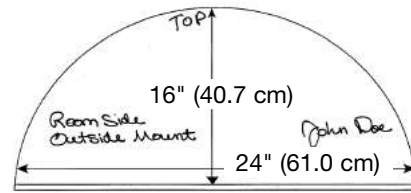

NOTE: This is just a sample for illustration purposes only— other information may be needed for your order.

Mail to: SPRINGS WINDOW FASHIONS LLC
33 West Third Street
Suite 400
Williamsport, PA 17701

NOTE: When mailing, make sure to get a tracking number and note your return address on the mailing tube.

ACCEPTABLE MATERIALS FOR MAKING TEMPLATES:

- Kraft Paper
- Butcher Paper
- Construction Paper

WE WILL NOT ACCEPT TEMPLATES MADE FROM THE FOLLOWING MATERIALS:

- | | |
|----------------------|----------------|
| Newspaper | Plastic |
| Wax Paper | Fabric |
| Tissue Paper | Roofing Paper |
| Existing Arch Shades | Wrapping Paper |
| Poster Board | Cardboard |

NOTE: If the material used to make a template stretches, tears easily, will not lay flat, or will mark the fabric, IT WILL NOT BE USED.

Using A Template Service

For surcharge, see Options Pricing

To use the template service, simply:

1. Select Template Service when entering your order online.
2. Use the template worksheet to determine what measurements you need to supply for each shape.
3. Enter the lettered measurements using line item comments. The comments have been pre-programmed to all of the measurements you need to enter for your special shape.

For additional information contact Customer Service.

General Information

Energy Performance

Graber® Cellular Shades are the smart choice for every window in your home. For year-round comfort, Cellular Shades effectively insulate your windows from the heat and cold. Regardless of climate, they are our most versatile and energy efficient window treatment available.

Cocoon fabric is constructed with three layers made up of a 100% metalized polyester film sealed between two layers of soft, high quality 100% spunlace fabric. This unique design forms a soft, thick barrier of insulation. Independent tests prove Cocoon 3/8" (1.0 cm) Double Cell fabric is one of our most energy efficient fabrics on the market.*

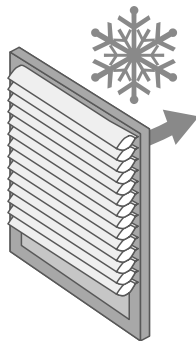

Block the Cold
Homes in colder climates benefit from Cellular Shades' insulating properties to block out the cold and regulate inside temperatures.

Cocoon 3/8" (1.0 cm) Double Cell delivers a 22% reduction in heat transfer during the winter.*

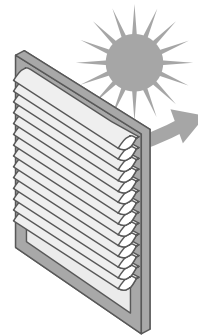

Block the Sun
Homes in warmer climates benefit from Cellular Shades' light-blocking properties to keep the heat from transferring to the inside.

Cocoon 3/8" (1.0 cm) Double Cell delivers a 56% reduction in heat transfer during the summer.*

*Values listed are for Cocoon 3/8" (1.0 cm) Double Cell. Based on third party testing, Architectural Testing Incorporated (ATI).

Energy Efficiency Ratings

DOUBLE PANE LOW-E (DOUBLE GLAZING) WINDOW & WINDOW COVERING				
Fabric in (cm)	R-Value (Higher is Better)	% Reduction Of Heat Transfer	SHGC (Lower is Better)	% Reduction Of Heat Transfer
Cocoon 3/8" (1.0) Double Cell	4.76	22.20%	0.12	56%
Elegant Neutrals 3/8" (1.0) Single Cell	4.55	21.58%	0.12	57%
Solitude 3/8" (1.0) and 3/4" (1.9) Single Cell Night Sky 3/8" (1.0) Single Cell	4.55	21.21%	0.12	58%
Cocoon 3/8" (1.0) Single Cell	4.55	20.91%	0.12	56%
Elegant Neutrals, Facets, Garden Retreat, Sala 3/8" (1.0) Double Cell	4.55	20.84%	0.10	63%
Translucence 3/8" (1.0) Double Cell	4.55	20.76%	0.15	48%
Garden Retreat 3/8" (1.0) Single Cell	4.55	19.55%	0.14	49%
Translucence 3/8" (1.0) Single Cell	4.55	18.89%	0.16	42%
Elegant Neutrals, Garden Retreat, Facets, Translucence, Scroll, Scroll FR 3/4" (1.9) Single Cell	4.39	16.00%	0.17	38%
Cambridge 3/8" (1.0) Single Cell Simply Sheer and Valletta 3/8" (1.0) and 3/4" (1.9) Single Cell	4.00	10.28%	0.19	30%

NFRC 102 2010 performed by Architectural Testing Inc.

R-Value
R-Value indicates the effectiveness of the window covering at preventing energy from flowing to the outside. The higher the R-Value, the greater the insulating effectiveness.

Solar Heat Gain Coefficient (SHGC)
SHGC measures how well window covering blocks heat from the sun from flowing to the interior. SHGC is expressed as a number between 0 and 1. The lower the SHGC, the better a product is at blocking unwanted heat gain.

General Information

UV Protection

Graber® Cellular shades effectively block ultraviolet (UV) rays. Over exposure to the sun's UV rays can damage furnishings, wood floors, draperies, carpeting and artwork. The Ultraviolet Protection Factor (UPF) rating system measures the UV protection provided by the fabric.

Fabric in (cm)	UPF Rating	% of UV Blockage
¾ (1.0) Double Cell: Cocoon, Elegant Neutrals, Facets, Garden Retreat, Sala, Translucence	50	99%
¾ (1.0) Single Cell: Cocoon, Elegant Neutrals, Garden Retreat, Night Sky, Solitude, Translucence		
¼ (1.9) Single Cell: Elegant Neutrals, Facets, Garden Retreat, Scroll, Scroll FR, Solitude, Translucence	<15	71%
¾ (1.0) Single Cell: Cambridge, Simply Sheer, Valletta		
¾ (1.9) Single Cell: Simply Sheer, Valletta		

UPF Rating

The UPF Rating system measures the UV protection, both UVA and UVB provided by fabric. It is very similar to the SPF rating system used for sunscreens. UPF ratings range from 15 (good) to 50+ (excellent). Shade with a UPF of 50 blocks 99% of the UV radiation.

UV Blockage

UV Blockage is directly related to UPF and shows window covering's effectiveness at preventing ultraviolet rays from entering an interior. The percentage rating indicates the amount of UV rays blocked by the shade.

Sound Absorption

Graber Cellular shades absorb sound to make rooms comfortable and cozy. The noise reduction coefficient (NRC) represents the amount of sound energy absorbed by the shade. An NRC of 0 indicates perfect reflection; an NRC of 1 indicates perfect absorption.

Fabric in (cm)	Sound Absorption (Higher is Better)
Elegant Neutrals, Facets, Garden Retreat, Sala ¾ (1.0) Double Cell	0.60
Elegant Neutrals, Garden Retreat ¾ (1.0) and ¼ (1.9) Single Cell; Facets, Scroll ¼ (1.9) Single Cell	0.55
Cocoon, Translucence ¾ (1.0) Double Cell	0.45
Solitude, Translucence ¾ (1.0) Single Cell; Solitude, Translucence ¼ (1.9) Single Cell, Night Sky ¾ (1.0) Single Cell	0.45
Cocoon ¾ (1.0) Single Cell	0.40
Cambridge, Simply Sheer ¾ (1.0) Single Cell; Simply Sheer, Valletta ¼ (1.9) Single Cell	0.30

General Information

Stack Height Chart: Standard Cord Control

HEIGHT OF SHADE in (cm)	TOTAL THICKNESS in (cm)				
	$\frac{3}{8}$ " (1.0) Double Cell Cocoon in (cm)	$\frac{3}{8}$ " (1.0) Double Cell Elegant Neutrals, Facets, Garden Retreat, Sala; $\frac{3}{8}$ " (1.0) Single Cell Cocoon in (cm)	$\frac{3}{8}$ " (1.0) Double Cell Translucence; $\frac{3}{8}$ " (1.0) Single Cell Elegant Neutrals, Garden Retreat, Night Sky in (cm)	$\frac{3}{8}$ " (1.0) Single Cell Cambridge, Translucence; $\frac{3}{4}$ " (1.9) Single Cell Elegant Neutrals, Facets, Garden Retreat, Scroll, Scroll FR in (cm)	$\frac{3}{8}$ " (1.0) Single Cell Simply Sheer, Solitude, Valletta; $\frac{3}{4}$ " (1.9) Single Cell Simply Sheer, Solitude, Translucence, Valletta in (cm)
18 (45.8)	2 $\frac{5}{8}$ (6.7)	2 (5.1)	1 $\frac{1}{8}$ (4.8)	1 $\frac{1}{8}$ (4.8)	1 $\frac{1}{8}$ (4.2)
30 (76.2)	3 $\frac{1}{8}$ (8.0)	2 $\frac{1}{2}$ (6.4)	2 $\frac{1}{4}$ (5.8)	2 $\frac{1}{8}$ (5.4)	1 $\frac{1}{8}$ (4.8)
42 (106.7)	3 $\frac{3}{4}$ (9.6)	3 (7.7)	2 $\frac{5}{8}$ (6.7)	2 $\frac{5}{8}$ (6.1)	2 $\frac{1}{8}$ (5.4)
54 (137.2)	4 $\frac{1}{4}$ (10.8)	3 $\frac{3}{8}$ (8.6)	3 (7.7)	2 $\frac{5}{8}$ (6.7)	2 $\frac{1}{4}$ (5.8)
66 (167.7)	4 $\frac{3}{8}$ (12.4)	3 $\frac{3}{8}$ (9.9)	3 $\frac{3}{8}$ (8.6)	2 $\frac{7}{8}$ (7.4)	2 $\frac{1}{2}$ (6.4)
78 (198.2)	5 $\frac{1}{2}$ (14.0)	4 $\frac{3}{8}$ (11.2)	3 $\frac{3}{4}$ (9.6)	3 $\frac{1}{4}$ (8.3)	2 $\frac{5}{8}$ (6.7)
90 (228.6)	6 (15.3)	4 $\frac{3}{4}$ (12.4)	4 $\frac{1}{8}$ (10.5)	3 $\frac{1}{2}$ (8.9)	2 $\frac{5}{8}$ (7.4)
96 (243.9)	6 $\frac{1}{8}$ (16.2)	5 $\frac{1}{8}$ (13.1)	4 $\frac{3}{8}$ (11.2)	3 $\frac{3}{8}$ (9.3)	3 (7.7)
108 (274.4)		5 $\frac{3}{8}$ (14.3)	4 $\frac{3}{4}$ (12.1)	3 $\frac{3}{8}$ (9.9)	3 $\frac{3}{8}$ (8.0)
120 (304.8)		6 (15.3)	5 $\frac{1}{8}$ (13.1)	4 $\frac{1}{4}$ (10.8)	3 $\frac{3}{8}$ (8.6)
132 (335.3)		6 $\frac{1}{2}$ (16.6)	5 $\frac{1}{2}$ (14.0)	4 $\frac{1}{2}$ (11.5)	3 $\frac{3}{8}$ (9.3)
144 (365.8)		7 (17.8)	5 $\frac{3}{4}$ (15.0)	4 $\frac{3}{4}$ (12.1)	3 $\frac{3}{4}$ (9.6)

$\frac{3}{8}$ " (1.0 cm) Double Cell and Single Cell

All stack calculations are with Standard Cord Controls.

For Cordless Lift, Continuous-loop, and Motorized add 1" (2.6 cm).

For BU/TD with Standard Cord Controls add $\frac{3}{8}$ " (1.0 cm), with Cordless Lift Controls add 1 $\frac{1}{8}$ " (4.2 cm).

For SU/SD with Standard Cord Controls add the two fabric stacks together and subtract $\frac{3}{8}$ " (1.0 cm) for the total stack height.

For SU/SD with Cordless Lift add the two fabric stacks together and add $\frac{1}{2}$ " (1.3 cm) for the total stack height.

$\frac{3}{4}$ " (1.9 cm) Single Cell

All stack calculations are with Standard Cord Controls.

For Cordless, Continuous-loop, and Motorized Lift add $\frac{7}{8}$ " (2.3 cm).

For BU/TD with Standard Cord Controls add $\frac{3}{8}$ " (1.0 cm), with Cordless Lift Controls add 1 $\frac{3}{8}$ " (3.5 cm).

For SU/SD with Standard Cord Controls add the two fabric stacks together and subtract $\frac{3}{8}$ " (1.6 cm) for the total stack height.

For SU/SD with Cordless Lift add the two fabric stacks together and add $\frac{1}{8}$ " (0.4 cm) for the total stack height.

General Information

Stack Width Chart: Slide-Vue™

Height of shade is indicated across the top and width of shade is indicated on the left side of chart.

Shade Stack Width Includes Side Rails in. (cm)														
WIDTH OF SHADE in. (cm)	% (1.0) Double Cell Cocoon in (cm)		% (1.0) Double Cell Garden Retreat in (cm)		% (1.0) Double Cell Elegant Neutrals, Facets, Sala, Translucence in (cm)		% (1.0) Single Cell Garden Retreat in (cm)		% (1.0) Single Cell Elegant Neutrals, Night Sky, Translucence; % (1.9) Single Cell Elegant Neutrals, Facets, Garden Retreat, Scroll, Scroll FR, Simply Sheer, Solitude, Translucence, Valletta in (cm)		% (1.0) Single Cell Cambridge, Simply Sheer, Solitude, Valletta in (cm)			
	< 72 (182.9)	88 (223.6)	< 72 (182.9)	120 (304.8)	< 72 (182.9)	120* (304.8)	< 72 (182.9)	88 (223.6)	< 72 (182.9)	120 (304.8)	< 72 (182.9)	120 (304.8)	< 72 (182.9)	120 (304.8)
72 (182.9)	9 ⁵ / ₁₆ (24.5)	13 ³ / ₁₆ (34.0)	9 ⁵ / ₁₆ (24.5)	13 ³ / ₁₆ (34.0)	9 ⁵ / ₁₆ (24.5)	13 ³ / ₁₆ (34.0)	9 ⁵ / ₁₆ (24.5)	13 ³ / ₁₆ (34.0)	9 ⁵ / ₁₆ (24.5)	13 ³ / ₁₆ (34.0)	9 ⁵ / ₁₆ (24.5)	13 ³ / ₁₆ (34.0)	9 ⁵ / ₁₆ (24.5)	13 ³ / ₁₆ (34.0)
84 (213.4)	10 ¹ / ₂ (26.7)	13 ³ / ₁₆ (34.0)	9 ⁵ / ₁₆ (24.5)	13 ³ / ₁₆ (34.0)	9 ⁵ / ₁₆ (24.5)	13 ³ / ₁₆ (34.0)	9 ⁵ / ₁₆ (24.5)	13 ³ / ₁₆ (34.0)	9 ⁵ / ₁₆ (24.5)	13 ³ / ₁₆ (34.0)	9 ⁵ / ₁₆ (24.5)	13 ³ / ₁₆ (34.0)	9 ⁵ / ₁₆ (24.5)	13 ³ / ₁₆ (34.0)
96 (243.9)	11 ¹ / ₂ (29.3)	13 ³ / ₁₆ (34.0)	9 ⁵ / ₁₆ (24.5)	13 ³ / ₁₆ (34.0)	9 ⁵ / ₁₆ (24.5)	13 ³ / ₁₆ (34.0)	9 ⁵ / ₁₆ (24.5)	13 ³ / ₁₆ (34.0)	9 ⁵ / ₁₆ (24.5)	13 ³ / ₁₆ (34.0)	9 ⁵ / ₁₆ (24.5)	13 ³ / ₁₆ (34.0)	9 ⁵ / ₁₆ (24.5)	13 ³ / ₁₆ (34.0)
108 (274.4)	12 ¹ / ₂ (31.8)	13 ³ / ₁₆ (34.0)	9 ⁵ / ₁₆ (25.1)	13 ³ / ₁₆ (34.0)	9 ⁵ / ₁₆ (24.5)	13 ³ / ₁₆ (34.0)	9 ⁵ / ₁₆ (24.5)	13 ³ / ₁₆ (34.0)	9 ⁵ / ₁₆ (24.5)	13 ³ / ₁₆ (34.0)	9 ⁵ / ₁₆ (24.5)	13 ³ / ₁₆ (34.0)	9 ⁵ / ₁₆ (24.5)	13 ³ / ₁₆ (34.0)
120 (304.8)	13 ³ / ₁₆ (34.7)	13 ³ / ₁₆ (35.3)	10 ³ / ₁₆ (27.0)	13 ³ / ₁₆ (34.0)	9 ⁵ / ₁₆ (24.5)	13 ³ / ₁₆ (34.0)	9 ⁵ / ₁₆ (24.5)	13 ³ / ₁₆ (34.0)	9 ⁵ / ₁₆ (24.5)	13 ³ / ₁₆ (34.0)	9 ⁵ / ₁₆ (24.5)	13 ³ / ₁₆ (34.0)	9 ⁵ / ₁₆ (24.5)	13 ³ / ₁₆ (34.0)
132 (335.3)	14 ¹ / ₂ (37.2)	14 ¹ / ₂ (37.8)	11 ¹ / ₂ (29.3)	13 ³ / ₁₆ (34.0)	10 ³ / ₁₆ (26.4)	13 ³ / ₁₆ (34.0)	9 ⁵ / ₁₆ (24.5)	13 ³ / ₁₆ (34.0)	9 ⁵ / ₁₆ (24.5)	13 ³ / ₁₆ (34.0)	9 ⁵ / ₁₆ (24.5)	13 ³ / ₁₆ (34.0)	9 ⁵ / ₁₆ (24.5)	13 ³ / ₁₆ (34.0)
144 (365.8)	15 ³ / ₁₆ (39.7)	15 ³ / ₁₆ (40.4)	12 ¹ / ₄ (31.2)	14 ¹ / ₂ (35.9)	11 ¹ / ₄ (28.6)	13 ³ / ₁₆ (34.0)	9 ⁵ / ₁₆ (24.5)	13 ³ / ₁₆ (34.0)	9 ⁵ / ₁₆ (24.5)	13 ³ / ₁₆ (34.0)	9 ⁵ / ₁₆ (24.5)	13 ³ / ₁₆ (34.0)	9 ⁵ / ₁₆ (24.5)	13 ³ / ₁₆ (34.0)
156 (396.3)	16 ³ / ₁₆ (42.3)	17 (43.2)	13 (33.1)	15 ³ / ₁₆ (39.1)	11 ¹ / ₂ (29.6)	14 ¹ / ₂ (35.9)	10 ³ / ₁₆ (26.1)	13 ³ / ₁₆ (34.0)	9 ⁵ / ₁₆ (24.5)	13 ³ / ₁₆ (34.0)	9 ⁵ / ₁₆ (24.5)	13 ³ / ₁₆ (34.0)	9 ⁵ / ₁₆ (24.5)	13 ³ / ₁₆ (34.0)
168 (426.8)			13 ³ / ₁₆ (35.3)	16 ¹ / ₂ (41.3)	12 ¹ / ₂ (31.8)	15 ³ / ₁₆ (39.1)	10 ³ / ₁₆ (27.7)	13 ³ / ₁₆ (34.0)	9 ⁵ / ₁₆ (24.5)	13 ³ / ₁₆ (34.0)	9 ⁵ / ₁₆ (24.5)	13 ³ / ₁₆ (34.0)	9 ⁵ / ₁₆ (24.5)	13 ³ / ₁₆ (34.0)
180 (457.2)			14 ³ / ₁₆ (37.2)	17 ¹ / ₂ (43.5)	13 ³ / ₁₆ (33.7)	16 ¹ / ₄ (41.3)	11 ¹ / ₂ (29.3)	13 ³ / ₁₆ (34.0)	10 ³ / ₁₆ (27.0)	13 ³ / ₁₆ (34.0)	9 ⁵ / ₁₆ (24.5)	13 ³ / ₁₆ (34.0)	9 ⁵ / ₁₆ (24.5)	13 ³ / ₁₆ (34.0)
192 (487.7)			15 ¹ / ₂ (39.4)	18 ³ / ₁₆ (46.7)	13 ³ / ₁₆ (35.0)	17 ¹ / ₂ (43.5)	12 (30.5)	13 ³ / ₁₆ (34.0)	10 ³ / ₁₆ (27.3)	13 ³ / ₁₆ (34.0)	9 ⁵ / ₁₆ (24.5)	13 ³ / ₁₆ (34.0)	9 ⁵ / ₁₆ (24.5)	13 ³ / ₁₆ (34.0)

*Facet, Sala maximum shade height 96" (243.9 cm)

*Translucence maximum shade height 98" (249.0 cm)

NOTE: For a clear opening, stack width must be doubled.

Stack Height Chart: Perfect-Vue™

All Pleated Fabrics Plus Cellular Fabrics Below in. (cm)					
HEIGHT OF SHADE in. (cm)	% (1.0 cm) Double Cell: Cocoon in (cm)	% (1.0 cm) Double Cell: Elegant Neutrals, Facets, Garden Retreat, Sala, Translucence; % (1.0 cm) Single Cell: Cocoon in (cm)	% (1.0 cm) Double Cell: Elegant Neutrals, Garden Retreat, Night Sky, Translucence in (cm)	% (1.0 cm) Single Cell: Cambridge, Scroll, Scroll FR, Simply Sheer, Solitude, Valletta % (1.9 cm) Single Cell: Facets, Garden Retreat in (cm)	% (1.9 cm) Single Cell: Elegant Neutrals, Simply Sheer, Solitude, Translucence, Valletta in (cm)
12 (30.5)	3 ³ / ₁₆ (8.6)	2 ⁷ / ₁₆ (7.4)	2 ⁷ / ₁₆ (6.7)	2 ⁷ / ₁₆ (6.4)	2 ⁷ / ₁₆ (6.7)
24 (61.0)	4 ¹ / ₄ (10.8)	3 ³ / ₁₆ (9.3)	3 ¹ / ₄ (8.3)	3 (7.7)	2 ⁷ / ₁₆ (7.4)
36 (91.5)	5 ¹ / ₄ (13.1)	4 ³ / ₁₆ (11.2)	3 ⁷ / ₁₆ (9.9)	3 ¹ / ₂ (8.9)	3 ¹ / ₄ (8.3)
48 (122.0)	6 (15.3)	5 ¹ / ₄ (13.1)	4 ¹ / ₂ (11.5)	4 (10.2)	3 ³ / ₁₆ (9.3)
60 (152.4)	6 ³ / ₄ (17.2)	5 ³ / ₁₆ (15.0)	5 ¹ / ₄ (13.4)	4 ¹ / ₂ (11.5)	4 (10.2)
72 (182.9)	7 ³ / ₄ (19.7)	6 ³ / ₁₆ (16.9)	5 ³ / ₁₆ (15.0)	5 ¹ / ₄ (13.1)	4 ³ / ₁₆ (11.2)
84 (213.4)		7 ³ / ₁₆ (18.8)	6 ¹ / ₂ (16.6)	5 ³ / ₁₆ (14.3)	4 ³ / ₁₆ (12.1)
96 (243.9)		8 ³ / ₁₆ (20.7)	7 ³ / ₁₆ (18.1)	6 ³ / ₁₆ (15.6)	5 ¹ / ₄ (13.1)

NOTE: Sizes are approximate.

All stack calculations are with Standard Cord Controls, for Cordless Lift Controls add 7/8" (2.3 cm).

Stack height includes all rails and both pleated and cellular fabrics together, but is based on the cellular fabric chosen.

Thickest pleated fabric was used for calculation.

Standard Handle Location: Slide-Vue

Standard Handle Location

- Up to 98" (249.0 cm) finished shade height the handle is centered on side rails
- 98¹/₁₆" (249.1 cm) to 120" (304.8 cm) finished shade height the handle will be 48" (122.0 cm) from the bottom of the side rails

Special Handle Height Location

- For specifications see chart

Slide-Vue Shade Special Handle Location Chart		
Shade Height less than or equal to in (cm)	Minimum Handle Distance From Bottom of Shade in (cm)	Maximum Handle Distance From Bottom of Shade in (cm)
24 (61.0) – 36 (91.5)	11 (28.0)	16 (40.7)
36 ¹ / ₁₆ (91.6) – 46 (116.9)	11 (28.0)	28 (71.2)
46 ¹ / ₁₆ (117.0) – 62 (157.5)	13 (33.1)	38 (96.6)
62 ¹ / ₁₆ (157.7) – 74 (188.0)	15 (38.1)	30 (76.2)
74 ¹ / ₁₆ (188.2) – 86 (218.5)	15 (38.1)	36 (91.5)
86 ¹ / ₁₆ (218.6) – 98 (249.0)	15 (38.1)	42 (106.7)
98 ¹ / ₁₆ (249.1) – 108 (274.4)	34 (86.4)	49 (124.5)
108 ¹ / ₁₆ (274.5) – 120 (304.8)	46 (116.9)	50 (127.0)

NOTE: Handle height is to center of handle.

General Information

Cellular Shade Color Coordination Chart And Slide-Vue™ Rail Colors

Fabric/Color Name	¾" (1.0 cm) DC	¾" (1.0 cm) SC	¾" (1.9 cm) SC	Default Rail Color Name	Color Number	Default Continuous-loop Cord Color Name	Color Number	Default Slide-Vue Color Name	Color Number
Cambridge									
Black Swan		2605		Mysterious	152	White	00	White Satin	205
Eagles Nest		2604		Coffee	079	Coffee	079	Coffee	079
Feather White		2600		White Satin	205	White	00	White Satin	205
Heron Plume		2602		Twine	439	Tender Taupe	103	Cream	715
Sandhill Crane		2601		Lamplight	904	Vanilla	100	Cream	715
Urban Bird		2603		Twine	439	Tender Taupe	103	Cream	715
Cocoon									
Arboretum	3830	0430		Cypress	334	Vanilla	100	Cream	715
Cafe	3815	0415		Beige	011	Tender Taupe	103	Cream	715
Castaway	3823	0423		Praline	108	Tender Taupe	103	Coffee	079
Cloud	3800	0400		White Satin	205	White	00	White Satin	205
Desert Dust	3839	0439		Lamplight	904	Vanilla	100	Cream	715
Dill	3846	0446		Cypress	334	Vanilla	100	Cream	715
Fresh Brew	3847	0447		Coffee	079	Coffee	079	Coffee	079
Hazy Skies	3848	0448		Smokey Gray	026	Smokey Gray	026	Cream	715
High Point	3821	0401		Cream	715	White	00	Cream	715
Inlet	3829	0429		Robin's Egg	075	Smokey Gray	026	Cream	715
Iron Gate	3851	0451		Tender Taupe	103	Tender Taupe	103	Cream	715
Lemon Tree	3814	0414		Vanilla	100	Vanilla	100	Cream	715
Livingston	3822	0402		White Satin	205	White	00	White Satin	205
Mist	3812	0412		Creamy Pearl	356	White	00	Cream	715
Molten Silver	3828	0428		Classic Gray	114	Smokey Gray	026	White Satin	205
Monument	3831	0431		Canyon Gray	053	Smokey Gray	026	Cream	715
Moonbeam	3827	0427		Creamy Pearl	356	Vanilla	100	Cream	715
Orchard Ridge	3824	0404		Creamy Pearl	356	Vanilla	100	Cream	715
Salted Caramel	3819	0419		Camel	086	Vanilla	100	Coffee	079
Savannah	3820	0420		Sand	701	Vanilla	100	Cream	715
Scarlet	3806	0406		Clover	049	Tender Taupe	103	Coffee	079
Stormy Sky	3850	0450		Mysterious	152	White	00	White Satin	205
Twine	3854	0454		Twine	439	Vanilla	100	Cream	715
Elegant Neutrals									
Alabaster Frost	3704	4204	0804	Cream	715	Vanilla	100	Cream	715
Cloud White	3710	4210	0810	Cream	715	White	00	Cream	715
Light Waves	2434	4234	0834	White Satin	205	White	00	White Satin	205
Sparkle	2401	4201	0801	White Satin	205	White	00	White Satin	205
Starlight	2402	4202	0802	White Satin	205	White	00	White Satin	205
Facets									
Antique	2457			Sand	701	Vanilla	100	Cream	715
Arboretum	2458			Cypress	334	Vanilla	100	Cream	715
Avocado	2443			Cypress	334	Vanilla	100	Cream	715
Café	2462		2562	Beige	011	Tender Taupe	103	Cream	715
Castaway	2449			Praline	108	Tender Taupe	103	Coffee	079
Chalet	2467			Robin's Egg	075	Smokey Gray	026	Cream	715
Deep Blue	2489			Midnight Blue	057	Smokey Gray	026	Cream	715
Deep Walnut	2491			Tender Taupe	103	Tender Taupe	103	Coffee	079
Dill	2476			Cypress	334	Vanilla	100	Cream	715
Fresh Brew	2423		2523	Coffee	079	Coffee	079	Coffee	079
Hazy Skies	2427		2527	Smokey Gray	026	Smokey Gray	026	Cream	715
Iron Gate	2441		2541	Olive	066	Tender Taupe	103	Cream	715
Lamplight	2409		2509	Lamplight	904	Vanilla	100	Cream	715
Lemon Tree	2452			Vanilla	100	Vanilla	100	Cream	715
Marseille	2444			Creamy Pearl	356	White	00	Cream	715
Midnight	2433			Black Satin	233	White	00	Cream	715
Midnight Tulip	2459			Mysterious	152	White	00	White Satin	205
Molten Silver	2446			Classic Gray	114	Smokey Gray	026	White Satin	205
Monument	2455		2555	Canyon Gray	053	Smokey Gray	026	Cream	715
Moonbeam	2403		2503	Creamy Pearl	356	Vanilla	100	Cream	715
Orchard Ridge	2463			Creamy Pearl	356	Vanilla	100	Cream	715
Pale Blue	2419			White Satin	205	White	00	White Satin	205
Salted Caramel	2461		2561	Camel	086	Vanilla	100	Coffee	079
Scarlet	2406			Clover	049	Tender Taupe	103	Coffee	079
Stormy Sky	2438		2538	Mysterious	152	White	00	White Satin	205
Sunshine	2464			Vanilla	100	Vanilla	100	Cream	715
Tropical Bay	2466			White Satin	205	White	00	White Satin	205
Twine	2454		2554	Twine	439	Vanilla	100	Cream	715
Wading Pool	2448			Classic Gray	114	Smokey Gray	026	White Satin	205

NOTE: DC = Double Cell SC = Single Cell

General Information

Cellular Shade Color Coordination Chart And Slide-Vue™ Rail Colors (Cont.)

Fabric/Color Name	¾" (1.0 cm) DC	¾" (1.0 cm) SC	¾" (1.9 cm) SC	Default Rail Color Name	Color Number	Default Continuous-loop Cord Color Name	Color Number	Default Slide-Vue Color Name	Color Number
Garden Retreat									
Antler	0978	0078	0778	Sand	701	Vanilla	100	Cream	715
Apollo	0902	0002	0702	Cream	715	White	00	Cream	715
Cayenne	0972	0072	0772	Clover	049	Tender Taupe	103	Coffee	079
Chalk	0903	0003	0703	Cream	715	White	00	Cream	715
Cilantro	0973	0073	0773	Mossy Gray	825	Tender Taupe	103	Coffee	079
Cirrus	0977	0077	0777	White Satin	205	White	00	White Satin	205
Classic Navy	0947	0047	0747	Midnight Blue	057	Smokey Gray	026	Cream	715
Colonial Slate	0993	0093	0793	Charcoal	591	Smokey Gray	026	White Satin	205
Country Barn	0988	0088	0788	Clover	049	Tender Taupe	103	Coffee	079
Creamy	0904	0004	0704	Vanilla	100	Vanilla	100	Cream	715
Espresso	0971	0071	0771	Coffee	079	Coffee	079	Coffee	079
Grasscloth	0931	0031	0731	Camel	086	Vanilla	100	Coffee	079
Hunting Lodge	0976	0076	0776	Coffee	079	Coffee	079	Coffee	079
Inlet	0979	0079	0779	Robin's Egg	075	Smokey Gray	026	Cream	715
Khaki	0944	0044	0744	Twine	439	Tender Taupe	103	Cream	715
Poppyseed	0989	0089	0789	Black Satin	233	White	00	Cream	715
Potter's Clay	0992	0092	0792	Tender Taupe	103	Tender Taupe	103	Cream	715
Quicksand	0915	0015	0715	Sand	701	Vanilla	100	Cream	715
Riverbed	0990	0090	0790	Olive	066	Tender Taupe	103	Cream	715
Sandcastle	0913	0013	0713	Sand	701	Vanilla	100	Cream	715
Sandy Point	0991	0091	0791	Canyon Gray	053	Smokey Gray	026	Cream	715
Solitaire	0901	0001	0701	White Satin	205	White	00	White Satin	205
Spring Rain	0916	0016	0716	White Satin	205	White	00	White Satin	205
Threshold Taupe	0910	0010	0710	Twine	439	Tender Taupe	103	Cream	715
Tide Pool	0994	0094	0794	Iris	080	Smokey Gray	026	White Satin	205
Timeless Taupe	0984	0084	0784	Twine	439	Tender Taupe	103	Cream	715
Valley Vine	0987	0087	0787	Cream	715	White	00	Cream	715
White Rose	0970	0070	0770	Cream	715	White	00	Cream	715
Night Sky									
Angelhair		0481		Cream	715	White	00	Cream	715
Buttercup		0482		Cream	715	Vanilla	100	Cream	715
Jack Frost		0480		White Satin	205	White	00	White Satin	205
Papyrus		0483		Cream	715	Vanilla	100	Cream	715
Sala									
Antique Map	2052			Twine	439	Tender Taupe	103	Cream	715
Cathedral	2051			Canyon Gray	053	Smokey Gray	026	Cream	715
Colonial Pewter	2055			Classic Gray	114	Smokey Gray	026	White Satin	205
Statue	2053			Canyon Gray	053	Smokey Gray	026	Cream	715
Weathered Stone	2054			Tender Taupe	103	Tender Taupe	103	Cream	715
Scroll									
Adirondack			2316	Tender Taupe	103	Tender Taupe	103	Cream	715
Atlantic Frost			2319	White Satin	205	White	00	White Satin	205
Canyon Clay			2321	Clover	049	Tender Taupe	103	Coffee	079
Coconut Cream			2313	Cream	715	White	00	Cream	715
Lime Chiffon			2320	Cream	715	White	00	Cream	715
Manila			2314	Creamy Pearl	356	White	00	Cream	715
Simply White			2301	White Satin	205	White	00	White Satin	205
Spring Fawn			2315	Twine	439	Tender Taupe	103	Cream	715
Trevi			2318	Canyon Gray	053	Smokey Gray	026	Cream	715
Walnut Shell			2317	Coffee	079	Coffee	079	Coffee	079
Scroll FR									
Adirondack			2916	Tender Taupe	103	Tender Taupe	103	Cream	715
Manila			2914	Creamy Pearl	356	White	00	Cream	715
Simply White			2901	White Satin	205	White	00	White Satin	205
Spring Fawn			2915	Twine	439	Tender Taupe	103	Cream	715
Trevi			2918	Canyon Gray	053	Smokey Gray	026	Cream	715
Simply Sheer									
Almond		0152	2152	Sand	701	Vanilla	100	Cream	715
Mocha		0154	2154	Beige	011	Tender Taupe	103	Coffee	079
Whisper		0150	2150	White Satin	205	White	00	White Satin	205
Solitude									
Adirondack		1714	2714	Tender Taupe	103	Tender Taupe	103	Cream	715
Atlantic Frost		1717	2717	White Satin	205	White	00	White Satin	205
Canyon Clay		1719	2719	Clover	049	Tender Taupe	103	Coffee	079
Coconut Cream		1711	2711	Cream	715	White	00	Cream	715
Lime Chiffon		1718	2718	Cream	715	White	00	Cream	715
Manila		1712	2712	Creamy Pearl	356	White	00	Cream	715
Simply White		1701	2701	White Satin	205	White	00	White Satin	205
Spring Fawn		1713	2713	Twine	439	Tender Taupe	103	Cream	715
Trevi		1716	2716	Canyon Gray	053	Smokey Gray	026	Cream	715
Walnut Shell		1715	2715	Coffee	079	Coffee	079	Coffee	079

NOTE: DC = Double Cell SC = Single Cell

General Information

Cellular Shade Color Coordination Chart And Slide-Vue™ Rail Colors (Cont.)

Fabric/Color Name	3/8" (1.0 cm) DC	3/8" (1.0 cm) SC	3/4" (1.9 cm) SC	Default Rail Color Name	Color Number	Default Continuous-loop Cord Color Name	Color Number	Default Slide-Vue Color Name	Color Number
Translucence									
Angelhair	3417	5117	4617	Cream	715	White	00	Cream	715
Buttercup	3401	5101	4601	Cream	715	Vanilla	100	Cream	715
Jack Frost	3400	5100	4600	White Satin	205	White	00	White Satin	205
Lioness	3413	5113	4613	Sand	701	Vanilla	100	Cream	715
Mocha	3411	5111	4611	Beige	011	Tender Taupe	103	Coffee	079
Papyrus	3402	5102	4602	Cream	715	Vanilla	100	Cream	715
Risotto	3412	5112	4612	Creamy Pearl	356	Vanilla	100	Cream	715
Sculpture Garden	3410	5110	4610	Twine	439	Tender Taupe	103	Cream	715
Valletta									
Adirondack		0855	2855	Tender Taupe	103	Tender Taupe	103	Cream	715
Atlantic Frost		0858	2858	White Satin	205	White	00	White Satin	205
Canyon Clay		0860	2860	Clover	049	Tender Taupe	103	Coffee	079
Coconut Cream		0851	2851	Cream	715	White	00	Cream	715
Lime Chiffon		0859	2859	Cream	715	White	00	Cream	715
Manila		0852	2852	Creamy Pearl	356	White	00	Cream	715
Simply White		0850	2850	White Satin	205	White	00	White Satin	205
Spring Fawn		0854	2854	Twine	439	Tender Taupe	103	Cream	715
Trevi		0857	2857	Canyon Gray	053	Smokey Gray	026	Cream	715
Walnut Shell		0856	2856	Coffee	079	Coffee	079	Coffee	079

NOTE: DC = Double Cell SC = Single Cell

General Information

Standard Cord Control Product Detail

Cellular 3/8" (1.0 cm) Single Cell, 3/8" (1.0 cm) Double Cell and 3/4" (1.9 cm) Single Cell Shades

NOTE: 3/8" (1.0 cm) Double Cell shown.

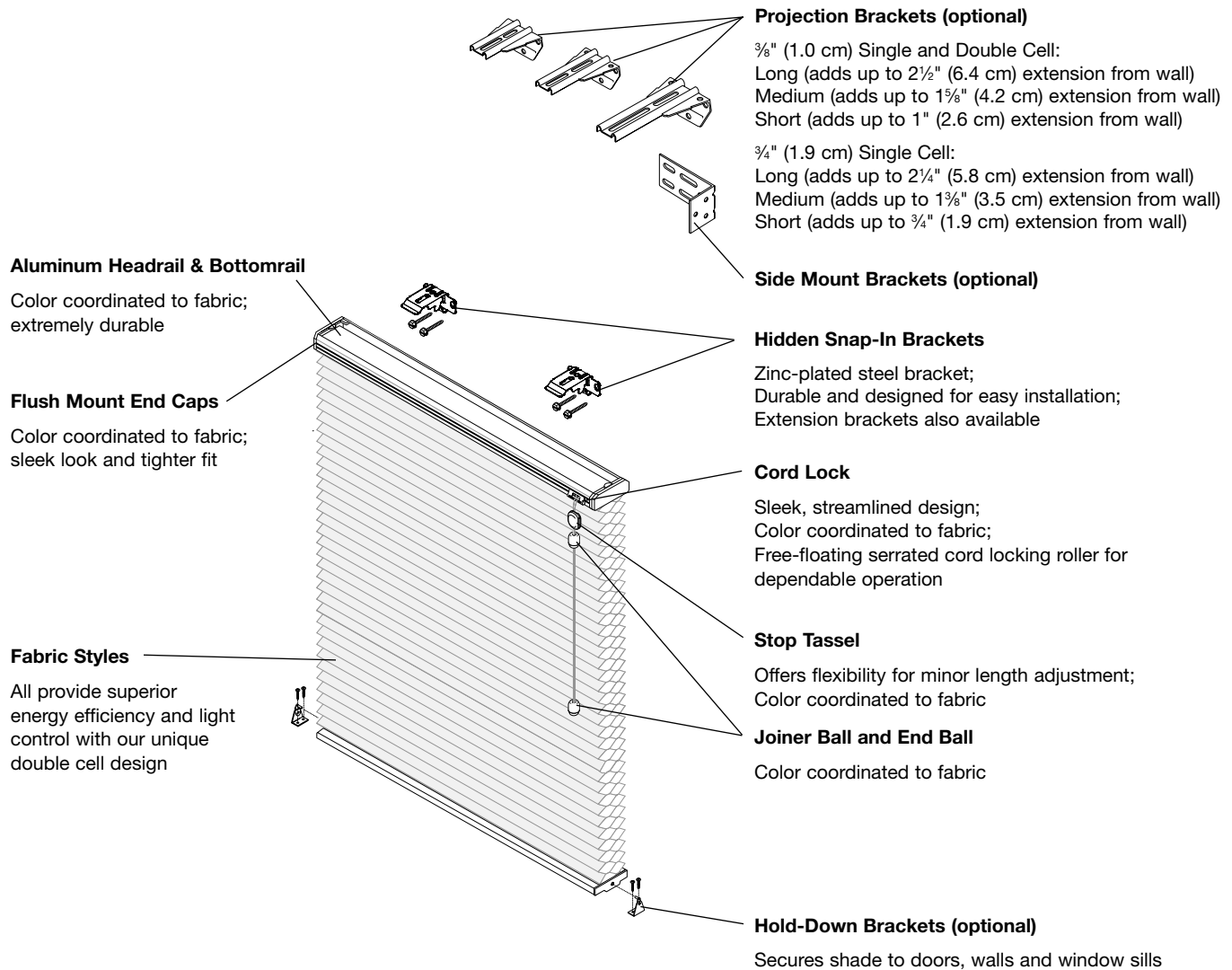

Cord Management Options

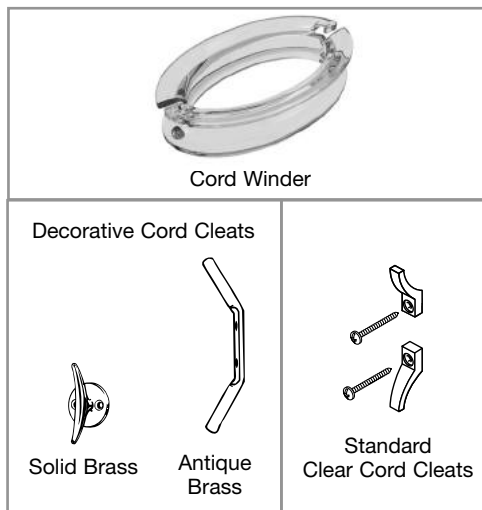

General Information

Cordless Lift Product Detail

NOTE: 3/8" (1.0 cm) Double Cell shown.

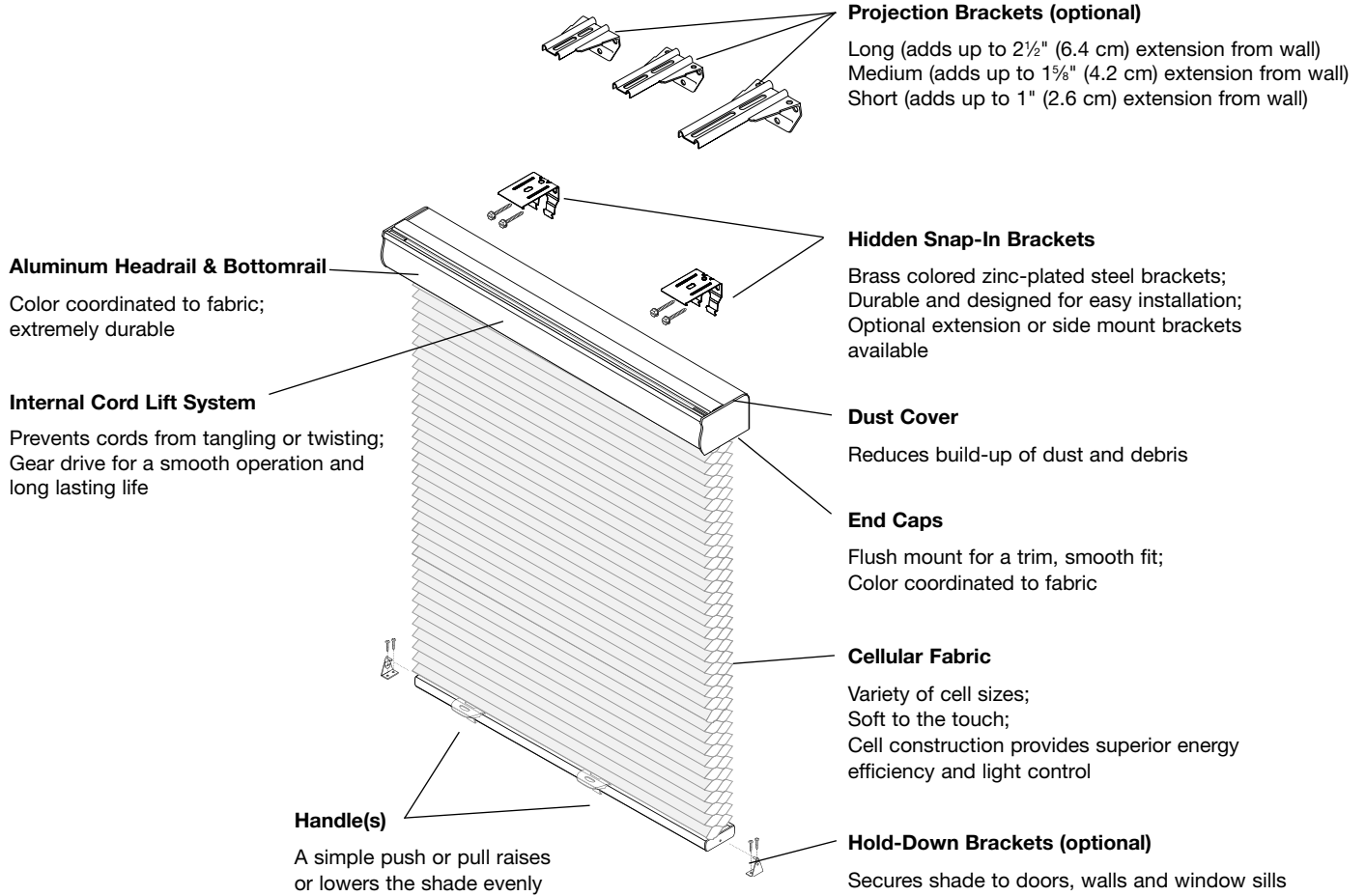

NOTE: All Cordless Lift shades need to be used on windows where consumers can comfortably raise and lower the shade with their hands and have easy access. Suggest adding a sky pole for hard-to-reach applications, up to 36" (91.5 cm) wide.

General Information

Continuous-loop Lift Product Detail

NOTE: 3/8" (1.0 cm) Single cell shown.

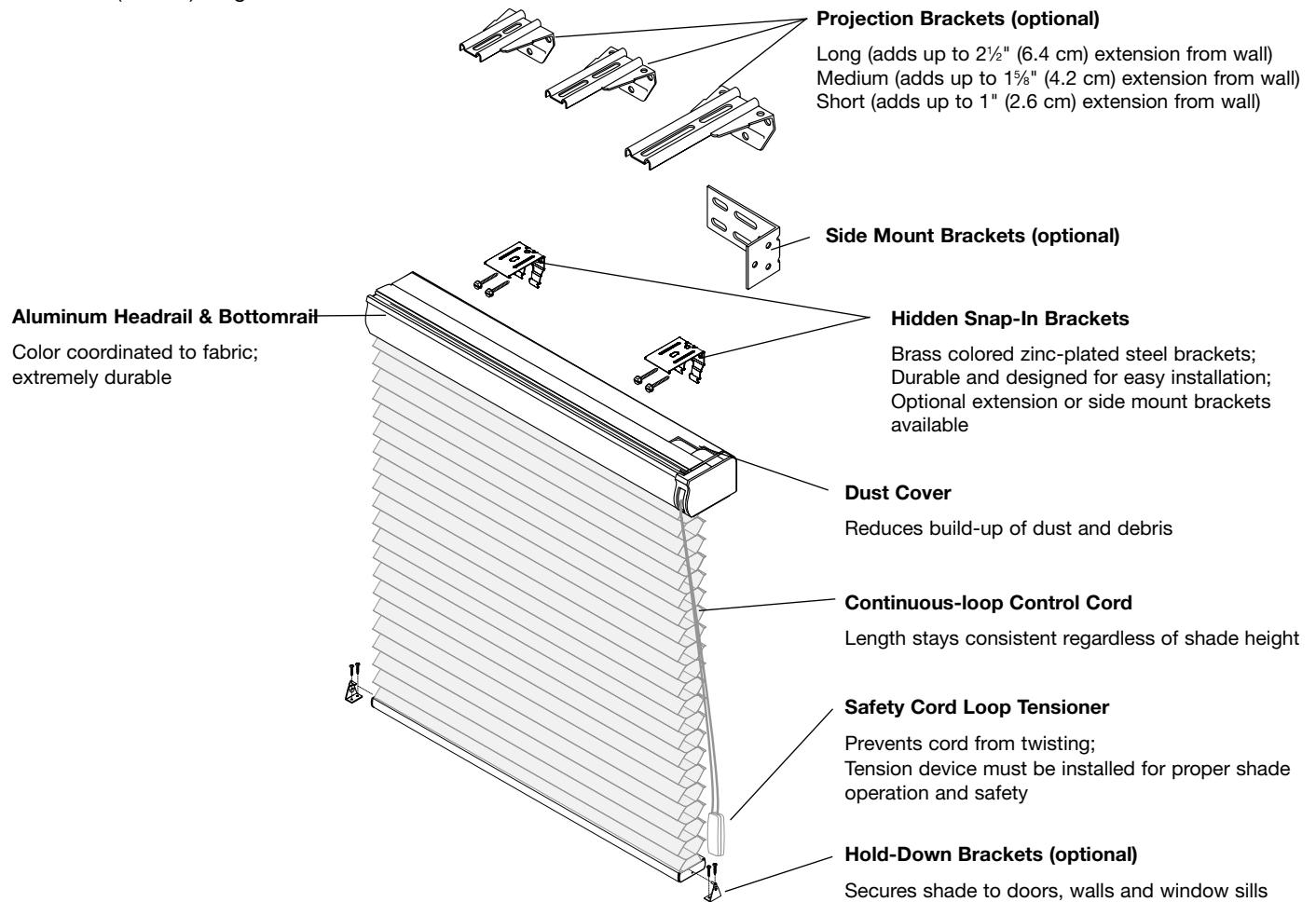

NOTE: Shades over 5000 sq. in. (3.22 sq. m) on all single cell except Cocoon and over 4000 sq. in. (2.58 sq. m) on all double cell and Cocoon single cell use a larger clutch ratio for easier lifting, but additional pulls are required to raise the shade.

General Information

Bottom Up/Top Down Standard Cord Control Product Detail

NOTE: 3/8" (1.0 cm) Double Cell shown.

Aluminum Headrail with Extension Lip

Color coordinated to fabric;
Eliminates any light gap where center rail and headrail meet

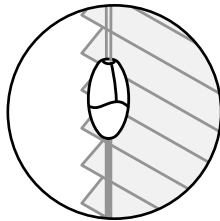

Cord Release Device

Color coordinated to fabric

Hidden Snap-In Brackets

Zinc-plated steel bracket;
Durable and designed for easy installation

Cord Locks

Sleek, streamlined design;
Color coordinated to fabric;
Free-floating serrated cord locking roller for dependable operation

Pull Cord

Allows for conventional shade operation

Joiner Ball and End Tassel

Color coordinated to fabric





Aluminum Intermediate Rail & Bottomrail

Color coordinated to fabric;
extremely durable

Hold-Down Brackets (optional)

Secures shade to doors, walls and window sills

Cord Management Options

 Cord Winder	
 Solid Brass	 Antique Brass
 Standard Clear Cord Cleats	

General Information

Bottom Up/Top Down Cordless Lift Product Detail

NOTE: 3/8" (1.0 cm) Single cell shown.

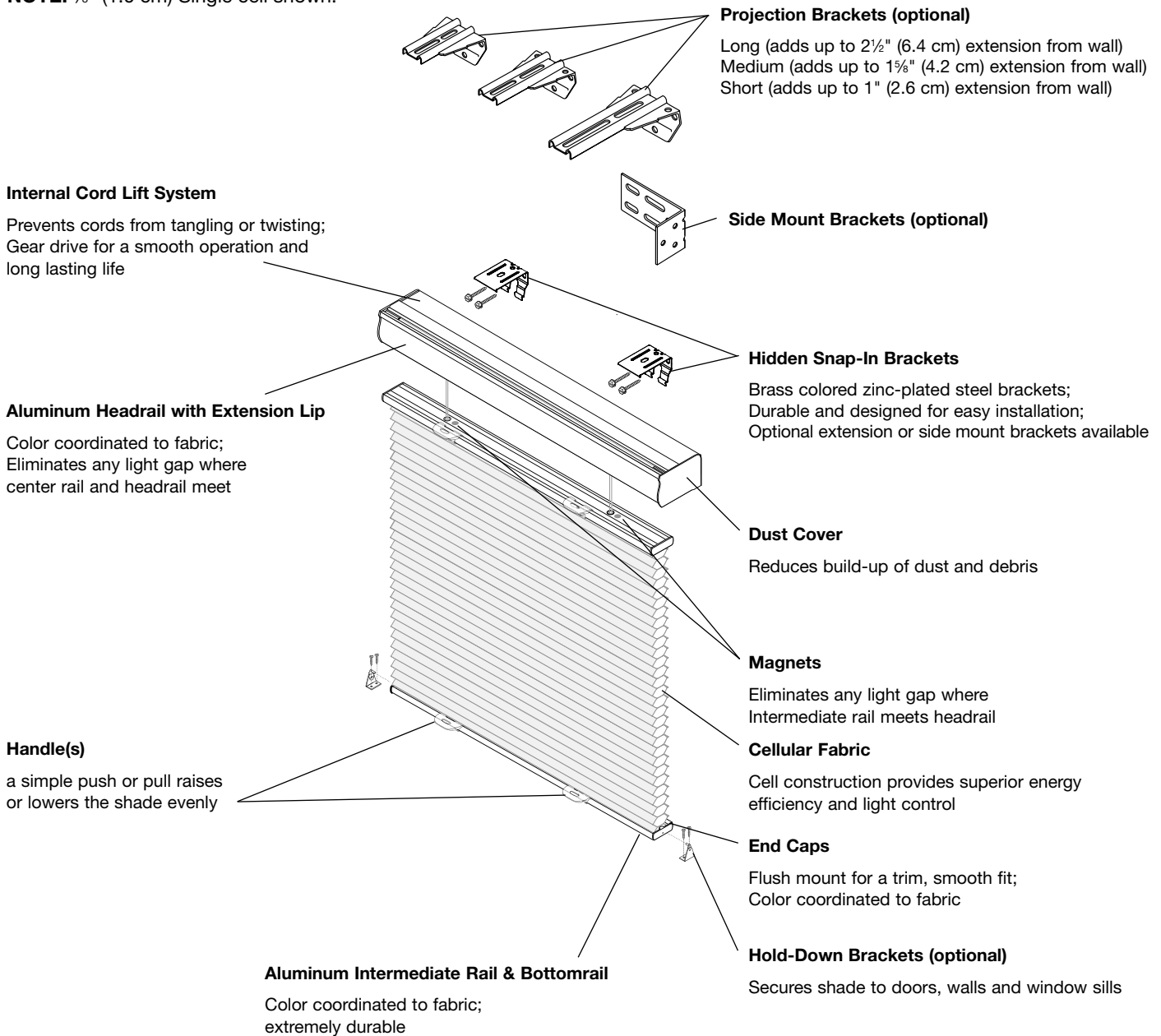

NOTE: All Cordless Lift shades need to be used on windows where consumers can comfortably raise and lower the shade with their hands and have easy access.

General Information

Standard Cord Control Product Detail: Perfect-Vue™

NOTE: 1" (2.6 cm) Pleated with 3/8" (1.0 cm) Double Cell shown.

Aluminum Headrail

Headrail coordinates with pleated fabric;
Extremely durable

Cord Release Device

Color coordinated to cord, cords
coordinate with pleated fabric;

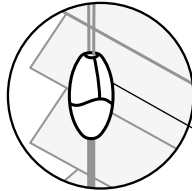

Fabric Styles

Soft to the touch;
All cellular fabrics provide superior energy
efficiency and light control, especially with
our unique double cell design;
Pleated fabric offers the ultimate in style,
privacy and light control options

Intermediate Rail and Bottomrail

Intermediate rail coordinates with pleated fabric;
Bottomrail coordinates with cellular fabric;
Extremely durable

Projection Brackets (optional)

Long (adds up to 2 1/2" (6.4 cm) extension from wall)
Medium (adds up to 1 5/8" (4.2 cm) extension from wall)
Short (adds up to 1" (2.6 cm) extension from wall)

Hidden Snap-In Brackets

Zinc-plated steel;
Durable brackets designed for easy installation;
Projection brackets also available

Flush Mount End Caps

Color coordinated to rails;
Sleeker look and tighter fit

Cord Locks

Sleek, streamlined design;
Color coordinated to headrail;
Free-floating serrated cord locking roller for
dependable operation;
Standard control is right control – operates
bottomrail, while left control operates
intermediate rail

Joiner Ball and End Tassel

Color coordinated to cord, cords coordinate
with pleated fabric

Hold-Down Brackets (optional)

Secures shade to doors, walls and window sills

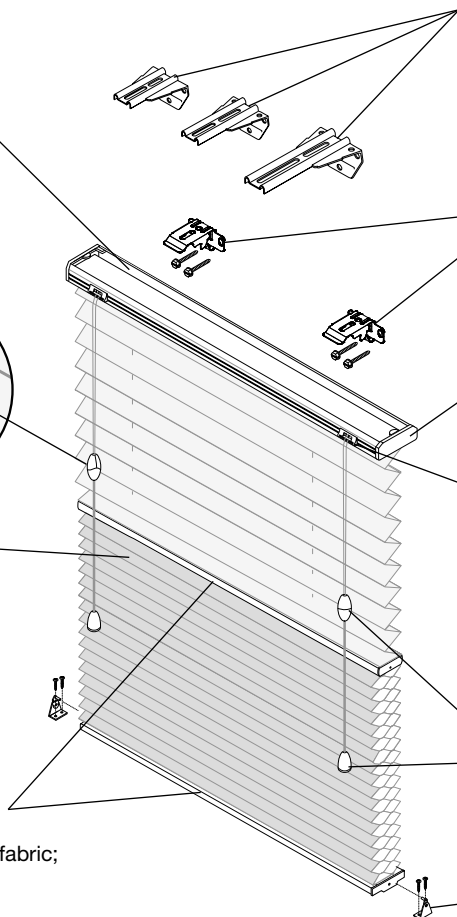

Cord Management Options

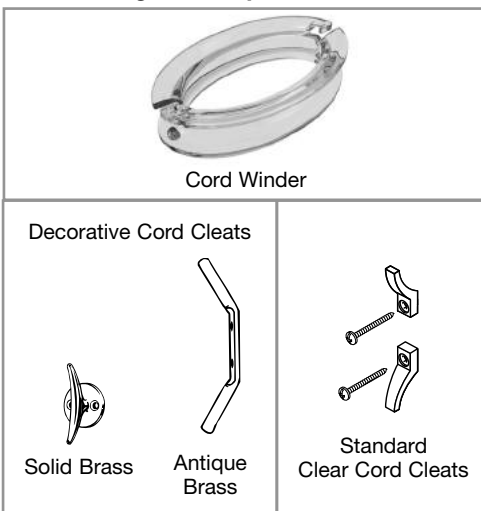

VIEW FROM BACK OF SHADE

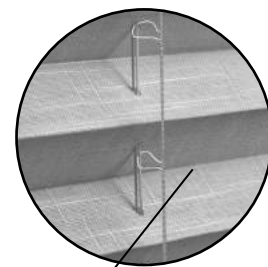

EvenPleat® (optional)

EvenPleat offers a unique ladder system
to guarantee pleats will not flatten.

General Information

Cordless Lift Product Detail: Perfect-Vue™

NOTE: 1" (2.6 cm) Pleated with 3/8" (1.0 cm) Double Cell shown.

Aluminum Headrail

Headrail coordinates with pleated fabric;
Extremely durable

Internal Cord Lift System

Prevents cords from tangling or twisting;
Gear drive for a smooth operation and
long lasting life;
Cords coordinate to pleated fabric

Fabric Styles

Soft to the touch;
All cellular fabrics provide superior energy
efficiency and light control, especially with
our unique double cell design;
Pleated fabric offers the ultimate in style,
privacy and light control options

Intermediate Rail and Bottomrail

Intermediate rail coordinates with pleated fabric;
Bottomrail coordinates with cellular fabric;
Extremely durable

Handles

A simple push or pull raises
or lowers the shade evenly

Projection Brackets (optional)

Long (adds up to 2 1/2" (6.4 cm) extension from wall)
Medium (adds up to 1 5/8" (4.2 cm) extension from wall)
Short (adds up to 1" (2.6 cm) extension from wall)

Hidden Snap-In Brackets

Brass colored zinc-plated steel;
Durable brackets designed for easy installation;
Projection brackets also available (optional)

Dust Cover

Reduces build-up of dust and debris

End Caps

Flush mount for a trim, smooth fit;
Color coordinated to rails

Hold-Down Brackets (optional)

Secures shade to doors, walls and window sills

VIEW FROM BACK OF SHADE

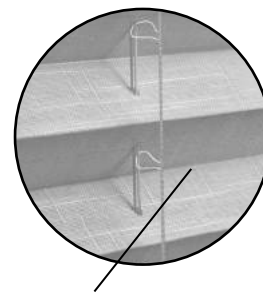

EvenPleat® (optional)

EvenPleat offers a unique ladder system
to guarantee pleats will not flatten.

NOTE: All Cordless Lift shades need to be used on windows where consumers can comfortably raise and lower the shade with their hands and have easy access.

General Information

Arch Over Standard Cord Control Product Detail

NOTE: 3/8" (1.0 cm) Double Cell shown.

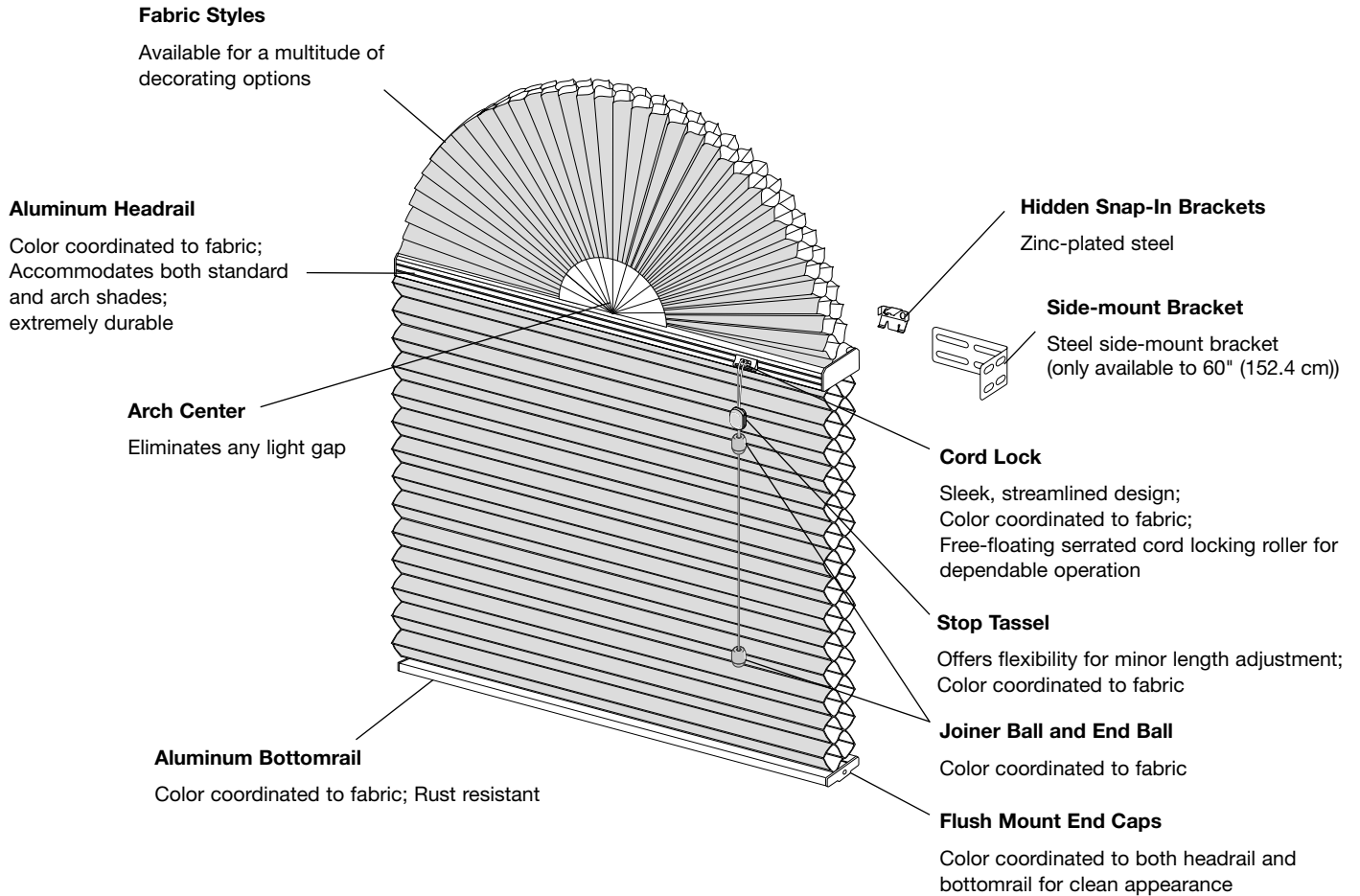

Cord Management Options

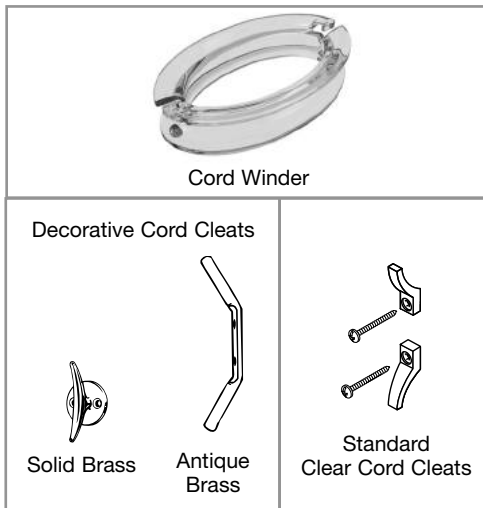

General Information

Slide-View™ Product Detail

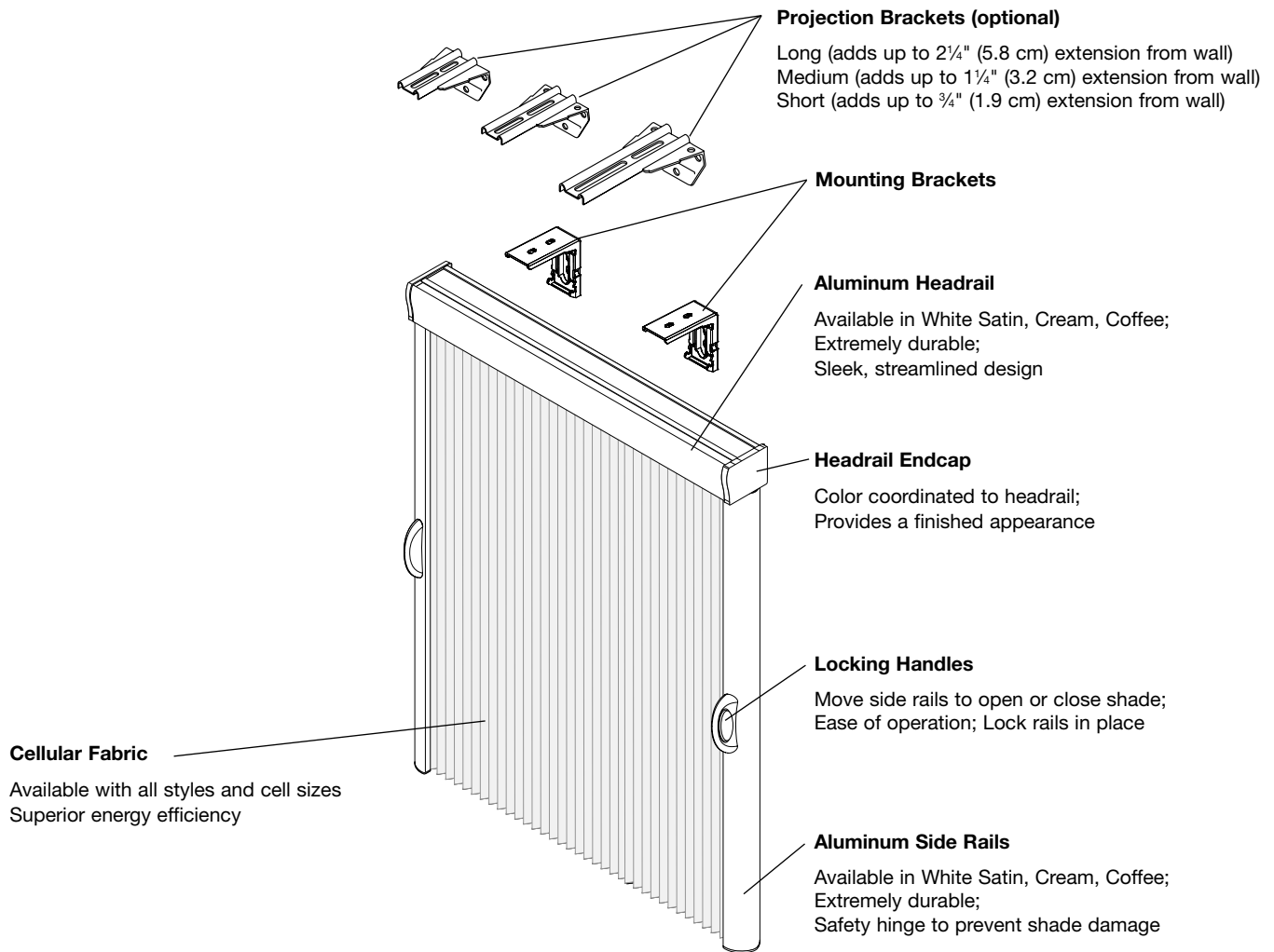

APPLICATION:

- Ideal for patio doors, wide windows and room dividers
- Movable side rails with locking handles for ease of operation
- Allows stack of material to be positioned on the right, center or left
- Easy to install
- Slim, compact stack

Not Shown:
 Safety Release Fabric Stem
 Releases from carriage to prevent fabric from tearing
 Cornice or Valance (optional)
 Refer to the Cornice and Valance tab of the price list for pricing and product specifications

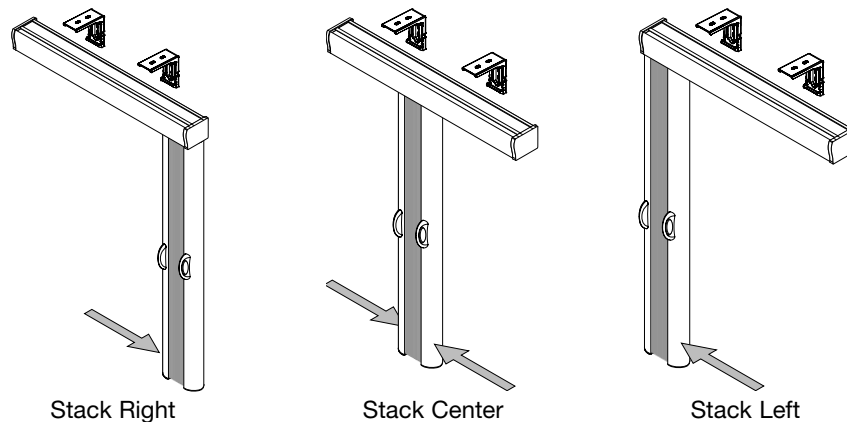

Price Charts

Price Group A: Translucence 3/8" (1.0 cm) Single Cell

Cellular Shade

HEIGHT UP TO in. (cm) ↓	WIDTH UP TO in. (cm) →																
	24 (61.0)	30 (76.2)	36 (91.5)	42 (106.7)	48 (122.0)	54 (137.2)	60 (152.4)	66 (167.7)	72 (182.9)	84 (213.4)	96 (243.9)	108 (274.4)	120 (304.8)	132 (335.3)	144 (365.8)	174 (442.0)	192 (487.7)
36 (91.5)	\$122	133	153	170	190	207	222	240	256	296	333	411	445	482	516	587	664
42 (106.7)	128	147	165	188	207	224	247	266	285	323	358	453	491	533	569	648	717
48 (122.0)	138	156	181	203	222	247	267	288	311	355	401	490	533	578	623	711	807
54 (137.2)	148	166	192	215	240	266	287	313	336	385	438	529	576	624	672	769	876
60 (152.4)	154	181	207	230	256	284	311	336	362	418	473	568	622	672	726	834	951
66 (167.7)	164	190	218	247	276	301	333	361	391	447	509	608	665	721	777	895	1019
72 (182.9)	170	201	230	261	296	323	354	385	416	478	546	648	708	768	832	958	1090
78 (198.2)	181	211	244	277	311	345	377	410	441	508	581	690	753	817	889	1016	1160
84 (213.4)	188	218	255	288	330	364	398	435	469	538	616	731	800	869	937	1073	1233
90 (228.6)	194	230	268	301	348	385	423	459	495	568	652	768	844	914	990	1134	1306
96 (243.9)	205	244	280	318	364	403	442	482	524	601	687	812	890	966	1043	1197	1374
108 (274.4)	221	267	310	353	399	445	489	533	578	664	762	894	980	1067	1154	1324	1524
120 (304.8)	240	287	336	385	438	487	533	581	631	727	834	970	1069	1161	1260	1455	1667
132 (335.3)	256	311	362	416	470	528	579	632	683	789	903	1054	1159	1263	1368	1578	1807
144 (365.8)	277	334	391	445	508	568	623	679	738	853	975	1134	1246	1360	1474	1704	1954

Add Surcharge To Shade Price

CONTINUOUS- LOOP SURCHARGE	\$80	82	89	91	94	98	101	108	113	120	125	135	147	154	160		
CORDLESS SURCHARGE	102	106	108	112	122	124	126	132	137	175	182	192	200	225	251		

Continuous width fabric up to 96" (243.9 cm).
Cordless Lift maximum height is 86" (218.5 cm).

Cordless Lift continuous shades available in outlined area above.

Multiple shades on one headrail—
Shade widths exceeding fabric width:
No charge

Multiple shades on one headrail—
Shades less than or equal to fabric width:
Add surcharge:
\$70 (two on one headrail);
\$114 (three on one headrail)

Colors

TRANSLUCENCE 3/8" (1.0 CM) SINGLE CELL†

Angelhair**	5117	Mocha	5111
Buttercup**	5101	Papyrus**	5102
Jack Frost**	5100	Risotto	5112
Lioness	5113	Sculpture Garden	5110

†Same color front and back.

**Color coordinates with Night Sky (Blackout).

Price Charts

Price Group B: Translucence 3/8" (1.0 cm) Double Cell And 3/4" (1.9 cm) Single Cell

Cellular Shade

HEIGHT UP TO in. (cm) ↓	WIDTH UP TO in. (cm) →																
	24 (61.0)	30 (76.2)	36 (91.5)	42 (106.7)	48 (122.0)	54 (137.2)	60 (152.4)	66 (167.7)	72 (182.9)	84 (213.4)	96 (243.9)	108 (274.4)	120 (304.8)	132 (335.3)	144 (365.8)	174 (442.0)	192 (487.7)
36 (91.5)	\$125	140	157	177	196	211	230	247	265	303	341	422	458	496	529	605	681
42 (106.7)	133	150	172	191	211	233	252	273	293	333	368	462	506	546	584	666	739
48 (122.0)	143	161	184	207	230	252	274	296	320	366	415	505	547	593	640	730	829
54 (137.2)	151	173	199	221	247	273	295	321	346	396	450	543	592	642	692	791	902
60 (152.4)	159	184	211	238	265	291	320	346	373	428	487	582	639	692	745	857	975
66 (167.7)	171	196	224	252	281	311	341	371	400	459	524	623	683	743	799	919	1049
72 (182.9)	177	206	238	271	303	333	365	393	426	491	561	666	726	789	854	984	1122
78 (198.2)	184	216	250	282	320	354	386	421	454	523	598	710	773	843	912	1045	1195
84 (213.4)	191	224	263	296	339	376	412	448	482	553	633	752	821	893	961	1102	1267
90 (228.6)	201	238	275	311	356	393	433	470	508	582	671	789	867	940	1017	1166	1342
96 (243.9)	210	250	288	329	376	416	456	496	537	617	707	832	913	991	1072	1230	1412
108 (274.4)	227	274	318	364	413	458	502	547	593	681	783	918	1008	1095	1188	1363	1567
120 (304.8)	247	295	346	393	450	499	547	598	648	747	857	997	1098	1196	1296	1494	1713
132 (335.3)	265	320	373	426	485	542	596	649	702	811	928	1085	1194	1298	1407	1619	1858
144 (365.8)	282	342	400	458	523	582	640	697	759	876	1003	1166	1281	1399	1515	1750	2006
Add Surcharge To Shade Price																	
CONTINUOUS- LOOP SURCHARGE	\$80	82	89	91	94	98	101	108	113	120	125	135	147	154	160		
CORDLESS SURCHARGE	102	106	108	112	122	124	126	132	137	175	182	192	200	225	251		

Continuous width fabric up to 96" (243.9 cm).
Cordless Lift maximum height is 86" (218.5 cm).

Cordless Lift continuous shades available in outlined area above.

Multiple shades on one headrail—
Shade widths exceeding fabric width:
No charge

Multiple shades on one headrail—
Shades less than or equal to fabric width:
Add surcharge:
\$70 (two on one headrail);
\$114 (three on one headrail)

Colors

TRANSLUCENCE 3/8" (1.0 CM) DOUBLE CELL†		TRANSLUCENCE 3/4" (1.9 CM) SINGLE CELL†	
Angelhair**	3417	Angelhair**	4617
Buttercup**	3401	Buttercup**	4601
Jack Frost**	3400	Jack Frost**	4600
Lioness	3413	Lioness	4613
Mocha	3411	Mocha	4611
Papyrus**	3402	Papyrus**	4602
Risotto	3412	Risotto	4612
Sculpture Garden	3410	Sculpture Garden	4610

†Same color front and back.

**Color coordinates with Night Sky (Blackout).

Price Charts

Price Group C: Elegant Neutrals 3/8" (1.0 cm) Single Cell And 3/4" (1.9 cm) Single Cell; Garden Retreat 3/8" (1.0 cm) Single And Double Cell, 3/4" (1.9 cm) Single Cell

Cellular Shade

HEIGHT UP TO in. (cm) ↓	WIDTH UP TO in. (cm) →																
	24 (61.0)	30 (76.2)	36 (91.5)	42 (106.7)	48 (122.0)	54 (137.2)	60 (152.4)	66 (167.7)	72 (182.9)	84 (213.4)	96 (243.9)	108 (274.4)	120 (304.8)	132 (335.3)	144 (365.8)	174 (442.0)	192 (487.7)
36 (91.5)	\$165	183	208	234	258	278	302	325	349	398	449	557	604	652	699	796	900
42 (106.7)	177	199	225	253	278	305	334	356	385	440	485	611	666	718	770	880	971
48 (122.0)	185	214	242	273	302	334	359	390	420	482	546	664	721	782	843	963	1091
54 (137.2)	200	227	261	293	325	356	389	424	454	522	593	717	781	849	912	1044	1186
60 (152.4)	211	241	278	314	349	385	420	454	492	565	642	769	840	912	981	1129	1284
66 (167.7)	220	258	295	334	374	412	450	487	527	605	690	823	902	976	1056	1211	1380
72 (182.9)	234	272	314	354	398	439	479	521	564	649	737	879	958	1041	1126	1294	1476
78 (198.2)	243	285	329	375	422	467	510	555	598	690	789	938	1017	1108	1197	1379	1574
84 (213.4)	253	298	345	390	445	495	542	588	633	727	833	988	1080	1178	1269	1455	1669
90 (228.6)	265	314	361	413	471	521	570	620	671	769	884	1041	1141	1240	1341	1537	1766
96 (243.9)	276	328	380	435	493	548	600	653	707	812	933	1099	1200	1305	1413	1624	1863
108 (274.4)	288	345	403	458	522	580	637	694	752	863	994	1162	1278	1389	1503	1727	1983
120 (304.8)	314	375	439	500	568	632	694	756	821	947	1084	1267	1391	1516	1639	1892	2170
132 (335.3)	336	404	473	541	616	687	754	822	891	1024	1178	1372	1509	1641	1780	2051	2355
144 (365.8)	359	437	509	580	662	737	812	885	961	1108	1272	1476	1626	1770	1921	2218	2542
Add Surcharge To Shade Price																	
CONTINUOUS-LOOP SURCHARGE	\$80	82	89	91	94	98	101	108	113	120	125	135	147	154	160		
CORDLESS SURCHARGE	102	106	108	112	122	124	126	132	137	175	182	192	200	225	251		

Continuous width fabric up to 120" (304.8 cm).
Cordless Lift maximum height is 86" (218.5 cm).

Cordless Lift continuous shades available in outlined area above.

Multiple shades on one headrail—
Shade widths exceeding fabric width:
No charge

Multiple shades on one headrail—
Shades less than or equal to fabric width:
Add surcharge:
\$70 (two on one headrail);
\$114 (three on one headrail)

Colors

ELEGANT NEUTRALS 3/8" (1.0 CM) SINGLE CELL†	GARDEN RETREAT 3/8" (1.0 CM) DOUBLE CELL	GARDEN RETREAT 3/8" (1.0 CM) SINGLE CELL	GARDEN RETREAT 3/4" (1.9 CM) SINGLE CELL
Alabaster Frost4204	Antler0978	Antler0078	Antler0778
Cloud White4210	Apollo†0902	Apollo†0002	Apollo†0702
Light Waves4234	Cayenne0972	Cayenne0072	Cayenne0772
Sparkle4201	Chalk†0903	Chalk†0003	Chalk†0703
Starlight4202	Cilantro0973	Cilantro0073	Cilantro0773
	Cirrus0977	Cirrus0077	Cirrus0777
ELEGANT NEUTRALS	Classic Navy0947	Classic Navy0047	Classic Navy0747
3/4" (1.9 CM) SINGLE CELL†	Colonial Slate0993	Colonial Slate0093	Colonial Slate0793
Alabaster Frost0804	Country Barn0988	Country Barn0088	Country Barn0788
Cloud White0810	Creamy0904	Creamy0004	Creamy0704
Light Waves0834	Espresso0971	Espresso0071	Espresso0771
Sparkle0801	Grasscloth0931	Grasscloth0031	Grasscloth0731
Starlight0802	Hunting Lodge0976	Hunting Lodge0076	Hunting Lodge0776
	Inlet0979	Inlet0079	Inlet0779
	Khaki0944	Khaki0044	Khaki0744
	Poppyseed0989	Poppyseed0089	Poppyseed0789
	Potter's Clay0992	Potter's Clay0092	Potter's Clay0792
	Quicksand0915	Quicksand0015	Quicksand0715
	Riverbed0990	Riverbed0090	Riverbed0790
	Sandcastle0913	Sandcastle0013	Sandcastle0713
	Sandy Point0991	Sandy Point0091	Sandy Point0791
	Solitaire†0901	Solitaire†0001	Solitaire†0701
	Spring Rain0916	Spring Rain0016	Spring Rain0716
	Threshold Taupe0910	Threshold Taupe0010	Threshold Taupe0710
	Tide Pool0994	Tide Pool0094	Tide Pool0794
	Timeless Taupe0984	Timeless Taupe0084	Timeless Taupe0784
	Valley Vine0987	Valley Vine0087	Valley Vine0787
	White Rose0970	White Rose0070	White Rose0770

†Same color front and back.

Price Charts

Price Group D: Night Sky 3/8" (1.0 cm) Single Cell, Scroll 3/4" (1.9 cm) Single Cell

Cellular Shade

HEIGHT UP TO in. (cm) ↓	WIDTH UP TO in. (cm) →																
	24 (61.0)	30 (76.2)	36 (91.5)	42 (106.7)	48 (122.0)	54 (137.2)	60 (152.4)	66 (167.7)	72 (182.9)	84 (213.4)	96 (243.9)	108 (274.4)	120 (304.8)	132 (335.3)	144 (365.8)	174 (442.0)	192 (487.7)
36 (91.5)	\$171	192	217	244	269	291	316	341	365	415	470	583	634	679	732	832	938
42 (106.7)	184	207	237	266	291	319	350	375	404	459	505	637	696	749	807	921	1016
48 (122.0)	196	224	255	284	316	349	377	410	439	502	570	695	754	818	881	1007	1141
54 (137.2)	207	239	273	308	341	375	407	445	474	546	621	748	816	886	952	1093	1239
60 (152.4)	218	252	291	327	365	403	439	474	515	591	673	806	879	953	1028	1182	1342
66 (167.7)	231	269	310	350	391	430	472	512	553	634	721	860	943	1021	1102	1265	1443
72 (182.9)	244	283	327	374	415	459	501	542	587	676	773	919	999	1089	1177	1354	1544
78 (198.2)	256	298	345	391	444	488	531	579	626	721	823	979	1065	1158	1252	1442	1647
84 (213.4)	266	311	360	410	465	517	565	615	664	762	871	1034	1131	1231	1328	1520	1745
90 (228.6)	276	327	378	431	492	542	599	647	703	804	924	1089	1195	1295	1400	1606	1848
96 (243.9)	287	345	396	456	516	573	628	680	737	849	977	1145	1256	1365	1477	1697	1948
108 (274.4)	302	360	420	481	546	608	668	728	785	903	1036	1214	1334	1452	1571	1804	2075
120 (304.8)	327	393	458	523	594	663	728	790	856	989	1134	1321	1453	1586	1715	1977	2269
132 (335.3)	352	421	494	565	641	717	789	860	931	1073	1230	1435	1577	1718	1862	2144	2461
144 (365.8)	376	456	530	608	693	773	849	926	1005	1158	1329	1545	1699	1850	2009	2320	2656

Add Surcharge To Shade Price

CONTINUOUS-LOOP SURCHARGE	\$80	82	89	91	94	98	101	108	113	120	125	135	147	154	160		
CORDLESS SURCHARGE	102	106	108	112	122	124	126	132	137	175	182	192	200	225	251		

Night Sky continuous width fabric up to 96" (243.9 cm).
 Scroll continuous width fabric up to 144" (365.8 cm).
 Cordless Lift maximum height is 86" (218.5 cm).

Cordless Lift continuous shades available in outlined area above.

Multiple shades on one headrail—
 Shade widths exceeding fabric width:
No charge

Multiple shades on one headrail—
 Shades less than or equal to fabric width:
Add surcharge:
 \$70 (two on one headrail);
 \$114 (three on one headrail)

Colors

NIGHT SKY 3/8" (1.0 CM) SINGLE CELL†

Angelhair** 0481
 Buttercup** 0482
 Jack Frost** 0480
 Papyrus** 0483

SCROLL 3/4" (1.9 CM) SINGLE CELL

Adirondack* 2316
 Atlantic Frost* 2319
 Canyon Clay* 2321
 Coconut Cream* 2313
 Lime Chiffon* 2320
 Manila* 2314
 Simply White* 2301
 Spring Fawn* 2315
 Trevi* 2318
 Walnut Shell* 2317

†Same color front and back.

*Color coordinates with Solitude (Blackout) and Valletta (Light Filtering/Room Darkening).

**Color coordinates with Translucence (Light Filtering).

Price Charts

Price Group E: Elegant Neutrals, Facets, Sala 3/8" (1.0 cm) Double Cell; Facets, Scroll FR 3/4" (1.9 cm) Single Cell

Cellular Shade

HEIGHT UP TO in. (cm) ↓	WIDTH UP TO in. (cm) →																
	24 (61.0)	30 (76.2)	36 (91.5)	42 (106.7)	48 (122.0)	54 (137.2)	60 (152.4)	66 (167.7)	72 (182.9)	84 (213.4)	96 (243.9)	108 (274.4)	120 (304.8)	132 (335.3)	144 (365.8)	174 (442.0)	192 (487.7)
36 (91.5)	\$181	201	228	257	283	305	331	357	383	436	493	611	662	715	767	873	988
42 (106.7)	194	218	246	278	305	334	366	391	423	483	532	670	731	788	845	965	1066
48 (122.0)	203	235	266	299	331	366	394	428	461	529	599	729	791	858	924	1057	1197
54 (137.2)	219	249	286	321	357	391	427	466	498	573	651	786	857	931	1000	1146	1301
60 (152.4)	232	264	305	345	383	423	461	498	540	620	704	844	922	1000	1076	1238	1409
66 (167.7)	242	283	323	366	410	452	494	534	579	663	757	903	990	1071	1158	1329	1514
72 (182.9)	257	298	345	389	436	481	525	572	619	712	809	964	1051	1142	1235	1419	1619
78 (198.2)	267	313	360	411	463	512	559	609	657	757	866	1029	1115	1216	1313	1513	1727
84 (213.4)	278	327	379	428	488	544	594	645	695	798	914	1084	1185	1293	1392	1597	1831
90 (228.6)	290	345	396	453	516	572	625	680	736	844	970	1142	1252	1361	1471	1686	1938
96 (243.9)	303	359	417	477	541	601	659	716	775	890	1024	1206	1316	1432	1550	1782	2044
108 (274.4)	316	379	442	503	573	636	698	762	825	947	1090	1275	1402	1524	1649	1895	2175
120 (304.8)	345	411	481	548	623	694	762	829	901	1038	1189	1390	1526	1663	1798	2076	2381
132 (335.3)	368	443	519	593	676	754	827	902	977	1123	1293	1505	1655	1800	1953	2250	2583
144 (365.8)	394	479	558	636	727	809	890	971	1054	1216	1396	1619	1784	1941	2107	2433	2789
Add Surcharge To Shade Price																	
CONTINUOUS-LOOP SURCHARGE	\$80	82	89	91	94	98	101	108	113	120	125	135	147	154	160		
CORDLESS SURCHARGE	102	106	108	112	122	124	126	132	137	175	182	192	200	225	251		

Facets, Sala continuous width fabric up to 90" (228.6 cm).
 Garden Retreat continuous width fabric up to 120" (304.8 cm).
 Scroll FR continuous width fabric up to 144" (365.8 cm).
 Cordless Lift maximum height is 86" (218.5 cm).

Cordless Lift continuous shades available in outlined area above.

Multiple shades on one headrail—
 Shade widths exceeding fabric width:
No charge

Multiple shades on one headrail—
 Shades less than or equal to fabric width:
Add surcharge:
 \$70 (two on one headrail);
 \$114 (three on one headrail)

Colors

ELEGANT NEUTRALS 3/8" (1.0 CM) DOUBLE CELL†	FACETS 3/8" (1.0 CM) DOUBLE CELL	FACETS 3/8" (1.0 CM) DOUBLE CELL (CONT.)	SALA 3/8" (1.0 CM) DOUBLE CELL
Alabaster Frost3704	Antique2457	Pale Blue2419	Antique Map2052
Cloud White3710	Arboretum**2458	Salted Caramel**2461	Cathedral2051
Light Waves2434	Avocado2443	Scarlet**2406	Colonial Pewter2055
Sparkle2401	Café**2462	Stormy Sky**2438	Statue2053
Starlight2402	Castaway**2449	Sunshine2464	Weathered Stone2054
	Chalet2467	Tropical Bay2466	
	Deep Blue2489	Twine**2454	
	Deep Walnut2491	Wading Pool2448	
	Dill**2476		
	Fresh Brew**2423		
	Hazy Skies**2427		
	Iron Gate**2441		
	Lamplight2409		
	Lemon Tree2452		
	Marseille2444		
	Midnight2433		
	Midnight Tulip2459		
	Molten Silver**2446		
	Monument**2455		
	Moonbeam**2403		
	Orchard Ridge**2463		
		FACETS 3/4" (1.9 CM) SINGLE CELL	
		Café**2562	Adirondack*2916
		Fresh Brew**2523	Manila*2914
		Hazy Skies**2527	Simply White*2901
		Iron Gate**2541	Spring Fawn*2915
		Lamplight**2509	Trevi*2918
		Monument**2555	
		Moonbeam**2503	
		Salted Caramel**2561	
		Stormy Sky**2538	
		Twine**2554	
			SCROLL FR 3/4" (1.9 CM) SINGLE CELL

†Same color front and back.

Deep fabric colors darken a room; light colors filter and diffuse bright sunlight.

*Color coordinates with Solitude (Blackout) and Valletta (Light Filtering/Room Darkening).

**Color coordinates with Cocoon (Blackout).

Price Charts

Price Group F: Cocoon 3/8" (1.0 cm) Single Cell And Double Cell

Cellular Shade

HEIGHT UP TO in. (cm) ↓	WIDTH UP TO in. (cm) →																
	24 (61.0)	30 (76.2)	36 (91.5)	42 (106.7)	48 (122.0)	54 (137.2)	60 (152.4)	66 (167.7)	72 (182.9)	84 (213.4)	96 (243.9)	108 (274.4)	120 (304.8)	132 (335.3)	144 (365.8)	174 (442.0)	192 (487.7)
36 (91.5)	\$211	237	268	301	330	360	388	420	450	512	661	718	776	839	900	1023	1323
42 (106.7)	227	253	291	326	360	393	427	462	496	566	718	785	857	925	993	1131	1439
48 (122.0)	241	274	312	352	388	427	464	505	541	619	776	854	928	1008	1082	1237	1551
54 (137.2)	257	293	335	378	420	460	503	546	587	671	839	920	1002	1092	1174	1342	1679
60 (152.4)	270	310	358	402	448	494	541	587	633	726	897	990	1081	1174	1264	1454	1792
66 (167.7)	287	330	380	427	480	529	580	627	678	778	959	1057	1161	1257	1356	1557	1921
72 (182.9)	301	348	402	456	512	566	618	670	725	832	1022	1130	1233	1339	1450	1665	2045
78 (198.2)	313	366	422	480	542	600	655	714	772	887	1083	1203	1311	1423	1542	1773	2166
84 (213.4)	326	384	445	505	571	635	697	755	816	936	1145	1272	1391	1513	1631	1871	2289
90 (228.6)	341	402	466	531	605	670	733	798	863	989	1209	1339	1468	1593	1715	1978	2417
96 (243.9)	356	421	489	558	634	707	772	839	909	1044	1268	1411	1545	1679	1818	2087	2536

Add Surcharge To Shade Price

CONTINUOUS- LOOP SURCHARGE	\$80	82	89	91	94	98	101	108	113	120	125	135	147	154	160		
CORDLESS SURCHARGE	102	106	108	112	122	124	126	132	137	175	182	192	200	225	251		

Continuous width fabric up to 86" (218.5 cm).
Cordless Lift maximum height is 86" (218.5 cm) for
Single Cell and 64" (162.6 cm) for Double Cell.

Single Cell Cordless Lift continuous shades available in outlined area above.

Double Cell Cordless Lift continuous shades available in dashed area above.

Multiple shades on one headrail—
Shade widths exceeding fabric width:
No charge

Multiple shades on one headrail—
Shades less than or equal to fabric width:
Add surcharge:
\$70 (two on one headrail);
\$114 (three on one headrail)

Colors

COCOON 3/8" (1.0 CM) DOUBLE CELL

Arboretum*	3830	Livingston	3822
Café*	3815	Mist	3812
Castaway*	3823	Molten Silver*	3828
Cloud	3800	Monument*	3831
Desert Dust	3839	Moonbeam*	3827
Dill*	3846	Orchard Ridge*	3824
Fresh Brew*	3847	Salted Caramel*	3819
Hazy Skies*	3848	Savannah	3820
High Point	3821	Scarlet*	3806
Inlet	3829	Stormy Sky*	3850
Iron Gate*	3851	Twine*	3854
Lemon Tree	3814		

COCOON 3/8" (1.0 CM) SINGLE CELL

Arboretum*	0430	Livingston	0402
Café*	0415	Mist	0412
Castaway*	0423	Molten Silver*	0428
Cloud	0400	Monument*	0431
Desert Dust	0439	Moonbeam*	0427
Dill*	0446	Orchard Ridge*	0424
Fresh Brew*	0447	Salted Caramel*	0419
Hazy Skies*	0448	Savannah	0420
High Point	0401	Scarlet*	0406
Inlet	0429	Stormy Sky*	0450
Iron Gate*	0451	Twine*	0454
Lemon Tree	0414		

*Color coordinates with Facets (Light Filtering/Room Darkening).

Price Charts

Price Group G: Valletta 3/8" (1.0 cm) Single Cell And 3/4" (1.9 cm) Single Cell

Cellular Shade

HEIGHT UP TO in. (cm) ↓	WIDTH UP TO in. (cm) →																
	24 (61.0)	30 (76.2)	36 (91.5)	42 (106.7)	48 (122.0)	54 (137.2)	60 (152.4)	66 (167.7)	72 (182.9)	84 (213.4)	96 (243.9)	108 (274.4)	120 (304.8)	132 (335.3)	144 (365.8)	174 (442.0)	192 (487.7)
36 (91.5)	\$222	249	281	316	347	378	407	441	473	538	694	754	815	881	945	1074	1389
42 (106.7)	238	266	306	342	378	413	448	485	521	594	754	824	900	971	1043	1188	1511
48 (122.0)	253	288	328	370	407	448	487	530	568	650	815	897	974	1058	1136	1299	1629
54 (137.2)	270	308	352	397	441	483	528	573	616	705	881	966	1052	1147	1233	1409	1763
60 (152.4)	284	326	376	422	470	519	568	616	665	762	942	1040	1135	1233	1327	1527	1882
66 (167.7)	301	347	399	448	504	555	609	658	712	817	1007	1110	1219	1320	1424	1635	2017
72 (182.9)	316	365	422	479	538	594	649	704	761	874	1073	1187	1295	1406	1523	1748	2147
78 (198.2)	329	384	443	504	569	630	688	750	811	931	1137	1263	1377	1494	1619	1862	2274
84 (213.4)	342	403	467	530	600	667	732	793	857	983	1202	1336	1461	1589	1713	1965	2403
90 (228.6)	358	422	489	558	635	704	770	838	906	1038	1269	1406	1541	1673	1801	2077	2538
96 (243.9)	374	442	513	586	666	742	811	881	954	1096	1331	1482	1622	1763	1909	2191	2663
108 (274.4)	390	462	537	613	697	782	852	926	1002	1155	1392	1557	1703	1852	2017	2307	2787
120 (304.8)	406	482	559	642	729	821	893	970	1049	1213	1453	1632	1784	1940	2125	2421	2911
132 (335.3)	422	501	583	670	760	861	932	1014	1096	1271	1515	1708	1866	2031	2232	2536	3036
144 (365.8)	439	521	606	697	792	901	973	1058	1143	1328	1576	1783	1947	2120	2340	2651	3159
Add Surcharge To Shade Price																	
CONTINUOUS- LOOP SURCHARGE	\$80	82	89	91	94	98	101	108	113	120	125	135	147	154	160		
CORDLESS SURCHARGE	102	106	108	112	122	124	126	132	137	175	182	192	200	225	251		

Continuous width fabric up to 144" (365.8 cm).
Cordless Lift maximum height is 86" (218.5 cm).

Cordless Lift continuous shades available in outlined area above.

Multiple shades on one headrail—
Shade widths exceeding fabric width:
No charge

Multiple shades on one headrail—
Shades less than or equal to fabric width:
Add surcharge:
\$70 (two on one headrail);
\$114 (three on one headrail)

Colors

VALLETTA 3/8" (1.0 CM) SINGLE CELL

Adirondack*	0855
Atlantic Frost*	0858
Canyon Clay*	0860
Coconut Cream*	0851
Lime Chiffon*	0859
Manila*	0852
Simply White*	0850
Spring Fawn*	0854
Trevi*	0857
Walnut Shell*	0856

VALLETTA 3/4" (1.9 CM) SINGLE CELL

Adirondack*	2855
Atlantic Frost*	2858
Canyon Clay*	2860
Coconut Cream*	2851
Lime Chiffon*	2859
Manila*	2852
Simply White*	2850
Spring Fawn*	2854
Trevi*	2857
Walnut Shell*	2856

*Color coordinates with Scroll (Light Filtering) and Solitude (Blackout).

Price Charts

Price Group H: Cambridge 3/8" (1.0 cm) Single Cell, Simply Sheer 3/8" (1.0 cm) Single Cell, Simply Sheer 3/4" (1.9 cm) Single Cell, Solitude 3/8" (1.0 cm) Single Cell And 3/4" (1.9 cm) Single Cell

Cellular Shade

HEIGHT UP TO in. (cm) ↓	WIDTH UP TO in. (cm) →																
	24 (61.0)	30 (76.2)	36 (91.5)	42 (106.7)	48 (122.0)	54 (137.2)	60 (152.4)	66 (167.7)	72 (182.9)	84 (213.4)	96 (243.9)	108 (274.4)	120 (304.8)	132 (335.3)	144 (365.8)	174 (442.0)	192 (487.7)
36 (91.5)	\$232	261	295	331	363	396	427	462	495	563	727	790	854	923	990	1125	1455
42 (106.7)	250	278	320	359	396	432	470	508	546	623	790	864	943	1018	1092	1244	1583
48 (122.0)	265	301	343	387	427	470	510	556	595	681	854	939	1021	1109	1190	1361	1706
54 (137.2)	283	322	369	416	462	506	553	601	646	738	923	1012	1102	1201	1291	1476	1847
60 (152.4)	297	341	394	442	493	543	595	646	696	799	987	1089	1189	1291	1390	1599	1971
66 (167.7)	316	363	418	470	528	582	638	690	746	856	1055	1163	1277	1383	1492	1713	2113
72 (182.9)	331	383	442	502	563	623	680	737	798	915	1124	1243	1356	1473	1595	1832	2250
78 (198.2)	344	403	464	528	596	660	721	785	849	976	1191	1323	1442	1565	1696	1950	2383
84 (213.4)	359	422	490	556	628	699	767	831	898	1030	1260	1399	1530	1664	1794	2058	2518
90 (228.6)	375	442	513	584	666	737	806	878	949	1088	1330	1473	1615	1752	1887	2176	2659
96 (243.9)	392	463	538	614	697	778	849	923	1000	1148	1395	1552	1700	1847	2000	2296	2790
108 (274.4)	408	484	562	642	730	820	892	970	1049	1210	1459	1631	1784	1940	2113	2417	2919
120 (304.8)	426	505	585	672	763	860	935	1016	1099	1271	1522	1709	1869	2033	2226	2537	3049
132 (335.3)	442	525	611	702	796	902	977	1063	1148	1331	1587	1790	1955	2127	2339	2657	3180
144 (365.8)	460	546	635	730	829	944	1020	1109	1198	1392	1651	1868	2039	2221	2452	2778	3310

Add Surcharge To Shade Price

CONTINUOUS- LOOP SURCHARGE	\$80	82	89	91	94	98	101	108	113	120	125	135	147	154	160		
CORDLESS SURCHARGE	102	106	108	112	122	124	126	132	137	175	182	192	200	225	251		

Continuous width fabric up to 144" (365.8 cm).
Cordless Lift maximum height is 86" (218.5 cm).

Cordless Lift continuous shades available in outlined area above.

Multiple shades on one headrail—
Shade widths exceeding fabric width:
No charge

Multiple shades on one headrail—
Shades less than or equal to fabric width:
Add surcharge:
\$70 (two on one headrail);
\$114 (three on one headrail)

Colors

CAMBRIDGE 3/8" (1.0 CM) SINGLE CELL†	SIMPLY SHEER 3/8" (1.0 CM) SINGLE CELL†	SOLITUDE 3/8" (1.0 CM) SINGLE CELL	SOLITUDE 3/4" (1.9 CM) SINGLE CELL
Black Swan2605	Almond.....0152	Adirondack*1714	Adirondack*2714
Eagles Nest2604	Mocha0154	Atlantic Frost*.....1717	Atlantic Frost*.....2717
Feather White2600	Whisper0150	Canyon Clay*.....1719	Canyon Clay*.....2719
Heron Plume.....2602		Coconut Cream*.....1711	Coconut Cream*.....2711
Sandhill Crane2601	SIMPLY SHEER 3/4" (1.9 CM) SINGLE CELL†	Lime Chiffon*1718	Lime Chiffon*2718
Urban Bird2603	Almond.....2152	Manila*1712	Manila*2712
	Mocha2154	Simply White*.....1701	Simply White*.....2701
	Whisper2150	Spring Fawn*1713	Spring Fawn*2713
		Trevi*.....1716	Trevi*.....2716
		Walnut Shell*1715	Walnut Shell*2715

*Color coordinates with Scroll and Valletta (Light Filtering/Room Darkening).

†Internal cords will be visible.

Price Charts

Price Group I: Translucence 3/8" (1.0 cm) Single Cell

Graber Slide-View™

HEIGHT UP TO in. (cm) ↓	WIDTH UP TO in. (cm) →																		
	24 (61.0)	30 (76.2)	36 (91.5)	42 (106.7)	48 (122.0)	54 (137.2)	60 (152.4)	66 (167.7)	72 (182.9)	78 (198.2)	84 (213.4)	96 (243.9)	108 (274.4)	120 (304.8)	132 (335.3)	144 (365.8)	156 (396.3)	174 (442.0)	192 (487.7)
36 (91.5)	\$469	516	563	604	643	678	717	761	796	853	872	942	1067	1116	1172	1218	1298	1306	1390
42 (106.7)	478	526	576	620	659	696	741	783	824	881	900	969	1110	1162	1224	1273	1358	1364	1445
48 (122.0)	487	538	587	634	673	717	762	807	849	912	931	1014	1148	1204	1267	1325	1422	1429	1535
54 (137.2)	496	548	603	648	693	736	783	833	875	942	962	1049	1188	1247	1316	1374	1478	1486	1602
60 (152.4)	502	558	615	663	708	756	806	856	900	974	994	1085	1224	1295	1363	1427	1544	1551	1677
66 (167.7)	515	571	625	679	728	773	827	880	928	1004	1023	1121	1264	1339	1413	1479	1605	1613	1745
72 (182.9)	519	582	641	694	746	796	849	904	956	1035	1054	1157	1305	1380	1458	1533	1667	1675	1814
78 (198.2)	527	590	652	709	764	816	874	928	980	1066	1085	1191	1347	1425	1509	1590	1727	1735	1889
84 (213.4)	537	597	664	721	781	836	894	956	1007	1094	1114	1229	1387	1472	1560	1639	1782	1791	1959
90 (228.6)	545	611	677	735	800	857	920	977	1033	1125	1145	1264	1425	1516	1605	1694	1850	1853	2032
96 (243.9)	553	623	690	753	816	875	939	1002	1063	1157	1176	1298	1468	1561	1657	1744	1906	1916	2101
98 (249.0)	563	635	705	773	844	895	960	1027	1092	1190	1208	1331	1511	1607	1708	1797	1964	1979	2170

Colors

TRANSLUCENCE 3/8" (1.0 CM) SINGLE CELL†

Angelhair**	5117	Mocha	5111
Buttercup**	5101	Papyrus**	5102
Jack Frost**	5100	Sculpture Garden	5110
Lioness	5113	Risotto	5112

†Same color front and back.

**Color coordinates with Night Sky (Blackout).

Price Group J: Translucence 3/8" (1.0 cm) Double Cell And 3/4" (1.9 cm) Single Cell

Graber Slide-View™

HEIGHT UP TO in. (cm) ↓	WIDTH UP TO in. (cm) →																		
	24 (61.0)	30 (76.2)	36 (91.5)	42 (106.7)	48 (122.0)	54 (137.2)	60 (152.4)	66 (167.7)	72 (182.9)	78 (198.2)	84 (213.4)	96 (243.9)	108 (274.4)	120 (304.8)	132 (335.3)	144 (365.8)	156 (396.3)	174 (442.0)	192 (487.7)
36 (91.5)	\$490	537	585	630	670	705	752	793	831	890	912	987	1120	1171	1231	1279	1364	1374	1461
42 (106.7)	500	549	600	647	686	728	775	821	860	922	944	1015	1161	1221	1284	1335	1429	1436	1521
48 (122.0)	507	562	612	662	705	750	797	845	889	956	977	1064	1203	1266	1333	1393	1498	1506	1618
54 (137.2)	516	571	630	678	724	769	820	870	917	988	1008	1101	1245	1312	1386	1447	1561	1567	1693
60 (152.4)	525	584	640	693	742	789	846	896	946	1023	1043	1142	1287	1361	1436	1502	1629	1635	1771
66 (167.7)	537	597	658	710	760	811	868	923	973	1056	1076	1178	1329	1407	1488	1561	1695	1701	1848
72 (182.9)	542	605	670	728	783	832	890	948	1001	1090	1109	1217	1375	1454	1539	1618	1761	1769	1922
78 (198.2)	552	619	683	742	799	856	916	977	1031	1122	1143	1255	1419	1501	1594	1678	1826	1833	2001
84 (213.4)	561	627	697	756	821	879	940	1002	1061	1153	1173	1293	1462	1552	1647	1731	1886	1893	2077
90 (228.6)	569	639	710	771	838	899	964	1027	1086	1186	1204	1333	1502	1599	1697	1790	1953	1959	2152
96 (243.9)	579	652	723	789	859	920	988	1054	1116	1220	1239	1371	1548	1648	1752	1848	2021	2027	2229
98 (249.0)	597	679	756	825	896	964	1036	1109	1176	1287	1309	1448	1637	1749	1860	1970	2160	2169	2391

Colors

TRANSLUCENCE 3/8" (1.0 CM) DOUBLE CELL†

TRANSLUCENCE 3/4" (1.9 CM) SINGLE CELL†

Angelhair**	3417	Angelhair**	4617
Buttercup**	3401	Buttercup**	4601
Jack Frost**	3400	Jack Frost**	4600
Lioness	3413	Mocha	4611
Mocha	3411	Papyrus**	4602
Papyrus**	3402	Sculpture Garden	4610
Sculpture Garden	3410	Risotto	4612
Risotto	3412	Lioness	4613

†Same color front and back.

**Color coordinates with Night Sky (Blackout).

Price Charts

Price Group K: Elegant Neutrals 3/8" (1.0 cm) Single Cell And 3/4" (1.9 cm) Single Cell; Garden Retreat 3/8" (1.0 cm) Single and Double Cell, 3/4" (1.9 cm) Single Cell

Grabber Slide-View™

HEIGHT UP TO in. (cm) ↓	WIDTH UP TO in. (cm) →																		
	24 (61.0)	30 (76.2)	36 (91.5)	42 (106.7)	48 (122.0)	54 (137.2)	60 (152.4)	66 (167.7)	72 (182.9)	78 (198.2)	84 (213.4)	96 (243.9)	108 (274.4)	120 (304.8)	132 (335.3)	144 (365.8)	156 (396.3)	174 (442.0)	192 (487.7)
36 (91.5)	\$504	553	605	654	695	735	784	829	873	940	957	1043	1194	1256	1324	1381	1486	1492	1606
42 (106.7)	514	568	622	673	718	763	814	861	909	981	1002	1078	1248	1318	1389	1453	1571	1576	1677
48 (122.0)	524	584	640	692	742	791	842	894	945	1023	1042	1138	1303	1374	1453	1524	1653	1661	1796
54 (137.2)	539	597	658	714	764	814	871	928	977	1064	1080	1187	1353	1432	1519	1593	1735	1742	1892
60 (152.4)	548	611	676	733	789	843	903	958	1014	1106	1126	1237	1407	1492	1582	1666	1819	1825	1990
66 (167.7)	559	626	691	753	812	869	933	994	1050	1146	1165	1284	1461	1554	1647	1738	1900	1909	2086
72 (182.9)	572	641	711	775	836	895	960	1024	1087	1190	1208	1333	1516	1612	1712	1807	1984	1990	2182
78 (198.2)	582	654	726	794	861	923	991	1060	1122	1231	1250	1381	1575	1671	1780	1880	2070	2076	2280
84 (213.4)	592	667	743	811	884	952	1023	1093	1158	1270	1288	1427	1627	1735	1850	1952	2144	2152	2374
90 (228.6)	604	682	760	833	911	977	1052	1125	1193	1311	1331	1478	1678	1795	1912	2022	2228	2234	2473
96 (243.9)	614	696	778	854	932	1006	1080	1158	1229	1353	1372	1525	1736	1854	1978	2094	2314	2321	2570
108 (274.4)	627	715	799	880	960	1038	1121	1198	1275	1406	1424	1585	1799	1929	2060	2185	2417	2425	2688
120 (304.8)	652	744	836	919	1006	1091	1176	1260	1343	1487	1507	1678	1902	2042	2188	2321	2582	2588	2876

Colors

ELEGANT NEUTRALS 3/8" (1.0 CM) SINGLE CELL†		GARDEN RETREAT 3/8" (1.0 CM) DOUBLE CELL		GARDEN RETREAT 3/8" (1.0 CM) SINGLE CELL		GARDEN RETREAT 3/4" (1.9 CM) SINGLE CELL	
Alabaster Frost4204	Antler0978	Antler0078	Antler0778
Cloud White4210	Apollo†0902	Apollo†0002	Apollo†0702
Light Waves4234	Cayenne0972	Cayenne0072	Cayenne0772
Sparkle4201	Chalk†0903	Chalk†0003	Chalk†0703
Starlight4202	Cilantro0973	Cilantro0073	Cilantro0773
		Cirrus0977	Cirrus0077	Cirrus0777
		Classic Navy0947	Classic Navy0047	Classic Navy0747
		Colonial Slate0993	Colonial Slate0093	Colonial Slate0793
		Country Barn0988	Country Barn0088	Country Barn0788
		Creamy0904	Creamy0004	Creamy0704
		Espresso0971	Espresso0071	Espresso0771
		Grasscloth0931	Grasscloth0031	Grasscloth0731
		Hunting Lodge0976	Hunting Lodge0076	Hunting Lodge0776
		Inlet0979	Inlet0079	Inlet0779
		Khaki0944	Khaki0044	Khaki0744
		Poppyseed0989	Poppyseed0089	Poppyseed0789
		Potter's Clay0992	Potter's Clay0092	Potter's Clay0792
		Quicksand0915	Quicksand0015	Quicksand0715
		Riverbed0990	Riverbed0090	Riverbed0790
		Sandcastle0913	Sandcastle0013	Sandcastle0713
		Sandy Point0991	Sandy Point0091	Sandy Point0791
		Solitaire†0901	Solitaire†0001	Solitaire†0701
		Spring Rain0916	Spring Rain0016	Spring Rain0716
		Threshold Taupe0910	Threshold Taupe0010	Threshold Taupe0710
		Tide Pool0994	Tide Pool0094	Tide Pool0794
		Timeless Taupe0984	Timeless Taupe0084	Timeless Taupe0784
		Valley Vine0987	Valley Vine0087	Valley Vine0787
		White Rose0970	White Rose0070	White Rose0770

†Same color front and back.

Price Charts

Price Group L: Night Sky 3/8" (1.0 cm) Single Cell, Scroll 3/4" (1.9 cm) Single Cell

Graber Slide-View™

HEIGHT UP TO in. (cm) ↓	WIDTH UP TO in. (cm) →																		
	24 (61.0)	30 (76.2)	36 (91.5)	42 (106.7)	48 (122.0)	54 (137.2)	60 (152.4)	66 (167.7)	72 (182.9)	78 (198.2)	84 (213.4)	96 (243.9)	108 (274.4)	120 (304.8)	132 (335.3)	144 (365.8)	156 (396.3)	174 (442.0)	192 (487.7)
36 (91.5)	\$509	559	614	666	710	750	801	849	892	965	982	1072	1235	1300	1367	1433	1546	1553	1675
42 (106.7)	523	578	634	689	731	779	834	885	932	1009	1029	1108	1292	1367	1440	1510	1638	1645	1754
48 (122.0)	533	595	653	708	759	810	865	921	971	1055	1073	1177	1353	1427	1512	1590	1731	1737	1887
54 (137.2)	548	609	672	731	785	838	895	957	1008	1100	1119	1232	1408	1492	1586	1663	1820	1827	1989
60 (152.4)	558	623	691	752	810	867	929	988	1048	1149	1165	1285	1467	1561	1654	1744	1914	1920	2099
66 (167.7)	572	642	712	775	837	896	966	1029	1091	1192	1211	1335	1525	1627	1727	1824	2003	2010	2204
72 (182.9)	586	657	730	802	864	927	994	1061	1128	1238	1256	1389	1586	1687	1798	1901	2095	2102	2310
78 (198.2)	598	671	748	820	892	958	1029	1099	1165	1285	1303	1443	1649	1753	1871	1980	2187	2194	2419
84 (213.4)	609	686	766	838	915	987	1063	1136	1207	1327	1347	1494	1707	1825	1950	2060	2272	2278	2521
90 (228.6)	618	703	785	862	945	1015	1096	1172	1247	1372	1389	1548	1765	1892	2015	2136	2361	2367	2630
96 (243.9)	632	721	803	887	970	1046	1129	1207	1285	1420	1439	1602	1825	1956	2088	2217	2456	2461	2737
108 (274.4)	647	739	829	914	1001	1084	1171	1254	1334	1477	1497	1666	1899	2039	2180	2316	2569	2575	2869
120 (304.8)	672	771	867	958	1051	1142	1233	1322	1410	1567	1586	1771	2011	2163	2319	2466	2751	2759	3072

Night Sky - Continuous fabric height up to 98" (249.0 cm).

Colors

NIGHT SKY 3/8" (1.0 CM) SINGLE CELL

Angelhair**	0481
Buttercup**	0482
Jack Frost**	0480
Papyrus**	0483

SCROLL 3/4" (1.9 CM) SINGLE CELL

Adirondack*	2316	Manila*	2314
Atlantic Frost*	2319	Simply White*	2301
Canyon Clay*	2321	Spring Fawn*	2315
Coconut Cream*	2313	Trevi*	2318
Lime Chiffon*	2320	Walnut Shell*	2317

†Same color front and back.

*Color coordinates with Solitude (Blackout) and Valletta (Light Filtering/Room Darkening).

**Color coordinates with Translucence (Light Filtering).

Price Charts

Price Group M: Elegant Neutrals, Facets, Sala $\frac{3}{8}$ " (1.0 cm) Double Cell; Facets, Scroll FR $\frac{3}{4}$ " (1.9 cm) Single Cell

Graber Slide-View™

HEIGHT UP TO in. (cm) ↓	WIDTH UP TO in. (cm) →																		
	24 (61.0)	30 (76.2)	36 (91.5)	42 (106.7)	48 (122.0)	54 (137.2)	60 (152.4)	66 (167.7)	72 (182.9)	78 (198.2)	84 (213.4)	96 (243.9)	108 (274.4)	120 (304.8)	132 (335.3)	144 (365.8)	156 (396.3)	174 (442.0)	192 (487.7)
36 (91.5)	\$553	607	663	718	763	807	860	910	958	1032	1050	1145	1310	1377	1452	1515	1631	1637	1762
42 (106.7)	564	623	683	738	788	837	893	945	998	1076	1099	1183	1370	1446	1524	1594	1723	1729	1840
48 (122.0)	575	641	702	759	814	868	923	981	1036	1122	1144	1249	1429	1507	1594	1672	1814	1823	1971
54 (137.2)	591	655	722	783	838	893	956	1018	1072	1167	1185	1302	1485	1571	1667	1748	1903	1911	2076
60 (152.4)	601	670	741	805	866	924	991	1051	1112	1214	1235	1357	1544	1637	1736	1827	1996	2002	2183
66 (167.7)	614	687	758	826	890	954	1024	1090	1151	1258	1278	1409	1602	1705	1807	1906	2085	2094	2288
72 (182.9)	627	703	780	850	918	982	1053	1123	1192	1305	1325	1462	1663	1768	1878	1982	2176	2183	2393
78 (198.2)	638	718	797	871	945	1012	1087	1163	1231	1350	1372	1515	1728	1833	1953	2062	2271	2278	2502
84 (213.4)	650	732	815	889	970	1044	1122	1199	1270	1393	1413	1565	1785	1903	2029	2141	2353	2361	2605
90 (228.6)	662	748	834	914	999	1072	1154	1234	1309	1438	1460	1622	1841	1970	2097	2218	2444	2451	2713
96 (243.9)	673	764	853	937	1023	1104	1185	1270	1348	1485	1505	1674	1904	2034	2170	2297	2539	2546	2819
108 (274.4)	688	784	877	965	1053	1139	1229	1314	1399	1542	1563	1739	1974	2116	2260	2397	2652	2660	2949
120 (304.8)	715	816	918	1008	1104	1197	1290	1382	1474	1632	1653	1841	2087	2241	2400	2546	2833	2840	3155

Facets, Sala - Continuous fabric height up to 92" (233.7 cm).

Colors

ELEGANT NEUTRALS $\frac{3}{8}$ " (1.0 CM) DOUBLE CELL†	FACETS $\frac{3}{8}$ " (1.0 CM) DOUBLE CELL	FACETS $\frac{3}{8}$ " (1.0 CM) DOUBLE CELL (CONT.)	SALA $\frac{3}{8}$ " (1.0 CM) DOUBLE CELL
Alabaster Frost3704	Antique2457	Pale Blue2419	Antique Map2052
Cloud White3710	Arboretum*2458	Salted Caramel*2461	Cathedral2051
Light Waves2434	Avocado2443	Scarlet*2406	Colonial Pewter2055
Sparkle2401	Café*2462	Stormy Sky*2438	Statue2053
Starlight2402	Castaway*2449	Sunshine2464	Weathered Stone2054
	Chalet2467	Tropical Bay2466	
	Deep Blue2489	Twine*2454	
	Deep Walnut2491	Wading Pool2448	
	Dill*2476		
	Fresh Brew*2423		
	Hazy Skies*2427		
	Iron Gate*2441		
	Lamplight2409		
	Lemon Tree2452		
	Marseille2444		
	Midnight2433		
	Midnight Tulip2459		
	Molten Silver*2446		
	Monument*2455		
	Moonbeam*2403		
	Orchard Ridge*2463		
		FACET $\frac{3}{4}$" (1.9 CM) SINGLE CELL	SCROLL FR $\frac{3}{4}$" (1.9 CM) SINGLE CELL
		Café*2562	Adirondack*2916
		Fresh Brew*2523	Manila*2914
		Hazy Skies*2527	Simply White*2901
		Iron Gate*2541	Spring Fawn*2915
		Lamplight*2509	Trevi*2918
		Monument*2555	
		Moonbeam*2503	
		Salted Caramel*2561	
		Stormy Sky*2538	
		Twine*2554	

†Same color front and back.
 Deep fabric colors darken a room; light colors filter and diffuse bright sunlight.
 *Color coordinates with Solitude (Blackout) and Valletta (Light Filtering/Room Darkening).
 **Color coordinates with Cocoon (Blackout).

Price Charts

Price Group N: Cocoon 3/8" (1.0 cm) Single Cell And Double Cell

Grabber Slide-View™

HEIGHT UP TO in. (cm) ↓	WIDTH UP TO in. (cm) →																		
	24 (61.0)	30 (76.2)	36 (91.5)	42 (106.7)	48 (122.0)	54 (137.2)	60 (152.4)	66 (167.7)	72 (182.9)	78 (198.2)	84 (213.4)	96 (243.9)	108 (274.4)	120 (304.8)	132 (335.3)	144 (365.8)	156 (396.3)	174 (442.0)	192 (487.7)
36 (91.5)	\$553	607	663	718	763	807	860	910	958	1032	1050	1232	1332	1407	1490	1563	1699	1705	2028
42 (106.7)	564	623	683	738	788	837	893	945	998	1085	1103	1292	1403	1491	1580	1662	1814	1821	2151
48 (122.0)	575	641	702	759	814	868	923	987	1041	1140	1158	1353	1476	1567	1668	1754	1925	1932	2270
54 (137.2)	591	655	722	783	838	897	964	1030	1089	1195	1213	1420	1544	1643	1755	1850	2036	2042	2403
60 (152.4)	601	670	741	805	868	934	1004	1073	1138	1255	1271	1479	1618	1727	1840	1946	2151	2157	2522
66 (167.7)	614	687	759	829	902	970	1046	1116	1187	1309	1325	1545	1688	1811	1929	2042	2260	2266	2657
72 (182.9)	627	703	782	860	935	1008	1085	1161	1235	1366	1382	1612	1766	1887	2016	2141	2373	2379	2787
78 (198.2)	638	719	804	885	967	1046	1124	1207	1285	1423	1439	1676	1840	1968	2103	2238	2487	2493	2916
84 (213.4)	650	736	827	911	998	1081	1167	1250	1330	1475	1491	1741	1914	2052	2197	2330	2590	2596	3044
88 (223.6)	665	757	851	938	1031	1117	1207	1294	1379	1529	1545	1807	1985	2133	2282	2419	2702	2709	3179

Colors

COCOON 3/8" (1.0 CM) DOUBLE CELL

Arboretum*	3830	Livingston	3822
Café*	3815	Mist	3812
Castaway*	3823	Molten Silver*	3828
Cloud	3800	Monument*	3831
Desert Dust	3839	Moonbeam*	3827
Dill*	3846	Orchard Ridge*	3824
Fresh Brew*	3847	Salted Caramel*	3819
Hazy Skies*	3848	Savannah	3820
High Point	3821	Scarlet*	3806
Inlet	3829	Stormy Sky*	3850
Iron Gate*	3851	Twine*	3854
Lemon Tree	3814		

COCOON 3/8" (1.0 CM) SINGLE CELL

Arboretum*	0430	Livingston	0402
Café*	0415	Mist	0412
Castaway*	0423	Molten Silver*	0428
Cloud	0400	Monument*	0431
Desert Dust	0439	Moonbeam*	0427
Dill*	0446	Orchard Ridge*	0424
Fresh Brew*	0447	Salted Caramel*	0419
Hazy Skies*	0448	Savannah	0420
High Point	0401	Scarlet*	0406
Inlet	0429	Stormy Sky*	0450
Iron Gate*	0451	Twine*	0454
Lemon Tree	0414		

*Color coordinates with Facets (Light Filtering/Room Darkening).

Price Charts

Price Group O: Valletta 3/8" (1.0 cm) Single Cell And 3/4" (1.9 cm) Single Cell

Graber Slide-View™

HEIGHT UP TO in. (cm) ↓	WIDTH UP TO in. (cm) →																		
	24 (61.0)	30 (76.2)	36 (91.5)	42 (106.7)	48 (122.0)	54 (137.2)	60 (152.4)	66 (167.7)	72 (182.9)	78 (198.2)	84 (213.4)	96 (243.9)	108 (274.4)	120 (304.8)	132 (335.3)	144 (365.8)	156 (396.3)	174 (442.0)	192 (487.7)
36 (91.5)	\$555	612	675	732	782	833	886	943	993	1079	1098	1294	1399	1477	1565	1641	1784	1790	2129
42 (106.7)	573	630	699	759	815	868	929	989	1046	1139	1158	1357	1473	1566	1659	1745	1905	1912	2259
48 (122.0)	588	653	723	788	845	906	969	1036	1093	1197	1216	1421	1550	1645	1751	1842	2021	2029	2384
54 (137.2)	605	675	747	816	880	942	1012	1082	1143	1255	1274	1491	1621	1725	1843	1943	2138	2144	2523
60 (152.4)	621	694	772	843	911	981	1054	1127	1195	1318	1335	1553	1699	1813	1932	2043	2259	2265	2648
66 (167.7)	638	715	797	870	947	1019	1098	1172	1246	1374	1391	1622	1772	1902	2025	2144	2373	2379	2790
72 (182.9)	653	735	821	903	982	1058	1139	1219	1297	1434	1451	1693	1854	1981	2117	2248	2492	2498	2926
78 (198.2)	667	755	844	929	1015	1098	1180	1267	1349	1494	1511	1760	1932	2066	2208	2350	2611	2618	3062
84 (213.4)	681	773	868	957	1048	1135	1225	1313	1397	1549	1566	1828	2010	2155	2307	2447	2720	2726	3196
90 (228.6)	698	795	894	985	1083	1173	1267	1359	1448	1605	1622	1897	2084	2240	2396	2540	2837	2844	3338
96 (243.9)	715	815	918	1015	1118	1212	1308	1407	1500	1663	1680	1968	2160	2323	2485	2633	2956	2964	3481
108 (274.4)	733	836	942	1045	1154	1248	1349	1454	1553	1720	1737	2037	2235	2408	2575	2728	3073	3084	3624
120 (304.8)	750	857	966	1073	1189	1286	1391	1503	1605	1778	1796	2106	2311	2492	2664	2821	3192	3203	3765

Colors

VALLETTA 3/8" (1.0 CM) SINGLE CELL

Adirondack*	0855
Atlantic Frost*	0858
Canyon Clay*	0860
Coconut Cream*	0851
Lime Chiffon*	0859
Manila*	0852
Simply White*	0850
Spring Fawn*	0854
Trevi*	0857
Walnut Shell*	0856

VALLETTA 3/4" (1.9 CM) SINGLE CELL

Adirondack*	2855
Atlantic Frost*	2858
Canyon Clay*	2860
Coconut Cream*	2851
Lime Chiffon*	2859
Manila*	2852
Simply White*	2850
Spring Fawn*	2854
Trevi*	2857
Walnut Shell*	2856

*Color coordinates with Scroll (Light Filtering) and Solitude (Blackout).

Price Charts

Price Group P: Cambridge 3/8" (1.0 cm) Single Cell, Simply Sheer 3/8" (1.0 cm) Single Cell, Simply Sheer 3/4" (1.9 cm) Single Cell, Solitude 3/8" (1.0 cm) Single Cell And 3/4" (1.9 cm) Single Cell

Grabber Slide-View™

HEIGHT UP TO in. (cm) ↓	WIDTH UP TO in. (cm) →																		
	24 (61.0)	30 (76.2)	36 (91.5)	42 (106.7)	48 (122.0)	54 (137.2)	60 (152.4)	66 (167.7)	72 (182.9)	78 (198.2)	84 (213.4)	96 (243.9)	108 (274.4)	120 (304.8)	132 (335.3)	144 (365.8)	156 (396.3)	174 (442.0)	192 (487.7)
36 (91.5)	\$582	641	707	767	820	872	928	988	1041	1131	1151	1355	1465	1548	1639	1719	1869	1876	2231
42 (106.7)	601	660	733	795	854	910	974	1036	1096	1194	1213	1421	1543	1640	1738	1828	1995	2003	2366
48 (122.0)	616	684	758	825	886	949	1015	1086	1145	1254	1274	1488	1624	1724	1835	1929	2118	2125	2497
54 (137.2)	634	707	782	855	922	987	1060	1133	1198	1315	1334	1562	1698	1807	1931	2035	2240	2246	2643
60 (152.4)	650	727	809	883	955	1027	1104	1180	1252	1381	1398	1627	1780	1900	2024	2141	2366	2373	2774
66 (167.7)	669	749	835	912	992	1067	1151	1228	1306	1440	1458	1700	1857	1992	2122	2246	2486	2493	2923
72 (182.9)	684	770	860	946	1029	1109	1194	1277	1359	1503	1520	1773	1943	2076	2218	2355	2610	2617	3066
78 (198.2)	699	791	884	974	1064	1151	1236	1328	1414	1565	1583	1844	2024	2165	2313	2462	2736	2742	3208
84 (213.4)	714	810	910	1002	1098	1189	1284	1375	1463	1623	1640	1915	2105	2257	2417	2563	2849	2856	3348
90 (228.6)	732	833	936	1032	1134	1229	1328	1423	1517	1682	1700	1988	2184	2346	2510	2661	2972	2980	3497
96 (243.9)	749	854	961	1064	1172	1269	1371	1474	1572	1742	1760	2061	2263	2433	2604	2759	3097	3105	3647
108 (274.4)	768	876	987	1095	1209	1308	1414	1524	1627	1802	1819	2134	2342	2522	2697	2858	3220	3231	3796
120 (304.8)	785	898	1012	1124	1245	1348	1458	1574	1682	1862	1881	2207	2421	2610	2791	2956	3344	3355	3945

Colors

CAMBRIDGE 3/8" (1.0 CM) SINGLE CELL†	SIMPLY SHEER 3/8" (1.0 CM) SINGLE CELL†	SOLITUDE 3/8" (1.0 CM) SINGLE CELL	SOLITUDE 3/4" (1.9 CM) SINGLE CELL
Black Swan2605	Almond.....0152	Adirondack*1714	Adirondack*2714
Eagles Nest2604	Mocha0154	Atlantic Frost*1717	Atlantic Frost*2717
Feather White2600	Whisper0150	Canyon Clay*1719	Canyon Clay*2719
Heron Plume.....2602		Coconut Cream*1711	Coconut Cream*2711
Sandhill Crane2601	SIMPLY SHEER 3/4" (1.9 CM) SINGLE CELL†	Lime Chiffon*1718	Lime Chiffon*2718
Urban Bird2603	Almond.....2152	Manila*1712	Manila*2712
	Mocha2154	Simply White*1701	Simply White*2701
	Whisper2150	Spring Fawn*1713	Spring Fawn*2713
		Trevi*1716	Trevi*2716
		Walnut Shell*1715	Walnut Shell*2715

*Color coordinates with Scroll and Valletta (Light Filtering/Room Darkening).

†Internal cords will be visible.

Options Pricing

Perfect Arches: Half Circle

Width To in. (cm) →	24 (61.0)	30 (76.2)	36 (91.5)	42 (106.7)	48 (122.0)	54 (137.2)	60 (152.4)	66 (167.7)	72 (182.9)	84 (213.4)
Group A	\$141	155	176	194	224	256	287	324	356	393
Group B	145	162	184	206	234	267	301	339	373	410
Group C	186	211	239	370	304	345	388	438	483	529
Group D	190	215	249	284	335	394	440	502	573	645
Group E	205	232	262	406	333	379	426	480	530	581
Group F	187	212	248	287	334	392	438	500	569	644
Group G	196	223	260	301	351	412	460	525	597	676
Group H	206	233	273	316	367	431	482	550	626	708

Non-Perfect Arches

Width To in. (cm) →	24 (61.0)	30 (76.2)	36 (91.5)	42 (106.7)	48 (122.0)	54 (137.2)	60 (152.4)	66 (167.7)	72 (182.9)	84 (213.4)
Group A	\$182	203	228	255	293	334	374	423	463	509
Group B	187	211	239	267	304	347	387	441	485	531
Group C	244	274	307	345	393	449	504	568	626	690
Group D	244	273	311	360	417	494	549	629	715	808
Group E	268	301	337	379	432	493	553	623	687	757
Group F	242	276	322	370	434	509	568	650	742	837
Group G	254	290	338	389	456	534	596	683	779	879
Group H	266	304	354	407	477	560	625	715	816	921

Options Pricing

Options Pricing

OPTION	SURCHARGE
Blackout Side Channels	\$108
Bottom Up/Top Down–Standard Cord Control	\$103
Bottom Up/Top Down–Cordless Lift	Price as a Cordless Lift shade and add \$124
Continuous-loop Lift (recommended for large, heavy shades)	See surcharge by width under Price Charts
Cord Cleats	Clear: No charge Decorative: Solid Brass \$10 Antique Brass: \$5
Cord Winder	\$8
Cordless Lift	See surcharge by width under Price Charts
Cut Outs	\$67
Motorized Lift	See Motorization tab
Multiple Shades on One Headrail (less than or equal to fabric width): Two or Three on One Headrail	2 on 1: \$70 3 on 1: \$114
Sky Pole	3 - 6½ ft. (91.5 cm - 198.2 cm): \$46 5 - 9½ ft. (152.4 cm - 289.6 cm): \$70
SkyTrack™ Skylight	\$123
Sun Up/Sun Down–Standard Cord Control	Price as two separate shades and combine for cost
Sun Up/Sun Down–Cordless Lift	Price as two separate shades and add one Cordless Lift surcharge for cost
Template Service	\$25 net
Top Down Only	\$83 plus the Continuous-loop surcharge
Perfect-Vue™ Shade–Standard Cord Control	See Price Chart
Perfect-Vue Shade–Cordless Lift	See Price Chart and add one Cordless Lift surcharge
Premier Wood-Wrapped Rails	See Price Chart below
Wood Cornices and Valances	See Wood Cornice and Valance Price List Tab
SPECIALTY SHAPES	SURCHARGE
Angled Top/Angled Bottom	Price as Standard Cord Control shade using angled width and longest height; add \$164
Arches and Non-perfect Arches	See Arch Pricing
Arch Over Standard Cord Control	Price as an arch and add to the cost of a Standard Cord Control shade
Octagon, Hexagon or Trapezoid	Price as Standard Cord Control shade using widest width and largest height; add \$251
SLIDE-VUE™ CELLULAR	SEE PRICE CHARTS FOR PRICING

Premier Wood-Wrapped Rails

WIDTH UP TO in. (cm) →	24 (61.0)	30 (76.2)	36 (91.5)	42 (106.7)	48 (122.0)	54 (137.2)	60 (152.4)	66 (167.7)	72 (182.9)	84 (213.4)	96 (243.9)	108 (274.4)	120 (304.8)
Surcharge	\$36	44	52	62	72	82	92	102	112	132	142	162	172

Color Charts: Perfect-Vue™

How To Order And Price Perfect-Vue Shades

1. Select the corresponding Price Group for the top of the shade (Pleated Fabric).
2. Select the corresponding Price Group for the bottom of the shade (Cellular Fabric).
3. Find your width and height.
4. Add together cost of the top and the bottom shades for the total cost of Standard Cord Control Perfect-Vue shade.
5. The Cordless Lift option has a surcharge based on the width of the shade:

WIDTH UP TO in. (cm) →	24 (61.0)	30 (76.2)	36 (91.5)	42 (106.7)	48 (122.0)	54 (137.2)	60 (152.4)	66 (167.7)	72 (182.9)	84 (213.4)
Cordless Lift	\$102	106	108	112	122	124	126	132	137	175

6. Two on one headrail (available as Standard Cord Control only) add surcharge of \$70.

Pleated Colors

1" (2.6 cm) FashionPleat®	Price Group			Color Name	1" (2.6 cm) Pleated Color #	2" (5.1 cm) Pleated Color #
	1" (2.6 cm) FashionPleat	1" (2.6 cm) EvenPleat®	2" (5.1 cm) EvenPleat			
Allure	B	E		Bone	2002	
				Milk Chocolate	2004	
				Sahara	2417	
				Silver Lining	2007	
				Tibet	2460	
				White	2001	
Brighton	A	D		Bark	4105	
				Bone	4122	
				Graham Cracker	4103	
				Platinum	4150	
				Sugar Maple	4102	
				Toast	4182	
				Tundra	4101	
				White	4119	
Brighton FR	B	E		Bark	5605	
				Bone	5622	
				Graham Cracker	5603	
				Platinum	5650	
				Sugar Maple	5602	
				Toast	5682	
				Tundra	5601	
White	5619					
Cabana			G	Calla Lily		2950
				Log Cabin		2951
				Spur		2952
Crossweave	C	F	G	Barley	0203	6703
				Brick	0202	6702
				Burnished Gold	0208	0708
				Natural	0200	0700
				Tahiti	0209	0709
				Thatched Roof	0212	0712
Desert	C	F	G	Clamshell	1438	2038
				Natural	1434	2034
				Sandstone	1432	2032
				Shell	1431	2031
				Strata	1436	2036
				Sugarcane	1437	2037

Color Charts: Perfect-Vue™

Pleated Colors (Cont.)

1" (2.6 cm) FashionPleat®	Price Group			Color Name	1" (2.6 cm) Pleated Color #	2" (5.1 cm) Pleated Color #
	1" (2.6 cm) FashionPleat	1" (2.6 cm) EvenPleat®	2" (5.1 cm) EvenPleat			
Geneva	B	E	G	Bamboo	5313	4713
				Bay Horse	5304	4704
				Frost White	5301	4701
				Mottled Sycamore	5302	4702
				Pearl Stone	5314	4714
				Regiment	5306	4706
				Tapenade	5309	4709
Grasscloth			G	Albuquerque		1004
				Boardwalk		1001
				Fence Post		1003
				Natural		1000
				Saddle		1002
				Safari		1050
Magnolia		F	H	Ravine	4951	1851
				Smoky Gardenia	4952	1852
				Snowdrop	4950	1850
Marquis		F	H	Bronze Age	0651	1651
				Gilded Age	0650	1650
				Victorian Age	0652	1652
Mission		F		Antique White	9700	
				Cappuccino	9710	
				Chamois	9704	
				Fox	9701	
				Sesame	9703	
Orchestra			H	Bilbao		2750
				Igloo		2751
				Indigo Ripple		2754
				Irish Moss		2752
				Toasted Almond		2753
Prism		F	H	Liquid Bronze	2251	2651
				Sequin	2250	2650
				Tinsel	2252	2652
Serendipity		E	G	Gorgeous Gray	5702	4902
				Grand Piano	5704	4904
				Heavenly	5700	4900
				Tufted Suede	5703	4903
				Vintage Cameo	5701	4901
Sheer Linen	B	E	G	Alabaster	3102	4802
				Cyclone	3106	4806
				Granola	3107	4807
				Martini	3108	4808
				White	3101	4801
Tuvalu			G	Cream Caramel		4850
				Cream Silk		4851
				French Silk		4852
Visage		E		Linen White	3700	
				Malton	3711	
				Otter	3713	
				Portabello	3712	

Color Charts: Perfect-Vue™

Cellular Colors

Style Name	Price Group			Color Name	¾" (1.0 cm) DC Color #	¾" (1.0 cm) SC Color #	¾" (1.9 cm) SC Color #
	¾" (1.0 cm) DC	¾" (1.0 cm) SC	¾" (1.9 cm) SC				
Cambridge		H		Black Swan		2605	
				Eagles Nest		2604	
				Feather White		2600	
				Heron Plume		2602	
				Sandhill Crane		2601	
				Urban Bird		2603	
				Arboretum			3830
Cocoon	F	F		Café	3815	0415	
				Castaway	3823	0423	
				Cloud	3800	0400	
				Desert Dust	3839	0439	
				Dill	3846	0446	
				Fresh Brew	3847	0447	
				Hazy Skies	3848	0448	
				High Point	3821	0401	
				Inlet	3829	0429	
				Iron Gate	3851	0451	
				Lemon Tree	3814	0414	
				Livingston	3822	0402	
				Mist	3812	0412	
				Molten Silver	3828	0428	
				Monument	3831	0431	
				Moonbeam	3827	0427	
				Orchard Ridge	3824	0404	
				Salted Caramel	3819	0419	
				Savannah	3820	0420	
				Elegant Neutrals	E	C	C
Stormy Sky	3850	0450					
Twine	3854	0454					
Alabaster Frost	3704	4204	0804				
Cloud White	3710	4210	0810				
Light Waves	2434	4234	0834				
Sparkle	2401	4201	0801				
Starlight	2402	4202	0802				
Facets	E		E	Antique	2457		
				Arboretum	2458		
				Avocado	2443		
				Café	2462		2562
				Castaway	2449		
				Chalet	2467		
				Deep Blue	2489		
				Deep Walnut	2491		
				Dill	2476		
				Fresh Brew	2423		2523
				Hazy Skies	2427		2527
				Iron Gate	2441		2541
				Lamplight	2409		2509
				Lemon Tree	2452		
				Marseille	2444		
				Midnight	2433		
				Midnight Tulip	2459		
				Molten Silver	2446		
				Monument	2455		2555
				Moonbeam	2403		2503
				Orchard Ridge	2463		
				Pale Blue	2419		
				Salted Caramel	2461		2561
Scarlet	2406						
Stormy Sky	2438		2538				
Sunshine	2464						
Twine	2454		2554				
Tropical Bay	2466						
Wading Pool	2448						

NOTE: DC = Double Cell SC = Single Cell

Color Charts: Perfect-Vue™

Cellular Colors (Cont.)

Style Name	Price Group			Color Name	¾" (1.0 cm) DC Color #	¾" (1.0 cm) SC Color #	¾" (1.9 cm) SC Color #
	¾" (1.0 cm) DC	¾" (1.0 cm) SC	¾" (1.9 cm) SC				
Garden Retreat	C	C	C	Antler	0978	0078	0778
				Apollo	0902	0002	0702
				Cayenne	0972	0072	0772
				Chalk	0903	0003	0703
				Cilantro	0973	0073	0773
				Cirrus	0977	0077	0777
				Classic Navy	0947	0047	0747
				Colonial Slate	0993	0093	0793
				Country Barn	0988	0088	0788
				Creamy	0904	0004	0704
				Espresso	0971	0071	0771
				Grasscloth	0931	0031	0731
				Hunting Lodge	0976	0076	0776
				Inlet	0979	0079	0779
				Khaki	0944	0044	0744
				Poppyseed	0989	0089	0789
				Potter's Clay	0992	0092	0792
				Quicksand	0915	0015	0715
				Riverbed	0990	0090	0790
				Sandcastle	0913	0013	0713
				Sandy Point	0991	0091	0791
				Solitaire	0901	0001	0701
				Spring Rain	0916	0016	0716
				Threshold Taupe	0910	0010	0710
				Tide Pool	0994	0094	0794
				Timeless Taupe	0984	0084	0784
Valley Vine	0987	0087	0787				
White Rose	0970	0070	0770				
Scroll			D	Adirondack			2316
				Atlantic Frost			2319
				Canyon Clay			2321
				Coconut Cream			2313
				Lime Chiffon			2320
				Manila			2314
				Simply White			2301
				Spring Fawn			2315
				Trevi			2318
				Walnut Shell			2317
Scroll FR			E	Adirondack			2916
				Manila			2914
				Simply White			2901
				Spring Fawn			2915
Simply Sheer		H	H	Trevi			2918
				Almond		0152	2152
				Mocha		0154	2154
Solitude			H	Whisper		0150	2150
				Adirondack			1714
				Atlantic Frost			1717
				Canyon Clay			1719
				Coconut Cream			1711
				Lime Chiffon			1718
				Manila			1712
				Simply White			1701
				Spring Fawn			1713
				Trevi			1716
Walnut Shell			1715				

NOTE: DC = Double Cell SC = Single Cell

Color Charts: Perfect-Vue™

Cellular Colors (Cont.)

Style Name	Price Group			Color Name	¾" (1.0 cm) DC Color #	¾" (1.0 cm) SC Color #	¾" (1.9 cm) SC Color #
	¾" (1.0 cm) DC	¾" (1.0 cm) SC	¾" (1.9 cm) SC				
Translucence	B	A	B	Angelhair	3417	5117	4617
				Buttercup	3401	5101	4601
				Jack Frost	3400	5100	4600
				Lioness	3413	5113	4613
				Mocha	3411	5111	4611
				Papyrus	3402	5102	4602
				Risotto	3412	5112	4612
				Sculpture Garden	3410	5110	4610
				Night Sky	D		
Buttercup		0482					
Jack Frost		0480					
Papyrus		0483					
Sala	E			Antique Map	2052		
				Cathedral	2051		
				Colonial Pewter	2055		
				Statue	2053		
				Weathered Stone	2054		
Valletta		G	G	Adirondack		0855	2855
				Atlantic Frost		0858	2858
				Canyon Clay		0860	2860
				Coconut Cream		0851	2851
				Lime Chiffon		0859	2859
				Manila		0852	2852
				Simply White		0850	2850
				Spring Fawn		0854	2854
				Trevi		0857	2857
				Walnut Shell		0856	2856

NOTE: DC = Double Cell SC = Single Cell

Price Charts

How To Order And Price Perfect-Vue™ Shades

1. Select the corresponding Price Group for the top of the shade (Pleated Fabric).
2. Select the corresponding Price Group for the bottom of the shade (Cellular Fabric).
3. Find your width and height.
4. Add together cost of the top and the bottom shades for the total cost of Standard Cord Control Perfect-Vue shade.
5. The Cordless Lift option has a surcharge based on the width of the shade:

WIDTH UP TO in. (cm) →	24 (61.0)	30 (76.2)	36 (91.5)	42 (106.7)	48 (122.0)	54 (137.2)	60 (152.4)	66 (167.7)	72 (182.9)	84 (213.4)
Cordless Lift	\$102	106	108	112	122	124	126	132	137	175

6. Two on one headrail (available as Standard Cord Control only) add surcharge of \$70.

Perfect-Vue Shade Pricing (Cont.)

FABRIC TYPE	PRICE GROUP	HEIGHT UP TO	WIDTH UP TO in. (cm) →														
			24 (61.0)	30 (76.2)	36 (91.5)	42 (106.7)	48 (122.0)	54 (137.2)	60 (152.4)	66 (167.7)	72 (182.9)	84 (213.4)	96 (243.9)	108 (274.4)	120 (304.8)	132 (335.3)	144 (365.8)
PLEATED PRICE GROUPS	A	36" (76.2 cm)	\$125	141	159	178	188	206	224	240	256	286	320	417	452	483	512
	B		134	152	171	197	207	226	245	263	279	312	413	452	490	525	558
	C		149	169	194	215	230	252	274	293	311	349	457	504	547	583	620
	D		144	165	181	205	217	238	258	276	293	327	365	478	518		
	E		157	179	200	225	241	262	283	305	324	364	481	524	572		
	F		163	187	212	236	253	276	297	319	341	380	505	551	598		
	G		219	252	280	313	339	369	399	427	455	625	674	733	909	1009	1109
	H		252	290	322	360	390	424	459	491	523	719	775	843	1045	1151	1257
CELLULAR PRICE GROUPS	A	36" (76.2 cm)	122	133	153	170	190	207	222	240	256	296	333	411	445	482	516
	B		125	140	157	177	196	211	230	247	265	303	341	422	458	496	529
	C		165	183	208	234	258	278	302	325	349	398	449	557	604	652	699
	D		171	192	217	244	269	291	316	341	365	415	470	583	634	679	732
	E		181	201	228	257	283	305	331	357	383	436	493	611	662	715	767
	F		211	237	268	301	330	360	388	420	450	512	661	718	776	839	900
	G		222	249	281	316	347	378	407	441	473	538	694	754	815	881	945
	H		232	261	295	331	363	396	427	462	495	563	727	790	854	923	990
PLEATED PRICE GROUPS	A	42" (106.7 cm)	133	149	169	188	209	226	242	261	279	309	349	449	483	519	556
	B		147	163	185	205	227	247	267	286	305	341	452	490	528	569	610
	C		163	180	204	229	252	273	294	317	339	377	504	547	587	632	678
	D		152	170	196	216	239	259	278	299	320	355	399	515	555		
	E		171	190	212	239	264	285	307	331	355	396	524	572	614		
	F		179	197	222	252	277	300	323	348	372	414	551	598	644		
	G		237	262	300	338	369	400	430	461	493	672	741	801	989	1114	1214
	H		273	301	345	389	424	460	495	530	567	773	852	921	1137	1252	1367
CELLULAR PRICE GROUPS	A	42" (106.7 cm)	128	147	165	188	207	224	247	266	285	323	358	453	491	533	569
	B		133	150	172	191	211	233	252	273	293	333	368	462	506	546	584
	C		177	199	225	253	278	305	334	356	385	440	485	611	666	718	770
	D		184	207	237	266	291	319	350	375	404	459	505	637	696	749	807
	E		194	218	246	278	305	334	366	391	423	483	532	670	731	788	845
	F		227	253	291	326	360	393	427	462	496	566	718	785	857	925	993
	G		238	266	306	342	378	413	448	485	521	594	754	824	900	971	1043
	H		250	278	320	359	396	432	470	508	546	623	790	864	943	1018	1092

Price Charts

Perfect-Vue Shade Pricing (Cont.)

FABRIC TYPE	PRICE GROUP	HEIGHT UP TO	WIDTH UP TO in. (cm) →														
			24 (61.0)	30 (76.2)	36 (91.5)	42 (106.7)	48 (122.0)	54 (137.2)	60 (152.4)	66 (167.7)	72 (182.9)	84 (213.4)	96 (243.9)	108 (274.4)	120 (304.8)	132 (335.3)	144 (365.8)
PLEATED PRICE GROUPS	A	48" (122.0 cm)	\$143	160	186	203	219	242	265	281	299	337	374	484	531	564	597
	B		157	178	202	218	241	266	289	308	327	370	484	533	580	618	654
	C		171	198	226	243	269	296	323	344	364	410	539	590	646	687	727
	D		165	185	212	233	252	279	305	323	342	386	431	557	607		
	E		181	207	235	253	280	309	338	358	379	430	560	617	673		
	F		190	217	247	266	294	324	355	378	399	449	590	647	707		
	G		253	287	330	356	391	431	470	502	533	716	785	861	1064	1219	1319
	H		291	330	380	409	450	496	541	577	613	823	903	990	1224	1347	1470
CELLULAR PRICE GROUPS	A	48" (122.0 cm)	138	156	181	203	222	247	267	288	311	355	401	490	533	578	623
	B		143	161	184	207	230	252	274	296	320	366	415	505	547	593	640
	C		185	214	242	273	302	334	359	390	420	482	546	664	721	782	843
	D		196	224	255	284	316	349	377	410	439	502	570	695	754	818	881
	E		203	235	266	299	331	366	394	428	461	529	599	729	791	858	924
	F		241	274	312	352	388	427	464	505	541	619	776	854	928	1008	1082
	G		253	288	328	370	407	448	487	530	568	650	815	897	974	1058	1136
	H		265	301	343	387	427	470	510	556	595	681	854	939	1021	1109	1190
PLEATED PRICE GROUPS	A	54" (137.2 cm)	149	169	192	210	230	255	279	302	324	363	405	510	554	603	644
	B		163	185	208	231	254	279	304	329	352	399	509	557	609	655	702
	C		180	204	231	256	282	310	338	365	391	441	563	618	676	728	781
	D		170	196	217	242	267	293	318	345	370	415	464	586	639		
	E		190	212	241	269	296	324	353	381	409	461	590	645	703		
	F		197	222	253	282	309	341	372	401	431	483	617	677	740		
	G		262	300	340	373	412	452	492	531	570	747	822	904	1143	1324	1424
	H		301	345	391	429	474	520	566	611	656	859	945	1040	1314	1448	1578
CELLULAR PRICE GROUPS	A	54" (137.2 cm)	148	166	192	215	240	266	287	313	336	385	438	529	576	624	672
	B		151	173	199	221	247	273	295	321	346	396	450	543	592	642	692
	C		200	227	261	293	325	356	389	424	454	522	593	717	781	849	912
	D		207	239	273	308	341	375	407	445	474	546	621	748	816	886	952
	E		219	249	286	321	357	391	427	466	498	573	651	786	857	931	1000
	F		257	293	335	378	420	460	503	546	587	671	839	920	1002	1092	1174
	G		270	308	352	397	441	483	528	573	616	705	881	966	1052	1147	1233
	H		283	322	369	416	462	506	553	601	646	738	923	1012	1102	1201	1291
PLEATED PRICE GROUPS	A	60" (152.4 cm)	157	181	209	227	261	279	297	320	343	393	437	557	594	641	688
	B		170	200	227	249	282	304	327	351	375	430	565	611	653	703	754
	C		193	218	252	278	315	338	361	389	417	477	630	680	724	780	835
	D		180	209	239	260	298	320	342	368	394	449	503	640	684		
	E		200	231	264	288	329	353	378	408	436	497	658	707	757		
	F		211	242	277	304	345	373	399	428	458	520	691	742	794		
	G		278	320	369	408	510	546	582	618	661	811	1021	1096	1325	1429	1529
	H		320	368	424	469	587	628	669	711	760	933	1174	1260	1524	1677	1830
CELLULAR PRICE GROUPS	A	60" (152.4 cm)	154	181	207	230	256	284	311	336	362	418	473	568	622	672	726
	B		159	184	211	238	265	291	320	346	373	428	487	582	639	692	745
	C		211	241	278	314	349	385	420	454	492	565	642	769	840	912	981
	D		218	252	291	327	365	403	439	474	515	591	673	806	879	953	1028
	E		232	264	305	345	383	423	461	498	540	620	704	844	922	1000	1076
	F		270	310	358	402	448	494	541	587	633	726	897	990	1081	1174	1264
	G		284	326	376	422	470	519	568	616	665	762	942	1040	1135	1233	1327
	H		297	341	394	442	493	543	595	646	696	799	987	1089	1189	1291	1390

Price Charts

Perfect-Vue Shade Pricing (Cont.)

FABRIC TYPE	PRICE GROUP	HEIGHT UP TO	WIDTH UP TO in. (cm) →														
			24 (61.0)	30 (76.2)	36 (91.5)	42 (106.7)	48 (122.0)	54 (137.2)	60 (152.4)	66 (167.7)	72 (182.9)	84 (213.4)	96 (243.9)	108 (274.4)	120 (304.8)	132 (335.3)	144 (365.8)
PLEATED PRICE GROUPS	A	66" (167.7 cm)	\$164	188	216	240	270	293	316	343	370	419	465	587	634	689	744
	B		180	207	238	265	296	323	349	377	406	456	593	645	694	754	813
	C		201	230	267	290	331	358	386	418	449	509	656	714	771	836	900
	D		188	217	249	278	313	339	363	394	425	480	534	676	728		
	E		209	241	277	306	343	373	402	436	470	531	690	745	806		
	F		220	253	290	322	361	391	422	457	492	557	722	784	847		
	G		295	339	386	425	530	571	610	660	709	853	1063	1140	1414	1534	1634
	H		339	390	444	489	610	657	702	759	815	981	1222	1311	1626	1789	1952
CELLULAR PRICE GROUPS	A	66" (167.7 cm)	164	190	218	247	276	301	333	361	391	447	509	608	665	721	777
	B		171	196	224	252	281	311	341	371	400	459	524	623	683	743	799
	C		220	258	295	334	374	412	450	487	527	605	690	823	902	976	1056
	D		231	269	310	350	391	430	472	512	553	634	721	860	943	1021	1102
	E		242	283	323	366	410	452	494	534	579	663	757	903	990	1071	1158
	F		287	330	380	427	480	529	580	627	678	778	959	1057	1161	1257	1356
	G		301	347	399	448	504	555	609	658	712	817	1007	1110	1219	1320	1424
	H		316	363	418	470	528	582	638	690	746	856	1055	1163	1277	1383	1492
PLEATED PRICE GROUPS	A	72" (182.9 cm)	169	198	227	253	283	309	335	364	393	440	497	618	674	729	786
	B		185	216	249	276	310	340	368	400	430	482	617	677	732	794	857
	C		204	240	278	307	342	375	409	443	477	535	687	751	817	886	954
	D		196	228	260	289	324	355	385	417	449	504	571	707	770		
	E		212	249	288	321	359	392	425	461	497	558	716	784	851		
	F		222	263	304	337	377	412	447	484	520	586	752	823	893		
	G		300	354	408	449	544	592	639	691	742	895	1086	1183	1483	1639	1739
	H		345	407	469	516	626	681	735	795	853	1029	1249	1360	1705	1877	2047
CELLULAR PRICE GROUPS	A	72" (182.9 cm)	170	201	230	261	296	323	354	385	416	478	546	648	708	768	832
	B		177	206	238	271	303	333	365	393	426	491	561	666	726	789	854
	C		234	272	314	354	398	439	479	521	564	649	737	879	958	1041	1126
	D		244	283	327	374	415	459	501	542	587	676	773	919	999	1089	1177
	E		257	298	345	389	436	481	525	572	619	712	809	964	1051	1142	1235
	F		301	348	402	456	512	566	618	670	725	832	1022	1130	1233	1339	1450
	G		316	365	422	479	538	594	649	704	761	874	1073	1187	1295	1406	1523
	H		331	383	442	502	563	623	680	737	798	915	1124	1243	1356	1473	1595
PLEATED PRICE GROUPS	A	78" (198.2 cm)	178	209	240	267	294	324	353	386	417	471	526	646	707	769	831
	B		197	229	265	290	321	353	386	419	452	515	645	709	771	838	905
	C		216	253	290	323	356	392	427	467	504	572	714	784	857	931	1005
	D		205	241	278	305	338	372	405	441	478	539	604	740	811		
	E		228	266	306	339	374	411	447	486	524	596	745	822	896		
	F		238	278	322	356	391	432	472	512	552	628	784	863	940		
	G		316	369	425	471	573	627	681	735	788	945	1151	1257	1575	1744	1844
	H		363	424	489	542	659	721	783	845	906	1087	1324	1446	1811	1992	2172
CELLULAR PRICE GROUPS	A	78" (198.2 cm)	181	211	244	277	311	345	377	410	441	508	581	690	753	817	889
	B		184	216	250	282	320	354	386	421	454	523	598	710	773	843	912
	C		243	285	329	375	422	467	510	555	598	690	789	938	1017	1108	1197
	D		256	298	345	391	444	488	531	579	626	721	823	979	1065	1158	1252
	E		267	313	360	411	463	512	559	609	657	757	866	1029	1115	1216	1313
	F		313	366	422	480	542	600	655	714	772	887	1083	1203	1311	1423	1542
	G		329	384	443	504	569	630	688	750	811	931	1137	1263	1377	1494	1619
	H		344	403	464	528	596	660	721	785	849	976	1191	1323	1442	1565	1696

Perfect-Vue Shade Pricing (Cont.)

FABRIC TYPE	PRICE GROUP	HEIGHT UP TO	WIDTH UP TO in. (cm) →														
			24 (61.0)	30 (76.2)	36 (91.5)	42 (106.7)	48 (122.0)	54 (137.2)	60 (152.4)	66 (167.7)	72 (182.9)	84 (213.4)	96 (243.9)	108 (274.4)	120 (304.8)	132 (335.3)	144 (365.8)
PLEATED PRICE GROUPS	A	84" (213.7 cm)	\$186	216	251	279	307	341	373	405	436	494	554	682	749	812	873
	B		204	238	274	305	338	374	410	444	479	543	677	750	819	888	956
	C		227	267	304	339	374	414	452	490	528	603	751	831	909	985	1059
	D		213	249	288	320	354	392	430	465	500	568	639	782	859		
	E		236	277	316	355	392	434	474	515	554	629	784	867	948		
	F		249	290	331	372	412	455	499	541	582	660	822	909	995		
	G		333	386	445	493	593	652	711	767	823	989	1188	1304	1645	1849	1949
	H		383	444	512	567	682	750	818	882	946	1137	1366	1500	1892	2080	2268
CELLULAR PRICE GROUPS	A	84" (213.7 cm)	188	218	255	288	330	364	398	435	469	538	616	731	800	869	937
	B		191	224	263	296	339	376	412	448	482	553	633	752	821	893	961
	C		253	298	345	390	445	495	542	588	633	727	833	988	1080	1178	1269
	D		266	311	360	410	465	517	565	615	664	762	871	1034	1131	1231	1328
	E		278	327	379	428	488	544	594	645	695	798	914	1084	1185	1293	1392
	F		326	384	445	505	571	635	697	755	816	936	1145	1272	1391	1513	1631
	G		342	403	467	530	600	667	732	793	857	983	1202	1336	1461	1589	1713
	H		359	422	490	556	628	699	767	831	898	1030	1260	1399	1530	1664	1794
PLEATED PRICE GROUPS	A	90" (228.6 cm)	192	224	259	290	320	353	387	420	452	513	577	703	770	837	903
	B		208	245	282	319	349	386	422	458	493	564	697	771	847	919	991
	C		231	274	312	352	387	430	472	511	550	627	773	857	936	1019	1099
	D		219	256	294	333	365	405	445	482	519	590	662	809	885		
	E		243	283	328	368	404	449	492	534	574	655	808	896	982		
	F		254	297	344	386	423	469	515	559	603	686	848	940	1030		
	G		342	399	458	518	612	673	732	791	850	1030	1221	1341	1702	1954	2054
	H		393	459	527	596	704	774	842	910	978	1185	1404	1542	1957	2153	2347
CELLULAR PRICE GROUPS	A	90" (228.6 cm)	194	230	268	301	348	385	423	459	495	568	652	768	844	914	990
	B		201	238	275	311	356	393	433	470	508	582	671	789	867	940	1017
	C		265	314	361	413	471	521	570	620	671	769	884	1041	1141	1240	1341
	D		276	327	378	431	492	542	599	647	703	804	924	1089	1195	1295	1400
	E		290	345	396	453	516	572	625	680	736	844	970	1142	1252	1361	1471
	F		341	402	466	531	605	670	733	798	863	989	1209	1339	1468	1593	1715
	G		358	422	489	558	635	704	770	838	906	1038	1269	1406	1541	1673	1801
	H		375	442	513	584	666	737	806	878	949	1088	1330	1473	1615	1752	1887
PLEATED PRICE GROUPS	A	96" (243.9 cm)	197	230	267	300	329	364	399	434	469	535	599	726	797	867	936
	B		214	254	290	331	357	400	438	476	512	583	720	797	873	948	1022
	C		238	282	324	365	401	443	486	527	568	649	798	886	970	1053	1135
	D		225	264	308	345	377	417	456	497	538	612	688	833	914		
	E		248	296	339	383	416	462	508	551	593	677	834	924	1015		
	F		261	309	356	401	438	486	534	578	623	711	877	968	1064		
	G		369	430	493	552	633	695	755	815	874	1106	1268	1388	1748	2059	2159
	H		424	495	567	635	728	799	868	937	1005	1272	1458	1596	2010	2211	2412
CELLULAR PRICE GROUPS	A	96" (243.9 cm)	205	244	280	318	364	403	442	482	524	601	687	812	890	966	1043
	B		210	250	288	329	376	416	456	496	537	617	707	832	913	991	1072
	C		276	328	380	435	493	548	600	653	707	812	933	1099	1200	1305	1413
	D		287	345	396	456	516	573	628	680	737	849	977	1145	1256	1365	1477
	E		303	359	417	477	541	601	659	716	775	890	1024	1206	1316	1432	1550
	F		356	421	489	558	634	707	772	839	909	1044	1268	1411	1545	1679	1818
	G		374	442	513	586	666	742	811	881	954	1096	1331	1482	1622	1763	1909
	H		392	463	538	614	697	778	849	923	1000	1148	1395	1552	1700	1847	2000



Graber is a brand of Springs Window Fashions, the Best Experience Company



graberblinds.com

Graber and the Graber logo are registered trademarks of Springs Window Fashions, LLC.
Springs Window Fashions, Middleton WI

19-0357-02 (05/15) 150622|S150039