



THIS
year
IS **the**
TICKET!



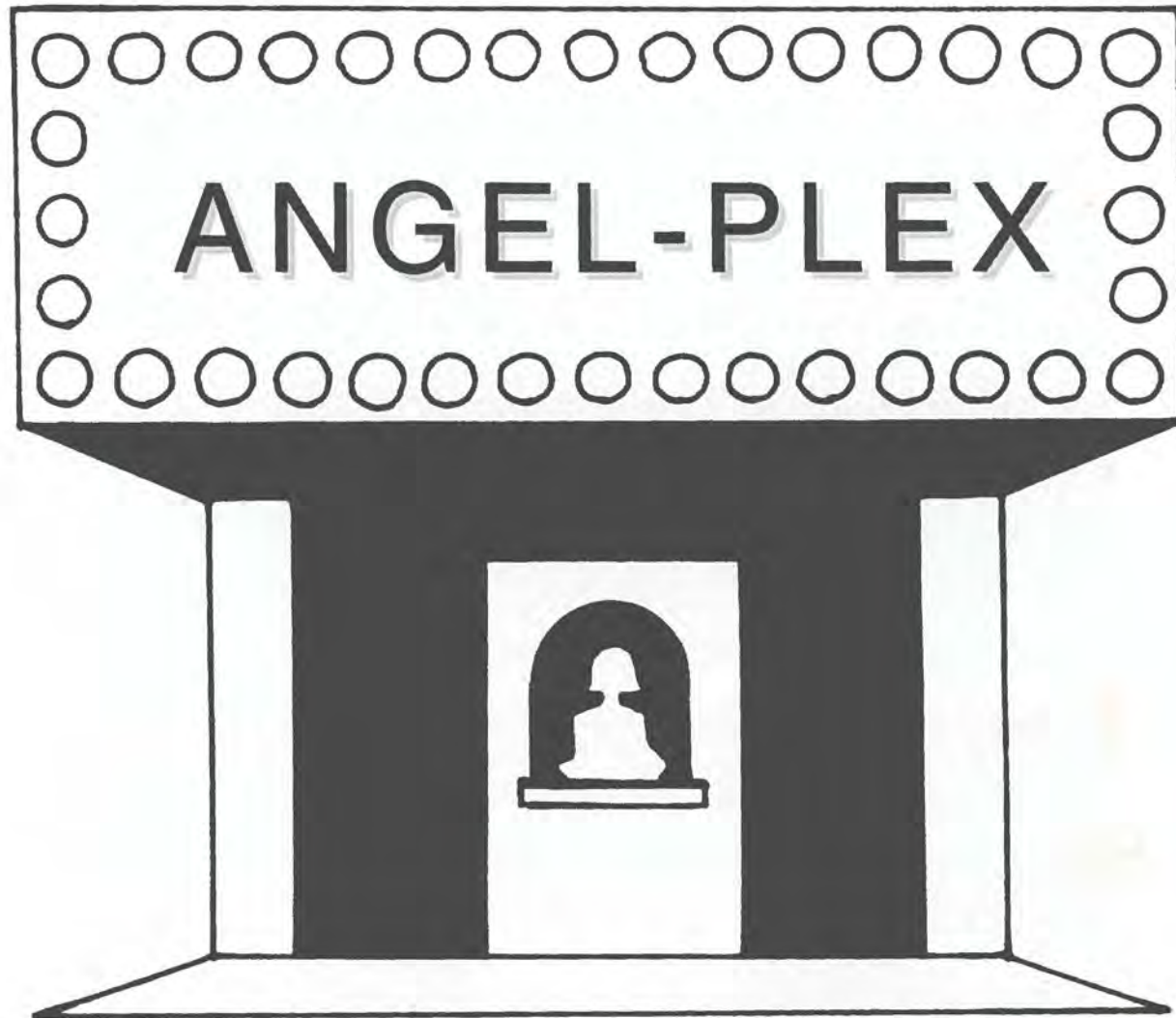

Table of Contents

A Paramount Year Opening	2
A Piece of the Action Student Life	4
Breakfast Club Clubs/Organizations	26
The Graduate Seniors	44
Dangerous Minds People	66
The Program Athletics	96
Higher Learning Academics	112
The Neverending Story Closing	128



1996 - 1997



ANGEL PLEX

~ Now Showing ~

Incarnate Word
Academy

** Aurora **

2910 South Alameda
Corpus Christi, Texas 78404
(512) 883 - 0857

V
O
L
U
M
E

7
3



A Paramount Year



Sophomore Leslie Meyer gives a helping hand to Freshman Juli Kim during her first year in high school.



Students at IWA have a variety of emotions throughout the school

year, as demonstrated by Manuel Macias who looks a little confused. "Where am I?"



Sister Eileen brings her first year Religion class into a circle to learn as a group.

The Debut:

Here it was, another year, a closing of the past and an opening of the future.

For most of us high school was probably the most important time of our lives. For the freshmen it was only the beginning, but for the seniors this year was the end of four years of good times and bad times, friendships, new experiences, maturity, and growth.

Like the premiere of a new movie, each unique year is different, bringing with it new teachers, new students, and an array of activities and knowledge.

Although these years may often seem long and endless, they can slip away without notice.



(Above) Dr. Harris prepares his history class for a year of action and thrills. (Left) Students loosen up at the school dance after a hard day of work.



(Above - Left to Right) Annie Palacios, Monica Briones, and Misty Ellis show off their beautiful smiles as they make love to the camera.



(Left - Left to Right) Vikash Patel, Andrea Garza, Jennifer Villareal, Ana Liza Thompson, and Adrienne Bosquez, excited to be out of school, take a quick pose before they go home from a hard day's work.



(Left) All I.W.A. students believe friendships that are begun here are lasting ones. Senior Tatiana Gutierrez and Junior Stacy Probert agree.

A Piece of The Action



Top: Cathy Chopin and John Wilder enjoy each other's company at the Halloween Dance
Bottom: Chris Collins and Vikash Patel take a trip to the Olympics over their summer vacation.



When grades are on the line, these freshmen will go any length to score some bonus points for their English class.



Jessica Chodosh and Mika Matthews relax a moment before departing for a soccer tournament.



Bottom left: Doug Lane, Cathy Chopin, Jenny Vacca, Collin Bost, and Annie Ray show their talent while performing in "The Boyfriend."
Bottom right: The junior class expresses their spirit at the '96 Homecoming Pep Rally.

Now Showing

- 4-5...A Piece of the Action
- 6-7...Something to Talk About
- 8-9...The Way We Were
- 10-11...Rebel Without a Cause
- 12-13...Beautiful Girls(& Boys)
- 14-17...Last Dance
- 18-19...Toy Story
- 20-21...The Sign of the Cross
- 22-23...As You Like it
- 24-25...Gone with the Wind

Right: Crazy hat day is just one of the many ways students find to relax from the everyday hectic school life here at Incarnate Word.



Something to Talk About

Walking down the halls of Incarnate Word Academy, what do you see? People right, but what kind of people? Everywhere you look you see groups of people talking about last night's party, or last night's homework, or even other friends. The five minute passing period has turned into an episode of "Young & the Restless." People running and yelling at someone else about one-hundred yards away. You hear anything from laughing to crying, but over what? The only way to find out is to ask, unless you wait until the next period where you'll probably "accidentally" hear all about it.



Above: Senior J.J. Trevino anxiously rushes through the hall in order to be the first out of the parking lot after school.

Left: Seniors, Bryan Johnson and Michelle Northcutt converse in the halls while Ashlee Howe hides from the camera.



Left: Unable to resist Junior Brenda Valdez' sweet smile, Senior Brandon Vargas takes time out to pose with her.



Right: Chris Collins, senior, and Erin Buck, freshman, still manage to find time to socialize between classes.



Above: Friendship is what it's all about at Incarnate Word as Juniors Sierra Gill and Giovana Berastain demonstrate.

Right: Junior Ana Lopez asks herself "why?" as Mikel Abreu tries the homework problem again.



The Way We Were



The company of sophomores Robert Collins and Jason Bundick brings a smile to Junior Stacy Probert's face.



Grinning happily as they leave campus, juniors Sarah Norris and Cristin McClure take time to show their friendship.

Using bunny-ears as the universal sign of friendship, sophomores David Kubicek and Bryan Ellis relax in the company of Junior Stacey Caldwell.



Seniors Ashley Mosser, Ashlee Howe, and Marchelle Levy smile for a patriotic picture.



Juniors Judy Hanley, William Powers, and Sierra Gill strike a friendly pose during Religion class.



TOP: Juniors Adrian Romero and Alexis Fasci enjoy each other's company at a Spirit Rally.
MIDDLE: Best friends sophomores Paige McCurdy and Misty Ellis spend lunch time together at the pay phone.



Senior Nathan Marek and junior Ashley Allen are caught in a loving moment at a locker.

When you go out into the world to experience new things, explore all your options and fulfill all your dreams.

But when you make new friends you can't forget the old because although new memories are great, the past is worth more than gold.

And when searching for a friend, know just what to look for. Find someone who will care for you whether you are rich or poor, one who will stand by you through thick and thin and will defend you against others again and again.

You should look up to a friend like a sister or brother and cherish your friendship like no other. So go out and make new friends—just don't forget the old.

Because new friends may be silver, but those before them were gold.

LEFT: Senior Belissa Lippert and juniors Angela Perez and Sierra Gill take a moment to pose for a picture in computer class.

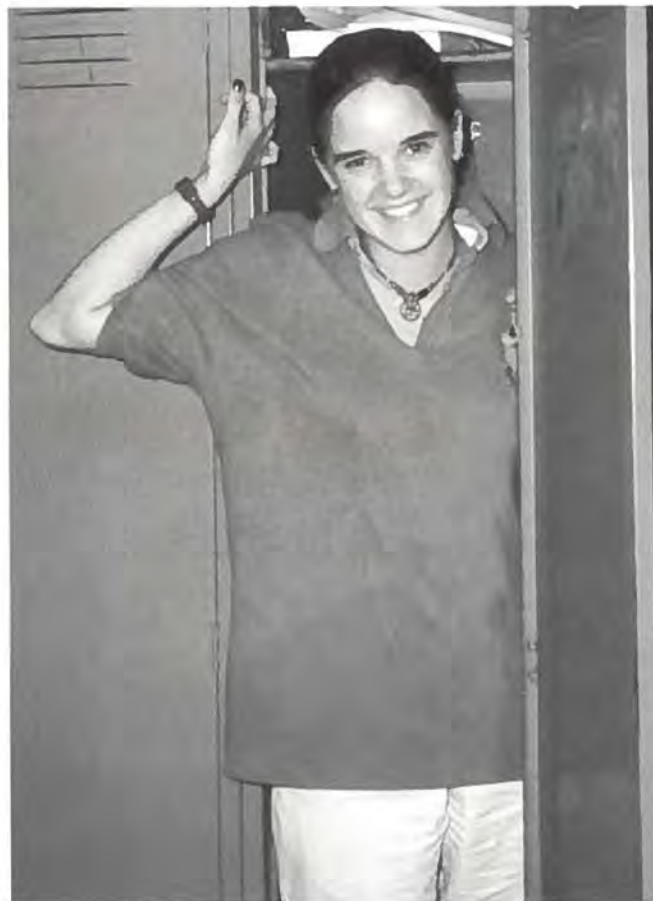

Above: Some people will go to any length to miss class. Sophomore Mika Matthews tries the old hide in the locker trick. Test next period?



Below: Rebels are individuals who do something to stand out in a crowd. In Judy Hanley's case, she prefers to monkey around rather than sit on the bench.

Rebel Without a Cause

James Dean, Fonzi, and *The Outsiders* are just a few examples of rebels. Yes, rebels. Every generation, T.V. show, and school have them. Even I.W.A. has a few rebels of its own. These are the students you see in the hallways, lunch line, and library that stand out in a crowd. Individuals, who don't mind being labeled as different, are true rebels. Members of the I.W.A. student body, such as Cyrus Mallison, Paige McCurdy, Joey Vela, and George Casey (not to mention those pictured here), are among those individuals who freely express themselves. Every rebel manages to touch the lives of the people around them and leaves a memory that will last forever.

Right: Rudy Reyes obviously wasn't expecting to be surprised by fast moving photography when we captured this one of a kind "deer in the headlight look."



Right: A Spanish class rebel, Junior Michael Hayes, displays pride when he receives a coupon from Senora McMinn. Viva, la Spanish class!



Left: Here is someone who definitely dares to be different. Corinne Walker shows off her earrings, or shall we say ear holes.



Left: Building an angelic reputation his junior year, Willie Powers was still known to be fairly mischievous at times.

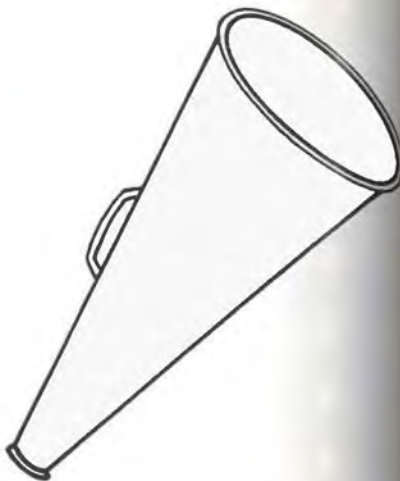

Top Left: John Wilder and Sister Martha celebrate the new mascot, emblem, and logo with a dance.

Beautiful Girls (and Boys)

Everyone, at one time or another, has the dream of being on center stage cheering. Having all eyes on you while you bring the student body alive with spirit and excitement and knowing that you're the reason that everyone is filled with such enthusiasm is the goal of all cheerleaders. Unfortunately only a few are able to be a cheerleader. "We work our hardest to encourage our fans as well as our team," said the cheerleading squad of 1997. This year being the first to have a stunt crew (the boys) has definitely proved to be the most extraordinary so far.

Left: The long hard practices pay off when it comes time to perform as Valerie Reyes demonstrates at a pep rally.



Above: The cheerleaders take a moment out of their time to pose for a picture during a basketball game.



Right: All cheerleaders need talent and spirit as Laura Kocian demonstrates at a basketball game.



As You

Like It

Favorite Musical Group

Smashing Pumpkins
Bone Thugs Live
No Doubt
Outkast



Favorite Song

Ode to My Car
The Dip
One Night At a Time
Spiderwebs
One in a Million



Favorite Car / Truck

Dodge Ram
Mustang GT
Neon
El Camino
Tahoe

Favorite Hangout

Half Price Books
Bryan & Jim's House
Mall
Beach
Drivin' Around
Corpus

Favorite Soft Drink

Coke
Dr. Pepper
Surge
Sprite
"Coastal Mug"

Favorite Cartoon Character

Winnie The Pooh
Scooby Doo
Ren & Stimpy
Bugs Bunny
Taz

Favorite Actor / Actress

Leonardo diCaprio
Sandra Bullock
Antonio Banderas
Demi Moore



Favorite Quote / Saying

"1-2..."
"Word"
"Whatever"
"As If"
"But Sister..."



Favorite Restaurant

Grandma's Gorditas
Tao Yen
Tony Roma's
Chili's
Wallbangers

Favorite Movie

Scream
Romeo & Juliet
Drop Dead Fred
Dante's Peak
Grease

As You

Like It

Favorite Musical Group

Smashing Pumpkins
Bone Thugs Live
No Doubt
Outkast



Favorite Song

Ode to My Car
The Dip
One Night At a Time
Spiderwebs
One in a Million



Favorite Car / Truck

Dodge Ram
Mustang GT
Neon
El Camino
Tahoe

Favorite Hangout

Half Price Books
Bryan & Jim's House
Mall
Beach
Drivin' Around Corpus

Favorite Soft Drink

Coke
Dr. Pepper
Surge
Sprite
"Coastal Mug"

Favorite Cartoon Character

Winnie The Pooh
Scooby Doo
Ren & Stimpy
Bugs Bunny
Taz

Favorite Actor / Actress

Leonardo diCaprio
Sandra Bullock
Antonio Banderas
Demi Moore



Favorite Quote / Saying

"1-2..."
"Word"
"Whatever"
"As If"
"But Sister..."



Favorite Restaurant

Grandma's Gorditas
Tao Yen
Tony Roma's
Chili's
Wallbangers

Favorite Movie

Scream
Romeo & Juliet
Drop Dead Fred
Dante's Peak
Grease



Above: The Star Wars craze returned in full force as senior John Wilder finds enjoyment in his movie replica of a cruiser.



Above: Freshman Jackie Salinas cuddles her bear backpack while studying after school.



Left: Junior Lindsey New holds a friend's Daffy Duck doll which she had purchased after seeing the movie Space Jam.



Left: They are not exactly toys, but Nathan Eby and Zachary Fritz have discovered a new way to pass time during a break at the junior retreat.



Right: Some students have legitimate reasons for having toys at school. Allison Davis, senior, displays her splendid birthday presents given to her by friends.



Above: Senior Laura Kocian has a toy of a different kind. Here is Laura's pet emu, Lupe.



TOY STORY

No matter what school you go to you will find these items around every corner, hanging out of backpacks or wrapped up in arms. One thing is for sure, where there are teenagers (or to be politically correct, "young adults") there will be toys. Cute, little, cuddly toys or even ugly gremlin things, either way, they are there, and as in any high school, they are here. Teachers tend to not appreciate having them around and often confiscate them. It makes you wonder about the collection of their toys at home.



The Sign of the Cross

No Catholic school would be complete without coming together as a community in prayer. Throughout the year, class and schoolwide Masses offered an opportunity for students and teachers alike to take part in planning, as well as attending, Masses. This has encouraged both spiritual growth and community involvement. The Incarnate Word tradition of the Rose Ceremony, which takes place on Ascension Thursday, allows the senior class to pass on the role of leadership to the junior class.



Left: Here the angelic choir demonstrates their excellence during the Rose Ceremony.



Right: Senior Juan Marmolejo receives communion at a schoolwide Mass.

Below left: Father Danny accepts the gifts from Bryan Johnson and Corinne Walker.

Below Right: Kim Wittliff entertains the student body by playing her harp during Mass.



Left: William Powers and Sierra Gill present Father Stembler with the gifts.

Below: This group of students prepares to receive communion.



Right: Ruben Garcia, Mari Pyle, Theresa McHugh, Ford Allen, Daphny Dominguez, and Bryan Johnson.

Below: Ford Allen and Tatiana Gutierrez.



Above: Sam Tisdale, Robert Collins, Korey Hardeman, Mika Mathews, Emily Yuras, and Monica Benavides.

Left: Patrick Horne, Ashley Allen, Dante Paiz, Candice Paiz, Adrian Romero, and Giovana Berastain.



Last Dance

No high school career would be complete without dances. To some they may be a place to let loose or relax, but for others, they are a place to make memories.



Left: Aya Aoshima, Allison Crain, Brian Sheridan, Juli Kim, and Amanda Farley.

Below: Susan Sheehan, Jackie Gillenwater, and Shannon Craft dance the night away.



Above: Jacob Kerwick, Vanessa Dunn, and Bryan Ellis get the party started with "The Train."

Right: Stacy Probert and John Wilder are given the award for School-Wide Spirit.





Mike Garcia makes a crazy face at Corinne Walker during MORP.



Wyatt Cargile "strikes a pose" at the MORP dance contest.

MORP and PROM

These two dances denote the approaching close of the school year. MORP, a time of fun and lively excitement, is a less serious spin off to Prom. On the other hand, Prom is a serious realization that this will be the last high school dance for the Seniors. All in all, these dances are quite enjoyable.



Prom Court winners: Tatiana Gutierrez, Ford Allen, Ruben Garcia, Ashley Allen, Giovana Berastain, Bryan Johnson, Dante Paiz, and Jana Muniz enjoy their special dance.

Dirty Dancing



Presenting Prom Court '97: Dante Paiz, Second Duke; Giovana Berastain, First Duchess; Ruben Garcia, Prince; Tatiana Gutierrez, Queen; Ford Allen, King; Ashley Allen, Princess; Bryan Johnson, First Duke; and Jana Muniz, Second Duchess.



Above: Willie Powers and Michelle Northcutt smile before one last dance.



Brandon Vargas slow dances with Andrea Garza.

Right: A friend, Adriana Contreras, and Matthew Scott get ready to have a fun night.



Lori Smith and Sarah Norris cherish their exciting evening.

The Goonies



(Above) Joey Vela and fellow band members take a break from their practice.

(Below) As one of their many projects, the German Club paints eggs for the Easter Tree.



John Wilder, Tatiana Gutierrez, Stephanie Gonzales, Ashley Mosser, and Laura Kocian bring students together at a pep rally.



(Left) Nike Career Club joins together for their meeting.

(Below) Juniors Mikel Abreu and Ana Lopez blow kisses to each other.



Mr. Perrone brings his Physics class together with a fun and challenging lab.



(Left) Isaac Garcia and Ed Arellano learn a few steps from a Spanish dancer.

(Right) Shannon Stacy and Rowena Apacible carefully prepare for the TAPPS competition.



Public school or private school, they all have their special "cliques". No matter what the group is, they all stick together. Although, they are all different and unique in their own way, one thing is for sure, here at I.W.A., everyone is a leader. As we have seen throughout the year, everyone dares to be (and are encouraged) different in their own personal way.



The Government class begin to learn their rules of order.

The Breakfast Club

Rudy Reyes and Tatiana Gutierrez take a break from eating during a weekly Student Council meeting.



Erin Barker and Jackie Gillenwater gossip about the latest news at lunchtime.



NOW SHOWING

- Language Clubs p. 28-29
- Thespian and Tri-M p. 30-31
- NHS and Mu Alpha Theta p. 32-33
- Group Photos p. 34-35
- Nike Career Club and JSA p. 36-37
- Octagon and p. 38-39
- Students For Life p. 40-41
- Student Council p. 42-43
- Yearbook and Newspaper



Center: Lori Smith looks on and Kristin Hall sorts through her lunch before the meeting begins.

Right: Marco Passeri shows his alertness as he prepares for the start of the meeting.



DESPERADO

Featuring: Language Clubs

This year was a great year for languages. The German club and the French club became more active. All of the language clubs tried to promote the understanding of different cultures.

They also allowed for opportunities to converse with other people in their native tongue. From fajitas to sauerkraut, it was a year of cultural development.



Those belonging to the French Club enjoy the day with French food and movies.



Emily Goodwin and Christy Kirk hang their decorated eggs on a German tree.



A Spanish dancer portrays his talent to the club.



Senora McMinn makes learning Spanish an experience for students.



The German club carefully decorates eggs using many vibrant colors.



Members of the Spanish Club group before a beautiful waterfall in Monterrey, Mexico.

SOUND OF MUSIC

Featuring: **Tri-M**

Tri-M is a club which encourages music. Tri-M, an honors society, requires the members to be in either band or choir and participate in school events. The club was sponsored by Mr. Harmon but was taken over by Mrs. Fowler during the year. Tri-M reactivated this year because of the major involvement of students in the music department. Their main objective was to perform concerts.

Mike Tabone said, "Tri-M gives me a greater appreciation of music."



The band practices to perfect their playing technique.



Jenny Vacca and Monica Briones take pride in all their performances.



The I.W.A. choir makes use of their in-class time to practice their vocalizing.



Thespian members work on an assignment.



President Kristen Barker conducts the club's agenda for the upcoming week.



The cast of "The Boyfriend" takes the stage to receive applause from the crowd.

ROMEO AND JULIET

Featuring: **Thespians**

Among the most colorful clubs at I.W.A. is the Thespian Honor Society. To become inducted into this club you must have participated in at least two plays or helped with the stage crew. The Thespian Club practices long hours to perform plays for the school. One of the major plays performed this year was "The Boyfriend" starring Kristen Barker and John Wilder. John Wilder commented, "It is the best club at the school, even though we have to wear makeup." Mike Tabone commented, "I agree."



John Wilder acts humorously with Jenny Vacca.

I.Q.

Featuring: Mu Alpha Theta

The elite in the math department belong to the math honor society, Mu Alpha Theta. The members of this organization show their mathematical capabilities in their school grades and also by being able to use deep reasoning skills. The members also participate by holding tutoring sessions for those students having difficulties with understanding math. The students also attend competitions.



Sr. Catherine passes her love of math to Mu Alpha Theta members Marsha Snapka, Matt Pyle, and Mike Tabone.



NHS members Carlos Garcia, Theresa McHugh, Matt Pyle, Mari Pyle, and Tatiana Gutierrez prepare for an induction ceremony.

WITH HONORS

Featuring: National Honor Society

The National Honor Society requires character, scholarship, leadership, service, and a 90 or above G.P.A. One of the main objectives is to tutor other students. NHS members put in a lot of time after school helping other students. Tatiana Gutierrez commented, "Being in NHS gives me an opportunity to help other students with their work."

Other objectives of NHS were producing the literary magazine and holding the award ceremony at the end of the year. NHS members have the qualities that make them stand out and serve as an example to other students.



Lindsey New, Brendan Feeney, and Joshua Oelschlegal practice their calculator know-how for upcoming competitions.

Mari Pyle offers a suggestion to the mathematical topic at a Mu Alpha Theta meeting.



President Theresa McHugh is very busy heading all the meetings.



Jennifer Montgomery and Heather Thomas help to raise money for their club through a bake sale.



NIKE



The Octagon Club



Young Democrats



MU ALPHA THETA



The German Club



Students for Life



Journalism



Junior Statesman of America



Young Republicans



National Honors Society



**STUDENT COUNCIL
(Juniors & Seniors)**



**STUDENT COUNCIL
(FRESHMEN & SOPHOMORES)**

BIG BUSINESS

Featuring: Nike

Often students are confused about various types of careers. Sooner or later we, as students, must decide what to do in life. The Nike Career Club provides answers to any questions that students may have by providing guest speakers at the meetings who talk about the professions which they have chosen. These speakers offer insight and much information on the backgrounds of their careers and capture the attention of the club's members.



A marine comes to a Nike meeting to speak about his career choice.



Nike President John Wilder understands his duties as the club's President.



An army recruiter awaits any students who are interested in his field of work.



A banker explains the education requirements to members.



The sponsor, Mrs. Guajardo, offers insights to any career-related questions proposed by the students.



John Wilder asks a question to Allison Davis and Jenny Vacca at the podium.



Jenny Vacca concentrates on the discussion topic at a JSA convention.

OUT FOR JUSTICE

Featuring: JSA

During lunch time meetings, JSA members center their focus on politics. The members had a chance to learn how the political system operates. Jorge Rodriguez said, "JSA is a fun, learning opportunity which teaches the youth of today how to be more active in the government." JSA also took trips to Austin and Houston.



JSA members take a trip to Houston for one of their many conventions.



Jorge Rodriguez finishes his lunch at one of the many important meetings of the group.

Featuring: Student Council in

Men (& Women) at Work

Student Council provides various activities and functions for the student body to become more involved. It is the voice of the students which seeks to form a common bond between them and the faculty. Many events like spirit week, prom, and other dances are ways that Student Council attempts to make school more enjoyable.

This year the Student Council arranged an exchange program with King High School. Various Student Council members from King visited I.W.A. and members of our Council returned the visit. Maureen Sheridan, senior, felt that it was a good experience but she preferred I.W.A.

The Student Council also sponsored Future Freshmen Day. Many 8th graders from several middle schools toured I.W.A. and received a dose of high school life.

These programs and others are the Student Council's way of integrating fun into school life.



Maureen Sheridan and Hillary Johnston creatively work on banners.



Theresa McHugh offers some ideas to fellow member Rudy Reyes.



Above and below: Student Council members and other clubs entertain possible future students on Future Freshmen Day.



Aya Aoshima, Dante Paiz, and Candice Paiz lend Theresa McHugh a hand during a game at the Student Council Lock-In.



Members gather together at a lock-in to share new ideas in a fun atmosphere.



Pictured from top to bottom:
Student Council Officers for the
1996-97 school year.

President Mari Pyle
Vice-Pres. Jennifer Montgomery
Secretary Tatiana Gutierrez
Treasurer Ashley Allen

THE PAPER

Featuring: The Newspaper and Yearbook

Deadlines, deadlines, deadlines. The journalism class constantly heard this word repeated by the teacher, Ms. Chambless, throughout the year. Bombarded by the many articles needed to be written, pictures to be taken, and spreads to be completed, the staff thought this endless task would remain unaccomplished. This yearbook, as well as the newspapers published, are proof that this assumption was wrong. Even though work continued even after school was out for the summer.



Desiree Valdez and John Wilder work successfully on their newspaper articles.



Corinne Walker and Andrew Rodriguez show that journalism can be fun.



Tracy Hutchinson, Andrew Rodriguez and Sadie Palmer brainstorm a new story.



Corinne Walker, Paige McCurdy, Mike Garcia, and Laura Kocian have fun with the computer.



Amanda Garza and Annie Palacios organize pictures for the yearbook.



Desiree Valdez searches for spread ideas through previous yearbooks.



The journalism class proves that it is possible to work on a Monday morning.

Editors: Lindsey New, Amelia Giovannone, Desiree Valdez, and Vanessa Roberts





(Left) Students concluded their school year by attending Project Graduation.

(Below) Maureen Sheridan and Hillary Johnston take part in a running contest at Project Graduation.



(Right) Seniors stand to receive their diplomas.

(Below) Corrie Thomsen leaves the stage proudly.



At Project Graduation, Seniors prepared for a fun-filled evening of good times and entertainment.



Matt Pyle, Joey Vanzant, and George Casey joke around before entering the auditorium.

Gone With The Wind

What are you going to do now that you've graduated?

"I'm going to Disney World!" ~ Jamie Rose ~

"I'm going to concentrate on grades in college because I slacked off so much in high school." ~ Marchelle Levy ~

"I'm going to be all that I can be ... In the Marines!" ~ Elias Green ~

"I'm going to pursue my career as an electrical engineer" ~ Corinne Walker ~



(Above) Sarah Richmond grins as she receives her diploma.

(Right) Annie Palacios carries her diploma with style.



(Above) Natalie Pena moves her tassel to the right as she graduates.



(Left) Seniors reconvene outside after Baccalaureate Mass.

Meatballs

Seniors finally achieved the right to eat meatball subs, Chinese food, tacos, or the notorious Elva's destroyer taquito on any day of the week (except for the dreaded Monday homeroom) and relished this privilege.



After basketball practice, Matt Pyle and Tony Marmalejo eat breakfast while studying diligently for their next class.



(Above) Corinne Walker, Mike Garcia, Daphny Dominguez, and Marchelle Levy, all eat a scrumptious Chinese meal together at Tao Yen restaurant.



(Right) Senior Jamie Rose smiles to the camera as he speeds out of the parking lot, ready to leave school.



(Top) Brandon Vargas, Ashlee Howe, Mike Garcia, Ford Allen, and Pat Tinning eat together at CC's Pizza.

To the left, Jenny Villarreal sometimes prefers to dine alone, especially when she has to study.



(Above) Friends, Belissa Lippert and Andrea Garza enjoy a hot lunch at Whataburger and both feel it's way better than the stuff the cafeteria serves!

Meatballs

Seniors finally achieved the right to eat meatball subs, Chinese food, tacos, or the notorious Elva's destroyer taquito on any day of the week (except for the dreaded Monday homeroom) and relished this privilege.



After basketball practice, Matt Pyle and Tony Marmalejo eat breakfast while studying diligently for their next class.



(Above) Corinne Walker, Mike Garcia, Daphny Dominguez, and Marchelle Levy, all eat a scrumptious Chinese meal together at Tao Yen restaurant.



(Right) Senior Jamie Rose smiles to the camera as he speeds out of the parking lot, ready to leave school.



(Top) Brandon Vargas, Ashlee Howe, Mike Garcia, Ford Allen, and Pat Tinning eat together at CC's Pizza.

(Above) Friends, Belissa Lippert and Andrea Garza enjoy a hot lunch at Whataburger and both feel it's way better than the stuff the cafeteria serves!

To the left, Jenny Villarreal sometimes prefers to dine alone, especially when she has to study.

“Hey You Guys! Ah ha ha!”- Sloth From the Goonies



Ford Allen



William Bannantine



Kristen Barker



Jason Beers



Adrienne Bosquez



Collin Bost



Monica Briones



Anjanette Cantu



David Caplan



Wyatt Cargile



George Casey



Christopher Collins

“Drop Dead Fred Did It!”- From Drop Dead Fred



Nimesh Dave



Allison Davis



Rachaelyn Dempsey



Daphny Dominguez



Jimmy Ellis



Matt Emerson



Clarissa Flores



Carlos Garcia



Isaac Garcia



Michael Garcia



Ruben Garcia



Andrea Garza

Goodfellas

Seniors spent their free time doing activities that ranged from cheering at the basketball games to just hanging out with their friends.



Jacob Kerwick shows off his spirit at one of the boys' basketball games.



Not only do Seniors cheer at games and hang out with friends, but they also like attending school dances as demonstrated by Monica Briones and Isaac Garcia.

Marchelle Levy and Jamie Rose pose for a pre-Homecoming picture taken at Ashley Mosser's house. Both were very excited about the very special night.



Lilia Gonzales, Natalie Pena, and Corrie Thomsen all show their support for the school play, "The Boyfriend."



Mike Garcia, Jamie Rose, Ford Allen, Rudy Reyes, Matt Emerson, and Pat Tinning are caught on film enjoying a night of rest and relaxation.



Laura Kocian, Corinne Walker, Daphny Domniguez, and Ashley Mosser get ready to go out for a night on the town.

"Luke, I am your father."-Darth Vader from Star Wars



Joseph Gonzales



Stephanie Gonzales



Lilia Gonzalez



Emily Goodwin



Elias Green



Tatiana Gutierrez



Faviola Hidalgo



Ashlee Howe



Bryan Johnson



Hillary Johnston



Daniel Keetch



Jacob Kerwick



Clarissa Flores, Sarah McDermott, Jennie Vacca, Lilia Gonzalez, and Kristen Barker painted their foreheads to show their Homecoming school spirit.

Pat Tinning shows off his "GQ" style while John McGettrick looks on with admiration.



Laura Kocian



Marchelle Levy



Ashley Lewis



Belissa Lippert



Nathan Marek



Juan Marmolejo

The Last Picture Show

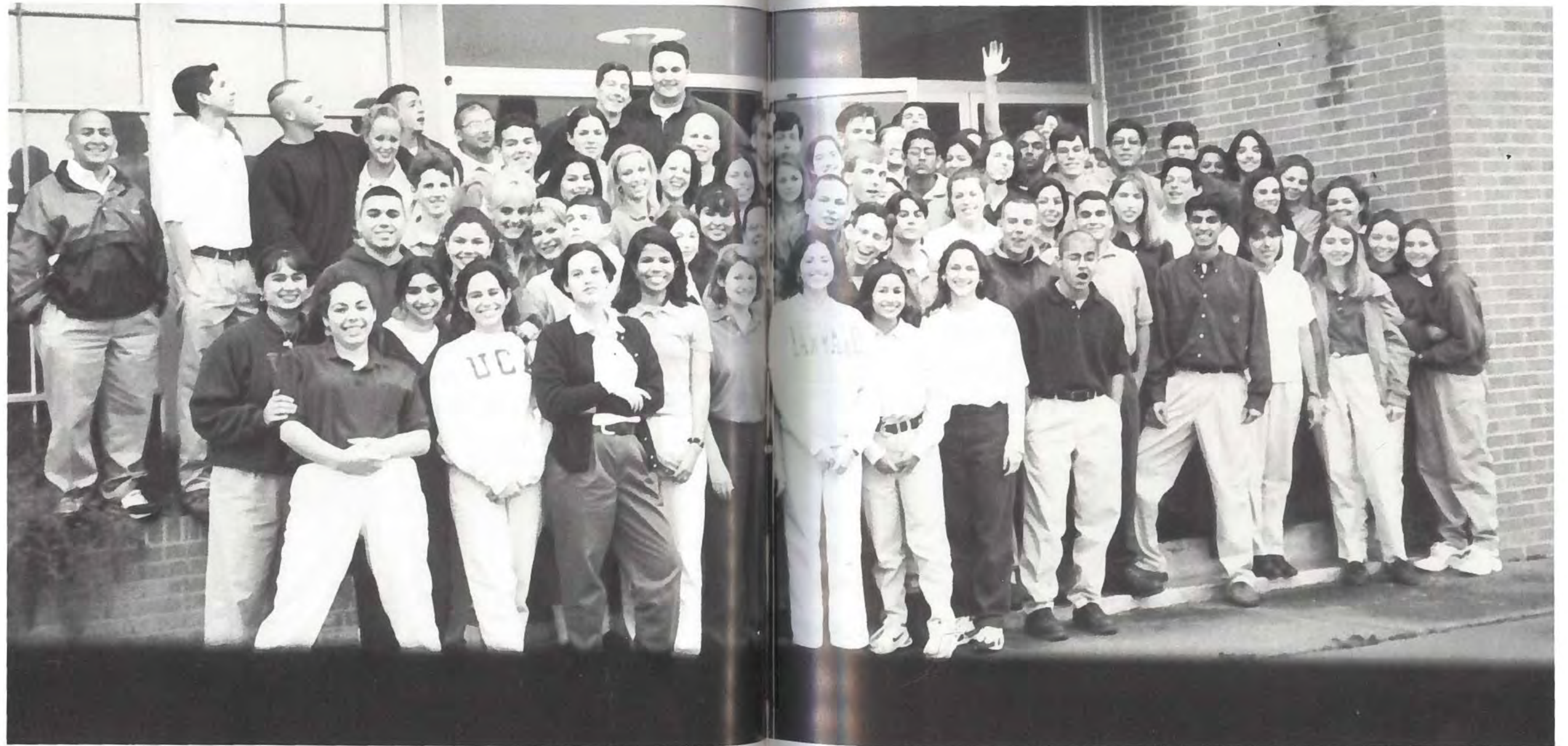



Mindy Matey



Sarah McDermott



John McGettrick



Theresa McHugh



Matt Pyle



Juanita Ramirez



Jimmy Reumuth



Rudy Reyes



Ashley Mosser



Jana Muniz



Michelle Northcutt



Annie Palacios



Sarah Richmond



Vanessa Roberts



Matt Emerson shows off his Herculean strength by climbing a pole.



Kyle Parks



Vikash Patel



Natalie Pena



Mari Pyle



Jamie Rose



J. J. Trevino works diligently on his computer in Mr. Jackson's computer science class.

“What, you think I’m funny, funny how?”-Goodfellas

The Last Goodtime

Everyone goes his/her separate way after graduation whether it be to new schools, new cities or new friends, but the high school memories will last forever. Many seniors said that they are going to miss a lot of things about high school.

As seniors remembered the past few years, memories of "good times" came to mind.....

"I'll miss Mr. Perrone's amazing ability to make time stand still."
-Patrick Tinning



Jimmy Ellis and Daniel Keetch relax in the library at the end of a day filled with brain-boggling tests.



"Chillin' in the hallways and the violation slips... Word!"
-JJ Trevino

"I probably miss my friends the most and the phrase, 'Where are we going for lunch, guys?'"
-Daphny Dominguez

"Good times and bad, I'll miss them both. Most of all, I'll miss the friendships that made high school bearable."
-Rudy Reyes, Jr.

"I will miss Dr. Harris' great acting, my friends, and walking Ashley to class through the halls of green lockers."
-Nathan Marek

"I will miss playing competitive basketball and the pep rallies."
-Matt Pyle



Joseph Saenz



Maureen Sheridan



Marsha Snapka



Michael Tabone



Corrie Thomsen



Patrick Tinning



J. J. Trevino



Jennie Vacca



John Wilder and his dog Otis spend quality time together.

(Standing) John Wilder, Matt Emerson, Ford Allen, Mike Garcia, John McGettrick, Ashley Mosser, Adrienne Bosquez, Ana Lisa Thompson, Rudy Reyes; (Kneeling) Isaac Garcia, Michelle Northcutt, Christopher Collins, Jacob Kerwick, and Vikash Patel; all pose for a picture after beating the freshmen and sophomores in the "Pig Skin Classic."



Ana Lisa Thompson



Alison Van Der Wall



Joey Vanzant



Brandon Vargas



Jenny Villarreal



Kristen Wakashige



Corinne Walker



Jennifer Wallace



John Wilder

Presenting the new Angel mascot used in the logo. Stephanie Gonzales and Tatiana Gutierrez help at a pep rally. The school revamped the logo and the seal this year.



Michael Hayes, Mica Matthews, Amelia Giovonne, Adrian Romero, and Meghan Byrne work hard in class. In-class assignments were a large part of the school day.



Presenting a report in English class, Erica Farawell works on both her writing and speaking skills.



People Section

Circle of Friends

16 Candles

Kids in the Hall

Sister Act

Right: Mark Buck, Alberto Garza, Sarah Hill, Shannon Stacy, and Rachel Williams help to decorate for Jeanne De Matel's birthday celebration.

Below: Stacy Probert works her way through the busy school halls.



Above: Dyana Kossum, Amanda Garza, and Brenda Valadez greatly enjoyed the Spanish field trip that they attended.

Circle of Friends



Left: Maria Martinez shows her beautiful smile to the camera.

Below: Adrian Rodriguez and Alexis Fasci mingle with their friends during lunch.



Left: Joey Vela and Christina Moon hang out before class begins.

JUNIORS

JUNIORS

Mikel Abreu
Randal Adams
Ashley Allen
Rowena Apacible



Fernando Araiza
Edward Arellano
Giovana Berastain
Lorie Beste



Patrick Brazell
Mark Buck
Megan Byrne
Stacey Caldwell



Jessica Chodosh
Adriana Contreras
John Detmer
Vanessa Dunn



Nathan Eby
Alexis Fasci
Zachary Fritz
Alberto Garza



Amanda Garza
Sierra Gill
Amelia Giovannone
Rene Gonzalez



Aubrey Goodrich
Mysti Grant
Joseph Guernsey
Karina Guerra



Judy Hanley
David Hart
Michael Hayes
Brandon Hewitt



Sarah Hill
Patrick Horne
Tracy Hutchinson
Sathesh Janaki



Christy Kirk
Dyana Kossum
Curtis Laich - Rock
Susan Lawrence

Ana Lopez
Adrianna Lynch
MariaMartinez
Cristin McClure



Jennifer Montgomery
Cristina Moon
Ben Narvaez
Lindsey New



Sarah Norris
Candice Paiz
Dante Paiz
Sadie Palmer



Angela Perez
Marina Pineda
William Powers
Stacy Probert



Valerie Reyes
Andrew Rodriguez
Jorge Rodriguez
Adrian Romero



JUNIORS



Left: Susan Lawrence, Christina Moon, and Amanda Garza enjoy their religion class.



Above: Angela Perez plays with her hair, while working on her Spanish.

RUTHLESS PEOPLE

Spitting, biting nails, smacking gum...everyone has a bad habit or two. Part of what makes bad habits so terrible is the fact that they are almost impossible to break. Bad habits can be small and harmless and others can be more serious.

"My bad habit is that I am a perfectionist," said Patrick Horne. "I procrastinate," said Willie Powers.

Some bad habits may be simply personality quirks that are funny or even endearing. "I think that people who play with their hair should just cut it off," said one student.

But no matter how bad a bad habit may be, there is always hope that it will cease someday.



Matthew Scott
Andrew Sengler
Susan Sheehan
Lori Smith



Susan Smith
Shannon Stacy
Trey Stearns
Travis Theriot



Heather Thomas
Brenda Valadez
Desiree Valdez
Joey Vela



Rachel Williams
Kimberly Wittliff



JUNIORS

Class Act

School-work is hard enough without having to worry about how you are going to cope with next year, but that's exactly what most juniors are doing. These worries include placement in AP and honors courses, college applications and acceptances, and taking the SAT. To handle all of that plus keep your grades up causes a great deal of stress during your junior year.

The majority start investigating colleges by the spring of their junior year, and by the time their senior year rolls around they have a pretty good idea of where they want to go and what classes they have to enroll in to be accepted. The same goes for the SAT. Very few people start their senior year without having taken the SAT at least once. This gives people a good idea of what areas they need to work on to bring up their scores.

With good time management, juniors can take some of the pressure off their senior year and keep up with their regular work at the same time.



Left: Shannon Stacy and Rowena Apacible study together after school.

Class of 1998



Matthew Scott
Andrew Sengler
Susan Sheehan
Lori Smith



Susan Smith
Shannon Stacy
Trey Stearns
Travis Theriot



Heather Thomas
Brenda Valadez
Desiree Valdez
Joey Vela



Rachel Williams
Kimberly Wittliff



JUNIORS

Class Act

School-work is hard enough without having to worry about how you are going to cope with next year, but that's exactly what most juniors are doing. These worries include placement in AP and honors courses, college applications and acceptances, and taking the SAT. To handle all of that plus keep your grades up causes a great deal of stress during your junior year.

The majority start investigating colleges by the spring of their junior year, and by the time their senior year rolls around they have a pretty good idea of where they want to go and what classes they have to enroll in to be accepted. The same goes for the SAT. Very few people start their senior year without having taken the SAT at least once. This gives people a good idea of what areas they need to work on to bring up their scores.

With good time management, juniors can take some of the pressure off their senior year and keep up with their regular work at the same time.



Left: Shannon Stacy and Rowena Apacible study together after school.

Class of 1998



Sixteen Candles



Right: Sophomore boys exhibit team work as they participate in Game Day.

Below: Sam Tisdale and Lauren Gonzales look on as Mrs. Quintero explains a lab assignment.



SOPHOMORES



Fernando Casals is "making his power for good felt" as he spends class time busily studying.



Above: Kerith Vara does her share by making up a test.



Above: Jackie Hallmark socializes at the Welcome Dance.



Left: Kelly Caldwell shows how much fun Senora Passeri's class can be.

Jesse Anzaldua
 Carlos Araiza
 Ernest Arellano
 Erinn Barker



Mary Beck



Monica Benavides



Jason Bundick



Gerry Caballero
 Kelly Caldwell
 Jonathan Carlson
 Fernando Casals



Mika Matthews, Cathy Chopin, and Barbara Schauer discuss History with Mrs. Keramian.

What is your favorite memory of the year?

Kristen Dill: "My Spring Break trip to Disney World!"

SOPHOMORES



Nichole Cassiano
 Catherine Chopin
 Heather Clark
 Robert Collins



Armando Mendez surveys the scene at the Welcome Dance.



Shannon Craft
 Sarah Cruise



Frankie Davila
 Hunter Dean



Kristen Dill
 Bryan Ellis



Misty Ellis
 Leslie Escobedo
 Andrew Farias
 Brendan Feeney

Carlos Flores
Joseph Flores
Molly Fritz
Arnie Garcia



Carlos Garcia
Sergio Garza
Jackie Gillenwater
Adrian Gonzales



Lauren Gonzales
Casey Graham
Elizabeth Green
Amber Guernsey



Kristin Hall
Jacquelyn Hallmark
Korey Hardeman
Micheal Heinz



Nicole Jaimes
Albert Juarez
Kallieste Koclanes
David Kubicek

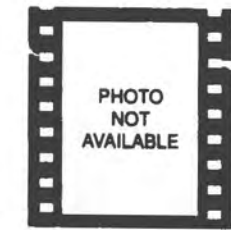

Juan Landivar
Katy Lee
Sophia Lee
Jeremy Long

Manuel Marcias
Matthew Markel
Raphaela Martinez
Mika Matthews

Paige Mc Curdy
Armando Mendez
Leslie Meyer
Joshua Oleschlegal

Jason Bundick, Emily Yuras, and Bryan Ellis show off their first drivers' licenses.

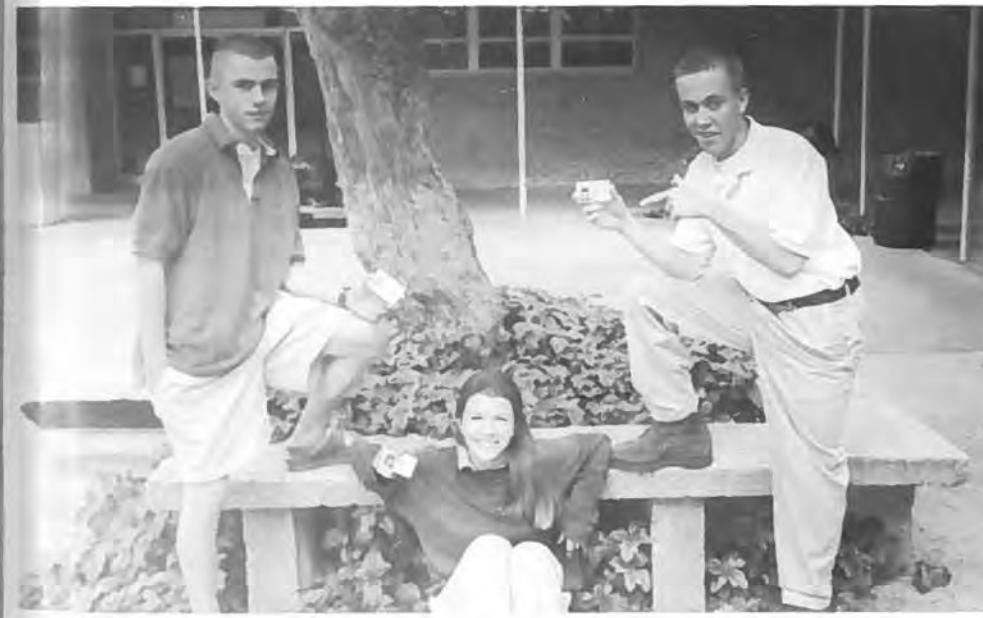

Now that you have your driver's license, do you feel that you have more freedom?

“ Well it's great until you become the official go-for.”- Armi Pigott

SOPHOMORES

Guy Palmer
 Marco Passeri
 Margie Perez
 Armi Pigott



Annie Ray
 Clare Renfro
 Trevor Rosen
 Doni Sambitan



Barbara Schauer
 Judith Sheridan
 Greg Smith
 Steven Snapka



Lizette Solis
 Kristin Tedesco
 Sam Tisdale
 Brandon Trevenio



Kerith Vara
 Susan Wardle
 Emily Yuras



Left: Good friends, Kristin Hall and Shannon Craft, joke around at the Clay Walker concert.



Above: Kelly Mc Gettrick and Emily Yuras prove that freshmen can have older friends.

Left: Cathy Chopin expresses her happiness after receiving her awards.

SOPHOMORES

What is your favorite memory of the year?
 Mika Matthews: "The dance contest at MORP, and Wyatt's (Wyatt Cargile, Senior) disco costume."

Kidz in the Hall



Sarah England, Kathryn Tabone, Araceli Garcia, and Deanna Garcia perform a talk show episode featuring the women from Great Expectations.



Above: Sarah Steele seems to enjoy her chat with a representative from a travel agency regarding a trip to Australia.



Douglas Lane stands at attention for the camera during a presentation on Les Miserables.



Left: Looking none too happy, Desiree Garza waits in her desk for class to start.



Juli Kim smiles brightly, a sure sign of a great day.



This picture makes one wonder exactly what Ben Jung had to do to complete his book report for Freshman English!



Eric Rodriguez spends his spare time bonding with a pole.

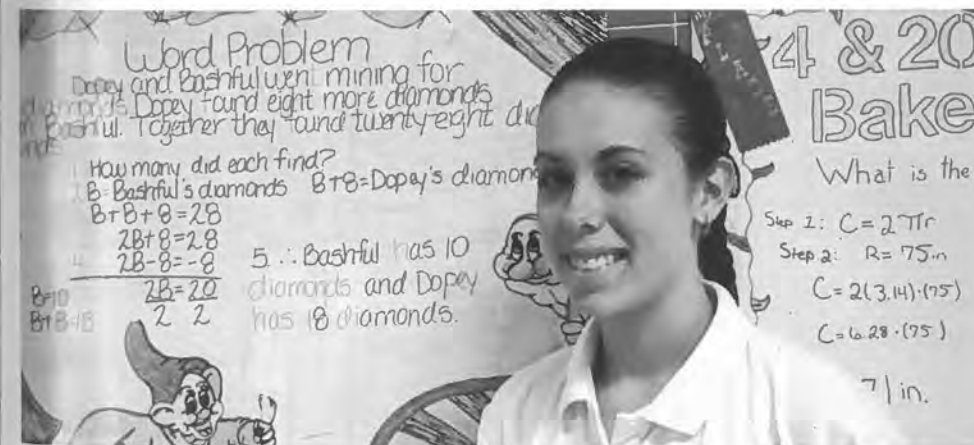

Natalie Cantu stands proudly next to her prize-winning math poster during Math Week.

FRESHMEN

Taylor Allen
Cruz Almaguer
Aya Aoshima
Dolores Alvarez



Roxana Apacible
Amanda Austin
Erin Barker
John Barrett



Elaina Barroso
Bonnie Bell
Erin Buck
Alfredo Canales



Natalie Cantu
Adrianna
Castaneda
Charlotte
Castaneda
Timothy Castillo



Min Choe
Kevin Cochrum
Dorian Cordero
Allison Crain



Sarah Darby
Babis Davila
Melynda Duncan
Erica Duran



Thomas Emerson
Brock England
Sarah England
David Escobedo



Erica Farawell
Amanda Farley
Laurel Franck
Lisa Gamble

FRESHMEN



Cyrus Mallison hangs out with the other participants last summer at the annual Renaissance festival.

Renaissance Man

Daring sword fights, maids, kings, and queens: these are all things we think of when the word Renaissance is mentioned. Some people think that this time in history is so noteworthy that they feel they need to reenact it. This is the case with Cyrus Mallison, a freshman who finds the Renaissance to be a very interesting time.

Cyrus and his family all love the Renaissance so much in fact, that they travel to the big Renaissance festival north of Houston every year. Cyrus usually dresses as Robin Hood, a favorite character of his. This, however, has gotten him into trouble once or twice. One time there was a "warrant" out for the arrest of the park's Robin Hood, and someone mistook Cyrus for the wanted man!

By: Desiree Valdez



Crybaby

As any freshman will attest to, being a fish is no fun. It means being the one who is always picked on, teased, and looked down upon. But most freshmen take it without too much fuss, accepting the fact that whatever they do, the teasing isn't going to stop. They look forward to next year when a new batch of fish will come in for them to harass, carrying on a tradition that has spanned generations of IWA students. Being a fish means being teased, as every freshman knows, and the only thing to do is hold on and wait until the year ends.

Deanna Garcia does not mind a little good-natured teasing every now and then.

Araceli Garcia
Deanna Garcia
Desiree Garcia
Jacqueline Garza



Kristen Garza
Michelle Garza
Yolanda Gomez
Elizabeth
Gongora



P. J. Gonzales
Tonia Gonzalez
Charles Gover
Renee Harris



Monique Herrera
Matthew Hoffer
Erin Irving
Ben Jung



Juli Kim
Cassie
Kirkpatrick
Stephanie
Klaneckey
Tiffany Kolaya



Ashley Kotara
Douglas Lane
Kelly Laudadio
Elizabeth Liska



Gabriella Lozev
Cyrus Mallison
Austen Marek
Miguel Martinez



Andrew Matey
Shannon
McCleary
Maureen
McClure
Kelly McGettrick

FRESHMEN

Larissa Mercado
Sarah Meyer
Seth Moore
Sheila Murray



Jeremiah
Narvaez
Al Pena
Ann Rinaldi
Yvonne Rio



April Rodriguez
Eric Rodriguez
Rene Rodriguez
Cameron Romer



Marie Saenz
Candace
Saldivar
Jackie Salinas
Aaron Sanders



Anthony
Sheldon
Brian Sheridan
Sarah Steele
Christi
Strickland



FRESHMEN



TIME
TO
HIT
THE BOOKS



Kathryn Tabone
P. Michael
Thamaravelil
Adam Thurman
Michael Tijerina

Celeste Torres
Hillary Wilder
Elizabeth
Zampikos

The Freshman

High school is a lot different than middle school, a fact that all freshmen learn pretty quickly. There are quite a few new things to adjust to such as: a larger school, more demanding

classes, more homework, and, of course, the perpetual teasing. But, despite all of these changes, most freshmen adjust pretty quickly to high school life. They come to enjoy the increased sense of responsibility that comes with it and look forward to their new experiences.



Gabriella Lozev and Kathryn Tabone look grim as they contemplate the amount of homework that they have.



FACULTY

Sr. Martha O'Gara
Principal
Sr. Henri Amador
Mrs. Elvia Barregarye
Sr. Catherine Brehony



Sr. Patricia Ann Burns
Mrs. Clelia Casey
Mrs. Isabel Cavazos
Miss Marie Chambless



Mr. Robert Dodd
Sr. Eileen Doherty
Ms. Colleen Duzich
Miss Mary E. Espinosa



Mrs. Kathleen Fowler
Mrs. Angela Garcia
Mr. Reynaldo Garcia
Dr. Judith Marie Saenz



Mrs. Cecilia Guajardo
Dr. Timothy Harris
Mrs. Andrea Hasse
Mr. David Hemphill



Sr. Martha O'Gara: Principal; Sr. Henri Amador: World Geography, Religion III; Mrs. Elvia Barregarye: Biology I; Sr. Catherine Brehony: Algebra II, Calculus; Sr. Patricia Ann Burns: English II, Religion II & IV; Mrs. Clelia Casey: English IV; Mrs. Isabel Cavazos: Counseling; Miss Marie Chambless: Practical Writing, Journalism, English I; Mr. Robert Dodd: Basketball, PE; Sr. Eileen Doherty: Religion I & II, English II; Miss Mary E. Espinosa: Algebra I; Mrs. Kathleen Fowler: German I & II, Choir; Mrs. Angela Garcia: Registrar; Mr. Reynaldo Garcia: U.S. History, Health, Baseball; Dr. Howard German: English IV; Mrs. Cecilia Guajardo: Guidance; Dr. Timothy Harris: Humanities, World History, Religion III&IV; Mrs. Andrea Hasse: Radio TV, Theatre Arts, English I; Mr. David Hemphill: Basketball; Sr. Lou Ella Hickman: Library; Mrs. Gail Huie: Latin I, II & III; Mr. Herman Jackson: Computer Science, Computer Applications, Key Boarding; Mrs. Marianne Jackson: Library; Mrs. Anne Keehan: Geometry, Algebra I; Mrs. Evon Kelly: English III; Mrs. Gayle Keramian: Government/Economics, U.S. History; Sr. Mary Ann Korczynski: Algebra II, Geometry; Mrs. M. Elena McMinn: Spanish II, III & IV; Mrs. Virginia Passeri: Spanish I; Mr. Raymond Perrone: Physics, Trigonometry/Analysis, Pre-Calculus; Mrs. Sandra Quintero: Chemistry I & II; Mrs. Lynda Richter: Secretary; Sr. Judith Marie Saenz: Religion I, III & IV; Mrs. Adrien Shelton: Art/ Drawing; Mrs. Nancy Sulik: French I, II & III.



Sr. Lou Ella Hickman
Mrs. Gail Huie
Mr. Herman Jackson
Mrs. Marianne Jackson



Mrs. Anne Keehan
Mrs. Evon Kelly
Mrs. Gayle Keramian
Sr. Mary Ann Korczynski



Mrs. M. Elena McMinn
Mrs. Virginia Passeri
Mr. Raymond Perrone
Mrs. Sandra Quintero



Mrs. Lynda Richter
Mrs. Adrien Shelton
Mrs. Nancy Sulik
Dr. Howard German

Sister Act... & Company



Sr. Martha works diligently as usual, but still manages to keep a happy face.



Though calculus is a difficult subject, both Sr. Catherine and Vanessa Roberts seem to have no trouble understanding it.



Mr. Perrone shows off his scientific expertise as Kristen Wakashige and Hillary Johnston look on.

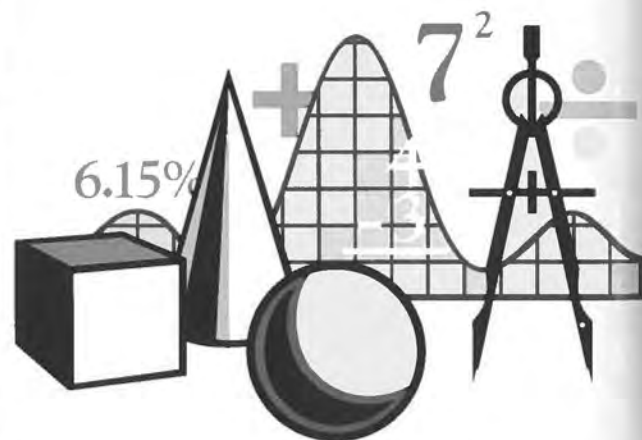

Mrs. Keramian helps an A.P. student with her work.



Dr. Harris and Mrs. Kelly seem to be enjoying their lunch in the teacher's lounge.



Mr. Jackson watches closely as his computer students do their work.



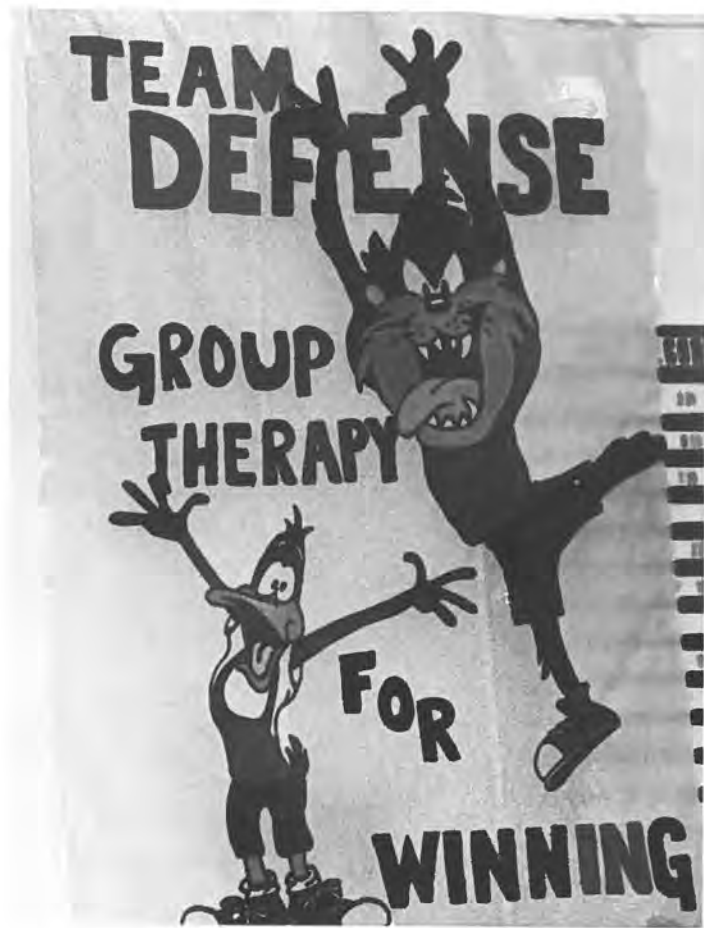

The Program

Sports

Cross Country	pg. 98
Angels Soccer	pg. 100
Lady Angels Soccer	pg. 102
Angels Basketball	pg. 104
Lady Angels Basketball	pg. 106
Angels Baseball	pg. 108
Angels Track	pg. 110
Angels Tennis and Freshman Basketball	pg. 111

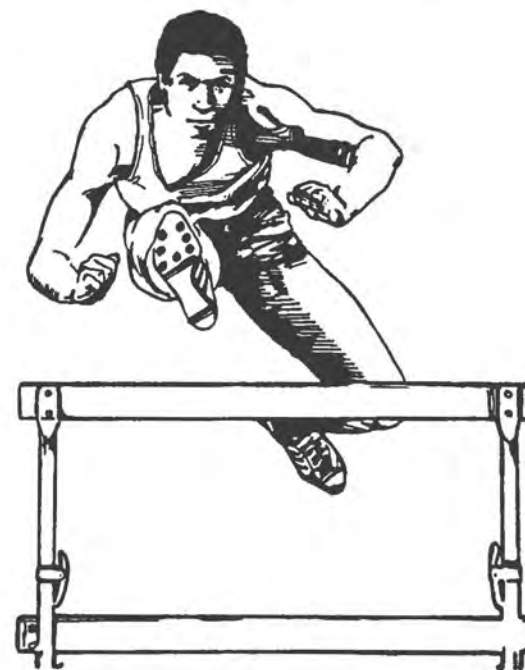

State Meet Results

3rd - Dante Paiz
 4th - John McGettrick
 11th - Ruben Garcia
 30th - Chris Collins
 31st - Matt Pyle
 36th - Curtis Laich
 42nd - Mikel Abreu

20th - Amber Guernsey
 26th - Mari Pyle
 30th - Judy Sheridan
 34th - Kristen Wakashige
 42nd - Lauren Gonzales
 49th - Erica Duran
 61st - Jana Muniz

Sophomore Judy Sheridan runs by the competition on her way to a third place finish for the Angels at the River City Cross Country meet.



The Lady Angels jumped out to a good lead early in the race and stayed strong through the end. The girls placed second overall in the River City meet.



Senior Mari Pyle extends her lead as she climbs a hill at the River City Cross Country meet.



Cross Country

CHARIOTS OF FIRE

Angels Burn the Competition

The boys' cross country team of 1996-97 had an outstanding performance at state. Six of seven runners revisited Waco for the most important three mile race of the year. Battling against the cold wind, the Angels proved that practice pays off. Their overall third place finish was led by Dante Paiz and John McGettrick, who earned third and fourth places, respectively. Their exceptional

performance, along with good finishes by Ruben Garcia, Matt Pyle, Chris Collins, Curtis Laich-Rock, and Mikel Abreu, placed IWA among the top three schools in the state in TAPPS for cross country.



Slow and steady wins the race. The cross country team gives their all in every race.



On his way to his first All-State award, Junior Dante Paiz runs to a third place finish. Dante ran a personal best of 16 minutes and 47 seconds at the State Cross Country Meet.



Mikel Abreu shows off his stuff at the state meet on his way to a 42nd place finish.



HOT SHOT

In past years, the Angels soccer team has fallen short of the playoffs. The Angels' well-rounded group ended the post-season drought by taking the team to regional competition. Kyle Parks, John McGettrick, and Jamie Rose, all experienced players, led the team and increased everyone's level of play.

The Angels got off to a good start when they took second place in the Annual Round Rock

Tournament. The Angels had to battle against injuries, grades, and new comer Rudy Reyes' red card. The players proved to be a strong team as their season came to a close at regionals with a 10-3-1 record. The team included Mark Buck, Ben Narvaez, Travis Theriot, Mikel Abreu, Korey Hardeman, Frankie Davila, Carlos Flores, Aaron Sanders, Alfredo Canales, P.J. Gonzales, Jeremiah Narvaez, John Barrett, and Taylor Allen.



1997 Angels Soccer Team: Standing: John Barrett, Taylor Allen, Carlos Flores, Mikel Abreu, Jamie Rose, Travis Theriot, Frankie Davila, and Ben Narvaez; Kneeling: Aaron Sanders, Alfredo Canales, Korey Hardeman, Kyle Parks, John McGettrick, P.J. Gonzales, and Jeremiah Narvaez. (Not pictured Rudy Reyes)

Coach Garcia and John McGettrick graciously accept a well-earned trophy.



Mikel Abreu fakes out a Shady Grove defender.



The Angels huddle around Coach Garcia for a pep talk and a break before the action resumes.



Jeremiah Narvaez slams on the brakes to avoid an opponent's slide tackle.

John McGettrick boots the ball down field with all of his might.



LADYBUGS

This year the soccer program extended itself and created the first ever IWA girls soccer team. Anne Davila stayed with the girls after the summer began last year to work with their soccer skills. They began the city league season in October where their outstanding performance led them to a city championship. The Lady Angels also played in TAPPS in which the competition was much more difficult. The Lady Angels would have continued their season into the play offs, but

because the Angels were a new team TAPPS rules prohibited the Angels from competing in post season play. The team consisted of Jessica Chodosh, Ashley Allen, Sarah Hill, Vanessa Roberts, Mika Mathews, Sarah Darby, Erin Buck, Babis Davila, Ann Rinaldi, Allison Crane, Emily Goodwin, Lilia Gonzales, Laural Franck, Erin Irving, Kim Witliff, Maria Martinez, Monique Herrera, Larissa Mercado, Maureen McClure, and Gabriella Lozev.



1997 Lady Angels Soccer Team: (Back) Babis Davila, Lilia Gonzales, Allison Crain, Gabriella Lozev, Emily Goodwin, Maureen McClure, Mika Mathews, Monique Herrera, Maria Martinez, Jessica Chodosh, (Middle) Larissa Mercado, Ashley Allen, Sarah Hill, Ann Rinaldi, Kim Witliff, Vanessa Roberts, (Front) Erin Buck, and Sarah Darby.

Below: Erin Buck moves down the field.



Ashley Allen makes a great steal during the Angels 2-0 victory against TMI.



Allison Crane breezes past a Houston defender on her way to the goal.



Above: Mika Mathews catches air while trying to trap the ball.

Left: Babis Davila keeps a TMI defender at bay.

(Right) Ford Allen leaps skyward as he takes the ball to the basket against Central Catholic.



(Above) The Angels Varsity Team huddles before the tip-off at the state competition in Waco.

(Right) (Back) Isaac Garcia, Matt Emerson, Curtis Laich-Rock, Tony Marmalejo, Matt Pyle, Ford Allen, (Front) Korey Hardeman, Kyle Parks, and John McGettrick display their first place trophy in the Calallen Tournament.



The Basketball Diaries

The Angels started their season against King High School. They fought hard, but came up short (most of the King players were huge, far outsizeing the Angels). This did not stop the "mighty Angels." They continued playing hard, and later proved victorious against the Ray Texans in what was perhaps the most memorable game of the season. The Angels won by one point in overtime, where Kyle Parks made two free throws to help the Angels move ahead. The Angels added to their accomplishments as they won district and headed up to Waco for the state tournament on February 20. The Angels again fought hard, but still came up short, (especially when compared to Southern Baptist's 6'10 player!). The Angels had an outstanding season and finished with a record of 21-14.

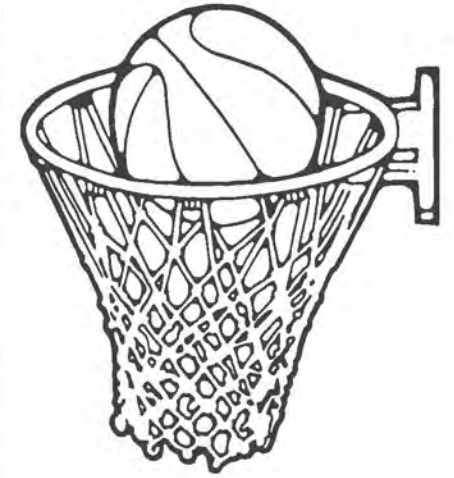

Korey Hardeman outmaneuvers a Gregory-Portland defender.



The 1996-1997 Angels Junior Varsity Team: (Back) David Kubicek, Marco Passeri, Sergio Garza, Jesse Anzaldua, John Detmer (Center) Stephen Snapka, Joseph Flores, Guy Palmer, Andrew Farias, Juan Landivar, (Front) Robert Collins, Jason Bundick, Fernando Araiza, Jeremy Long, and Carlos Araiza.

(Right) Lauren Gonzales stops shooting her free throws for a second to pose for a picture.



(Above) Belissa, Juanita, and Jana even eat as a team!

The 1996-1997 Lady Angels Junior Varsity Team: (Back) Heather Clark, Barbara Schauer, Kristen Dill, Shannon Craft, Monica Benavides, (Front) Marina Pineda, Lauren Gonzales, and Adriana Contreras.



Hoop Dreams

The Lady Angels started their season against King and played well. This season, a rebuilding year, was successful. The team worked hard going from a group of individuals to a strong, bonded team. The Lady Angels made it to regionals and placed second in district. They ended the year with a record of 20-10.

Mari Pyle made first team All-State. Karina Guerra, Sierra Gill, and Judy Sheridan made first team All-District, and Jana Muniz earned an honorable mention in All-District.

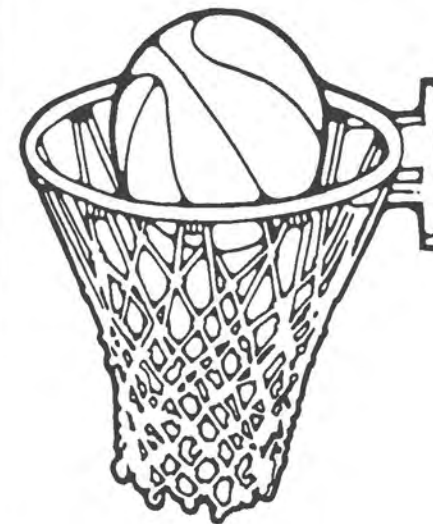

(Above) The 1996-1997 Lady Angels: (L-R) Judy Sheridan, Mari Pyle, Erica Duran, Amber Guernsey, Sierra Gill, Jennifer Montgomery, Karina Guerra, Juanita Ramirez, Jana Muniz, Belissa Lippert, and Anjanette Cantu.

Angels In the Outfield

The Angels Baseball team got off to a rocky start. However, they proved their talent in the Lake Travis Tournament where they won their first game 3-2 and their second 12-4. They would have continued their great streak, but got rained out. Altogether, the Angels had a great year and the school is proud of their accomplishments.



Trey Stearns and Patrick Horne glanced toward the pitcher before the game began.



The Angels jog to the dugout to prepare for an offensive attack.



(Left) The 1996-1997 Angels Baseball team: (Back) Sam Tisdale, Matt Marco, Andy Gutierrez, Bryan Johnson, Joseph Saenz, Trey Stearns, Brandon Trevino, Brian Brazell, Rudy Reyes, (Front) Bryan Ellis, P.J. Gonzales, Taylor Allen, Jeremiah Narvaez, and Casey Graham.

(Below) Rudy Reyes sits, dedicated to keeping up with each player's statistics.

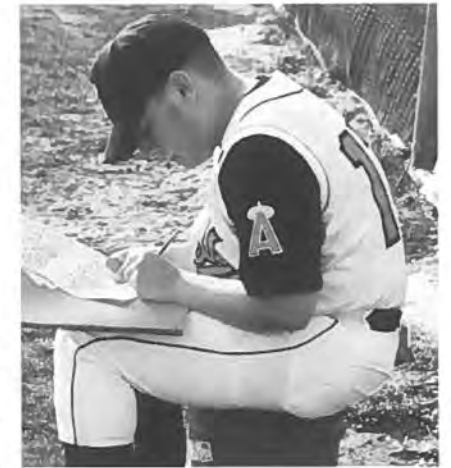

(Above) Patrick slides home, knocking down the catcher in the process.

(Left) Brandon hurls the ball toward the infield.

Chariots of Fire

The 1997 Angels track team had a very successful year. Many members qualified for state and competed at Baylor on May 2nd and 3rd.

For the Lady Angels: Shannon Craft placed 2nd in discus, Kristen Wakashige placed 4th in the 100 meter hurdles and 5th in the 300 meter hurdles, Amber Guernsey finished 8th in the 800 meter run, and Sierra Gill placed 5th in the 100 meter dash. The 400 meter team of Kristen Wakashige, Judy Sheridan, Amanda Farley, and Sierra Gill placed 6th. The mile relay team of Judy Sheridan, Sierra Gill, Natalie Cantu, and Amber Guernsey placed 5th.

For the Angels: Dante Paiz placed 4th in the 2 mile run and 5th in the mile run, and John McGettrick finished 4th in the 800 meter run. The 400 meter relay team of Korey Hardeman, Stephen Snapka, Curtis Laich-Rock, and Robert Collins took home 5th place. The Angels one mile relay team of Korey Hardeman, Robert Collins, Curtis Laich-Rock, and John McGettrick placed 6th.

(Below) John McGettrick and Robert Collins breeze past a Central Catholic runner.



(Right) Amber Guernsey runs her best in the relay.



(Far Right) Kristen Wakashige fearlessly bounds over a hurdle.



(Right) Sierra Gill gives her all in every race.



(Left) The 1996-1997 Angels Tennis team: (Back) Coach Dave Cook, Sathesh Janaki, Fernando Casals, Nimesh Dave, Theresa McHugh, (Front) Kelly McGettrick, Elizabeth Gongora, and Yvonne Rio.

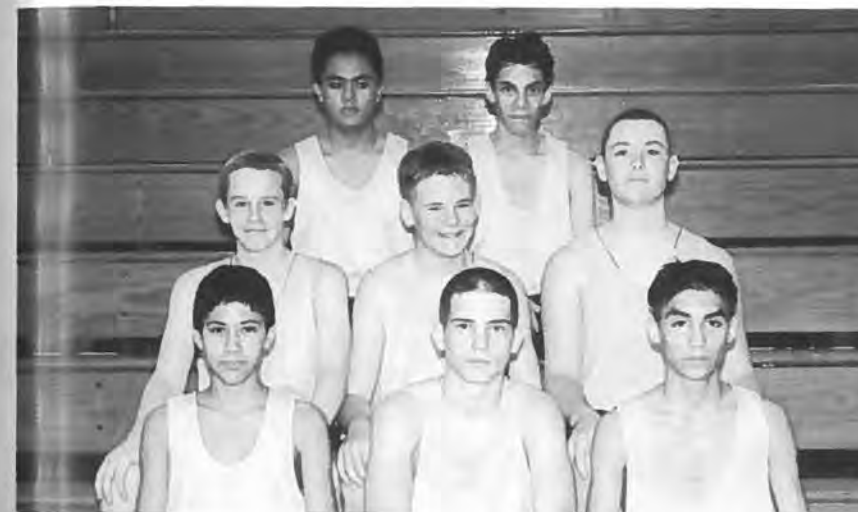

(Center) The 1996-1997 Angels Freshman team: (Back) Dorian Cordero, Tim Castillo, (Middle) Matthew Hoffer, Thomas Emerson, Kevin Cochrum, (Front) Rene Rodriguez, Brian Sheridan, and Al Pena.



(Left) The 1996-1997 Lady Angels Freshman team: (Back) Aya Aoshima, Tonia Gonzalez, Natalie Cantu, Celeste Torres, Lisa Gamble, Bonnie Bell, (Front) Erica Farawell, Amanda Farley, Melynda Duncan, and Shannon McCleary.



Don't crowd the bottom: Freshmen, Juli Kim, Allison Crane, and Alfred Canales, work to finish the Jesse Tree for Advent.

"Excuse me, were trying to learn here!" Michael Heinz, sophomore, tries to subtly hint at our camera person the importance of his education.



"Doe, a deer, a female deer?" Mrs. Fowler's third period choir class takes a breather between songs.

Our fearless leader, Sr. Martha O'Gara tries her best everyday to make sure our educational experiences run smoothly.



Higher Learning



Seniors get down and dirty! Michelle Northcutt and Daphny Dominguez finish their art work.

Right: Strike a pose! Paige McCurdy works her best to get pictures made for Journalism.



Now Showing

- 114-115 *Fantastic Voyage*
- 116-117 *Eyes of an Angel*
- 118-119 *Teachers*
- 120-121 *Daze of Thunder*
- 122-123 *The English Patient*
- 124-125 *Pressure Point*



Sarah Darby and Sheila Murray act out a fight scene from "Romeo and Juliet."



Carlos Garcia and Joseph Saenz discuss and ponder over their Calculus homework.

Paige McCurdy is busy collecting negatives for the yearbook and the newspaper. If you think this is easy we've got news for you.



Students in this World Geography class are caught red-handed (Gasp!) doing work!



In band class Douglas Lane dazzles Erin Irving and Joey Vela with his piano playing prowess.



After a tough day in P.E., Coach Dodd's students collapse on the gym floor.

FANTASTIC VOYAGE

What is your favorite class and why?



Sophomore Trevor Rosen enjoys English because he "understands it, and the class is not boring."



Freshman Elizabeth Liska likes taking English with Mrs. Hasse because she makes it fun.



Freshman Sara Meyer gets into History and learns about the past and other events.



Junior Maria Martinez's favorite subject is Chemistry.



Sophomore Mike Heinz enjoys studying about Physical Science.

EYES OF AN ANGEL

As students of I.W.A., we tend to see things differently than our teachers. When we think of our school, we think back on our good friends and the fun we had. Our good times together are really what high school is all about: from the laughs with our true friends to the times when we lost our voices yelling for the team; from falling in love and dating to breaking up and fighting; from staying up all night on the phone to staying up all night cramming; through the eyes of Angels, we've seen all this.

It's our memories and good times that we will cherish, not our SAT scores, but our time together. So, as another year passes us by and another senior class walks out the door to become "adults," we will never forget I.W.A.



Above: Vanessa Roberts makes her power for good felt by helping Kim Wittliff gather her belongings.

Below: **Hillary Johnston works hard on her computer at home to finish her class assignment.**



Above: Sarah England helps out at the office by filing papers.



Left: Lilia Gonzales does her part by cleaning up the computer room for work study.

Right: **Mysti Grant exemplifies Angel Spirit by helping her friend Maria Martinez to finish her home work.**



Above: Desiree Valdez is caught taking a picture of some mysterious person.

TEACHERS

Who is your favorite teacher and why?



Junior Susan Sheehan's favorite teacher is Mrs. Kelly, because "she challenges me."



Dr. Harris receives Senior David Caplan's vote for favorite teacher.



Freshman Tiffany Kolaya shows her disappointment when Mr. Harmon, her favorite teacher left.



"Coach Garcia makes learning fun," according to Junior Stacy Probert.



Freshman Tonia Gonzalez likes Sister Eileen because she cares.



Those not fortunate enough to have him for a class miss out when Mr. Perrone delights some of his students by playing the guitar.



Students at I.W.A. consider Dr. Harris to be one of the most colorful teachers on the entire campus.



Sr. Catherine pauses for a moment to reflect on her day.



Mrs. Shelton prepares for her art classes by cutting paper.

The student body anxiously awaits for Coach Hemphill to say something, perhaps to sing his rendition of R-E-S-P-E-C-T.





Sathesh Janaki releases some stress after taking one of his semester exams. Many students get stressed out before, during, and after exams but we all survive the rigorous days of testing.



Junior Stacey Caldwell like many other people must sit in the hall to make up a quiz she missed.



Marchelle Levy had to rest from the hectic schedule of the day. Many students who felt sick whether from illness or an upcoming test would ask Mrs. Richter if they could take a nap in the parlor.

**D
A
Z
E

O
F

T
H
U
N
D
E
R**



(Left) Senior Brandon Vargas attempts to Karate kick one of our camera persons after they asked about his last exam.
(Below) Freshman Juli Kim listens closely to her teacher as she gives notes for the next test.



Reading isn't always an individual task. Seniors, Sarah Richmond, Lilia Gonzalez, Corrie Thomsen, Natalie Pena, and Faviola Hidalgo prove that group reading can be just as effective.



Seniors, Jennifer Villarreal, Stephanie Gonzales, and Juanita Ramirez demonstrate their public speaking abilities in class.



Senior William Bannantine uses his time in religion class to brush up on Bible readings.



Kim Wittliff along with other staff from the Diocesan wide Youth Spectacular read through their scripts for the day.

THE ENGLISH PATIENT

What is your favorite book ever assigned to you to read for English class and why?



The Hound of the Baskervilles
"It was entertaining and full of mystery."
-Hillary Johnston



A Separate Peace
"It shows the true trials of high school life."
-Kim Wittliff



All Quiet on the Western Front
"I like old-time war stories."
-Maureen Sheridan



The Great Gatsby
"It was just a good book with an interesting twist."
-Susan Sheehan



Wuthering Heights
"I liked the story and the characters."
-Emily Goodwin



Alberto Garza, junior, takes a well-earned rest after a tough test.



Vikash Patel is working hard on his art project. Many students take art as a way to relieve stress.



Seniors Brandon Vargas and Patrick Tinning diligently practice their computer skills.



Anjanette Cantu, senior, concentrates on her Chemistry lab experiment.



Trigonometry students, Alexis Fasci, Lorie Beste, Maria Martinez, Daphny Dominguez, and Marchelle Levy, contemplate a complicated series of problems.



Joseph Saenz proves that you can run but you can't hide from government class, or any class for that matter. Carlos Garcia seconds this sentiment.



Every Student reaches his/her

It's 6 o'clock in the morning; you're fast asleep when your alarm goes off. Time to get out of bed, throw on those snazzy clothes we all love so much, and somehow be at school by 8:00 a.m. You're on the road trying your best

PRESSURE POINT

to get in last minute studying for a test first period. [E=MC sq.] Oh no, you have history first.

Okay, fourth period is over and you head for the lunchroom. You realize you forgot your lunch at home and you have no cash. You make

it through the rest of the day, despite the fact that your stomach talked more than you did.

The last bell rings and you head for your car, only to notice that you locked your keys in it.

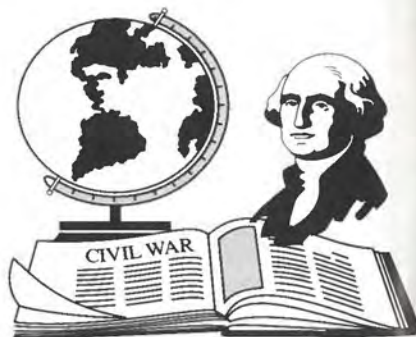



Mission: Impossible

TAPPS District 2-5A

Meet

Advanced Mathematics

4th- Mike Tabone
6th- Matt Pyle

Calculator

1st- Lindsey New
2nd- Rachel Williams
4th- Brendan Feeny

Computer Science

1st- Mike Tabone
4th- Matt Pyle
6th- Jimmy Reumuth

Current Events

1st- Collin Bost
3rd- John Wilder

Dramatic/Humorous Interpretation

3rd- Kathryn Tabone
4th- Cathy Chopin
5th- Renee Harris

Duet Acting

1st- Kathryn Tabone
& Juli Kim
2nd- Leslie Meyer
& Brock England
3rd- Ashley Lewis
& Jenny Vacca

History

5th- John Wilder

Literary Criticism

1st- Rachel Williams
3rd- Theresa McHugh

Math

6th- Shannon Stacy

Number Sense

2nd- Rowena Apacible
3rd- Matt Pyle
6th- Alberto Garza

Poetry Interpretation

1st- Araceli Garcia
3rd- Sarah England
4th- Cathy Chopin

Prose Interpretation

2nd- Kathryn Tabone
5th- Jenny Vacca
6th- Collin Bost

Ready Writing

3rd- Shannon Stacy
4th- Alberto Garza

Science

2nd- Maria Martinez
4th- Carlos Garcia
5th- Theresa McHugh

Spanish

2nd- Mikel Abreu

Spelling

1st- Lizette Solis
2nd- Lindsey New
6th- Roxana Apacible

Yearbook

3rd- Aurora

District Standing:

First Over All

TAPPS District 2-5A

Art Meet

Art History/Picture Memory

2nd- Carlos Garcia
3rd- Cathy Chopin
5th- Collin Bost

Black & White Drawing

1st- Travis Theriot
2nd- Susan Lawrence

Color Drawing

3rd- Zach Fritz

Commercially Processed

Photography
1st- David Caplan

Computer-Aided Design

1st- John Wilder

Ink Drawing

2nd- Susan Lawrence
3rd- Christina Moon
4th- Dante Paiz

Mixed Media

3rd- Corinne Walker

On-Site Drawing

2nd- Ruben Garcia
4th- Travis Theriot

Opaque Painting

2nd- Vikash Patel

Relief Sculpture

1st- Vikash Patel

Sculpture

2nd- Vikash Patel

Senior Portfolio

3rd- Vikash Patel

Transparent Painting

3rd- Sophia Lee

District Art:

Second Place Over All

TAPPS State Competition

Advanced Mathematics

3rd- Matt Pyle
6th- Mike Tabone

Calculator

1st- Rachel Williams
2nd- Lindsey New

Computer Science

3rd- Jimmy Reumuth
5th- Mike Tabone

Duet Acting

2nd- Jenny Vacca
& Ashley Lewis

Dramatic/Humorous Interpretation

1st- Kathryn Tabone

Literary Criticism

2nd- Rachel Williams

Prose Interpretation

1st- Kathryn Tabone

Ready Writing

1st- Alberto Garza

Spanish

6th- Mikel Abreu

Spelling

1st- Lizette Solis
4th- Lindsey New

First Over All



Back: John Wilder, Ashley Lewis, Jenny Vacca, Vikash Patel, Juli Kim, Sophia Lee, Carlos Garcia, Brendan Feeny, Shannon Stacy, Jimmy Reumuth; Middle: Theresa McHugh, Mike Tabone, Matt Pyle, Collin Bost, Ruben Garcia, Alberto Garza, Rachel Williams, Cathy Chopin, Mrs. Kelly; Front: Brock England, Lindsey New, Maria Martinez, Mikel Abreu, Travis Theriot; Kneeling: Rowena Apacible, Roxana Apacible, Araceli Garcia, Kathryn Tabone, and Sarah England.

The Neverending Story



John McGettrick contemplates on his experiences in his senior year and looks forward to the future.



Left: Barbara Schauer, Kristen Dill, Monica Benavides, Jeremiah Narvaez, and Stephanie Gonzales enjoy a break from the usual routine.



Above: New found friends, Corinne Walker and Andrew Rodriguez, look back at their year as it draws to a close.

The End Has Finally Come

Finally another year is over, and our future is getting closer and closer. This year was a time of good, a time of bad; it was a time of happy, and a time of sad. All in all, this year was a time of enlightenment where we all grew personally, physically and spiritually.

For the seniors, it was a year of preparation for the real world, a time to reflect on the past and look forward on what is to come. For the juniors, it was a time to take on the new challenges the seniors left behind and assume the responsibilities of being the role models of our school. For the rest of the student body it was one step up the ladder to leadership.



Back to Front: Brenda Valadez, Adrian Romero, Lorie Smith, and Ruben Garcia study for their Spanish test.

Below: Mikel Abreu does a victory dance for Korey Hardeman after a win at their soccer game.



The Incredible Journey

This school year has been a journey for the students of IWA. We have gone through many experiences, growing from the good and learning from the bad. Our journey through the school year of 1996-97 has been a preliminary journey through life. Our memories will never fade.



Above: Senior Vanessa Roberts reflects on her last year at IWA remembering the good times she had.



Above: Senior Cheerleader Tatiana Gutierrez flips for the basketball team.
Below: Juniors Gio Berastain and Adrian Romero enjoy their fun Spanish Trip to Mexico.

Below: "Fashion Friends" Stacey Caldwell, Michelle Northcutt, Ashley Mosser, and Ashley Allen show off at the Style Show.



Above: Junior Megan Byrne contemplates the year's end.

Right: Maureen McClure, Christi Strickland, Sarah Darby, and Charles Gover first got to know each other at the Welcome Dance.



Left: Mrs. McMinn, Kristen Hall, Fernando Casales, Rowena Apacible, Shannon Stacy, and Gerry Caballero enjoy a fun day in Spanish class.



Left: The year is finally over, and Seniors Ford Allen, Matt Emerson, and John McGettrick take a well needed rest.



Endless Summer



The students of IWA always look forward to their summer break, they only wish that it could be endless. The summer is a time of relaxation and fun. Some people go out of town; some people go out of state; and some even go out of the country. Most of the students enjoy staying in town, going to the beach, and hanging out with friends. All in all, no matter what one does on their break, the time off is very necessary and greatly appreciated.



Jacob Kerwick, Angela Perez, and Dyana Kossum make one final toast to their successful school year on their last day of school.



Summertime is often best spent just relaxing on the beach with friends.



Bye Bye Birdie



Mr. Harmon



Many students thank Mr. Harmon for his dedication to the IWA Band. His high expectations and goals led to its continued excellence. Mr. Harmon is appreciated and will always be remembered. Much luck to him in his new job.



That Thing You Do



Mrs. Allen thanks for your contributions to the newspaper and yearbook. Also, her volunteer work is extraordinary.



Mrs. Pena graciously donates her time by substituting for the faculty when she is needed most.

Many people at IWA lended a helping hand when we needed it most. There were times that we could not make it without them; notably the volunteer parents of IWA. The teachers and students appreciate the extra help that these people provided. From substitute teaching to chaperoning, we truly thank them.



Mrs. McHugh has helped IWA by substituting and chaperoning. Mr. McHugh drove the van to Austin for the TAPPS State Team. Both have helped many other ways.



Mr. and Mrs. McClure have donated much of their time into helping the students and faculty of IWA. We are very thankful for their dedication.

Helping



Mr. Kolaya, better known to most of the students as Lanky, has made sure that each student has had an enjoyable lunch.



Lanky's crew has also ensured that each student receives a tasty lunch.



Jesse, our maintenance operator, always makes sure that our school looks its best.

Maintaining our school is not an easy job, but these people have managed to make the job look simple. Whether they're providing us with lunch or cleaning up a spill, these people and others have shown outstanding service to IWA.

Good Luck
Juniors on your
Senior Year!

Love,
Mr. & Mrs. Giovannone

Hillary Johnston
Congratulations, we're
proud of you!

The Valdezes 
(your second family)



Laura.

*Congratulations! We
are very proud of you
and we love you very
much.*

Mom. Dad. Leslie & Lisa



We're outta here....

A few last words before we go...

To all of the faculty and staff that have made these last four years special, thank you for all that you have done to help us along the road to success.

We would like to thank the Sisters of the Incarnate Word and Blessed Sacrament for their continued ministry in our midst. We pray that the Lord God will continue to bless the work of the Sisters in the Dioceses of Corpus Christi and Brownsville.

This year has been memorable. To the future classes, we wish the same. Good luck and God Bless you all.

Rudy Reyes, Jr. and Bryan Johnson
Class of 1997

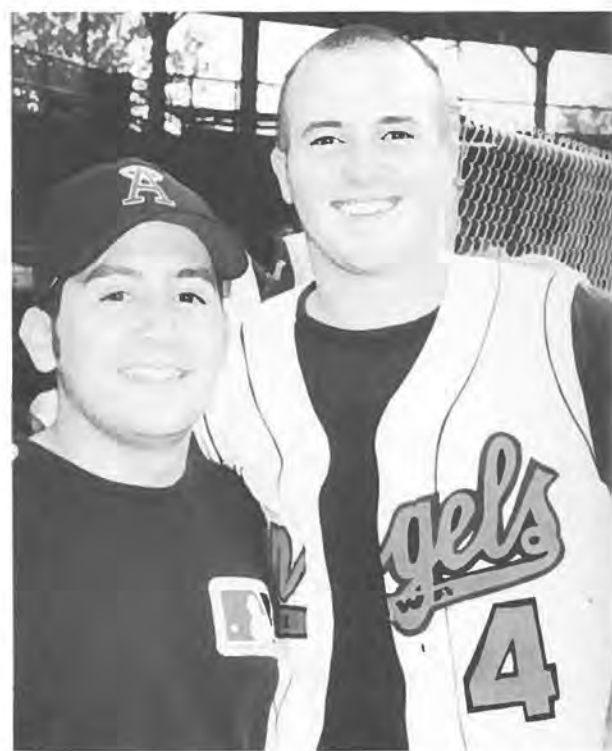

"Best Buds" by Ann Allen

Can You Guess Who These Babies Are?

1)



2)



3)



4)



ANSWERS:

1) Hillary Johnston
2) Tracy Hutchinson
3) Lindsey New
4) Natalie Pena



World Affairs

- and Local and School Affairs-

O.J. Simpson's Civil Trial ~ Tim Mc Veigh found guilty of Oklahoma City bombing ~ Star Wars Trilogy re-released in theaters ~ Michael Jackson has a baby BOY! ~ Madonna has a baby GIRL!! ~ Crash of T.W.A. flight 800 ~ Summer Olympics in Atlanta, Georgia ~ Olympic Bombing ~ Ennis Cosby was killed ~ Life is found on Mars ~ Model T & Roadmaster production is stopped ~ Mistake is found on SAT by a teenage genius who scores perfectly ~ Heaven's Gate suicides & murders ~ Cloning of Dolly, the sheep ~ SuperBowl between Green Bay Packers (winners) and New England Patriots ~ Deaths of Tupac Shakur, Notorious B.I.G., and Sublime band member ~ Susan Lucci lost for the 17th time in the Daytime Emmy Awards ~ Miss USA became Miss Universe ~ Plane lands at Cabanis Field ~ Selena Memorial ~ Mary Rhodes passed away ~ CCA joins IWA ~ Beeville prisoner escapes ~ 400th anniversary of Jeanne Chezard de Matel ~ Lake Texana Pipeline ~ Republic of Texas standoff ~ Tornado hits Jarrell, Texas ~ Plane leaves formation in Colorado Air Force show; wreckage was found in nearby mountains ~ Tiger Woods wins the Masters



Way to go, Big Bear! Now it's time for another big step.
Love,
Mom & Dad

Be Happy!
We're finally out!
Srs. '97, Good luck!
Love, Vanessa



Kindergarten



Graduation



Congratulations Ashley! Love, Mom & Dad



I love you guys,
and I'll miss you
while you're at
college.

Your little sis,
Kelly

Remember Nat,
"Never compromise yourself, you're
all you have."

Love,
Mom, Dad & The Kids



Leaving OUR MARK



Hordes of students enjoy themselves at
MORP and reminisce about the
Seventies.

Giovana Berastain, "tango-ready", stretches
out in front of John McGettrick, Ford Allen,
and Jamie Rose.



**Dear Alison,
Be proud of your
accomplishments...We are.**

**Love,
Mom, Geoff, Bernie,
Grandma & Grandpa**

**Congratulations to all the 1997
I.W.A. Senior class. Good Luck!
Dr. Rene Rodriguez & Family**



*Jenny and Emily,
Congratulations! You actually graduated.
We're going to miss you.
Love, Christy and Lindsey*



*Ben,
We are very proud of you.
Congratulations on a
★ terrific year! ★*

*Love,
Mom, Dad & Analisa*



*We love you,
George.
Mom & Dad*



Seniors '97



Juanita, Andrea, Jennifer, Belissa, Annie, Ana Liza, and Stephanie



WYATT CARGILE, ANA LOPEZ, MARINA PINEDA, SUSAN LAWRENCE, CANDICE PAIZ, LORIE BESTE, MONICA BRIONES, ANGELA PEREZ, DANTE PAIZ, KARINA GUERRA, MEGAN BYRNE, GIOVANA BERASTAIN, AND ADRIAN ROMERO CHERISH THE TRADITION OF THE ROSE CEREMONY.



TRACY HUTCHINSON CONTINUES TO BARREL RACE WITH THE HOPE TO COMPETE PROFESSIONALLY SOMEDAY.

FRIEND "CHIP"

Jimmy -n- Jessica -n- Wyatt -n- Mika
"That You Did" "Really?!" "Well Alright" "Ho'd On"



Free Christmas tree ~ carnival rides in Sunrise Mall's parking lot ~ W.B.C. ~ "U.B.U." ~ S.O.S. ~ Look! Native American Bison ~ It's a tiger's bite ~ Toadies ~ Sleep overs ~ Norman ~ "The spa" ~ Smashing Pumpkins ~ Joe's Malts & Burgers ~ SCREAM! (Jimmy's house afterward) ~ Jingle All The Way ~ C.O.P.S. ~ Homecoming '97 ~ The sweet "Southern Comfort" ~ The "Pimp Chair" ~ Buster ~ It's not a pig's ear, it's a rawhide ~ Mr. Clean...are you serious? ~ "I had a dog that went crazy in the snow" ~ COP!...I think I'll park in the middle of the intersection ~ Favorites '97 ~ The Village People ~ Jewel ~ Rage Against the Machine ~ Chato & Chito ~ Jaime (Jimmy) ~ Baskin Robbins ~ Fairy ~ Banana Fight ~ Jim, What are you doing?... "juggling" ~ The Mockingbird Song ~ Super Hits from the 70s ~ Coastal Chillers ~ 20 minutes of coming attractions ~ Bananas in Pajamas ~ Morp '97 ~ "Mr. Disco" ~ pillow fights ~ that's phat...with a "P" ~ Prom '97 ~ Andy Torres and the baseball game ~ Wyatt and Jimmy, Good luck in all that you two decide to do. We hope all goes well for you in the future. We'll miss you both and hope to keep in touch. We're glad that the four of us had the chance to become so close this year and we'll never forget you. We love you both. Love always, Mika and Jessica.

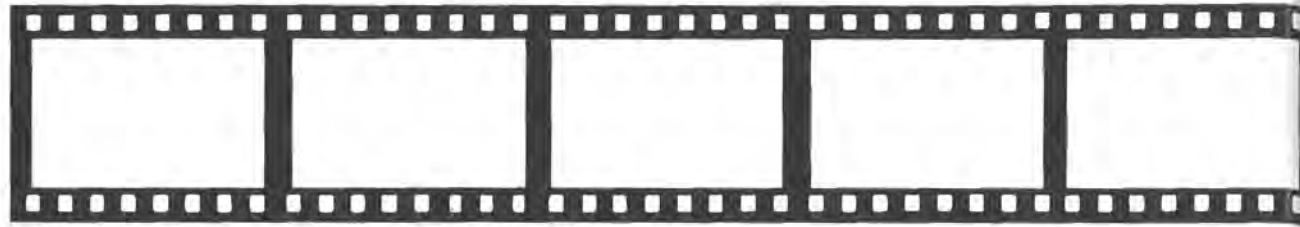

The 1997 Aurora was printed by Herff Jones, Inc. in Corpus Christi, Texas. Much thanks to our Herff Jones representative Ms. Chapuran who graciously devoted her time and energy in helping produce our yearbook. The yearbook was completed on a Power Macintosh 6100/60 and a Macintosh Powerbook 170 in conjunction with our Desktop Publishing system (Aldus Pagemaker 5.0).



The Cast

Editor, Lindsey New and **Assistant Editor**, Amelia Giovannone. **Section Editors:** Lindsey New and Amelia Giovannone, opening/closing; Tracy Hutchinson, student life; Annie Palacios, clubs/organizations; Corinne Walker, seniors; Ashley Mosser, people; David Caplan, athletics; Desiree Valdez, academics; Rachel Williams, advertisements.

Staff Members: Mikel Abreu, David Caplan, Allison Davis, Mike Garcia, Amanda Garza, Amelia Giovannone, Ashlee Howe, Tracy Hutchinson, Daniel Keetch, Laura Kocian, Marchelle Levy, Paige McCurdy, John McGettrick, Ashley Mosser, Lindsey New, Annie Palacios, Sadie Palmer, Vanessa Roberts, Andrew Rodriguez, Jorge Rodriguez, Desiree Valdez, Corinne Walker, John Wilder, and Rachel Williams.

Darkroom operators: Paige McCurdy, Corinne Walker, Mike Garcia, and Amelia Giovannone.

Advisor: Ms. Marie Chambless

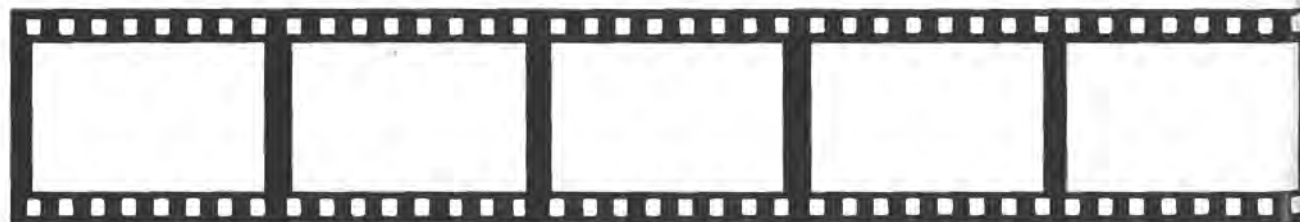



THE END