

New Design



HangSafe Hooks®

SCHAUER FAMILY INNOVATIONS, LLC

INVOICE 21350

165 East State Highway CC t. 888.803.7403
Nixa, MO 65714 f. 417.725.8901

Bill to

School District Five of Lexington and Richland Counties
1020 Dutch Fork Rd.
Irmo, SC 29063

Ship to

Leaphart Elementary School
120 Piney Grove Road
Columbia, SC 29210

Invoice Date

Order Date 9/28/2011

P.O. 132066

Terms Net 30

Ship Date

Via

Order Details

Model	Quantity	Description	Price	Subtotal
RK6408L	3	Oak Coat Rack w/ 8 Hooks 6.4" OC = 4'-3 1/4"	\$95.00	\$285.00
RK6409L	3	Oak Coat Rack w/ 9 Hooks 6.4" OC = 4'-9 5/8"	\$106.00	\$318.00
RK6409R	1	Oak Coat Rack w/ 9 Hooks 6.4" OC = 4'-9 5/8"	\$106.00	\$106.00
RK6410	7	Oak Coat Rack w/ 10 Hooks 6.4" OC = 5'-4"	\$117.00	\$819.00
RK6410L	2	Oak Coat Rack w/ 10 Hooks 6.4" OC = 5'-4"	\$117.00	\$234.00

PAID

NOV 14 2011

CITY OF FINANCE

Order Total	\$1,762.00
Shipping	\$109.50
Total	\$1,871.50
Payments	
Balance Due	\$1,871.50

Order Summary

150 hooks
16 racks
6.4" inch spacing

Hardware Included

68 Buttons
64 Tapcons
64 Washers

Budget No. 535-253-540-3000-50
 PO No. 132066 Date 1/11/12
 Comments Partial C
 Price ✓
 Material ✓
 Use (No)
 Signature [Signature]

VENDOR: 681362
 HANGSAFE HOOKS
 KEVIN N SCHAUER
 165 E HIGHWAY CC
 NIXA MO 65714
 417-725-8900

PURCHASE ORDER

Page 1
PURCHASE ORDER NO: 132066
 NET 30 DAYS

OUR PURCHASE ORDER NUMBER MUST APPEAR ON ALL INVOICES, PACKAGES AND CORRESPONDENCE.

SEND ALL INVOICES FOR PAYMENT TO:

Accounts Payable
 School District Five of
 Lexington and Richland Counties
 1020 Dutch Fork Road
 Irmo, South Carolina 29063

SHIP TO:

LEAPHART ELEM. SCHOOL
 120 PINEY GROVE ROAD
 COLUMBIA SC 29210

803-476-4700
 KEITH MCALISTER

ORDER DATE: Sep 26, 2011

QUANTITY/UNIT	CATALOG NUM.	DESCRIPTION	UNIT PRICE	TOTAL
1		SECTION A HOOKS	1,115.00	1,115.00
1		SECTION B HOOKS	201.00	201.00
1		SECTION C HOOKS	234.00	234.00
1		SECTION D HOOKS	212.00	212.00
1		SHIPPING	109.50	109.50

Sub Total 1,871.50
 Sales Tax 131.01
TOTAL \$2,002.51

ACCOUNT DISTRIBUTION DETAILS

REV	APPRV	ACCOUNT NUMBER	AMOUNT	REV	APPRV	ACCOUNT NUMBER	AMOUNT	REV	APPRV	ACCOUNT NUMBER	AMOUNT
TJC	BGE	535-253-540-3000-50	\$2,002.51								

Jeffrey C. Patterson

 Signature



September 27, 2011

 Date

VENDOR

INSTRUCTIONS:

- 1. Order is to be shipped in accordance with prices, delivery, and specifications shown below.**
- 2. Notify us immediately if you are unable to ship as specified.**
- 3. Visitors are prohibited from using tobacco on District property.**



165 E Hwy CC
 Nixa, MO 65714
 P: 888.803.7403
 F: 417.725.8901

Price Breakdown

Area 'A'				Section 1
Model	Quantity	Description	Price	Extension
RK6410	5	Oak Coat Rack w/ 10 Hooks 6.4" OC = 5'-4"	\$117.00	\$585.00 ✓
RK6408L	2	Oak Coat Rack w/ 8 Hooks 6.4" OC = 4'-3 1/4"	\$95.00	\$190.00 ✓
RK6410L	2	Oak Coat Rack w/ 10 Hooks 6.4" OC = 5'-4"	\$117.00	\$234.00 ✓
RK6409L	1	Oak Coat Rack w/ 9 Hooks 6.4" OC = 4'-9 5/8"	\$106.00	\$106.00 ✓
Hooks per Section: 95 = 50.67 Linear Feet			Section Price	\$1,115.00
			Quantity x	1
Total Hooks: 95 = 50.67 Linear Feet			Section Subtotal	\$1,115.00

Area 'B'				Section 2
Model	Quantity	Description	Price	Extension
RK6409L	1	Oak Coat Rack w/ 9 Hooks 6.4" OC = 4'-9 5/8"	\$106.00	\$106.00 ✓
RK6408L	1	Oak Coat Rack w/ 8 Hooks 6.4" OC = 4'-3 1/4"	\$95.00	\$95.00 ✓
Hooks per Section: 17 = 9.07 Linear Feet			Section Price	\$201.00
			Quantity x	1
Total Hooks: 17 = 9.07 Linear Feet			Section Subtotal	\$201.00

Area 'C'				Section 3
Model	Quantity	Description	Price	Extension
RK6410	2	Oak Coat Rack w/ 10 Hooks 6.4" OC = 5'-4"	\$117.00	\$234.00 ✓
Hooks per Section: 20 = 10.67 Linear Feet			Section Price	\$234.00
			Quantity x	1
Total Hooks: 20 = 10.67 Linear Feet			Section Subtotal	\$234.00

PO
 540
 535-253-500-3000-50

appnd 9/26/11
 TJC
 m/t

167160
 9/26/11

1.871.50x
 1.07=
 2.002.51*

165 E Hwy CC - Nixa, MO 65714 - Fax: 417.725.8901 - www.hangsafehooks.com

Proposal: 2011-1315 v1

This proposal reflects only the items listed within this document. Any changes to the configuration may result in changes to the given price. This proposal will expire 30 days from the date listed above. Any extension is subject to the approval of HangSafe Hooks.



HangSafe Hooks

165 E Hwy CC
Nixa, MO 65714
P: 888.803.7403
F: 417.725.8901

Price Breakdown

Area 'D'				Section 4	
Model	Quantity	Description	Price	Extension	
RK6409L	1	Oak Coat Rack w/ 9 Hooks 6.4" OC = 4'-9 5/8"	\$106.00	\$106.00 ✓	
RK6409R	1	Oak Coat Rack w/ 9 Hooks 6.4" OC = 4'-9 5/8"	\$106.00	\$106.00 ✓	
Hooks per Section: 18 = 9.6 Linear Feet			Section Price	\$212.00	
			Quantity ×	1	
Total Hooks: 18 = 9.6 Linear Feet			Section Subtotal	\$212.00	

			TOTALS	
150	Total Hooks	Order Price	\$1,762.00	
16	Total Racks	Shipping	\$109.50	
80.01'	Total Rack Length	TOTAL	\$1,871.50	

Description

Above Pricing Includes:

- Solid oak racks (1 1/2 (double 3/4" layers) x 3 1/2") fully finished (standard stain, polyurethane protective coat(s)), with polycarbonate (Lexan) hooks (7 x 1 1/4 x 3/8"), secured with #14 x 2" stainless steel screws
- Racks are fully assembled
- All mounting hardware (method per wall type)
- Customer choice of stain color
- Design coordination. (to determine number of hooks that can be fitted in an area, mounting criteria)
- Phone installation assistance if needed

165 E Hwy CC - Nixa, MO 65714 - Phone: 888.803.7403 - Fax: 417.725.8901 - www.hangsafehooks.com

Proposal: 2011-1315 v1

This proposal reflects only the items listed within this document. Any changes to the configuration may result in changes to the given price. This proposal will expire 30 days from the date listed above. Any extension is subject to the approval of HangSafe Hooks.

VENDOR:

681362

HANGSAFE HOOKS
KEVIN N SCHAUER
165 E HIGHWAY CC
NIXA MO 65714
417-725-8900

PURCHASE ORDER

Page 1

PURCHASE ORDER NO: 132383

NET 30 DAYS

OUR PURCHASE ORDER NUMBER MUST APPEAR ON ALL INVOICES, PACKAGES AND CORRESPONDENCE.

SEND ALL INVOICES FOR PAYMENT TO:

Accounts Payable
School District Five of
Lexington and Richland Counties
1020 Dutch Fork Road
Irmo, South Carolina 29063

SHIP TO:

LEAPHART ELEM. SCHOOL
120 PINEY GROVE ROAD
COLUMBIA SC 29210

803-476-4700
KEITH MCALISTER

ORDER DATE: Oct 04, 2011

QUANTITY/UNIT	CATALOG NUM.	DESCRIPTION	UNIT PRICE	TOTAL
1		AREA A SECTION / HOOKS SOLID OAK RACKS	1,115.00	1,115.00
1		AREA B SECTION / HOOKS SOLID OAK RACKS	201.00	201.00
1		AREA C SECTION / HOOKS SOLID OAK RACKS	234.00	234.00
1		AREA D SECTION / HOOKS SOLID OAK RACKS	212.00	212.00
1		SHIPPING	109.50	109.50

Sub Total	1,871.50
Sales Tax	131.01
TOTAL	\$2,002.51

ACCOUNT DISTRIBUTION DETAILS

REV	APPRV	ACCOUNT NUMBER	AMOUNT	REV	APPRV	ACCOUNT NUMBER	AMOUNT	REV	APPRV	ACCOUNT NUMBER	AMOUNT
TJC	BGE	535-253-540-3000-50	\$2,002.51								

Jeffrey C. Patterson

Signature



October 05, 2011

Date

VENDOR

INSTRUCTIONS:

- 1. Order is to be shipped in accordance with prices, delivery, and specifications shown below.**
- 2. Notify us immediately if you are unable to ship as specified.**
- 3. Visitors are prohibited from using tobacco on District property.**

VENDOR:

681362

PURCHASE ORDER

Page 1

HANGSAFE HOOKS
KEVIN N SCHAUER
165 E HIGHWAY CC
NIXA MO 65714
417-725-8900

PURCHASE ORDER NO: 132383

NET 30 DAYS

OUR PURCHASE ORDER NUMBER MUST APPEAR ON ALL INVOICES, PACKAGES AND CORRESPONDENCE.

SEND ALL INVOICES FOR PAYMENT TO:

Accounts Payable
School District Five of
Lexington and Richland Counties
1020 Dutch Fork Road
Irmo, South Carolina 29063

SHIP TO:

LEAPHART ELEM. SCHOOL
120 PINEY GROVE ROAD
COLUMBIA SC 29210

803-476-4700
KEITH MCALISTER

ORDER DATE: Oct 04, 2011

QUANTITY/UNIT	CATALOG NUM.	DESCRIPTION	UNIT PRICE	TOTAL
1		AREA A SECTION / HOOKS SOLID OAK RACKS	1,115.00	1,115.00
1		AREA B SECTION / HOOKS SOLID OAK RACKS	201.00	201.00
1		AREA C SECTION / HOOKS SOLID OAK RACKS	234.00	234.00
1		AREA D SECTION / HOOKS SOLID OAK RACKS	212.00	212.00
1		SHIPPING	109.50	109.50

** Please CANCEL this PO (it ^{is} fixed a duplicate of PO 132066) 10/6/11 11/16/11 TJC*

Sub Total	
Sales Tax	131.01
TOTAL	\$2,002.51

ACCOUNT DISTRIBUTION DETAILS

REV APPRV	ACCOUNT NUMBER	AMOUNT	REV APPRV	ACCOUNT NUMBER	AMOUNT	REV APPRV	ACCOUNT NUMBER	AMOUNT
TJC	BGE 535-253-540-3000-50	\$2,002.51						

Jeffrey C. Patterson



October 05, 2011

Date

Signature

Irmo, SC 29063
(803) 732-8000

ACCOUNTS PAYABLE

PO
535-253-540-3000-50

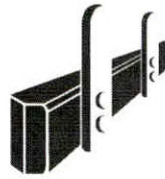

107659
MH
10/4/11
apprd 10/4/11

HangSafe Hooks®
SCHAUER FAMILY INNOVATIONS, LLC

Proposal

Date: 9/14/2011

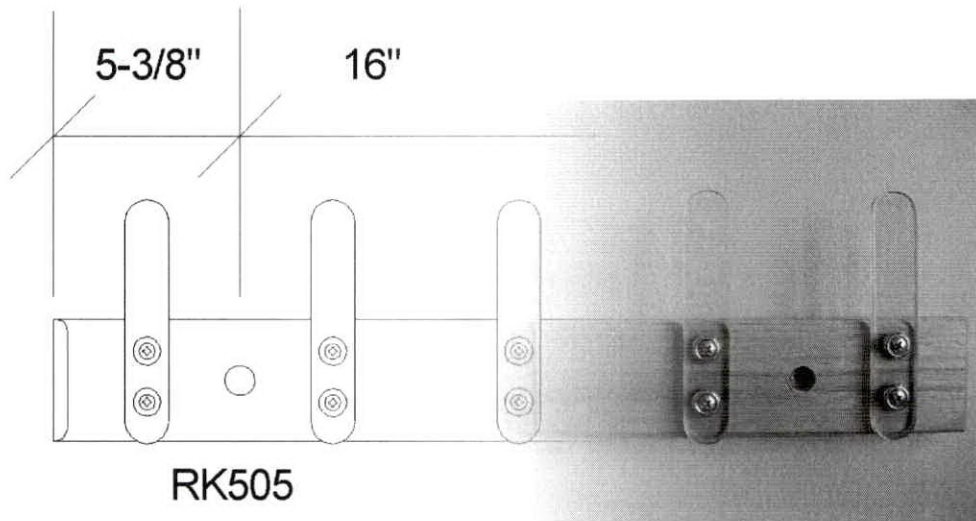

Proposal for School District Five of Lexington and Richland

Contact
Scott Carlin
Address

1020 Dutch Fork Rd. - Irmo, SC 29063

165 E Hwy CC - Nixa, MO 65714 - Phone: 888.803.7403 - Fax: 417.725.8901 - www.hangsafehooks.com

Proposal: 2011-1315 v1



HangSafe Hooks®
SONARKE FAMILY INNOVATIONS, LLC

165 E Hwy CC
 Nixa, MO 65714
 P: 888.803.7403
 F: 417.725.8901

Price Breakdown

Area 'A'				Section 1	
Model	Quantity	Description	Price	Extension	
RK6410	5	Oak Coat Rack w/ 10 Hooks 6.4" OC = 5'-4"	\$117.00	\$585.00	
RK6408L	2	Oak Coat Rack w/ 8 Hooks 6.4" OC = 4'-3 1/4"	\$95.00	\$190.00	
RK6410L	2	Oak Coat Rack w/ 10 Hooks 6.4" OC = 5'-4"	\$117.00	\$234.00	
RK6409L	1	Oak Coat Rack w/ 9 Hooks 6.4" OC = 4'-9 5/8"	\$106.00	\$106.00	
Hooks per Section: 95 = 50.67 Linear Feet			Section Price	\$1,115.00	
			Quantity x	1	
Total Hooks: 95 = 50.67 Linear Feet			Section Subtotal	\$1,115.00	

Area 'B'				Section 2	
Model	Quantity	Description	Price	Extension	
RK6409L	1	Oak Coat Rack w/ 9 Hooks 6.4" OC = 4'-9 5/8"	\$106.00	\$106.00	
RK6408L	1	Oak Coat Rack w/ 8 Hooks 6.4" OC = 4'-3 1/4"	\$95.00	\$95.00	
Hooks per Section: 17 = 9.07 Linear Feet			Section Price	\$201.00	
			Quantity x	1	
Total Hooks: 17 = 9.07 Linear Feet			Section Subtotal	\$201.00	

Area 'C'				Section 3	
Model	Quantity	Description	Price	Extension	
RK6410	2	Oak Coat Rack w/ 10 Hooks 6.4" OC = 5'-4"	\$117.00	\$234.00	
Hooks per Section: 20 = 10.67 Linear Feet			Section Price	\$234.00	
			Quantity x	1	
Total Hooks: 20 = 10.67 Linear Feet			Section Subtotal	\$234.00	

165 E Hwy CC - Nixa, MO 65714 - Phone: 888.803.7403 - Fax: 417.725.8901 - www.hangsafefhooks.com

Proposal: 2011-1315 v1

This proposal reflects only the items listed within this document. Any changes to the configuration may result in changes to the given price. This proposal will expire 30 days from the date listed above. Any extension is subject to the approval of HangSafe Hooks.



HangSafe Hooks®
SCHAEFER FAMILY INNOVATIONS, LLC

165 E Hwy CC
Nixa, MO 65714
P: 888.803.7403
F: 417.725.8901

Price Breakdown

Area 'D'				Section 4	
Model	Quantity	Description	Price	Extension	
RK6409L	1	Oak Coat Rack w/ 9 Hooks 6.4" OC = 4'-9 5/8"	\$106.00	\$106.00	
RK6409R	1	Oak Coat Rack w/ 9 Hooks 6.4" OC = 4'-9 5/8"	\$106.00	\$106.00	
Hooks per Section: 18 = 9.6 Linear Feet			Section Price	\$212.00	
			Quantity x	1	
Total Hooks: 18 = 9.6 Linear Feet			Section Subtotal	\$212.00	

			TOTALS	
150	Total Hooks		Order Price	\$1,762.00
16	Total Racks		Shipping	\$109.50
80.01'	Total Rack Length		TOTAL	\$1,871.50

w/ tax **\$2,002.51**

Description

Above Pricing Includes:

- Solid oak racks (1 1/2 (double 3/4" layers) x 3 1/2") fully finished (standard stain, polyurethane protective coat(s)), with polycarbonate (Lexan) hooks (7 x 1 1/4 x 3/8"), secured with #14 x 2" stainless steel screws
- Racks are fully assembled
- All mounting hardware (method per wall type)
- Customer choice of stain color
- Design coordination. (to determine number of hooks that can be fitted in an area, mounting criteria)
- Phone installation assistance if needed

165 E Hwy CC - Nixa, MO 65714 - Phone: 888.803.7403 - Fax: 417.725.8901 - www.hangsafehooks.com

Proposal: 2011-1315 v1

This proposal reflects only the items listed within this document. Any changes to the configuration may result in changes to the given price. This proposal will expire 30 days from the date listed above. Any extension is subject to the approval of HangSafe Hooks.

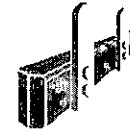

HangSafe Hooks®
SCHAFFER FAMILY INNOVATIONS, LLC

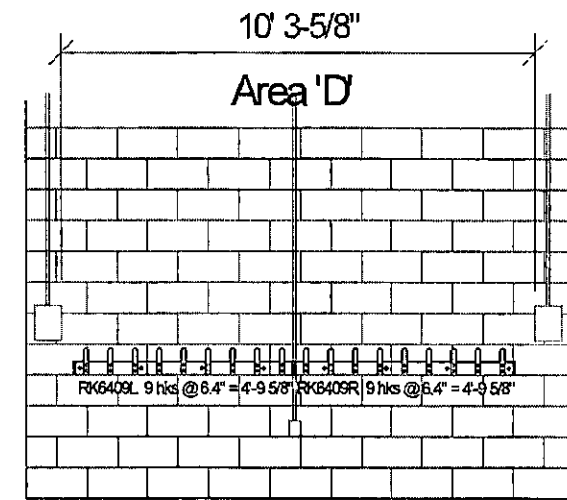
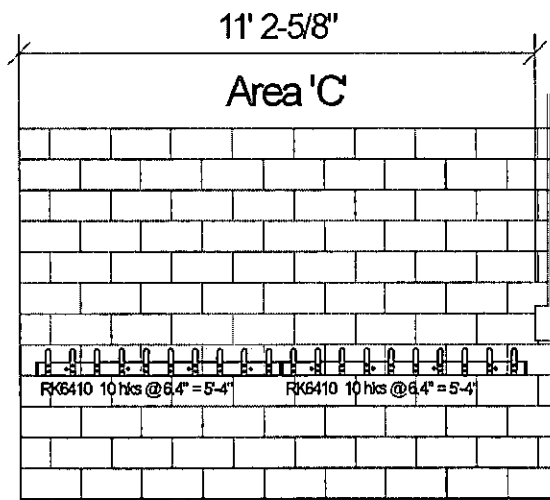
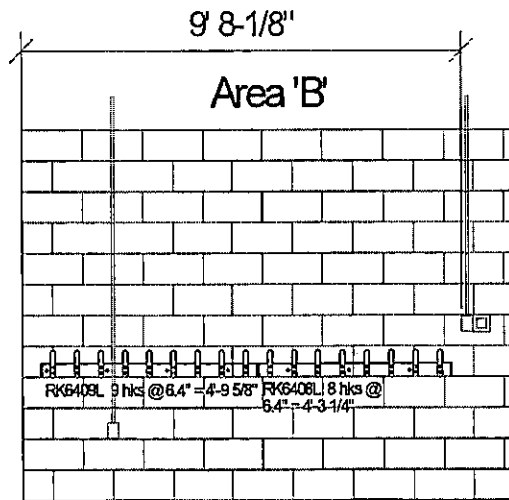
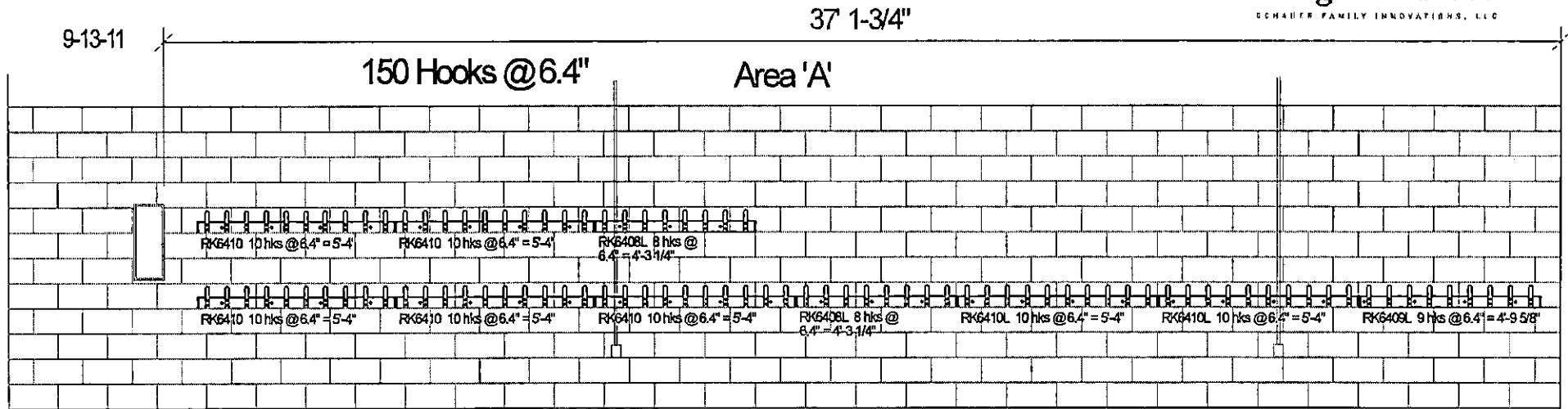



Tracie Covey <tcovey@lexrich5.org>

Fwd: Coat Racks

1 message

Scott Carlin <scarlin@lexrich5.org>
To: Tracie Covey <tcovey@lexrich5.org>

Mon, Oct 3, 2011 at 5:03 PM

Tracie,
- Please cut a PO for this material.
- It's going in the cafeteria at LES as part of their furnishing.
Thanks,
scott

----- Forwarded message -----

From: **Scott Carlin** <scarlin@lexrich5.org>
Date: Wed, Sep 14, 2011 at 11:34
Subject: Fwd: Coat Racks
To: David Shealy <dmshealy@lexrich5.org>, Metts Melba <mmmetts@lexrich5.org>
Cc: Gary Gerald <GGary@lexrich5.org>, McAlister Keith <kmcalist@lexrich5.org>

David,
- Please take a look at this final proposal from the folks at hang-safe.
- If all looks good, let's get Tracie Covey to cut a PO for this.
- They will arrive with all necessary equipment for us to install (cafeteria at LES).
Thanks,
Scott

Sent from my iPhone

Begin forwarded message:

From: Kevin Schauer <kevin@hangsafefhooks.com>
To: "scarlin@lexrich5.org" <scarlin@lexrich5.org>
Cc: "aric@hangsafefhooks.com" <aric@hangsafefhooks.com>
Subject: Coat Racks

Good Morning Scott;

Please note the attached proposal.

Couple of things we did with this design:

- Lowered the racks 8".
- Used another short wall that we hadn't before.
- Put some distance between the coat racks and the fire extinguisher.

- Limit the use of double tiers.

Please let us know what other moving around we'll have to do.

Kevin

Kevin Schauer

HangSafe Hooks

165 E State Hwy CC

Nixa, MO 65714

t. 888-803-7403

417-725-8900

f. 417-725-8901

<<http://www.hangsafehooks.com/>> www.hangsafehooks.com

--
Scott A. Carlin
Coordinator of Facilities
1020 Dutch Fork Rd.
Irmo, SC 29063
Ph: 803.476.8123
Fax: 803.476.8037

notitia, fiducia, assensus

2 attachments



image001.gif
1K



Proposal School District Five of Lexington and Richland Counties 2011-1315 v1.pdf
894K