

**ROUND LAKE AREA SCHOOLS CUSD #116  
ROUND LAKE MIDDLE SCHOOL PAVEMENT IMPROVEMENTS**

<b>INVITATION FOR BIDS</b>
----------------------------

Sealed bids for the Round Lake Middle School Pavement Improvements, for the Round Lake Area Schools Community Unit School District #116, as described below will be received at the Round Lake Area Schools CUSD #116 Operations Service Center, 811 Sunset Drive, Round Lake, IL 60073 until 12 noon, local time, Tuesday, May 23, 2023. At 1:00 PM, all bids will be publicly opened and read aloud at the Maintenance Warehouse, 719 Valentin Drive, Round Lake, IL, 60073. Sealed envelopes are to be marked "Sealed Bid for SD116-ROUND LAKE MIDDLE SCHOOL PAVEMENT IMPROVEMENTS" and submitted to the Attention of Dr. Pamela Kibbons.

Electronic Bid Documents may be obtained, starting at 9:00 AM on Thursday, May 11, 2023, on the Round Lake Areas Schools CUSD #116 District website, Operations Tab-select Business Office. Hard Copies of the Bid Documents are not available.

The work shall consist of, but shall not be limited to, the following: The Base Bid of the project involves milling the existing pavement to a depth of 1.5" and 5" depending on the area, pavement removal, HMA resurfacing, pavement reconstruction, and restriping the area as directed by the owner at Round Lake Middle School. See Location Map for additional requirements and specific work locations.

Bid security in the form of a Bid Bond, Bank Cashier's Check, or Certified Check in the amount of TEN (10) percent of the total bid amount, made payable to the Round Lake Area Schools CUSD #116 shall accompany the bid.

There will be a **STRONGLY ENCOURAGED** Pre-Bid Walk-Thru Meeting for all interested bidders. Any prime bidder submitting a bid on this project can attend this meeting. Location and time are as follows:

Location: Round Lake Middle School, 2000 N. Lotus Drive, Round Lake Heights, IL 60073  
Bidders must enter the school through Door 21 and have a valid picture ID  
Date: Wednesday, May 17, 2023  
Time: 9:00 a.m.

The Round Lake Area Schools CUSD #116 reserves the right to accept or reject any bid, to award all or part of a contract, and to make such awards as are in the best interests of the School District. Factors other than price which will be considered in awarding or rejecting bids shall include the results of reference contacts, and the quality of the bidder's performance on prior projects, if any, in the judgment of the School District. All proposals submitted shall be valid for a period of 90 days.

Round Lake Area School District 116, in an effort to reaffirm its policy of non-discrimination, encourages the efforts of Operators and sub-Operators to take affirmative action to bid, in addition to providing for Equal Employment Opportunity without regard to race, religion, creed, color, sex, national origin, age, handicap unrelated to ability to perform the job or protected Veteran's status.

Dated in Round Lake, Illinois, this May 11, 2023.

By Order of Round Lake Area Schools CUSD #116

# PROJECT MANUAL

CONTRACT DOCUMENTS AND  
SPECIFICATIONS FOR CONSTRUCTION

for

## Round Lake Middle School 2023 Pavement Improvements

**Owner:**

Round Lake Area Schools CUSD #116  
884 Nippersink Road  
Round Lake, IL 60073

**Engineer:**

Gewalt Hamilton Associates, Inc.  
625 Forest Edge Drive  
Vernon Hills, Illinois 60061  
(847) 478-9700



**GHA** GEWALT HAMILTON  
ASSOCIATES, INC.

CONSULTING ENGINEERS

Direct All Communications Regarding This Bid To:  
Dr. Pamela Kibbons, Asst. Superintendent of Business  
Round Lake Area Schools CUSD #116

Direct All Communications Regarding Site Work To:  
Mark Vierck, Project Manager  
Round Lake Area Schools CUSD #116

**BIDS ISSUANCE DATE: May 11, 2023**

**BID DUE DATE: May 23, 2023 BY 12:00 PM/NOON**

# Table of Contents

**BIDDING DOCUMENTS** .....4

- Scope of Work.....4
- Description of Work .....4
- Project Specifics .....4
- CONTRACTOR PREQUALIFICATIONS:.....4
- START DATE: .....4
- COMPLETION DATE .....4
- LIQUIDATED DAMAGES .....5
- WORKING HOURS .....5
- PROJECT SCHEDULE .....5
- STAGING & PHASING .....5
- Bid Package Instructions.....6
- Bid Proposal Form – Base Bid .....7
- Bid Addendum Notice Form(s) .....8
- Bid Certification Form.....9
- Bid Security ..... 10
- Performance Reference Form..... 11
- Significant Sub-contractor Form..... 12
- Non-Collusion Certification Form ..... 13
- Non-Conflict of Interest Certification Form ..... 14
- Sexual Harassment Policy ..... 15
- Certificate of Non-Discrimination..... 16
- Prevailing Wage Statement..... 17
- Prevailing Wage Requirements..... 18
- Bidding Conditions ..... 19
- Definitions ..... 19
- Preparation of Bid ..... 20
- Bid Security..... 21
- Submission of Bid ..... 21
- Withdrawal of Bid..... 22
- Disqualification of Bid ..... 22
- Consideration of Bid ..... 23
- Rejection of Bid..... 23
- Protest of Bid ..... 24
- Non-collusion ..... 24
- No Conflict of Interest ..... 24
- Unit Prices and Quantities ..... 24
- Addenda ..... 24

Project Conditions.....	25
Contract Conditions .....	25
CONTRACT DOCUMENTS .....	27
Supplemental General Conditions .....	27
1.0 Contract Documents .....	27
2.0 Project Engineer .....	27
3.0 Owner .....	27
4.0 Contractor .....	28
5.0 Subcontractors.....	34
6.0 Payments & Completion .....	35
7.0 Safety Programs & Responsibilities .....	37
8.0 Insurance .....	38
9.0 Changes in the Work .....	40
10.0 Hold Harmless Agreement & Indemnification.....	42
11.0 Delays & Extensions of Time.....	44
12.0 Hazardous Materials.....	45
13.0 Uncovering & Correction of work.....	46
14.0 Miscellaneous Provisions .....	47
Special Provisions .....	52
Section 105 – Control of Work.....	52
Section 107 - Legal Relations and Responsibility to the Public .....	55
Section 109 – Measurement and Payment .....	55
Recurring Special Provisions.....	59
Temporary Restroom Facilities.....	59
Construction Layout.....	59
Cooperation with Existing Utilities .....	59
Disposal of Surplus Material (CCDD) .....	60
Special Waste Policy .....	61
Maintenance of Existing Roadways .....	61
Progress Cleaning, Sweeping, and Waste Removal.....	61
Protection of Existing Drainage Facilities During Construction .....	61
Use of Premises .....	62
Material Storage .....	62
Environmental Control .....	62
Submittals.....	63
Rejection of Work .....	68
Project Specific Special Provisions .....	68
General Provisions .....	68
Traffic Control & Protection, Special.....	69
Hot Mix Asphalt Binder & Surface Courses.....	70

Sample Contract..... 72  
Exhibits ..... 73  
    Project Improvement Plan ..... 73  
    Standard Details ..... 75

# **BIDDING DOCUMENTS**

## **Scope of Work**

*The Scope of Work includes all work necessary to complete the proposed improvements as detailed in the project documents, specifications, plans and ordinances governing this work. Contractor shall provide all labor, materials, equipment, training, testing, insurance, bonding, permits, subcontracting and licenses necessary for the execution of the Scope of Work. At a minimum, all applicable federal, state and local requirements shall be complied with for the Scope of Work.*

## **DESCRIPTION OF WORK**

The work shall consist of, in general, but shall not be limited to, the following: The Base Bid of the project involves milling the existing pavement to a depth of 1.5” and 5,” depending on the area, pavement removal, HMA resurfacing, pavement reconstruction, and restriping the area as directed by the owner. See Location Map for additional requirements and specific work locations.

## **PROJECT SPECIFICS**

### **CONTRACTOR PREQUALIFICATIONS:**

- General Contractor = All bidders shall submit, separate from the sealed bid, a resume of similar projects performed, enumerated, as to location, type of work, approximate completion date, and engineering references. Resumes of similar projects must be submitted no later than the bid due date and time. Bids submitted without sufficient prequalification documents will, at the discretion of the Owner, be returned unopened.
- Subcontractor = Subcontracting portions of the work will be allowed pursuant to Section 108.01 of the “Standard Specifications for Road and Bridge Construction”, Illinois Department of Transportation, latest edition. The Owner reserves the right to reject any Bidder or subcontractor who, in the opinion of the Owner, Construction Manager or Engineer, does not have adequate experience, personnel or equipment to perform the work in a timely, efficient, and satisfactory manner.

### **START DATE:**

Work on this project is scheduled to begin no sooner than **May 30, 2023**

### **COMPLETION DATE**

The completion date on this contract is **August 4, 2023**. In case of failure to complete the work on time the provisions of Article 108.09 of the “Standard Specifications” shall apply.

### **LIQUIDATED DAMAGES**

All of the costs for the Owner's operations (i.e.: utilities, security, re-construction, etc.) resulting from failure by the Contractor to complete the work by the required date will be assessed to (and deleted from) the Contractor's payment for every day/shift that the project is not completed by the agreed upon completion dates as noted above. Contract liquidated damages will be assessed in accordance with the provisions of Article 108.09 of the Illinois Department of Transportation's Standard Specifications for Road and Bridge Construction, latest edition.

### **WORKING HOURS**

All work shall be confined to the period beginning at 7:00 AM and ending at 7:00 PM Monday - Friday. No construction equipment can be started, or idling, before the allowable work hours. Work on Saturday by approval of District only. No work shall be done on Sundays or legal holiday periods as defined in Article 107.09 of the Standard Specifications.

### **PROJECT SCHEDULE**

The awarded Bidder shall submit a schedule at the mandatory pre-construction meeting. The schedule shall be detailed showing all major tasks and associated minor tasks showing predecessors and successors, milestone dates, including punch list walkthrough and punch list completion. The schedule shall be updated and submitted weekly during the course of the project. The schedule is subject to review by the Owner for approval and made part of the Contract.

### **STAGING & PHASING**

Construction shall be staged within the construction area and minimize impacts to the school. The staging plan must be presented at the pre-construction meeting and approved by the Owner prior to commencement of construction. Hot-Mix Asphalt installation shall commence within five working days of pavement milling operations. Temporary aggregate shall be used as needed to maintain access to entrances at all times during construction and is considered incidental to the contract. All costs for remobilization to adhere to these contract requirements are considered included in the bid.

## Bid Package Instructions

### Instructions to Bidders on Filling out Forms:

1. The Bid Proposal Form must be signed by an authorized agent. The unit price(s), amount(s), date of signature, and any other relevant information must be stated.
2. The Bid Addenda Notice Form (if addendum are issued) must be signed by an authorized agent.
3. The BIDDER'S Bid Certification Form must be signed by an authorized agent. The date, notary public seal, and any other relevant information must be properly filled out.
4. The Bid Security must be signed by an authorized agent. The date, notary public seal, and any other relevant information must be properly filled out.
5. The Performance Reference Form must be properly filled out. The Owner requires that bidder provide at least three (3) references from projects performed by the bidder that are similar in scope, cost, and schedule. References provided shall be the project owner's key contact for the referenced project.
6. The Significant Subcontractor Form must be properly filled out if necessary. The bidder shall list all subcontractors that will be performing 20% or more of the value of the contract. The bidder shall also list any specialized subcontractors as listed in the pre-qualification statement under the scope of work.
7. The BIDDER'S Non-Collusion Certificate must be signed by an authorized agent. The date, notary public seal, and any other relevant information must be properly filled out.
8. The BIDDER'S Non-Conflict Certificate must be signed by an authorized agent. The date, notary public seal, and any other relevant information must be properly filled out.
9. The BIDDER'S Sexual Harassment Policy Statement must be signed by an authorized agent. The date, notary public seal, and any other relevant information must be properly filled out.
10. The BIDDER'S Certificate of Non-Discrimination must be signed by an authorized agent. The date, notary public seal, and any other relevant information must be properly filled out.
11. The BIDDER'S Prevailing Wage Statement & Prevailing Wage Requirements Notice must be signed by an authorized agent. The date, notary public seal, and any other relevant information must be properly filled out.

**IF THESE ELEVEN ITEMS ARE NOT PROPERLY FILLED OUT AND SUBMITTED WITH BID  
PRIOR TO THE ESTABLISHED DEADLINE,  
THE BID MAY BE REJECTED**



# Bid Proposal Form – Base Bid

## BASE BID

Round Lake Middle School 2023 Parking Lot Resurfacing  
 Round Lake Area Schools CUSD 116  
 May 23, 2023

Description: The work consists of 1.5" to 5" mill and resurfacing, 15" pavement removal and other associated improvements.

ITEM NO	DESCRIPTION	QUANTITY	UNIT	UNIT PRICE	TOTAL
20200100	Earth Excavation	180	CY	\$	\$
20201200	Removal and Disposal of Unsuitable Material	54	CY	\$	\$
21001000	Geotechnical Fabric For Ground Stabilization	1600	SY	\$	\$
28000510	Inlet Filters	9	EA	\$	\$
35102200	Aggregate Base Course, TY B, 10"	1600	SY	\$	\$
40603080	Hot-Mix Asphalt Binder Course, IL-19.0, N50, 3 1/2"	450	TN	\$	\$
40604060	Hot-Mix Asphalt Surface Course, Mix D, N50, 1 1/2"	680	TN	\$	\$
40800029	Bituminous Materials (Tack Coat)	6580	LBS	\$	\$
44000100	Pavement Removal	1600	SY	\$	\$
44000156	Hot-Mix Asphalt Surface Removal, 1 1/2"	5650	SY	\$	\$
44000169	Hot-Mix Asphalt Surface Removal, 5"	640	SY	\$	\$
44000500	Combination Curb and Gutter Removal	235	FT	\$	\$
44201692	Class D Patches, Type II, 4 Inch	63	SY	\$	\$
44201694	Class D Patches, Type III, 4 Inch	63	SY	\$	\$
44201696	Class D Patches, Type IV, 4 Inch	63	SY	\$	\$
60603800	Combination Concrete Curb and Gutter, Type B-6.12	235	FT	\$	\$
67100100	Mobilization	1	LS	\$	\$
78000100	Thermoplastic Pavement Marking - Letters and Symbols	176	SF	\$	\$
78000200	Thermoplastic Pavement Marking - Line 4"	4550	FT	\$	\$
<b>TOTAL BASE BID</b>				<b>\$</b>	

WRITTEN TOTAL PRICE:

---

COMPANY NAME: \_\_\_\_\_

COMPANAY AUHORTIZED REPRESENTATIVE:

\_\_\_\_\_  
 (Printed Name)

\_\_\_\_\_  
 (Signature)

DATE: \_\_\_\_\_

## **Bid Addendum Notice Form(s)**

*(if issued)*

Instructions:

- The notice forms shall be filled out completely
- Attach a signed copy of ALL addendum notices issued to this sheet

# Bid Certification Form

From: \_\_\_\_\_

\_\_\_\_\_  
 (Name Of Bidding Company)

(Name of Bidder)

\_\_\_\_\_  
 (Company Address # & Street Name + Suite # or PO Box)

(Bidder Phone #)

\_\_\_\_\_  
 (Company City, State, Zip)

(Bidder Email)

The undersigned, being an authorized representative of the Bidder, hereby certifies in accordance with Illinois State Statutes 720 ILCS 5/33E-11 that the Bidder is not barred from submitting a bid for this contract as a result of a violation of either Section 33E-3 or Section 33E-4 of Illinois State Statutes 720 ILCS 5/33E – “Public Contracts” concerning bid rigging, bid rotating, kickbacks, bribery, and other interference with public contracts.

The undersigned hereby certifies that they have examined and carefully prepared this proposal from the plans and specification and have checked the same in detail before submitting this proposal.

The undersigned declares that he/they understand(s) that where quantities are mentioned, they are approximate only, subject to increase or decrease, and that in such cases Bidder will take in full payment therefore the amount of the summation of the actual quantities, as finally determined, multiplied by the unit prices shown on the schedule of prices contained herein.

The undersigned certifies that he is familiar with all the local conditions affecting the cost of the Work, and hereby proposes to furnish all labor, materials, tools, and equipment necessary to perform and complete in a thorough workmanlike manner the construction as enumerated below all in accordance with the Contract Documents prepared by Gewalt Hamilton Associates, Inc., 625 Forest Edge Drive, Vernon Hills, Illinois 60061, and entitled:

**Round Lake Middle School  
 2023 Pavement Improvements  
 Bid Due Date: May 23, 2023**

\_\_\_\_\_, being duly sworn, deposes and say that he/she is the

(Print Name of bidder)

\_\_\_\_\_ of \_\_\_\_\_ and that the statements above are true and correct.

(Title)

(Company)

By: \_\_\_\_\_  
 (Bidder Signature)

Dated this \_\_\_\_\_ day of \_\_\_\_\_, \_\_\_\_\_  
 (date) (month) (year)

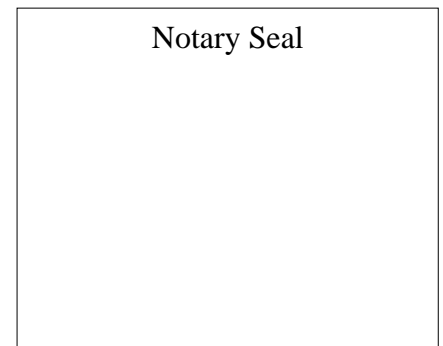

Notary:

Subscribed and sworn before me this \_\_\_\_\_ day of \_\_\_\_\_, \_\_\_\_\_  
(date) (month) (year)

**Bid Security**

Section 20410

Instructions:

- In the amount of 10% of base bid total
- The security must be signed by an authorized agent.
- The date, notary public seal, and any other relevant information must be properly filled out.
- The bond shall be filled out completely
- Attach an original to this page

# Performance Reference Form

Project Name & Year: \_\_\_\_\_  
Project Value: \_\_\_\_\_  
Owners Name: \_\_\_\_\_  
Owners Address: \_\_\_\_\_  
City & State: \_\_\_\_\_  
Owners Contact Person: \_\_\_\_\_  
Title/Position: \_\_\_\_\_  
Telephone Number: \_\_\_\_\_  
Contact Email: \_\_\_\_\_

Project Name & Year: \_\_\_\_\_  
Project Value: \_\_\_\_\_  
Owners Name: \_\_\_\_\_  
Owners Address: \_\_\_\_\_  
City & State: \_\_\_\_\_  
Owners Contact Person: \_\_\_\_\_  
Title/Position: \_\_\_\_\_  
Telephone Number: \_\_\_\_\_  
Contact Email: \_\_\_\_\_

Project Name & Year: \_\_\_\_\_  
Project Value: \_\_\_\_\_  
Owners Name: \_\_\_\_\_  
Owners Address: \_\_\_\_\_  
City & State: \_\_\_\_\_  
Owners Contact Person: \_\_\_\_\_  
Title/Position: \_\_\_\_\_  
Telephone Number: \_\_\_\_\_  
Contact Email: \_\_\_\_\_

# Significant Sub-contractor Form

*The bidder shall list all subcontractors that will be performing 20% or more of the value of the contract*

Scope of Work: \_\_\_\_\_  
Est. % of Contract Value \_\_\_\_\_  
Company Name: \_\_\_\_\_  
Address: \_\_\_\_\_  
City & State: \_\_\_\_\_  
Telephone Number: \_\_\_\_\_  
Contact Person: \_\_\_\_\_  
Contact Email: \_\_\_\_\_

Scope of Work: \_\_\_\_\_  
Est. % of Contract Value \_\_\_\_\_  
Company Name: \_\_\_\_\_  
Address: \_\_\_\_\_  
City & State: \_\_\_\_\_  
Telephone Number: \_\_\_\_\_  
Contact Person: \_\_\_\_\_  
Contact Email: \_\_\_\_\_

Scope of Work: \_\_\_\_\_  
Est. % of Contract Value \_\_\_\_\_  
Company Name: \_\_\_\_\_  
Address: \_\_\_\_\_  
City & State: \_\_\_\_\_  
Telephone Number: \_\_\_\_\_  
Contact Person: \_\_\_\_\_  
Contact Email: \_\_\_\_\_

# Non-Collusion Certification Form

By Submission of this proposal, the Bidder \_\_\_\_\_ certifies,  
(Name of Bidder)

That (s)he is \_\_\_\_\_ of \_\_\_\_\_ and,  
(Title ) (Name of Company)

under penalty of perjury, affirms:

1. The prices in this proposal have been arrived at independently without collusion, consultation, communication, or agreement, for the purpose of restricting competition, as to any matter relating to such prices with any other Bidder or with any competitor;
2. Unless otherwise required by law, the prices which have been quoted in this bid have not been knowingly disclosed by the Bidder and will not knowingly be disclosed by the Bidder prior to opening, directly or indirectly, to any other Bidder or to any competitor; and
3. No attempt has been made or will be made by the Bidder to induce any other person, partnership or corporation to submit or not submit a proposal for the purpose of restricting competition.
4. The proposal was not made in the interest of or on behalf of any undisclosed person, partnership, company, organization or corporation.
5. Each person signing the proposal certifies that:

(A) - (S)he is the person in the Contractor's organization responsible within that organization for the decision as to prices being offered in the proposal and that he has not participated and will not participate in any action contrary to (1-4] above;

Or

(B) - (S)he is not the person in the Contractor's organization responsible within that organization for the decision as to prices being offered in the proposal but that he has been authorized in writing to act as agent for the persons responsible for such decisions in certifying that such persons have not participated, and will not participate, in any action contrary to (1-4) above, and that as their agent, does hereby so certify; and that he has not participated, and will not participate in any action contrary to (1-4) above

## Non-Conflict of Interest Certification Form

By Submission of this proposal, the Bidder \_\_\_\_\_ certifies,  
(Name of Bidder)

That (s)he is \_\_\_\_\_ of \_\_\_\_\_ and,  
(Title ) (Name of Company)

under penalty of perjury, affirms:

1. I certify that neither I nor any member of my immediate family has a material personal or financial relationship with any other Bidder.
2. I certify that I have fully disclosed to the OWNER to the best of my knowledge, all circumstances under which this company, any immediate family members and/or other persons who work with the company have or may have any conflict of interest with the Owner.
3. I certify to fully disclose to the Owner any such circumstances that might arise during the contract period upon my becoming aware of such circumstances.
4. I certify that no other relationship, bias or ethical conflict exists which will prevent me from submitting this bid solely on its merits and in accordance with the bid's evaluation criteria.
5. I certify that if I am serving as the Procurement Officer of record, I agree to advise my supervisor of any changes that could appear to represent a conflict of interest.



# Sexual Harassment Policy

By Submission of this proposal, the Bidder \_\_\_\_\_ certifies,  
(Name of Bidder)

That (s)he is \_\_\_\_\_ of \_\_\_\_\_ and,  
(Title ) (Name of Company)

under penalty of perjury, affirms:

1. I certify pursuant to Section 2-105 of the Illinois Human Rights Act (775 ILCS 5/2-105) that BIDDER has a written sexual harassment policy that includes, at a minimum, the following information: (i) the illegality of sexual harassment; (ii) the definition of sexual harassment under State law; (iii) a description of sexual harassment, utilizing examples; (iv) an internal complaint process including penalties; (v) the legal recourse, investigative and complaint process available through the Department of Human Rights and Human Rights Commission; (vi) directions on how to contact the Department of Human Rights and Human Rights Commission; and (vii) protection against retaliation

## Certificate of Non-Discrimination

By Submission of this proposal, the Bidder \_\_\_\_\_ certifies,  
(Name of Bidder)

That (s)he is \_\_\_\_\_ of \_\_\_\_\_ and,  
(Title ) (Name of Company)

under penalty of perjury, affirms:

1. I certify pursuant BIDDER does not engage in discriminatory practices regarding employment or delivery of or access to services and programming and that it fully complies with the requirements of federal and State civil rights laws, including but not limited to: the Illinois Civil Rights Act of 2003, P.A. 93-0425; Illinois Human Rights Act, 775 ILCS 5/1-101 et seq.; the Americans with Disabilities Act, 42 U.S.C.12101 et seq., and the Rehabilitation Act of 1973, as amended, 29 USC 701 et seq., as well as the rules and regulations promulgated there under.
2. In certifying to the above, I hereby acknowledge that the School Board may declare any contract awarded pursuant to this bid void if this certification pursues false.

# Prevailing Wage Statement

By Submission of this proposal, the Bidder \_\_\_\_\_ certifies,  
(Name of Bidder)

That (s)he is \_\_\_\_\_ of \_\_\_\_\_ and,  
(Title ) (Name of Company)

under penalty of perjury, affirms:

1. I certify it shall be mandatory upon the BIDDERS to whom the contract is awarded and upon any subcontractor thereof to pay all laborers, workers, and mechanics employed by them not less than an up-to-date and current general prevailing rate of wages in the locality for each craft or type of workman or mechanic needed to perform such work and the current general prevailing rate for legal holidays and overtime pursuant to Illinois Department of Labor and pursuant to Illinois Law and Statutes in such cases made and provided. The Illinois Department of Labor will provide each County Clerk with the most recently revised prevailing wage rates determined by the Illinois Department of Labor on the first day of each month.

# Prevailing Wage Requirements

By Submission of this proposal, the Bidder \_\_\_\_\_ certifies,  
(Name of Bidder)

That (s)he is \_\_\_\_\_ of \_\_\_\_\_ and,  
(Title ) (Name of Company)

under penalty of perjury, affirms:

1. The above bidder or contractor hereby certifies that he is not barred from bidding on this contract as a result of either the bid-rigging or bid-rotation provision of Article 33E of the Criminal Code of 1961, as amended. He also certifies that he has read, understands and agrees that acceptance by the School District of the bidder's contract will create a binding contract.

## 2. REQUIREMENTS

- a. Contractor and each subcontractor shall comply with requirements of the "An Act regulating wages of laborers, mechanics and all other workmen employed in any public works by the State, County, City or any public body or any political subdivision or by anyone under contract for public works."
- b. If, during the course of the work under this contract, the Dept. of Labor revises the prevailing rate of hourly wages to be paid under this contract for any trade or occupation, the Contractor shall have the sole responsibility and duty to ensure that the revised prevailing rate of hourly wages is paid by the Contractor and all subcontractors to each worker to whom the revised rate is applicable. Revisions of the prevailing wage, as set forth above shall not result in an increase in the Contract Sum.

## 3. ACT AND ORDINANCES

- a. "An Act regulating wages of laborers, mechanics and other workmen employed in any public works by the State, County, City, or by any public body or political subdivision or by anyone under contract for public works. Illinois Revised Statutes. 1981. Chapter 48. Section 39s-1 through 39s-2".

# Bidding Conditions

## DEFINITIONS

The term "OWNER" whenever used in the contract documents shall be construed to Round Lake Area Schools Community Unit School District #116 (SD116) and any action required to be taken by the "OWNER" or "DISTRICT", unless otherwise specified, shall be taken by the SD116 or their designee(s).

The term "ENGINEER" or "PROJECT ENGINEER" whenever used in the contract documents shall be construed to mean the representative manager from Gewalt Hamilton Associates, Inc. of Vernon Hills, IL or the appointed representative.

The term "BIDDER" whenever used in the contract documents shall be construed to mean any person or firm submitting a bid to the OWNER or its appointed representative.

The term "CONTRACTOR" whenever used in the contract documents shall be construed to mean any person or firm having a contract with the OWNER for the work so specified or its appointed representative.

The term "Standard Specification" whenever used in this document shall be construed to mean the "Standard Specifications for Road and Bridge Construction" and "Supplemental Specifications and Recurring Special Provisions", dated April 1, 2022 the "Standard Specifications for Traffic Control Items"; the latest edition of the "Illinois Manual on Uniform Traffic Control Devices for Streets and Highways" in effect; all issued by the State of Illinois, Department of Transportation.

The term "Water & Sewer Specifications" whenever used in this document shall be construed to mean the "Standard Specifications for Water and Sewer Main Construction in Illinois", dated June 2014 available from the Associated General Contractors of Illinois or the Illinois Society of Professional Engineers.

The term "Contract Documents" is defined as those documents specifically identified in the Contract between the OWNER and CONTRACTOR, including but not limited to, the Notice to Bidders, Instructions to Bidders, General Conditions, Bid Proposal Form, Bidder's Certifications, Addenda, Pre-Bid Attendance Form, Contract, Performance Bond, Payment Bond, Notice of Award, Notice to Proceed, Contractor Certifications, and Change Orders executed subsequent to the Effective Date of the Contract, if any.

The term "Project and or Work" means the entirety of the work intended to be performed pursuant to the contract documents.

The term "Progress Schedule" shall mean the schedule, prepared and maintained by CONTRACTOR, which describes the sequence and duration of the work activities necessary to accomplish the work within the contract times.

The term "Project Manager" means the Owner's Representative or Construction Manager for matters involving the project.

The term "Provide" shall mean furnish, install and pay for.

The term "Schedule of Values" shall mean that schedule prepared and maintained by CONTRACTOR which allocates portions of the contract price to various portions of the work and used as the basis for reviewing CONTRACTOR's applications for payment.

The terms "Statute," "Law," "Regulation," "Code," and "Ordinance," shall be deemed to include all revisions, amendments, and supplements in effect as of commencement of the work, or subsequently enacted anytime during the progress of the work.

The term "Subcontractor" is defined as having a contract with the CONTRACTOR for the performance of any portion of the work and any subcontractor having a contract with any lower tiered subcontractor.

The term "Substantial Completion" means the stage whereby the work, or a designated portion thereof, is complete, operable and accessible in accordance with the contract documents so that the OWNER can fully occupy or use the project or the designated portion for its intended purpose without interruptions, and for which only minor or inconsequential punch list items need to be completed.

The term "Final Acceptance" means the stage whereby the project is completed with no work (original, extra, or punchlist) remaining on the project, all regulatory authority approvals have been received, and the OWNER has issued the "Start of Maintenance" certificate.

### **PREPARATION OF BID**

The BIDDER shall prepare their proposal on the attached proposal forms furnished by the OWNER. The BIDDER shall only furnish the necessary bid package forms when submitting. It is not recommended to supply the supplemental information of this project manual with the bid. It is not recommended to supply any additional CONTRACTOR information with this bid.

All blank spaces on the proposal page or pages, applicable to the subject specification, must be correctly completed in ink or type written. All signatures must be completed in ink.

The total bid amount is to be shown in both words and figures where indicated. In case of a discrepancy between words and figures, the words shall prevail, unless it clearly appears in the OWNER's opinion that the words rather than the figures are in error. BIDDERS are warned against making any erasures or alterations of any kind, and Proposals which contain omissions, erasures, conditions, alterations, or additions not called for may be rejected.

If BIDDER is a corporation, the President and Secretary shall execute the bid and the corporate seal shall be affixed. In the event this bid is executed by other than the President, attach hereto a certified copy of that section of corporate by-laws or other authorization by the corporation which permits the person to execute the offer for the corporation.

If BIDDER is a partnership, all partners shall execute the bid, unless one partner has been authorized to sign for the partnership, in which case, evidence of such authority satisfactory to the OWNER shall be submitted.

### **BID SECURITY**

All bids shall be accompanied by a bid security in the amount of 10% of the base bid amount. Bid securities shall be in the form of a bid bond, a certified check or cashier's check drawn on a responsible bank doing business in the United States and shall be made payable to the OWNER. All bids not accompanied by the proper bid security, when required, will be rejected.

The bid security of all except the three (3) lowest responsible BIDDERS will be returned within fourteen (14) calendar days after the opening of the bid. The bid security of the successful BIDDER will be returned by the OWNER after receipt and acceptance of a satisfactory performance bond and execution of the contract. The remaining bid securities of each BIDDER will be returned within fourteen (14) calendar days after the OWNER has awarded the contract and the contract is fully signed by all parties.

Written notification of award will be mailed to the lowest responsible BIDDER within ten (10) calendar days after approval of bid by the OWNER. The OWNER will hold a special Board Meeting on May 23, 2023 at 5:00pm to consider award of this contract. Failure on the part of the successful BIDDER to execute the contract and provide proper insurance, and any and all required performance and payment bonds within fifteen (15) calendar days of receipt of contact from owner shall be considered just cause to withdrawal the award. In such case the bid security of the lowest responsible BIDDER shall be forfeited as liquidated damages and not as a penalty.

### **SUBMISSION OF BID**

All bids must be delivered to the RLAS-116 Operations Center, 811 Sunset Drive, Round Lake, IL, in the care of Dr. Pamela Kibbons (Assistant Superintendent of Business) by the specified opening time of the bid. Bids arriving after the specified time will not be accepted.

Each proposal must be submitted on the bid form provided with these specifications and must be contained in a sealed envelope. Envelope should be marked clearly "Sealed Bid for Round Lake Middle School 2023 Pavement Improvements."

## **WITHDRAWAL OF BID**

BIDDERS may withdraw or cancel their proposals at any time prior to the advertised bid opening time by submitting a signed request to the OWNER. Telephone requests to withdraw a bid will not be considered. After the bid opening time, no bid shall be withdrawn or canceled for a period of ninety (90) calendar days. The successful BIDDER shall not withdraw or cancel its proposal after having been notified by the DISTRICT that said bid has been accepted.

BIDDERS must satisfy themselves, upon examination of these specifications, to the intent of the specifications. After the submission of the proposal, no complaint or claim that there was any misunderstanding in regard to items for bidding will be entertained from either party. If any BIDDERS is in doubt as to the true meaning of any part of the plans, specifications or other Contract Documents, they shall request an interpretation from the ENGINEER prior to bidding.

All bids shall be deemed final, conclusive and irrevocable, and once opened no bid shall be subject to correction or amendment for any error or miscalculation. No bid shall be withdrawn without the consent of the OWNER after the scheduled closing time for the receipt of the bids.

## **DISQUALIFICATION OF BID**

The following will be cause for disqualification of bids:

- a) Bids exceed monies available for the intended work;
- b) Failure to submit bid security or surety;
- c) Failure to offer to meet specified delivery or performance schedules;
- d) Failure to price out the bid in conformance to the required format; or qualification of price to protect the BIDDER from unknown future market conditions;
- e) Rights of the DISTRICT limited under any contract clause;
- f) Reasonable basis to suspect either conflict of interest or collusion among BIDDERS;
- g) BIDDER fails to submit required information, literature, or affidavits with bid;
- h) Late bids;
- i) Failure of any authorized person to sign any required forms or to sign the bid; and
- j) BIDDER is prohibited by local, state or federal law from entering into public contracts.
- k) The DISTRICT shall be held harmless should any individual or group file or attempt to file any action to disrupt, alter or stop this process. In the event that any such action occurs, the DISTRICT is released from its contract.



## **CONSIDERATION OF BID**

The OWNER shall accept the bid of the lowest responsible BIDDER on the basis that the bid is in the best interest of the OWNER to accept. In awarding the contract, in addition to price, the DISTRICT shall consider the following:

- a) The Board may inquire as to the financial stability of the contractor and may request financial references. Such information shall be provided by the bidder within 48 hours of the request.
- b) Nature and extent BIDDER's experience and efficiency with projects of similar size and character
- c) The ability, capacity, and skill of the BIDDER to perform the contract to provide the service required;
- d) Whether the BIDDER can perform the contract or provide the service promptly, or within the time specified, without delay or interference based on the quality of performance of previous contracts of services;
- e) The previous and existing compliance by the BIDDER with laws and ordinances relating to the contract or service;
- f) The ability to obtain required payment and performance bonds;
- g) The quality, availability, and adaptability of the supplies or contractual services to the particular use required;
- h) Ability to work cooperatively with the OWNER and its administration based on references;
- i) Past records of the BIDDER'S transaction with the OWNER, ENGINEER or with other entities as evidence of the BIDDER'S responsibility, character, integrity, reputation, judgment, experience, efficiency, and cooperativeness. No proposal will be accepted from or contract awarded to any person, firm or corporation that is in arrears or is in default to the OWNER and/or ENGINEER upon any debt or contract, or that is a defaulter, as surety or otherwise, upon any obligation to said OWNER and/or ENGINEER, or that has failed to perform faithfully any previous contract with the OWNER and/or ENGINEER.
- j) Any explanation or statement, which the bidder wishes to make, must be placed in the same envelope with the proposal, but shall be written separately and independently of the proposal and attached thereto. Unless the bidder so indicates, it is understood that the bidder has bid in strict accordance with these specification requirements. Alternate bids will be considered only secondarily to the contract specifications. Any alternates submitted must be thoroughly detailed to merit consideration.

## **REJECTION OF BID**

The DISTRICT reserves the right to reject any and all bids and waive any informality and any irregularities or defects in any or all proposals and to accept that bid which in its opinion is in the best interest of the DISTRICT. Any such decision shall be considered final. It is the intent of the DISTRICT to award a contract to the lowest responsible, responsive bidder meeting specifications which is in the best interest of the DISTRICT as determined by the Board of Education. While the financial responsibility of the Contractor is a significant concern, the Board is equally

concerned with ability of the Contractor to satisfactorily perform its contract so that the service will be provided in accordance with proposed contract documents. The DISTRICT may reject any and all bids, and may order a re-advertisement for new bids or waive the competitive bid process.

The OWNER reserves the right to accept or reject any and all proposals or disregard any formality or technical errors, when in its opinion the best interest of the OWNER will be served by such action.

**PROTEST OF BID**

In addition to the requirements of this bid document any BIDDER wishing to file a protest regarding the bid process may do so by giving written notice to the OWNER no later than seven (7) calendar days of the closing time and date of bid submissions. Any such notice should include the title of the section in protest, the closing date, and the nature of the protest. Any disputes concerning a question of fact under this bid shall be decided by the OWNER, whose decision shall be final and conclusive unless determined by a court of competent jurisdiction to have been fraudulent, capricious, arbitrary, or so grossly erroneous as to imply bad faith.

**NON-COLLUSION**

The BIDDER, shall by offering his/her signature on the Non-collusion statement form, agrees to the following: "BIDDER certifies: that this bid is made without any previous understanding, agreement or connection with any person or firm or corporation making a bid for the same item and is in all respect free, with outside control, collusion, fraud or other illegal action." Identical bids may be reported to the Justice Department, in conformance to the President's Executive Order No. 10936, 26 F.R. 3555 (1961), and to local or state investigative bodies.

**NO CONFLICT OF INTEREST**

The BIDDER, shall by offering his/her signature on the No Conflict of Interest statement form, agrees that no conflict of interest issues exist at the time of submission of this bid. In addition, non-conflict of interest statements must also be provided for any significant sub-contractors.

**UNIT PRICES AND QUANTITIES**

Each pay item should have a unit price and a total price. If no total price is shown or if there is a discrepancy between the unit price multiplied by the quantity, the unit price shall govern. If a unit price is omitted, the total price will be divided by the quantity in order to establish a unit price. Any quantities listed on the plans or in the specifications are approximate only.

**ADDENDA**

If a written addendum is issued, a copy of such addendum will be issued by one or more of the following methods; Email, fax transmittal, first-class mail, or overnight delivery. This notice will be issued to all holders of bid documents

known to the ENGINEER. It is the BIDDER's responsibility to ascertain that they have received all addenda issued to the bidding documents prior to submitting their bids. BIDDER's must provide written acknowledgment of receipt of each addendum issued with their bid submission. The information shall also be placed on file and be made available to the public per the Freedom of Information Act. No addenda shall be issued less than two (2) business days ahead of the scheduled bid opening date & time. The ENGINEER shall give a written interpretation of the matter in question. Only a written interpretation shall be binding and no BIDDERS shall rely upon any verbal interpretation or correction given by any other method.

### **PROJECT CONDITIONS**

The BIDDER acknowledges that, prior to submission of its bid, it has taken steps necessary to ascertain the nature and location of the work, and that it has investigated, confirmed, verified as correct and satisfied itself as to the general and local conditions which can affect the work or its costs, including but not limited to (1) location and load capacity of existing roadways, utilities, corresponding pavement, shoulders, curb and gutter, sanitary sewer, storm sewers, and water main, bearing upon transportation, disposal, handling and storage of materials; (2) the availability of labor, water, electric power and roads; (3) uncertainties of weather, river stages, or similar physical conditions at the site;(4) the conformation and conditions of the ground and existing detention ponds; (5) the character of equipment and facilities needed prior to and during work performance; (6) subsurface conditions at the site of work; (7) the quantities and qualities of all materials, equipment, and labor set forth in bid proposal, plans, drawings, and specifications that are necessary to complete all of the work as required under the contract documents; and (8) the location, condition, compatibility, configuration of all existing utilities and infrastructure. The BIDDER also acknowledges that it has verified as correct, confirmed, and satisfied itself as to the character, quality, and quantity of surface and subsurface materials, obstacles or conditions to be encountered insofar as this information is reasonably ascertainable from an inspection of the site, including all exploratory work done, if any, as well as from the drawings, plans, and specifications made part of the bidding documents. The BIDDER further acknowledges that it has reviewed, investigated, confirmed, verified as correct, and satisfied itself as to any supplemental reports such as geotechnical and environmental reports. Any failure of the BIDDER to take the actions described and acknowledged in this paragraph will not relieve the BIDDER from responsibility for estimating properly the difficulty and cost of successfully performing the work, or for proceeding to successfully perform the work without additional expense to the OWNER. ENGINEER and OWNER assume no responsibility for any conclusions or interpretations made by the BIDDER based on information made available by the ENGINEER or the OWNER of the project. Nor do the OWNER or ENGINEER assume responsibility for any understanding reached or representation made concerning conditions which can affect the work by any of its officers, agents or employees before the acceptance of the bid offer and execution of the contract, unless that understanding or representation is expressly stated in this contract.

### **CONTRACT CONDITIONS**

Before submitting a proposal, the BIDDER should carefully examine all of the contract documents, including the specifications. By the submission of a bid, the BIDDER will be understood to have read and fully informed himself

as to the contents of all of the documents. Should a BIDDER find any discrepancies, omission, ambiguities or conflicts among the contract documents, or be in doubt about their meaning, the BIDDER shall bring such questions to the attention of the OWNER'S REPRESENTATIVE not later than four (4) business days prior to the date of the scheduled bid opening date and time. **Bid Questions may be submitted to:** [Bids@RLAS-116.org](mailto:Bids@RLAS-116.org). No bid questions will be answered after 12:00pm/noon on Thursday, May 18, 2023. All bid question responses will be posted to the project website by 8:00am on Friday, May 19, 2023. The OWNER'S REPRESENTATIVE will review the questions and, where information sought is not already indicated or specified will issue a clarifying "Notice to Bidders," which will become a part of the contract documents. Neither the OWNER nor the ENGINEER will make or be responsible for any oral instructions and clarifications, and no such oral instructions or clarification shall be binding upon the OWNER or ENGINEER.

Upon award of the contract work, the successful BIDDER will be required to execute a contract with the OWNER.

# **CONTRACT DOCUMENTS**

## **Supplemental General Conditions**

### **Section 00200**

#### **1.0 CONTRACT DOCUMENTS**

- 1.1 The Contract Documents shall consist of the Owner/Contractor Agreement, the General Conditions and specifications, the Drawings, the Specifications, all Addenda issued prior to the bidding, and all modifications issued after execution of the Contract.
- 1.2 The Work encompasses all labor, materials, equipment and supplies required to complete the Project in a timely and workmanlike manner.
- 1.3 By executing the Contract, the Contractor represents that he has visited the site, familiarized himself with local conditions under which the Work is to be performed and verified his observations with the requirements of the Contract Documents.

#### **2.0 PROJECT ENGINEER**

- 2.1 The Project Engineer also referred to as the Engineer, shall be Gewalt Hamilton Associates, Inc., 625 Forest Edge Drive, Vernon Hills, Illinois 60061. (847-478-9700)
- 2.2 The Project Engineer will provide coordination of the Contract and shall act as the Owner's representative to both the Contractor and to the various governmental authorities.
- 2.3 The Engineer shall have access to all portions of the Work as well as to the Contractor's project records as required.
- 2.4 The Project Engineer shall have authority to make a recommendation to the owner to reject work, which does not conform to the Contract Documents. The Owner or their representatives shall also have the authority to do the same.

#### **3.0 OWNER**

- 3.1 The Owner is the person or entity identified as such in the Owner/Contractor Agreement and is referred to throughout the Contract Documents. The term Owner means the actual Owner or his authorized representative.

- 3.2 The Owner shall endeavor to forward all instructions to the Contractor through the Project Engineer rather than going directly to the Contractor. If the Owner deems it necessary, it may contact the Contractor directly.
- 3.3 If the Contractor fails to perform the Contract in accordance with the provisions therein, or fails to correct defective work, or persistently fails to carry out the work according to the Contract Documents, then the Owner may, by written order signed personally, or by an agent specifically empowered by the Owner in writing, order the Contractor to stop the Work, or any portion thereof, until the cause for such order has been eliminated.
- 3.4 If the Contractor defaults or neglects to carry out the Work in accordance with the Contract Documents, the Owner shall serve written notice to remedy such fault. If, within seven days of receipt of the notice, the Contractor has not remedied the fault, the Owner shall have the right to terminate the Contract.
- 3.5 If the Contractor defaults or neglects to carry out the Work in accordance with the Contract Documents and fails within a seven-day period after receipt of written notice from the Owner to commence and continue correction of such default or neglect with diligence and promptness, the Owner may, without prejudice to other remedies the Owner may have, correct such deficiencies. In such case an appropriate Change Order shall be issued deducting from payments then or thereafter due the Contractor the reasonable cost of correcting such deficiencies, including Owner's attorneys' fees and other Owner's expenses and compensation for the Project Engineer's additional services made necessary by such default, neglect or failure. If payments then or thereafter due the Contractor are not sufficient to cover such amounts, the Contractor shall pay the difference to the Owner.

#### **4.0 CONTRACTOR**

- 4.1 The Contractor is the person or entity identified as such in the Owner/Contractor Agreement and is referred to throughout the Contract Documents, without regard to whether the Work is actually performed by the Contractor or by a sub-contractor.
- 4.2 The Contractor shall supervise and direct all Work, to his best skill and attention. He shall be solely responsible for all construction means, methods, techniques, sequences and procedures and for coordinating all portions of the Work under this Contract. The Contractor shall advise the Project Engineer and the Owner's representative:
- (a) If the specified procedure deviates from good construction practice;
  - (b) If following the procedure will affect any warranties; or
  - (c) Of any objections which the Contractor may have to the procedure.

- 4.3 The Contractor shall be responsible to the Owner for the acts and omissions of his employees, sub-contractors and their agents and employees, and other persons or entities performing any portion of the Work for, or on behalf of, the Contractor or any of its Subcontractors.
- 4.4 Intentionally Omitted.
- 4.5 The Contractor shall be responsible for inspection of portions of Work already performed to determine that such portions are in proper condition to receive subsequent Work.
- 4.6 The Contractor shall coordinate all portions of the Work with other separate Owner employed contractors, if any.
- 4.7 The Contractor shall assign a competent, technically trained office project manager to this Project who shall handle all office functions including checking, approving, and coordinating shop drawings and approving purchasing and disbursement, pay-out requests and correspondence.
- 4.8 Unless otherwise provided in the Contract Documents, the Contractor shall provide and pay for all labor, materials, equipment, tools, construction equipment and machinery, water, heat, utilities, transportation, and other facilities and services necessary for the proper execution of the Work, whether temporary or permanent and whether or not incorporated or to be incorporated in the Work. Unless specifically permitted or required elsewhere in the Contract Documents, all Work shall be performed during regular working hours and the Contractor shall not permit Work to be performed on Sunday or legal holidays without the Owner's written consent. The Owner shall not be liable for any overtime without its prior written consent approving such Work.
- 4.9 Except in the case of minor changes in the Work authorized by the Project Engineer, the Contractor may make substitutions only with the consent of the Owner, after evaluation by the Project Engineer and in accordance with a Change Order or Construction Change Directive.
- 4.10 The Contractor shall enforce strict discipline and good order among the Contractor's employees and other persons carrying out the Work. The Contractor shall not permit employment of unfit persons or persons not properly skilled in tasks assigned to them. The Contractor shall be responsible for any damages to property or injuries to persons caused by the failure of the Contractor's employees to comply with any laws, rules or regulations as well as the rules, regulations and policies of the Owner.
- 4.11 The Contractor warrants to the Owner that all materials and equipment furnished under this Contract will be new unless otherwise specified, and that all Work will be of good quality, new, and free from faults and defects and in conformance with the Contract Documents. Work, materials, or equipment

not conforming to these requirements shall be considered defective. If required by the Project Engineer, the Contractor shall furnish satisfactory evidence as to the kind and quality of materials and equipment. The warranty will not be affected by the specification of any product or procedure, unless the Contractor objects promptly to such product or procedure and advises the Project Engineer of possible substitute products or procedures which will not affect the warranty. This warranty shall not be restricted by the limitations of any manufacturer's warranty. Inability or refusal of the Subcontractor or supplier responsible for the defective work to correct such work shall not excuse the Contractor from performing under the warranty.

- 4.12 If the Contractor fails to correct Work that is not in accordance with the requirements of the Contract Documents as required by Section 13.2.1 or fails to carry out Work in accordance with the Contract Documents, the Owner may issue a written order to the Contractor to stop the Work, or any portion thereof, until the cause for such order has been eliminated; however, the right of the Owner to stop the Work shall not give rise to a duty on the part of the Owner to exercise this right for the benefit of the Contractor or any other person or entity.
- 4.13 Permits, fees and notices: Unless otherwise provided in the Contract Documents, the Contractor shall secure and pay for all building permits as well as for other permits, fees, licenses, and inspections by government agencies necessary for proper execution and completion of the Work that are customarily secured after execution of the Contract and legally required at the time bids are received or negotiations concluded. The Contractor shall comply with and give notices required by applicable laws, statutes, ordinances, codes, rules and regulations, and lawful orders of public authorities applicable to performance of the Work. If the Contractor performs Work contrary to applicable laws, statutes, ordinances, codes, rules and regulations, or lawful orders of public authorities, the Contractor shall assume appropriate responsibility for such Work and shall bear the costs attributable to correction.
- 4.14 Intentionally Omitted.
- 4.15 The Contractor shall employ a competent superintendent and necessary assistants who shall be in attendance at the Project site during performance of the Work and shall supervise the Work. The superintendent shall represent the Contractor, and communications given to the superintendent shall be as binding as if given to the Contractor. Communications shall be confirmed on written request. The Superintendent's sole responsibility shall be supervision and coordination of the Work. Failure of the Contractor to supervise the job properly as determined by the Project Engineer and the Owner shall be deemed a default under the Contract Documents. The Contractor, as soon as practicable after award of the Contract, shall furnish in writing to the OWNER the name and qualifications of a proposed superintendent. The Project Engineer may reply within 14 days to the Contractor in writing stating (1) whether the Owner or the Project Engineer has reasonable objection to the proposed



superintendent or (2) that the Project Engineer requires additional time to review. Failure of the Project Engineer to reply within the 14-day period shall constitute notice of no reasonable objection. If the Owner or Project Engineer objects to the proposed superintendent, the Contractor shall tender another individual to the Owner through the Project Engineer in accordance with this Section. The Contractor shall not change the superintendent without the Owner's consent, which shall not unreasonably be withheld or delayed.

4.16 Intentionally Omitted.

4.17 Documents and Samples at the Site: The Contractor shall maintain one record copy of all drawings, specifications, and all other Contract Documents on-site. The Contractor and its Subcontractors shall maintain an accurate record of deviations and changes from the Contract Documents which occur in the Work; shall indicate all such deviations and changes on mylar sepias or in CAD format, as the Owner may request or the Contract Documents require; and shall turn over to the Project Engineer upon completion of the Work all such documents and information, such as final shop drawings and sketches, marked prints and similar data indicating the as-built conditions. Plumbing, HVAC and Electrical Contractors shall record all changes and deviations in their Work from what appears on the Contract Documents. The mylar sepias or CAD files of the Contract Documents shall be furnished by the Project Engineer and paid for by the Contractor. The cost of recording and documenting the changes or deviations shall be included in the contract price for the respective work. The as-built mylar sepias shall be delivered by the Contractor to the Project Engineer prior to the final acceptance of the Project and issuance of final payment.

4.18 Electronic Close-Out Documentation

A. General. Contractor to provide a complete project close-out documentation package in electronic format. This package shall include:

1. Issued for Construction Plans and Specifications
2. Project Record Documents
3. Approved Submittals
4. Operation and Maintenance Manuals, as applicable
5. Warranties
6. Owner training Videos, including those of ongoing maintenance (.WMV or .MP4 Format)
7. Project Close-Out Directory

B. The electronic close-out documentation shall be prepared by BHFX Imaging. **GCs / CMs are responsible for close-out fee.** Please contact Sarah Jacobs at 847-593-3161 x206 or [sarah.jacobs@bhfx.net](mailto:sarah.jacobs@bhfx.net) for Pricing and Close-out Organization Information.

C. In order to facilitate the Electronic Close-Out Documentation process, comply with the following procedures:

1. Contact BHFx Imaging for a Project Order Form a minimum of thirty days prior to the date of Substantial Completion to schedule a pre-closeout meeting.

Review the following:

- a. Format of documents. PDF electronic format of all documents.
  - b. Folder structure for storage and transfer of files.
  - c. Schedule for collection and turn-over of close-out documentation.
  - d. Record Document format procedures. Provide clean and accurate paper copies of the marked-up Record Documents (Drawings and Specifications) for scanning.
  - e. Provide contact information for the individual responsible for the collection and transfer of Electronic Close-Out Documentation Package contents.
  - f. Review a complete listing of Electronic Close-Out Documentation Package contents.
2. **Multi-Building Projects – Submittals must be sorted by building** (NOT APPLICABLE TO THIS PROJECT)
    - a. Each submittal must be assigned to a building
    - b. Submittals pertaining to multiple buildings must be labeled or tagged with all buildings associated with that particular file.
    - c. Building specific folders can be generated. Files pertaining to multiple buildings must be added to all appropriate folders.
  3. Provide all documentation to BHFx Imaging for processing no later than 30 days after the date of Substantial Completion.
  4. Schedule a training conference with the Owner's Representative, Construction Manager and BHFx Imaging to present the completed Electronic Close-Out Documentation Package.

4.19 All required shop drawings will be submitted directly to the Project Engineer. By submitting Shop Drawings, Product Data, Samples and similar submittals, the Contractor represents to the Owner and Project Engineer that the Contractor has (1) reviewed and approved them, (2) determined and verified materials, field measurements and field construction criteria related thereto, or will do so and (3) checked and coordinated the information contained within such submittals with the requirements of the Work and of the Contract Documents. The Contractor shall perform no portion of the Work for which the Contract Documents require submittal and review of Shop Drawings, Product Data, Samples or similar submittals until the respective submittal has been approved by the Project Engineer.

4.20 After the award of the Contract, a request by the Contractor for a substitution of materials or equipment in place of those specified in the Contract Documents will be considered only under one or more of the following conditions:

- (a) Required for compliance with interpretation of code requirements or insurance regulations then existing;
- (b) Unavailability of specified products, through no fault of the Contractor;

- (c) Subsequent information discloses inability of specified products to perform properly as required;
- (d) Manufacturer/fabricator refuses to certify or guarantee performance of specified product as required; or
- (e) When it is clearly seen, in the judgment of the Project Engineer that a substitution would be substantially to the Owner's best interests, in terms of cost, time, or other consideration.

Substitution requests shall be written, timely and accompanied by adequate technical and cost data. Requests shall include a complete description of the proposed substitutions, name of the material or equipment for which it is to be substituted, drawings, cuts, performance and test data, and any other data or information necessary for a complete evaluation by the Project Engineer.

- 4.21 **Cleaning Up:** The Contractor shall keep the premises free from accumulation of waste materials or rubbish caused by his operations on a daily basis. At the completion of the Work, he shall remove all his waste materials from the Project site as well as all tools, construction equipment, etc. If the Contractor fails to clean up as provided in the Contract Documents, the Owner may do so and Owner shall be entitled to reimbursement from the Contractor for all costs and expenses associated therewith.
- 4.22 **Use of Site:** The Contractor shall confine operations at the site to areas permitted by applicable laws, statutes, ordinances, codes, rules and regulations, and lawful orders of public authorities and the Contract Documents and shall not unreasonably encumber the site with materials or equipment.
- 4.23 **Cutting and Patching:** The Contractor shall be responsible for cutting, fitting or patching required to complete the Work or to make its parts fit together properly. All areas requiring cutting, fitting and patching shall be restored to the condition existing prior to the cutting, fitting and patching, unless otherwise required by the Contract Documents. The Contractor shall not damage or endanger a portion of the Work or fully or partially completed construction of the Owner or separate contractors by cutting, patching or otherwise altering such construction, or by excavation. The Contractor shall not cut or otherwise alter such construction by the Owner or a separate contractor except with written consent of the Owner and of such separate contractor; such consent shall not be unreasonably withheld. The Contractor shall not unreasonably withhold from the Owner or a separate contractor the Contractor's consent to cutting or otherwise altering the Work. Only trades persons skilled and experienced in cutting and patching shall perform such work.
- 4.24 The Contractor shall forward all communications to the CONSTRUCTION MANAGER.
- 4.25 Execution of the Contract by the Contractor is a representation that the Contractor has examined all conditions affecting the Work and is fully familiar with all the conditions thereon and affecting the same. As a result of such examination, Contractor hereby waives its rights under the *Public*

*Construction Contract Act, 30 ILCS 557/10*, to an increase in the Contract Sum or time for subsequently discovered subsurface, latent or unknown conditions on the site. Contractor hereby acknowledges that it has made its bid in an amount sufficient to compensate it for its knowing waiver of such rights. Any adjustment to Contract Sum or time as a result of subsequent-discovered conditions shall be made in accordance with, and only to the extent otherwise required by the Contract Documents.

- 4.26 The Contractor specifically acknowledges and declares that the Contract Documents are full and complete, are sufficient to have enabled the Contractor to determine the cost of the Work therein and that the Drawings, the Specifications, and all Addenda, are sufficient to enable the Contractor to construct the Work outlined therein in accordance with applicable laws, statutes, building codes and regulations, and otherwise to fulfill all its obligations hereunder. The Contractor further acknowledges that having carefully examined all Drawings, Specifications, and documents that there are no discrepancies or omissions in the Contract Documents.
- 4.27 Work Included: Throughout the construction the Project Engineer may require the Contractor to perform testing of various materials or installed items. The Contractor shall provide all material and assistance needed to perform inspection and testing required under pertinent other sections of these specifications.

## **5.0 SUBCONTRACTORS**

- 5.1 All sub-contractors must be approved by the Project Engineer and Owner prior to their entry onto the job site. Such approval may be secured during bidding or the Contractor may wait until he actually needs the sub-contractor. All Subcontracts shall be in writing, and shall be assignable by the Contractor to the Owner.
- 5.2 The Contractor shall not contract with a proposed person or entity to whom the Owner or Project Engineer has made reasonable and timely objection. The Contractor shall not be required to contract with anyone to whom the Contractor has made reasonable objection. If the Owner or Project Engineer has reasonable objection to a person or entity proposed by the Contractor, the Contractor shall propose another to whom the Owner or Project Engineer has no reasonable objection. If the proposed but rejected Subcontractor was capable of performing the Work, the Contract Sum and Contract Time shall be increased or decreased by the difference, if any, occasioned by such change, and an appropriate Change Order shall be issued before commencement of the substitute Subcontractor's Work. However, no increase in the Contract Sum or Contract Time shall be allowed for such change unless the Contractor has acted promptly and responsively in submitting names as required. The Contractor shall not substitute a Subcontractor, person or entity previously selected without written approval of Owner.

- 5.3 By appropriate written agreement, the Contractor shall require each Subcontractor, to the extent of the Work to be performed by the Subcontractor, to be bound to the Contractor by terms of the Contract Documents, and to assume toward the Contractor all the obligations and responsibilities, including the responsibility for safety of the Subcontractor's Work, which the Contractor, by these Documents, assumes toward the Owner and Project Engineer. Each subcontract agreement shall preserve and protect the rights of the Owner and Project Engineer under the Contract Documents with respect to the Work to be performed by the Subcontractor so that subcontracting thereof will not prejudice such rights, and shall allow to the Subcontractor, unless specifically provided otherwise in the subcontract agreement, the benefit of all rights, remedies and redress against the Contractor that the Contractor, by the Contract Documents, has against the Owner. Where appropriate, the Contractor shall require each Subcontractor to enter into similar agreements with Sub-subcontractors. The Contractor shall make available to each proposed Subcontractor, prior to the execution of the subcontract agreement, copies of the Contract Documents to which the Subcontractor will be bound, and, upon written request of the Subcontractor, identify to the Subcontractor terms and conditions of the proposed subcontract agreement that may be at variance with the Contract Documents. Subcontractors will similarly make copies of applicable portions of such documents available to their respective proposed Sub-subcontractors.
- 5.4 The Contractor shall be responsible for any and all Subcontractors working under it and shall carry insurance for all Subcontractors or ensure that they are carrying it themselves so as to relieve the Owner and Project Engineer for any liability.
- 5.5 Each sub-contractor shall submit a certificate of insurance to the OWNER prior to entry onto the Project site.

## **6.0 PAYMENTS & COMPLETION**

- 6.1 The Contractor shall submit payment requests on a monthly basis, noting units completed to-date, and unit amounts remaining. The Owner may withhold 10% on a cumulative basis from the project payments, this amount being paid to the Contractor upon completion of the Project. "A Sworn Contractor's Affidavit" shall be submitted with each payment request in sufficient form for the Owner to determine Contractor's right to payment and compliance with the Illinois *Mechanic's Lien Law*. Each payment request shall include executed waivers of lien in conformity with information set forth on a properly completed Contractor's Affidavit. In the event that the Owner is satisfied with Contractor's payment procedures, the Owner may accept partial waivers of lien of Subcontractors and suppliers who were included in the immediate preceding payment. The Contractor shall submit waivers on a current basis, but the Owner may allow Subcontractors and suppliers to be not more than one payment late with their partial waivers.

- 6.2 Decisions To Withhold Certifications For Payment: The Owner may decide not to certify payment and may withhold payment in whole or in part, to the extent reasonably necessary to protect the Owner, if the quality of the work is not in accordance with the contract documents. If the Owner is unable to certify payment in the amount of the invoice, the Owner will promptly issue payment for the amount of the Work completed in accordance with the contract documents. The Owner may decide not to certify payment because:
- defective work not remedied
  - third party claims filed or reasonable evidence indicating probable filing of such claims
  - failure of Contractor to make payments properly to Subcontractors for labor, materials or equipment
  - reasonable evidence that the work cannot be completed for the unpaid balance of the Contract Sum
  - damage to the Owner or another contractor
  - reasonable evidence that the work will not be completed within the Contract period and that the unpaid balance would not be adequate to cover actual or liquidated damages for the anticipated delay
  - persistent failure to carry out work in accordance with Contract Documents.
- 6.3 Final Inspection: The Owner and the Project Engineer shall inspect the project and produce a final punch list once the contract Work is substantially completed. The Contractor shall remedy the points noted on the punch list and shall request re-inspection when the list is completed. If the Owner incurs costs due to multiple inspections of the work, whether for substantial completion, final completion or otherwise, the Contractor shall pay such costs by a back charge.
- 6.4 The date of substantial completion shall be the date when the Project Engineer, and the Owner substantially accept the Project improvements.
- 6.5 Final Payment: Upon completion of the punch list and satisfactory inspection by the Owner, and the Project Engineer, the Contractor shall request final payment. The Owner shall review the request and release payment to the Contractor.
- 6.6 Neither final payment nor any remaining retained percentage shall become due until the Contractor submits to the Project Engineer (1) an affidavit that payrolls, bills for materials and equipment, and other indebtedness connected with the Work for which the Owner or the Owner's property might be responsible or encumbered (less amounts withheld by Owner) have been paid or otherwise satisfied, (2) a certificate evidencing that insurance required by the Contract Documents to remain in force after final payment is currently in effect and will not be canceled or allowed to expire until at least 30 days' prior written notice has been given to the Owner, (3) a written statement that the Contractor knows of no substantial reason that the insurance will not be renewable to cover the

period required by the Contract Documents, (4) consent of surety, if any, to final payment and (5), if required by the Owner, other data establishing payment or satisfaction of obligations, such as receipts, releases and waivers of liens, claims, security interests or encumbrances arising out of the Contract, to the extent and in such form as may be designated by the Owner. If a Subcontractor refuses to furnish a release or waiver required by the Owner, the Contractor may furnish a bond satisfactory to the Owner to indemnify the Owner against such lien. If such lien remains unsatisfied after payments are made, the Contractor shall refund to the Owner all money that the Owner may be compelled to pay in discharging such lien, including all costs and reasonable attorneys' fees. Acceptance of final payment by the Contractor, a Subcontractor or material supplier shall constitute a waiver of claims by that payee except those previously made in writing and identified by that payee as unsettled at the time of final Application for Payment.

- 6.7 The Contractor warrants that title to all Work covered by an Application for Payment will pass to the Owner no later than the time of payment. The Contractor further warrants that upon submittal of an Application for Payment all Work for which Certificates for Payment have been previously issued and payments received from the Owner shall, to the best of the Contractor's knowledge, information and belief, be free and clear of liens, claims, security interests or encumbrances in favor of the Contractor, Subcontractors, material suppliers, or other persons or entities making a claim by reason of having provided labor, materials and equipment relating to the Work.
- 6.8 Notwithstanding any other provision in any Contract Document, the Owner shall not, in any manner, be deemed or intended to have waived any claim by making a final payment or progress payment of any amount.
- 6.9 Liens: Neither the final payment nor any part of any retained percentages, shall become due until the contractor, if required, delivers to the Owner, a complete release of all liens arising out of this contract, or receipts in full in lieu thereof and, if required in either case, an affidavit that so far as he has knowledge or information the releases and receipts include all the labor and material for which a lien could be filed. If any lien remains unsatisfied after all payments are made the contractor shall refund to the Owner all moneys that the latter may be compelled to pay in discharging such a lien, including all costs and reasonable attorney's fees.

## **7.0 SAFETY PROGRAMS & RESPONSIBILITIES**

- 7.1 The Contractor shall be responsible for initiating, maintaining, and supervising all safety precautions and programs connected with the Work.
- 7.2 The Contractor shall notify Owner, in writing, of any actual or possible claim for personal injury or property damage relating to the Work, or of any occurrence which might give rise to such a claim,

promptly upon obtaining the first knowledge of same. The notice shall be in writing and shall provide sufficient detail for the Owner to investigate the incident or claim.

**8.0 INSURANCE**

8.1 Prior to the commencement of the work, the Contractor shall submit a certificate of insurance to the Owner’s Representative, evidencing the request of this Section 8.0. **Additionally, all insurance required of the Contractor, including any/all subcontractors, with the sole exception of worker’s compensation insurance, shall name the OWNER (Round Lake Area Schools Community Unit School District 116), its individual Board members, officials, employees and agents, and the ENGINEER (Gewalt Hamilton Associates, Inc.) as additional insureds thereon.**

8.1.1 During the term of the Contract, the Contractor and each sub-contractor shall at their own expense, purchase and maintain the following insurance in companies properly licensed and satisfactory to Owner with at least the minimum stated.

8.1.2 Worker's Compensation:  
In the amount required by law

8.1.3 Employer's Liability:  
At least \$1,000,000 each accident for bodily injury by accident and each employee for bodily injury by owner.

8.1.4 Comprehensive General Liability:

\$1,000,000 per occurrence and in the aggregate	
Include Complete Operations	
Each Occurrence	\$1,000,000
Aggregate	\$2,000,000

8.1.5 Automobile Liability

All autos:	
Bodily Injury Each Person	\$1,000,000
Bodily Injury Each Occurrence	\$1,000,000
Property Damage Each Occurrence	\$100,000

8.1.6 Umbrella or excess liability insurance \$10,000,000  
The Umbrella or excess insurance shall follow the form of the underlying insurance.



8.2 Other Insurance:

- 8.2.1 Include coverage for direct operations, sublet work, and contractual liability.
- 8.2.2 Completed Operations and Products Liability: Maintain in force for one year after final payment.
- 8.2.3 "XCU" Coverage: Remove exclusions (explosion, collapse, underground property damage).
- 8.2.4 Liability insurance may be arranged by combining Commercial General Liability and Automobile Liability policies for the full limits required; or by a combination of underlying Commercial Liability policies for lesser limits with the remaining limits provided by an Excess or Umbrella Liability policy.
- 8.2.5 Contractor shall require sub-contractors not protected under his insurance to take out and maintain worker's compensation insurance and insurance of the same kind in amounts specified above and naming the additional insureds required above. Contractor shall submit evidence of coverage of insurance required.
- 8.2.6 Contractor shall carry sufficient insurance on his equipment at site of Work and on route to and from site to fully protect him. Contractor shall require same coverage of his sub-contractors. It is expressly understood and agreed that Owner shall have no responsibility therefore. All insurance of the Contractor shall be primary and non-contributory. Additionally, Contractor waives any rights of subrogation it or any of its insurers may have against any of the additional insureds.
- 8.2.7 The Contractor waives all rights against the Owner, its individual Board members, agents, employees and consultants, as well as the Engineer and its officers, agents and employees for any loss or damage to the extent such loss or damage is covered by insurance. The Contractor shall require all subcontractors and all sub-subcontractors, by appropriate agreement, to contain such similar waivers in favor of the parties enumerated herein.
- 8.2.8 All insurance required of the Contractor and all Subcontractors shall state that the coverage afforded to the additional insureds shall be primary insurance of the additional insureds and not contributing with any other insurance or similar protection available to the additional insureds, whether said other available coverage by primary, contributing or excess. If the additional insureds have other insurance which is applicable to the loss, it shall be deemed to be on an excess or contingent basis. It is the intent of the Parties that the insurance of

all other additional insureds be fully and completely exhausted before the Owner's policy becomes applicable to the loss.

## **9.0 CHANGES IN THE WORK**

9.1 Changes in the Work may be accomplished after execution of the Contract, and without invalidating the Contract, by Change Order, Construction Change Directive or order for a minor change in the Work, subject to the limitations in the Contract Documents. A Change Order shall be based upon agreement among the Owner, Contractor and Project Engineer; a Construction Change Directive requires agreement by the Owner and Project Engineer and may or may not be agreed to by the Contractor; an order for a minor change in the Work may be issued by the Project Engineer or the Owner. Changes in the Work shall be performed under applicable provisions of the Contract Documents, and the Contractor shall proceed promptly, unless otherwise provided in the Change Order, Construction Change Directive or order for a minor change in the Work.

9.2 Change Orders: A Change Order is a written instrument prepared by the Contractor and signed by the Owner, Contractor and Project Engineer stating their agreement upon all of the following:

1. The change in the Work;
2. The amount of the adjustment, if any, in the Contract Sum; and
3. The extent of the adjustment, if any, in the Contract Time.

As required by *The Criminal Code, Section 33E Public Contracts (720 ILCS 5/33E-9)*, any changes which authorize or necessitate an increase or decrease in either the cost of the contract by \$10,000 or more of the time of completion of the Work by 30 days or more may only be made upon the written authorization of the Owner and only upon the written determination of the Owner that:

1. The circumstances necessitating the change were not reasonably foreseeable at the time the contract was signed; or
2. The change is germane to the original contract as signed; or
3. The change order is in the best interest of the owner and is authorized by law.

9.3 Construction Change Directives: A Construction Change Directive is a written order prepared by the Project Engineer and signed by the Owner and Project Engineer, directing a change in the Work prior to agreement on adjustment, if any, in the Contract Sum or Contract Time, or both. The Owner may by Construction Change Directive, without invalidating the Contract, order changes in the Work within the general scope of the Contract consisting of additions, deletions or other revisions, the Contract Sum and Contract Time being adjusted accordingly. A Construction Change Directive shall be used in the absence of total agreement on the terms of a Change Order. If the Construction Change Directive provides for an adjustment to the Contract Sum, the adjustment shall be based on one of the following methods:

1. Mutual acceptance of a lump sum properly itemized and supported by sufficient substantiating data to permit evaluation;
2. Unit prices stated in the Contract Documents or subsequently agreed upon;
3. Cost to be determined in a manner agreed upon by the parties and a mutually acceptable fixed or percentage fee; or
4. As otherwise provided in this Section.

Upon receipt of a Construction Change Directive, the Contractor shall promptly proceed with the change in the Work involved and advise the Project Engineer of the Contractor's agreement or disagreement with the method, if any, provided in the Construction Change Directive for determining the proposed adjustment in the Contract Sum or Contract Time.

A Construction Change Directive signed by the Contractor indicates the Contractor's agreement therewith, including adjustment in Contract Sum and Contract Time or the method for determining them. Such agreement shall be effective immediately and shall be recorded as a Change Order.

If the Contractor does not respond promptly or disagrees with the method for adjustment in the Contract Sum, the Project Engineer shall determine the method and the adjustment on the basis of reasonable expenditures and savings of those performing the Work attributable to the change, including, in case of an increase in the Contract Sum, an amount for overhead and profit as set forth in the Agreement, or if no such amount is set forth in the Agreement, a reasonable amount. In such case, the Contractor shall keep and present, in such form as the Project Engineer may prescribe, an itemized accounting together with appropriate supporting data. Unless otherwise provided in the Contract Documents, costs for the purposes of this Section shall be limited to the following:

1. Costs of labor, including social security, old age and unemployment insurance, fringe benefits required by agreement or custom, and workers' compensation insurance;
2. Costs of materials, supplies and equipment, including cost of transportation, whether incorporated or consumed;

3. Rental costs of machinery and equipment, exclusive of hand tools, whether rented from the Contractor or others;
4. Costs of premiums for all bonds and insurance, permit fees, and sales, use or similar taxes related to the Work; and
5. Additional costs of supervision and field office personnel directly attributable to the change.

Overtime when specifically authorized by the Owner shall be paid for by the Owner on the basis of a premium payment only, plus the cost of insurance and taxes based on the premium payment. Overhead and profit will not be paid by the Owner for overtime. Contractor shall submit a detailed, itemized breakdown of quantities and unit costs, including overhead and profit as separate items with response to request for price.

The amount of credit to be allowed by the Contractor to the Owner for a deletion or change that results in a net decrease in the Contract Sum shall be actual net cost as confirmed by the Project Engineer. When both additions and credits covering related Work or substitutions are involved in a change, the allowance for overhead and profit shall be figured on the basis of net increase or decrease, if any, with respect to that change. Pending final determination of the total cost of a Construction Change Directive to the Owner, the Contractor may request payment for Work completed under the Construction Change Directive in Applications for Payment.

- 9.4 Minor Changes in the Work: The Project Engineer has authority to order minor changes in the Work not involving adjustment in the Contract Sum or extension of the Contract Time and not inconsistent with the intent of the Contract Documents. Such changes will be effected by written order signed by the Project Engineer and shall be binding on the Owner and Contractor.
- 9.5 Deduction for Uncorrected Work: If the Owner deems it in-expedient to correct work damaged or not done in accordance with the contract, the difference in value, together with a fair allowance for damage shall be deducted from the contract amount due. The value of such deduction shall be determined by the Owner.

## **10.0 HOLD HARMLESS AGREEMENT & INDEMNIFICATION**

- 10.1 Contractor agrees to indemnify, hold harmless and defend SD116 members of the Board of Education, employees, students, teachers, and any agents thereof against all suits, actions, legal proceedings, claims and demands, and against all damage, loss, cost, expense and attorney's fees, in any manner caused by, arising from, incident to, connected with growing out of the performance of this contract. The contractor shall agree to indemnify, hold harmless, and defend the School District, members of the Board of Education, officers, employees, students, teachers and agents from and against all suits, actions, legal proceedings, claims and demands of every

nature, and against all damages, loss, cost, expense and attorney's fees on account or injury to, or death of persons, or damage to, or loss of property caused by, or resulting in any manner from acts or omissions, negligent or otherwise, of the contractor, its agents or employees, in performing or failing to perform, any of the services, duties or operations to be performed by the said contractor under the terms of the contract.

- 10.2 In any and all claims by an employee of Contractor, any Subcontractor, anyone directly or indirectly employed by any of them or anyone for whose acts any of them may be liable, the indemnification obligations in the Contract Documents shall not be limited in any way by any limitation on the amount or type of damages, compensation or benefits payable by or for Contractor or any Subcontractor under workers' or workmen's compensation acts, disability benefit acts or other employee benefit acts. Contractor and every Subcontractor agree to assume the entire liability for all personal injury claims suffered by their own employees allegedly injured on the Project and waive any limitation of liability defense based on workers' compensation acts, or interpretations thereof, against claims by Owner for indemnification or contribution, and further agree to indemnify and defend Owner and their board members, agents and employees and consultants (Indemnitees) from and against all such claims, damages, losses and expenses, including reasonable attorneys' fees, that the Indemnitee's may sustain as a result of such claims, except to the extent that Illinois law prohibits indemnity for the Indemnitee's own negligence, and further agree to pay any contribution appropriate for Contractor's and Subcontractors' own negligence. Contractor shall ensure that this provision is inserted in every contract between Contractor and Subcontractors. If such provision is not contained within a Subcontractor contract, or if a Subcontractor's insurance does not cover or is insufficient to pay such claims, Contractor shall assume all Subcontractor liability for such indemnification of or contribution to Owner.
- 10.3 "Claims, damages, losses and expenses" as these words are used in the Contract Documents shall be construed to include, but not be limited to (1) injury or damage consequent upon the failure of or use or misuse by Contractor, its Subcontractors, agents, servants or employees, of any hoist, rigging, blocking, scaffolding, or any and all other kinds of items of equipment, whether or not the same be owned, furnished or loaned by Owner; (2) all attorneys' fees, court costs, expert witness fees and costs incurred in defense of the claim or in bringing an action to enforce the provisions of this Indemnity or any other indemnity contained in the Contract Documents; and (3) all costs, expenses, lost time, opportunity cost, etc. incurred by the party being indemnified or its employees, agents or consultants.
- 10.4 Contractor's indemnity obligations shall, but not by way of limitation, specifically include all claims and judgments which may be made against the indemnities under federal or state law or the law of other governmental bodies having jurisdiction, and further, against claims and judgments arising

from violation of public ordinances and requirements of governing authorities due to Contractor's or Contractor's employees' method of execution of the Work.

- 10.5 To the extent prohibited by the *Construction Contract Indemnification for Negligence Act*, 740 ILCS 35/1, the indemnification obligations of Contractor under the Contract Documents shall not extend to the liability of Owner, any Owner's Representative, or the Engineer, or their agents, consultants or employees, arising out of their own negligence.
- 10.6 If the Work is to be performed by trade unions, the Contractor shall make all necessary arrangements to reconcile, without delay, damage, or cost to the Owner and without recourse to the Engineer, or the Owner, any conflict between the Contract Documents and any agreements or regulations of any kind at any time in force among members or council which regulate or distinguish what activities shall not be included in the Work of any particular trade. In case the progress of the Work is affected by any undue delay in furnishing or installing any items or materials or equipment required under the Contract Documents because of the conflict involving any such agreement or regulation, the Engineer may require that other material or equipment of equal kind and quality be provided by the Contractor at no additional cost to the Owner.

## **11.0 DELAYS & EXTENSIONS OF TIME**

- 11.1 If the Contractor is delayed at any time in the progress of the Work by any act or neglect of the Owner, Owner's employees, any separate contractor employed by the Owner by changes ordered in the Work (which changes do not result, in whole or in part, from neglect of the Contractor, its agents or employees or subcontractors), regional labor disputes as they affect the Work that cannot be resolved by the Contractor agreeing to the wages, hours and working conditions as they have been established as the pattern settlement with respect to the said dispute, fire which does not result from any willful or negligent act of the Contractor, any subcontractors or any of their respective agents or employees, an unusual delay in transportation that could not have been prevented by the Contractor's planning or adequate investigation of conditions, unusually severe weather conditions not reasonably anticipated, or delay authorized by the Owner, the date of Substantial Completion shall be extended by Change Order for such reasonable time as the Project Engineer shall determine. It is further understood that only delays caused by the conditions listed above which the Contractor could not reasonably anticipate, are beyond the Contractor's control and which delays could not have been mitigated by the Contractor will be sufficient to extend the Substantial Completion date. The Contractor has an affirmative duty to inquire and make reasonable investigation where circumstances would alert the reasonable Contractor to a potential delay for whatever reason. The criteria on which the term "unusually severe weather" shall be based is the normal average amount of precipitation received in the project area, as recorder over a period of the last five (5) years at the local are United States Weather Station. Any extension of

time due to unusually severe weather must be requested by the Contractor on the basis of documented records of the actual precipitation for a minimum period of three (3) months time, compared with the normal average for the area. Also, the criteria shall include the number of excessive precipitation days over the same period and whether or not the Contractor's force worked on said days or any stage of construction was affected.

- 11.2 Where a delay occurs which is beyond the Contractor's control, the Contractor has an affirmative duty to mitigate the effect of that delay on the progress of the Work. An extension of the Substantial Completion date will not be granted to the extent that the Contractor breaches said duty to mitigate.
- 11.3 The Contractor shall not be entitled to recover from the Owner, and hereby waives all rights which it or its Subcontractors or any other person may otherwise have to recover, any costs, expenses and damages of any nature which it or its Subcontractors or any other person, may suffer by reason of delay in the performance of the Work or any portion thereof for any reason, the extension of Contract Time granted herein being the Contractor's sole and exclusive remedy.
- 11.4 The date of final completion of the Work is the date of the Owner's written acceptance of the Project Engineer's final Certificate for Payment or the Owner's issuance of final payment, whichever occurs first.

## **12.0 HAZARDOUS MATERIALS**

- 12.1 The Contractor is responsible for compliance with any requirements included in the Contract Documents regarding hazardous materials. If the Contractor encounters a hazardous material or substance not addressed in the Contract Documents and if reasonable precautions will be inadequate to prevent foreseeable bodily injury or death to persons resulting from a material or substance, including but not limited to asbestos or polychlorinated biphenyl (PCB), encountered on the site by the Contractor, the Contractor shall, upon recognizing the condition, immediately stop Work in the affected area and report the condition to the Owner and Project Engineer in writing.
- 12.2 Upon receipt of the Contractor's written notice, the Owner shall obtain the services of a licensed laboratory to verify the presence or absence of the material or substance reported by the Contractor and, in the event such material or substance is found to be present, to cause it to be rendered harmless. When the material or substance has been rendered harmless, Work in the affected area shall resume. By Change Order, the Contract Time shall be extended appropriately and the Contract Sum shall be increased in the amount of the Contractor's reasonable actual additional costs of shut-down, delay and start-up.

- 12.3 The Owner shall not be responsible under this Section 12.3 for materials or substances the Contractor brings to the site unless such materials or substances are required by the Contract Documents. The Owner shall be responsible for materials or substances required by the Contract Documents, except to the extent of the Contractor's fault or negligence in the use and handling of such materials or substances.
- 12.4 The Contractor shall indemnify the Owner for the cost and expense the Owner incurs (1) for remediation of a material or substance the Contractor brings to the site, or (2) where the Contractor fails to perform its obligations under this Section, except to the extent that the cost and expense are due to the Owner's fault or negligence.

### **13.0 UNCOVERING & CORRECTION OF WORK**

- 13.1 Uncovering of Work: If a portion of the Work is covered contrary to the Project Engineer's request or to requirements specifically expressed in the Contract Documents, it must, if requested in writing by the Project Engineer, be uncovered for the Project Engineer's examination and be replaced at the Contractor's expense without change in the Contract Time. If a portion of the Work has been covered that the Project Engineer has not specifically requested to examine prior to its being covered, the Project Engineer may request to see such Work and it shall be uncovered by the Contractor. If such Work is in accordance with the Contract Documents, costs of uncovering and replacement shall, by appropriate Change Order, be at the Owner's expense. If such Work is not in accordance with the Contract Documents, all costs, fees and expenses and the cost of correction, including but not limited to testing fees, shall be at the Contractor's expense unless the condition was caused by the Owner or a separate contractor in which event the Owner shall be responsible for payment of such costs.
- 13.2 Correction of Work
- 13.2.1 Before or After Substantial Completion: The Contractor shall promptly correct Work rejected by the Project Engineer or failing to conform to the requirements of the Contract Documents, whether discovered before or after Substantial Completion and whether or not fabricated, installed or completed. Costs of correcting such rejected Work, including additional testing and inspections, the cost of uncovering and replacement, and compensation for the Project Engineer's services and expenses made necessary thereby, shall be at the Contractor's expense.



13.2.2 After Substantial Completion: If, within one year after the date of Substantial Completion of the Work or designated portion thereof or after the date for commencement of warranties, or by terms of an applicable special warranty required by the Contract Documents, any of the Work is found to be not in accordance with the requirements of the Contract Documents, the Contractor shall correct it promptly after receipt of written notice from the Owner to do so. The one-year period for correction of Work shall be extended with respect to portions of Work first performed after Substantial Completion by the period of time between Substantial Completion and the actual completion of that portion of the Work. In the case of any Work performed in correcting defects pursuant to the guarantees provided or referred to by this Section 13, the guarantee period specified or referenced to by Section 13 shall begin anew from the date of completion of such Work. The Contractor shall remove from the site portions of the Work that are not in accordance with the requirements of the Contract Documents and are neither corrected by the Contractor nor accepted by the Owner. The Contractor shall bear the cost of correcting destroyed or damaged construction, whether completed or partially completed, of the Owner or separate contractors caused by the Contractor's correction or removal of Work that is not in accordance with the requirements of the Contract Documents. Nothing contained in this Section 13.2.2 shall be construed to establish a period of limitation with respect to other obligations the Contractor has under the Contract Documents. Establishment of the one-year period for correction of Work as described in this Section relates only to the specific obligation of the Contractor to correct the Work, and has no relationship to the time within which the obligation to comply with the Contract Documents may be sought to be enforced, nor to the time within which proceedings may be commenced to establish the Contractor's liability with respect to the Contractor's obligations other than specifically to correct the Work.

13.3 Acceptance of Nonconforming Work: If the Owner prefers to accept Work that is not in accordance with the requirements of the Contract Documents, the Owner may do so instead of requiring its removal and correction, in which case the Contract Sum will be reduced as appropriate and equitable. Such adjustment shall be effected whether or not final payment has been made.

#### **14.0 MISCELLANEOUS PROVISIONS**

14.1 The Contract shall be governed by the law of the place where the Project is located. The project is located in the State of Illinois, Lake County.

14.2 The Owner and Contractor respectively bind themselves, their partners, successors, assigns and legal representatives to covenants, agreements and obligations contained in the Contract Documents. Except as provided in this Section, neither party to the Contract shall assign the Contract as a whole without written consent of the other. If either party attempts to make such an assignment without such consent, that party shall nevertheless remain legally responsible for all obligations under the Contract. The Owner may, without consent of the Contractor, assign the Contract to a lender providing construction financing for the Project, if the lender assumes the Owner's rights and obligations under the Contract Documents. The Contractor shall execute all consents reasonably required to facilitate such assignment.

14.3 Written notice shall be deemed to have been duly served if delivered in person to the individual, to a member of the firm or entity, or to an officer of the corporation for which it was intended; or if delivered at, or sent by registered or certified mail or by courier service providing proof of delivery to, the last business address known to the party giving notice.

14.4 Duties and obligations imposed by the Contract Documents and rights and remedies available thereunder shall be in addition to and not a limitation of duties, obligations, rights and remedies otherwise imposed or available by law. No action or failure to act by the Owner, Project Engineer or Contractor shall constitute a waiver of a right or duty afforded them under the Contract, nor shall such action or failure to act constitute approval of or acquiescence in a breach there under, except as may be specifically agreed in writing or as specifically provided in the Contract Documents.

14.5 **Termination or Suspension of the Contract**

14.5.1 **Termination by the Contractor:** The Contractor may terminate the Contract if the Work is stopped for a period of 30 consecutive days through no act or fault of the Contractor or a Subcontractor, Sub-subcontractor or their agents or employees or any other persons or entities performing portions of the Work under direct or indirect contract with the Contractor, for any of the following reasons:

1. Issuance of an order of a court or other public authority having jurisdiction that requires all Work to be stopped;
2. An act of government, such as a declaration of national emergency that requires all Work to be stopped; or
3. Because the Project Engineer has not issued a Certificate for Payment and has not notified the Contractor of the reason for withholding certification, or because the Owner has not made payment on a Certificate for Payment within the time stated in the Contract Documents.

The Contractor may terminate the Contract if, through no act or fault of the Contractor or a Subcontractor, Sub-subcontractor or their agents or employees or any other persons or entities performing portions of the Work under direct or indirect contract with the Contractor, repeated

suspensions, delays or interruptions of the entire Work by the Owner as described in Section 14.5.3 constitute in the aggregate more than 100 percent of the total number of days scheduled for completion, or 120 days in any 365-day period, whichever is less.

If one of the reasons described in Section 14.5.1 or 14.5.2 exists, the Contractor may, upon seven days' written notice to the Owner and Project Engineer, terminate the Contract and recover from the Owner payment for Work executed, including reasonable overhead and profit, costs incurred by reason of such termination, and damages.

If the Work is stopped for a period of 60 consecutive days through no act or fault of the Contractor or a Subcontractor or their agents or employees or any other persons performing portions of the Work under contract with the Contractor because the Owner has repeatedly failed to fulfill the Owner's obligations under the Contract Documents with respect to matters important to the progress of the Work, the Contractor may, upon seven additional days' written notice to the Owner and the Project Engineer, terminate the Contract and recover from the Owner as provided in this Section.

**14.5.2 Termination by the Owner for Cause:** The Owner may terminate the Contract if the Contractor:

1. refuses or fails to supply enough properly skilled workers or proper materials;
2. fails to make payment to Subcontractors for materials or labor in accordance with the respective agreements between the Contractor and the Subcontractors;
3. disregards applicable laws, statutes, ordinances, codes, rules and regulations, or lawful orders of a public authority; or
4. otherwise is guilty of a breach of a provision of the Contract Documents.

When any of the above reasons exist, the Owner, may without prejudice to any other rights or remedies of the Owner and after giving the Contractor and the Contractor's surety, if any, seven days' written notice, terminate employment of the Contractor and may, subject to any prior rights of the surety:

1. Exclude the Contractor from the site and take possession of all materials, equipment, tools, and construction equipment and machinery thereon owned by the Contractor; and
2. Finish the Work by whatever reasonable method the Owner may deem expedient. Upon written request of the Contractor, the Owner shall furnish to the Contractor a detailed accounting of the costs incurred by the Owner in finishing the Work.

When the Owner terminates the Contract for one of the reasons stated in Section 14.5.2, the Contractor shall not be entitled to receive further payment until the Work is finished. The Contractor shall only be compensated for work completed in accordance with the Contract Documents, less any costs, fees or expenses incurred by the Owner as a result of Owner's termination for cause.

If the unpaid balance of the Contract Sum exceeds costs of finishing the Work, including compensation for the Project Engineer's services and expenses made necessary thereby, and other damages incurred by the Owner and not expressly waived, such excess shall be paid to the Contractor. If such costs and damages exceed the unpaid balance, the Contractor shall pay the difference to the Owner. The amount to be paid to the Contractor or Owner, as the case may be, shall be certified by the Construction Manager, upon application, and this obligation for payment shall survive termination of the Contract.

- 14.5.3 **Suspension by the Owner for Convenience:** The Owner may, without cause, order the Contractor in writing to suspend, delay or interrupt the Work in whole or in part for such period of time as the Owner may determine. The Contract Time shall be adjusted for increases in the time caused by suspension, as described in this Section. No adjustment shall be made to the extent
1. that performance is, was or would have been so suspended, delayed or interrupted by another cause for which the Contractor is responsible; or
  2. that an equitable adjustment is made or denied under another provision of the Contract.

- 14.5.4 **Termination by the Owner for Convenience:** The Owner may, at any time, terminate the Contract for the Owner's convenience and without cause. Upon receipt of written notice from the Owner of such termination for the Owner's convenience, the Contractor shall:
1. cease operations as directed by the Owner in the notice;
  2. take actions necessary, or that the Owner may direct, for the protection and preservation of the Work;
  3. except for Work directed to be performed prior to the effective date of termination stated in the notice, terminate all existing subcontracts and purchase orders and enter into no further subcontracts and purchase orders;
  4. place no further orders and enter into no further Subcontracts for materials, labor, services or facilities except as necessary to complete continued portions of the Contract;
  5. terminate all Subcontracts and orders to the extent they relate to the work;
  6. proceed to complete the performance of Work not terminated; and
  7. take actions that may be necessary, or that the Owner may direct, for the protection and preservation of the terminated Work.

Allowance shall be made for payments previously made to the Contractor for the terminated portion of the Work, and claims which the Owner has against the Contractor under the Contract.

14.6 Intentionally Omitted.

14.7 The Contractor, before commencing the Work, shall furnish a Performance Bond and a Labor and Material Payment Bond. The Performance Bond shall be in an amount equal to 100 percent of the

full amount of the Contract Sum as security for the faithful performance of the obligations of the Contract Documents, and the Labor and Material Payment Bond shall be in an amount equal to 100 percent of the full amount of the Contract Sum as security for the payment of all persons performing labor and furnishings materials in connection with the Contract Documents. Such bonds shall be on A.I.A. Document A-312, issued by the American Institute of Architects, or such other document as may be acceptable to Owner, shall be issued by a surety satisfactory to the Owner and shall name the Owner as a primary co-obligee.

The Contractor shall deliver the required bonds to the Owner no later than three days following the date the Agreement is entered into, or if the Work is to be commenced prior thereto in response to a letter of intent, the Contractor shall, prior to the commencement of the Work, submit evidence satisfactory to the Owner that such bonds will be furnished.

The Contractor shall require the attorney-in-fact who executes the required bonds on behalf of the surety to affix thereto a certified and current copy of the power of attorney.

Upon the request of any person or entity appearing to be a potential beneficiary of bonds covering payment of obligations arising under the Contract, the Contractor shall promptly furnish a copy of the bonds or shall authorize a copy to be furnished.

- 14.9 Separate Contracts: The Owner reserves the right to let other contracts in connection with this work. The contractor shall afford other contractors reasonable opportunity for the introduction and storage of their materials and the execution of their work and shall properly connect and coordinate his work with theirs. If any part of the contractor's work depends for proper execution or results upon the work of any other contractor, the contractor shall inspect and promptly report to the Owner any defects in such work that render it unsuitable for such proper execution and results. His failure to so inspect and report shall constitute an acceptance of other contractor's work as fit and proper for the reception of his work.

To insure the proper execution of his subsequent work, the contractor shall measure work already in place and shall at once report to the Owner any discrepancy between the executed work and the drawings which will affect his work.

## Special Provisions

### Section 01200

The following Special Provisions supplement the "Standard Specifications for Road and Bridge Construction", adopted April 1, 2022, the latest edition of the "Manual on Uniform Traffic Control Devices for Streets and Highways", and the "Manual of Test Procedures of Materials" in effect on the date of invitation of bids, and the Supplemental Specifications and Recurring Special Provisions indicated here in which apply to and govern the construction of the ROUND LAKE MIDDLE SCHOOL 2023 PAVEMENT IMPROVEMENTS and the current edition of the "Standard Specifications for Water Main and Sewer Construction in Illinois". The Special Provisions included herein apply to and govern the proposed improvement and, in case of conflict with any part or parts of said specifications, said special provisions shall take precedent and shall govern.

#### **Section 105 – Control of Work**

1. Delete Article 105.05 and replace with the following:

“The documents forming the Contract Documents, as listed in the Agreement, are complementary, and the work called for by one is as binding upon the parties as if it was called for by all. In the event of conflict between the Contract Documents, the interpretation of the Engineer shall govern. Generally, the Engineer will resolve conflicts in a manner which will yield the greater quality in the Work. In the interpretation of any conflict between the Contract Documents, the following order of precedence shall govern:

- Agreement
- Bid Form
- Change Orders
- Addenda
- Special Provisions
- Drawings/Plans
- Instruction to Bidders
- Supplemental Standard Specifications
- Supplemental Specifications
- Standard Specifications – Illinois Department of Transportation
- Other Referenced Specifications
- Other documents included in the Contract Documents by specific reference in the “Agreement.”

2. Add the following sentences to the first paragraph of Article 105.07:

“The Drawings depict the locations of various existing underground utilities, including gas mains, electric duct lines, telephone lines, cable TV lines, sewers, and water mains. The information shown on the Drawings has been determined from the best available information, including field surveys and/or the records of the parent utility companies. Such information may or may not be accurate. Other underground utilities may also be present. As such, the Owner and Engineer assume no responsibility

in the event that, during construction, utilities other than those shown are encountered or that actual locations of those utilities shown are different from the locations designated on the Drawings.

3. Delete Article 105.07 Paragraph (b) in its entirety and replace with the following:

**“Unknown Utilities.** The requirements stated above for known utilities shall apply to unknown utilities. No compensation will be allowed for delays caused by unknown utilities.

**Definition.** An unknown utility is defined as an active or inactive underground transmission facility (excluding service connections) which is neither (a) shown in any way in any location on the plans, and (b) included in the proposal.”

4. Add the following to Article 105.09:

The work shall be constructed to the lines, grades, and cross sections indicated on the Contract Drawings, unless otherwise directed by the Engineer. The Engineer reserves the right to make changes in the lines, grades and cross sections as may be deemed necessary during the progress of the work. Such minor changes in the line and grade shall not change the payment to the Contractor for such work.”

5. Delete Article 105.10 and replace it with the following:

**“105.10 Authority of Engineer.** The Owner's representative, will administer the Contract and observe, survey, monitor, and judge the performance of the Contractor. The Engineer will perform technical inspections of work performed by the Contractor and shall have authority to reject, in writing, all work and materials which do not comply with the Contract Documents.

The Owner's representative, will interpret the Contract Documents. The Owner's representative will decide questions which arise in the execution of the Work or in the interpretation of the Contract Documents. The Owner's representative's decision or interpretations shall be final, unless the Contractor appeals to the Owner in writing within fifteen (15) calendar days after the decision or interpretation.

Neither the Owner's representative's authority to act under this Section, or elsewhere in the Contract Documents, nor any decision made by the Owner's representative in good faith either to exercise or not exercise such authority shall give rise to any duty or responsibility of the Engineer to the Contractor; any Subcontractor; any supplier, manufacturer, fabricator, distributor, vendor, or any other person or organization performing any of the Work, or to any surety for any of them.

The use of terms, such as, but not limited to: “approval”, “judgment”, “requirement”, or “direction” shall not be effective to assign to the Engineer any duty or authority to supervise or direct the furnishing or performance of the Work or any duty or authority to undertake responsibility contrary to the provisions herein; shall not be construed in any manner to relieve the Contractor of any of its responsibilities under

the Contract Documents; nor, shall be construed to create duties on the part of the Engineer or the Owner toward the Contractor.

The Owner's representative will not be responsible for the Contractor's means, methods, techniques, sequences, or procedures of construction, or the safety precautions and programs incident thereto, and the Engineer will not be responsible for the Contractor's failure to perform or furnish the Work in accordance with the Contract Documents.

The Owner's representative will not be responsible for the acts or omissions of the Contractor or of any Subcontractor; any supplier, manufacturer, fabricator, distributor, vendor, or of any other person or organization performing or furnishing any of the Work. It is agreed and understood that the Contractor is solely responsible for supervising the Work and for safety at the site of the Work as provided for in Article 105.14.”

6. Add Article 105.14, which shall read as follows:

**“105.14 Job-Site Safety.** The Contractor is solely responsible at all times for safety at the job site. The Contractor shall implement whatever protection measures are necessary to fully protect his work forces, the work forces of his suppliers and subcontractors, and the general public from construction activities. Any and all safety regulations and other provisions of applicable Federal, State and local laws and building and construction codes shall be observed.

The Drawings do not include standards or guidelines for construction safety. The Contractor shall be responsible for the adequacy and safety of all construction methods and the safe prosecution of the Work, including, but not limited to: forms, false work, scaffolding, trench protection, protective barricades, protective rails, and warning lights. It is expressly stipulated that any examination and/or approval by the Engineer of the Contractor's plans for such items as well as for any other items needed for the prosecution of the Work will cover only general conformance with the design concept of the project and general compliance with the information given in the Contract Documents. Such examination and/or approval by the Engineer shall not relieve the Contractor from full and complete responsibility for safe prosecution of the Work at all times and for obtaining satisfactory results. Requirements for safety-related work tasks presented in Project Drawings and Specifications, such as traffic control, represent the minimum level of protection which must be implemented. Depending on the Contractor's means and methods, these protection measures may or may not be fully adequate to protect Project work forces or the general public. As such, the Contractor is solely responsible for and is required to implement whatever additional protection measures may be necessary to fully protect the Project work force and the general public.

Nothing in the foregoing paragraphs shall be construed as relieving the Contractor from full responsibility for safe prosecution of the Work at all times. In the event the Owner, Engineer or their



representatives are held by a court or administrative body to be liable for personal injuries or damages to property arising from deficiencies in job-site safety, the Contractor shall promptly indemnify and hold them harmless there from.”

**Section 107 - Legal Relations and Responsibility to the Public**

1. Add the following paragraphs to Article 107.30:

“The Contractor assumes full responsibility for the safekeeping of all materials and equipment and for all unfinished work until final acceptance by the Owner, and if any of it is damaged or destroyed from any cause, the Contractor shall replace it at his own expense.

The Contractor shall indemnify and save harmless the Owner against any liens filed for nonpayment of his bills in connection with the Contract work. The Contractor shall furnish the Owner satisfactory evidence that all persons who have done work or furnished materials, equipment or service of any type under this Contract have been fully paid prior to the acceptance of the Work by the Owner.

The Contractor shall erect and maintain such barriers and lights and/or watchmen as will protect and warn pedestrians and vehicles, and prevent access of unauthorized persons to the site so as to prevent accidents as a consequence of his work.

The Contractor shall indemnify and hold harmless the Owner, the Owner's employees, the Engineer, and the Engineer's employees from any and all liability, loss, cost, damages and claims, and expense (including reasonable attorney's fees and court costs) resulting from, arising out of, or incurred by reason of any claims, actions, or suits based upon or alleging bodily injury, including death, or property damage arising out of, or resulting from the Contractor's operations under this Contract, whether such operations be by himself or by any subcontractor or by anyone directly or indirectly employed by either of them. The Contractor shall obtain insurance for this purpose, which shall insure the interests of the Owner and Engineer as the same may appear, and shall file with the Owner and Engineer certificates of such insurance.

The Contractor shall protect the Owner's property and adjacent property from injury or loss resulting from his operations. Objects sustaining such damage shall be replaced to the satisfaction of the Owner and Engineer; the cost of such repairs shall be borne by the Contractor.

**The Contractor shall be completely responsible for protecting his work from vandalism. Any vandalized concrete shall be repaired and/or replaced as directed by the Engineer and at the Contractor's expense.”**

**Section 109 – Measurement and Payment**

1. Add the following paragraphs to Article 109.02:

“All the requirements of the Supplemental Standard Specifications pertaining to Sections 100 to 109 of the Standard Specifications are considered incidental to the Work, and no separate or additional payment will be made, except as otherwise indicated, for complying with said requirements. The Owner has the authority to withhold any payment if satisfactory progress is not made by Contractor to complete any work on the Contract.

The cost of removal of any temporary surfaces, trench backfill or other temporary materials above the subgrade level in areas where final surface restoration is to be performed shall be incidental to the Contract and no additional separate payment will be made.

Existing facilities or property damaged by construction activities, including settlement, whether through result of Contractor's negligence or as a normal result of the means and methods employed by the Contractor, shall be restored to original condition. Restoration of damaged areas will be considered incidental to the Work and the cost shall be included as part of the unit or lump sum price item to which the restoration pertains.

**Pay Items (P.I.) are defined in Section 01010 of the Supplementary Specifications of this Contract Document. Pay Item definitions and measurement procedures in Section 01010 shall take precedence over any other conflicting definitions or procedures.**

Payment for each item will be made at the unit or lump sum price bid for that item. The cost of all other related or incidental work required by the plans and specifications shall not be measured or paid for as a separate item, but shall be included as part of the unit or lump sum price item to which the work pertains. Failure to list all such related or incidental work for the bid items shall not invalidate this stipulation.”

2. Delete Article 109.07 and replace it with the following:

**“109.07 Partial Payments and Retainage.** The Owner will pay the Contractor monthly for Work completed in accordance with the Contract Documents. Applications for Payment from the Contractor (and subcontractors) shall be prepared and submitted by the Contractor with all supporting documents to the Engineer. Supporting documents to be submitted with Applications for Payment shall include, but are not limited to:

**Documents to be Submitted With  
Applications for Partial Payment**

- (a) All delivery tickets for trench backfill, concrete and asphalt.
- (b) Lien Waivers
- (c) Certified Payroll Report(s)

**Failure to submit any of the above documents may cause the payment application to be rejected.**

Lien waivers shall accompany each Application for Payment and shall reflect the amount paid to each subcontractor, and supplier, and their respective supporting lien waivers. Contractor's lien waivers submitted with interim Applications for Payment shall reflect all costs up to the date of the Application. Lien waivers from subcontractors, suppliers and others accompanying interim Applications for Payment may be submitted one month in arrears. Lien waivers submitted with the final Application for Payment shall reflect the full values of Contractor's efforts; and, all subcontracts, materials purchases, and other Project costs.

Applications for Payment shall be reviewed by the Engineer within ten (10) calendar days of the submittal and returned to the Contractor for correction or forwarded to the Owner for approval, as appropriate. Engineer and Contractor must agree to quantities forwarded to the Owner. Any disputed quantities not included in the Application for Payment must be resolved within thirty (30) calendar days with any adjustments from disputed quantities to be included on the following Application for Payment. Applications for Payment certified by the Engineer must be in the District offices by the close of business on the last working day of each month. The Owner will pay the Contractor within thirty (30) calendar days of receipt of Applications for Payment certified by the Engineer.

Retainage shall be withheld as follows:

There shall be deducted from the amount so determined a sum of ten percent to be retained until after the completion of the entire work to the satisfaction of the Owner and Engineer.”

3. Delete the first, third, and fourth paragraphs of Article 109.08 and add the following:

“Final payment will be made within sixty (60) calendar days after the Work is fully completed and accepted by the Owner and the Contract fully performed. Request for final payment shall be prepared by the Contractor and accompanied by the documentation hereinafter listed. Quantities for this Contract shall be subject to the contract unit price applied to final measured quantities.

Neither the final payment nor any part of the retained percentage shall become due until the Contractor delivers to the Owner a complete release of all liens arising out of this Contract, or receipts in full in lieu thereof, and in either case, an affidavit that so far as he has the knowledge or information, the releases and receipts include all the labor and material for which a lien could be filed, but the Contractor may, if any subcontractor refuses to furnish a release or receipt in full, furnish a bond satisfactory to the Owner, to indemnify the Owner against any lien. If any liens remain unsatisfied after all payments are made, the Contractor shall refund to the Owner all moneys that the Owner may be compelled to pay in discharging such liens, including all costs and Attorney's fees.

With his final payment request, the Contractor shall submit the following data:

**Documents to be Submitted With  
Application for Final Payment**

- (a) Contractor prepared Record - Drawings
4. Add the following as the first two paragraphs of Article 109.09:
- “The Contractor shall notify the Construction Manager immediately when the Contractor becomes aware of any circumstances which the Contractor believes may lead to a claim for extra cost. Where possible, the Contractor shall delay proceeding with work which may result in the claim for extra cost until the Engineer has had a reasonable opportunity to review the situation, unless such delay will materially disrupt the prosecution of the Work or unless immediate Contractor action is required to resolve an emergency which endangers life or property. The purposes of the Engineer's review are: to verify that a claim for extra cost may be warranted, to make modifications to the Work to avoid or minimize the extra cost, and/or to monitor the Contractor's performance of the work generating the extra cost. For those situations where the Engineer is not notified prior to the Contractor performing work which causes the claim, the amount of extra cost to which the Contractor is entitled shall not include costs which, in the Engineer's sole opinion, could reasonably have been avoided if the Contractor had notified the Engineer prior to proceeding with the Work.

The Contractor shall submit, in writing, claims for extra cost to the Engineer as soon as possible after the occurrence of the event(s) giving rise to the claim, but not more than thirty (30) calendar days thereafter. Claims shall include appropriate supporting documentation as specified in following paragraphs to justify the extra cost claimed. This documentation shall include, as a minimum: a description of the circumstances which generated the claim, prior notifications provided to the Engineer, and a detailed breakdown of costs incurred by the Contractor. In the event that this documentation cannot be assembled within thirty (30) calendar days or if the extra cost is ongoing, the Contractor shall submit, in writing, whatever partial information is available to keep the Engineer informed of the Contractor's progress. Extra costs incurred by the Contractor solely because of the particular means and methods which the Contractor chooses to perform the Work will not be considered. Claims submitted more than thirty (30) calendar days after the occurrence of the event(s) giving rise to the claim will not be considered.”

## **RECURRING SPECIAL PROVISIONS**

### **Temporary Restroom Facilities**

State of Illinois Public Act 094-0042 (Construction Site Temporary Restroom Facility Act) stipulates that the CONTRACTOR must provide and maintain, for their work force, temporary restroom facilities. Please review this Act or the most recent update to the legislation in order to have a clear understanding of the provisions of the Act such as the quantity, type, and appurtenances necessary for the project. The cost of this item shall be considered incidental to the project. Per the language of the Act the OWNER has the authority to penalize the CONTRACTOR if the provisions of the Act are not followed.

### **Construction Layout**

The CONTRACTOR shall be required to furnish and place construction layout stakes for this project. The ENGINEER can provide adequate control points and benchmarks for the project if requested in writing by the CONTRACTOR.

The CONTRACTOR shall provide field forces, equipment and material to set all additional stakes for this project, which are needed to establish offset stakes, reference points, and any other horizontal or vertical controls, including supplementary benchmarks, necessary to secure a correct layout of the work. Stakes for line and grade of pavement and/or curb shall be set at sufficient station intervals (not to exceed 50 ft.) to assure substantial conformance to plan line and grade. The CONTRACTOR will not be required to set additional stakes to locate a utility line which is not included as a pay item in the contract nor to determine property lines between private properties.

The CONTRACTOR shall be responsible for having the finished work substantially conform to the lines, grades, elevations and dimensions called for in the plans. Any inspection or checking of the CONTRACTOR'S layout by the ENGINEER and the acceptance of all or any part of it shall not relieve the CONTRACTOR of his/her responsibility to secure the proper dimension, grades and elevations of the several parts of the work. The CONTRACTOR shall exercise care in the preservation of stakes and benchmarks and shall have them reset at his/her expense when any are damaged, lost, displaced or removed or otherwise obliterated.

### **Cooperation with Existing Utilities**

The CONTRACTOR shall familiarize himself with the locations of all utilities and structures that may be found in the vicinity of the construction. The CONTRACTOR is required to contact the Joint Utility Locating Information for Excavators (J.U.L.I.E.) Illinois 1 call system and follow all appropriate guidelines. In addition CONTRACTOR shall submit a request to the OWNER, whom will locate all existing sanitary systems, storm systems, water system, and roadway lighting systems. The CONTRACTOR shall conduct his operations to avoid damage to the above-mentioned utilities and structures. Should any damage occur due to the Contractor's negligence, repairs shall be made by the CONTRACTOR at his expense in a manner

acceptable to the ENGINEER. The CONTRACTOR shall notify all utility owners of his construction schedule and shall coordinate construction operations with the utility owners so that relocation of utility lines and structures may proceed in an orderly manner. Notification shall be in writing, with copies transmitted to the ENGINEER.

**Disposal of Surplus Material (CCDD)**

CONTRACTOR shall be responsible for the proper disposal of all materials, construction debris, soil and other waste. Disposal of all materials, construction debris, soil, and other wastes shall be at a disposal site that is properly licensed and permitted to accept the particular materials, construction debris, soil and other wastes delivered to it in accordance with all Illinois and federal environmental laws and regulations. Failure to identify disposal site(s) for materials, construction debris, soil and other wastes or to submit such information when requested by the OWNER is a material breach. The costs to test, remove and dispose of excavation materials, construction debris, soil and other regulated waste are included in the unit price for this pay item. OWNER will sign a CONTRACTOR provided LPC-662 or LPC-663 if requested and fully supported with all necessary background testing information.

Upon request of the OWNER, CONTRACTOR shall provide the OWNER with copies of all load tickets, manifests, bills of lading, scale tickets and other pertinent documents, including copies of all permits and/or licenses for the proposed transfer station, CCDD site and/or landfill. In the event that the transfer station, CCDD site and/or landfill proposed for use by CONTRACTOR does not possess the necessary permits and/or licenses to accept the materials, construction debris, soil or other wastes, CONTRACTOR will replace the transfer station and/or landfill. If the CONTRACTOR disposes of materials, construction debris, soil or other wastes at a site which is not properly permitted, the CONTRACTOR shall be responsible for all costs associated with the removal of the waste to a properly licensed/permitted landfill or disposal site, including fines, penalties and attorney's fees.

CONTRACTOR shall notify the OWNER within 24 hours of receipt of any environmental complaints, fines, citations, violations or notices of violation ("Claims") by any governmental body or regulatory agency against CONTRACTOR or any of his subcontractors or any third party relating to the loading, hauling or disposal of material, construction debris, soil or other wastes in connection with the Project. CONTRACTOR will provide evidence to the OWNER that any such Claim has been addressed to the satisfaction of the issuer or initiator of any such Claim.

CONTRACTOR shall haul any materials, construction debris, soil and other wastes in vehicles and/or containers complying with all applicable environmental laws. All equipment used to transfer materials, construction debris, soil or other wastes shall be designed to prevent spillage during the hauling operation. All hauling equipment shall fully comply with all OWNER, state, and federal regulations, laws and ordinances pertaining to size, load weight, safety and any environmental laws.

### **Special Waste Policy**

From information such as general history provided by OWNER, Special Waste are not anticipated to be encountered during work performed as part of this contract.

If the CONTRACTOR encounters materials within the project limits that the CONTRACTOR believes may be classified as Special Waste, the CONTRACTOR will immediately halt work that may disturb the suspected waste and immediately notify the ENGINEER. None of the suspected waste will be removed from the in-situ location on jobsite prior to ENGINEER approval. The CONTRACTOR will protect the jobsite from potential contamination from the suspected waste. Illinois Department of Transportation Standard Specification Article 104.03 will apply.

The CONTRACTOR will have the suspected waste material tested to determine if the suspected waste meets the criteria of Special Waste Testing and disposal of Special Waste will be paid for as Extra Work.

### **Maintenance of Existing Roadways**

Beginning on the date that the contractor begins work on this project, the contractor shall assume responsibility for the normal maintenance of all roadways within the limits of the improvement. This normal maintenance shall include all repair work deemed necessary by the Village, Owner or Engineer. Traffic control and protection required for this work will be provided by the contractor.

### **Progress Cleaning, Sweeping, and Waste Removal**

The CONTRACTOR shall maintain a work area that is free of waste material, debris, and rubbish. The CONTRACTOR shall at a minimum mechanically sweep and collect debris from the pavement areas and curb and gutter of the project and adjacent roadways utilized to access the site on a weekly basis, preferably on Friday or Saturday afternoons. CONTRACTOR shall collect and remove waste materials, debris, and rubbish from the project site periodically and dispose of in an acceptable fashion offsite, or clean site as directed by ENGINEER. The project site shall be kept in a clean and in an orderly condition. When applicable, remove debris and rubbish from pipe chases, plenums, attics, crawl spaces, and other closed or remote spaces prior to enclosing the space. When applicable, dust and vacuum interior areas prior to applying surface finishes, and continue cleaning to eliminate dust build up. The cost of this item shall be considered incidental to the project.

### **Protection of Existing Drainage Facilities During Construction**

All existing drainage structures are to be kept free of debris resulting from construction operations. All work and material necessary to prevent accumulation of debris in the drainage structures will be considered as incidental to the contract. Any debris in the drainage structures resulting from construction operations shall be removed at the contractor's own expense, and no extra compensation will be allowed.

During construction, if the contractor's forces encounter or otherwise becomes aware of any sewers, underdrains or field drains within the right-of-way other than those shown on the plans, they shall inform

the engineer. The engineer shall direct the work necessary to maintain or replace the facilities in service, and to protect them from damage during construction if maintained. Existing facilities to be maintained that are damaged because of non-compliance with this provision shall be replaced at the contractor's own expense. Should the engineer have directed the replacement of a facility, the necessary work and payment shall be done in accordance with Sections 550 and 601 and Article 104.02 respectively of the "Standard Specifications."

### **Use of Premises**

The contractor shall confine his apparatus, the storage of materials and the operations of his workers, to limits indicated by law, ordinances, permits or directions of the Owner.

### **Material Storage**

On-site areas may be designated for material/equipment storage. The contractor will assume all risk and liability associated with the storage of material/equipment at on-site locations.

## **Environmental Control**

### Section 01568

#### **PART 1 - GENERAL**

##### 1.01. ENVIRONMENTAL PROTECTION

The Contractor shall be responsible for furnishing all necessary items for fulfilling the Work described herein for environmental protection including prevention and control of erosion and sedimentation that results directly or indirectly from the Project.

##### 1.02. PREVENTION OF WATER POLLUTION

The Contractor shall take all such precautions in the conduct of his operations as may be necessary to avoid contaminating the water in adjacent watercourses or water storage areas including wells whether natural or man-made.

All earthwork, moving of equipment, water control of excavations, and other operations likely to create silting, shall be conducted so as to minimize pollution of watercourses or water storage areas.

Water used during the Contract Work, which has become contaminated with oil, bitumens, harmful or objectionable chemicals, sewage or other pollutants, shall be disposed of so as to avoid affecting all nearby waters and lands. Under no circumstances shall the Contractor discharge pollutants into any watercourse or water storage area. Do not allow water used in aggregate processing, concrete curing, foundation and concrete lift cleanup or any other waste to directly enter a stream untreated. When water from adjacent natural sources is



used in the Contract Work, intake methods shall be such as to avoid contaminating the source of supply or becoming a source of erosion or sedimentation.

1.03. NOISE AND AIR POLLUTION CONTROL

Conduct operations so as not to violate any applicable ordinances, regulations, rules and laws in effect in the area at the date of bid opening pertaining to noise and air pollution and to conform to all provisions in effect at the date of bid opening as set forth in the Rules and Regulations Governing the Control of Air Pollution and noise pollution in the State of Illinois.

1.04. PLANT PEST CONTROL

All soil moving or handling equipment that has operated in or will operate in regulated areas shall be subject to plant quarantine regulations. In general, these regulations require the thorough cleaning of soil from equipment before such equipment is moved from regulated areas to non-infested areas. Complete information may be obtained from the regional office of the Plant Pest Control Division of the United States Department of Agriculture.

1.05. PRESERVATION OF NATURAL RESOURCES

All construction operations, contract work, clean up and the condition of the adjacent terrain upon completion of the Work shall fully comply with all applicable regulations and laws concerning the preservation of natural resources.

1.06. DUST CONTROL

Throughout the entire construction period, maintain dust control by use of water sprinklers or chemical dust control binder as may be approved by the Engineer.

**PART 2 - PRODUCTS**

Not applicable to this section.

**PART 3 - EXECUTION**

Not applicable to this section.

**PART 4 - PAYMENT**

No separate payment will be made for the work in this Section; all the costs of such work shall be considered included to the items of work to which they pertain.

**Submittals**

Section 01300

**PART 1 - GENERAL**

1.01.1.1. Scope

This section includes general requirements and procedures related to the Contractor's responsibilities for preparing and transmitting submittals to the Engineer to demonstrate that the performance of the Work will be in accordance with the Contract requirements. Submittals include schedules, Contractor's Drawings, calculations, samples, manuals, methods of construction, and record drawings. Other requirements for submittals are specified under applicable sections of the Standard Specifications.

1.01.1.2. Required Submittals

Submit Shop Drawings and Manufacturer's Literature for each of the following:

- 1.02.1. HMA Mix Designs & Plant Certifications
- 1.02.2. Concrete Mix Designs & Plant Certifications
- 1.02.3. Aggregate Base Material
- 1.02.4. ADA Detectible Warning Tiles

1.01.1.3. Contractor's Drawings & Other Submittals

A. *General*

Contractor's drawings shall be neat in appearance, legible and explicit to enable proper review relative to Contract compliance. They shall be complete and detailed to show fabrication, assembly and installation details, catalog data, pamphlets, descriptive literature, and performance and test data. They shall be accompanied by calculations or other sufficient information to provide a comprehensive description of the structure, machine or system provided and its intended manner of use.

B. *Contractor's Responsibility*

Each Contractor's drawing submitted by the Contractor shall have affixed to it the following Certification Statement, signed by the Contractor:

**"Certification Statement:** By this submittal, I hereby represent that I have determined and verified all field measurements, field construction criteria, materials, dimensions, catalog numbers and similar data and I have checked and coordinated each item with other applicable approved drawings and all Contract requirements."

The review and approval of Contractor's drawings by the Engineer shall not relieve the Contractor from his responsibility with regard to the fulfillment of the terms of the Contract. All risks of error and omission are assumed by the Contractor, and the Engineer will have no responsibility therefore.

No portion of the Work requiring a Contractor's drawing shall be started nor shall any

materials be fabricated, delivered to the site, or installed prior to the approval or qualified approval of such item. Fabrication performed, materials purchased or on-site construction accomplished which does not conform to approved Contractor's drawings and data shall be at the Contractor's risk. The Owner will not be liable for any expense or delay due to corrections or remedies required to accomplish conformity.

Contract Work, materials, fabrication, and installation shall conform with approved Contractor's drawings.

*C. Identification*

Data - All submittals for approval shall have the following identification data, as applicable, contained thereon or permanently adhered thereto.

1. Owner Contract Number.
2. Project name and location.
3. Submittal Numbers. Re-submittals shall bear original submittal number and be lettered.
4. Product identification.
5. Drawing title, drawing number, revision number, and date of drawing and revision.
6. Applicable Contract drawing numbers and specification section and paragraph numbers.
7. Subcontractors, vendors, and/or manufacturer's name, address and phone number.
8. Contractor's certification statement.

Catalog Data - Each submittal of catalog data shall have the identification required as hereinbefore stated.

1. Catalogs or brochures submitted in packages of multiple items for approval need the identification only on the exterior. In such instances the identification shall include page and catalog item numbers for items submitted for approval. If one or more of the items in such a submittal are not approved, re-submittal of only the unapproved items is required.

2. Catalog cuts containing various products, sizes and materials shall be highlighted to show particular items being submitted.

Space - Vacant space of approximately 3-1/2-inches high by 4-inches wide shall be provided adjacent to the identification data to receive the Engineer's status stamp.

*D. Shop Drawings*

Shop drawings shall show types, sizes, accessories, weights, layouts including plans, elevations and sectional views, component, assembly and installation details, and all other information required to illustrate how applicable portions of the Contract requirements will be fabricated and/or installed. Include manufacturer's certified performance curves, catalog cuts, pamphlets and descriptive literature, as required.

*E. Working Drawings*

Submit working drawings as required for changes, substitutions, contractor design items, and designed methods of construction. Requirements for working drawings will be listed in appropriate Specification Sections and/or in Special Provisions. Drawings shall be accompanied by calculations or other information to completely explain the structure and describe its intended use. Working drawings and calculations as submitted shall be sealed, dated and signed by a Professional Engineer, and/or Structural Engineer as appropriate, registered in the State of Illinois.

Review and approval of such drawings by the Engineer shall not relieve the Contractor from his responsibility with regard to the fulfillment of the terms of the Contract. All risks of error are assumed by the Contractor and the Engineer shall have no responsibility, therefore.

*F. Catalog Data*

Submittals – An electronic copy (.PDF) on a USB Flash Drive of the catalog data is required for the original submittal and each subsequent re-submittal that may become necessary.

Manufacturer's equipment data shall be certified and shall include materials type, performance characteristics, voltage, phase, capacity, and similar data. Provide wiring diagrams when applicable. Indicate catalog, model and serial numbers representing specified equipment. Provide complete component information to verify all specified required items.

Data Identification - Each submittal shall have all pertinent data contained therein that are applicable to the item submitted for approval, adequately and prominently designated.

G. *Approval Process*

Original Submittal – Electronic copies (.PDF) of catalog data specified in Item F and legible prints of all shop and working drawings shall be submitted to the Engineer for approval in accordance with the Contractor's drawings submission schedule, with all fabrication and installation requirements, allowing at least 30 calendar days for checking and appropriate action by the Engineer. Three copies of all Contractor's drawings will be returned.

Contractor's drawings will be returned, stamped with one of the following classifications:

*NO EXCEPTION TAKEN*

No corrections, no marks.

*FURNISH AS NOTED*

Minor corrections are required as noted on the submittal. All items may be fabricated as marked without further resubmission. Resubmit corrected copy to the Engineer.

*REJECTED*

Requires corrections or is otherwise not in accordance with the Contract Documents. Correct and resubmit drawings as per original submission. Thirty (30) calendar days will be allowed for checking and appropriate action by the Engineer. Only one stamped drawing will be returned. Incomplete submittals or submittals not in conformance with this Specification will not be reviewed but will be returned to the Contractor as "not approved".

*INFORMATION ONLY*

Items not reviewed or items for which submittals are not required.

Review and approval of Contractor's drawings by the Engineer shall not relieve the Contractor in any way from his responsibility with regard to the fulfillment of the terms of the Contract. All risks of error are assumed by the Contractor and the Engineer shall have no responsibility therefor.

*H. Excessive Reviews of Contractor Drawings and Other Submittals*

The Owner's cost for Engineer's effort to review Contractor drawings or other submittals which have been returned two or more times stamped "REJECTED" shall be borne by the Contractor at a rate of \$300.00 per labor hour. Upon completion of each subsequent review, the Engineer will provide the Contractor a summary total of hours expended in performing the review. Moneys due the Owner for Engineer's cost for third and additional reviews of Contractor drawings and other submittals will be deducted from the next regular payment due the Contractor. The cost for these services shall be deducted from the "Amount Earned to Date" from the next regular payment due the Contractor.

**Part 2 - Payment**

No separate payment will be made for the work in this section; all the costs of such work shall be considered incidental to the items of work to which they pertain.

**Rejection of Work**

Any materials or Work found not to be in compliance with the Standard Specifications, these Special Provisions, and/or the construction plans shall be cause for the complete rejection of all work performed as determined by the Owner. The Contractor shall replace at its sole cost and expense all Work that is rejected by the Owner. No additional compensation shall be paid for said replacement Work.

**PROJECT SPECIFIC SPECIAL PROVISIONS**

**General Provisions**

The Contractor shall dig test holes to determine locations and elevations of conflicting underground utilities.

The Contractor shall not close any parking lot without prior notification and consent of the ENGINEER and shall provide at least twenty-four (24) hour notice. Failure to notify ENGINEER is considered a traffic control deficiency and the CONTRACTOR will be charged an amount as determined by the IDOT standard. In the event of an emergency, the CONTRACTOR shall provide immediate access to closed areas.

The CONTRACTOR shall contact the OWNER, OWNER'S REPRESENTATIVE & ENGINEER twenty-four (24) hours advance notice of parking restrictions with appropriate signs and/or barricades placed meeting the approval of the ENGINEER.

The CONTRACTOR shall be responsible for the immediate repair of any damage done to the roadway or existing structures within the right-of-way by the construction vehicles or equipment during any construction. This work shall be considered incidental to the cost of the contract.

The CONTRACTOR shall protect from damage all parts of curbs, paving, catch basins, manholes, drains, pavement, buildings, utilities and all other improvements liable to injury by his operations and shall, at his own expense, make good all damages to the satisfaction of the OWNER.

All trees shall be protected from damage by all contractors. The CONTRACTOR shall be responsible for any negligence or willful damage to these trees or their root system. The CONTRACTOR shall not remove any trees unless requested to do so in writing by the ENGINEER or if they are marked on the plans for removal.

A pre-construction conference will be scheduled after execution of the Agreement, and prior to commencement of the Work.

### **Traffic Control & Protection, Special**

#### **Description:**

Traffic control shall be in accordance with the applicable sections of the Standard Specifications, the applicable guidelines contained in the State of Illinois Manual on Uniform Traffic Control Devices for Streets and Highways, the Standard Specification for Traffic Control Items, and these Special Provisions.

#### **Construction Requirements:**

##### **General:**

The contractor shall contact the Owner's Representative and the Project Engineer at least 48 hours in advance of beginning work. Special attention is called to Articles 107.09 and 107.14 of the Standard Specifications and the following highway standards relating to traffic control: Standard 701301-04 and 701901-03. The following special provisions also apply: Work Zone Traffic Control Devices, Traffic Control Deficiency Deduction, Construction Zone Traffic Control, Flaggers in Work Zones, Flagger Vests, Personal Protective Equipment, and Flagger Certification.

The Contractor shall obtain, erect, maintain, and remove all signs, barricades, flagmen, and other traffic control devices as may be necessary for the purpose of regulating, warning, or guiding traffic and protecting pedestrians. Placement and maintenance of all traffic control devices shall be in accordance with the applicable parts of Article 107.14 of the Standard Specifications and the State of Illinois Manual on Uniform Traffic Control Devices for Streets and Highways.

At a minimum, the Contractor will provide lighted barricades where any hazardous conditions are created. Additionally, where traffic lanes are restricted on major arterial roads, a flashing arrow board is required. Any Work damaged due to lack of adequate barricades shall be replaced by the Contractor at the Contractor's expense.

A minimum of one lane of traffic must be kept open at all times. The contractor shall coordinate with residents to assure access to private driveways is maintained at all times, or to ensure residents are notified of any temporary condition that would prohibit access to their driveway. NO OVERNIGHT LANE CLOSURES ON ANY STREET WILL BE ALLOWED.

**Basis of Payment:**

This item will be paid based on a contract lump sum (LUMP) for TRAFFIC CONTROL & PROTECTION, SPECIAL, which shall include all labor, equipment, and materials required to complete the work as specified herein.

**Hot Mix Asphalt Binder & Surface Courses**

**Description:**

This item shall include all labor, material, and equipment necessary to perform the installation of Hot Mix Asphalt. The standard shall as listed in Art. 420.12.

**Materials.**

Hot Mix Asphalt pavements shall be designed, produced, stored, controlled (sample inspection, sampling, and testing), shipped, and constructed in accordance with Section 406 and other applicable sections of the Standard Specifications for Road and Bridge Construction, applicable Special Provisions, and Chapter 44 of the Bureau of Local Roads and Streets Manual and the following:

All asphalt mix designs shall target 3.5% Air Voids and all production shall trend about 3.5% Air Voids.

N50, IL-19.0 mm Binder course shall have a minimum of 40% passing the #4 sieve.

N50, IL-9.5 mm Surface and Level courses shall have a minimum of 40% passing the #8 sieve.

Re-proportioning (within SSRBC adjustments allowed) of IDOT verified mix designs may be allowed and the contractor must submit these values for a review by the Engineer at least one week prior to the first day of production.

One field TSR test by the Contractor will be required to validate changes.

The AJMF during production shall meet the remaining IDOT volumetric requirements.

**HOT-MIX ASPHALT MIXTURE REQUIREMENTS**

<b>ITEM</b>	<b>AC TYPE</b>
Hot Mix Asphalt Surface Course, Mix "D", N50	PG 58-22/58-28*
Leveling Binder (Machine Method), N50	PG 58-22/58-28*
Hot Mix Asphalt Binder Course, IL-19, N50	PG 58-22/58-28*



Note:

The unit weight used to calculate all HMA surface mixture quantities is 112 lbs/sq yd/in

\* When Asphalt Binder Replacement (ABR) exceeds 15%, the new asphalt binder in the mix shall be PG 58-28. No more than 2% Reclaimed Asphalt Shingles shall be allowed in the asphalt.

**Construction Requirements:**

General:

- Tack coat all longitudinal joints (hot and cold) and curb faces.
- Pneumatic tire roller is required on all lifts, all mixes, except surface courses.
- Auger extensions are required on all lifts, all mixes.
- Reverse augers must be installed properly.
- Roll (compact) the confined and curb line longitudinal joint by overlapping by 6" from the hot to cold side of mat and/or curbing.
- Paving of the full roadway width shall be completed at the end of each day. Longitudinal joints shall be closed daily and within one truck load of HMA to prevent cold joints. Any violation shall require saw cutting edge back 3" to expose straight edge, shall be tack coated twice, and will be straight and uniform.
- Asphalt along the curb line shall be compacted such that the asphalt is ¼" above the curb line.

Atmospheric Conditions:

This work shall only take place with the atmospheric temperatures is 40 degrees and rising in the shade. Aggregate Base and/or Binders must be free of standing water, and no precipitation shall be forecasted for the duration of the work.

# Sample Contract

## Section 20500

(informational only)

1. This Agreement made and concluded this \_\_\_\_\_ day of \_\_\_\_\_, 2023, between Round Lake Area Schools Community Unit School District 116 (SD116) known as the party of the first part and \_\_\_\_\_, his/their executors, administrators, successors, or assigns, known as the party of the second part.

2. WITNESSETH: That for and in consideration of the payment and agreements mentioned in the Bid hereto attached, to be made and performed by the party of the first part, and according to the terms expressed in the Bond referring to these presents, the party of the second part agrees with said party of the first part at his/their own proper cost and expense to furnish all labor, equipment, supplies and materials necessary to complete the work in accordance with the Plans and Specifications hereinafter described and in full compliance with all the terms and conditions of the Agreement.

3. And it is also understood and agreed that the Instructions to Bidders and General Conditions, Supplemental General Conditions, Special Provisions, Contract Special Provisions, Submittals, Bid Form, Bid Bond, the latest edition of the Illinois Department of Transportations 'Standard Specifications for Road and Bridge Construction' (with the exception of Division 100, unless otherwise indicated in the Contract Documents), any addenda, and the Drawings titled:

**2023 Pavement Improvements  
Round Lake Middle School  
Dated: May 11, 2023**

as prepared by:

**GEWALT HAMILTON ASSOCIATES, INC.  
625 FOREST EDGE DRIVE  
VERNON HILLS, ILLINOIS 60061**

are all essential documents of this Contract and are a part thereof.

4. IN WITNESS THEREOF, the said parties have executed these presents on the date above mentioned.

Attest:

\_\_\_\_\_  
Party of the First Part —  
Round Lake Area Schools Community Unit  
School District #116  
President Board of Directors

\_\_\_\_\_  
(seal)

Attest:

\_\_\_\_\_  
Party of the Second Part

\_\_\_\_\_  
Corporation - Secretary (seal)

**Exhibits**

**PROJECT IMPROVEMENT PLAN**

(See next page)



**MILL & RESURFACE:**

- HMA SURFACE COURSE REMOVAL, 5"
- HOT-MIX ASPHALT BINDER COURSE, IL-19.0, N50, 3.5"
- HOT-MIX ASPHALT SURFACE COURSE, MIX D, N50, 1.5"

**MILL & RESURFACE:**

- HMA SURFACE COURSE REMOVAL, 1.5"
- HOT-MIX ASPHALT SURFACE COURSE, MIX D, N50, 1.5"

**PAVEMENT RECONSTRUCTION:**

- FULL DEPTH PAVEMENT REMOVAL
- AGGREGATE BASE COURSE, CA-6, 10"
- HOT-MIX ASPHALT BINDER COURSE, IL-19.0, N50, 3.5"
- HOT-MIX ASPHALT SURFACE COURSE, MIX D, N50, 1.5"

**PROPOSED LEGEND**

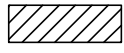
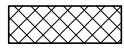
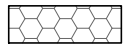
-  FULL DEPTH PAVEMENT RECONSTRUCTION
-  MILL & RESURFACE, 5"
-  MILL & RESURFACE, 1.5"



**GRAPHIC SCALE**

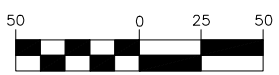

( IN FEET )  
1 inch = 50 ft.

**GHA GEWALT HAMILTON ASSOCIATES, INC.**  
625 Forest Edge Drive ■ Vernon Hills, IL 60061  
Tel.: 847.478.9700 ■ Fax.: 847.478.9701

**EXHIBIT**  
**PARKING LOT RESURFACING**  
**ROUND LAKE MIDDLE SCHOOL**  
**ROUND LAKE, ILLINOIS**

FILE: 5903.008_Round Lake MS Repaving_2.dwg	
DRAWN BY: JRF	GHA PROJECT #
DATE: 4.27.23	5903.008
CHECKED BY: GLP	SCALE: 1"=50'

**STANDARD DETAILS**

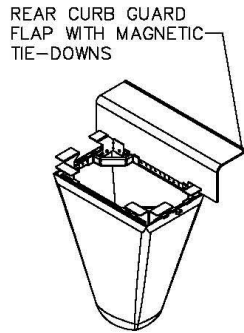

**TYPICAL CURB BOX  
INLET FILTER**

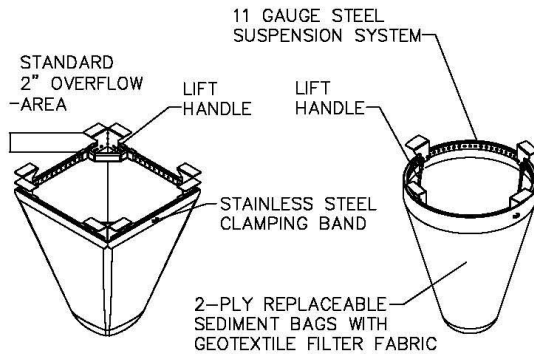

**TYPICAL  
FLAT/RECTANGULAR/ROLLED  
CURB INLET FILTER**

**TYPICAL ROUND  
INLET FILTER**

Material Property	Test Method	Value (min. ave.)	
		Non-Woven	Woven Mono
<b>&gt; Inlet Filter Bag Specs (2ft<sup>3</sup> min vol)</b>			
Grab Tensile	ASTM D 4632	100 lbs	200 lbs
Puncture Strength	ASTM D 4833	65 lbs	90 lbs
Trapezoidal Tear	ASTM D 4535	45 lbs	75 lbs
UV Resistance	ASTM D 4355	70% at 500 hrs	90%
App. Open Size (AOS)	ASTM D 4751	70 sieve (.212 mm)	40 sieve (.425 mm)
Permittivity	ASTM D 4491	2.0/sec.	2.1/sec
Water Flow Rate	ASTM D 4491	145 gpm/sqft.	145gpm/sqft
<b>&gt; Polyester Outer Reinforcement Bag Specifications</b>			
Weight	ASTM D 3776	4.55 oz/sqyd +/-15%	
Thickness	ASTM D 1777	.040 +/- .005	
<b>&gt; Frame Construction</b>			
A36 Structural Steel; 11 Gauge, Zinc Plated	ASTM A 576	Tensile Strength > 58,000 psi Yield Strength > 36,000 psi	

**MAINTENANCE**  
1. CLEAN OUT AFTER  
EVERY RAIN EVENT

ACCEPTABLE MANUFACTURER'S  
AS LISTED BELOW:

1. INLET & PIPE PROTECTION,  
INC. Naperville, IL 60564 847  
722-0690

2. MARATHON MATERIALS,  
INC. Plainfield, IL 60544  
800-983-9493

03.15.2016

**GHA GEWALT HAMILTON ASSOCIATES, INC.**  
625 Forest Edge Drive ■ Vernon Hills, IL. 60061  
TEL 847.478.9700 ■ FAX 847.478.9701

**INLET BASKET DETAIL**  
2021 PAVEMENT IMPROVEMENTS  
LAKES & ANTIUCH HIGH SCHOOLS  
LAKE VILLA, ILLINOIS 60048

FILE: Typical Sections.dwg  
DRAWN BY: SAR GHA PROJECT #  
DATE 3/22/2021 4675.408  
CHECKED BY: CAS SCALE N.T.S.

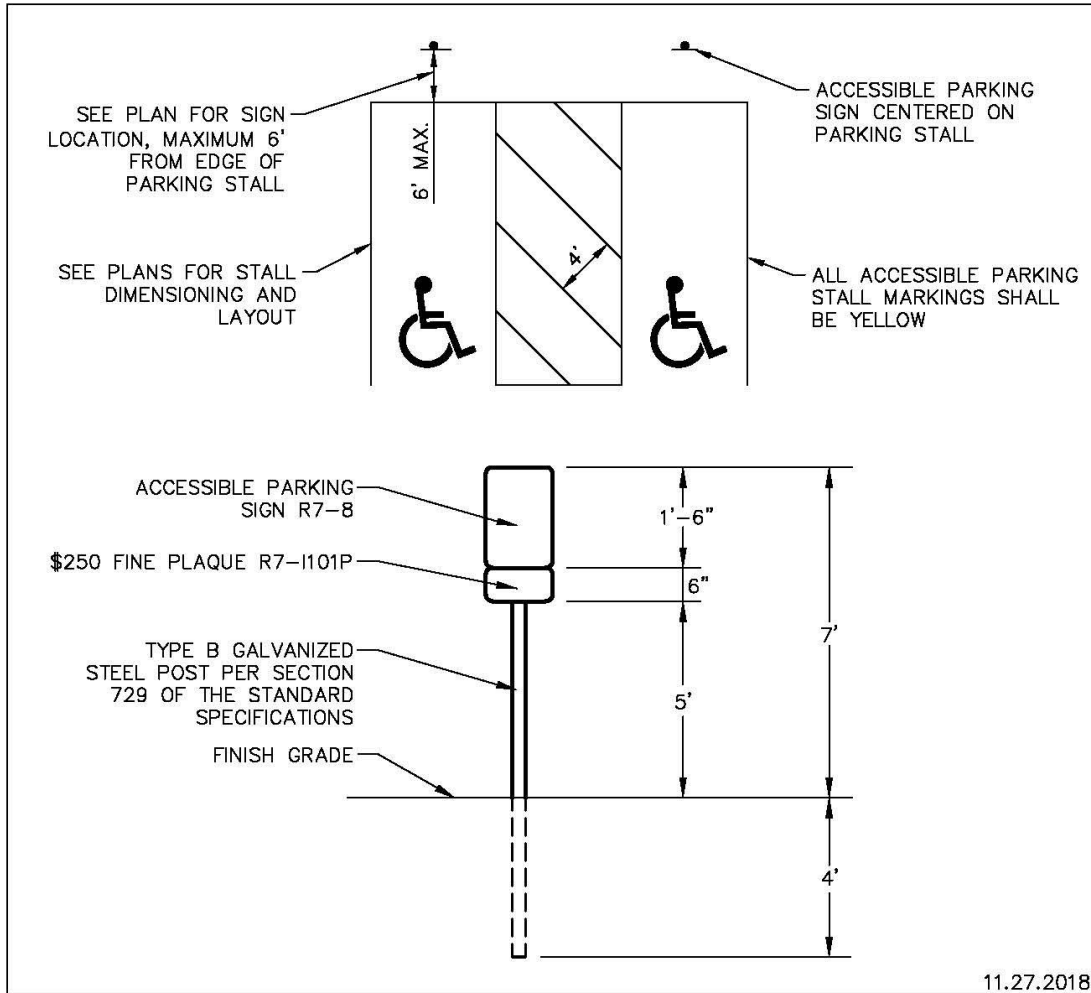

11.27.2018

**GHA GEWALT HAMILTON ASSOCIATES, INC.** ACCESSIBLE PARKING DETAIL

<b>GHA GEWALT HAMILTON ASSOCIATES, INC.</b> 625 Forest Edge Drive ■ Vernon Hills, IL. 60061 TEL 847.478.9700 ■ FAX 847.478.9701	<b>HANDICAP STALL PAVEMENT MARKING</b>		FILE: Typical Sections.dwg
	2021 PAVEMENT IMPROVEMENTS		DRAWN BY: SAR
	LAKES & ANTIOCH HIGH SCHOOLS		DATE: 3/22/2021
	LAKE VILLA, ILLINOIS 60048		CHECKED BY: CAS
			GHA PROJECT # 4675.408
			SCALE: N.T.S.