

# Cadet Handbook and Regulations



**SAINT THOMAS  
ACADEMY**

Cadets Name \_\_\_\_\_

Graduation Class Year \_\_\_\_\_

***School Year 2023 - 2024***

Cadets,

This handbook is provided as a guide for you to excel as a member of the Saint Thomas Academy Corps of Cadets. The basic principles of developmental military leadership require that you meet certain standards. To do this, you must exercise discipline in adhering to these standards both when it is easy to do so, as well as when it is not. As you may already know, many of the things you'll learn about leadership cannot be printed in the pages of a handbook. This booklet is not meant to be an all-encompassing guide for life, but rather, one of many tools for you to employ as you establish your own unique leadership style.

To thrive as a Cadet, and ultimately as a man of character in your years beyond this school, you'll need to also embrace the values of: honor, courage, and commitment. During your time at Saint Thomas Academy, you can embrace these values by following the guidance below:

1. Grasp the Saint Thomas Academy spirit and culture of brotherhood.
2. Be loyal to the Academy and its traditions.
3. Respect fellow cadets and your instructors.
4. Show pride in your uniform and personal appearance.
5. Demonstrate "gentlemanship" in all endeavors.
6. Give maximum effort in all classes and activities.
7. Live a life of faith, honesty, truthfulness, and integrity.

If you choose to establish these goals for yourself, you will have no difficulty in complying with the rules and regulations of STA; success in this school will come naturally.

For over 139 years, Cadets at this institution have developed a strong moral and ethical foundation and honed their skills in ethical leadership. Our graduates have served at the highest levels of leadership in various communities, within the Church, and in the armed forces, where they courageously defended our great country. Please understand that it is truly a blessing to attend this institution and to belong to such a glorious tradition of excellence. As you establish your own legacy within the walls of the Academy, I ask that you do so in a manner that truly earns you the title of "Cadet".

Respectfully,

*Nick Honan*

Captain, U.S. Marines (2010-2021)

Commandant of Cadets

## Index

- Uniform and Appearance Standards 4
- Required Uniform Items 11
- Awards 18
- STA Ribbon Order of Precedence 20
- Merits and Demerits 22
- Promotion and Organization 28
- Senior Leader Application Process 28
- Chain of Command 29
- Brigade and Company Organizational Charts 30
- STA Cadet Creed 31
- STA Fight Song 32
- Prayer of St. Thomas Aquinas 33

## UNIFORM AND APPEARANCE STANDARDS

Saint Thomas Academy is a military institution where discipline is enforced and students are required to meet the military standard for wearing the uniform. A neat and well-groomed appearance is fundamental to building pride and esprit-de-corps while simultaneously honoring the many distinguished alumni of this institution. The faculty, staff, and senior cadet leaders are responsible to ensure that cadets present a neat and orderly appearance. Cadets must wear the uniform correctly and completely at all times on and off campus; it may not be worn in parts, you are either all in uniform or out. When civilian attire is authorized for special events, such as field trips, the grooming standards still apply (hair, shave, shower).

### Uniform Types

**Class A** - Blue blouse coat, gray trousers, white shirt, tie, and black shoes. This uniform is worn for Alumni Review, Grandparents Day Review, and other special events. This is also the uniform for ALL Masses but without the blouse coat.

**Class A1** - Identical to Class A, except that cadets wear the white dress trousers. This uniform is worn for the Archbishop's Review, Military Ball, Auction Gala, Military Awards, Baccalaureate Mass, and Graduation. For Military Ball, a bow tie is worn – this is the most formal uniform.

**Class B** - Long-sleeved blue shirt with tie and gray pants. This is the normal duty uniform for school between October and April.

**Class B1** - Blue shirt (sleeves neatly folded to 1-3" above the elbow, with a 2 ½ inch cuff) and no tie. This uniform is worn as the duty uniform during August - September and May-June.

**Crack Drill Uniform** - May be worn in lieu of the class A/B uniform on CDS performance days. The Crack Drill quarter zip jacket may be worn in lieu of the uniform coat.

## Outer Garments

When in uniform, all cadets who choose to wear an outer garment must comply with the following:

- A. Cadets are authorized to wear any Saint Thomas Academy issued or purchased sweatshirts (also known as spirit wear or hoodie sweatshirts) or jackets (windbreaker, winter jacket, or Saint Thomas Academy team purchased jacket) when traveling to or from school while in uniform. The Saint Thomas Academy black jacket and letter jacket are still authorized and may also be worn. Civilian sweatshirts or jackets are not permitted while in uniform at any time.
- B. A Saint Thomas Academy sweatshirt or jacket is defined as a sweatshirt or jacket that generally conforms to portraying school spirit by advertising the school name, "Cadets," or "STA". It may be accompanied by a team moniker such as "Cadets Football". Generally speaking, the Saint Thomas Academy sweatshirt, or jacket, may consist of school colors: navy, blue, black, white, or any combination thereof.
- C. Winter stocking caps must be blue, black, or gray in color, and either without a logo, or with the STA logo.

## Personal Appearance

### A. General

- All cadets will maintain a high standard of dress and appearance. Uniforms will be properly fitted, clean, serviceable, and pressed as necessary. Cadets must project a neat and disciplined image that leaves no doubt that they live by a common orderly standard, and are responsible for good order and discipline. Cadets must be "all-in" uniform or "all-out" of uniform at all times. There is no middle ground, whether on campus or off.

## **B. Hair/Grooming**

1. All Cadets will maintain a high standard of dress and appearance. Hair will be neatly groomed. Hair will not exceed 3 inches in total length or 2 inches of bulk. Bulk is defined as the distance that the mass of hair protrudes from the scalp. As it naturally lies, hair cannot touch the ears or the collar of the uniform shirt. As styled, hair will not touch the eyebrows.
2. Hair must show a generally even/balanced appearance conforming to the natural shape of the head. Hair will also be tapered upward. The rate of taper will not exceed a one inch increase in length for each inch of scalp. No accessories will be worn in the hair (beads, bobby pins, rubber bands, etc.). Hairstyles may not be extreme or eccentric, the definition of which is at the Military Leadership Instructors' discretion. Hair dyes or coloring must appear natural. Lines or designs cut into the scalp are not permitted.
3. The unique quality and texture of curled, kinked, waved and straight hair are recognized. Varying hairstyles, including Afros are permitted if these styles meet the criteria of maximum length and bulk, conform to the shape of the head and are gradually tapered. Twists and braids are not permitted. Sideburns will be neatly trimmed, not flared, and not extend below the lowest part of the exterior ear opening. The Commandant has the final say in all grooming standards.
4. The entire face will be clean-shaven each day. Waivers for skin disorders are granted by Military Instructors with parental or doctor's note.
5. Cadets are expected to maintain good daily hygiene, clean uniforms regularly, and wear their uniforms so as not to detract from the overall appearance. Cadets will keep fingernails clean and neatly trimmed. Painted or glossed nails are not authorized.
6. Tattoos visible in uniform are unauthorized. Hickeys or other forms of skin alteration are not permitted.
7. Cadets are not authorized to wear any ear, lip, eyebrow, or nose rings or studs. In addition, only clear or skin-tone plastic pins/spacers to keep the piercing hole open are allowed.

### C. Wearing of Uniform

1. Cadets will ensure that when articles are carried in the trouser pockets they do not protrude from the pocket or present a bulky appearance. Items such as keys, keychains, lanyards, or carabineers will not be attached to belt loops or belts. Nothing may be placed in the uniform shirt pockets. Trouser pockets are to remain buttoned at all times.
2. While in uniform, cadets will not place their hands in their pockets, except momentarily to place or retrieve objects.
3. Uniforms will be kept buttoned, zipped, and snapped. Broken or missing buttons will be replaced.
4. Metallic devices such as metal insignia, belt buckles, and belt tips will be kept shined and will be free of scratches and corrosion.
5. Medals and ribbons will be clean and not frayed.
6. Shoes will be cleaned and brush-shined daily to ensure they are free of scuffs. Shoes will be kept tied and in good repair. Black, calf-length socks, without logos/patterns, will be worn with all classes of uniform. All cadets are required to wear black, leather, low-quarter, military-style shoes with the uniform (the only exception is Crack Drill Squad members who may wear shoes approved by the Commandant of Cadets).
7. Lapels and sleeves of coats and jackets will be roll-pressed (without creasing). Trousers will be creased. Although some uniform items are made of wash-and-wear materials or treated with a permanent press finish, pressing will be required to maintain a neat cadet appearance. However, before pressing, cadets should read and comply with attached care instruction labels.
8. Shirts will be tightly tucked in trousers at all times. Shirts will not be pulled out over the belt. Gig lines will be straight at all times.
9. Frayed, torn, soiled, or unsightly clothing is not permitted.
10. Coats, sweatshirts, caps, etc. will not be worn to class unless authorized STA outer garments are prescribed by the training schedule.
11. Distinguishing insignia and accouterments will be worn at all times (patches, brass, and insignia of rank, nameplate). All authorized awards (decorations, cords, and ribbons) will be worn on the Class A and A1 uniforms.
12. The black and white service caps are required for outdoor formations and for indoor in-ranks inspections, unless directed otherwise.

13. During periods of severe wet and cold weather, cadets may wear boots with the uniform during transit to and from school. Cadets will change into authorized footwear upon entering school.
14. Neckties will be tied to hang no lower than the top of the belt buckle or no more than three inches from the top of the belt buckle. The knot will be tied as a "Half or Full Windsor" knot, will be neat and cover the top button of the shirt which will be buttoned. When tied, the back part of the tie will be shorter than the front and will not be tucked into the shirt. A conservative tie tack or tie clasp is authorized.
15. All cadets will wear the regulation blue nylon belt with silver buckle. The tipped end will pass through the buckle to the wearer's left and will not extend beyond the end of the buckle (no fabric of the belt may be visible). The end of the belt without the tip may extend beyond the keeper portion of the inside of the buckle as long as it is not visible when worn. Excess fabric should be trimmed and removed. Honor Guard, Crack Drill Squad, Ranger Team and Rifle Team members may wear their associated custom belt and buckle when earned.
16. A solid white, short-sleeve or long-sleeve, crewneck undershirt will be worn with all uniforms. No lettering, emblems or logos are authorized. Sleeveless undershirts or tank tops are not authorized for wear.

#### **D. Exceptions (Injured Cadet Policy)**

**Note:** All cadets out of uniform for injuries require a pass from a Military Instructor prior to the start of the school day; the injury will also be substantiated by a Military Instructor at that time. The pass will cover the entire time the cadet is to be out of uniform in accordance with (IAW) the health care providers directive. Exceptions will be granted on a case-by-case basis by the Commandant of Cadets or his representative.

If a cadet is injured, as determined in writing by a healthcare professional, **and the injury prevents him from wearing the uniform of the day** (as substantiated by the health care professional, and specifies the pertinent time period), the following guidance will apply:

1. If the injury is to an upper extremity and prevents the wearing of the uniform shirt, cadets will wear a collared, polo-type, STA spirit-wear shirt with dress khaki type pants and dress shoes. T-shirts are not authorized.



2. If the injury is to a lower extremity and prevents the wear of uniform pants or shoes, cadets will wear a collared, polo-type, STA spirit-wear shirt with STA spirit-wear shorts or joggers, and athletic shoes as deemed necessary.

### **E. Serviceability and Uniform Fit.**

The following is a summary of general fitting guidelines:

1. Serviceability. Cadets are required to maintain a serviceable and proper-fitting uniform at all times. When a uniform item is damaged or no longer fits, it must be repaired, altered or replaced before being worn. Because of projected cadet growth patterns, families must be prepared to replace uniform items during a cadet's tour at Saint Thomas Academy.
2. Blouse coat. The sleeve length will be one inch below the bottom of the wrist bone. The bottom edge of the blouse coat should be about mid-thigh while standing at attention.
3. Trousers. Trousers are to be fitted and worn with the lower edge of the waistband at the top of the hipbone, plus or minus 1/2 inch. The front crease of the trousers will reach the top of the instep and be cut on a diagonal line (West Point cut style) to reach a point approximately midway between the top of the heel and the top of the shoe in the back. The trousers may have a slight break in the front.
4. Long sleeve shirts. The sleeve length will extend to the mid-point between the wrist and the first knuckle of the thumb.

### **F. Jewelry**

A conservative wristwatch (brown, black, dark blue, gray or metal band), one ring per hand and a religious necklace (hidden beneath the t-shirt) are permitted. Jewelry, bracelets, key chains, earrings, neck chains, medals, pins, buttons and flowers are not authorized for wear with the uniform. Exceptions such as: Winter Carnival, Blood Drive stickers and Homecoming buttons may be worn during specified time-frames with approval from the Commandant of Cadets.

### **G. Wearing of eyeglasses**

1. Conservative (*as interpreted by Military Instructor*) prescription eyeglasses are authorized for wear.
2. Conservative sunglasses are authorized for wear outdoors, except when in formation.

## H. Final Authority

The Military Instructors are the final authority in determining uniform and grooming issues.

## REQUIRED UNIFORM ITEMS

### Cord, Distinctive shoulder

- A. STA Military Institute Shoulder Cord, yellow with gold finial is worn on the left shoulder of the Blouse Coat, if earned.
- B. STA Activity Shoulder Cord is worn on the right shoulder of the Blouse Coat, when authorized. Cadets serving in good standing in the following activities or teams are authorized to wear the cord.

### COLOR

Blue  
Orange/White  
Red  
Tan  
Blue/White  
Black  
Scarlet/Grey

### ACTIVITY

Band  
Honor Guard  
Crack Drill Squad  
Rifle Team  
Command Sergeants Major  
Ranger Team  
Cadet Master Gunnery Sergeant

**Unit Merit Devices (Colored Star):** If earned, the five-pointed white, blue, or gold star is worn on the blouse coat, centered 1/8 inch above the right breast pocket flap with one point up and two points down.

### Name Tag

- A. Blouse Coat: 1/4 inch below the top of the right breast pocket flap and centered.
- B. White and Blue Shirt: 1/4 inches below the top of the right breast pocket flap and centered.

## Insignia

- A. Cap Insignia and Chinstrap: The gold cap insignia and chinstrap are authorized in three configurations.
- B. Cadet officers wear the "Eagle" cap insignia with a single gold chinstrap.
- C. Band members wear the "Lyre" cap insignia with a single silver chinstrap.
- D. All other cadets wear the Standard STA cap insignia with a single black chinstrap.
- E. Insignia, Collar (Torch of knowledge): Worn by all cadets on the blouse coat. Placement is as follows:
  - 1. Blouse Coat, Enlisted: Worn on the right collar 5/8 inch above the lapel notch and centered between the inside and outside edges. The torch is aligned parallel to the inside edge of the lapel so that the bottom of the torch is angled through the notch.
  - 2. Blouse Coat, Officer: Same as above except that it is 5/8 inch below the lapel notch.
  - 3. Academy Collar Insignia (STA, Maltese Cross): Same placement as the torch insignia above for both officer & enlisted, but on the left side.
  - 4. Insignia, Officer, Gold ST: Cadet Officers wear the "ST" brass on the blouse coat collar where the Torch and Maltese brass are normally positioned for enlisted personnel; they wear the Torch and Maltese brass on the lapels below the notch similar to how the enlisted wear them above the notch.
  - 5. Insignia, Rank:
    - Cadet Officer:**
      - 1. Blouse Coat: Metal rank insignia are worn on both shoulder loops of the blouse coat, centered between the front and rear edges, and between the shoulder seam and the loop button.
      - 2. Blue and White Shirts: The rank insignia is embroidered on shoulder boards. The shoulder boards are worn over the shirt shoulder loops with the wide edge toward the shoulder seam.
    - Cadet Enlisted:**
      - 1. Blouse Coat: The rank insignia is embroidered on shoulder boards. The shoulder boards are worn over the blouse coat shoulder loops with the wide edge toward the shoulder seam.

2. Blue and White Shirts: The rank insignia is embroidered on shoulder boards. The shoulder boards are worn over the shirt shoulder loops with the wide edge toward the shoulder seam.

6) ML Level Insignia: Will be worn on the right collar of the blue or white shirts centered and ½ inch from the front edge of the collar.

7) Unit or Company Insignia: Company/letter designation will be worn on the left collar of the blue or white shirt centered and ½ inch from the front edge of the collar.

**White Cap with STA Cap Insignia.** Worn by all Honor Guard cadets.

**Bow Tie (black, no decoration).** Worn after retreat (after 5PM) with the Class A or A1 uniform to designated social events.

**Cap, Service.** Worn with all uniforms at outdoor formations and as prescribed by the training schedule or the Commandant of Cadets. It must be worn with the chinstrap, crown stiffener, and cap insignia. It will be worn squarely on the head and not tipped backward or to the side.

**Sabers and Swords:**

- A. Sabers: The only cadet authorized to wear or carry a saber is the C/Colonel or a senior officer by the permission of the Commandant. Sabers are affixed to the left side of the Sam Browne belt with a Saber Guard and Chain.
- B. Swords: Cadet officers are authorized to wear Cadet Swords when designated by the Commandant. Swords are affixed to the left side of the Sam Browne belt with a Frog.

**Shoes:**

- A. Oxford, black, leather, low cut with laces and plain round toe. Only leather shoes are authorized. Worn with all classes of uniform.
- B. Tuxedo, Patent leather, pointed toe. Authorized for wear by Crack Drill Squad members.

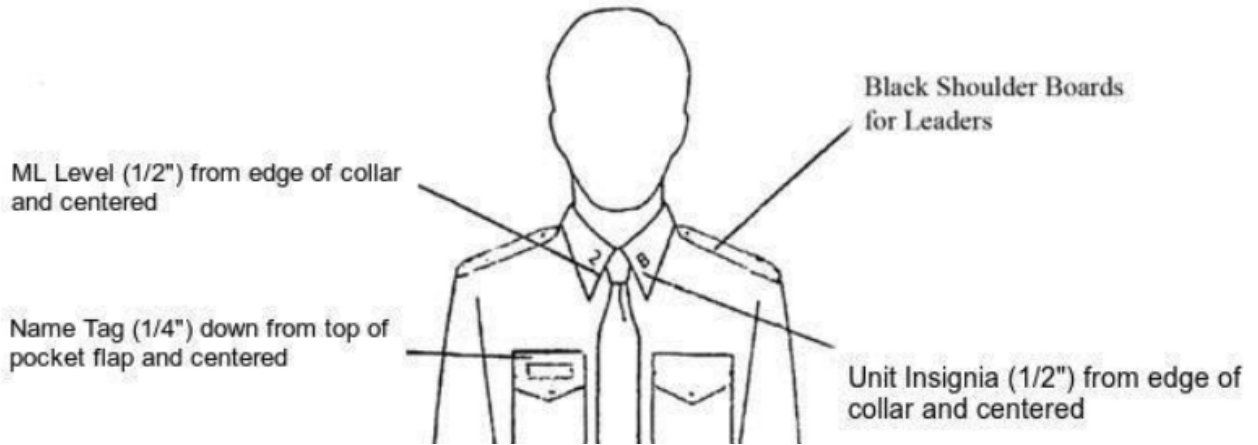
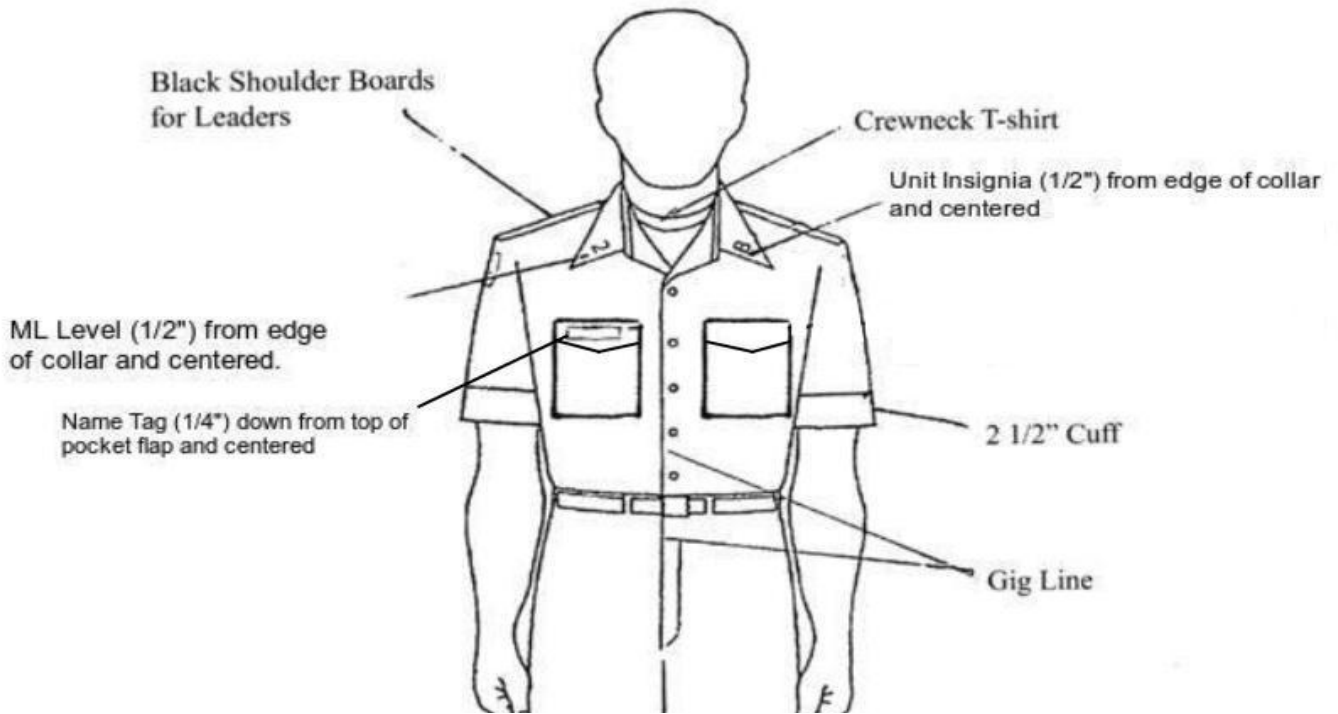

## OFFICER PLACEMENT ON BLOUSE COAT

Officer "ST" Brass worn on the Blouse Coat where the Torch and Maltese Brass are normally positioned for enlisted personnel; they wear their Torch and Maltese brass on the lapels below the notch, similar to how enlisted wear them above the notch.

Torch Brass is 5/8" below the lapel notch and placed so that a straight line is drawn through the center of the "ST" and Torch Brass

STA Maltese Cross is 5/8" below the lapel notch and placed so that a straight line is drawn through the center of the "ST" and Maltese Cross Brass

Honor School Star (Gold Star), is worn 1/8" above the right breast pocket flap with one point up and centered

Officer ranks are pinned on epaulet, centered between front and rear edges and between shoulder seam and loop button

Name Tag, 1/4" below the top edge of the right breast pocket flap and centered

Ribbons 1/8" above the left breast pocket flap and centered, no space between rows

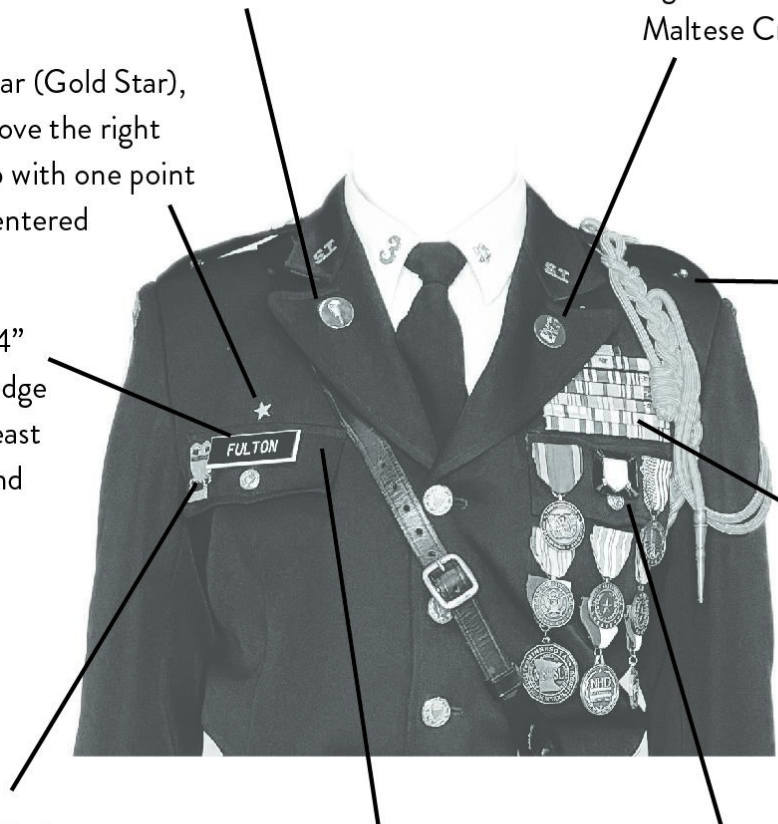

Eagle Award 1/4" below the top edge of right breast pocket flap, centered between right edge of pocket and right edge of name tag

Torch Award 1/4" below the top edge of right breast pocket flap, centered between left edge of pocket and left edge of name tag

Marksmanship badge 1/4" below the top of the left breast pocket flap and centered

# NCO AND ENLISTED PLACEMENT OF ITEMS ON BLOUSE COAT

Torch Brass is worn on the right collar and centered between the inside and outside edges. The torch is aligned parallel to the inside edge of the lapel so that the bottom of the torch is angled through the notch

STA Maltese Cross same placement as the Torch Insignia but on the left collar

Honor School Star (Gold Star), is worn 1/8" above the right breast pocket flap with one point up and centered

Shoulder boards slide over the epaulet

Name Tag, 1/4" below the top edge of the right breast pocket flap and centered

Ribbons 1/8" above the left breast pocket flap and centered, no space between rows

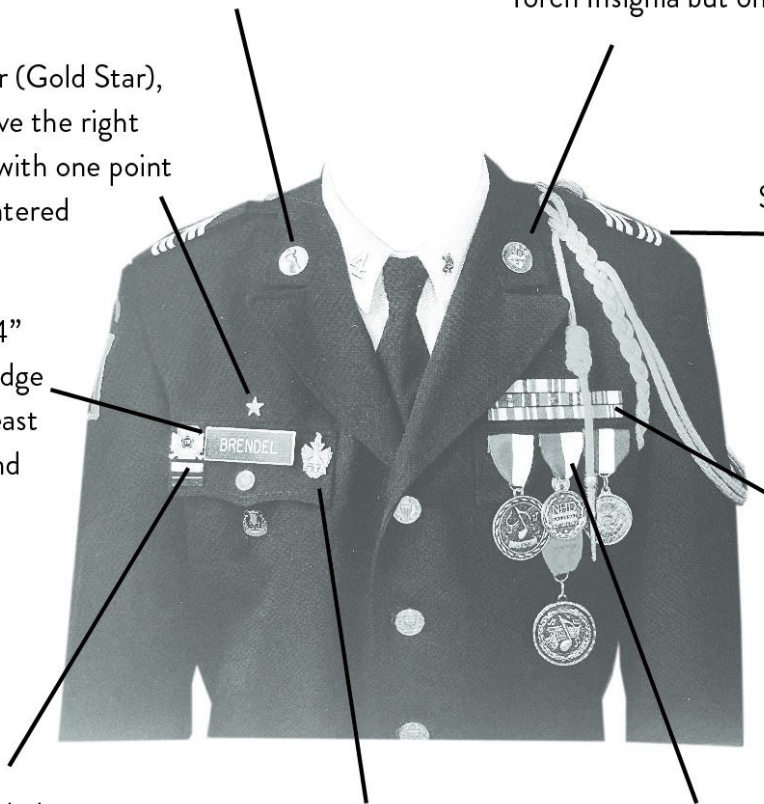

Eagle Award 1/4" below the top edge of right breast pocket flap, centered between right edge of pocket and right edge of name tag

Torch Award 1/4" below the top edge of right breast pocket flap, centered between left edge of pocket and left edge of name tag

Marksmanship badge 1/4" below the top of the left breast pocket flap and centered

## REQUIRED UNIFORM LIST Grades 9-12

<u>Item</u>	<u>Quantity Required</u>
Blouse Coat	1
Trousers (Gray)	2
Blue shirt	2
White shirt	1
Garrison cap	1
Tie (Black)	1
White Gloves	1
Nametag	2
Belt, blue with silver buckle	1
STA Insignia	1
Insignia, Cap, Enlisted/Officer/Band as required	1
Torch	1
Year brass	2
Company brass	2
Yellow Citation Cord	1
Shoes, low quarters, black oxford leather	1
White pants	1
<b>OPTIONAL</b>	
Black Sweater	1
Jacket, black leather	1
<b>OFFICER PACK</b>	
Sam Brown belt	1
Cap Eagle	1
Cap strap gold	1
ST brass (set)	1
<b>BAND PACK</b>	
Cap lyre	1
Lapel lyre	1
Cap strap silver	1
<b>HONOR GUARD PACK</b>	
Garrison Capt, White	1
Parade Belt, White	1
Leather Belt	1
Custom (HG) Buckle	1
White and Orange Cord	1
White Gloves with rubberized palm	1



**Quartermaster Store Hours:** The store's current hours are posted on the QM door in the Garberg Wing.

### **Out of Uniform Days**

Occasionally, cadets are afforded the opportunity to attend school in civilian attire. These days are associated with specific school-pride events or as a reward for a significant accomplishment. If an "Out of Uniform" day is announced with a theme (e.g. jersey day, blue out, Halloween... etc) Cadets are expected to participate in the theme of the day or they will wear the Class B uniform. If no theme is provided, Cadets may come in appropriate civilian attire. Shirts cannot be tank-tops or crop tops and shoes must be worn. Additionally, t-shirts must be in good taste, cover the stomach, and not advertise/promote drugs, alcohol, profanity, bodily functions, or anything sexual in nature. Cadets may not dress as VIS students or girls/women. Lastly, grooming standards (hair, shave, shower) still apply when out of uniform. School administration will determine the appropriateness of any article of clothing.



















### **AWARDS**







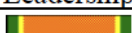
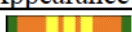
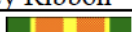









1. Eagle, Saber, and Torch Awards. The Eagle Award is worn on the right breast pocket flap of the blouse coat, 1/4 inch below the top edge of the pocket flap, centered between the right end of the name plate and the right edge of the pocket flap. The Torch Award is worn on the right breast pocket flap of the blouse coat, 1/4 inch below the top edge of the pocket flap, centered between the left end of the name plate and the left edge of the pocket flap. Saber is worn to the wearer's right if no Eagle is worn and to the wearer's left if an Eagle is worn. Cadets will wear no more than two academic awards on their blouse coat. If all three awards are earned, the highest two will be worn.
2. Key Volunteer/JA Pin. Worn 1/8 inch above the right breast pocket flap centered between the gold star and the left edge of the pocket.
3. Ribbons. Ribbons are worn on the left side of the blouse coat with the bottom row centered on, and 1/8 inch above the left breast pocket flap. Each row can have a maximum of three ribbons with successive rows placed immediately above the lower row. No space is authorized between rows. Ribbons are arranged in order of precedence, higher always above and/or to the wearer's right of a lower ribbon. Your lowest ribbon will be worn on the

bottom row, to the far left and 1/8 inch above the left breast pocket flap on the blouse coat. If you only have one ribbon it will be centered 1/8 inch above the left breast pocket flap.

4. Medals. Full-size medals are worn on the left breast pocket flap of the blouse coat 1/4 inch below the top edge of the pocket flap and centered. For any award, the full-size medal or the ribbon may be worn, but not both. A maximum of 15 medals may be worn at one time, in five rows of three. If medals are worn with the marksmanship qualification badge, the medals will be worn to the left and right, equally spaced between the marksmanship badge and left/right edge of the pocket and 1/4 inch below the top edge of the left breast pocket flap. Cadets are authorized to stagger the display and in no particular order.
5. Co-curricular Arch Pins. Arch pins will be worn one inch below the right breast pocket flap and centered. Cadets with multiple co-curricular pins will wear them stacked in no particular order (with no space between pins).
6. Badges.
  - a. Military Band Distinctive Badge: Worn on the Blouse Coat. Band members will wear the gold metal "Lyre" badge centered 1/8 inch above the top row of ribbons or top edge of the left breast pocket flap if no ribbons are worn.
  - b. Marksmanship Qualification: Worn on the Blouse Coat. The marksmanship qualification badge will reflect the latest firing period shot by the cadet; if he did not qualify during that record fire session, no badge will be worn. If worn alone, the badge is centered 1/4 inch below the top edge of the left breast pocket flap.

### STA Ribbon Order of Precedence (2021-22)

Ribbon	Description/Criteria	R	BL	SL	GL
N-1-1 	One cadet per grade level as selected by the Cadet of the Year Board. (Student Selected)				
N-1-2 	One cadet per grade level with the highest GPA as identified by the Dean of Academic Life.				
N-1-3 	Cadets who attain a grade level of "A" in all subjects for the academic year.				
N-1-4 	Physically present at all scheduled classes during the past school year.				
N-1-5 	Student Council member / Class Officer				
N-1-6 	Satisfactory completion of one year of Leadership.				
N-1-7 	Member of Quiz Bowl, Mock Trial, Debate, Math, Knowledge Bowl, Speech Team, etc.				
N-1-8 	Member of Military Band, Chorus, Orchestra, Worship Band, Jazz Band, Vista Theatre, etc.				
N-1-9 	Citation, Kaydet, Cadence, Speech, Debate, Mock Trial, Japanese, EVT, etc.				
N-1-10 	Bowling, Chess, Frolf, Boxing, Drone racing, e-sports, IBA, Curling, etc.				
N-2-1 	Earned varsity letter (List Sport/Activity)				
N-2-2 	Scored <b>85%</b> or higher <i>in all categories</i> of the Cadet Challenge - not an average or a specific point total.				
N-2-3 	Member of STA athletic team (school or intramural)				
N-2-4 	Selected All-Conference or Honorable Mention (list sport/activity)				
N-2-5 	Selected All-State or All-American or Honorable Mention (List sport/activity)				
N-3-1 	An impact award for outstanding performance during a specific event as selected by the ML Dept. staff.				
N-3-2 	Cadets who consistently exceed published U&A standards as selected by the ML Dept. staff				
N-3-3 	Cadet/NCO/Officer of the Quarter				
N-3-4 	Awarded annually to members of the Crack Drill Squad.				
N-3-5 	Awarded annually to members of the Ranger Team.				

Ribbon	Description/Criteria	R	BL	SL	GL
N-3-6  Honor/Color Guard	Awarded annually to members of the Honor Guard.				
N-3-7  Rifle Team	Awarded annually to members of the Rifle Team				
N-3-8  Adventure Training	for completion of Boy Scout camps; Civil Air Patrol Camps; Ranger Challenge/Orienteering; JCLC, etc.				
N-3-9  Commendation	Cadet superior performance that exceeds that expected of a cadet of his rank and experience.				
N-3-10  Good Conduct	Outstanding conduct by receiving no more than 5 demerits during the previous school year.				
N-3-11  Summer Camp	Attended a summer camp (JCLC), Senior Cadet Leaders Workshop, or New Student Orientation				
N-3-12  Marksmanship	Awarded annually to those who qualify in the STA Marksmanship Program				
N-3-13  Best Squad	Awarded to winners of the Best Squad-Unit Competition (List Squad, Platoon, and Company)				
N-3-14  Best Platoon	Awarded to winners of the Best Platoon-Unit Competition (List Platoon and Company)				
N-3-15  Best Company	Awarded to winners of the Best Company-Unit Competition (List Company)				
N-4-1  Parade	Crack Drill Squad, Honor Guard, Choir, or Band members who have represented STA off campus in public appearances with a group.				
N-4-2  Recruiting	Participant in an off-campus school visit, Parent Night, School Orientation, ACE visit, school tours, etc.				
N-4-3  Student Mentors	Satisfactory participation in Campus Ministry or the Peer Mentor Program.				
N-4-4  NCO Leader	Awarded to any cadet NCO for consistent demonstration of leadership principles as selected by the ML Dept. staff				
N-4-5  Lifesaving	Awarded for attempted or successful lifesaving—though not necessarily at major risk to cadet				
N-4-6  Service Learning	Participant in any Service Learning Trip (i.e. Guatemala) or completion of Senior Service Hours (List)				
N-4-7  Excellent Staff Performance	Awarded to any Staff Officer who consistently sets the example for outstanding performance in their assigned role as selected by the Commandant of Cadets.				

## MERITS AND DEMERITS

The merit/demerit system is a means of monitoring a cadet's behavior, attitude, and appearance. The intent is to promote adherence to school standards and self-discipline. Cadet leaders, and faculty/staff members may assess merits and demerits. Merits are awarded for work, positive behavior and assistance rendered to Saint Thomas Academy. Demerits are given for poor behavior, poor attitude, and deficiencies in personal hygiene and/or uniform discrepancies.

1. The Commandant of Cadets and the Advanced Military Leadership Instructor are responsible for maintaining the program and serve as the final authority for appeals.
2. ML instructors are responsible for reviewing and approving/disapproving all cadet performance reports for their class, and serve as the first appeal level.
3. Battalion Commander and Cadet Colonel – Periodically review for excessive demerits, counsel cadet(s) with company commander.
4. Cadet Company Commander, Cadet First Sergeant, Platoon Leaders and Platoon Sergeants. Review the status of merits/demerits for their company or Platoon on a weekly basis. Identify cadets with excessive demerits, counsel them with their Squad Leader as needed to improve performance.
5. Cadet First Sergeant. Input merit/demerits into the cadet database.

### Merits

Merits are awarded to cadets who, on their own time, volunteer to assist others in the STA community. Merits may be earned or awarded, on a case-by-case basis, for exemplary work actions. Merits **DO NOT AFFECT A CADETS GRADE**. Earned merits are tallied at the end of each quarter and awards are presented upon attainment of benchmarks. If an award is not earned, accumulated merits carry over to the next quarter or next school year. Merits are not awarded to "Work Off" or cancel demerits.

50 Merits – Bronze Award for Volunteerism

100 Merits – Silver Award for Volunteerism

200 Merits – Gold Award for Volunteerism

Any STA faculty/staff member or senior cadet leader who has direct supervision of the Cadet during the work performed or event attended can award merits.

Completed merit slips must include date of work, a brief description, and the legible signature of the supervisor / witness. Merit slips for work or event participation ***must be turned-in the next school day*** for the Cadet to receive credit. As a guideline, two merits will be awarded for each one-half hour of work (or 1 merit for 15 minutes) in performance of a service benefiting the Academy outside of school hours. This service must be under the supervision of a Cadet Senior Leader or Faculty/Staff member. Max of 8 merits per event, per day.

Examples include:

- Secret Santa (if service hours are not awarded)
- Meals on Wheels (if service hours are not awarded)
- Off-Campus Recruiting Events
- Work at STA-sponsored youth events
- Other service projects in connection with STA where service hours are not awarded.

**\* Cadets will not earn merits during school hours. This includes events for HG/CG and CDS. Cadet are not allowed to work in lieu of demerits or to “work-off” demerits issued.**

## **Demerits**

Standards. Demerits are issued for violating rules and regulations of the Academy. They are assessed commensurate with the seriousness of the offense committed. Whoever recommends assessment of demerits will fill out a Cadet Performance Report and ensure the recipient is aware of, and understands the violation for which he is being cited. A Cadet Performance Report may be executed at any time of the day and more than once a day for the same correctable violation if the cadet does not have a pass from their ML instructor.

Assessment of demerits: The list shown on pages 25-27 of this handbook indicates the recommended number of demerits for common violations. Violations not listed will be evaluated as minor (3 demerits), medium (5 demerits) or severe (10-15 demerits). Below is the Military Leadership grading policy as it pertains to cadet performance:

Each week, a cadet begins with 100 points for “deportment”. The attainment of demerits results in the reduction of this score. Each demerit results in a loss of 5 points (e.g. if a cadet receives 3 demerits for “talking in formation”, his maximum weekly score is an 85). The following week, a cadet begins anew at 100 points. At the end of the quarter, each weekly score is tallied and becomes part of the “cadet performance” grade which is equal to 50% of the overall cadet’s grade. The other 50% is based on “assessments”. Earning over 25 demerits in one quarter lowers the final ML QTR grade by one full letter grade. Earning over 40 demerits in one quarter lowers the final ML QTR grade by two full letter grades and could result in an abbreviated Board of Discipline with the Dean of Students and Commandant.

**Appeals.** Cadets who feel they have been erroneously or unjustly assessed demerits may appeal the demerits. The appeal process is as follows:

1. First contact the initiator of the demerits for reconsideration, informally (face to face) or formally (in writing via email for tracking purposes).
2. If the initiator rejects the appeal, the cadet may submit a written appeal (via email) to their Military Leadership Instructor. The appeal must be submitted within five school days of when the demerits were entered in the grade book. A letter of appeal will contain the following items:
  - a) Cadet’s name and date.
  - b) A statement that the initiator was contacted and rejected the appeal.
  - c) Full justification for the appeal.
  - d) A statement of the facts and circumstances relating to the incident.
  - e) The name of any corroborating witnesses.
  - f) Sign the appeal.
3. The Military Leadership Instructor will review the incident and issue a final decision. If further adjudication is warranted, the appeal will be forwarded to the Commandant of Cadets for a final determination.

**Serious Violations.** Cadets who commit one of the serious offenses listed below will be reported to the Dean of Students for appropriate action in addition to any assessment of demerits. Additional punishments may include, but are not limited to, permanent loss of all rank, loss of leadership position, and / or rank reduction.

- A. Skipping any class, mass, assembly period, or mandatory event
- B. Willful safety violation on firing range
- C. Stealing
- D. Lying
- E. Cheating
- F. Plagiarism
- G. Possession or consumption of alcohol or other drugs
- H. Vaping
- I. Fighting
- J. Conduct unbecoming a cadet

**Personal Appearance / Hygiene**

Poor personal hygiene / unsatisfactory overall appearance	5
Hair - unkempt, long ( <b>per day until standard is met</b> )	5
Hair needs washing, combing, or is dyed	3
Facial Hair - did not shave	5
Sideburns – long or flared	3
Wearing unauthorized jewelry	3
Fingernails (long or dirty)	3

**Uniform Appearance**

Unbuttoned coat	3
Unbuttoned shirt collar	3
Shoes dirty / not polished	3
Shoes not tied	3
Unauthorized Shoes	3
Brass - missing or not polished	3
Nametag missing or defaced	3
Patch missing or worn	3
Shirt un-tucked	3
Improperly folded sleeves	3
Tie - missing or not correctly worn	3
Wearing of unauthorized T-shirt or socks	3
Dirty, tears, broken zipper, missing button	3
Out of uniform without proper excuse (pass)	5
Pants – Low Slung	5



Wearing an unauthorized hat, jacket or sweatshirt	5
Wearing an authorized hat backwards	5
Wearing of unauthorized decoration or rank	10

**Department**

Chewing gum, eating/drinking during class	3
Late for class	3
Talking in formation / class / event	3
Littering	3
Unsecured Property	5
Unprepared for Class	5
Inappropriate use of technology (other work/sites)	3
Absent detention	5
Standing in wrong company during formation	5
Failure to follow instructions / Unprepared	5
Failure to support Cadet Chain of Command	5
Throwing food	5
Inattention during prayer / pledge	5
Conspiracy to Commit Deception	5
Disrupting Class	5
Deception	5
Unauthorized Cell phone use	5
Ejected from class	5
Profanity	5
Late for school (unexcused)	10
Gross Out of uniform in public / off campus	15
Destruction of school property	15
Hazing	15
Disrespect to a faculty or staff member	15
Pornographic / indecent material in possession	15
Fighting / Conduct unbecoming of an STA Cadet	15
Skipping class / school	15
Academic Misconduct	15
Cheating / Stealing / Lying*	15

\* When cheating / stealing / lying / Academic Misconduct / Conduct Unbecoming / has been substantiated a cadet will lose one or more ranks, face possible removal from position, and the possibility of disciplinary action IAW school policy.

## PROMOTIONS AND ORGANIZATION

The promotion system is designed to recognize leadership and management skills. It is based on STA's model of strong ethical and moral leaders. A cadet's maturity, deportment, ability, and potential are all key in the attainment of rank and responsibilities. Promotions are limited by the rank and organizational structure and are merit based IAW the following criteria:

In order to be considered for promotion, a cadet must meet ALL of the following:

- Be assigned to a position that allows for the promotion.
- Be recommended by his chain of command.
- Not be on the academic ineligible/recovery list.
- Have a ML grade of B or higher.
- Have less than 10 demerits for the quarter (less than 15 demerits for freshmen).
- All promotion recommendations are subject to the approval of the ML instructor.

**ONLY CADETS IN AUTHORIZED LEADERSHIP POSITIONS (Squad leader thru Cadet Colonel) ARE AUTHORIZED TO WEAR BLACK EPAULETTES.**

Cadets will retain the highest rank achieved the previous year whenever possible. Newly assigned leaders will be promoted incrementally as determined by the Commandant of Cadets. Promotions are not merely seniority based, nor are they permanent. A student who fails to meet the criteria/standards may be removed from position and/or reduced in rank.

**Reduction / Reassignment:** Administrative reductions are sometimes required if a cadet transfers from one company to another during the school year. The Commandant handles these on a case-by-case basis. Reduction of rank is also determined by the severity of discipline, excess demerits, or attitude problems.

Reduction may result in the loss of one rank to complete reduction to Cadet Private. Reassignment or removal from a leadership position may also be necessary. The Commandant will approve each reduction.

## SENIOR LEADER APPLICATION PROCESS

*All juniors are required to apply.*

# Saint Thomas Academy Corps of Cadets Organization

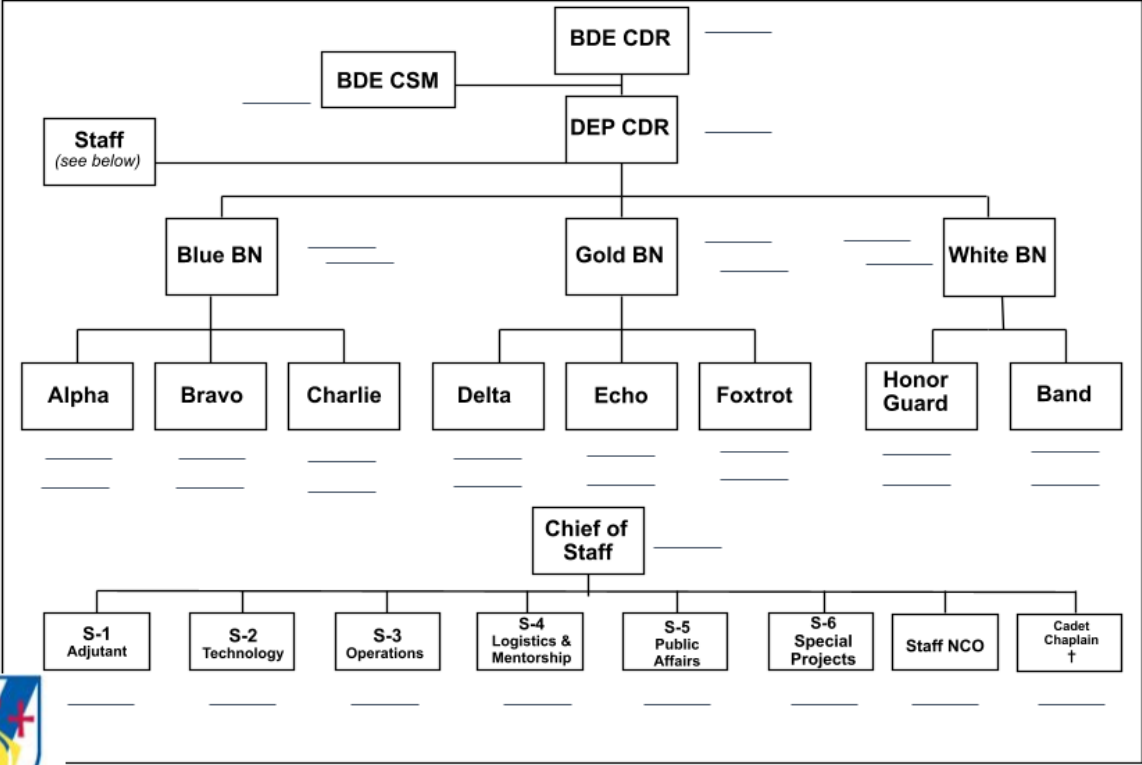

# Saint Thomas Academy Company Level Organization

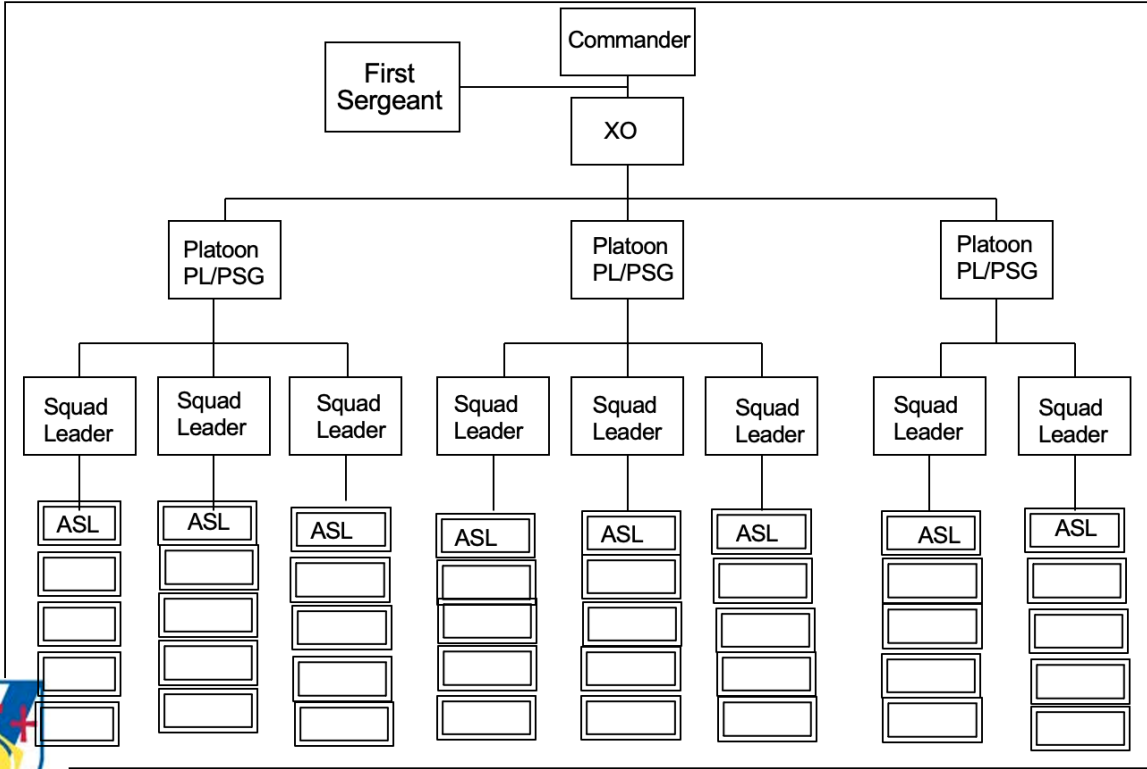

## ***STA Cadet Creed***

I am a Saint Thomas Academy Cadet

I pledge to uphold this school's brotherhood, integrity, and diligence.

I will love God, help my neighbor, and serve those in need.

I will be loyal to my nation and always strive to be an outstanding citizen.

I will support, respect, and aid my fellow cadets, always.

I will seek excellence and will always work toward a brighter future.

I will honor the legacy of this institution and those who have come  
before me.

I am a Saint Thomas Academy Cadet, and I will always abide by this  
creed.

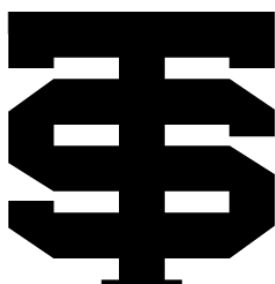

**STA Fight Song**  
***"Kaydet Rouser"***

Fight Cadets fight!

Carry high the blue and white.

Win Cadets, win!

Fight on and don't give in.

(Ra Ra Ra Ra)

Fight all the way

to Victory today!

We'll fight, fight, fight with all our might

For STMA!