

2

1

Back-To-Back Lockers Duplicate x4 for each Locker Room

18'

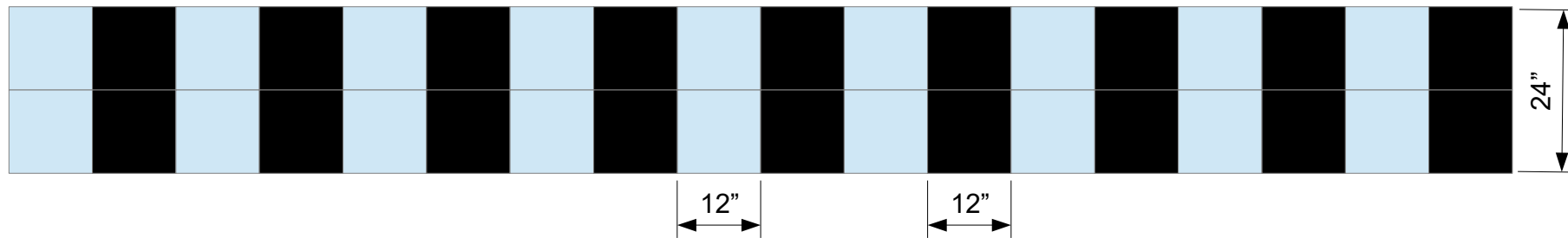

Back-To-Wall Lockers Duplicate x2 for each Locker Room

12"

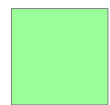
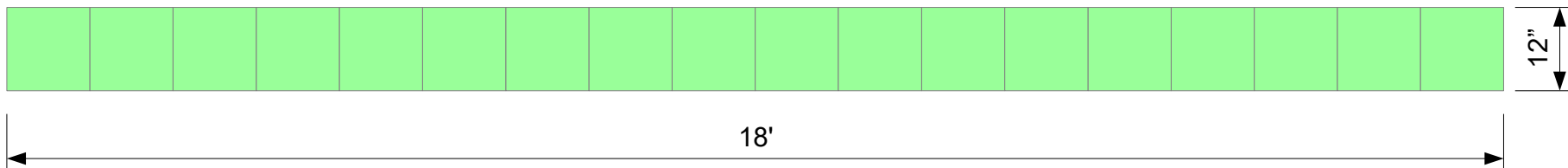

= 2-Tier "Back-To-Wall" Lockers
12"W x 12"D x 77"H
W/ Sloped Hoods



= 1-Tier "Back-To-Back" Lockers
12"W x 12"D x 77"H
W/ Sloped Hoods



= 6-Tier "Back-To-Back" Lockers
12"W x 12"D x 77"H
W/ Sloped Hoods

Project:

Jorgenson Lockers

Date:

2895 S 300 W
SLC, UT 84115

Drawn by:

101 Johnston Circle
Palmetto, GA 30268



Jorgenson Lockers

A div. of Jorgenson Industrial Companies

STRONG on Customer Service 877-952-0151

2

1

2

1

72" High Single Tier Jorgenson Athletic Locker Locker

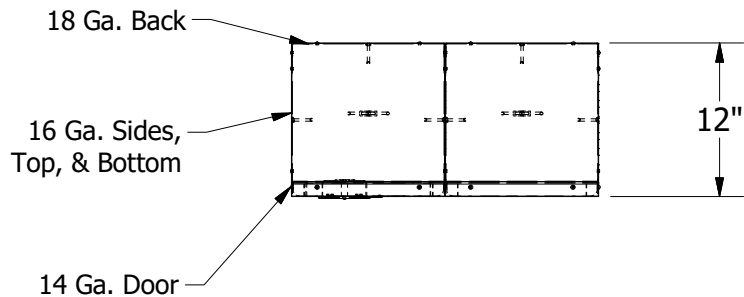

B

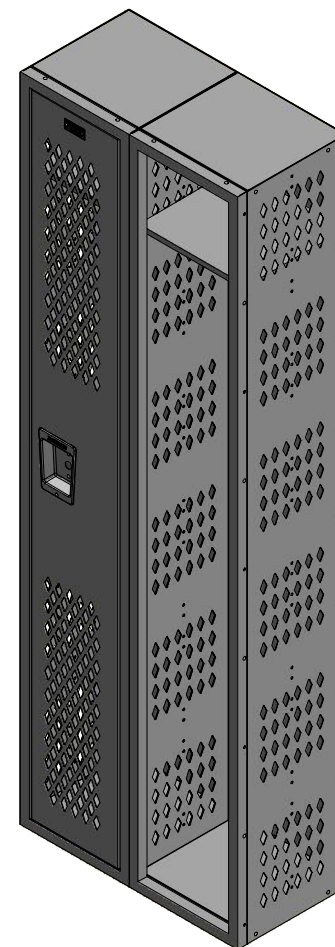
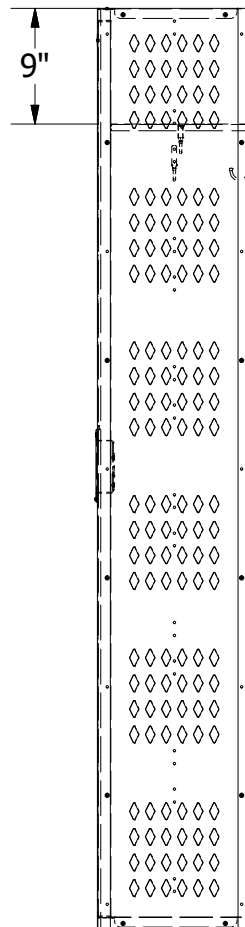
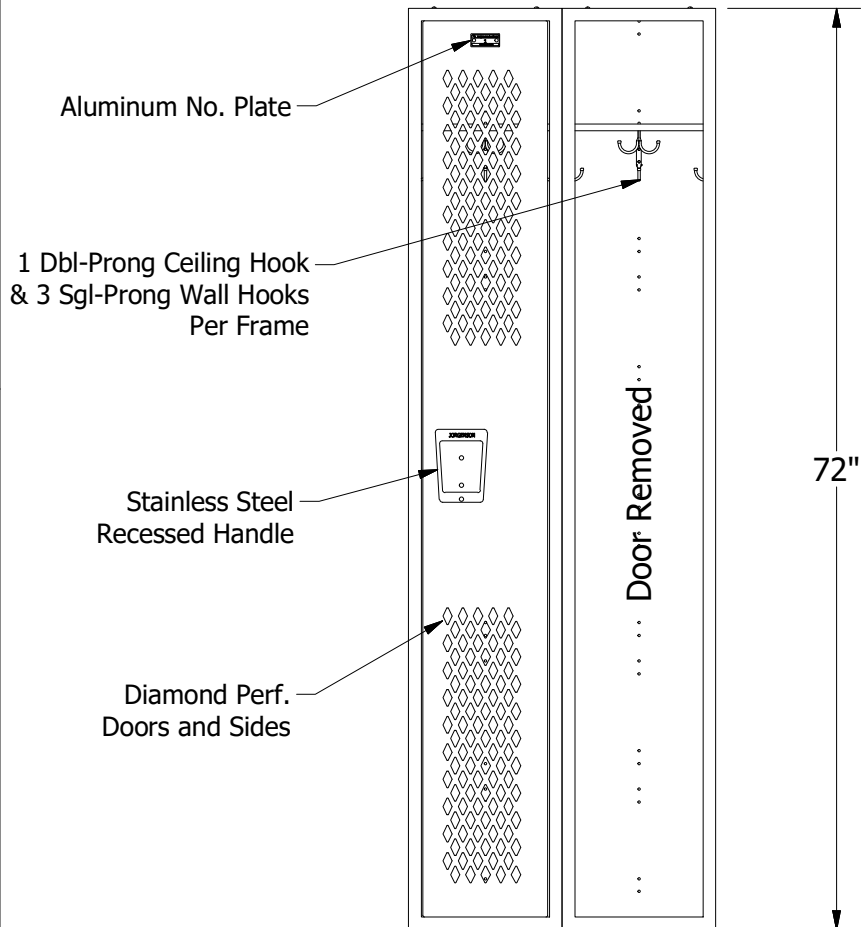

B

A

A

Allow $\frac{1}{16}$ " growth per frame

2

Project:

Date:

Drawn by:

Jorgenson Lockers

2895 S 300 W
SLC, UT 84115

101 Johnston Circle
Palmetto, GA 30268



Jorgenson Lockers

A div. of Jorgenson Industrial Companies

STRONG on Customer Service 877-952-0151

1

2



1

72" High 6 Tier Jorgenson Athletic Locker

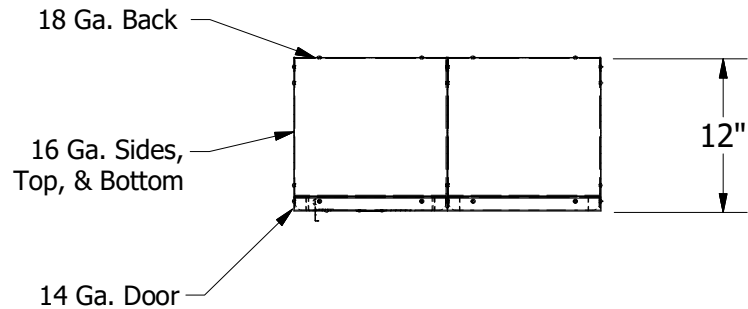

B

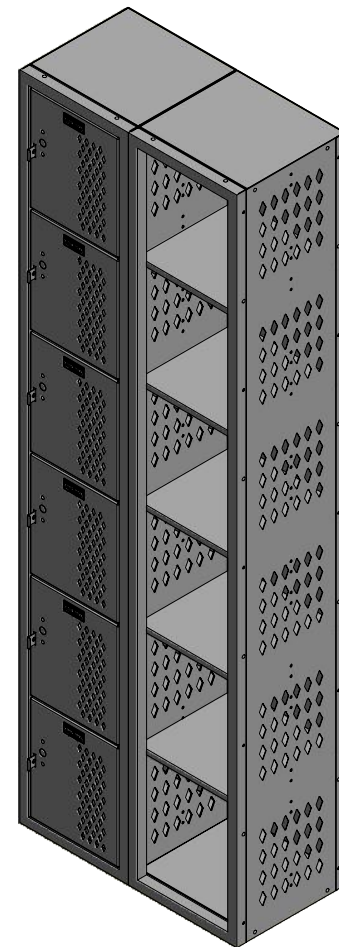
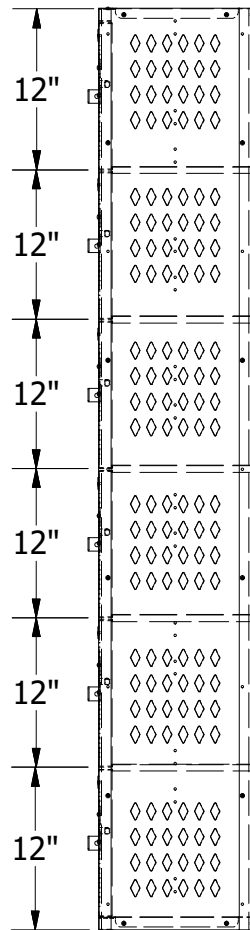
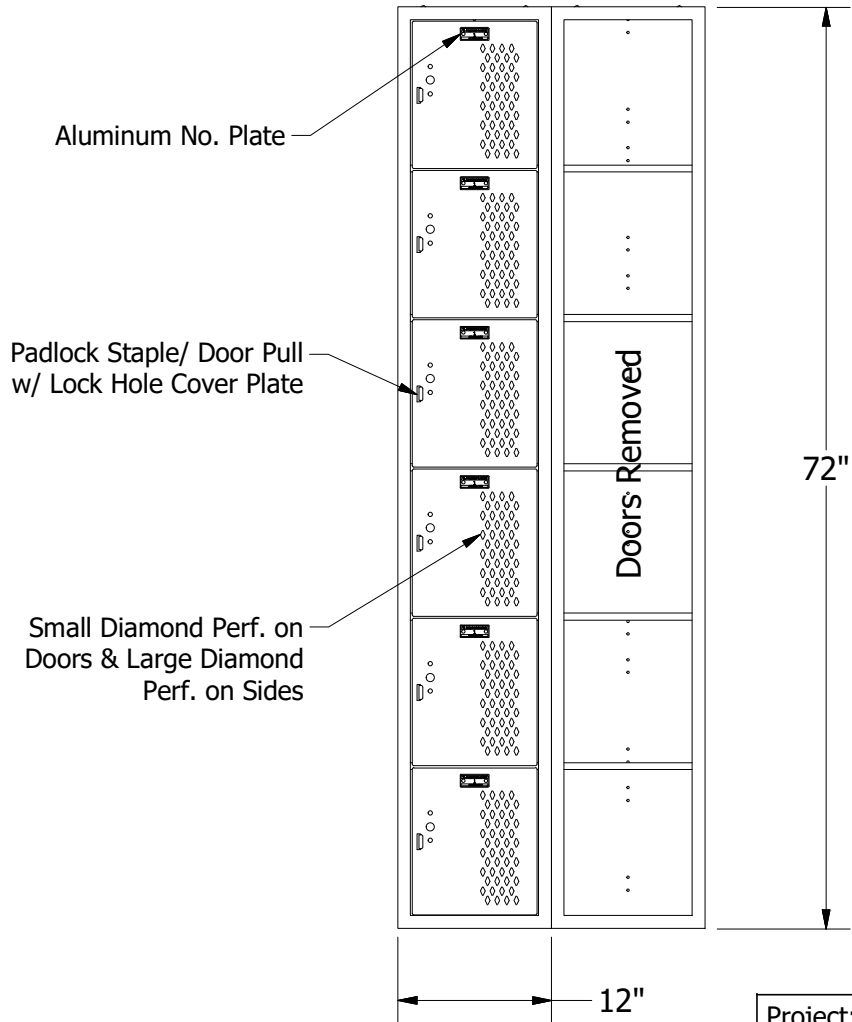

B

A

A

Allow $\frac{1}{16}$ " growth per frame

Project:

Date:

Drawn by:

Jorgenson Lockers

2895 S 300 W
SLC, UT 84115

101 Johnston Circle
Palmetto, GA 30268



Jorgenson Lockers

A div. of Jorgenson Industrial Companies

STRONG on Customer Service 877-952-0151

2



1

2

1

6T-1T-6T

B

B

A

A

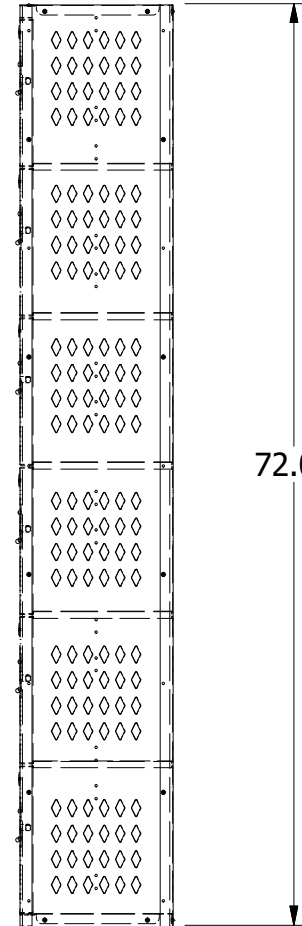
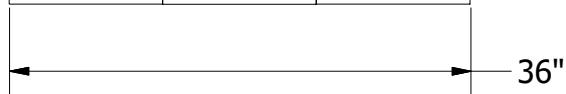
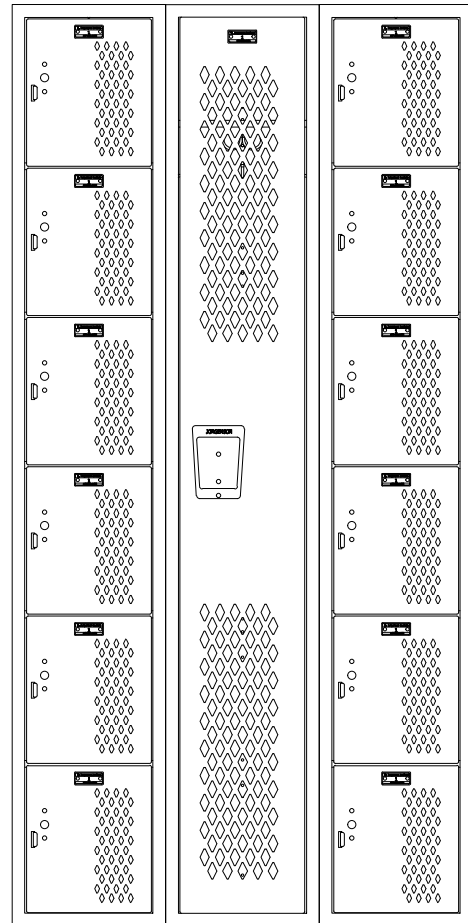

72.00

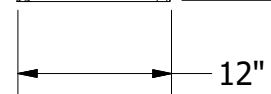

Sloped Hoods Not Shown

Project:

Jorgenson Lockers

Date:

2895 S 300 W
SLC, UT 84115

Drawn by:

101 Johnston Circle
Palmetto, GA 30268



Jorgenson Lockers

A div. of Jorgenson Industrial Companies

STRONG on Customer Service 877-952-0151

2

1

2



1

1T-6T-1T

B

B

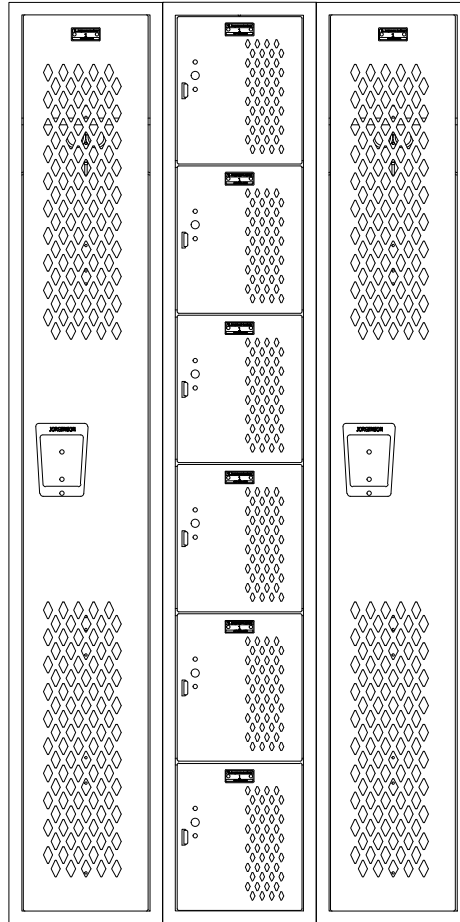

36"

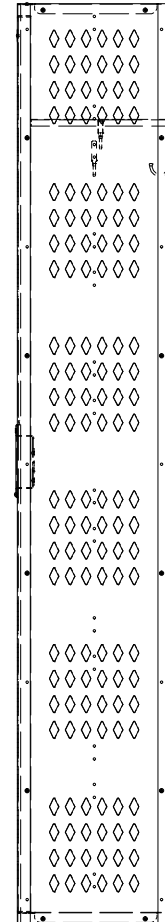

12"

72.00

A

A

Sloped Hoods Not Shown

Project:

Date:

Drawn by:

Jorgenson Lockers

2895 S 300 W
SLC, UT 84115

101 Johnston Circle
Palmetto, GA 30268



Jorgenson Lockers

A div. of Jorgenson Industrial Companies

STRONG on Customer Service 877-952-0151

2



1

2



1

72" High 2 Tier Jorgenson Athletic Lockers For "Back-To-Wall" Lockers

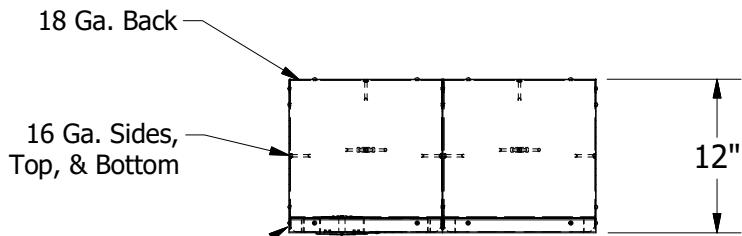

B

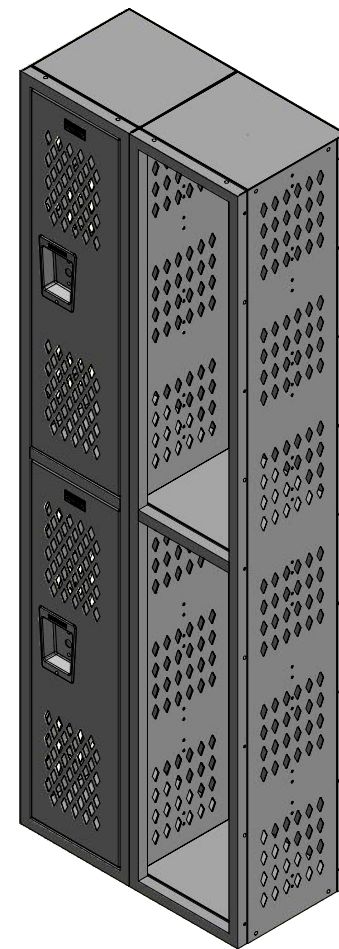
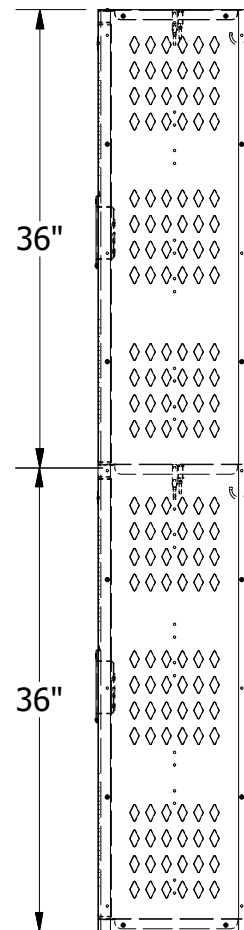
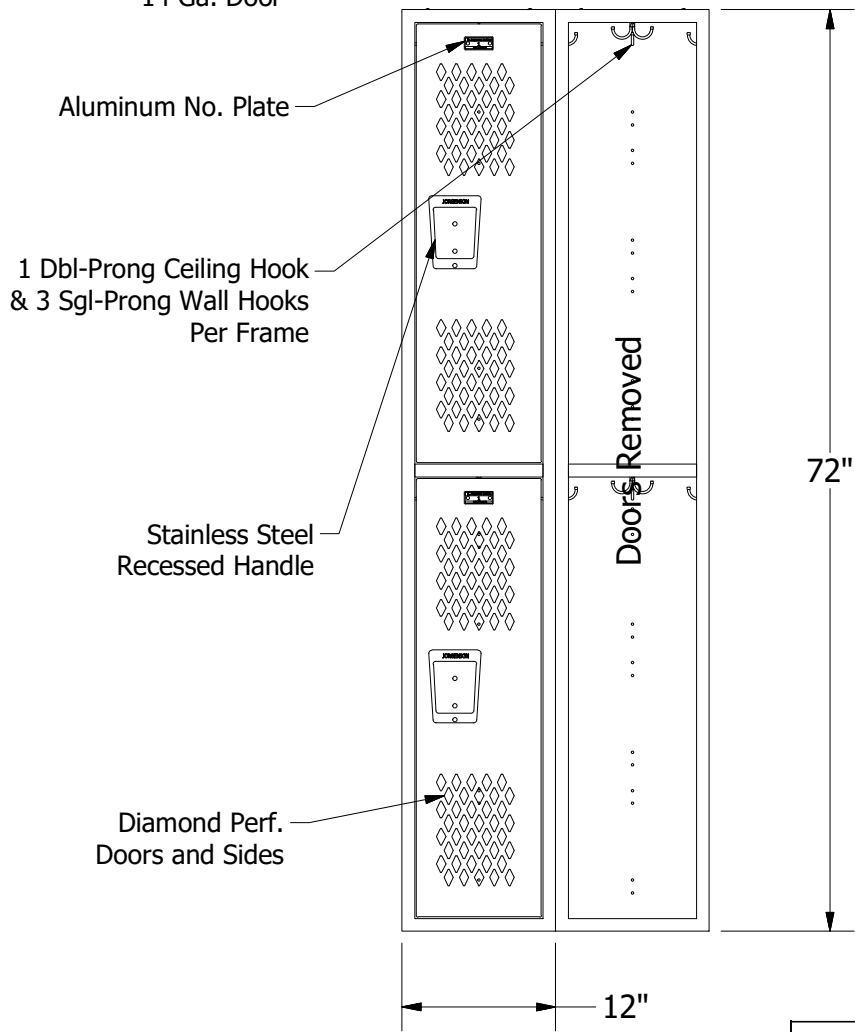

B

A

A

Allow $\frac{1}{16}$ " growth per frame

2



1

Project:

Jorgenson Lockers

Date:

2895 S 300 W
SLC, UT 84115

Drawn by:

101 Johnston Circle
Palmetto, GA 30268



Jorgenson Lockers

A div. of Jorgenson Industrial Companies

STRONG on Customer Service 877-952-0151

2

1

ERECTOR TO CUT HOOD TO SUIT CONDITION AND CONCEAL CUT EDGE UNDER SPLICE ASSY.

UNIVERSAL REAR HOOD SUPPORT

12"
15"
18"
21"
24"

SLOPE TOP CORNER FILLERS

HOOD SPLICE
SECTION

(2) REQ'D PER 6' SLOPED HOOD. THEY ARE SHIPPED FLAT & ARE TO BE BENT TO PROPER SIZE IN FIELD. EA. ONE HAS LOCKER DEPTHS SCRIBED ONTO THE SURFACE. BEND THE SUPPORT TO 90° @ THE LOC. THAT MATCHES THE LOCKER DEPTH.

SLOPE END (LH) SPECIFY (LH OR RH)

STD. 72 3/16" SLOPE HOOD LENGTH SHOWN N.T.S.

UNIVERSAL REAR HOOD SUPPORTS

STD. SLOPE ENDS (ONE LH ONE RH)

TYPICAL INSTALLATION

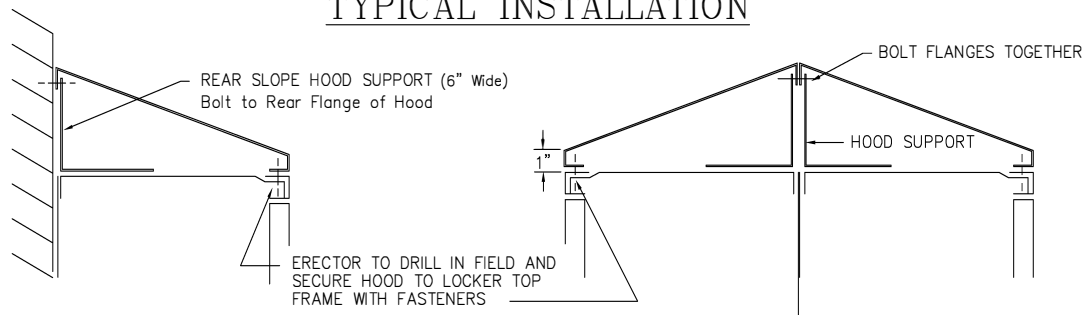

DETAIL OF SINGLE ROW SLOPE HOOD AT WALL

DETAIL OF DOUBLE ROW SLOPE HOOD

SLOPE HOOD INSTALLATION DETAILS

Project:

Date:

Drawn by:

Jorgenson Lockers

2895 S 300 W
SLC, UT 84115

101 Johnston Circle
Palmetto, GA 30268



Jorgenson Lockers

A div. of Jorgenson Industrial Companies

STRONG on Customer Service 877-952-0151

2

1

B

B

A

A