

# Available Room Arrangements

## Council Chamber B

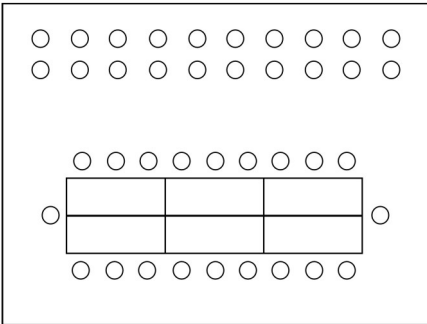

**Workshop**  
Up to 20 at tables,  
20 in audience

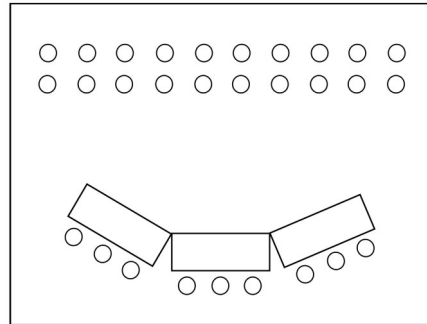

**Council**  
Up to 20 in audience, 9 at dais

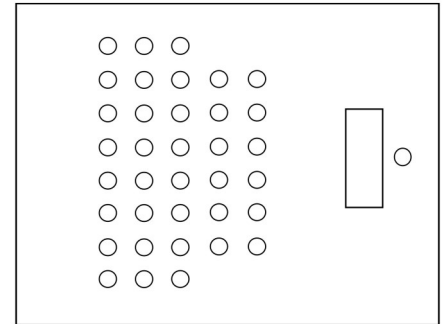

**Lecture**  
Up to 38 in audience,  
presenter at front table

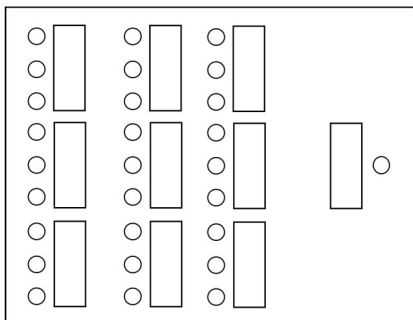

**Classroom X**  
Up to 27 at tables,  
presenter at front table

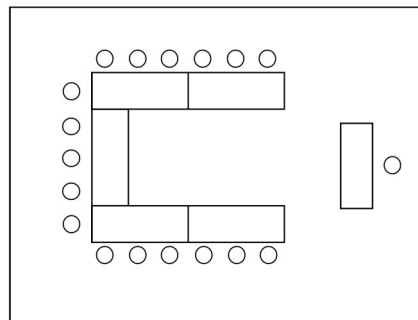

**Small Horseshoe**  
Up to 17 at tables,  
presenter at front table

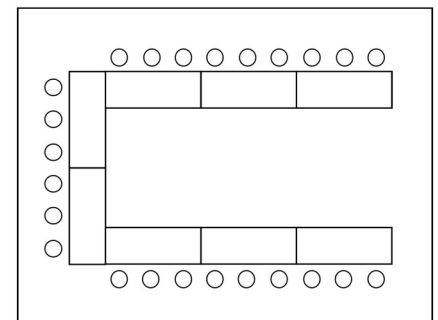

**Large Horseshoe**  
Up to 26 at tables

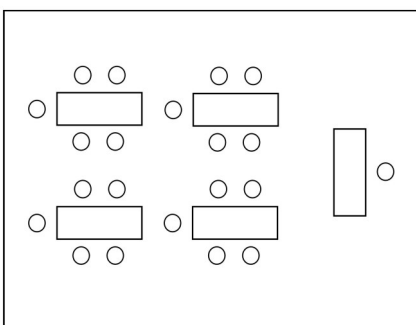

**Classroom Y**  
Up to 20 at tables,  
presenter at front table

*All room arrangements have been configured to maximum headcounts based on fire and safety codes. You may choose an arrangement above with a smaller headcount or a similar arrangement with a smaller headcount but no arrangements may exceed the listed maximums.*