

Public Health Pest Management

A Training Guide

Michael F. Potter and G. Mark Beavers

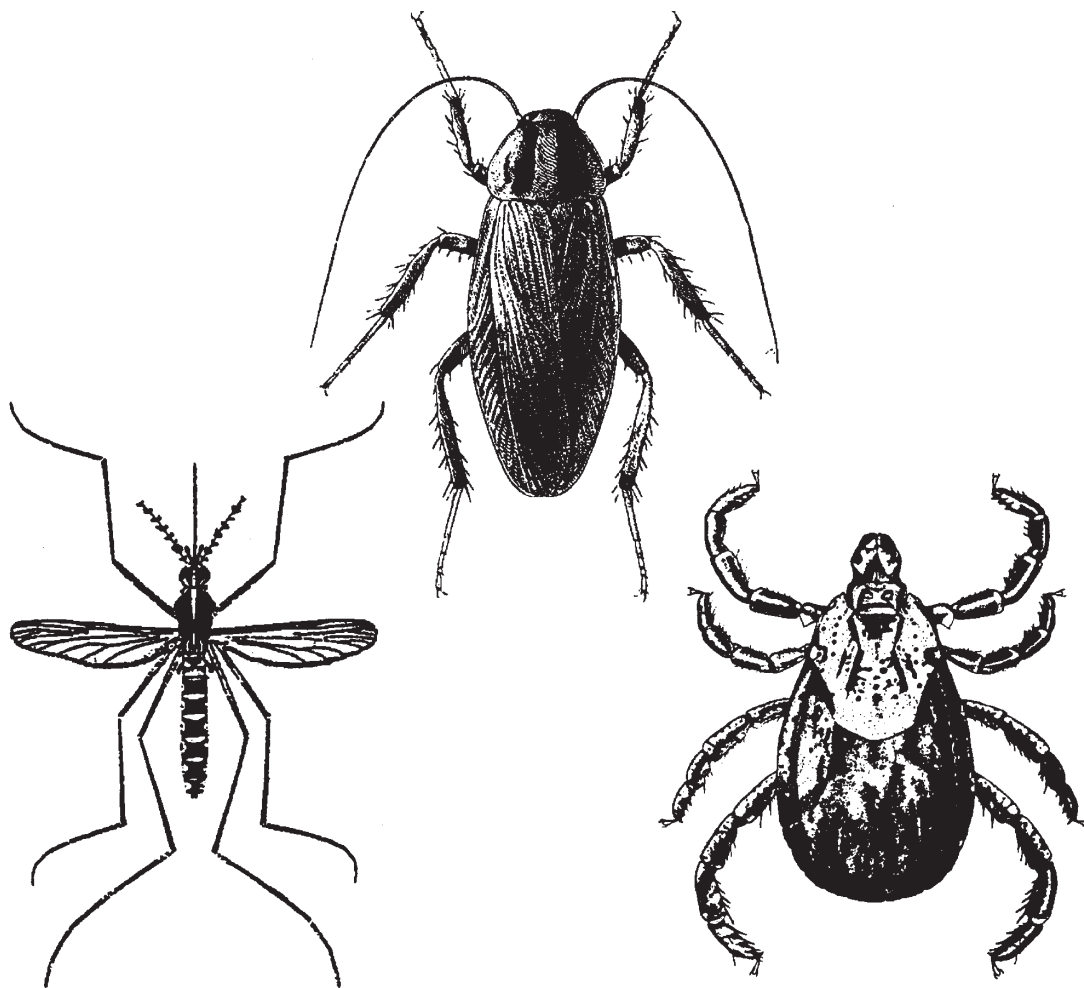

Table of Contents

Preface	ii
Introduction	ii
Cockroaches	3
Ectoparasites of Humans	6
Fleas	6
Ticks	8
Lice	11
Mites	12
Bed bugs	13
Mosquitoes	14
Flies	21
Wasps, Hornets and Yellowjackets	24
Spiders	26
Rodents	28
Birds	32
Itches, Irritations and Delusions	33

Preface

Federal and state regulations require that persons who apply pesticides meet minimum standards of competency. Information pertaining to general standards is contained in the Core Manual, *Applying Pesticides Correctly: A Guide for Private and Commercial Applicators*. This training guide (*Public Health Pest Management*) was developed to help you meet the specific standards for professionals engaged in public health-related pest control. Collectively, the two manuals contain information necessary to pass the Commercial Applicator Certification Exam, and become certified to use pesticides in Category 8, Public Health Pest Management.

Public Health Pest Management

A Training Guide

Michael F. Potter and G. Mark Beavers

Introduction

Insects, rodents, birds, and other pests cause billions of dollars worth of damage to our food, health, and property each year. Losses resulting from insect and rodent damage to stored food alone exceed \$1 billion annually. Many pests also transmit disease. Cockroaches, flies, mosquitoes, ticks, fleas, rodents, and birds are directly involved in the transmission of such diseases as food poisoning, malaria, typhus, viral encephalitis, plague, and Lyme disease. Other pests bite or sting or cause allergic reactions in the indoor environment. Finally, pests living in and around buildings are objectionable to most people simply by their presence, detracting from the overall quality of life.

This manual provides useful information on the identification, biology, significance and control of pests impacting public health. From a regulatory standpoint, the manual emphasizes the responsible use of pesticides. However, our greater goal is to provide a broader understanding of public health pest management, and encourage its implementation. This information will serve as a reference long after the certification exam.

Cockroaches

Cockroaches are among the most common insect pests found inside buildings. They are especially troublesome where food is prepared and sanitation is lacking. Cockroaches are repulsive to most people simply by their presence. They may

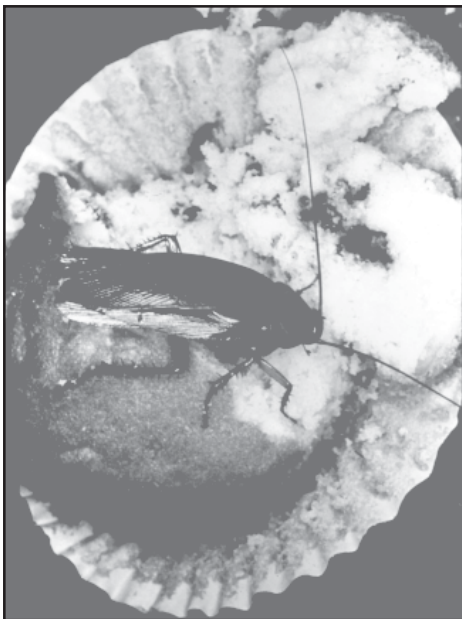

Fig. 1-1—Cockroaches contaminate food, transferring bacteria and other pathogens.

contaminate food, kitchen utensils, and other items, and they leave an unpleasant odor. Because cockroaches move freely from filth to food, they can transfer microorganisms that cause food poisoning and other illnesses (Fig. 1-1). Many people are also allergic to cockroach excrement and their cast-off skins, resulting in wheezing, watery eyes, and skin rashes.

Cockroaches enter buildings in various ways. They are often introduced in produce boxes, beverage cartons, or grocery bags. Species such as the American and Oriental cockroach also gain entry through cracks and openings around windows and doors, and through sewer and drain lines. While cockroaches thrive where sanitation is poor, even the cleanest home or restaurant can become infested.

Cockroaches are flattened, brownish, fast-running insects, with long, slender antennae. There are three life stages: egg, nymph, and adult (Fig. 1-2). The female cockroach produces small, brown, bean-shaped egg cases, called *oothecae*, that are deposited in out-of-the-way places. Several nymphs emerge from each egg case. Nymphs resemble adults except that they are smaller and lack wings. The nymphs gradually become larger and inhabit the same places as the adults. Cockroaches are prolific breeders. Species such as the German cockroach are capable of producing several thousand offspring in less than a year.

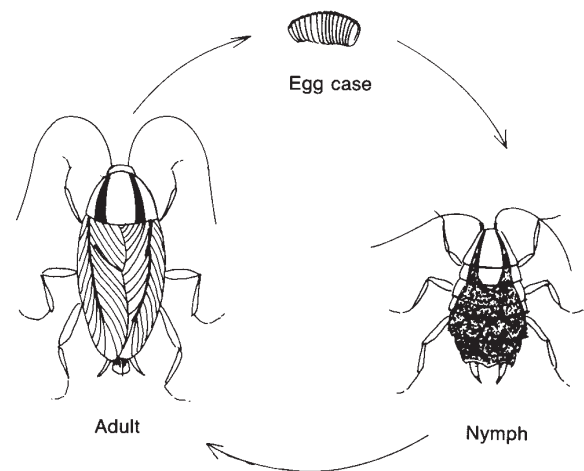

Fig. 1-2—Life cycle of the cockroach (nymphs molt several times).

Cockroaches are more active at night than during the daytime. During the day they generally remain hidden in small cracks and other dark, secluded areas which provide warmth and humidity. At night, they leave their hiding places and search for food. Cockroaches feed on a wide variety of foods and will eat anything consumed by man. They also feed on such materials as glue, hair, soap, fabrics, and filth. Cockroaches readily migrate from one room to another along plumbing and electrical lines and through cracks and openings within walls.

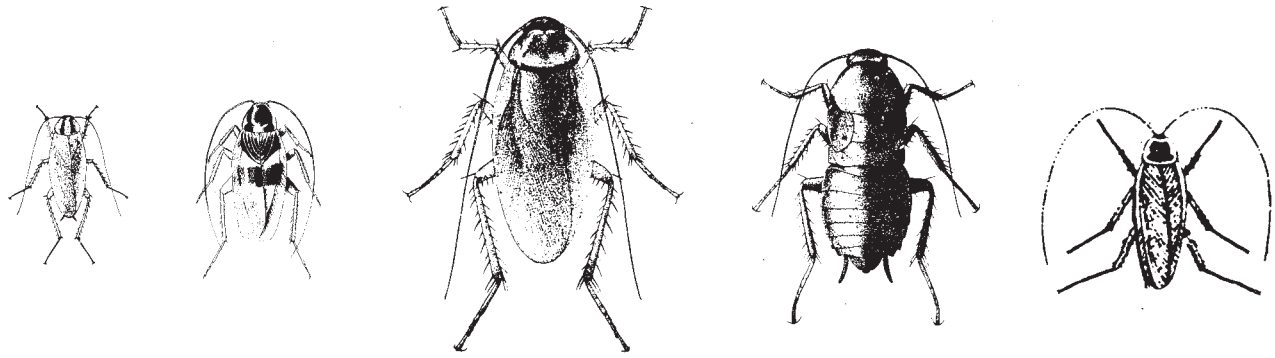

Fig. 1-3—Common structure-infesting cockroaches--Left to right: German, brown-banded, American, Oriental, and woods roach. Drawings approximate actual size of adults.

Types of Cockroaches

There are more than 50 species of cockroaches in the United States, but only a handful infest structures in Kentucky. Determining which type of cockroach is present is essential in knowing where to focus your control efforts. The following descriptions will help you identify common cockroach species. (Refer also to Figs. 1-3 and 1-4).

German Cockroach (*Blattella germanica*) is by far the most common and important cockroach species from the standpoint of public health. Adults are light brown and about 1/2 inch long, with two dark stripes running lengthwise along the shield-like area behind the head. The nymphs are smaller and

darker with a tan stripe down the middle of the back. German cockroaches reproduce very rapidly, which is one reason control can be difficult. A single mated female can produce an infestation of several thousand new roaches in less than a year.

German cockroaches require warmth, moisture, and food, which is why they are most common in kitchens, bathrooms, and eating areas. Preferred hiding places include cracks and crevices under sinks and toilets; beneath refrigerators, ice machines, dishwashers, and stoves; next to trash containers; and inside cabinets and pantries. German cockroaches also congregate in clocks, microwave ovens, and other electronic equipment. When populations are large or food is scarce,

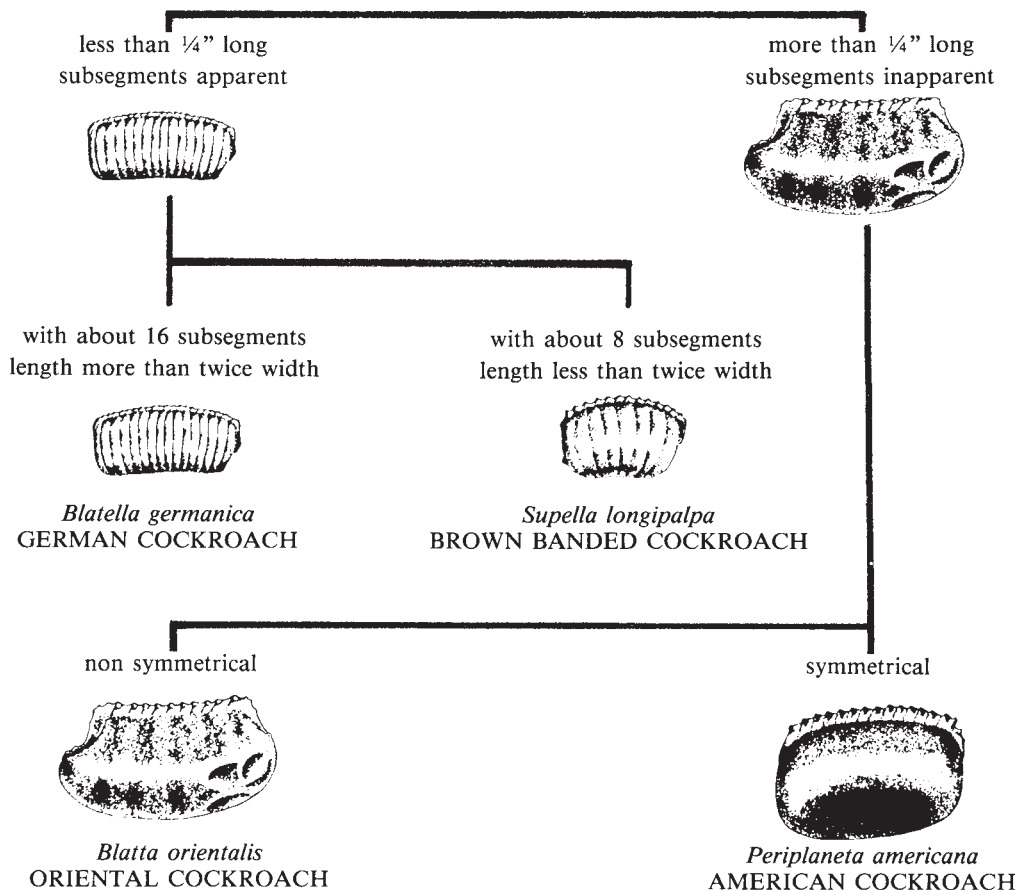

Modified from: U.S. DEPARTMENT OF HEALTH EDUCATION AND WELFARE
PUBLIC HEALTH SERVICE Communicable Disease Center, Training Branch, Atlanta, Georgia—1965

Fig. 1-4—Pictorial key to egg cases of common domestic cockroaches. (Harold George Scott, Ph.D., and Margery R. Brown)

they can be found in bedrooms, closets and other non-food areas. German cockroaches spend most of their time hidden in cracks and crevices, but can be quite mobile. They often travel between rooms or adjoining apartments along utility pipes and wires, and within wall voids.

American Cockroach (*Periplaneta americana*) is the largest cockroach found in Kentucky, measuring about 1 1/2 inches long when fully grown. It is reddish brown to brown, with a pale yellow band around the edge of the shield behind the head. Adults have well-developed wings, but seldom fly. Nymphs are smaller and lack wings, but are otherwise similar to the adults. The developmental rate of the American cockroach is much slower than the German cockroach, usually requiring more than a year from egg to adult.

American cockroaches prefer dark, moist areas, such as in basements and crawl spaces. They are often found nesting in floor drains, sump pumps, pipe chases, and laundry areas. They also frequent boiler rooms, steam heat tunnels, and sewers. During warmer months, this cockroach may be found outdoors and around outbuildings and woodpiles.

Oriental Cockroach (*Blatta orientalis*) is shiny black or dark brown, and the adult is about 1 inch long. Females have very short wings; males have wings that cover about half the abdomen. The entire life cycle may require one to two years.

The oriental cockroach is one of the filthiest cockroach species because it commonly infests cool, dark, damp places (e.g., sewers and basements), feeding on garbage, human waste, and decaying organic matter. The nymphs and adults are comparatively slow-moving and are generally found at ground level. They often are found living in floor drains and sump pumps. During warmer months, oriental cockroaches also live outdoors beneath leaves and plant mulch.

Brown-banded Cockroach (*Supella longipalpa*) is far less common than the German cockroach, but can be a problem in homes. Correct identification is important because it has markedly different hiding places and habits from the German cockroach. The brown-banded cockroach is similar in size to the German cockroach, but lacks the dark lengthwise stripes on the region behind the head. Instead, there are two transverse yellow bands across the base of the wings.

The brown-banded cockroach prefers to feed on starchy materials and may be found anywhere in a building. It does not require the close association with moisture, characteristic of the German cockroach, and is more often found in homes and apartments than in restaurants and other commercial food-handling establishments. In homes, brown-banded cockroaches are commonly found in rooms other than the kitchen and bathroom. Preferred locations include upper areas of ceilings, walls, cabinets, and closets; behind picture frames and wall decorations; and beneath or inside furniture. This roach attaches its pea-sized egg capsules to hidden surfaces, such as the undersides of dressers and tables.

Cockroach Management

Since cockroaches may be hiding in a great many places, a thorough **inspection** is essential to locate as many of these areas as possible. In performing the inspection, consider the unique habits and preferred harborage sites of the cockroach

species involved. A bright flashlight, inspection mirror (for inspecting underneath, above and behind construction elements), and a set of screwdrivers, pliers, etc., to access equipment and other potential hiding places, are essential tools for conducting a professional cockroach inspection. The use of a **flushing agent**, i.e., an insecticide containing natural pyrethrin, can also help to reveal hidden pockets of cockroaches. Pyrethrum is highly irritating to cockroaches and forces them out into the open. **Sticky traps** and **glue boards** are useful tools for pinpointing areas where cockroaches may be hiding. Monitoring traps should be placed at strategic locations, such as beneath sinks or behind refrigerators, and positioned flush against walls, corners, or at the junction of two or more construction elements. When foraging for food, cockroaches prefer to travel along edges and corners where two surfaces meet, rather than in the open.

Cockroach inspections must be performed in an organized, methodical manner. Otherwise, areas harboring cockroaches may be missed. This is especially true when inspecting restaurants and other commercial food handling establishments where there are countless cracks and crevices in which roaches can hide. A systematic way to inspect these facilities is to begin at a door or corner and inspect one 3- to 5-foot "zone" (extending from floor to ceiling) at a time. Continue in this manner around the entire perimeter of each room (kitchen, dining area, etc.), inspecting sinks, ovens, dishwashers, cabinets, and any wall-mounted fixtures or equipment. You will also need to make periodic "sidetrips" toward inner portions of rooms, i.e., away from wall areas, to inspect equipment, tables, etc.

Cockroaches are best controlled using a combination of techniques. Since roaches flourish where food, moisture, and shelter are readily available, **sanitation** is an important step in preventing problems. Crumbs, spills, grease, and other food debris should be cleaned, and unwashed dishes, kitchen utensils, and pet food should not be allowed to set overnight. Loose food should be stored in tight-fitting containers, and garbage, cardboard boxes, and paper bags should not be allowed to accumulate. Items in food storage areas should be removed from cardboard boxes and stored off the floor on stainless steel racks. Moisture leaks should be repaired and floor drains routinely sanitized.

Another element of cockroach management is **exclusion**, also known as pest-proofing. This involves the use of sealants such as caulk, foam, copper mesh, or cement. Sealing cracks, crevices, and other openings likely to harbor cockroaches eliminates the need to repeatedly treat these areas with insecticides. It is also a good idea to caulk or plug any openings where plumbing pipes or wires pass through walls or floors. This is especially useful in apartments to reduce migration of cockroaches between adjoining units.

Although good sanitation and exclusion are important, insecticides are usually required to eliminate an existing cockroach problem. To perform the treatment safely and effectively, care must be given to the type of insecticides used and how they are applied. Cockroaches spend very little time out in the open. Consequently, emphasis should be on **finding and treating cockroach harborages**, rather than treating

along baseboards, wallcoverings, and other exposed surfaces. Besides being more effective, directed placement of insecticides into cracks, wall voids, and other hidden locations ensures that residues will not contaminate food or food preparation surfaces, or be contacted by children or pets.

A wide variety of insecticide active ingredients and formulations is available for cockroach control. **Residual insecticides** are commonly used and provide effective residues lasting from a few days to several months. For these products to be effective, cockroaches need not be present at the time of application. The roaches are killed provided they remain on a treated surface long enough to absorb a lethal dose of insecticide. Common classes of residual insecticides include the synthetic pyrethroids (e.g., cypermethrin, cyfluthrin); organophosphates (e.g., chlorpyrifos, acephate); carbamates (e.g., propoxur); and inorganic dusts (boric acid, silica aerogel). Residual insecticides known as **insect growth regulators** (hydroprene, fenoxycarb) are also used in cockroach control. These materials disrupt the cockroaches' normal growth and development, causing the population to decline.

Residual insecticides may be formulated and applied as liquid or aerosol sprays, dusts, granules, or baits. Liquids and aerosols are typically used for injection into cracks and crevices, whereas dust formulations are used primarily for treating wall voids and hollow spaces beneath cabinets and appliances. Baits are also used widely in cockroach control and contain such active ingredients as hydramethylnon, sulfluramid, boric acid, and abamectin. Cockroach baits contain a slow-acting insecticide incorporated into a food attractant. Roaches locate and feed on the bait and crawl away to die, usually within a few days. Bait carried back to the nesting area also kills other roaches after being expelled in the sputum and feces. Some baits come pre-packaged with the insecticide and food attractant confined within a plastic, child-resistant container; others are formulated as pastes, dusts, granules, or gels. Since baits must be ingested to be effective, they must be placed within a few feet of where cockroaches are likely to be living.

Non-residual insecticides are those products applied to obtain control of cockroaches only during the time of treatment. Pyrethrin or resmethrin are often used in conjunction with residual products to locate and “flush out” hidden infestations of cockroaches. They can also provide rapid (although short-lived) knockdown of cockroaches present at the time of application. Non-residual insecticides are usually applied with aerosol or ultra low volume (ULV) equipment, and directed into areas suspected of harboring cockroaches. Indiscriminant dispersal of non-residual insecticides into the air (i.e., fogging or space treatment) in kitchens, dining rooms, storage areas, etc., should normally be avoided because it will only disperse and drive cockroaches deeper into wall voids and other protected locations.

Because cockroaches are typically found in areas where food is prepared or stored, special care must be taken not to contaminate food, dishes, cooking utensils, or food preparation surfaces with insecticides. Before treatment, these items should be removed, placed in plastic bags, or covered with polyethylene sheeting.

Before treatment, it is essential that all insecticide labels

be read in their entirety. Some products can only be used in “non-food” areas such as garbage rooms and mop closets, where foods are never processed, prepared, served, or stored. Other insecticides can only be applied into cracks and crevices to limit potential contact with food or food preparation surfaces. As with any insecticide application, the label is the best guide.

Ectoparasites of Humans

Several species of insects and related pests feed on people and their pets. These pests are called **ectoparasites** when they feed externally, taking blood from their host. In addition to the irritation caused by their bites, some ectoparasites such as fleas, ticks, and lice also may transmit serious disease-producing organisms.

Fleas

Fleas are small (1/16”), wingless, blood-sucking insects that commonly feed on pets and people. Their bodies are flattened from side to side, permitting easy movement through the hairs of the host. In addition to causing discomfort and irritation, fleas can transmit serious diseases to humans, most notably plague and fleaborne typhus. Fleas become carriers (vectors) of these diseases after feeding on infected rodents such as rats. Fortunately, plague and flea-borne typhus are seldom encountered in Kentucky. Fleas are, however, capable of transmitting tapeworms from pets to people. Fleas account for more than half of all dermatological conditions requiring veterinary assistance, and even a single flea bite to a hypersensitive animal or individual may cause intense itching and irritation.

The most common flea that infests structures in Kentucky is the cat flea (Fig. 2-1) which feeds on both dogs and cats. The dog flea, mouse flea, and rat flea are also sometimes encountered, especially where there have been no pets and the structure has had an infestation of rodents, squirrels, or other wild hosts. If the host dies or is removed from the home,

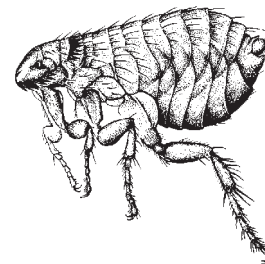

Fig. 2-1—Cat flea

the adult fleas will actively seek a new host. Some of the worst problems with fleas occur when a family moves into a home that previously had pets, or after an infestation of rats or mice has been eliminated.

The life cycle of the flea consists of four stages: egg, larva, pupa, and adult (Fig. 2-2). Adult cat fleas lay all of their eggs (up to 50 per day) **on the animal**. The eggs soon fall off into carpeting, beneath the cushions of furniture, and wherever else the pet sleeps or spends most of its time. Several hundred eggs may be laid by a single adult female flea. After hatching, the larvae feed and develop on organic de-

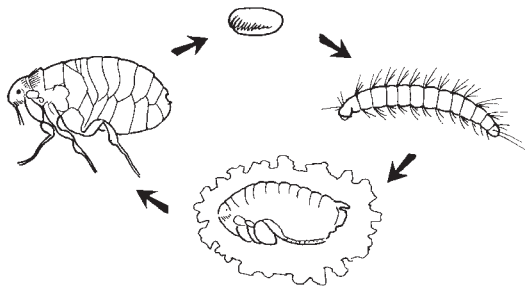

Fig. 2-2—Life cycle of a flea

bris, especially adult flea feces (dried blood), which accumulates along with the eggs in animal resting and bedding areas. Larvae remain hidden deep in carpet fibers, beneath furniture cushions, and in other protected areas. Before becoming adults, the larvae transform into pupae within a silken cocoon. Pupae remain inside the cocoon for 2 to 4 weeks, sometimes longer. The pupal stage is relatively resistant to insecticides, which is why some adult fleas are seen for an extended period, even after the home and pet are treated.

Adult cat fleas (the biting stage) spend virtually their entire life on the animal, as opposed to in carpeting, pet bedding, etc. This is why effective control of fleas requires treatment of the pet in conjunction with treatment of the premises.

MANAGEMENT

Effective flea control requires a systematic program consisting of inspection, client education, treatment of the pet, and treatment of the premises. Prior to treatment, the pet owner should:

- Remove all toys, clothing, and stored items from floors, under beds, and in closets, in order to provide access for treatment.
- Remove pet food and water dishes, cover fish tanks, and disconnect their air pumps.
- Wash, dry clean, or destroy all pet bedding.
- Vacuum all carpets, floors, throw rugs, and upholstery, especially in areas where pets rest or sleep. Vacuuming removes many of the eggs, larvae, and pupae developing within the home. It also stimulates pre-adult fleas to emerge sooner from their insecticide-resistant cocoons, thus hastening their contact with insecticide residues in the carpet. By raising the nap of the carpet, vacuuming improves the insecticide's penetration down to the base of the carpet fibers where the developing fleas live. Vacuuming should be thorough, especially in rooms or areas where pets rest or sleep. After vacuuming, the vacuum bag should be sealed in a garbage bag and discarded in an outdoor trash container.

Treating the Home - Once fleas become established in a home, insecticides are almost always needed to control them. Always read and follow label directions on the insecticide container. Other than the person performing the application, people and pets should be out of the house during treatment. **People and pets should also remain off treated surfaces until the spray has dried.** Drying may take several hours, depending on carpet type, ventilation, and method of application. Opening windows and running the fan or air conditioner after treatment will enhance drying and minimize odor.

A wide array of flea control products are available for home

treatment. The most effective formulations contain both an adulticide (e.g., chlorpyrifos, permethrin) effective against the biting adult stage, and an insect growth regulator (e.g., methoprene or fenoxycarb), necessary to provide long-term suppression of the eggs, larvae, and pupae. Most homeowners will find aerosol formulations easier to apply than liquids. Examples sold over the counter include Siphotrol Plus®, Fleatrol®, Basis™ House & Kennel Aerosol, and Raid Max® for fleas. **It is essential that the application be thorough and include all likely areas of flea development.** Carpets, throw rugs, under and behind beds and furniture, and beneath cushions on which pets sleep should all be treated. Pay particular attention to areas where pets spend time or sleep, as these will be the areas where most flea eggs, larvae, and pupae will be concentrated. Hardwood and tile floors generally do not require treatment, but should be thoroughly vacuumed and mopped.

Pet owners should expect to see some fleas for 2 weeks or longer following treatment. Provided all infested areas were treated initially, these “survivors” are probably newly emerged adults which have not yet succumbed to the insecticide. Instead of re-treating the premises immediately, they should **continue to vacuum.** As noted earlier, vacuuming stimulates the insecticide-resistant pupae to hatch, bringing the newly emerged adults into contact with the insecticide sooner. If adult fleas continue to be seen beyond 2-4 weeks, retreatment of the premises (and pet) may be necessary.

TREATING THE PET

It is important that the pet be treated in conjunction with the premises, preferably on the same day. Adult fleas spend virtually their entire life on the animal—not in the carpet. Untreated pets will continue to be bothered by fleas. They may also transport fleas in from outdoors, eventually overcoming the effectiveness of the insecticide applied inside the home.

Pets can be treated either by a veterinarian or the pet owner. A variety of on-animal formulations are available that may be prescribed by veterinarians. Some contain an insect growth regulator (IGR) to prevent eggs from hatching as they are laid on the animal. Two such products are Ovitrol Plus® and Basis™ Flea and Tick Spray. These products kill both adult fleas and flea eggs laid on the animal. Another very effective product is the Ovitrol Flea Egg Collar. Although the collar contains no adulticide, it prevents flea eggs from hatching for several months. For optimum results, the collar should be placed on the pet before flea season begins (April - May).

Similar results can be obtained with a product called Program®, which is administered orally to pets once a month as a tablet. When a female flea bites a Program®-treated animal, the flea ingests the active ingredient (lufenuron), which then passes into her eggs and prevents them from hatching. Like the Ovitrol Flea Egg Collar, pet owners should ideally begin using the tablets before flea season begins. Doing so will greatly reduce the chances of developing a serious flea problem later in the summer.

Pet owners should always read the pesticide label. Certain products can be used only on dogs, and some list specific treatment procedures for puppies and kittens. Do **not** treat pets with the same products used to treat carpeting or the yard. As men-

tioned, it is absolutely essential that pets be kept off treated carpets and surfaces until the spray has completely dried.

To reiterate, de-fleaing the pet is an essential step in ridding a home of fleas; however, pet owners must also treat the pet's environment (the home). **Having the pet dipped or using a flea collar will not, in itself, eliminate fleas in an infested home.**

TREATING THE YARD

Most flea problems in Kentucky can be eliminated by treating the pet and the interior of the home. In cases where pets spend most of their time outdoors, it may also be necessary to treat the yard. One way to determine if the yard is infested is to walk around the property wearing white athletic socks, pulled to the knee. If fleas are present, they will be seen against the white background of the socks.

Outdoor flea treatment should focus on areas where pets rest, sleep, and run, such as doghouse and kennel areas, under decks, along fences, and next to the foundation. It is seldom necessary to treat the entire yard or open areas exposed to full sun. Insecticide formulations containing chlorpyrifos (Dursban) or diazinon are effective for outdoor flea treatment. These can be applied with a hose-end or pump-up sprayer. Long-term suppression of fleas infesting kennels or outdoor areas can be enhanced with formulations containing a light-stable IGR such as fenoxycarb (e.g., Basis House & Kennel Aerosol or Torus[®]).

Fleas can be successfully controlled using the techniques described above. Homeowners who lack the time to control fleas themselves or who are uncomfortable applying pesticides may wish to enlist the services of a professional pest control firm.

Ticks

Ticks are small, insect-like animals that are commonly found in woodland, mixed shrub, and overgrown areas. With two body regions and eight legs, ticks are more closely related to spiders than insects. They are usually reddish brown to brown, and their bodies are oval and flattened. Ticks have four life stages: egg, larva, nymph, and adult (Fig. 2-3). The latter three stages feed solely on the blood of mammals, birds, reptiles, or amphibians. Some ticks feed exclusively on a single

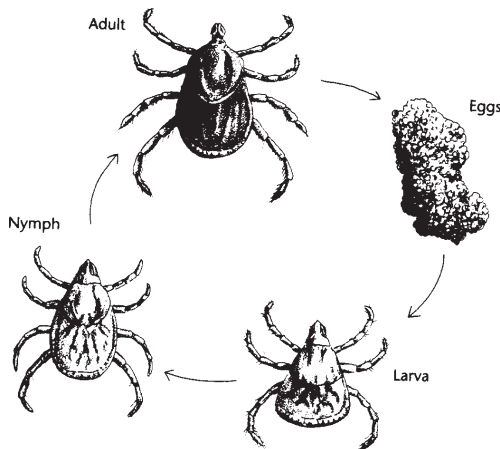

Fig. 2-3—The life cycle of a tick

host. Other species need two or more different animal hosts to complete their development.

Adult ticks usually mate on the body of the host animal.

The female then drops to the ground and deposits a mass of eggs which hatch into thousands of tiny larvae. The larvae, often called **seed ticks**, disperse and attach themselves to a passing rodent or other small animal. After feeding, the blood-engorged larvae drop off the host and transform to nymphs. The nymphs then crawl onto low vegetation and await another host for attachment and feeding before transforming to adults.

When not attached to a host, ticks remain on or near the ground. Since they cannot jump or fly, the larvae, nymphs, and adults climb onto tall grass, weeds, or brush to wait for a suitable host to pass by. Initial contact with humans is usually made on the foot, ankle, or lower leg. Once aboard, they crawl upward until constricted by skin folds or tight clothing, often attaching behind the knee, waist, armpit, or base of the scalp. Ticks are especially common along overgrown borders and paths, since these areas are frequented by passing hosts. Ticks are seldom found in open areas of mowed yards.

COMMON TICKS IN KENTUCKY

The most common ticks found in Kentucky (Fig. 2-4) are the American dog tick (*Dermacentor variabilis*) and the lone star tick (*Amblyomma americanum*). Both species readily feed on humans and pets. Another species, the brown dog tick (*Rhipicephalus sanguineus*), is less common in Kentucky, but can be a serious pest inside homes.

American Dog Tick — Adult American dog ticks are brown and about the size of a small pencil eraser. They have a silvery-grey, shield-like plate covering part or all of their backs. Adult females that have filled themselves with blood are slate-

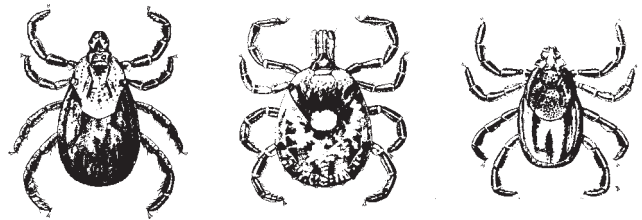

Fig. 2-4—(Left to right): American dog tick, lone star tick, and brown dog tick. The first two species are most common in Kentucky.

grey and about the size of a raisin. Larvae and nymphs are much smaller and more difficult to identify; they feed almost exclusively on small wild rodents. Consequently, only the readily distinguishable adults are found on humans and pets. Dogs are the preferred host, but these ticks also will feed on cattle, horses, and people.

The American dog tick is the principal vector of Rocky Mountain spotted fever (RMSF). It can also transmit tularemia and cause tick paralysis. Campers, hikers, and hunters are likely to encounter this tick in overgrown areas, woods, fields, and parks. Pet owners also frequently find this tick on their dogs, especially around the head and ears. The adult ticks are active in Kentucky from spring through mid-summer.

Lone Star Tick—The lone star tick gets its name from a distinct white spot on the back of the adult female. Adult males do not have this spot; instead, they have pale, lacy white markings on the rear edge of the back.

Lone star ticks are most prevalent in western and south-

central Kentucky, but are spreading to other areas. They are especially abundant during spring and summer. The life cycle is similar to that of the American dog tick with one notable exception: immature lone star ticks (larvae and nymphs) readily attack humans, whereas immature American dog ticks do not. Consequently, if you are bitten by tiny larval ticks (about the size of the period at the end of this sentence), or slightly larger nymphs, they are probably lone star ticks.

Lone star ticks are less frequent disease carriers than are American dog ticks, but they can transmit Rocky Mountain spotted fever and tularemia. The major problem with lone star ticks, however, is that they often occur in tremendous numbers, especially as immatures. A person who walks through vegetation containing a clump of larval lone star ticks may find hundreds of the tiny ticks crawling on him. Unattached larvae can be removed by bathing or showering. However, once ticks are attached, removal is difficult, and their bite can be very irritating. The attachment site can become inflamed and infected and is sometimes accompanied by a rash.

Brown Dog Tick—Although less common in Kentucky than the two previous species, the brown dog tick can be a serious pest on dogs. The ticks are usually found around the ears, between the toes, and along the back. Unfed males and females are uniformly dark brown with no distinctive markings or color patterns. The ticks become dark grey and bulbous after they have fed.

A home can become heavily infested when dogs transport ticks inside. Brown dog ticks seldom bite humans, but can be a serious problem inside homes. Females can lay as many as 5,000 eggs behind walls or under furniture or carpeting. Larvae, nymphs, and adults feed exclusively on dogs, which is why this tick is likely to become established in homes. Brown dog ticks can survive for more than six months in an unengorged state hidden in cracks and crevices.

TICKS AND DISEASE

Ticks can transmit several serious diseases to humans, pets, and farm animals. The two tick-borne diseases that are most often reported in this area are Lyme disease and Rocky Mountain spotted fever.

Lyme Disease is a potentially serious bacterial infection, transmitted through the bite of an infected tick. The disease is named for the town of Lyme, Connecticut, where it was first reported in 1975. The bacterium, called *Borrelia burgdorferi*, is transmitted principally by a tick called *Ixodes scapularis* (= *I. dammini*). The disease affects humans and a wide range of animals including pets and livestock.

Lyme disease manifests itself in many ways and if left untreated may progress through several stages. The disease is difficult to diagnose clinically because early symptoms mimic the flu (e.g., fatigue, headache, fever, or swollen glands, pain or stiffness in the neck, muscles, or joints). The most definitive early sign is a gradually expanding circular or oval-shaped red rash (*erythema migrans*) at the site of the bite. The rash

usually appears between three and 30 days after the tick bite, but develops in only about 60-70 percent of infected individuals. Also, the rash frequently disappears within a few weeks and may be overlooked.

Persons who experience any of the above-mentioned symptoms after being bitten by a tick — or after spending time in an area where ticks are abundant — should consult a physician immediately. In the earliest stages, Lyme disease can be successfully treated with antibiotics. As the disease progresses, therapy becomes more difficult. Left untreated, Lyme disease may result in chronic arthritis, heart disease, and neurological disorders.

Lyme disease is most common in the Northeast, upper Midwest, and Pacific Coast states. Lyme disease is such a new disease in Kentucky that the mechanism of transmission is not yet known. Neither the American dog tick nor the lone star tick (the two most common ticks in the state) appear to be vectors of the disease. And, to date, none of the known vectors of the disease (e.g., *Ixodes scapularis*) have been found here. Until more is known about how Lyme disease in Kentucky is transmitted, people should be aware of the early symptoms and should see a physician if they suspect they may have been bitten by a tick.¹

Rocky Mountain Spotted Fever has not received the media attention of Lyme disease, but it is potentially more serious. Each year about 10 to 30 cases are reported statewide. The primary vector of RMSF is the American dog tick, although lone star ticks can also transmit the disease pathogen, a bacterium-like microorganism, *Rickettsia rickettsii*.

Symptoms of RMSF begin two to 12 days after tick attachment and include headache, chills, muscle aches, and a very high fever (104-106°F). The most characteristic sign of RMSF is a rash that appears on about the second to fifth day on wrists and ankles, later spreading to other parts of the body. When promptly diagnosed, RMSF can be successfully treated with antibiotics. In the absence of treatment, victims may die.

In the case of RMSF and Lyme disease, infected ticks must be attached for at least 12 to 24 hours for pathogens to be transmitted. A person cannot become infected simply by having a tick crawl over the skin or clothing. Daily body checks for attached ticks greatly reduce one's chances of becoming infected.

REMOVING ATTACHED TICKS

Attached ticks should be removed promptly to reduce the chance of infection and disease transmission. The mouthparts of a tick are shaped like tiny barbs. Therefore, the best way to remove a tick is to grasp it with tweezers as close to the skin as possible and pull it straight out with gentle, even pressure (Fig. 2-5). Don't jerk or twist the tick because the head and mouthparts may remain embedded, increasing the chance of infection. If tweezers are unavailable, grasp the tick with a piece of tissue, trying not to squeeze or crush the tick's body as this may force disease organisms into the wound. Petroleum jelly, hot matches, and other "folk" methods of removal should be avoided.

¹In certain areas of the state there is confusion regarding the term "deer tick". "Deer tick" is a term often used when referring to *Ixodes scapularis*, the principal vector of Lyme disease in the northeastern U.S. The same term is used when referring to nymphal lone star ticks which are commonly found in western and southern parts of Kentucky. The lone star tick is not considered to be a vector of Lyme disease, although it can transmit Rocky Mountain spotted fever.



Fig. 2-5—To remove an embedded tick, grasp it close to the skin, and pull slowly and straight out.

Once the tick is removed, wash the affected area and your hands with soap and water, apply antiseptic, and cover with an adhesive bandage. Itching can be relieved by applying topical ointments such as those containing hydrocortisone. Keep the tick. Place it in a container with alcohol for at least three weeks. Should any disease-related symptoms appear, the identity of the tick may help the physician with diagnosis. The Entomology Department at the University of Kentucky will identify ticks at no charge. Specimens should be accompanied by the date and county from which the tick was collected.

AVOIDING TICK BITES

The best way to avoid tick bites is to follow these precautions:

1. *Avoid walking through uncut fields, brush, and other overgrown areas, especially from April through July. Walk in the center of mowed trails to avoid brushing up against vegetation.*
2. *When hiking or camping in tick-infested areas, wear light-colored clothing and long pants tucked into boots or socks. Ticks will be easier to spot, and it will be more difficult for them to attach to your skin.*
3. *Consider applying insect (tick) repellent to shoes, cuffs, socks, and pant legs. Products containing diethyl toluamide (DEET) or permethrin are most effective, but be sure to read and follow directions for use on the container.*
4. *Regularly inspect family and pets carefully after they have been in tick-infested areas. Promptly remove any ticks. Showering or bathing effectively removes ticks that have not yet attached.*

CONTROLLING TICKS ON PETS

Free-roaming pets are much more likely to become infested than are pets that are confined. Fencing in yards prevents pets from picking up ticks from surrounding areas. Fencing also discourages dogs and other large animals from introducing ticks onto the property. Ticks on pets can be controlled using sprays, dips, dusts, and insecticide-impregnated collars. A variety of brand names are available containing active ingredients such as permethrin, chlorpyrifos, propoxur, carbaryl,

and pyrethrins. Pet owners should be advised to consult with their veterinarian for appropriate products to use on their pet.

Pet pens and runs also can be sprayed to control ticks that may be present in those areas. Products labeled for tick control outdoors are usually labeled for use in these areas as well. Do not contaminate food or water.

CONTROLLING TICKS OUTDOORS

Ticks are sometimes a problem in yards, especially when pets are kept outdoors. Ticks also can be a serious problem in parks, camps, picnic sites, and other recreational areas. A good way to determine if ticks are present is to drag a 3-ft x 3-ft white flannel cloth through suspected areas. Ticks will attach and be visible against the white background.

Tick populations can be reduced in these areas by mowing and trimming lawns and other vegetation, thus creating a less favorable habitat for ticks and their wild hosts. Wood, brush piles, and other accumulated debris should also be removed.

Insecticide sprays are most effective when directed into areas where ticks and their animal hosts are likely to frequent. Pay particular attention to borders and fences between wooded or brushy areas and the lawn, around ornamental plantings, beside foot paths, and the dog house. Products containing carbaryl (Sevin), chlorpyrifos (Dursban), and diazinon are effective, as are permethrin, cyfluthrin (Tempo), and other synthetic pyrethroid insecticides. A single application during late April or May is often all that is required, although treatment may need to be repeated in June.

The ground and vegetation up to a height of about three feet should be thoroughly wetted with the insecticide. The insecticide should be applied according to label instructions. Children and pets should be kept off treated areas until the vegetation is completely dry. Treating the entire lawn is of little benefit since ticks avoid direct sunlight and normally will not infest areas that are well maintained.

CONTROLLING TICKS INDOORS

Tick control indoors is seldom required in Kentucky. This is because the American dog tick and lone star tick are rarely found indoors except on the pet. Indoor treatment is necessary only for the brown dog tick, which is relatively rare in Kentucky. Controlling this tick is difficult because of its many possible hiding places inside the home. After feeding, brown dog ticks drop off the dog and conceal themselves in cracks and crevices, where they can survive without another blood meal for several months.

Management of the brown dog tick in homes requires frequent inspection and removal of ticks from pets. Pet bedding should be laundered, and rugs, floors, and furniture should be routinely vacuumed, especially along baseboards and under and behind furniture.

Insecticides are almost always required to kill ticks hidden in protected areas. Treatment should focus on cracks and crevices along baseboards and molding, around door and window frames, underneath furniture, beneath the edges of carpeting, behind loose wallpaper, and in similar areas where ticks might conceal themselves. Pay particular attention to

areas where the dog spends time. Ticks tend to crawl up walls and other vertical surfaces, so it will be necessary to treat cracks and crevices up high as well as low.

Effective active ingredients for indoor application include carbaryl, chlorpyrifos, bendiocarb, and permethrin. Homeowners should be reminded to follow label directions and always keep children and pets off treated surfaces until the spray has dried. Because the eggs and immatures may take several weeks to hatch or molt, retreatment may be necessary to eliminate all ticks emerging from hidden areas.

Lice

Lice are parasites of warm-blooded animals, including man. The three species of lice that parasitize humans are the head louse, body louse, and pubic louse (Fig. 2-6). All three suck blood and cause considerable itching when they feed or crawl on the body. The body louse is also important in the transmission of human diseases, most notably epidemic typhus. Millions of people throughout time have died from louse borne typhus, although in the United States, the disease has not been present for many years. *Pediculosis* is a skin condition resulting from continuous and severe infestation of lice. Scarred, hardened, and pigmented skin results from continuous scratching of louse bites. All three kinds of human lice can cause pediculosis.

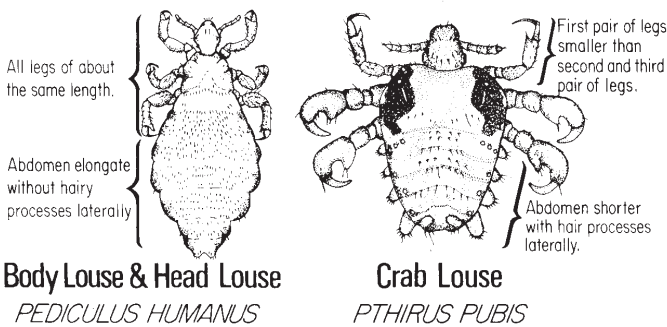

Fig. 2-6—Lice commonly found on humans

Lice associated with humans spend virtually their entire life on the host. Head lice are the type of louse most often encountered and almost always occur on the head. Head lice are small (1/12 inch or about the size of a sesame seed), and white or grayish. They move quickly and avoid light, sometimes making them difficult to see. Diagnosis is more often made by the presence of the **nits** (eggs). Nits are tiny, yellowish white oval eggs attached directly to the hairs of the scalp. They are often mistaken for dandruff or residues of shampoo, but will not wash off or blow away (Fig. 2-7). Body lice resemble head lice, but prefer to live in clothing except when they crawl onto the body to feed. Outbreaks of body lice are usually associated with large numbers of people living in close quarters under poor sanitation. Transfer of body lice can occur from shared bedding or clothing. Pubic (crab) lice usually infest the pubic area, but also may be found on other hairy areas of the body. Transfer of crab lice between individuals usually requires intimate personal contact because the lice cannot survive longer than 24 hours off the host.

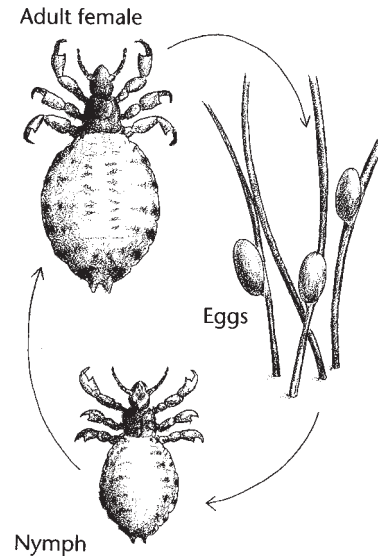

Fig. 2-7—Life stages of the head louse. Actual size of adults is 1/16 - 1/18-inch. Eggs are attached to hair shaft, whereas dandruff can be flicked off.

MANAGEMENT AND PREVENTION

The public health professional should be able to detect the presence of lice, and recommend steps for deinfestation and prevention. This is particularly important in the case of head lice, which infest an estimated ten percent of elementary school children each year. Specific recommendations for dealing with head lice are discussed below. (Most of the recommendations are also relevant to the management of body and crab lice).

As mentioned, head lice usually infest only the head, preferring the nape of the neck and the area behind the ears. Head lice are especially common on schoolchildren between the ages of three and ten. Schools bring large numbers of children together in close personal contact. Hats and coats are often shared or hung together in the same closet, permitting transfer of lice from one child to another. Transfer of head lice can also occur by using infested combs and brushes, or resting one's head on upholstered furniture or pillows recently used by an infested person.

The first indication of head lice is itching and scratching caused by the bloodsucking habits of the louse. Examination of the hair and scalp will usually reveal the crawling forms (nymphs and adults) and yellowish white eggs (nits) attached to the hair shafts close to the scalp. Usually all lifestages can be seen with the naked eye, although a flashlight and hand lens are helpful. Red bite marks or scratch marks are often seen on the scalp or neck.

There are four (4) key steps to eliminating head lice and preventing their return:

1. The child or infected person(s) should be treated with a medicated shampoo formulated specifically to control lice. Several different products, most containing pyrethrins, are available through pharmacists and physicians. Follow the directions on the package. Some products require retreatment in 7-10 days. If one family member is found to be infested, all others should be examined. Only those showing evidence of lice should be treated. All infested family members should be

treated at the same time to prevent reinfestation from one person to another.

2. Remove all nits using a fine-tooth louse comb. Louse control shampoos often do not kill all the nits, and surviving eggs will hatch within 7-10 days, continuing the cycle of reinfestation. Dead nits also tend to remain attached to the hair, causing uncertainty about reinfestation. Nits are most easily removed by combing while the hair is slightly damp. They can also be picked out with fingernails, or cut out with a small safety scissors.

3. All personal articles that have been in contact with the infected individual should be deloused. Normal laundering with hot, soapy water (125 degrees F for 10 minutes) or dry cleaning will kill lice and nits on clothing, bed linens, and towels. Combs and brushes should be soaked for 10 minutes in a pan of very hot water. (Note: steps 1-3 should be performed at the same time to avoid reinfestation after shampooing).

4. To reduce the chance of reinfestation, children should be instructed not to share hats, clothing, or brushes with their classmates. Each child should have a separate storage space for hats and other clothing at home and school to prevent contact with other garments. If this is not possible, coats should be hung on hooks so they do not touch, or on the backs of students' chairs.

Elimination of a head lice outbreak in a school, nursing home, or similar shared facility requires prompt, coordinated action and administrative support to prevent the spread of lice to uninfected individuals. Unless **all** affected persons are treated, the condition will continue.

Treatment of the premises or clothing with insecticides is generally not required or recommended for the control and prevention of head, body, or crab lice. This is because the lice cannot survive for any length of time off of their human host.

Mites

Mites (Fig. 2-8) are very small arthropods that are closely related to ticks. Mite larvae have six legs whereas the nymphal and adult stages have eight. Most species of mites are pests of agricultural crops. However, certain types of mites are parasitic on humans.

Chiggers

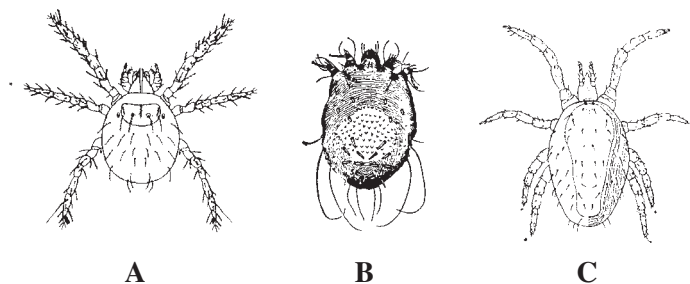

Fig. 2-8—Mites parasitic on humans: (a) chigger; (b) scabies mite, and (c) bird mite.

Chiggers are the larvae of a family of mites that are sometimes called red bugs. The adults are large red mites often seen running over pavement and lawns. Chiggers are extremely small (0.5 mm) and are difficult to see without magnification. The six-legged larvae are hairy and yellow-orange or light red. They are usually encountered outdoors in low, damp places where vegetation is rank and grass and weeds are overgrown. Some species also infest drier areas, however, making it difficult to predict where an infestation will occur.

Chiggers overwinter as adults in the soil, becoming active in the spring. Eggs are laid on the soil. After hatching, the larvae crawl about until they locate and attach to a suitable host. The larvae do not burrow into the skin, but inject a salivary fluid which produces a hardened, raised area around them. Body fluids from the host are withdrawn through a feeding tube. Larvae feed for about 4 days and then drop off and molt to nonparasitic nymphs and adults. Chiggers feed on a variety of wild and domestic animals, as well as humans. The life cycle (from egg to egg) is completed in about 50 days.

Most people react to chigger bites by developing reddish welts within 24 hours. Intense itching accompanies the welts, which may persist for a week or longer if not treated. Bites commonly occur around the ankles, waistline, armpits, or other areas where clothing fits tightly against the skin. Besides causing intense itching, chigger bites that are scratched may result in infection and sometimes fever. Chiggers in North America are not known to transmit disease.

Persons walking in chigger-infested areas can be protected by treating clothing (cuffs, socks, waistline, sleeves) or exposed skin with tick repellents. Some repellents should only be used on clothing; and it is important to follow label directions. People who suspect they may have been attacked by chiggers should take a soapy bath immediately and apply antiseptic to any welts. A local anesthetic will provide temporary relief from itching. Regular mowing and removal of weeds and brush make areas less suitable for chiggers and their wild hosts. Mowing also enhances penetration and performance of miticides, should they be required. Chigger populations can be further reduced by treating infested areas with residual miticides. Applications should be thorough but restricted to areas frequented and suspected of being infested.

Human Scabies

The sarcoptic itch mites, *Sarcoptes scabiei*, infest the skin of a variety of animals including humans. The types of *Sarcoptes* inhabiting the skin of mammals are considered forms of *Sarcoptes scabiei* and can exchange hosts to some degree. (For example, Canine scabies can be temporarily transferred from dogs to humans, causing itching and lesions on the waist, chest, and forearms.)

Human scabies mites are very small and are rarely seen. They commonly attack the thin skin between the fingers, the bend of the elbow and knee, the penis, breasts, and the shoulder blades. The mites burrow into the skin, making tunnels up to 3 mm (0.1 inch) long. When they first burrow into the skin, the mites cause little irritation, but after about a month, sensitization begins. A rash appears in the area of the burrows

and intense itching is experienced.

Scabies mites are transmitted by intimate personal contact, usually from sleeping in the same bed. The adult fertilized female mite is usually the infective life stage. She adheres to the skin using suckers on her legs and burrows into the skin where she lays her oval eggs. In 3 to 5 days these eggs hatch into larvae and move freely over the skin. Soon they transform into nymphs and reach maturity 10 to 14 days after hatching.

A scabies infestation should be handled as a medical problem and is readily diagnosed and treated by most physicians. The first step to control a scabies infestation usually involves softening the skin with soap and water to make sure the pesticide treatments can penetrate well. An evening bath followed by overnight treatment works best. A total body (neck-down) application of topical pesticide medication should remain for 8-12 hours before showering in the morning. Commonly used products include lindane (Kwell®), permethrin (Elimite®), and crotamiton (Eurax®).

Because the symptoms of scabies mite infestations are delayed by about a month, other members of the household besides those showing symptoms may be harboring the mites. It is important that everyone in the infected family or living group go through the treatment regime. A second treatment may be necessary to eliminate an infestation of scabies mites, but patients should avoid overzealous pesticide treatment because itching may persist for a week or more after treatment and does not necessarily indicate treatment failure.

Scabies mites cannot live off of a human host for more than 24 hours. Therefore, insecticide treatment of premises is not warranted. It is recommended, however, that coincident with treatment, the clothing and bedding from infested individuals be washed in hot water or dry cleaned.

Bird and Rodent Mites

Parasitic mites that occasionally infest buildings are usually associated with wild or domestic birds or rodents. Bird and rodent mites normally live on the host or in their nests, but migrate to other areas of the structure when the animal dies or abandons the nest. Rodent mites often become a nuisance after an infestation of mice or rats has been eliminated. People usually become aware of the problem when they are attacked by mites searching for an alternate food source. Their bites cause moderate to intense itching and irritation. Rodent and bird mites are very tiny, but usually can be seen with the naked eye. They are about the size of the period at the end of this sentence.

The first step in controlling bird or rodent mites is to eliminate the host animals and remove their nesting sites. Often, the nests will be found in the attic, around the eaves and rafters, or in the gutters or chimney. Gloves should be used when handling dead animals. A respirator should also be worn when removing nest materials to avoid inhaling fungal spores and other potential disease-producing organisms associated with the droppings.

After nests are removed, the areas adjacent to the nest should be sprayed or dusted with a residual insecticide such as those products labeled for flea control. Space or ULV treatments with non-residual materials (e.g., synergized pyrethrins)

can be used in conjunction with residual sprays. Space treatments are especially useful when the mite infestation has dispersed widely from the nesting site. In this case, more extensive treatment with residual and non-residual insecticides may also be necessary in other areas of the structure where mites are observed. A vacuum cleaner or cloth moistened with alcohol can be used to eliminate mites crawling on open surfaces.

Bed Bugs

There are several species of bed bugs, all of which are parasites of warm-blooded animals. The **common bed bug**, whose preferred host is humans, is rarely encountered, presumably because of improvements in sanitation. Related species, such as the **bat bug** and **bird bug**, prefer to feed on bats, birds, and other wild hosts, but will also feed on humans if the opportunity arises or the preferred host dies or leaves the roost. Adult bed bugs are about 1/4-inch long and reddish brown, with oval, flattened bodies (Fig. 2-9). Bed bugs prefer to hide in cracks and crevices during the daytime and come out to feed on the host's blood at night, usually while the host is sleeping. Infestations are usually detected by the welts and irritation caused by the bites, and the fecal smears and blood spots visible on pillowcases, sheets and mattresses. Heavy infestations of bed bugs are also accompanied by a distinct odor.

The key to controlling bed, bird, and bat bugs is to locate

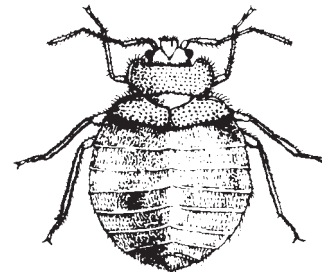

Fig. 2-9—Bed bug

and treat all cracks and crevices where the bugs may be hiding. Typical hiding places are in the tufts, folds and seams of mattresses, and cracks in the box spring and bed frame. Heavier infestations often spread to behind baseboards, window and door casings, behind pictures, electrical switch plates, and loose wallpaper, in the pleats of drapes, and the upholstery of furniture. When inspecting for bed bugs, look for the insects themselves as well as the telltale fecal and blood spots indicating that a hiding place is nearby. Residual insecticides (sprays or dusts) used to control cockroaches and ants are usually effective, but always consult the label for specific instructions.

Following thorough inspection/treatment of living areas, efforts should be made to locate and eliminate potential wild animal sources of infestation. These may include birds, bats, or squirrels in the attic, or possibly mice or rats. If bat bugs or bird bugs are found in these areas, residual and non-residual insecticides should be applied, and the wild hosts excluded.

Mosquitoes

Mosquitoes have done more harm to human health and well-being than any other insect group. They are the only natural carriers of such debilitating diseases as malaria, yellow fever, dengue, and several types of viral encephalitis. Mosquitoes can also transmit filarial diseases (caused by parasitic worms) to humans and animals. The viral encephalitides and dog heartworm are the only diseases that are a threat in Kentucky. The mosquito's annoying biting habits often make it a nuisance around the home, and in parks and other recreational areas. Fortunately, most mosquito species feed on animals other than humans. However, some of these species can be pests of pets and farm animals.

Kentucky has over 50 mosquito species. Only the female mosquito bites; males feed strictly on nectar and other plant juices. Female mosquitoes need an additional source of protein (in the form of a blood meal) before they can develop eggs. Females also feed on nectar and plant juices, using this food source for flight and metabolism.

Biology and Habits

Mosquito development consists of four stages: egg, larva, pupa, and adult (Fig. 3-1). All life stages except the adult are aquatic. Mosquitoes are generally small (less than 1/2-in) and fragile. Their most obvious characteristics include one pair of wings with scales on the wing veins and hind margin, and an elongated beak with piercing mouthparts (Fig. 3-2). Mosqui-

toes are often confused with midges, punkies, biting gnats, and other flies.

Eggs—Mosquito eggs, elongate and about 1/40-inch long, turn dark brown or black when ready to hatch. Eggs are laid

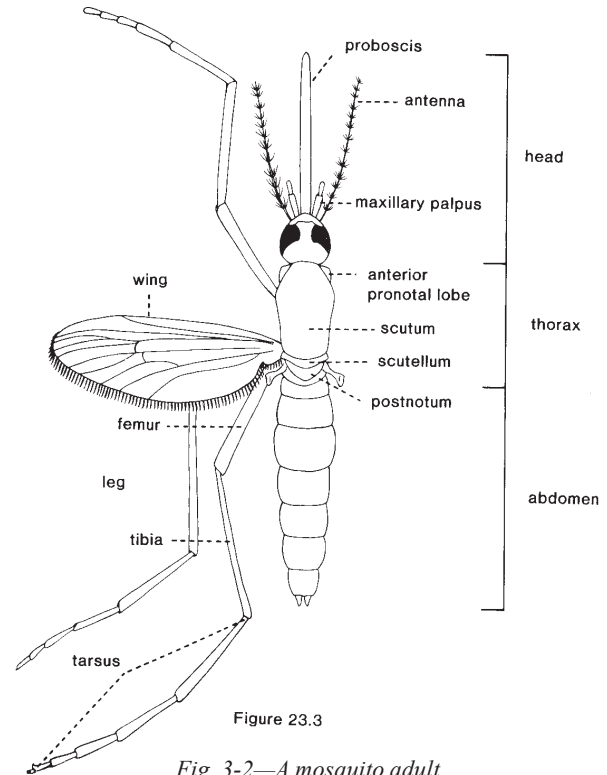

Figure 23.3
Fig. 3-2—A mosquito adult

	ANOPHELINES		CULICINES	
	ANOPHELES	AEDES	CULEX	
EGGS				
LARVA				
PUPA				
HEAD				
RESTING POSITION				

Fig. 3-1—Anopheles, Aedes, and Culex mosquitoes at various stages of development

singly or in batches of 50-400. *Anopheles* and *Aedes* deposit eggs singly, *Culiseta* and *Culex spp.* deposit them in rafts. Oviposition by most groups is on the surface or along the margins of quiet pools of water. However, flood water and salt marsh mosquitoes, as well as many tree-hole breeders, (e.g., *Aedes* and *Psorophora*) oviposit above the waterline in sites subject to flooding by tidal water, overflow, or rainwater. Each mosquito species lays its eggs in a specific type of site.

Eggs laid by floodwater mosquitoes do not all hatch at the same time. Most hatch after the first flooding, the remainder will emerge only after the second or subsequent floodings. Eggs of some common *Aedes* species will hatch only after 4 years of intermittent flooding.

Larvae—Mosquito larvae are commonly known as “wigglers,” because of their swimming habits. They differ from other aquatic insects by an absence of legs and by their bulbous thorax, which is wider than the head or abdomen. In contrast to other fly larvae, most larval mosquitoes have a complete head capsule and a prominent breathing tube located on the eighth abdominal segment (Fig. 3-3). This stage lasts about 7 days, depending on temperature.

Mosquito larvae can breed in virtually any naturally occurring collection of water. Great swarms may be produced from either fresh or brackish water, polluted or clear. Breeding sources may include water in tin cans, vehicle tires, hoof prints, tree holes, leaf cups, or the margins of rivers, streams, lakes, or impoundments. Mosquitoes cannot breed, however, in large bodies of water with clean edges because the larvae are

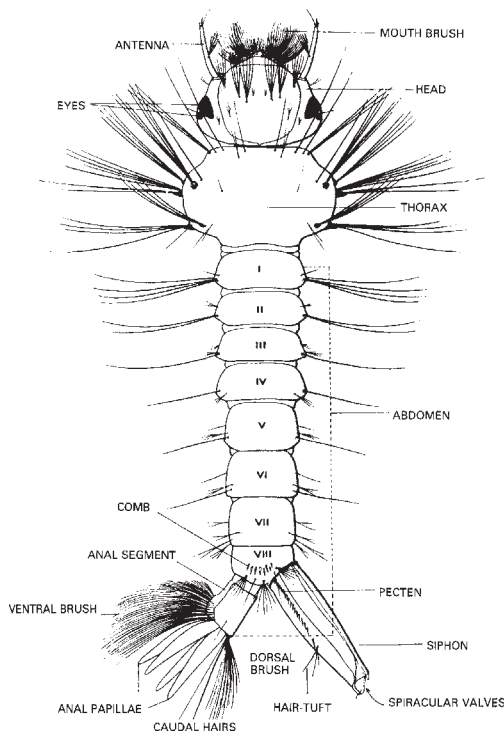

Fig. 3-3—Dorsal view of a *Culex* mosquito larva

unable to withstand wave action.

Most wigglers hang suspended diagonally from the water surface by means of the breathing tube. *Anopheles* larvae do not have a tube, however, and lie horizontally just beneath the surface of the water by means of float hairs (Fig. 3-4). Mosquito larvae are quite mobile and will quickly dive to the bottom if disturbed. They will return to the surface shortly.

Most mosquito larvae feed by filtering out microorganisms and other particulates in the water, or by “browsing”

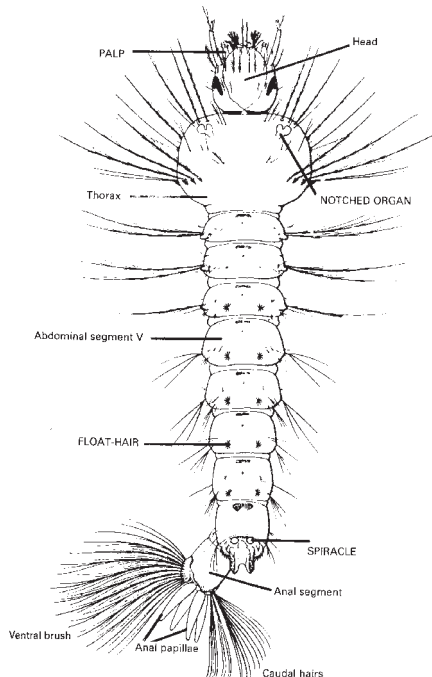

Fig. 3-4—Dorsal view of an *Anopheles* mosquito larva

microorganisms growing on solid surfaces. Some mosquitoes, including *Toxorhynchites* and *Psorophora* species, are considered beneficial insects because the larval stage actively preys upon other mosquito larvae.

Pupae—Mosquito larvae molt 4 times. The last results in a non-feeding pupa or “tumbler.” The pupal stage is quite short, usually 2-3 days. The pupa is shaped like a comma (Fig. 3-5). The “dot” part of the comma is called the cephalothorax and the “tail” of the comma is the abdomen. A pair of breathing “trumpets” are situated on top of the cephalothorax and paddle-like flaps on the end of the abdomen. The pupa is remarkably active and sensitive to disturbances. When alerted, it quickly darts in a tumbling action to deeper water and, after a few moments, rises with little motion back to the surface. Pupae are aquatic, but they can survive quite well on a moist substrate such as wet mud in a drying puddle.

Adult—The adult mosquito emerges from the pupal case onto the surface of the water. Careful movements by the emerg-

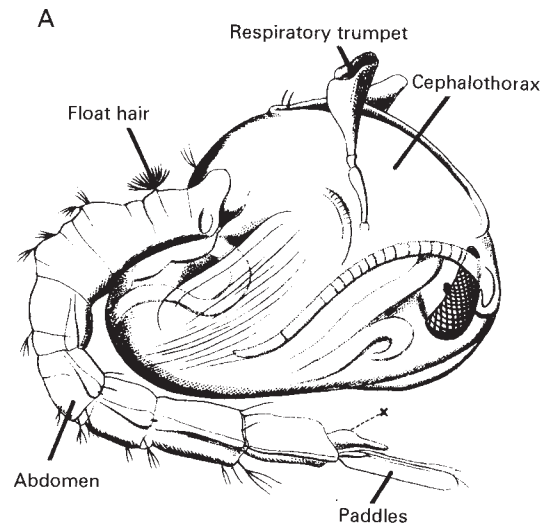

Fig. 3-5—A mosquito pupa

ing adult are required to ensure that it does not fall sideways and become trapped in the surface film.

Male mosquitoes usually live no longer than 1 to 2 weeks. Females with ample food may live for several months although, during the summer, female survival may average closer to two weeks. Some mosquito species have only one generation each year. Other species may have four or more generations per year, with populations building up to large numbers by late summer.

Some species can fly no more than a few city blocks, whereas others can travel up to twenty miles. Most mosquitoes are active only at night, although some varieties bite during the daytime. When they are not active, adult mosquitoes tend to seek protection in quiet areas with high humidity. Resting sites for adult mosquitoes include shrubs, wooded areas, and similar dense vegetation, drainage ditches, sewers, or under the eaves of buildings.

Mosquito Species Common in Kentucky

Only trained specialists can differentiate between mosquito species. Knowing which species is involved is crucial to planning appropriate control measures. The following are some of the most troublesome species found in Kentucky.

Aedes albopictus, the Asian tiger mosquito, was first discovered in 1985 in the Houston, Texas, area in used tires imported from Japan. It has spread rapidly throughout the eastern U.S. where it is now reported in 25 states. The Asian tiger mosquito has the potential to become established throughout much of the U.S. because it can survive winter temperatures. As of 1994, 46 counties in Kentucky were infested with the mosquito, causing concern among state health officials. It is an aggressive daytime biter and has the potential to transmit numerous diseases including dengue, yellow fever, La Crosse encephalitis, eastern equine encephalitis, and dog heartworm. La Crosse encephalitis, eastern equine encephalitis, and dog heartworm are of particular concern to Kentuckians because the pathogenic agents responsible for these diseases are known to occur here.

The Asian tiger mosquito is of average size, black and white, with banded white legs and a distinctive single white band down the length of the back of the thorax. One of the major breeding sites for the mosquito is artificial containers, principally vehicle tires. The movement and improper storage of used tires is the primary means of dispersal in this country.

Aedes canadensis is a dark mosquito with the ends of the legs banded with white. It is a serious pest in woodlands. This species overwinters in the egg stage and is one of the first mosquitoes to appear in early spring. Larvae breed in woodland pools filled by melting snow or spring rains. It prefers pools with bottoms containing dead and decaying leaves, although it is sometimes found in roadside puddles, sink holes, wooded swamps, etc. Eggs are laid singly on the ground above the waterline in woodland pools. Eggs are able to survive long periods of drying. Biting occurs most frequently during the evening hours, but can occur during the day or night. This mosquito is a secondary vector of La Crosse encephalitis.

Aedes triseriatus, the eastern tree hole mosquito, is black with silvery-white scales at the sides of the thorax. There are no bands on the legs. This mosquito breeds in tree holes, tires, and other artificial containers. The bites are painful and can be annoying. This mosquito does not fly far from its breeding place and is the principal vector of La Crosse encephalitis in Kentucky. It has several generations per year and overwinters in the egg stage.

Aedes vexans, the inland floodwater mosquito, is a medium-sized brown mosquito with narrow rings of white scales on the hind tarsi and a "V"-shaped notch at the middle of each band of white scales on the upper surface of the abdomen. Common breeding sites are rain pools, floodwaters, roadside puddles, and just about all temporary bodies of freshwater. The eggs are laid on the ground above the waterline and hatch when flooding occurs. Adults can fly long distances from their breeding sites with flights of ten miles being common. Adults are vicious biters and are especially annoying at dusk and after dark. They rest during the day in grass and other vegetation. This mosquito overwinters in the egg stage. It is a secondary vector of eastern equine encephalitis.

Anopheles quadrimaculatus. These large, dark-brown mosquitoes have four dark spots near the center of each wing; the legs are entirely dark. Eggs are laid singly on the water surface with lateral floats to keep them suspended. One hundred or more eggs are laid at a time. This species is the most important vector of malaria in the eastern U.S. and can be found frequently in houses. Their bites are less painful than many other mosquitoes and often go unnoticed. Breeding sites are chiefly in permanent, freshwater pools, ponds, and swamps that contain aquatic vegetation or floating debris. City park ponds, sluggish streams, and shallow margins of reservoirs and lakes can contain many larvae. During the day adults rest in cool, damp, dark shelters such as buildings, caves, and under bridges. These mosquitoes feed at night and will readily enter houses to feed on humans. Cows, horses, mules, pigs, and chickens are also attacked. Adults usually remain within one-half mile of their breeding site. Breeding occurs throughout the summer months. Adult fertilized females are the overwintering stage.

Culex pipiens, the common house mosquito, is brown, of medium size and has cross bands of white scales on the abdominal segments, but is without prominent markings. It is a vector of St. Louis encephalitis and dog heartworm. Breeding occurs in rain barrels, tin cans, tires, storm-sewer catch basins, street gutters, polluted ground pools, cesspools, open septic tanks, etc. Eggs are laid on the water surface as rafts in clusters of 100-400. The flight range is restricted unless great numbers are produced. Adults are active only at night and can be found resting during the day in and around houses, out-buildings, and various shelters near their breeding places. They commonly enter houses. This mosquito overwinters as an adult.

Mosquitoes and Disease

Mosquitoes are not naturally infected with disease agents; they must first acquire these pathogens from a "sick" individual or host before they can be passed to a "healthy" one. For example, just because a person was bitten by *Anopheles quadrimaculatus* (the mosquito capable of transmitting malaria in Kentucky) doesn't mean that he or she will contract malaria. For that to happen, the mosquito would first have had to have bitten an individual suffering from malaria -- a highly unlikely event in Kentucky.

The following mosquito-borne diseases are of some concern in Kentucky.

St. Louis Encephalitis (SLE) is one of the most common arthropod-borne viruses (arboviruses) in the U.S. In nature, it is maintained and transmitted among birds, primarily by *Culex* mosquitoes. Humans can become ill when bitten by an infected mosquito. Infected individuals may experience abrupt onset of fever, nausea, vomiting, and severe headaches. These symptoms usually develop within 5 to 7 days after someone is bitten. People of any age may contract the disease; however, disease incidence is greater and symptoms more severe in people 60 years or older. Mortality rates range from 2 to 20 percent, with the highest mortality occurring in the oldest age groups.

Humans become infected with SLE only as a result of being bitten by a mosquito that had formerly contracted the pathogen from biting an infected bird. There is no person-to-

person transmission via mosquitoes, because the virus concentration (titer) in human blood never reaches a sufficient level to render a biting mosquito infective. Thus, humans are considered to be an “accidental” or “dead end” host for this disease. Disease outbreaks are most likely to occur from mid-summer through early fall when *Culex* populations are at their peak.

Eastern Equine Encephalitis (EEE) is an infection maintained in nature by a bird-mosquito-bird cycle similar to SLE. Horses are involved as dead end hosts in the cycle, as are humans. This virus can infect persons of any age, but young children and infants are most susceptible. Mortality in humans may exceed 50% and can be significantly higher in horses. Children and infants who survive the infection are frequently afflicted with varying degrees of mental retardation and paralysis. A number of mosquitoes, including *Culiseta melanura* and several *Aedes* species, are capable of transmitting this disease.

La Crosse Encephalitis (LAC)—The natural cycle of LAC differs from the other encephalitides in that the natural hosts are small animals such as rabbits, hares, and squirrels, rather than birds. The primary vector is the eastern tree hole mosquito, *Aedes triseriatus*. Humans are susceptible to this disease but mortality is usually low.

Dog Heartworm is caused by the filarial worm *Dirofilaria immitis*. It is a serious disease for all breeds of dogs in Kentucky. Several mosquito species can transmit this parasite, including *Culex pipiens* and several *Aedes* species. Mosquitoes ingest the immature worms, called microfilariae, while taking blood from infected dogs. After several days, the fully developed heartworm larvae are transmitted via the mosquito’s mouthparts to a healthy dog when the mosquito feeds again. The larvae grow and eventually migrate to the right ventricle of the dog’s heart where they mature and reproduce. The adult female worm can grow to approximately 11 inches and the male 6 inches. Large numbers of adult worms can develop in the host dog, usually killing the infected animal.

Mosquitoes and AIDS

News releases concerning the possibility of mosquitoes biologically or mechanically transmitting AIDS (Acquired Immune Deficiency Syndrome) were common when the disease was first recognized, and the subject is still addressed by tabloids that seek headlines to increase their circulation. The National Centers for Disease Control (CDC) has conducted several scientific studies on this topic and all of these clearly show that **mosquitoes cannot transmit AIDS**. There are several reasons for this:

Human immuno-deficiency virus (HIV) is ingested by mosquitoes along with the blood meal. However, mosquitoes ingesting HIV-infected blood digest the entire blood meal within 1-2 days, **completely destroying any virus particles** that could potentially produce infection.

What about the possibility of mosquitoes “mechanically” transmitting HIV on the outside of the mouthparts? In order for insect-borne viruses to be passed from one individual to the next (via contaminated blood on the mouthparts), the pathogen must be present at very high levels in the infected individual’s bloodstream. Infected humans rarely circulate more than 10 units of HIV virus particles in their blood. Calculations with mosquitoes and HIV show that a mosquito feeding on an HIV carrier circulating **1000 units** of HIV has a *one in 10 million chance of injecting a single unit of HIV to an AIDS-free recipient*. In other words, an AIDS-free individual would have to be bitten by about 10 million mosquitoes that had previously fed on an AIDS carrier to receive a single unit of HIV from contaminated mosquito mouthparts! Using the same calculations, crushing a fully engorged mosquito containing AIDS-infected blood would still not begin to approach the levels needed to initiate infection. In short, mechanical transmission of AIDS by HIV-contaminated mosquitoes appears to be well beyond the limits of probability.

What about contaminated blood *inside* a mosquito’s mouthparts? Many people think of mosquitoes as tiny, flying hypodermic syringes—and if hypodermic syringes can successfully transmit HIV from one individual to another, then mosquitoes should also. However, unlike a syringe, the mosquito delivers its salivary fluids through one passage (i.e., tube) and draws blood up another. As a result, the food canal is not flushed out like a used needle, and blood flow in mosquito feeding is always one-way. Thus, the mechanics involved in mosquito feeding are totally unlike the mechanisms employed by syringes (and far less likely to result in transmission of HIV).

What about contaminated blood *inside* a mosquito’s mouthparts? Many people think of mosquitoes as tiny, flying hypodermic syringes—and if hypodermic syringes can successfully transmit HIV from one individual to another, then mosquitoes should also. However, unlike a syringe, the mosquito delivers its salivary fluids through one passage (i.e., tube) and draws blood up another. As a result, the food canal is not flushed out like a used needle, and blood flow in mosquito feeding is always one-way. Thus, the mechanics involved in mosquito feeding are totally unlike the mechanisms employed by syringes (and far less likely to result in transmission of HIV).

Mosquito Surveillance

An effective mosquito management program cannot be planned or implemented until surveys are made to determine which species are present, their relative abundance, and the location of potential breeding sites. Moreover, understanding the biology of the species involved is essential so that control efforts are not only directed at the proper habitat, but at the right time. Surveys can be labor intensive but will allow personnel to focus control efforts on only those species that are causing a problem. This helps mosquito control personnel avoid unnecessary intrusion into areas which do not need to be treated, thus saving time and money.

Surveys for **eggs and oviposition sites** can often be a useful predictor of mosquito abundance. Mosquito egg surveys for floodwater mosquitoes are often used to schedule an effective pre-hatch application of insecticide. Oviposition traps constructed with a black-painted jar or open can, a wooden paddle serving as the oviposition site, and a little water in the trap, have proven valuable in sampling for *Aedes albopictus* and *Aedes triseriatus*. However, surveys for egg rafts of *Culex*, and single floating eggs of *Anopheles*, are too difficult to be useful.

While egg surveys are often useful, **larval surveys** are the primary means of deciding whether control measures should be applied to aquatic sites. A white dipper equipped with a long handle is the collecting tool most often used (Fig. 3-6). Brown larvae can be easily seen on a white utensil. Some “stealth” is required when dipping for mosquito larvae because the larvae quickly swim to deeper water when disturbed. The surveyor must also not overlook obscure larval sites, such as cattle hoofprints in wet pastures or on the edges of water holes and ponds. For examining tree holes, artificial containers, and similarly inaccessible cavities, a large-capacity rubber suction bulb and flexible extension tube can be used to draw out the water into a white metal pan.



Fig. 3-6—Mosquito monitoring equipment. The most important device is a white enamel dipper equipped with a long handle for sampling larvae and pupae.

An important survey method for collecting adult mosquitoes is the **light trap**. A variety of light traps have been designed for sampling mosquitoes, one example being the New Jersey light trap (Fig. 3-7). This trap contains an incandescent bulb, which serves as the attractant, and a fan to draw nearby mosquitoes into the killing chamber. A portable, battery-operated modification of the New Jersey light trap has also proven successful.

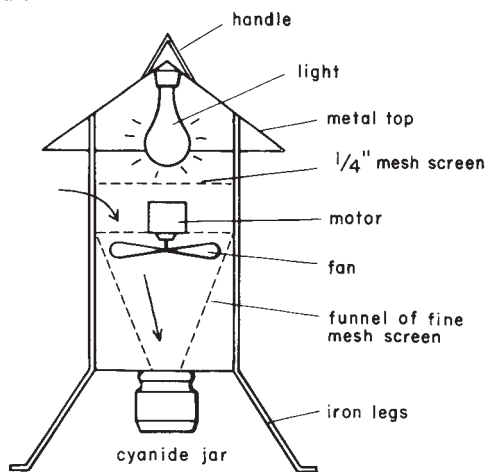

Fig. 3-7—Schematic diagram of a New Jersey light trap.

Carbon dioxide (a respiratory gas given off by animals) is a strong attractant to mosquitoes. For this reason, dry ice is often used in conjunction with light traps, resulting in significant increases in the number of mosquitoes caught.

Light traps are relatively inexpensive and are easy to set up. They are most useful in determining the presence or absence of a particular mosquito species, and in demonstrating population trends. However, light traps are ineffective for determining the absolute number of mosquitoes in an area. Light traps collect only those mosquitoes that are active at night *and are attracted* to lights. Therefore, light traps may not necessarily collect all the mosquito species present in the area.

Another disadvantage of light traps is that they are non-selective: they collect all mosquitoes attracted to them as well as flies, beetles, and other insects attracted to light. Many of the mosquitoes caught in a light trap may actually be feeding on reptiles or rodents and may be of little, if any, public health importance. Despite these limitations, light traps are an important surveillance tool.

Another technique used in adult mosquito surveillance is the **landing/biting count**. This method uses humans or animals as the attractant. The human or animal host is placed at a specific location and remains motionless. Mosquitoes are attracted to the host, and as they land to feed, they are collected with a battery-powered aspirator. This technique is very useful because only those species that bite that particular host will be collected. This technique requires that the host be bitten, and therefore is not recommended when there is a high risk of disease transmission.

Light traps, dippers, and other mosquito surveillance equipment can be purchased through BioQuip Products, 17803 LaSalle Ave., Gardena, CA 90248-3602 (Tel. 310-324-0620).

Control Techniques

Most successful mosquito management programs concentrate on control of the larvae. This stage of the insect's life cycle is concentrated in specific, identifiable areas. Larval mosquito control can be accomplished either by reducing breeding sites, employing biological control agents, or by applying chemical larvicides (insecticides) to breeding sites that cannot be eliminated.

Breeding Site Reduction

The most effective way to control mosquitoes is to find and eliminate their breeding sites. Eliminating large breeding areas such as swamps, or sluggishly moving streams or ditches may require community-wide effort. The initial investment is usually high, but significant savings can be realized over time. In these operations, expert advice must be available to prevent potential environmental problems. For example, filling a swampy area may block normal drainage patterns, creating new breeding sites or interfering with aquatic life.

In addition to reducing large mosquito breeding sites, individual property owners can take the following steps to prevent mosquito breeding on their own premises.

- Dispose of tin and soda cans, old tires, buckets, plastic sheeting, or other containers that can collect and hold water. Water should not be allowed to accumulate at the base of flower pots or in pet dishes for more than 5 days.
- Clean debris from rain gutters and remove standing water under or around structures, or on flat roofs.

- Drain childrens' wading pools when not in use (or at least change the water weekly).
- Change the water in bird baths at least once a week.
- Remove, drain, or fill tree holes and stumps with mortar.
- Eliminate seepage from cisterns, cesspools, and septic tanks.
- Eliminate standing water from around animal watering troughs.
- Irrigate lawns and gardens carefully to prevent water from standing for several days.
- Keep the grass mowed around ponds and other bodies of water, taking care to keep clippings out of the water.
- Maintain farm ponds according to good management practices. Excessive amounts of emergent aquatic vegetation will shelter mosquitoes. Stagnant ponds and waste lagoons also can produce very large numbers of mosquitoes.

Biological Control

Nematodes, planaria, microsporidia, and even other predaceous mosquitoes such as *Toxorhynchites*, show some promise against mosquito larvae. However, the most effective biological control agents to date are predaceous fish such as the mosquito fish, *Gambusia affinis*, and the common guppy, *Poecilia reticulata*. These fish are approximately 1 1/2 inches long and feed voraciously on mosquito larvae. They are commonly found in streams and creeks where they can be seined and transferred to sites harboring mosquito larvae. These fish can be so effective that many county mosquito abatement districts in the U.S. maintain their own fish breeding programs. One drawback to using this method is that some mosquito insecticides are lethal to the fish.

Chemical Control

The use of insecticides is, at best, a temporary measure that should be limited to only those situations for which no other alternatives exist. Chemical control can be divided into two general categories: (1) **Larviciding** is the most efficient and effective method and should be the basis of any chemical control program. (2) **Adulticiding** is less efficient and should be used only for supplemental or emergency purposes. The detection of active transmission of mosquito-borne disease is an example of such an emergency.

Larval Control (Larviciding)

Solving a mosquito problem by killing the larvae is the most logical approach because the mosquitoes are being controlled before they become a nuisance. The application of larvicides should only be made at sites where mosquito larvae of the target species are present. The degree of control obtained with larvicide applications depends upon the amount of pollution in the water, as well as the type and amount of vegetative cover present. Where vegetative cover is heavy, granular formulations frequently provide better control than emulsions or oil spays. Repeated insecticide treatments may be needed, especially after heavy rainfall. A listing of some mosquito larvicides is presented in Table 3-1.

Adult Control (Adulticiding)

Adult mosquito control programs are most successful if large areas are to be treated. In general, adulticiding provides only temporary relief by reducing populations to less annoying levels. However, this may be the most practical technique for local problems or in the event of a disease outbreak. In addition, some adult mosquito species can fly long distances, often making it necessary to supplement larval control measures with adult control. A listing of some mosquito adulticides is presented in Tables 3-2 and 3-3.

Table 3-1. Some suggested larvicides for mosquito breeding waters. (For specific application rates and safety precautions, follow label directions.)

Insecticide Common name	Trade Name/Formulation*
<i>Bacillus thuringiensis israeliensis (Bti)</i>	Vectobac AS, WP & G Bactimos WP, G, P & Briquets Teknar HP-D
methoprene	Altosid P & Briquets
temephos	Abate SG, EC & CG

*AS=Aqueous Suspension, CG=Celatom Granule, EC=Emulsifiable Concentrate, G=Granule, HP-D=Higher Potency-Double, P=Pellet, SG=Sand Granular, WP=Wettable Powder

Table 3-2. Some suggested ULV insecticides for adult mosquitoes. (For specific application rates and safety precautions, follow label directions.)

Insecticide Common name	Trade Name/Formulation*
chlorpyrifos	Dursban LC
malathion	Cythion LC (= Fyfanon)
naled	Dibrom LC
permethrin plus piperonyl butoxide	Permanone LC
resmethrin plus piperonyl butoxide	Scourge LC

*LC=Liquid Concentrate

Table 3-3. Some suggested insecticides for application as mist sprays for adult mosquitoes. (For specific rates and safety precautions, follow label directions.)

Insecticide Common name	Trade Name/Formulation*
carbaryl	Sevin SUS
chlorpyrifos	Dursban EC
malathion	Cythion EC (= Fyfanon)
naled	Dibrom EC
permethrin	Perimeter MF

*EC=Emulsifiable Concentrate, MF=Mosquito Formulation, SUS=Suspension

Aerial Application—Application by fixed-wing aircraft or helicopters for control of mosquitoes is a common practice. However, this method is generally not feasible for most areas in Kentucky because of its high costs and potential environmental concerns. In most cases, the insecticides labeled for aerial application are specific formulations designed for this purpose. Aerial applications are most useful under emergency conditions, or when the areas to be treated are too large or inaccessible for treatment with vehicle-mounted equipment.

Aerosol Application—Aerosols are applied to control mosquitoes outdoors using specialized equipment that dispenses insecticides in extremely small droplets. Aerosols work as a contact toxicant and have no residual effect. Consequently, they are effective only as a space treatment against actively flying adults. Aerosols are dispensed from the application device and allowed to drift as a fog with the wind through the target area. This technique is effective only where there is little wind. Aerosols can treat a swath of approximately 300 feet. Because the primary activity period for most pest and vector mosquitoes is during the evening hours, aerosol applications are usually most effective during this period.

Thermal Foggers—Thermal foggers dispense the insecticide by heating diesel oil or water to the vapor point and releasing the vapors along with the insecticide so that a thick smoke or fog of very fine particles is released. This technique is seldom used any more in the U.S.

Ultra Low Volume (ULV) Fogging—Special nozzle adaptations and development of micrometering systems now make it possible to apply undiluted insecticides in extremely small droplets (less than 25 μm on average) that can give effective coverage for adult mosquito control. Such application techniques now make it possible to reduce application volume to less than 4 fluid ounces of pesticide per acre.

ULV generators have several advantages over thermal fogging units. Less insecticide is applied with ULV, resulting in fewer potential environmental problems. Because smaller quantities of insecticide are applied, smaller holding tanks are needed, allowing smaller, more economical vehicles to be used. Finally, there is a significantly reduced hazard to traffic compared with the near non-visibility created by thermal fog applications.

Mist Applications—Misting involves applying insecticides suspended in water using powerful mist blowing machines. Mist droplets are somewhat larger than aerosol droplets and settle faster. Thus, misting does not have the “reach” available in ULV applications. However, mists do provide some residual control in addition to contact kill. Avoid direct application to parked cars because their finishes may become spotted if droplets are not washed off immediately.

Residual (Surface) Spraying—Residual pesticides are usually applied in water using hydraulic field or hand sprayers. This type of application is of limited utility because residual effectiveness of the treatment is usually short. Residual sprays are applied as surface applications to tall grasses, shrubs, trees, buildings, playgrounds, etc.

Indoor Control—Mosquitoes found inside buildings can be killed with most household aerosol sprays that are

labeled for flying insect control indoors. Aerosol space sprays containing synergized pyrethrins often produce rapid results. Doors and windows should be kept closed for 15-30 minutes after spraying. Only products labeled for flying insects should be used.

Repellents—Repellents can protect humans from mosquito bites for 1-12 hrs, depending on how much a person sweats and rubs the skin, and the percentage of active ingredient in the repellent. Repellents are formulated and sold as aerosols, creams, and liquids. Repellents containing ingredients such as diethyl-meta-toluamide (DEET) or dimethyl carbate are most commonly used. The area of skin to be protected should be covered evenly, because mosquitoes will find and bite spots left untreated. It is often helpful to apply repellents on outer clothing as well as the skin because many mosquitoes can bite through thin, tight-fitting clothing. Do not apply repellents to the eyes, nostrils, or lips.

DEET is a very effective repellent but should be used according to the product label. Do not apply DEET to the hands of young children. In addition, in very rare cases, use of this product may cause skin reactions. If a reaction to DEET is suspected, wash the affected area and contact the local poison control center.

Additional Control Measures

Vegetation Management—Many adult mosquitoes prefer to rest on weeds and other vegetation. Trimming or eliminating areas of dense vegetation will force mosquitoes to find other, more distant, resting sites.

Mechanical Barriers—Mosquitoes can be kept out of buildings by keeping windows, doors, and porches tightly screened with 12-18 mesh screening. This method is not as important in buildings that have air conditioning. Those few insects that do get into structures can be eliminated with a fly swatter.

Insect Electrocutors—Insect electrocutors (e.g., “bug zappers”), using ultraviolet light as an attractant, are generally ineffective at reducing outdoor populations of mosquitoes or their biting activity. Light traps using ultraviolet light do capture large numbers of flying insects, including mosquitoes, when used *inside* buildings.

Numerous other devices, including ultrasonics and mosquito-repellent plants, are available which claim to attract, repel, or kill outdoor infestations of mosquitoes. These devices are generally ineffective. Individuals considering purchasing such devices should first consult with a mosquito specialist.

Public Education

All good public health programs must include community-wide education of the public to gain and maintain support. This is especially important with mosquitoes. Widespread aerial spraying for mosquitoes can produce anxiety and concern over the effects of pesticides on human health. Homeowners can be of great help by managing their own property to eliminate breeding sources of several mosquito species. The effectiveness of any area-wide public health program can only be helped if people understand the program's benefits and limitations.

Flies

Flies, especially in large numbers, can be very annoying and seriously interfere with work and recreational activities. For centuries, flies have had a significant impact on human health and welfare because of their ability to spread disease. Most fly species have evolved to feed and breed in decaying organic matter, including garbage, sewage, dead animals, or manure. Flies have a high potential for spreading disease organisms because they show little preference when selecting feeding sites. They will just as readily feed on dog droppings in the lawn as they will potato salad at a family picnic (Fig. 4-1).

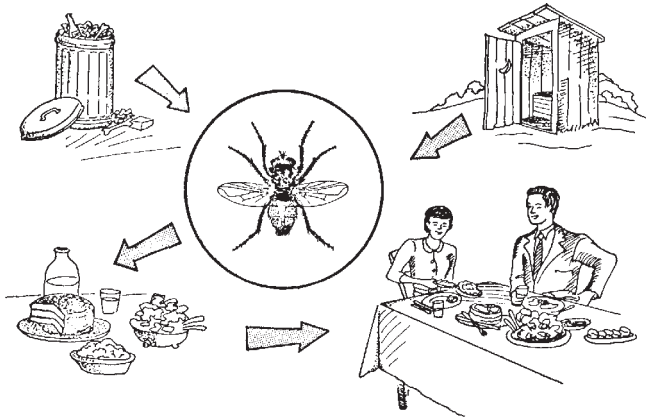

Fig. 4-1—Flies often feed on filth, before alighting on human food.

Flies are well equipped to transmit bacteria and other disease-producing organisms. Most are highly mobile, and their bodies are covered with thousands of tiny hairs. Flies have pads on the bottom of their feet, which aid in the mechanical pickup and transfer of pathogenic organisms. Many species, such as the house fly, also have “sponging” mouthparts for lapping up and ingesting liquid foods. As the house fly feeds, it regurgitates digestive enzymes and bacteria onto the food surface.

Other species of flies, including black flies, deer flies, and stable flies, have piercing/sucking mouthparts designed to suck blood. Bites of these flies are painful and may seriously interfere with outdoor activities.

All flies have four stages in their development: egg, larva, pupa, and adult. The habitat in which the adult female chooses to lay her eggs differs depending upon species (Table 4-1). Optimum larval development requires that the breeding medium be moist, but not wet. Many flies of public health significance lay their eggs in moist, decaying organic matter—human garbage and waste, manure of domestic animals, or decaying vegetation, fruits, or vegetables. After the eggs hatch, the larvae (called maggots) feed upon organic material, eventually transforming into the pupal stage from which they later emerge as adults. The development rate varies among species and is greatly influenced by temperature. Under ideal conditions, development can be completed in as little as one week. Considering that a single adult fly can lay several hundred eggs, the potential for a serious fly infestation is enormous.

Table 4-1: Summary of important domestic flies (from Wilson et al. 1977)

Insect	Identifying Characteristics	Preferred Host Material	Adult Occurance	Life Cycle	Management Methods	
					Chemical	Other
House Fly	1/4 inch long; dull gray with 4 stripes on thorax; 4th wing vein sharply angled.	Animal waste, garbage and other decaying organic matter.	Most abundant later summer and early fall.	7 to 45 days.	Residual and contact sprays; baits, traps; larvicides.	Sanitation, exclusion, habitat destruction.
Flesh Flies	2 to 3 times larger than house fly; gray and black checkerboard pattern on the abdomen.	Garbage, manure and animal carcasses.	Common in warm months	2 to 4 weeks	Residual and contact sprays; larvicides.	Sanitation and habitat destruction.
Blow Flies	About twice as large as house fly; metallic blue or green color.	Animal carcasses, garbage and manure.	Spring and summer.	2 to 4 weeks.	Residual and contact sprays; larvicides.	Sanitation and habitat destruction.
Fruit Flies	1/8 inch long; yellowish brown; hover around ripe or decaying fruits.	Decaying fruits and vegetables; garbage.	Most abundant in late summer and early fall.	1 to 2 weeks.	Residual and contact sprays.	Sanitation and habitat destruction.
Phorid Flies	Superficially resemble fruit flies, but are more humpbacked.	Decaying vegetation and animal matter.	Most abundant in warmer months.	1 to 2 weeks.	Residual and contact sprays.	Sanitation, habitat destruction, and moisture control.
Moth Flies	1/8 inch long; body and wings densely covered with long hairs.	Decaying organic matter, especially around drains and sewers.	More common in warmer months.	2 to 3 weeks.	Residual and contact sprays.	Sanitation, habitat destruction, and moisture control.
Cluster Fly	Superficially resemble house flies, but is slightly larger and more sluggish in its movement.	Parasitic on earthworms.	Abundant in spring and fall.	4 to 6 weeks.	Residual and contact sprays.	Screening and caulking around eaves, windows, etc.

Some flies disperse many miles from their original breeding site. More often, the breeding area is nearby, such as a pile of manure-soaked straw, a rotting potato beneath a cabinet, or a poorly maintained dumpster behind a restaurant.

Fly Management

An essential first step in managing fly problems is correctly identifying the species involved. This may require the assistance of an entomologist. Some of the more common domestic flies are shown in the taxonomic key (Fig. 4-2). Proper identification is important because this will help to identify possible breeding sites for corrective action. It may also identify conditions contributing to the infestation, such as poor sanitation or inadequate screening of doors or windows.



Non-Chemical Control

Sanitation is the single most important step in controlling flies. In general, the poorer the sanitation, the greater the fly problem. However, even small amounts of garbage or waste can support hundreds of developing flies. Fermenting goo under food preparation equipment, or a neglected floor mop, can support a serious infestation of fruit flies. The same is true for a seldomly cleaned floor drain which may be the source of moth flies or phorid flies. *Efforts must be made to find and eliminate the breeding source; otherwise, the problem is likely to continue regardless of what other control methods are attempted.*

BRIEF TAXONOMIC KEY FOR COMMONLY ENCOUNTERED FLIES

1. Small fly — less than 1/4 inch in length 2
 - 1'. Larger fly — about 1/4 inch in length or larger 8

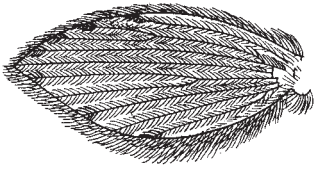
 2. Tan or brown in color 3
 - 2'. Dark color 5

 3. Wing has unique vein pattern (shown below) — body and wings covered with tiny hairs so that it resembles a moth **Moth Fly**
- 
- 3'. Pattern in wing veins not as described above 4
 4. Has red eyes — thorax does not have humpbacked shape **Fruit Fly**
 - 4'. Thorax has humpbacked shape (shown below) — head is small in comparison to body — does not have red eyes **Phorid Fly**
- 
5. Black, shiny color with bronze tints on thorax — body has long, thin shape — has reddish brown eyes — iridescent wings fold flat over abdomen — has sponging, lapping mouthparts **Cheese Skipper**
 - 5'. Not as described above 6

6. Wing has unique vein pattern (shown below) — body and wings covered with tiny hairs so that it resembles a moth **Moth Fly**

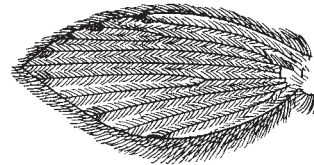

- 6'. Not as described above 7
7. The first segment of the tarsi on the hind leg is enlarged (as shown below) **Sphaeroцерid Fly**

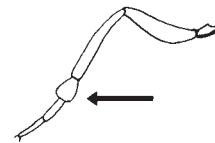

- 7'. Small, often tiny dark fly — has thin abdomen, legs and wings — the first leg segment, the coxa, is long and thin (as shown) **Fungus Gnat**

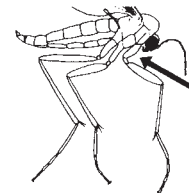

8. Medium-sized fly — body has shiny, metallic green or blue color **Blow Fly or Bottle Fly**
- 8'. Not metallic colored, size varies 9
9. Top of thorax has dark, longitudinal stripes 10
- 9'. No dark stripes on top of thorax 12
10. Three dark stripes on top of thorax — top of abdomen has checkerboard pattern of dark and light gray squares — medium to large flies **Flesh Fly**

Fig. 4-2—Taxonomic key for commonly encountered flies (Source: Hedges, Stoy A., PCT Field Guide for the Management of Structure-Infesting Flies, Franzak & Foster Co., 1994).

Fig. 4-2—continued

- 10'. Four dark stripes on top of thorax, 1/4-3/8 inch in length 11



11. Calypteres have no tuft of bristles (shown below) **House Fly**
 11'. Calypteres with a tuft of bristles (shown below) **Face Fly**



12. Medium-sized, dark colored fly — wings fold flat over body — has patch of yellow hairs present on upper (see below), front sides of the thorax **Cluster Fly**

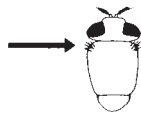

- 12'. Large flies, 1/2 inch to more than 1 inch in length — color varies 13
 13. Long, thin, black fly about 1 inch in length — has two light colored patches on top of abdomen just behind thorax **Soldier Fly**



- 13'. Not as described above 14
 14. Fly is about 3/8-1/2 inch in length — tan or brown color — visible biting mouthparts — has dark stripe or marking on wings **Deer Fly**
 14'. Larger, more robust flies with varying colors — large eyes, sometimes brightly colored — size may vary from 5/8 inch to over 1 inch in length — visible, strong biting mouthparts **Horse Flies**

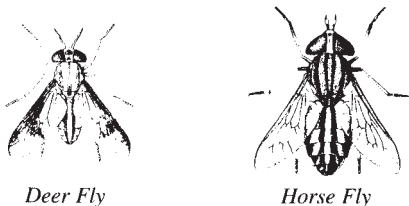

Clean garbage cans and dumpsters regularly and keep them covered to prevent attracting flies. Trash should be collected at least twice a week from residences, and daily from business establishments. Promptly removing waste ensures that if flies do begin breeding in garbage, they will be removed before a new generation reaches the adult stage. Garbage should be buried in a sanitary landfill. Incinerators may be practical for large cities where landfills are too remote. Sanitary disposal of sewage and industrial waste is essential in any municipal fly control program. Open sewage pits and wastes from canneries, feed mills, poultry and meat packing houses are sources of heavy fly breeding and can cause more problems in nearby residential areas. Adequate disposal methods should be available at the plant, or holding facilities should be available from which wastes can periodically be transported to a sanitary landfill. Public health agencies must secure the support of other agencies that will be involved with waste disposal.

Another very important method of preventing fly problems in buildings is **exclusion**. Exterior doors and windows should be properly screened and kept closed whenever practical. Plastic strip curtains and air doors can be used to deny fly access in some situations.

Once flies are inside a building, **light traps** can be used to capture the winged adults. These traps usually employ ultraviolet (UV) light as an attractant, and kill either by electrocution or entrapment on replaceable, glue-covered cardboard inserts. In order for these traps to be effective, they must be properly positioned along routes of fly entry and movement. They must also be installed at the proper height (ideally within 5 feet of the floor) and away from windows and other competing light sources. The “glow” of a light trap should not be visible from outside; otherwise, the trap will attract insects into the building when doorways are open. Bulbs should be replaced each year, and catch pans or glueboards serviced routinely to prevent dead insects from becoming a food source for other insects (e.g., dermestids).

Bottle or jar traps are also useful for capturing adult flies. Bottle traps are especially useful for trapping fruit flies and phorid (humpback) flies, once the breeding source is eliminated. (Potential breeding sites for these tiny flies include rotting fruits or vegetables; spillage in trash cans or recycling bins; unsanitized floor drains; and food-soiled mops or cleaning rags). A simple jar trap for fruit or phorid flies can be made by placing a paper funnel into a jar which is then baited with a few ounces of cider vinegar as an attractant.

Chemical Control

In most cases, insecticides should be considered a secondary form of fly control after sanitation, exclusion, and trapping. Regardless of how effective a treatment may appear, unless you locate and eliminate the breeding source and/or point of entry into a structure, the problem will continue. Moreover, because flies reproduce rapidly, they quickly develop resistance to most insecticides.

Various types of insecticide treatments are used in fly control.

• **Non-Residual (Contact) Sprays** — Temporary control of adult flies can be achieved by applying synergized pyrethrins

or short-residual synthetic pyrethroids such as allethrin, sumethrin, or resmethrin. While these insecticides quickly knock down adult flies, they provide no lasting effect and do not control developing larvae. Application can be made with aerosol-type dispensers, ultra low volume (ULV), or fog-generating equipment. For optimum results indoors, apply the precise amount of material per cubic area specified on the label. When performing space treatments, the applicator should wear goggles and a respirator. He should also ensure that no people are present, and that any food, utensils, or food preparation surfaces are covered or washed before reusing.

• **Residual Sprays**—Residual insecticides are sometimes useful in fly control, but only as a supplement to other methods already mentioned. Treatments should be applied as coarse low pressure sprays, confined to surfaces where flies rest and are likely to absorb a lethal dose (e.g., areas around dumpsters or sun-exposed exterior walls adjacent to a doorway). Several different insecticides are registered, including chlorpyrifos, diazinon, and propoxur. Synthetic pyrethroids (e.g., cypermethrin, cyfluthrin) are also very effective, especially wetttable powder or microencapsulated formulations.

• **Fly Baits**—Baits are a mixture of toxicant and attractant and are used primarily to control house flies. Most baits contain sugar and the house fly sex pheromone, muscalure. These keep the fly in contact with the toxicant for a longer time. Fly baits are typically formulated as granules which are placed in shallow trays or scattered around dumpsters and other fly breeding areas. Their effect is short-lived unless the bait is reapplied.

Wasps, Hornets, and Yellowjackets

Wasp, hornet, and yellowjacket stings are a serious health threat to humans and animals. Hundreds (perhaps thousands) of people in the United States die each year from allergic reactions to the venom of these insects. Wasps, hornets, and yellowjackets are more dangerous and unpredictable than honey bees. Workers foraging away from the nest are seldom aggressive, but nests should be eliminated with great care and in a specific manner. “Folk” remedies, such as dousing nests with gasoline or a garden hose, seldom work and can result in multiple stings.

Paper Wasps—Paper wasps (as well as hornets and yellowjackets) construct nests of a paper-like material containing finely chewed wood fragments and salivary secretions of the wasps. Paper wasps typically build their umbrella-shaped nests under eaves and ledges (Fig. 5-1). These brownish wasps are not as aggressive as yellowjackets or hornets, and can be eliminated rather easily with a wasp and hornet spray sold at most grocery and hardware stores. One advantage of these formulations is that they can be sprayed as far as 20 feet.

Although it is best to treat all wasps at night, paper wasps can be eliminated during the daytime *provided you do not stand directly below the nest during treatment*. Most wasp sprays cause insects to drop instantly. Standing directly under a nest increases the risk of being stung. After treatment, wait a day to ensure that the colony is destroyed, then scrape or knock down the nest. This will prevent secondary problems with carpet beetles and other insects.



Yellow jacket

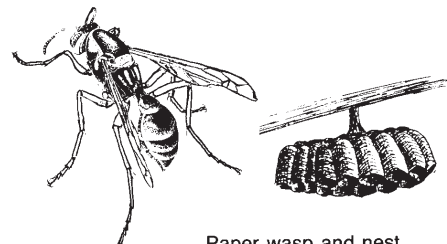

Paper wasp and nest

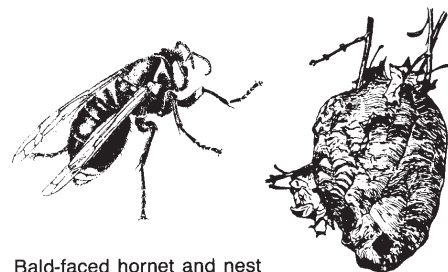

Bald-faced hornet and nest

Fig. 5-1—Wasps, hornets, and yellowjackets

Hornets—Hornets are far more difficult and dangerous to control than paper wasps. The nests resemble a large, grey, bloated football, which typically is attached to a tree, bush, or side of a building. Hornet nests may contain thousands of wasps which are extremely aggressive when disturbed. The nests are often located out of reach and removal is best accomplished by a professional pest control firm.

Treat hornet and yellowjacket nests at night when most wasps are within the nest and the colony is less active. A full wasp suit, sealed at the wrists, ankles, and collar, should be worn. Apply an aerosol-type wasp and hornet spray, or dust formulation, carbaryl (Sevin) or bendiocarb (Ficam), directly into the nest opening. Hornet nests have a single opening, usually toward the bottom, where the wasps enter and exit. *It is critical that the paper envelope of the nest not be broken during treatment or the irritated wasps will scatter in all directions, causing even greater problems.* Following treatment, wait at least a day before removing the nest to ensure that all of the wasps are killed. If hornets continue to be observed, the application may need to be repeated.

If the nest is located away from frequently used areas, another option is to wait and do nothing. In Kentucky, wasp, hornet, and yellowjacket colonies die naturally after the weather turns cold, and the paper carton disintegrates over the winter months.

Yellowjackets—Yellowjackets are often considered the most dangerous stinging insects in the United States. They tend to be unpredictable and usually will sting if the nest is disturbed.

Yellowjackets form annual colonies in Kentucky (Fig. 5-2). Mated queens overwinter under bark and in other shel-

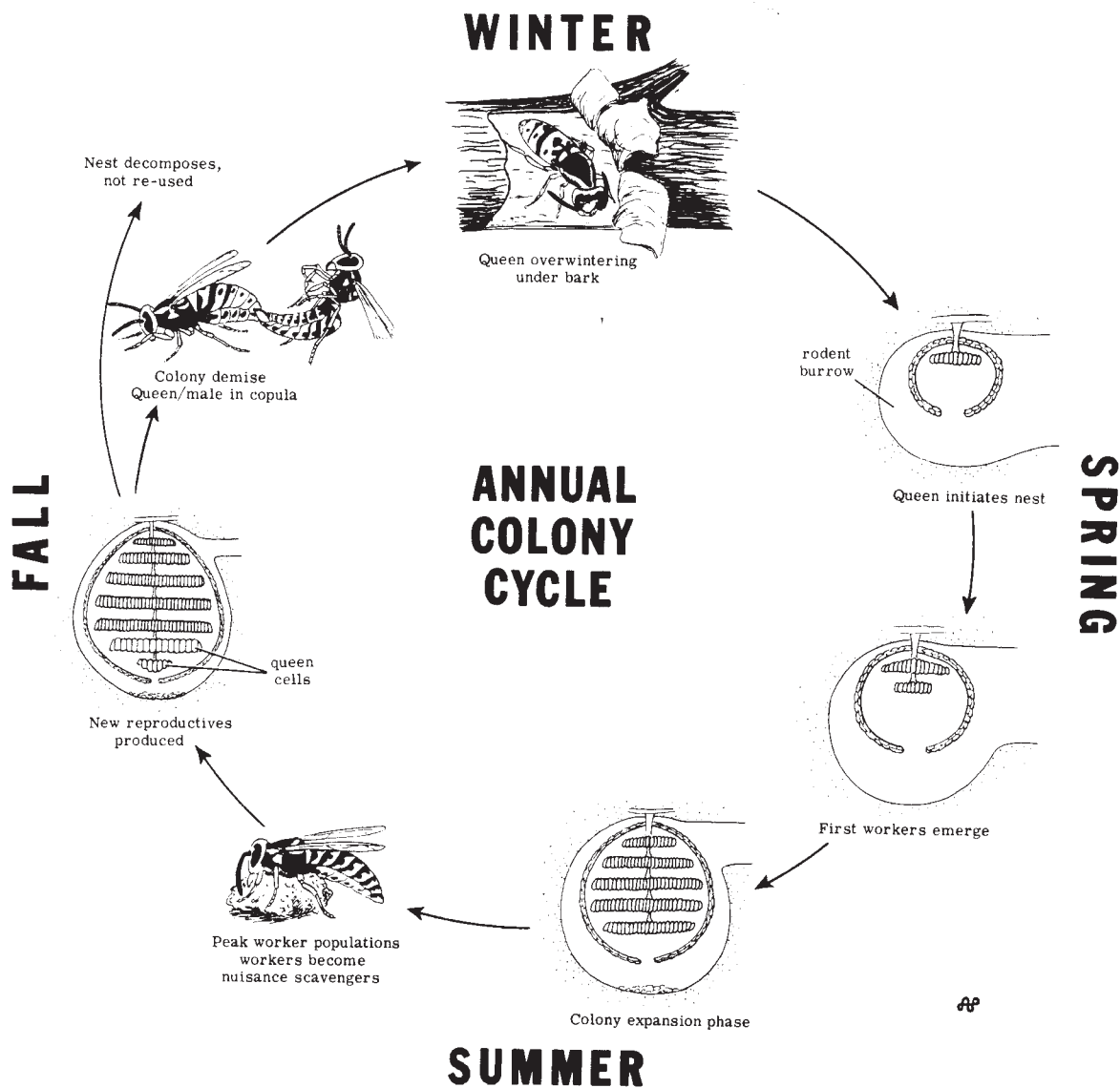

Fig. 5-2—Life cycle of the yellowjacket (modified from Olkowski et al. 1991)

tered locations. In the spring the queens emerge and construct a small paper nest in which they lay their eggs. Larvae are fed by the queen, and in about a month, emerge as sterile adult females called workers. The newly emerged workers assume all nest activities except egg laying. Thereafter, the colony grows rapidly, containing up to 4000 workers by the end of the summer. New males and queens are produced in late summer to early fall. After mating, the colony dies off and the newly fertilized queens seek out sheltered sites for overwintering. Abandoned nests are not reused and soon disintegrate.

Yellowjacket nests are often located underground in old rodent burrows or beneath rocks or landscape timbers. Yellowjackets also build nests in walls, attics, crawlspaces, and behind the siding of buildings. If the nest can be located, it can usually be eliminated by carefully applying a wasp spray insecticide into the nest opening. Dust formulations (e.g., carbaryl, bendiocarb, Drione®) are also very effective provided a handduster or similar type applicator is used to dispense several

puffs of insecticide dust into the nest opening. A dry, empty liquid detergent bottle filled no more than halfway with dust and shaken before dispensing also works well. A few pebbles or marbles added to the bottom of the bottle prevent caking.

Treatment should be performed late at night after all yellowjackets are in the nest and less active. Pinpoint the nest opening during the daytime so you will remember where to direct your treatment after dark. Approach the nest slowly and do not shine the beam of your flashlight directly into the nest entrance as this may startle the wasps; instead, cast the beam to the side to illuminate the nest indirectly. If possible, place the light on the ground rather than in your hand as wasps tend to fly toward light. As with hornets, yellowjackets are extremely aggressive when the nest is disturbed. It may be prudent to refer homeowners to a pest control operator, particularly when access to the nest is difficult.

Late-Summer Foraging Activity—During late summer and fall, yellowjacket colonies are nearing maturity and huge numbers of workers are out foraging for food for the develop-

ing queens. Late in the year, feeding preferences shift in favor of available sources of sugar, including fruits, ice cream, soft drinks, beer, or other sweets. The persistent foraging of yellowjackets at picnics and other outdoor activities produces many calls from homeowners and businesses wanting to know what can be done to alleviate the problem. Options include:

- **Sanitation**—The best way to reduce the threat of foraging yellowjackets is to minimize attractive food sources. People eating outdoors should keep food and beverages covered. Spills and leftovers should be cleaned up promptly. Trash cans should be equipped with tight-fitting (preferably self-closing) lids. Similar sanitation recommendations should be made to commercial establishments, including ice cream parlors, outdoor cafes, and supermarkets. Whenever possible, trash cans and dumpsters should be located away from serving tables, loading dock doors, and other entrances. Trash cans should be equipped with a plastic liner and emptied and cleaned frequently.

Maintaining high levels of sanitation earlier in the summer will make areas less attractive to yellowjackets later in the year. This strategy is especially useful for parks and recreation areas.

- **Avoidance**—Combined with sanitation, this is the best advice in most situations. Yellowjackets foraging away from their nests are seldom aggressive and usually will not sting unless provoked. People should resist the temptation to “swat” at the wasps -- and be careful when drinking from beverage cans which may contain foraging individuals.

Avoidance may also be the best advice if a yellowjacket (or hornet) nest is located in a tree or other out of the way location. As noted earlier, yellowjacket colonies die off on their own in late autumn.

- **Repellants**—A dilute solution of ammonia and water (approximately 6 ozs of ammonia per gallon of water) sprayed in and around trash cans and sponged onto outdoor tables and food preparation surfaces may help to repel yellowjackets from these areas. Use household ammonia, not bleach.

- **Traps**—Although only of marginal benefit, traps are available which catch impressive numbers of yellowjackets when properly baited and positioned. Business establishments such as outdoor cafes may find these traps worthwhile when used with other approaches. Braunschwagger liverwurst spread combined with jelly has been an effective attractant.

Allergic Reactions

Wasp, hornet and yellowjacket stings can be life-threatening to persons who are allergic to the venom. People who develop hives, difficulty breathing or swallowing, wheezing, or similar symptoms of allergic reaction should seek medical attention immediately. Itching, pain, and localized swelling can be somewhat reduced with antihistamines and a cold compress.

Spiders

Many different kinds of spiders live in and around buildings. Some, such as garden and cellar spiders, construct webs to help entrap their prey. Others, including the wolf spiders,

are free-roaming and make no webs. Most spiders are harmless, and in fact are beneficial, because they prey upon flies, crickets, and other insects. They generally will not attempt to bite humans unless held or accidentally trapped. Moreover, the majority of spiders have fangs too small or weak to puncture human skin. Of the hundreds of species found in Kentucky, only the *black widow* and *brown recluse* are dangerous. Fortunately, both are relatively uncommon, and have markings that can be used to distinguish them from other non-threatening species.

Black Widow Spider

Of the spiders capable of inflicting a poisonous bite, black widows are the most notorious. *The female is about 1/2-inch long, shiny black, and usually has a red hourglass mark on the underside of the abdomen* (Fig. 6-1). In some varieties the hourglass mark may be reduced to two separate spots. Spiderlings and male spiders are smaller than females and have several red dots on the abdomen's upper side.

Widow spiders belong to the cobweb spider family and spin loosely organized trap webs. The webs are usually found outdoors under objects such as rocks and ground trash or

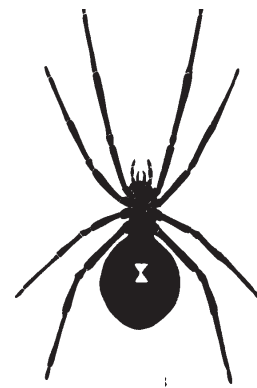

Fig. 6-1—Black widow spider (female)

under an overhanging embankment. Black widow spiders are not as common in homes as the brown recluse. When found in homes, they are usually under appliances or heavy furniture and not out in the open like other cobweb spiders. Black widow spiders are timid, however, and will only bite in response to being injured. People are usually bitten when they reach under furniture or lift objects under which a spider is hiding.

Black widow venom is a nerve toxin and its effects are rapid. The victim suffers painful rigidity of the abdomen and usually a tightness of the chest. Blood pressure and body temperature may rise and sweating, localized swelling, and a feeling of nausea may occur. In about 5% of the bite cases the victim may go into convulsions in 14 to 32 hours and die if not given medical attention. First aid for black widow spider bites involves cleansing the wound and applying ice packs to slow absorption of venom. Victims should seek medical attention promptly. Most black widow spider envenomizations respond to intravenous administration of calcium gluconate or calcium salts. An antivenin is also available for severe cases.

Brown Recluse Spider

The brown recluse (Fig. 6-2) is about the size of a black widow but is not so readily distinguished from many other spiders. It ranges from a dark cream color to dark brown. The abdomen is darker than the rest of the body. *It has a violin-shaped, dark mark on top of the leg-bearing section of the body* and therefore is sometimes called the “fiddler or violin” spider. Brown recluse spiders also have 3 pairs of eyes rather than 4 pairs for most other spiders.

The brown recluse roams at night seeking its prey. During the day, it hides in dark niches and corners, where it may spin a poorly organized web. It is shy and will try to run from

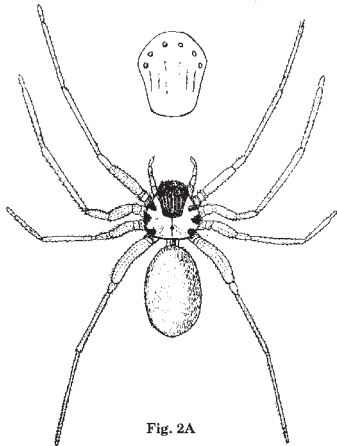

Fig. 6-2—Brown recluse spider

a threatening situation but will bite if cornered. People are sometimes bitten while they are asleep because they roll onto a brown recluse spider while it is hunting in the bed. More often the victim is bitten while putting on a shoe or piece of clothing which a spider has selected for its daytime hiding place.

The bite of the brown recluse is usually painless until 3 to 8 hours later when it may become red, swollen, and tender. Later, the area around the bite site may develop into an ulcerous sore from 1/2 to 10 inches in diameter. Healing often requires a month or longer, and the victim may be left with a deep scar. Prompt medical attention can reduce the extent of ulceration and alleviate other complications that may develop. In rare cases, the bite can produce a severe systemic reaction resulting in death.

Persons bitten by a spider which they think is a brown recluse should try to collect the specimen and bring it to a qualified individual for identification. Positive identification by an expert will help the physician decide on the appropriate course of treatment.

Control

Eliminating an infestation of brown recluse or black widow spiders involves two basic principles: (1) altering the environment in and around a building to make it less attractive to spiders; and (2) finding and destroying as many spiders as possible. The following measures can be used to control all spiders:

1. Routine, thorough house cleaning is the best way to eliminate spiders and discourage their return. A vacuum cleaner or broom effectively removes spiders, webs, and egg sacs.
2. Spiders prefer quiet, undisturbed areas such as closets, garages, basements, and attics. Reducing clutter in these areas makes them less attractive to spiders.
3. Large numbers of spiders often congregate outdoors around the perimeter of structures. Migration indoors can be reduced by moving firewood, building materials, and debris away from the foundation. Shrubs, vines and tree limbs should be clipped back from the side of the building.
4. Install tight-fitting window screens and door sweeps to exclude spiders and other insects. Inspect and clean behind outdoor window shutters.
5. Consider installing yellow or sodium vapor light bulbs at outside entrances. These lights are less attractive than mercury vapor, fluorescent, or incandescent bulbs to night-flying insects which, in turn, attract spiders.
6. To further reduce spider entry from outdoors, insecticides can be applied as a “barrier treatment” around the base of the foundation. Pay particular attention to door thresholds, garage and crawl space entrances, including foundation vents. Carbaryl, bendiocarb, chlorpyrifos, or any of the synthetic pyrethroids (e.g., cypermethrin, cyfluthrin, lambda-cyhalothrin) are effective, but may need to be reapplied periodically throughout the summer. Wettable powder or microencapsulated “slow-release” formulations are most effective.

The brown recluse may be found living indoors or outdoors while black widows are more often encountered outdoors. Thorough inspection of cracks, corners, and other dark, undisturbed areas with a bright flashlight will help determine the location and extent of infestation. Both species construct irregular, nondescript webs. Indoors, pay particular attention to basements, attics, crawl spaces, closets, under/behind beds and furniture, inside shoes, boxes of stored items, and between hanging clothing. Brown recluse spiders also may be found living in drop ceilings, behind baseboards, and inside ductwork or registers. Another way to detect infestations in these areas is to install glueboards or sticky traps. These devices can be purchased at grocery or farm supply stores. Placed flush along walls and in corners, glueboards and sticky traps are useful monitoring tools and will also capture large numbers of spiders.

Brown recluse and black widow spiders also live outdoors in barns, utility sheds, woodpiles, and underneath lumber, rocks, and accumulated debris. To avoid being bitten, wear work gloves when inspecting inside boxes or when moving stored items.

Each of the management tips (1-6) noted above for spiders in general is also useful against the black widow and brown recluse. Removal of unnecessary clutter is especially helpful in making areas unattractive to these pests. Indoor infestations of brown recluse and black widow warrant treatment with insecticides. Insecticides should be applied into areas where spiders are living, making an attempt to contact as many spiders and webs as possible with the treatment.

Spot treatments with synthetic pyrethroids such as cyfluthrin, cypermethrin, or lambda-cyhalothrin are especially effective. Most household insecticides with spiders listed on the label will also kill spiders provided the spider is treated directly. In inaccessible or cluttered areas such as attics and storage sheds, total-release foggers or aerosols containing synergized pyrethrin or synergized pyrethroids (e.g. resmethrin, sumithrin, cyfluthrin) will have a better chance of contacting spiders that are hidden.

Severe infestations of brown recluse or black widow spiders require specialized skills and equipment to eradicate. In these situations, it would be prudent to call a professional pest control operator.

Rodents

Rats and mice are remarkably well-adapted for living in close association with humans. The greatest economic loss is not from how much these rodents eat, but what must be thrown out because of damage or contamination. Food, clothing, furniture, books, and many other items are contaminated by their droppings and urine or damaged by their gnawing. Rodents damage doors, walls, insulation, and other structural components by their gnawing and burrowing. They also gnaw through utility pipes and electrical wiring, causing fires, indoor flooding, power outages, and equipment failure.

Rats and mice can also transmit diseases, most notably salmonellosis (bacterial food poisoning), when food is contaminated by infected rodent feces. Other rodent-borne diseases include plague, murine typhus, rat-bite fever, rickettsial pox, and hantavirus.

Description, Biology, and Habits

Three common species of rodents live in close association with humans: the Norway rat, roof rat, and house mouse.

Norway Rat—The Norway rat (Fig. 7-1), also called the brown or sewer rat, is the largest domestic rodent. An adult weighs about 12 to 16 ounces, and the body is stocky and covered with coarse, reddish brown fur. The head is small, with close-set ears and a blunt muzzle. The tail is shorter than the combined length of the head and body. Adult droppings are about 3/4-in long, capsule-shaped, with blunt ends.

Norway rats live about one year and reach sexual maturity in 2 to 3 months. Females have 4 to 6 litters each year with 6 to 12 young per litter.

Outdoors, Norway rats commonly nest in burrows alongside buildings, fences, and under bushes or debris. They use the same routes daily and their feet make a beaten path along the ground. Indoors, Norway rats prefer to nest in the lower portions of buildings in wall voids, underneath floors, in crawlspaces, and beneath or inside equipment or stored items.

Norway rats eat essentially the same foods as humans, including meats, vegetables, and cereal grains, as well as garbage. They require water each day when feeding on dry food. Rats tend to be more cautious than mice in their foraging and feeding habits. Their average foraging range from the nest is about 50-150 feet, but will travel further if food or water is scarce. Like all commensal rodents, Norway rats are nocturnal (active primarily at night), and they prefer to travel adjacent to walls and edges.

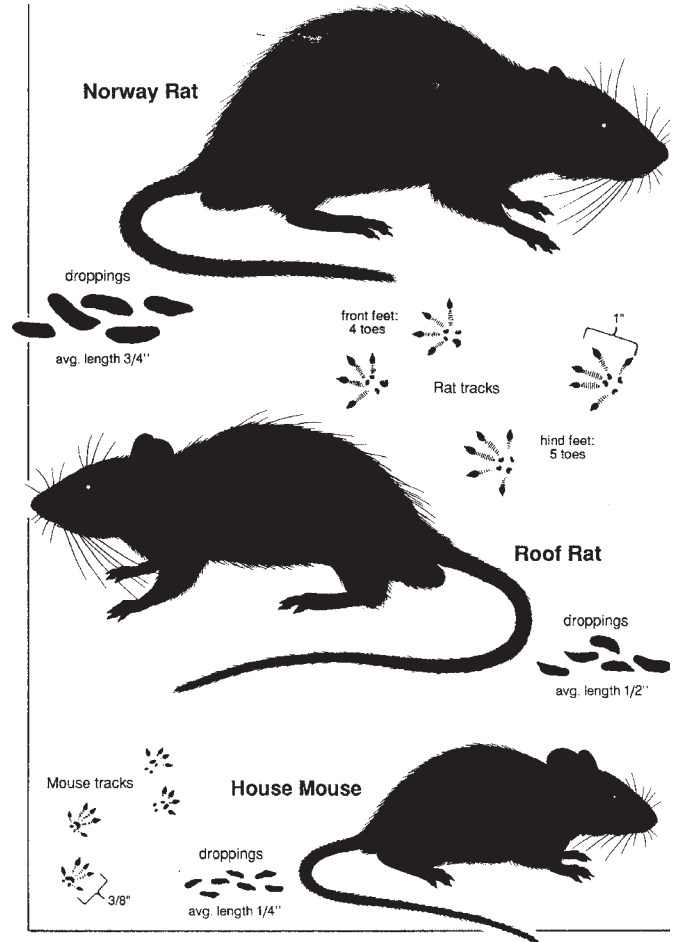

Fig. 7-1—Common domestic rodents (from Bennett et al. 1988).

Roof Rat—Roof rats are much less common in Kentucky, but are occasionally encountered. These rats are smaller and sleeker than the Norway rat, weighing about 8 to 12 ounces when fully grown. The tail is longer than the combined length of the head and body, the muzzle is pointed, and the ears are large.

Roof rats are excellent climbers and are usually found above ground level. Nests may be located indoors, in attics, roof areas, or ceiling voids. Roof rats often enter buildings by using tree limbs, utility lines, or fences. They also nest outdoors, in trees, vines, or on the roof or sides of buildings. Occasionally, they will nest in underground burrows like the Norway rat.

Roof rats consume many types of foods, but prefer vegetables, fruits, seeds, and cereal grains. Droppings are about 1/2-inch long and spindle shaped (pointed) on one end.

House Mouse—The house mouse is the smallest domestic rodent. Adults are 2 1/2- to 3 1/2-inches long, with a 3- to 4-inch semihairless tail. House mice are gray to brown, and have large ears. Mouse droppings are 1/8- to 1/4-inch long with at least one of the ends pointed.

House mice only live about a year, but are prolific breeders. Females produce 6 to 10 litters continuously throughout the year with 4 to 7 young per litter. House mice may live indoors or outdoors. Outdoors, they often live among weeds

and shrubbery or near building foundations, inside garages, crawl spaces, or outbuildings. When food becomes scarce in the fall, mice often move indoors. Inside buildings, mice commonly nest within walls, ceiling, and cabinet voids, furniture, and large appliances.

Mice feed on a wide variety of foods but prefer seeds and cereal grains. They are also fond of foods high in fat and protein such as nuts, bacon, butter, and sweets (a useful point to remember when selecting baits for snap traps). Mice are “nibblers” and may make 20 to 30 visits to different food sites each night. Compared to rats, mice forage only short distances from their nest, usually not more than 10-25 feet. When food and shelter are adequate, their foraging range may be only a few feet. For this reason, traps and other control devices must be placed in areas where mouse activity is most apparent. Similar to rats, mice prefer to travel adjacent to walls and other edges (another important point to remember when positioning control devices). Mice are very inquisitive and will investigate each new object placed in their foraging territory. Therefore, if control devices are not initially successful, try moving them to a different location.

Control

To control rats and mice, you must “think like a rodent.” Keep in mind the behavioral traits noted above for each species. Begin with a thorough inspection of the premises, relying on the following signs as indicators of rodent activity:

1) Droppings are the most common indicators of rodent presence and provide valuable clues where to place control devices. They are likely to be found where rodents travel, near their shelters, or other places rodents frequent. The shape and number of droppings can tell the species of rodent involved, the approximate size of the infestation, and whether the infestation is old or new. Fresh droppings are usually soft, shiny and dark but can become hard in a matter of hours. Old droppings are dull and often covered with dust. Active infestations can best be determined by removing old droppings and noting the presence of new droppings.

2) Runways/Rub Marks—Rodents are creatures of habit. They consistently use the same routes between food, water, and harborage. Outdoors, runways can be found next to walls, along fences, and under vegetation. Active runways are smooth, well packed, and free of vegetation. Indoors, runways may be found along walls, edges, and between stored items. As a rat moves along walls and through tight spaces, its body hairs often leave a dark, greasy deposit on surfaces. These “rubmarks” may be seen at ground level (along floor-wall junctions) or overhead beneath beams and rafters.

3) Burrows—The Norway rat prefers to nest in burrows, whereas the roof rat and house mouse only burrow occasionally. Rat burrows are usually found under concrete slabs, alongside building foundations, or beneath shrubbery and debris. Active burrows usually are smooth and compacted at the entrance, and free of dust and cobwebs. To determine if a burrow is active, stuff wads of paper into the opening or cave in the burrow with soil and recheck it the following day. Rat burrows usually consist of a main entrance and two or more “bolt” holes.

4) Tracks—Rodent footprints or tail marks can sometimes be found on dusty surfaces or in mud. To better see tracks in dust, hold a flashlight so that the beam is directed across the tracks at an angle. A tracking patch made of talc or flour can further help to determine if rodents are present.

5) Gnawing Marks—Mice and rats gnaw on all types of objects. Mice often gnaw small, clean-cut holes about one inch in diameter in boxes, bags, door sweeps, etc. Gnaw holes from rats are larger (about 2 inches in diameter), and often contain rough, torn edges. Rats often gnaw on the bottom of wood doors, joists, and other structural members.

Sanitation

Rodents must have food and shelter to survive. Whatever can be done to limit availability of these essential resources will help to reduce rodent problems. This is especially true for rats, which require considerably more food, water, and shelter than do mice. Garbage should be kept in rodent-proof containers and picked up regularly. The same is true for pet food and bird seed. Weeds and unnecessary vegetation should be removed, especially when they are adjacent to building foundations. (Weed seeds are a favored food of mice and also serve as rodent harborage). Rubbish, lumber, rock piles, and old equipment should be eliminated, as should standing water. Where practical, boxes, crates, and other items should be stored at least 18 inches off the ground and 12 inches away from walls. Storing items in this manner makes them less attractive to rodents. It also facilitates inspection, cleaning, and installation of rodent control devices.

Rodent-Proofing

Along with proper sanitation, the best way to avoid rodent problems in buildings is to prevent their entry. Mice are able to squeeze through extremely small openings no wider than the diameter of a pencil (1/4-inch). Rats can enter through cracks the size of a quarter (1/2-inch). Cracks and openings under doors, around windows, in building foundations, vents, and where plumbing, electrical, and air conditioning lines enter the structure should all be sealed (Fig. 7-2). Permanent sealants such as cement, sheet metal, and hardware cloth are preferred.

Traps and Glue Boards

Trapping can be a very effective form of rodent control, especially against mice. If signs indicate that you do not have a large rodent population, traps are generally preferred over pesticides because they are less hazardous to use around children and pets. In addition, because rodents are captured by the trap, they are not as likely to die in walls or other inaccessible areas and create odors. *Snap traps* (Fig. 7-3) are widely available and easy to use. Trapping efficiency can be enhanced by baiting the trigger with such foods as peanut butter, bacon, raisins, or fruit. Snap traps with an expanded trigger catch significantly more mice than conventional designs. Snap traps should be oriented perpendicular to the wall, with the trigger end against the vertical surface.

Another very effective trap against mice is the *automatic, multiple-catch trap* (Fig. 7-4). Mice enter these traps out of

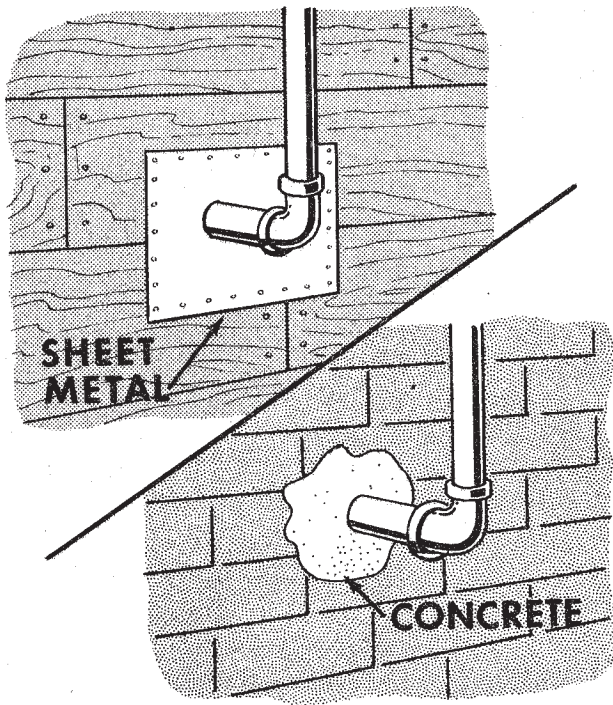

STOPPAGE OF OPENINGS AROUND PIPES

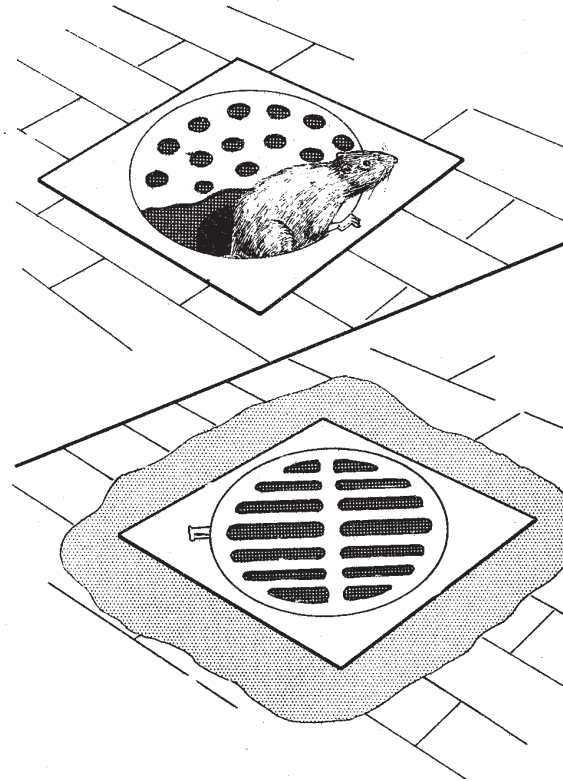

DRAIN COVER SCREENING

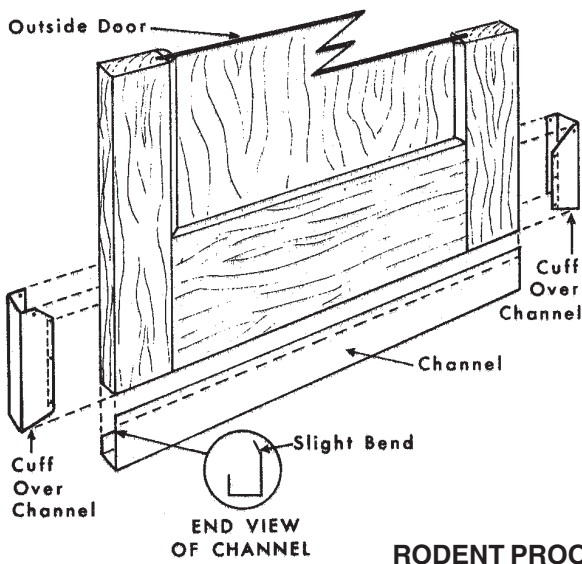

RODENT PROOFING OF A DOOR

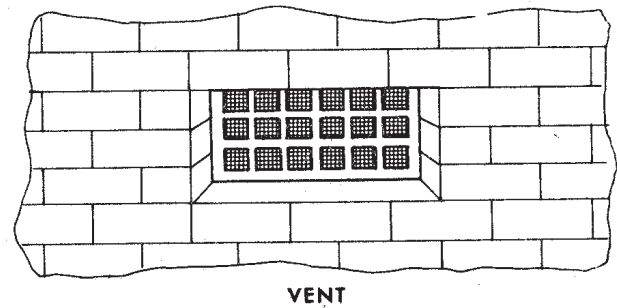

RODENT PROOFING OF A VENT

Fig. 7-2—Rodent proofing common entry points.

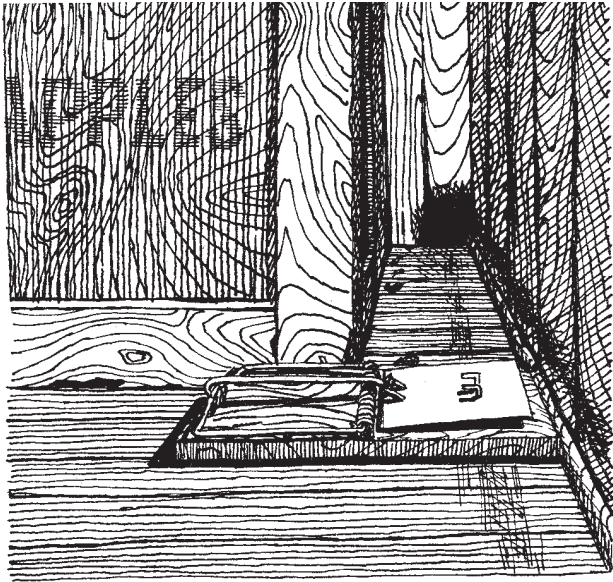

Fig. 7-3—Position snap traps flush against wall with trigger against vertical surface (note expanded trigger design)

curiosity for new objects placed in their territory. One type of multiple-catch trap requires winding and flips mice into a holding chamber. Another model operates using the principle of a trap door. Both devices can capture and hold several mice before needing to be emptied. Multiple-catch traps can be oriented with the entrance hole either perpendicular or parallel to the wall.

Glue boards are also very effective against rodents, especially mice. Mice become entangled in the glue when they

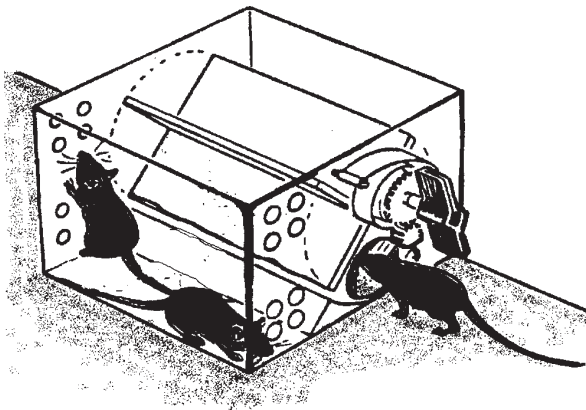

Fig. 7-4—One type of automatic multiple-catch trap.

run over the boards. Captured mice soon die of suffocation. Along with traps, glue boards are a preferred method of control in homes and other sensitive locations where pesticides are a concern. Glue traps can be purchased ready made, or can be custom made using bulk glue and plywood cut to varying sizes to fit the particular job requirements. Should the glue from a glue board contact the fur of a pet or the skin of a child, it can be removed with mineral or vegetable oil.

Regardless of which type of trap or glue board is used, placements should be installed up against walls, behind objects and appliances, and in secluded areas where droppings, damage, and other signs of rodents are evident. Ro-

dent control devices should also be installed in areas where there is potential for rat or mouse entry (e.g., on both sides of exterior doors, and near utility openings in walls).

Rodents have limited foraging ranges, therefore, it's important to use *several* trap placements. For mice, traps and glue boards should be spaced no more than 10 feet apart in areas where mouse activity is apparent -- closer if the infestation is severe. Rat traps can be spaced 15 to 20 feet apart.

Traps and glue boards should be checked daily, and dead rodents disposed of in plastic bags. Gloves should be worn when handling rodent carcasses to prevent any chance of disease spread. Records should be kept indicating where each control device was installed and which placements caught rodents. Decomposing rodents attract flies, dermestids, and other insects which can lead to additional problems if not removed. Keeping trap catch records also helps to identify persistent areas of rodent activity. Adjustments to the rodent control activities in these areas (e.g., adding more traps, exclusion, weed control) can then be made accordingly.

Rodenticides

Specific pesticides, known as *rodenticides*, are available for rodent control. The three main types are poison baits, tracking powders and fumigants.

Poison Baits

Most rodenticides are formulated as food-based baits containing seeds or grain to attract the rodents. Many baits are *anticoagulants* containing brodifacoum, bromadiolone, chlorophacinone, diphacinone, or warfarin as active ingredients. These toxicants kill by interfering with normal clotting of the rodents' blood, causing the rodent to die from internal bleeding. The newer anticoagulants (e.g., brodifacoum, bromadiolone) are normally lethal to rodents after a single feeding. Nonetheless, 3 to 5 additional days are typically required for the rodent to die. The older anticoagulants (warfarin, chlorophacinone, diphacinone) required several feedings by the rodent, and two or more weeks for death to occur.

Non-anticoagulant rodenticide baits are also available. Most of them kill rodents after a single feeding. Bromethalin kills rodents in 2-3 days by causing paralysis of the nervous system. Cholecalciferol causes an excess of calcium in the blood, leading to heart failure in 3-4 days. Zinc phosphide kills rodents in 1-24 hours by forming phosphine gas in the circulatory system.

Commercial baits, in pelleted or meal form, are available in sealed plastic, cellophane or paper packets (known as "place" packs), as loose bait, or molded into paraffin (wax) blocks. The wax block formulation is very useful for both outdoor and indoor baiting locations because it resists dampness and moisture. *Regardless of which bait formulation is used, extreme care must be taken to position baits in areas inaccessible to children, pets, and wildlife or in tamper-resistant bait stations.* Dogs, in particular, will seek out and find baits placed in areas that are accessible.

Other than when placing baits directly into a rodent burrow, it makes good sense to confine baits in an enclosed bait

box (Fig. 7-5). Bait boxes help to (1) reduce accidental contact with people and non-target animals, (2) keep bait fresh by protecting it from dirt, moisture, and dust, (3) provide a protected and attractive place for rodents to feed, and (4) allow label, company contact number, and other pertinent information to be provided at the baiting site. If rodent bait cannot be installed in locations inaccessible to children and non-target animals, it must be placed in **tamper-resistant bait boxes**. These boxes are constructed of metal or non-crushable plastic, are equipped with a locking mechanism, and have a specific internal design for confining bait within the station. In order to be considered truly tamper-resistant, the station must also be secured to the mounting substrate (ground, floor, wall, fence, etc.). This can be done with a stake, nail gun, length of chain, “liquid nails,” or by securing the station to a weighted paving block.

As with traps, proper bait placement is critical. Place bait in all areas suspected of harboring rodents, along routes of

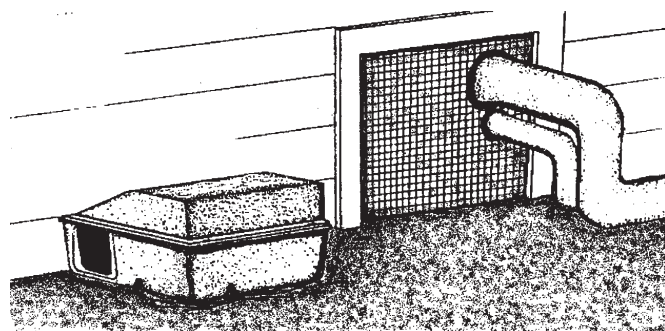

Fig. 7-5—Bait boxes enhance bait effectiveness and help prevent accidental poisoning. Place bait stations flush against walls and along rodent runways.

travel, and where they are likely to enter the building. Several placements will produce better results than just a few. Baits that are not being fed upon may need to be repositioned. Rodent bait should be replaced at least monthly because rats and mice are not attracted to old, moldy bait.

Tracking Powder

Some rodenticides are formulated as “toxic dusts,” known as **tracking powders**. Tracking powders may contain anticoagulants (e.g., chlorophacinone, diphacinone) or non-anticoagulants (e.g., zinc phosphide) as toxicants. Small amounts of tracking powder are placed in known rodent runways, burrows, wall voids, and other concealed locations, usually via a hand duster. Rodents pick up the toxicant on their fur and feet and ingest it while grooming. Tracking powders are especially effective against mice, which groom themselves and their nestmates continuously. Tracking powders should only be placed in inaccessible areas or in the bottom of tamper-resistant bait stations. As with any pesticide, care must be taken not to contaminate food preparation surfaces or other surfaces that may be contacted by people or pets.

Fumigants

Certain rodenticides are also formulated as poisonous gases (fumigants). The most common use of these products is for burrow gassing. Gassing rodent burrows with a fumigant is a fast and effective way to control burrowing rodents (e.g., Norway rats) in outside locations. The most common fumigant used for burrow gassing is **aluminum phosphide**, formulated as tablets or pellets. The product is placed in the burrow with a gloved hand, and the gas releases slowly as it reacts with ground moisture in the burrow. Fumigants can be extremely dangerous if used incorrectly. Applicators should always remember to read the pesticide label before use.

Pest Birds

Pigeons, starlings, and sparrows (Fig. 8-1) cause millions of dollars in damage by defacing buildings, sidewalks, cars, etc., with their droppings. Downspouts and air vents may become stopped up by nesting materials. Bird feathers, filth, and carcasses can lead to secondary pest problems by attracting carpet beetles, mealworms, and other scavengers.

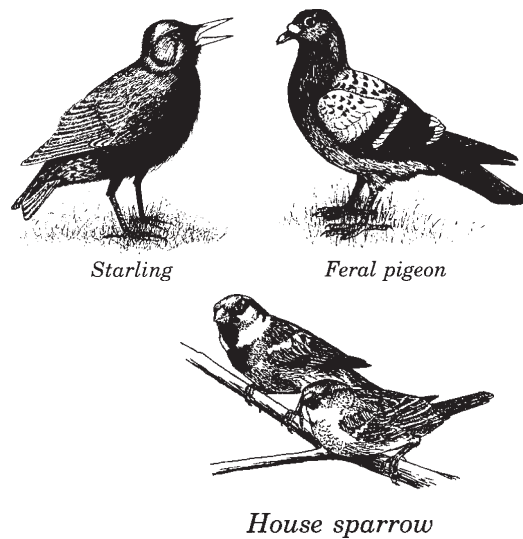

Fig. 8-1—Pictorial key to common pest birds.

Birds nesting around buildings also constitute a health hazard to people and animals. Ectoparasites such as mites, lice, and bedbugs can invade living areas and bite humans after the nestlings leave or a bird dies. Birds can also transmit serious diseases, including cryptococcosis and histoplasmosis — systemic fungal infections acquired by inhaling air-borne spores which grow in bird droppings.

Bird Management Options

Non-Lethal Controls—The most effective way to avoid problems with pest birds around buildings is to deny them nesting and roosting sites. The best time to do this is before nests are well established. Vents and other small openings should be sealed with 1/4-inch hardware cloth or similar exclusion materials. Attic vents may need to be screened or netted on the *exterior*, to prevent sparrows from nesting between the louvers. Nesting or roosting on ledges, eaves, window sills, and other surfaces can be deterred by installing tightly

strung, parallel strands of wire just above the surface of the ledge. Roosting of pest birds can also be discouraged by changing the angle of the ledge to 45 degrees or more with sheet metal or wood boards. “Porcupine” wires (e.g., Nixalite®, Cat Claw®) or coils (Bird Barrier™), repellent gels, or bird netting also are effective, provided they are correctly installed (Fig. 8-2).

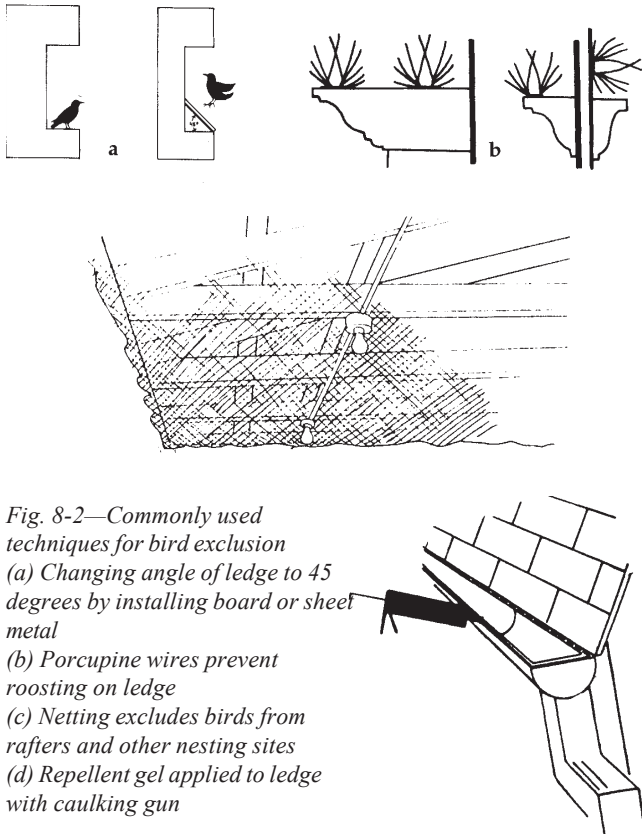

Fig. 8-2—Commonly used techniques for bird exclusion
(a) Changing angle of ledge to 45 degrees by installing board or sheet metal
(b) Porcupine wires prevent roosting on ledge
(c) Netting excludes birds from rafters and other nesting sites
(d) Repellent gel applied to ledge with caulking gun

Before installing the screening, remove nests and droppings to avoid problems with scavenger insects and disease pathogens. Gloves and a respirator (dust masks are insufficient) should be worn to avoid inhaling fungal and bacterial spores. Lightly moistening droppings and nesting materials with water before removal reduces the tendency for spores to become airborne.

Frightening devices can be used to disperse birds, but are often ineffective and require persistence and proper technique. Fake owls, snakes, balloons, and other visual repellents often fail because birds soon become acclimated to these objects and ignore them. If these devices are tried, reposition them periodically or vary the pattern. Noise devices (e.g., distress call cassette tapes, noise bombs, whistle bombs), can be effective for dispersing small roosts of birds such as starlings, but require persistence. Noise frightening efforts should preferably begin before the flock has formed a strong attachment to the site. Noise-producing devices should be activated before dark, as soon as the birds begin to appear at the roost. If frightening efforts are to be successful, they must continue for several consecutive nights.

In the case of pigeons, small populations can often be controlled by capturing them in *live traps* placed near their

roosting, loafing, or feeding sites. Success of live trapping can be enhanced by pre-baiting traps with corn or milo for several days before actual trapping begins.

Lethal Controls—Toxic perches are registered for the control of pigeons and starlings roosting around buildings. Perches are hollow tubes that hold about an ounce of toxicant and a wick to transfer the toxicant to the birds’ feet. Birds landing on the treated perch absorb the pesticide rapidly and die within 24 to 72 hours. The active ingredient used in most toxic perches (e.g., Rid-A-Bird®) is fenthion. Because of their potential hazard to non-target birds, animals and people, toxic perches are classified as Restricted Use Pesticides, and should be used only by trained personnel. In order to be effective, perches must be installed in areas where birds routinely roost. Toxic perches are prohibited inside food storage, handling, and processing facilities.

Toxic Baits can also be used to reduce pest bird populations. Commonly used products include **Avitrol** (for pigeons, starlings and sparrows) and **Starlicide** (for starlings). Avitrol is available in corn or mixed grain formulations of which a small number of grains or kernels are treated with a toxicant. Birds that eat the treated particles of bait behave erratically and emit warning cries. These birds, in turn, frighten other birds in the flock to leave the area. Birds that eat the treated bait particles usually die. Different levels of mortality and flock-alarming response can be achieved by varying the ratio of treated to untreated bait. Starlicide produces a slow, non-violent death in starlings, usually within 24 to 36 hours after feeding.

Toxic bird baits are Restricted-Use-Pesticides that require experience to use safely and effectively. Selection of baiting sites requires knowledge of daily bird activity patterns, especially where the flock is feeding. Pre-baiting with untreated bait is important in order to condition the birds to feed on the bait toxicant. Baiting must be carefully monitored to ensure that no non-target birds such as doves or songbirds are attracted to the bait.

Shooting of birds should be avoided and in many areas is illegal. Large or complicated bird jobs may require the services of a professional pest control operator or nuisance wildlife control expert.

Itches, Irritations, and Delusions

Once in a while, nearly everyone experiences the irritation of an unexpected itch or the sensation of something crawling over the skin. Other times, the irritation may feel more like an insect bite. These reactions can become so annoying for some people that they are forced to seek professional help. Even though actual pests may not have been observed, the irritation is often attributed to “bugs,” and an insecticide is applied in the hope that the problem will be resolved. Unfortunately, pesticides seldom work in these situations, and they may even cause irritation and additional health problems.

As a public health professional, you should be aware that there are many potential causes of itching and irritation other than pests. Allergies, cosmetics, medications, and environmental contaminants all can produce reactions similar to

insect bites. While this makes the experience no less real or unpleasant for the affected individual, it underscores the importance of keeping an open mind to the possibility of non-insect causes of such reactions. Much like a detective, you should attempt to rule out all potential sources of irritation through the process of elimination.

Sources of Irritation

Itches and real or perceived bites of unknown origin can usually be attributed to one of four general sources: (1) obscure biting arthropods (e.g., insects or mites), (2) personal use products, (3) environmental factors, or (4) health-related conditions. Specific agents most often implicated as irritants are summarized in Table 9-1 and discussed in detail below.

Obscure Biting Arthropods

In some cases, insects or minute, biting mites prove to be the source of irritation. Although these pests are quite small, most are visible upon close examination (Figure 9-2). The location and appearance of bites or welts on the body is another key consideration in determining if pests are causing the irritation as well as which species is involved.

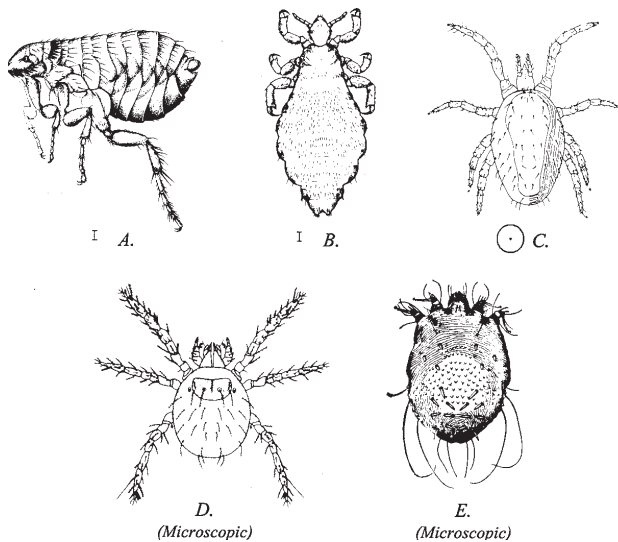

Fig. 9-2--Arthropod pests most often responsible for bites and itches of unknown origin: (a) flea, (b) louse, (c) bird mite, (d) chigger, (e) scabies mite. Note scale indicating actual size.

Fleas are the most common source of insect bites within homes. Although fleas are small (1/8") and fast-moving, they are large enough to be seen. They usually bite people around the ankles, producing a small, red, hardened, and slightly raised welt. Fleas are most often associated with pets, although the presence of mice, rats, squirrels, skunks, or raccoons can also result in fleas infesting a home.

Lice may also cause intense itching and irritation. Infestations occur on the head and other hairy areas of the body. Lice are tiny, grayish-white insects, but are visible under close inspection.

Mites are very tiny arthropods which occasionally infest structures and bite people. In most cases, the infestation can be traced to birds nesting in an attic or on a window ledge, etc., or to an infestation of mice or rats. When a

bird or rodent dies or the young leave the nest, thousands of parasitic mites may migrate indoors and bite humans. Bird and rodent mites are smaller than fleas and lice, but if you look closely they will appear as tiny, dark specks that move.

There are two notable exceptions where mites may be the source of irritation but are too small to be seen with the naked eye. The human itch (scabies) mite burrows into the skin, causing intense itching and irritation. Skin between the fingers, the bend of the elbow or knee, and the shoulder blades are areas most often affected. The intense itching is accompanied by a rash. Scabies is readily diagnosed and treated by most physicians.

Chiggers also bite people and generally are too small to be seen without magnification. Chiggers live outdoors in tall weeds and grass. They crawl onto people and move upward until they encounter a point of constriction between skin and clothing, such as around the ankles, behind the knee, or at the waistline. Chigger bites produce a hardened, red welt which begins to itch intensely within 24-48 hours. Consequently, people may not associate the irritation with the fact that they were bitten while walking outdoors a day or two before. Delayed irritation following a "bug" bite is also common with such pests as mosquitoes and ticks, as well as with the contact dermatitis which results from exposure to poison ivy/poison oak.

Mosquitoes, ticks, and a limited number of other arthropods may also bite people, but these pests are usually large enough to be seen at the time the irritation is felt. The vast majority of insects and related pests encountered in homes and buildings **cannot** bite people; yet, they are often blamed for itching or irritation caused by other factors.

If a person believes that insects too small to be seen are crawling over his or her skin, strips of clear cellophane tape may be patted over the affected area as the "crawling" sensation is occurring. Most small biting arthropods move slowly and will be picked up by the tape if present. Tape samples should be attached to a white index card and labeled to indicate from where they were collected.

Household Products

There are literally hundreds of non-insect agents capable of causing itching and irritation. Household products are involved far more often than are pests and may cause skin reactions similar to insect bites. Products most often implicated include phosphate detergents, soaps, cosmetics, ammonia-based cleaning agents, hair products, medications, printing inks (especially from multiform carbonless carbon paper), and certain types of clothing, particularly those which contain fire retardants. If a connection can be made between irritation and exposure to one of these potential irritants, avoiding further exposure may correct the problem. A dermatologist can usually confirm that a product, rather than a pest, is causing the irritation.

Environmental Factors

When two or more individuals experience irritation in the absence of pests, the cause is likely to be environmental con-

ditions or contaminants dispersed in the air. The irritant(s) may be either physical or chemical in nature.

Physical irritants—The most common physical irritants are tiny fragments of paper, fabric, or insulation (Figure 9-3). When these fibers contact the skin, they can produce symptoms ranging from a “crawling sensation” to intense itching accompanied by a rash, welts, or open sores. If fibers or fragments are involved, the irritation is usually generalized, occurring over exposed areas of the body such as arms, legs, neck, and head.

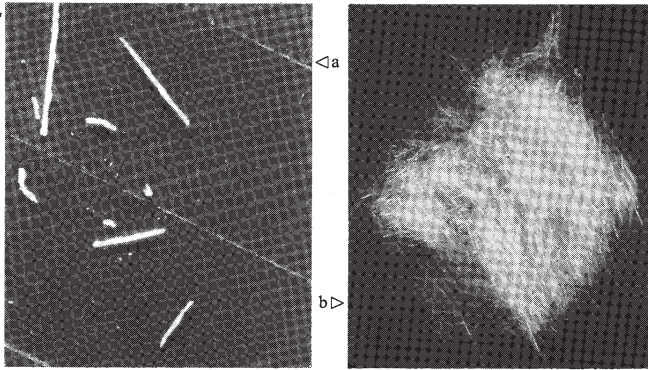

Fig. 9-3—Tiny fragments, such as these paper splinters (a) and insulation fibers (b), can cause itching and irritation often mistaken for insect bites.

Irritation produced by paper fragments is especially common in offices where large quantities of paper are processed daily. Continuous-feed paper from computers and multi-page forms generate large amounts of fragments, resulting in accumulations on desktops and other surfaces. Newly installed or badly worn synthetic carpet, drapes, or upholstery also shed fibers which can irritate skin.

Other potential sources of irritation are insulation fibers released into the air by heating/cooling systems in need of repair and sound-deadening fibers embedded into drop-ceiling tiles. These latter sources are especially suspect if there have been problems with the air-handling system or recent repair work on the ceiling.

Irritation is aggravated by static electricity which increases the attraction of the tiny charged fibers to exposed skin. Low humidity, electronic equipment, and nylon (e.g., from carpeting, upholstery, or women’s stockings) all increase levels of static electricity and the potential for problems from fragments or fibers. Static electricity may also cause body hair to move, giving the impression of insects crawling over the skin.

If fibers or fragments are suspected of causing the reactions, floors, rugs, work surfaces, and furniture should be thoroughly and routinely vacuumed, and desktops and tables wiped down with a damp cloth. Static-reducing measures should also be considered such as raising the humidity level of the air and installing static-resistant mats and pads under chairs and electronic equipment in offices. Anti-static sprays can be used to treat seat cushions and nylon stockings.

Dry air alone can cause irritation, producing a condition known as “winter itch.” As skin loses moisture, itching results. A similar reaction can occur from changes in tempera-

ture; these tend to make skin more sensitive. A skin moisturizer is often helpful in these situations.

Airborne chemical irritants—Indoor air pollution can be a serious problem in modern office buildings and other energy-efficient structures where air is recirculated over and over. Indoor air pollution can also be a problem in homes. As the concentration of chemical contaminants in the air increases, people may experience dizziness, headaches, and eye, nose, or throat irritation. Certain air-borne contaminants can also produce rashes and skin irritation similar to insect bites. Chemical contaminants most often responsible for these reactions include ammonia-based cleaning agents, formaldehyde emitted from wall and floor coverings, tobacco smoke, and solvents and resins contained in paints, glues, and adhesives.

Reactions to airborne chemicals most often occur in buildings with inadequate ventilation, especially those that are new or have been refurbished with new paint or wall or floor coverings. If indoor air pollutants rather than insects are suspected, contact an industrial hygienist. These specialists are equipped to monitor ventilation levels and the presence of allergy-producing contaminants. Companies specializing in environmental health monitoring have listings in the telephone directories of most metropolitan areas.

Health-Related Conditions

Health-related conditions may be responsible for irritation mistakenly attributed to insects. Itching and skin irritation are common during pregnancy (especially during the last trimester) and may also occur in conjunction with diabetes, liver, kidney, and thyroid disease, and herpes zoster (shingles). Food allergies are another common cause of itching and irritation.

One’s emotional state can likewise induce skin reactions that can be mistaken for insect bites. Stress and conflict at work or home can produce itching and irritation. The itching response can be induced in other individuals simply by the “power of suggestion”; i.e., when one person in a group feels an itch or bite and begins to talk about it, others also feel the urge to scratch as well (a condition known as Bell’s syndrome).

Delusions of parasitosis is a more serious emotional disorder characterized by an irrational fear that living organisms are infesting a person’s body. Cases of delusory parasitosis often have similar symptoms and patterns of behavior. Patients typically report “bugs” invading their ears, nose, eyes, and other areas of their body. The “creatures” frequently disappear and reappear and change colors while being observed. Specimens brought in for identification usually consist of bits of dead skin, hair, lint, and miscellaneous debris. The skin of the individual is often severely irritated from desperate scratching, excessive bathing, and application of ointments. While these occurrences may seem bizarre to persons who are not affected, they are frighteningly real to the patient. Delusions of parasitosis as well as other suspected emotional or medical conditions should be brought to the attention of a dermatologist or other physician.

Finding a Solution

There is no easy way to pinpoint the cause of so-called “invisible” itches. The most important consideration in determining if pests are involved is whether or not anyone has actually seen or captured any “bugs” as the itching or irritation is occurring. As noted earlier, most insects and mites that bite humans can be seen without magnification if you

look carefully. Pesticides should not be applied unless there is actual evidence that pests are the cause of irritation.

Most often, pests will not be involved and relief from irritation will lie outside the realm of pest control. Approaching these problems in a rational and methodical manner will increase the chances of finding other likely sources of irritation. Refer to the list of likely irritants in Table 9-1 and follow suggestions that were mentioned earlier for alleviating the condition.

Table 9-1. Principal Causes of Itches and Bites of Unknown Origin

<p>Obscure Biting Arthropods*</p>	<ul style="list-style-type: none"> • mites (e.g., bird, rodent, scabies) • lice • fleas • chiggers • biting midges/mosquitoes • ticks • bedbugs
<p>Household Products</p>	<ul style="list-style-type: none"> • detergents (especially phosphate-based) • soaps • cosmetics/hair products • ammonia-based cleaners • medications • printing inks (e.g., carbonless) • clothing (especially fire retardant)
<p>Environmental Factors</p> <p>A. Physical irritants</p> <p>B. Chemical irritants</p>	<ul style="list-style-type: none"> • paper, fabric, or insulation fibers • low humidity • seasonal changes in temperature • static electricity • formaldehyde (e.g., from particle board, wall and floor coverings) • ammonia • solvents/resins associated with paints and adhesives • tobacco smoke • volatiles from asphalt and tar installation
<p>Health-Related Conditions</p>	<ul style="list-style-type: none"> • pregnancy • communicable diseases (e.g., chicken pox, measles) • stress • diabetes, liver, or kidney disorders • food allergies • insect phobias
<p><i>*Many of these pests are large enough to be seen without magnification. One should also consider the possibility of delayed irritation such as from bites obtained while outdoors.</i></p>	

Where trade names are used, no endorsement is intended, nor criticism implied of similar products not named.

Educational programs of Kentucky Cooperative Extension serve all people regardless of race, color, age, sex, religion, disability, or national origin. Issued in furtherance of Cooperative Extension work, Acts of May 8 and June 30, 1914, in cooperation with the U.S. Department of Agriculture, M. Scott Smith, Director of Cooperative Extension Service, University of Kentucky College of Agriculture, Lexington, and Kentucky State University, Frankfort. Copyright © 2005 for materials developed by University of Kentucky Cooperative Extension. This publication may be reproduced in portions or its entirety for educational or nonprofit purposes only. Permitted users shall give credit to the author(s) and include this copyright notice. Publications are also available on the World Wide Web at www.ca.uky.edu.