

# **BRIDGEWATER - RARITAN REGIONAL HIGH SCHOOL**

**600 Garretson Road  
Bridgewater, NJ 08807**

## **PROGRAM OF STUDIES**

**2021 - 2022**



## **PERSONNEL DIRECTORY**

### **ADMINISTRATORS**

*PHONE: 908-231-8660*

Dr. Charles Ezell.....ext. 477005	Principal
Mr. Vincent Del Priore .....ext. 477001	Assistant Principal
Dr. Michael Godown .....ext. 477003	Assistant Principal
Dr. Kristia Greenberg .....ext. 477004	Assistant Principal
Ms. Laura Zamrok .....ext. 477002	Assistant Principal

### **DEPARTMENT SUPERVISORS**

*PHONE: 908-231-8660*

Dr. Laura Craig .....ext.477509	Supervisor of Performing Arts K – 12
Ms. Jennifer Edge .....ext.471499	Supervisor of Social Studies K – 12
Ms. Lois Fyfe .....ext. 477510	Supervisor of Health, Physical Education, & Nursing K – 12
Mr. Michael Herbst .....ext. 471899	Supervisor of Science 6 – 12
Dr. Leonard Herman .....ext. 471399	Supervisor of Business, Industrial Technology, & Family Consumer Science 6 – 12; Fine Arts K-12
Mr. Alan Iachini.....ext. 477203	Supervisor of School Counseling K – 12
Dr. Mark Jarmon .....ext. 471599	Supervisor of English 9 - 12
Ms. Maria Kostis.....ext. 471799	Supervisor of World Languages & ESL K - 12
Mr. John Maggio .....ext. 477501	Athletic Director
Mr. Jason Mauriello .....ext. 471699	Supervisor of Mathematics 9 – 12
Mr. Brian Smith.....ext. 937502	Supervisor of Special Education 9 – 12

*PHONE: 908-685-2777*

Mr. David Matonis .....ext. 937503	Supervisor of Special Programs K – 12
Ms. Annmarie Mattia .....ext. 937402	Supervisor of Professional Practice & Development

### **HIGH SCHOOL COUNSELING STAFF**

*PHONE: 908-231-8660*

Ms. Justina Del Rio ..... ext. 477215	Dr. Terry McDonald ..... ext. 477224
Mr. Bryan Devlin ..... ext. 477212	Mr. Steve Rubin ..... ext. 477217
Ms. Lisa Finnis ..... ext. 477214	Mr. Evan Seavey ..... ext. 477218
Ms. Bernice Hornchak..... ext. 477219	Ms. Imrin Thind ..... ext. 477221
Ms. Jessica Kaiser..... ext. 477220	Ms. Sapphire Toussaint..... ext. 477222
Ms. Laura Karns ..... ext. 477216	

### **HIGH SCHOOL CHILD STUDY TEAM**

*PHONE: 908-231-8660*

Ms. Julie Gold, Psychologist ..... ext. 477505	Dr. James Porter, Psychologist ..... ext. 477514
Mr. Robert Jankay, Social Worker ..... ext. 477507	Ms. Sabina Sessa, LDTC..... ext. 477515
Ms. Erin Lowman, Psychologist..... ext. 477508	Ms. Risa Trinker, LDTC ..... ext. 477518
Ms. Gerardine McKnight, Psychologist..... ext. 477522	Ms. Suzanne Trombadore, Psychologist ..... ext. 477519
Ms. Sarah Morelli-Stutz, Psychologist ..... ext. 477512	Ms. Kimberly Turse, LDTC..... ext. 477520
Mr. Roman Panczyszyn, Psychologist ..... ext. 477513	

**CENTRAL ADMINISTRATION**

PHONE: 908-685-2777

Dr. Thomas Ficarra .....	ext. 937198	Interim Superintendent of Schools
Ms. Karen Jones.....	ext. 937298	Assistant Superintendent of Schools
Dr. Daniel Fonder.....	ext. 937605	Assistant Superintendent for Personnel
Dr. Daniel Silvia .....	ext. 937801	Assistant Superintendent for Special Services
Mr. Peter F. Starrs.....	ext. 937701	School Business Administrator/Board Secretary

---

**BOARD OF EDUCATION**

- Ms. Jackie Barlow, President
- Mr. Barry Walker, Vice President
  - Ms. Jill Gladstone
  - Ms. Lynne Hurley
  - Mr. A.J. Joshi
- Ms. Chingchanun Lee
  - Ms. Jessica Levitt
  - Ms. Lucretia Sandler
  - Mr. Steven Singer

**Educational Philosophy**

The educational philosophy of the Bridgewater-Raritan Regional School District is founded on the belief that the responsibility of school is to nurture intellect, civic mindedness, and sociability in students through the combined efforts of staff, administration, parents and community. Our Board of Education believes that students should be guided to attain the knowledge and to develop those skills necessary for success in future occupational endeavors and in the social world in which they will find themselves after formal schooling ends. A fundamental aim of our schools is to develop in youth an understanding of, an appreciation for, and a devotion to the democratic way of life and to instill a desire to improve this way of life. The Board believes the welfare and the development of each individual are the basis of our educational program. All children shall have an opportunity to learn. A well prepared individual, able to meet and solve the problems of society, is the goal.

The Board and staff accept the following charges to achieve this goal:

- To accept primary responsibility for giving students a mastery of the basic skills of learning, thinking, and problem solving; for teaching them to use the various media of self-expression; for instilling in them a knowledge of the social and natural sciences; for acquainting them with the richness of our heritage; and for stimulating them to productive work in the various areas of human endeavor.
- To recognize their responsibility to help meet the physical, intellectual and emotional needs of children, particularly the needs to inquire, to learn, to think, to create, to establish aesthetic, moral and ethical values, and to relate satisfactorily to others in social situations involving family, work, government, and recreation.
- To acknowledge the importance of their supplemental role to the home and other social agencies in developing habits which make for effective personal living, for the maintenance of optimum physical and mental health, and for the establishment of sound moral, ethical, and aesthetic values.

## Graduation — Requirements

### Graduation Requirements: High School

Diplomas shall be granted only to students who have completed the requirements for graduation as mandated by state law and administrative code established and approved by the Bridgewater-Raritan Board of Education. Those requirements include:

- The achievement of approved levels of proficiency in all courses necessary to satisfy graduation requirements.
- The student's compliance with the district's final examination requirements as stated in *BOE Policy 2624.1, Mid-Year and Final Examinations: High School*.
- The student's compliance with the district's attendance requirements as stated in *BOE Regulation 5200, Attendance*.
- The achievement of a passing score as indicated in the charts below (by graduating year) on any required New Jersey State assessment(s) or other designated, substitute assessment(s) approved by the New Jersey Department of Education (NJDOE).

Students who perform below statewide standards shall be provided with a comprehensive individualized assessment as specified in *N.J.A.C. 6:8-3.4*. On the basis of assessment students shall be provided with the services needed to remedy those identified deficiencies, which shall include but not be limited to the development and implementation of an individual student improvement plan.

#### For the Class of 2022:

English Language Arts	Mathematics
NJSLA/PARCC ELA Grade 10 $\geq$ 750 (Level 4) <i>or</i>	NJSLA/PARCC Algebra I $\geq$ 750 (Level 4) <i>or</i>
NJSLA/PARCC ELA Grade 9 $\geq$ 750 (Level 4) <i>or</i>	NJSLA/PARCC Geometry $\geq$ 725 (Level 3) <i>or</i>
NJSLA/PARCC ELA Grade 11 $\geq$ 725 (Level 3) <i>or</i>	NJSLA/PARCC Algebra II $\geq$ 725 (Level 3) <i>or</i>
SAT Reading Test $\geq$ 22 <i>or</i>	SAT Math Test $\geq$ 22 <i>or</i>
SAT Evidence-Based Reading & Writing Section $\geq$ 450 <i>or</i>	SAT Math Section $\geq$ 440 <i>or</i>
ACT Reading or ACT PLAN Reading** $\geq$ 16 <i>or</i>	ACT or ACT PLAN Math** $\geq$ 16 <i>or</i>
Accuplacer Write Placer $\geq$ 6 <i>or</i>	Accuplacer Elementary Algebra $\geq$ 76 <i>or</i>
Accuplacer Write Placer ESL $\geq$ 4 <i>or</i>	Next-Generation ACCUPLACER Quantitative, Reasoning, Algebra, and Statistics (QAS) $\geq$ 255
PSAT10 Reading or PSAT/NMSQT Reading $\geq$ 22 <i>or</i>	PSAT10 Math or PSAT/NMSQT Math $\geq$ 22 <i>or</i>
ACT Aspire Reading** $\geq$ 422 <i>or</i>	ACT Aspire Math** $\geq$ 422 <i>or</i>
ASVAB-AFQT Composite $\geq$ 31 <i>or</i>	ASVAB-AFQT Composite $\geq$ 31 <i>or</i>
Meet the Criteria of the NJDOE Portfolio Appeal	Meet the Criteria of the NJDOE Portfolio Appeal

\*\*Test is no longer administered but can be used for the graduating year.

#### For the Classes of 2023 and beyond:

##### From NJDOE:

*"The NJDOE is committed to providing fair notice to students and educators and will continue to collaborate with stakeholders to transition to the next generation of statewide assessments."*

## High School Credit and Course Requirements for Graduation

- A total of **120** credits are required for graduation, 90 of which must be earned at the high school level or through demonstration of proficiency as per Option II (see page 6).
- Courses amounting to at least 35 credits must be taken by all 9<sup>th</sup>, 10<sup>th</sup>, and 11<sup>th</sup> grade students. For these three grade levels, a minimum of seven courses must be scheduled at all times.
- 12<sup>th</sup> grade students are permitted to take the minimum number of credits needed for graduation. Students are required to take an English Language & Literature IV course and a Physical Education/Health IV course during their senior year.
- Successful completion of the following courses:
  - Four years (20 credits) of **English Language & Literature** (AP English Language & Composition and/or AP English Language & Literature included)
  - Three years (15 credits) of **Social Studies**; two years (10 credits) must be American History and one year (5 credits) must be World Civilizations
  - Three years (15 credits) of **Science** (5 credits must be in laboratory Biology and one additional laboratory/inquiry based science course in Chemistry, Physics, or Environmental Science)
  - Three years (15 credits) of **Mathematics** (must include Algebra I and Geometry)
  - One year (5 credits) in **World Languages**
  - One year (5 credits) in **Visual and Performing Arts**

### *Visual and Performing Arts Courses:*

AP Art History	Cultural Ceramics	Select Treble Choir
AP Music Theory	Design	String Orchestra 9
AP Studio Art	Digital Fine Arts I	String Orchestra
Art History	Intro to Guitar	Symphonic Band
Art I, II, III, IV (all levels)	Mixed Choir	Symphonic Choir
Ceramics I, II, III, IV	Music Workshop	Symphony Orchestra
Concert Band	Painting and Drawing	Wind Ensemble
Crafts I, II	Sculpture	



- One year (5 credits) in **21<sup>st</sup> Century Life and Careers**, or **Career-Technical Education**

*21<sup>st</sup> Century Life and Career Courses:*

Academic Internship Program	Entrepreneurship & Business Management
Accounting I, II	Family & Child
Advanced Topics in Computer Science	Family and Consumer Sciences
AP Computer Science A	Fashion & Creative Design
AP Computer Science Principles	Filming & Video Editing I, II, III, IV
AP Macroeconomics	Fundamentals of Automated Design
AP Microeconomics	Home & Interior Design
App Development	International Foods
Audio & Music Engineering	Introduction of Culinary Arts
Baking & Pastry Arts	Introduction to Business
Business & Criminal Law	Introduction to Electronics
Career Exploration and Awareness	International Business
CNC Production	Introduction to Electronics
Computer Aided Design Tech. I, II	Introduction to Marketing through Social Media
Computer Applications & Keyboarding	Leadership & Philanthropy
Computer Repair & Tech. Support I, II	Notetaking & Study Skills
Computer Science I, II	Photo Editing & Web Design
Cooking Across America	Photo Editing for Business
Culinary Nutrition	Programming for Business
Design & Sewing Techniques	Programming for Business II
Desktop Publishing & Multimedia Presentations	Today's Living
Early Childhood Education	Wood Design and Fabrication I, II, III
Engineering Computer Graphics I,	
All Programs of Study at Somerset County Vocational Technical School	

- One-half year (2.5 credits) in **Financial, Economic, Business, and Entrepreneurial Literacy**

Accounting I	Financial Planning
AP Macroeconomics	Introduction to Business
AP Microeconomics	Related Instruction (Academic Internship)
Economics Today	Today's Living

- **Technological Literacy** – integrated throughout the curriculum
  - One credit year of **Physical Education, Health and Safety** for each year of enrollment.
- In some instances, as determined by the high school principal in consultation with the Superintendent, students may meet specific credit and curriculum requirements through *BOE Policy 5462, Option Two* (refer to page 6 for more information).

### Requirements for Promotion

- 30 credits are required for placement in grade 10
- 60 credits are required for placement in grade 11
- 90 credits are required for placement in grade 12

## Option II

The New Jersey Department of Education (NJDOE) recognizes and acknowledges that all students will not achieve Core Curriculum Content Standards (CCCS) in the same manner and/or with the same level of success. To this end, the Bridgewater-Raritan Regional School District is permitted to allow students individualized learning opportunities outside of the traditional classroom that are stimulating and challenging and that enable students to meet or exceed the Core Curriculum Content Standards. This is commonly referred to as "**Option II.**" Option II allows for the design and implementation of programs to meet the needs of **all** students. Students are permitted to earn credit toward graduation through Option II learning experiences. Credits toward graduation will be awarded only to students who have completed an 8<sup>th</sup> grade program. Prior to the completion of 8<sup>th</sup> grade, Option II may be utilized for the purpose of advancement only. These experiences include, but are not limited to: interdisciplinary or theme-based programs, independent study, early college credit, magnet programs, student exchange programs, distance learning, on-line learning, work-based programs, internships, service learning, co-curricular or extra-curricular programs, and/or other structured learning experiences. In addition, Option II allows for group programs based upon specific instructional objects that meet or exceed Core Curriculum Content Standards. Participation in Option II is predicated on the application process through which students seek approval. The process for application, evaluation, and assessment is detailed below. Attainment of credit toward graduation is based on the successful completion of assessments that verify student achievement in meeting or exceeding the Core Curriculum Content Standards at the high school level.

### **Option II Credit Attainment**

Students planning to pursue course work for credit external to the traditional offerings of BRHS curriculum are required to submit a completed application to the Principal's Option II Credit Review Committee. This committee will be comprised of the High School Principal, a designated Departmental Supervisor, Supervisor of School Counseling, and a designated School Counselor. Deadlines for submission are June 1<sup>st</sup> for Summer and Fall Semester course work; January 1<sup>st</sup> for Spring Semester course work. The Principal's Option II Credit Review Committee will review each application to determine eligibility and grant approval/disapproval based on the criteria outlined. Each student's application will be reviewed on its own merit. The committee will ensure that each student is on track to fulfill graduation requirements. The Assistant Superintendent will review all decisions of the committee.

Grades for approved Option II course work will be reflected on a student's transcript with the designation of "P" (Pass) or "U" (Fail). Upon approval, policies regarding the dropping of said course work will follow those procedures as outlined by the institution providing the course work **and** the procedures as outlined in the BRHS Program of Studies. Option II course work will not be included in the calculation of a student's overall Grade Point Average (GPA). Official transcripts generated by course work taken outside of BRHS may be attached to a student's BRHS transcript. Such requests must be made through the student's assigned school counselor. Once credit has been earned in an approved Option II course, students will not be permitted to enroll in an equivalent BRHS course.

### **Credit Recovery**

Students receiving a final grade of "U" in a BRHS course do not receive credit. Students who fail to meet course requirements and/or meet attendance requirements receive a final grade of "NC" (no credit). In each case, credits towards graduation are not earned. Student options include the repeat of the course during the next school year; enrollment in an approved summer school program; or enrollment in an approved Option II alternative. Option II alternatives require approval by the Principal's Option II Credit Review Committee. Completed applications must be submitted by July 1, 2021. Registration for summer credit recovery courses must be completed by July 2, 2021. This includes traditional classroom and online credit recovery courses. All summer credit recovery courses must be completed by August 6, 2021. Students enrolled in an online credit recovery course are required to take the final exam for that course at BRHS. Final exams are available by appointment, weekdays only - August 2-6, 2021.

Credit Recovery courses require students to be enrolled for a minimum of 60 hours for a 5 credit course. Grades for completed Credit Recovery courses will be reflected on transcripts with the designation of "P" (Pass) or "U" (Fail). Approved courses dropped after the drop/add period will be recorded on BRHS transcripts as "W" (Withdrawn). Credit recovery courses are not included in the calculation of a student's overall GPA. The original course and final grade **will be** retained on the student's transcript. Appropriate credits will be applied toward graduation requirements. Credit recovery can be achieved through in-person or on-line coursework.

### Additional Credit; Acceleration Credit

A student may opt to enroll in Option II courses to include on his/her transcript and/or to accelerate a course level. A common example of accelerated coursework is the student who takes an additional mathematics course to advance to the next level of math. Additional credit, or acceleration can be achieved through in-person or on-line coursework. The following guidelines must be followed:

1. Completed applications must be received by the Principal's Option II Credit Review Committee by June 1<sup>st</sup> for enrollment in a Summer or Fall Semester course; January 1<sup>st</sup> for a Spring Semester course.
2. The course must be from an accredited institution and/or monitored by a certified staff member. Accreditation must be from a United States Department of Education recognized national or regional professional accrediting organization. Additional/Acceleration Credit courses must meet the 120-hour enrollment requirement for complete course advancement.
3. The course must be approved by the Principal's Option II Credit Review Committee.
4. Acceleration Credit courses must be completed by August 6, 2021. Students enrolled in an online, acceleration credit course are required to take the final exam for that course at BRHS. Final exams are available by appointment, weekdays only - August 2-6, 2021. Additional Credit courses must be completed within 9 (nine) months and prior to June 7, 2022. **Please note that original, full credit Physical Education courses cannot begin until September 1<sup>st</sup>. New Jersey Administrative Code requires that students must be enrolled in a Physical Education course during the school year. This requirement does not apply to Health courses.** An official transcript from the institution must be submitted promptly following the completion of the course. Grades for completed Additional/Acceleration Credit courses will be reflected on transcripts with the designation of "P" (Pass) or "U" (Fail). Approved courses dropped after the drop/add period will be recorded on BRHS transcripts as "W" (Withdrawn). Additional/Acceleration Credit courses are not included in the calculation of a student's overall GPA. Failure to submit an official transcript will result in the designation of "I" (Incomplete) on the student's BRHS transcript.
5. Permission to accelerate a course level is dependent on a final assessment as determined by the department supervisor. The assessment will be utilized to determine proficiency and the ability to succeed in the next level. The assessment does not impact the awarding of credit based on course completion. If deemed not to meet proficiency standards, credit earned will be applied as elective credit, and the student will be required to enroll in the next BRHS level course.

### College Credit

Students may opt to enroll in college level courses and apply credits earned toward high school graduation requirements. Students enrolling in college level courses must meet eligibility requirements as established by Board of Education *BOE Policy 5462, Option Two* **and** those established by the college or university. College credit can be achieved through in-person or on-line coursework. The following guidelines must be followed:

1. Completed applications must be received by the Principal's Option II Credit Review Committee by June 1<sup>st</sup> for enrollment in a Summer or Fall Semester course; January 1<sup>st</sup> for a Spring Semester course.
2. The course must be taken from a regionally accredited two or four-year college/university.
3. The course must be approved by the Principal's Option II Credit Review Committee.
4. An official transcript from the college/university must be submitted promptly following the completion of the course. Grades for completed College Credit courses will be reflected on transcripts; however, the grade will not be included in the calculation of a student's overall GPA. Approved courses dropped after the drop/add period will be recorded on BRHS transcripts as "W" (Withdrawn). Failure to submit an official transcript will result in the designation of "I" (Incomplete) on the student's BRHS transcript.

### Independent Study

The Independent Study program at BRHS is intended for individuals who seek intense study in an academic area not currently offered by the BRHS curriculum. Independent studies may not replace a course listed in the BRHS Program of Studies. Independent Study credit can be achieved through in-person or on-line coursework. The following guidelines must be followed:

1. Completed applications, Option II and Independent Study, must be received by the Principal's Option II Credit Review Committee by June 1<sup>st</sup> for enrollment in a Summer or Fall Semester Independent Study; January 1<sup>st</sup> for a Spring Semester Independent Study. Independent Study applications are in addition to the Option II application. The Independent Study application provides specific details of requirements. See application for more information.



2. The course must be approved by the Principal's Option II Credit Review Committee.
3. A BRHS certified faculty member must serve as an advisor and be secured prior to the submission of required paperwork. Advisors are voluntary participants working collaboratively with the student to develop independent study goals. The responsibilities of student and advisor are detailed in the Independent Study application.
4. The Independent Study advisor is responsible for the final evaluation of the study and must submit verification that instructional objectives have been met. Grades for Independent Study courses will be reflected on transcripts with the designation of "P" (Pass) or "U" (Fail). Approved Independent Studies dropped after the drop/add period will be recorded on BRHS transcripts as "W" (Withdrawn). Independent Study courses are not included in the calculation of a student's overall GPA. Failure to submit a report by the advisor will result in the designation of "I" (Incomplete) on the student's BRHS transcript.

## Service Learning

Students are encouraged to seek opportunities within the community to complement their education through volunteering. Under Option II, students may apply credit from Service Learning to high school graduation requirements if approved in advance by the Principal. The following guidelines must be followed:

1. Completed applications, Option II and Service Learning, must be received by the Principal's Option II Credit Review Committee by June 1<sup>st</sup> for enrollment in Summer or Fall Semester Service Learning; January 1<sup>st</sup> for Spring Semester Service Learning. Service Learning applications are in addition to the Option II application. The Service Learning application provides specific details of requirements. See application for more information.
2. The Service Learning project must be approved by the Principal's Option II Credit Review Committee.
3. The student must have an approved mentor for the project.
4. The student must complete a self-reflection and learning outcome report at the conclusion of the service learning experience and submit it to his/her mentor. The mentor will include a copy of the report with his/her evaluation.
5. The Service Learning mentor is responsible for the final evaluation and must submit verification that service learning objectives have been met including a signed log of hours the student completed during the experience. Grades for Service Learning will be reflected on transcripts with the designation of "P" (Pass) or "U" (Fail). Approved Service Learning dropped after the drop/add period will be recorded on BRHS transcripts as "W" (Withdrawn). Service Learning will not be included in the calculation of a student's overall GPA. Failure to submit a report by the mentor will result in the designation of "I" (Incomplete) on the student's BRHS transcript.
6. Service Learning credit cannot be earned for providing assistance to a staff member.
7. A student may earn up to twenty (20) Service Learning Credits during his/her high school career.

## Alternative Physical Education

Students may pursue opportunities to meet the CCCS for Physical Education through participation in co-curricular or extra-curricular programs and/or through other structured learning experiences that involve substantial physical activity/exertion. Students should apply for consideration through the academic supervisor and Principal's Option II Committee. If approval is given, the student will be assigned a study hall during the period that would be scheduled for Physical Education during the marking period(s) for which an alternative experience has been approved. The student will be required to participate in the Health curriculum during the marking period in which Health would be scheduled.



## AP/Honors Courses

AP/Honors courses are available in specified courses in English, World Languages, Mathematics, Science, Fine Arts, Business, Performing Arts and Social Studies. These courses offer enrichment both in scope and exploration of material presented.

Students who wish to enroll in AP/Honors level courses must meet eligibility criteria as indicated in the next sections.

## 9th Grade Honors Courses

The following criteria will serve as the basis for eligibility to enroll in 9<sup>th</sup> grade Honors level courses:

- Students currently enrolled in and maintaining a "B-" or higher average in Grade 8 E LAL will automatically be eligible to "roll up" into English 9 Honors.
- Students currently enrolled in and maintaining a "B-" or higher average in Grade 8 E Science will automatically be eligible to "roll up" into Biology Honors.
- Students currently enrolled in and maintaining a "B-" or higher average in Grade 8 E Social Studies will automatically be eligible to "roll up" into World Civilizations II Honors.
- Students currently enrolled in and maintaining an "A-" or higher average in a Grade 8 World Language course will be eligible to "roll up" into a World Language level II Honors course.
- Students may opt to enroll in an Honors level mathematics without regard for current grade. The decision to enroll in an Honors level mathematics course should be made based on the individual student's desire to challenge him/herself.
- Any students receiving an "A-" or higher grade for **both** Marking Period 1 and Marking Period 2 can pre-schedule for Honors in the corresponding subject area. Final scheduling of the Honors level course is contingent upon a year-end (final) grade of "A-" or higher (excluding mathematics).
- Students not meeting initial eligibility requirements and who have achieved a year-end (final) grade of "A-" or higher may submit a Course Request Change Form for Honors in the corresponding subject area. **Change Forms must be submitted by July 1, 2021, and will not be accepted after this date.**

## 10<sup>th</sup>, 11<sup>th</sup> and 12<sup>th</sup> Grade AP/Honors Courses

The following criteria will serve as the basis for eligibility to enroll in AP/Honors level courses:

- Students currently enrolled in an AP/Honors course and maintaining a "B-" or higher average are eligible to automatically "roll up" into the next year's AP/Honors course in the corresponding subject area.
- Students currently enrolled in an Academic level course and receiving an "A-" or higher grade for both Marking Period 1 and Marking Period 2 can pre-schedule for an AP/Honors course in the corresponding subject area. Final scheduling of the AP/Honors level course is contingent upon a year-end (final) grade of "A-" or higher.
- BRHS offers mathematics courses at the academic, honors and advanced placement levels. It is the belief of the district that all students should be offered the opportunity to take rigorous mathematics courses if desired. As such, there are no specific grades needed as prerequisites for honors and advanced placement mathematics courses. Decisions on levels should be made in conjunction with the school counselor and be based on student desire to challenge themselves in mathematical reasoning, modeling and application.
- Students not meeting initial eligibility requirements and who have achieved a year-end (final) grade of "A-" or higher may submit a Course Request Change Form for AP/Honors in the corresponding subject area. **Change Forms must be submitted by July 1, 2021, and will not be accepted after this date.**

## Retention in AP/Honors Level Courses

Students in grades 9-12 enrolled in an AP/Honors course have the responsibility to maintain a grade of at least a "B-" in that course. The following level changes: from AP to Honors; from AP to Academic; and from Honors to Academic are permitted through the 3<sup>rd</sup> school day after the posting of grades at the close of the first (1<sup>st</sup>) marking period (*BOE Regulation 2464, Gifted and Talented Students*).

All students should be aware of the following regarding AP/Honors level course changes:

- Students have the **1<sup>st</sup> MARKING PERIOD** to determine the appropriateness of level placement. Course level changes are permitted through the 3<sup>rd</sup> school day following the posting of grades at the close of the first (1<sup>st</sup>) marking period. After the completion of the 1<sup>st</sup> Marking Period, students who have not opted for a level change or who have not been reassigned, **will remain in their current course level placement for the duration of the school year. Mid-year level changes will not be permitted.**
- Prior to the end of the 1<sup>st</sup> marking period, students whose projected grade is a "C+" or lower, shall be counseled by the department supervisor, the teacher, and/or the school counselor, and the parent and student will make a decision regarding placement. **If a student is reassigned to another full year course, the student will begin the course with the letter grade associated with the weighted grade of the higher level course.** The student will receive grades for the second, third, and fourth marking periods from the receiving teacher. The transcript will reflect the name of the course the student was enrolled in at the conclusion of the year.
- Students who earn a grade of "D+" or lower in an AP or Honors course for the 1<sup>st</sup> Marking Period shall be counseled by the department supervisor, the teacher, and/or the school counselor, and the parent and student will make a decision regarding continued placement which can include moving into a course that can be a minimum of one academic level lower (e.g., AP to Honors, Honors to Academic). The grade from the AP/Honors level course will move with the student to the new course with the weighted grade of the higher level course. The student will receive grades for the second, third, and fourth marking periods from the receiving teacher. The transcript will reflect the name of the course the student was enrolled in at the conclusion of the year.
- Continued eligibility for the next school year in an AP/Honors level course is contingent upon the receipt of a final grade (transcript grade) of "B-" or higher in the corresponding subject area. Students earning a final grade of "C+" or lower will be ineligible to continue in that subject area. Students reserve the right to submit an Appeal Form at the conclusion of the school year to petition for continued enrollment. Approval of the appeal is contingent on the extenuating circumstances presented. **Appeal Forms must be submitted by July 12, 2021. Appeals will not be accepted after this date.**

## Advanced Placement Program

The Advanced Placement (AP) Program, in cooperation with the CollegeBoard, extends educational opportunities to students who wish to be challenged by college-level courses. Appropriate credit and placement at many colleges may occur as a result of scores achieved on Advanced Placement Examinations.

Currently, Advanced Placement courses are available in Art History, Biology, Calculus, Chemistry, Chinese, Computer Science, Computer Science Principles, English, Environmental Science, European History, French, German, Government & Politics, Italian, Latin, Macroeconomics, Microeconomics, Music Theory, Physics, Probability & Statistics, Psychology, Research, Seminar, Spanish, Studio Art, and United States History. Students accepted into the Advanced Placement courses are expected to take the AP examination at the end of the year.

Please note that all students must meet eligibility requirements for AP Macroeconomics and/or AP Microeconomics regardless of current enrollment in any AP/Honors level course. Eligibility is based upon final grades earned in **both** English and Mathematics courses. Grades of "B-" or higher must be earned in AP/Honors English/Mathematics level courses or "A-" or higher in Academic level English/Mathematics courses.

Retention in Advanced Placement courses follows the Retention in AP/Honors Level Courses definition (see above). Students enrolling in Advanced Placement courses that do not have a respective academic course and seek to drop the Advancement Placement course after the allotted time in drop/change policy are eligible for a withdraw (W) or may remain in the AP course to earn a grade higher than a failure.

## AP Capstone Diploma™

**AP Capstone™** is a diploma program based on two AP courses: **AP Seminar** and **AP Research**. These yearlong courses focus on developing the critical thinking, research, collaboration, time management, and presentation skills needed for college-level work. **AP Capstone™** fosters the research, argumentation, and communication skills at the core of college readiness and lifelong learning. **AP Capstone™** lets students show colleges that they have challenged themselves academically and illustrate their passion and interest in specific research topics. Students may earn an **AP Capstone™** designation on his/her diploma following the successful completion of **AP Seminar**, **AP Research** [earned AP Exam score of three (3) or higher on each] and the successful completion of any combination of four (4) AP courses [earned AP Exam score of three (3) or higher on each]. **AP Seminar** and **AP Research** course descriptions are available on page 48.

### AP Capstone

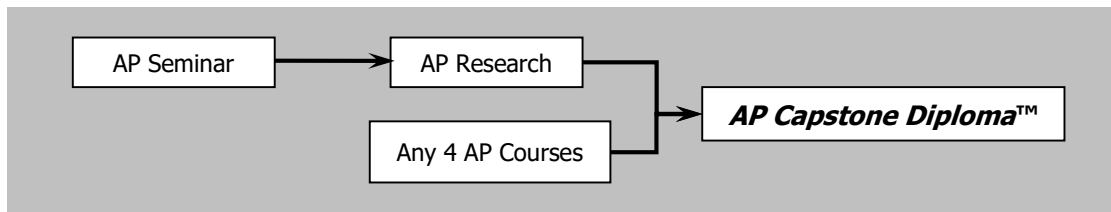

## Academic/Standard Courses

Academic courses are designed to prepare students for the demands of higher learning beyond high school. Whereas standard level courses, which are placement decisions made by department supervisors through collaboration with school counselors, are designed to meet the needs of students who would benefit from a more moderate pacing of the curriculum in addition to a focus on skill mastery. If a standard level course is appropriate for a student, the school counselor will bring it to his or her attention.

## National Honor Society

Membership in the National Honor Society is an honor bestowed upon a student. Selection for membership is by a faculty council and is based on leadership, service, character, and outstanding scholarship (minimum 3.5 grade point average rounded to the hundredths on a 4.33 weighted scale: all courses are factored in computing grade point average).

NOTE: *Refer to student handbook for further information.*



## Academic Achievement Certification Program

The Academic Achievement Certificate Program is designed to provide a list of the knowledge that a student has acquired in a certain area of study. Each certificate will list the area of concentration and the courses taken. The certificate will be signed by the Principal and the department supervisor and will be suitable for college and business entrance portfolios. To receive a certificate, the student must achieve a grade of "C" or better in the courses listed under each area noted below. With a wise choice of electives, a student could qualify for two certificates. **The Academic Achievement areas and their required courses are:**

### Computer Technology

- App Development
- Computer Applications & Keyboarding
- Photo Editing and Web Design
- Desktop Publishing & Multimedia Presentations
- Computer Repair & Maintenance
- Photo Editing for Business
- Programming for Business

### Accounting Technology

- Accounting I
- Accounting II
- Computer Applications & Keyboarding
- Financial Planning or Introduction to Business
- International Business or Entrepreneurship & Business Management
- Photo Editing and Web Design

### Business Administration

- Business & Criminal Law or Introduction to Business
- International Business or Entrepreneurship & Business Management
- Financial Planning
- Introduction to Business or Economics
- Computer Applications & Keyboarding or Photo Editing and Web Design
- Introduction to Marketing through Social Media

### Office Technology

- Computer Applications & Keyboarding
- Career Exploration and Awareness
- Academic Internship Program
- Leadership & Philanthropy

## Academic Internship Program

The Academic Internship Program is a senior-level program designed for the student who wants to prepare for a career by gaining valuable work experience in a business environment. This program is designed to provide on-the-job training in an office-related occupation that corresponds with a student's career objective. This unique program capitalizes on a high level of student motivation and gives the student the opportunity to "learn by doing." Please refer to page 58 for a course description under Business Education.

The internship provides background in a particular career for students planning to further their education following graduation from high school. The course is designed to provide students with a year of valuable work experience that will put them ahead of other beginning college freshmen.

Students are to report to work placements for the final two periods of the day. In addition to the afternoon work experience, students will attend a related class in the morning to further develop their office skills and to obtain guidance in adjusting from the school environment to the world of work.

An application is required for admission to the program. Please submit the completed application to the program coordinator or to the school counselor. Students admitted must be employed within the first two (2) weeks of the start of school. Failure to be employed will result in removal from the program and the student completing a full (9 period) schedule.

## Connections with Raritan Valley Community College

Opportunities are available to Sophomore, Junior, and Senior students to earn college credit through Raritan Valley Community College while enrolled in High School. Students completing courses will receive an official Raritan Valley transcript. Please note that college credit is accepted at the discretion of individual institutions and may not be directly transferable to other institutions of higher learning.

In order to be eligible, a student must be of at least Sophomore status, have a cumulative GPA of at least a 3.0, satisfactory scores on Raritan Valley placement tests or minimum scores on SAT, parental permission, completion of pre-requisites, and school counselor approval.

Three options are available to eligible students: Concurrent Enrollment (CEP); Dual Enrollment; or Early Credit. Bridgewater-Raritan High School currently offers Concurrent Enrollment courses through its English department entitled English Language and Literature IV CEP (please refer to page 29 for a course description). Enrollment in Early Credit courses is dependent on the availability of the student and college. Dual Enrollment and Early Credit courses may be applied toward high school graduation requirements (please refer to Option II guidelines). Please see your school counselor for additional information or for an application. More information is also available at the following link:

<http://www.raritanval.edu/pstudents/earlycredits.html>

## Connections with Rider University

Collaboration between Rider University Communications Department and Bridgewater-Raritan's Media Communications Faculty has resulted in the opportunity for students to earn college credits. Students completing the necessary coursework can apply for three credits in ***COM 131 Fundamentals of Video Production***, which will appear on an official Rider University transcript. Please note that college credit is accepted at the discretion of individual institutions and may not be directly transferable to other institutions of higher learning.

In order to be eligible, a student must complete Film & Video Editing I through IV prior to graduation with a grade of "B" or better in all courses and apply within 27 months of graduation from Bridgewater. Once they have completed all of the courses, they can apply for Advanced Standing Credit through Rider's Department of Communications and Journalism.

It is abundantly apparent in this age of information that media plays an important role in the development of societal norms and mores. As the field of Media Communications increasingly expands, it continues to shape our society and affect careers beyond the discipline of communications alone. The quality of Bridgewater's Media Communications curriculum is demonstrated by Rider University's willingness to convey university level credits on our students. For more information, please see a faculty member of the Media Communication Department or visit following link:

**[Program for Advanced Scholastic Standing \(PASS\)](#)**

## Connections with Fairleigh Dickinson University

Collaboration between Fairleigh Dickinson University's Middle College and Bridgewater-Raritan's Accounting II Business Education faculty has resulted in the opportunity for students to earn college credits. Students completing the necessary coursework can apply for 3 credits in ***Acct 2021 Introduction to Financial Accounting***, which will appear on a regular Fairleigh Dickinson University transcript. These credits will be good at both FDU and accepting universities; note that college credit is accepted at the discretion of individual institutions.

In order to be eligible, a student must complete Accounting I & II prior to graduation with a grade of B or better. Students will complete necessary application and tuition fee to FDU's Middle College in September at the start of Accounting II. Teacher then reports grades in June to FDU for approval.

It is our belief in a capitalist economic system that creates a high standard of societal living and thus drives many high school students to study Business at the college level. The quality of Bridgewater's Business Education curriculum is demonstrated by Fairleigh Dickinson's willingness to convey university level credits on our students. For more information, please see a faculty member of the Business Education Department or visit the following link:

**[FDU – Middle College](#)**

## Preparation for College Entrance

The philosophies of education, specific course requirements, and other qualifications for acceptance vary among the nation's colleges and universities. All, however, recognize the desirability of a broad education with a strong foundation in the traditional, solid academic subjects.

Students are evaluated for admission not only in terms of grades achieved, but also with respect to the strength of the academic program undertaken. Students are encouraged to take the strongest possible academic program available within his/her own personal limitations during all four years of high school. A rigorous secondary school preparation remains the best means by which a student can be assured of maximizing the benefits to be derived from a challenging college education.

## Admission to College

Admission to college can be quite competitive. In order to ensure consideration by a college admissions committee, students are encouraged to begin planning for college in the eighth grade by giving serious deliberation to course selections for high school.

Each college has its own admission requirements and sets its own priorities. When students apply to college, the Admissions Office compiles information regarding specific applicants in an individual folder. This information is reviewed and given much consideration by the college as it makes decisions regarding admissions. There are four main areas normally considered:

1. Academic record and school recommendation
2. Standardized test scores
3. Activities
4. Unique characteristics of the applicant

## NCAA College-Bound Student-Athletes

The National Collegiate Athletic Association (NCAA) has specific academic requirements for students to be eligible to participate in athletics at the Division I or II collegiate level. **It is the responsibility of the student and parent/guardian to ensure compliance with all NCAA eligibility requirements. It is recommended that students/parents/guardians consult with the Counseling Department beginning with 9<sup>th</sup> grade course selection.** NCAA eligibility requirements are based on course enrollment (core courses), test scores (ACT/SAT), and core-course grade point average (GPA). Minimum requirements are based on collegiate level of play – Division I or II.

For more information, please visit the NCAA Eligibility website at:

[http://web3.ncaa.org/ECWR2/NCAA\\_EMS/NCAA\\_EMS.html#](http://web3.ncaa.org/ECWR2/NCAA_EMS/NCAA_EMS.html#).

You may also access a quick reference sheet of initial eligibility requirements at:

[http://fs.ncaa.org/Docs/eligibility\\_center/Quick\\_Reference\\_Sheet.pdf](http://fs.ncaa.org/Docs/eligibility_center/Quick_Reference_Sheet.pdf)

## Class Rank

The academic environment in Bridgewater-Raritan Regional High School is very challenging. The majority of our students meet that challenge by earning exemplary grades. However, we believe the comparisons among students inherent in rank-in-class calculations unnecessarily increase competition within the school; further, we believe that our students' levels of achievement are not equitably or fully communicated by this single transcript statistic. **The Bridgewater-Raritan Board of Education Policy, therefore, precludes the reporting of class rank for the college application process. Note, upon college acceptance class rank will be made available if requested by the college/university to determine college financial aid and scholarship eligibility. This information will only be made available to the inquiring institution.**

## Department of School Counseling

### ***What is the Department of School Counseling, and what does it do for students?***

The Department of School Counseling consists of a Supervisor of School Counseling, School Counselors and clerical staff all dedicated and trained to provide counseling and educational services for students. These services can be categorized into three major functions: 1) counseling; 2) consulting; and 3) information management.

### ***What is a School Counselor?***

High school years are full of growth, promise, excitement, frustration, disappointment, and hope. It is the time when students begin to discover what the future holds for them. School counselors enhance the learning process and promote academic achievement. School counseling programs are essential for students to achieve optimal personal growth, to acquire positive social skills and values, to set appropriate career goals, and to realize full academic potential to become productive, contributing members of the world community. The professional high school counselor holds a Master's degree and requires state certification in school counseling.

### ***What will my counselor do for me?***

The services that you receive from your counselor are varied and to a great extent depend upon you. You should never hesitate to see your counselor for any reason. Depending on your individual needs, your counselor can help: assess your strengths and limitations; assist in decisions; discover special talents and abilities; aide in planning your education; decide on a career; ... and more!

### ***When can I see my counselor?***

Any time you are free, drop in on your counselor, for anything from a quick question to a personal conference. Because counselors deal with many students and are involved in other educationally related activities, they are not always free to see you instantly. To ensure that your counselor is available and free to see you, you should sign up for a conference in the main School Counseling Office. If you feel it is an emergency, please indicate that to the secretaries. (Some hints: Don't come from a class without the teacher's permission. Don't leave without a pass ... and ... Don't sit for periods waiting to see your counselor if he/she is not expecting you.)

### ***What basic School Counseling services does my counselor provide each year?***

By now you probably understand the extent of the services offered and how they can meet your individual needs and requests; however, there are certain basic services offered to everyone, each year.

**For Freshmen:** transitioning to high school; discussing your academic progress with an emphasis on study skills and time management; planning; and selecting courses for your sophomore year.

**For Sophomores:** reviewing your academic progress; extensive career planning; helping to plan your future; and selecting courses for your junior year.

**For Juniors:** discussing your progress with emphasis on your strengths and limitations; planning for further education; attending college and career conferences; selecting courses for your senior year; and providing informational services.

**For Seniors:** in-depth planning meetings with counselors; providing informational services; assisting with applications for further education, jobs and scholarships; and discussing academic progress through graduation.



## Special Services Programs

Special Services are designed to support students who have been identified as having learning differences. Following a Child Study Team evaluation and the determination of eligibility for special education and related services, an Individual Education Program (IEP) is developed by members of an IEP team, which includes a member(s) of the Child Study Team, parent(s), teacher(s), and the student.

A variety of services are offered at Bridgewater-Raritan High School, with determination for services based on the individual needs of the student. These services include:

1. In-Class Resource is a collaborative teaching model which provides supportive services to students with IEPs in the general education environment. Students are expected to meet the expectations of the course requirements. Students may require accommodations or modifications as determined by the IEP team.
2. Resource program replacement instruction occurs outside the general education classroom in a small group setting. Students are expected to complete the requirements for the course based on the general education requirements. Instructional pacing, reteaching of skills, and a lower teacher-student ratio enables student to progress through the curriculum.
3. The Work Study Program is offered for students in their junior or senior year. Students in the Work Study Program progress toward a career goal and earn graduation credit through a combination of classroom job-related instruction and part-time employment. Students are assisted with job placements. The special education teacher supervises each student by visiting job sites and meeting with job supervisors.
4. Departmentalized content area courses are designed to support students with developmental disabilities. Classes include instruction in Language Arts, Mathematics, Sciences, Social Studies, Employment Orientation and Life Skills. Employment Orientation provides students with transition from school to work experiences and helps develop positive work attitudes and ethics. Students are given opportunities to work in various on-campus job sites, some of which include office occupations, mail delivery, and food services. Additionally, Career and Community Exploration and the School to Employment Program (STEP) offer students the opportunity to job-sample in the community at supported work-sites.
5. The School to Employment Program (STEP) is a transitional class for students who require supervised assistance in employment. The students in the STEP program participate in job sampling opportunities in a variety of community work sites with related employment activities at BRHS. They are supported by certified special education teachers and paraprofessional job coaches.

All special education classes are instructed by teachers holding the appropriate NJ certifications.



## Master Schedule

The high school's master schedule and staffing patterns are determined by the course selections of the students. Every attempt is made to accommodate each student's requests. However, due to the complexities inherent in building a master schedule for a school our size, conflicts arise which result in the school's inability to fulfill all requests. Board of Education policy indicates that each course must have a minimum of 15 students to be offered. There may be occasions when a course will not be offered due to insufficient enrollment. This will necessitate the selection of an alternate request. Students are provided an opportunity to resolve conflicts within their schedules during the summer prior to the beginning of school. Following the start of school, schedule changes must follow the procedures outlined below.

## Scheduling Procedures

The process of selecting an academic program is one in which many people are involved and which requires several months of preparation and consultation. Class size considerations and staffing are determined by initial student course requests. Student course selections are made after serious deliberation among student, parents, faculty, and counselor. The selection program is designed to meet the student's personal and educational needs and goals. All students will engage in an online registration process in which core (English Mathematics, Science, Social Studies) content and elective course requests are selected by the individual student. Incoming freshmen (current 8<sup>th</sup> grade students) will register for elective courses only during the week of February 1-7, 2021. Upper classmen, grades 9-11, will register for all courses during the period February 12-22, 2021. Changes to individual student course requests will not be accepted after the close of scheduling meetings with assigned school counselor, therefore, it is essential that the original selections are given careful and thoughtful consideration. Scheduling meetings with school counselors will begin on February 23, 2021, and conclude on March 26, 2021. Changes to course requests will not be permitted after this date. Students will receive a copy of their 2021-2022 schedules prior to the start of school. Please note that the schedule received is tentative and subject to change without notice. The basis for such changes are a result of systemic needs, e.g., to balance sections of courses, programmatic changes, and staffing patterns.

Once courses have been selected, the need for program changes is recognized only under special circumstances. Scheduling problems/errors, and course conflicts are given the highest priority. The following illustrates the type of schedule changes permitted:

**Type 1 – Scheduling Error** adjustments should be made as soon as possible. Examples of **Type 1** changes are:

- period or course conflicts
- data entry error, e.g. student has wrong course on schedule
- absence of a lunch
- open period

**Type 2 - Program Change:**

- student going into or out of a vo-tech sharetime program
- approved early graduation
- student completed an approved Option II program (Credit Recovery and/or Accelerated Credit) that necessitates a modified schedule
- student adding an approved independent study program or service learning experience

**Type 3 - Departmental Change**

- level changes, e.g. French II Academic to French II Honors, or Algebra I to Essentials of Algebra I etc.

Type 3 changes take place only after consultation with the student, parent, counselor, teacher, and supervisor.

**The policy of Bridgewater-Raritan High School is not to make preference-based or lateral course changes.** Examples are, but not limited to: requests for a different teacher; requests to change lunch to a different period; request to enroll in an academic course earlier (or later in the day); sibling had an unpleasant experience with a particular teacher.

## Procedure for Dropping a Course

The dropping of a course is a serious matter and is generally discouraged; such an action should be done only after much thought and consultation takes place. The request to drop a course must be in writing by the parent or guardian unless the student is his/her own agent.

### ➤ Semester Courses

- Requests to drop a semester course will be considered through the first two (2) weeks after the start of the first and/or third marking periods provided the student would still be scheduled for 35 credits, a minimum of seven (7) courses are scheduled in the semester (*BOE Policy 5410, Promotion and Retention*), (not applicable to Seniors), has the permission of the parent/guardian, and has consulted with his/her assigned counselor. This course will be deleted.
- After the two (2) week period courses may be dropped provided the student would still be scheduled for 35 credits, a minimum of seven (7) courses are scheduled in the semester (*BOE Policy 5410, Promotion and Retention*) (not applicable to Seniors), has the permission of the parent/guardian, and has consulted with his/her assigned counselor and the department supervisor. The transcript will then indicate "W" (withdrawn).

### ➤ Full-Year Courses

- Requests to drop a full-year course will be considered through the third school day following the posting of grades at the close of the first marking period and provided the student will still be scheduled for 35 credits, a minimum of seven (7) courses are scheduled in the semester (*BOE Policy 5410, Promotion and Retention*) (not applicable to Seniors), has the permission of the parent/guardian, and has consulted with his/her assigned counselor and the department supervisor. The course will be deleted.
- After the third school day following the close of the first marking period courses may be dropped provided the student would still be scheduled for 35 credits, a minimum of seven (7) courses are scheduled in the semester (*BOE Policy 5410, Promotion and Retention*) (not applicable to Seniors), has the permission of the parent/guardian, and has consulted with his/her assigned counselor, teacher and the department supervisor. The transcript will then indicate "W" (withdrawn).
- Voluntary level changes in which a student moves from a more rigorous level to a less rigorous level (e.g. moving from Advanced Placement to Honors or Honors to Academic) may only take place through the third day following the posting of grades at the close of the first (1<sup>st</sup>) marking period (*BOE Regulation 2464, Gifted and Talented Students*).

## Procedure for Entering a Course

A student may request to enter a course provided the student has parental approval and the course has space for an additional student.

### ➤ Semester Courses

- A student may enter a new course up to two (2) weeks after the start of the semester. Priorities for Fall semester will be as follows: Seniors may begin adding a course on September 9<sup>th</sup>; Juniors on September 13<sup>th</sup>; Sophomores and Freshmen on September 15<sup>th</sup>; ending on September 22<sup>nd</sup>. For the Spring semester: Seniors on February 2<sup>nd</sup>; Juniors on February 4<sup>th</sup>; and Sophomores and Freshmen on February 7<sup>th</sup>; ending on February 15<sup>th</sup>.

### ➤ Full Year Course

- A student may enter a new full-year course up to four (4) weeks after the start of the school year. This includes entering a more rigorous level of an existing course, providing the student has met the eligibility requirements. (e.g., moving from Academic to Honors or Advanced Placement). The add period will cease on October 6<sup>th</sup>.

### ➤ Auditing Courses\*

- Students will be given the privilege of auditing courses under the following circumstances:
  1. Permission from the parent
  2. Permission from the teacher
  3. Permission from the department supervisor
  4. Permission from the counselor
- Requests to audit semester courses will be considered through the seventh week of the semester.
- Requests to audit full-year courses will be considered through the twelfth week of the course.
- Courses audited will be noted on report cards and transcripts in the grade column as "AU".

**\*Auditors have the same responsibilities in the class as any other student and may not detract from the performance of the regular students in the class.**

## Subject Offerings by Grade

Students may generally elect any subject listed in a previous grade as long as they have completed all prerequisites for that subject.

**Key:** *High School Credit* = Credit toward high school diploma      **X** = Grade in which course is offered.

**S** = Standard Level    **A** = Academic    **H** = Honors    **AP** = Advanced Placement    **CEP** = Concurrent Enrollment Program

Course Numbers	Course	High School Credit	Grade level course is offered				Page Number
			9	10	11	12	
<b>English</b>							
HLA50539	<b>AP</b> English Language & Composition III	5			X		27
HLA50570	<b>AP</b> English Literature and Composition IV	5				X	28
HLA10541 (A) HLA30540 (H) HLA60569 (S)	English Language & Literature I – A, H, S	5	X				28
HLA10555 (A) HLA30544 (H) HLA60599 (S)	English Language & Literature II – A, H, S	5		X			28
HLA10558 (A) HLA30557 (H) HLA60547 (S)	English Language & Literature III – A, H, S	5			X		28-29
HLA10562 (A) HLA30561 (H) HLA60563 (S)	English Language & Literature IV – A, H, S	5				X	28-29
HLA10577 (A) HLA30574 (H)	English Language & Literature IV CEP – A	5				X	29
HLA60748	ESL I – Grammar & Conversation	10 Elective	X	X	X	X	29
HLA60750	ESL II – Grammar & Conversation	10 Elective	X	X	X	X	29
HLA60747	ESL III – Reading & Writing	5 Elective	X	X	X	X	29
HLA60462	English Language & Literature SI	5 English	X	X	X	X	29
HLA60551	English Language & Literature T I	5 English	X	X	X	X	30
HLA60596	English Language & Literature T II	5 English	X	X	X	X	30
<b>(Electives)</b>							
HLA20505	American Film Study	2.5			X	X	30
HLA40555	Comprehensive Creative Writing – A	5			X	X	30
HLA20568	Drama	2.5	X	X	X	X	30
HLA20575	Forensics – A	2.5	X	X	X	X	30
HLA20555	Introduction to Creative Writing – A	2.5	X	X	X	X	31
HLA20569	Introduction to Screenwriting	2.5			X	X	31
HLA20566	Journalism – A	2.5	X	X	X	X	31
HLA20597	Kid Lit Literacy	2.5	X	X	X	X	31
HLA60589	Literacy Support 11	5			X		31
HLA60593	Literacy Support 12	2.5				X	31
HLA20554	LP: Lyrical Poetry	2.5	X	X	X	X	31
HLA40553	Publication Development & Production	5	X	X	X	X	32
HLA20595	Reading Animation	2.5	X	X	X	X	32
HLA20578	SAT Preparation	2.5			X	X	32
HLA20567	Speech – A	2.5	X	X	X	X	32
HLA20576	Theater Production	2.5	X	X	X	X	32

Course Numbers	Course	High School Credit	Grade level course is offered				Page Number
			9	10	11	12	
<b>Mathematics</b>							
HMA50220	<b>AP</b> Calculus AB	5			X	X	34
HMA50227	<b>AP</b> Calculus BC	5			X	X	34
HMA50200	<b>AP</b> Computer Science A	5		X	X	X	38
HMA50201	<b>AP</b> Computer Science Principles	5		X	X	X	38
HMA50252	<b>AP</b> Probability & Statistics	5			X	X	34
HMA10206	Algebra I – A	5	X				35
HMA61000	Algebra I	10	X				35
HMA60219	Algebra I SI - A	10	X	X	X	X	35
HMA10210	Algebra II – A	5	X	X	X		36
HMA30211	Algebra II – H	5	X	X			36
HMA10263	Calculus – A	5			X	X	36
HMA10220	Algebra III/Trigonometry	5		X	X	X	36
HMA10207	Geometry – A	5	X	X			35
HMA30209	Geometry – H	5	X	X			35
HMA60220	Geometry SI – A	5	X	X	X	X	35
HMA10202	Mathematics SI - A	5	X	X	X	X	34
HMA10229	Precalculus – A	5		X	X	X	36
HMA30214	Precalculus – H	5		X	X		36
HMA10265	Probability and Statistics – A	5			X	X	36
<b>(Electives)</b>							
HMA20556	Advanced Mathematics: Calculus III	2.5				X	37
HMA20555	Advanced Mathematics: Differential Equations	2.5				X	37
HMA50620	Advanced Mathematics: Topics in Engineering	5				X	37
HMA50650	Advanced Topics in Computer Science	5			X	X	38
HMA20221	Computer Science I	2.5	X	X	X	X	38
HMA20222	Computer Science II	2.5	X	X	X	X	39
HMA60203	Mathematics III Workshop	2.5			X		37
HMA60204	Mathematics IV Workshop	2.5				X	37
HLA20578	SAT Preparation	2.5			X		37
<b>Science</b>							
HSC50323	<b>AP</b> Biology	7			X	X	40
HSC50324	<b>AP</b> Chemistry	7			X	X	40
HSC50328	<b>AP</b> Environmental Science	6			X	X	40
HSC50329	<b>AP</b> Physics 1	6			X	X	41
HSC50330	<b>AP</b> Physics 2	6			X	X	41
HSC50365	<b>AP</b> Physics C	7			X	X	41
HSC10303	Biology – A	6	X				41
HSC30305	Biology – H	6	X				41
HSC60304	Biology – S	5	X				41
HSC10309	Chemistry – A	6		X	X		41
HSC30310	Chemistry – H	6		X	X		42
HSC60311	Chemistry – S	5		X	X		42
HSC10312	Conceptual Physics – A	6			X	X	42
HSC10313	Physics – A	6			X	X	42
HSC30314	Physics – H	6			X	X	42
HSC10380	Earth & Space Science – A	5			X	X	42

Course Numbers	Course	High School Credit	Grade level course is offered				Page Number
			9	10	11	12	
<b>Science (cont.)(Electives)</b>							
HSC20322	Astronomy – A	2.5		X	X	X	43
HSC10346	Environmental Science – A	5			X	X	43
HSC20359	Exercise Physiology – A	2.5		X	X	X	43
HSC20374	Forensic Science – A	2.5		X	X	X	43
HSC20362	General Anatomy & Physiology – A	2.5		X	X	X	43
HSC30814	Genetics – H	3			X	X	44
HSC40363	Human Anatomy & Physiology	5		X	X	X	44
HSC30358	Introduction to Engineering - H	7			X	X	44
HSC20368	Marine Biology - A	2.5		X	X	X	44
HSC10317	Medical Laboratory Technique	5			X	X	44
HSC20363	Medical Physiology – A	2.5		X	X	X	44
HSC10335	Microbiology – H	5		X	X	X	45
HSC20320	Oceanography/Meteorology – A	2.5		X	X	X	45
HSC30361	Organic & Biochemistry – H	6			X	X	45
<b>Social Studies</b>							
HSS50121	<b>AP</b> U.S. History I	5		X	X		46
HSS50120	<b>AP</b> U.S. History II	5			X	X	46
HSS60100	Social Studies SI	5	X	X	X	X	46
HSS10108 (A) HSS30107 (H) HSS60110 (S)	U.S. History I – A, H, S	5		X	X		47
HSS10112 (A) HSS30111 (H) HSS60113 (S)	U.S. History II – A, H, S	5			X	X	47
HSS10123 (A) HSS30122 (H) HSS60124 (S)	World Civilizations II – A, H, S	5	X				47
<b>(Electives)</b>							
HSS50136	<b>AP</b> European History	5			X	X	47
HSS50102	<b>AP</b> Government & Politics	5			X	X	48
HSS50139	<b>AP</b> Psychology	5			X	X	48
HSS50151	<b>AP</b> Research	5				X	48
HSS50150	<b>AP</b> Seminar	5			X	X	48
HSS20555	Advanced Social Studies: Abnormal Psychology	2.5				X	49
HSS20556	Advanced Social Studies: Social Psychology	2.5				X	49
HSS20118	American Law – A	2.5		X	X	X	49
HSS0155	Civics	2.5	X	X	X	X	49
HFA20101	Cultural Ceramics	2.5	X	X	X	X	49
HSS20115	Economics Today	2.5	X	X	X	X	50
HSS10131 (A) HSS30114 (H)	Global Studies – A, H	5				X	50
HSS20114	Historical Exploration	2.5			X	X	50
HSS20116	Human Development – A	2.5		X	X	X	50
HSS20145	Pop Culture: 20 <sup>th</sup> Century	2.5		X	X	X	50
HSS20117	Sociology – A	2.5		X	X	X	50
HSS20142	Women’s Studies: Evolving Image of Women – A	2.5	X	X	X	X	50
HSS20143	Women’s Studies: Social Change: Changing Gender Roles – A	2.5	X	X	X	X	51

Course Numbers	Course	High School Credit	Grade level course is offered				Page Number
			9	10	11	12	
<b>World Languages</b>							
HWL50485	<b>AP</b> Chinese Language	5			X	X	52
HWL50432	<b>AP</b> French Language	5			X	X	52
HWL50499	<b>AP</b> German Language	5			X	X	52
HWL50406	<b>AP</b> Italian Language	5			X	X	52
HWL50417	<b>AP</b> Latin	5			X	X	52
HWL50431	<b>AP</b> Spanish Language	5			X	X	52
HWL10439 (I-A) HWL10443 (II-A) HWL30478 (II-H) HWL10463 (III-A) HWL30448 (III-H) HWL10449 (IV-A) HWL30455 (IV-H) HWL10492 (V-A)	Chinese I, II, III, IV, V – A  Chinese II, III, IV – H	5	X	X	X	X	52-53
HWL10411 (I-A) HWL10412 (II-A) HWL30470 (II-H) HWL10414 (III-A) HWL30471 (III-H) HWL10416 (IV-A) HWL30472 (IV-H) HWL10494 (V-A)	French I, II, III, IV, V – A  French II, III, IV – H	5	X	X	X	X	52-53
HWL10419 (I-A) HWL10420 (II-A) HWL30473 (II-H) HWL10422 (III-A) HWL30474 (III-H) HWL10424 (IV-A) HWL30475(IV-H) HWL10498(V-A)	German I, II, III, IV, V – A  German II, III, IV – H	5	X	X	X	X	52-53
HWL10408 (I-A) HWL10409 (II-A) HWL30418 (II-H) HWL10410 (III-A) HWL30442 (III-H) HWL10438 (IV-A) HWL30450 (IV-H) HWL10415 (V-A)	Italian I, II, III, IV, V – A  Italian II, III, IV - H	5	X	X	X	X	52-53
HWL10427 (I-A) HWL10428 (II-A) HWL30446 (II-H) HWL10429 (III-A) HWL30477 (III-H) HWL10430 (IV-A) HWL30425 (IV-H) HWL10421 (V-A)	Latin I, II, III, IV, V – A  Latin II, III – H, IV – H	5	X	X	X	X	52-53

Course Numbers	Course	High School Credit	Grade level course is offered				Page Number
			9	10	11	12	
<b>World Languages (cont.)</b>							
HWL10400 (I-A) HWL10401 (II-A) HWL30467 (II-H) HWL10403 (III-A) HWL30468 (III-H) HWL10405 (IV-A) HWL30469 (IV-H) HWL10496 (V-A)	Spanish I, II, III, IV, V – A  Spanish II, III, IV – H	5	X	X	X	X	52-53
HWL10451	Spanish for Heritage Speakers Beginners -A	5	X	X	X	X	53
<b>Physical Education and Health</b>							
HPE00094; HPE00095 HPE00104; HPE00105 HPE00114; HPE00115 HPE00124; HPE00125 HPE70810 (Adaptive)	Physical Education & Health I, II, III, IV	4 or 5 each Year	X	X	X	X	54
HPE000808	PE Partners				X	X	54
<b>Performing Arts</b>							
HFA50811	<b>AP</b> Music Theory	5			X	X	55
HFA40639	Concert Band	5	X				55
HFA40500	Introduction to Guitar	5	X	X	X	X	56
HFA40604	Mixed Choir	5	X	X	X	X	56
HFA40611	Music Workshop	5	X	X	X	X	56
HFA40610	Select Treble Choir	5		X	X	X	56
HFA40606	String Orchestra 9	5	X				57
HFA40603	String Orchestra	5	X	X	X	X	57
HFA40616	Symphonic Band	5		X	X	X	57
HFA30601	Symphonic Choir – H	5		X	X	X	57
HFA30600	Symphony Orchestra – H	5		X	X	X	57
HFA30626	Wind Ensemble – H	5		X	X	X	58
<b>Business Education</b>							
HFB20697	Academic Internship Program	7.5				X	59
HFB40522	Academic Internship Program	15				X	59
HFB40507	Accounting I	5	X	X	X	X	59
HFB30510	Accounting II - H	5		X	X	X	59
HFB50525	<b>AP</b> Macroeconomics	5			X	X	59
HFB50515	<b>AP</b> Microeconomics	5			X	X	59
HFB20450	App Development	2.5	X	X	X	X	59
HFB20515	Business & Criminal Law	2.5	X	X	X	X	60
HFB20520	Career Exploration and Awareness	2.5	X	X	X	X	60
HFB20452	Computer Applications & Keyboarding	2.5	X	X	X	X	60
HFB20531	Computer Repair & Technical Support I	2.5	X	X	X	X	60
HFB20532	Computer Repair & Technical Support II	2.5	X	X	X	X	60
HFB20545	Desktop Publishing & Multimedia Presentations	2.5	X	X	X	X	60
HFB20525	Entrepreneurship & Business Management	2.5	X	X	X	X	60
HFB20523	Financial Planning	2.5			X	X	61
HFB20524	International Business	2.5	X	X	X	X	61
HFB20500	Introduction to Business	2.5	X	X	X	X	61
HFB20490	Introduction to Marketing through Social Media	2.5	X	X	X	X	61



Course Numbers	Course	High School Credit	Grade level course is offered				Page Number
			9	10	11	12	
<b>Business Education (cont.)</b>							
HFB20535	Leadership & Philanthropy	2.5	X	X	X	X	61
HFB20502	Notetaking & Study Skills	2.5	X	X	X	X	61
HFB20466	Photo Editing & Web Design	2.5	X	X	X	X	61
HFB20555	Photo Editing for Business	2.5	X	X	X	X	62
HFB20530	Programming for Business	2.5	X	X	X	X	62
HFB20556	Programming for Business II	2.5	X	X	X	X	62
HFB40521	Related Instruction(scheduled with Academic Internship Program)					X	58
<b>Family and Consumer Sciences</b>							
HFB20730	Baking & Pastry Arts	2.5	X	X	X	X	63
HFB20731	Cooking Across America	2.5	X	X	X	X	64
HFB30735	Culinary Nutrition - H	2.5		X	X	X	64
HFB20441	Design & Sewing Techniques	2.5	X	X	X	X	65
HFB20710	Early Childhood Education	2.5			X	X	64
HFB20705	Family & Child	2.5			X	X	64
HFB20700	Family & Consumer Sciences	2.5	X	X	X	X	64
HFB20442	Fashion & Creative Design	2.5		X	X	X	65
HFB20707	Home & Interior Design	2.5	X	X	X	X	65
HFB20732	International Foods	2.5	X	X	X	X	64
HFB20701	Introduction to Culinary Arts	2.5	X	X	X	X	65
HFB20440	Sewing Concepts	2.5	X	X	X	X	65
HFB40707	Today's Living	5				X	65
<b>Fine Arts</b>							
HFA50622	<b>AP</b> Studio Art	5				X	66
HFA50488	<b>AP</b> Art History	5		X	X	X	67
HFA40628	Art History	5	X	X	X	X	67
HFA40624	Art I	5	X	X	X	X	67
HFA40602	Art II	5		X	X	X	67
HFA40487	Art III	5			X	X	67
HFA30736	Art III - H	5			X	X	68
HFA40737	Art IV	5				X	68
HFA30555	Art IV – H	5			X	X	68
HFA20603	Ceramics I	2.5	X	X	X	X	68
HFA20489	Ceramics II	2.5	X	X	X	X	68
HFA20746	Ceramics III	2.5		X	X	X	68
HFA20767	Ceramics IV	2.5		X	X	X	69
HFA20604	Crafts I	2.5	X	X	X	X	69
HFA20611	Crafts II	2.5	X	X	X	X	69
HFA20101	Cultural Ceramics	2.5	X	X	X	X	69
HFA20605	Design	2.5		X	X	X	69
HFA20487	Digital Fine Arts I	2.5	X	X	X	X	69
HFA20606	Painting & Drawing	2.5		X	X	X	69
HFA20608	Sculpture	2.5		X	X	X	70

<i>Course Numbers</i>	<i>Course</i>	<i>High School Credit</i>	<i>Grade level course is offered</i>				<i>Page Number</i>
			<i>9</i>	<i>10</i>	<i>11</i>	<i>12</i>	
<b><i>Industrial Technology</i></b>							
HFB20610	Audio & Music Engineering	2.5	X	X	X	X	70
HFB40533	Computer Aided Design Technology I	5	X	X	X	X	71
HFB40535	Computer Aided Design Technology II	5		X	X	X	71
HFB20615	CNC Production	2.5	X	X	X	X	71
HFB40720	Engineering Computer Graphics I	5		X	X	X	72
HFB20601	Filming & Video Editing I	2.5	X	X	X	X	72
HFB20602	Filming & Video Editing II	2.5	X	X	X	X	72
HFB20603	Filming & Video Editing III	2.5		X	X	X	72
HFB20604	Filming & Video Editing IV	2.5		X	X	X	73
HFB20605	Filming & Video Editing Seminar - H	2.5			X	X	73
HFB40725	Introduction to Electronics	5	X	X	X	X	72
HFB40709	Wood Design & Fabrication I	5	X	X	X	X	73
HFB40710	Wood Design & Fabrication II	5		X	X	X	73
HFB40711	Wood Design & Fabrication III	5			X	X	73
<b><i>Other</i></b>							
	Option II	Varies	X	X	X	X	6
	Teacher's Aide	5 or 10				X	74
	Vo-Tech A or C	15	X	X	X	X	NA



## COURSE DESCRIPTIONS

**NOTE:** *The first grade level listed under each course indicates the year in which the course is first offered. Additional grade levels show years of continuing student interest.*

### English

**Supervisor: Dr. Mark Jarmon – 908-231-8660 ext. 2265**

#### Overview

- All students must satisfactorily complete four years of English Language & Literature. This requirement means that all students must take, complete all core requirements for, and pass at least one year of English Language & Literature (5 credits) each year that they attend school.
- Students who are required to take Literacy Support in addition to English Language & Literature courses are identified by district and state test scores.
- In addition to the four years of required English Language & Literature, students may select additional courses from the list of electives. These courses may not replace any of the four years of required English Language & Literature.
- The English Language & Literature courses are characterized by a strong emphasis on the relationship of the language processes to thinking and learning. Through the structured integration of speaking, reading, listening, and viewing activities, students are able to master the basic skills and to develop a continuing interest in language and literature.
- **Flexible Grouping.** Instruction takes place through large group, small group, and independent learning. Flexible grouping and varied activities help to maintain interest in learning and to provide for individual differences.
- **Speaking.** In order to encourage maximum participation, the courses include a wide variety of informal and formal speaking activities such as oral reports and dramatization of stories. Speaking is also taught as a vital part of the composing process and is related closely to the development of listening skills.
- **Writing.** Writing is viewed as a continuing, rather than an occasional, activity which requires writing in varied, realistic, challenging ways. Writing is taught not only for its own value, but also as a means of thinking and learning. Central to the writing program is the composing process in which students learn to prepare, write, and edit what they have written for a given audience and for a particular purpose. Writing assignments range from the personal response to the formal research paper. Instruction in the support skills - grammar, usage, and mechanics - figures prominently in the editing phase of the composing process.
- **Literature and Reading.** The study of literature is diverse and challenging. The selection of contemporary and classic literature includes the study of the major genres: novel, drama, short story, biography, and poem. Students are provided with materials to meet their reading ability and personal interests. Literature is taught in response to grade-level essential questions either through thematic units or through American, British, or world selections. All of these encourage personal, literal, inferential, critical, and creative responses.
- **Viewing.** Since the non-print media - especially films and television - are major factors in shaping people's lives, students are taught to read visual images and messages intelligently and to share their responses with others in speech and writing.

The following flow charts illustrate possible sequencing of courses within the department. Students are encouraged to take the most challenging courses (differentiated by level of rigor) in which they will be most successful. Movement across options is possible. This is determined by student ability, motivation, and achievement. **Students are encouraged to read specific course descriptions prior to selection, taking note of prerequisite and recommendation requirements.**

### Option #1 Most Rigorous

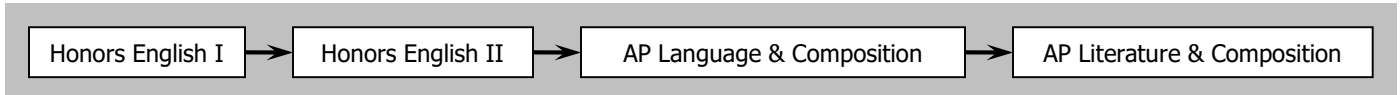

### Option #2 Highly Rigorous



### Option #3 Rigorous

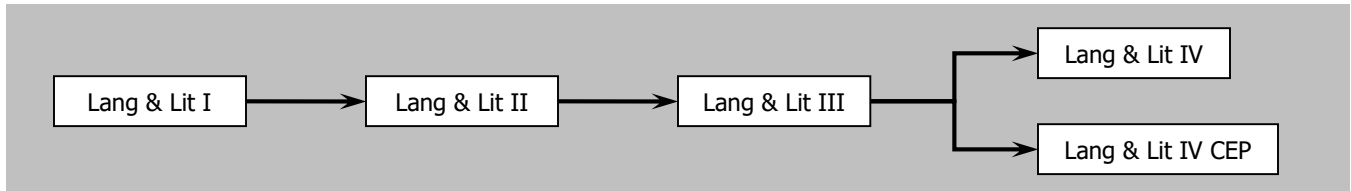

### ESL

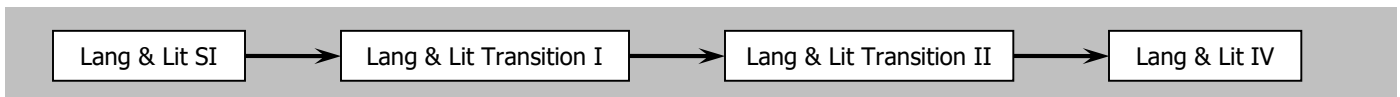

### Electives

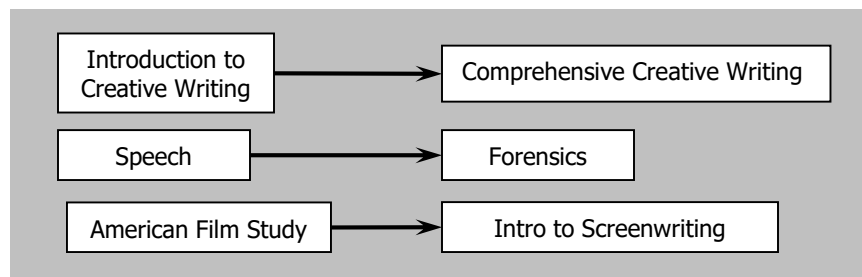

### English Department Course Descriptions

#### **Advanced Placement Language and Composition III ..... Credits: 5**

##### **Grade 11**

This college-level course in effective writing and critical reading centers on fostering a student's awareness of writing as a thinking process. Intense concentration on language use and stylistic development will lead to insight regarding interpretative reading and writing skill. The fiction and nonfiction course readings will serve as tools for advancing the manipulation of language details and structure to create meaning primarily within the modes of exposition, analysis, and argumentation.

\*\*Students completing Honors English II in good academic standing may elect Advanced Placement Language and Composition III.

**Advanced Placement Literature and Composition IV ..... Credits: 5****Grade 12**

This college-level course enables students to focus on intensive, in depth, advanced study in English. Critical analysis of literature will lead to insights in structure and meaning. Authors and literary works from the 16th century to the present will be studied. In addition, major authors, periods, genres, and themes will be studied via a concentration on imaginative literature—poetry, fiction, and drama.

\*\*Students completing Honors English III or Advanced Placement Language and Composition III in good academic standing may elect Advanced Placement English Literature and Composition IV.

**English Language and Literature I (Honors) ..... Credits: 5****Grade 9**

English I Honors focuses on classic and contemporary literature to establish a framework for enabling students to use language as a tool for exploring the world actively, communicating effectively, and growing intellectually. As a student in the honors program, you will be asked to read and write in a more independent fashion than you would in other English courses. As a result of an accelerated instructional pace, core literature will be enriched with advanced-level assignments.

**English Language and Literature II (Honors) ..... Credits: 5****Grade 10**

English II Honors adds to the framework of prior knowledge with a study of American literature to encourage student use of language as a tool for exploring the world actively, communicating effectively, and growing intellectually. As a student in the honors program, you will be asked to read and write in a more independent fashion than you would in other English courses. As a result of an accelerated instructional pace, core literature will be enriched with advanced-level assignments.

**English Language and Literature III (Honors) ..... Credits: 5****Grade 11**

English III Honors applies the use of language as a tool for exploring the world actively, communicating effectively, and growing intellectually through the study of British literature. As a student in the honors program, you will be asked to read and write in a more independent fashion than you would in other English courses. As a result of an accelerated instructional pace, core literature will be enriched with advanced-level assignments.

**English Language and Literature IV (Honors) ..... Credits: 5****Grade 12**

English IV Honors serves as the culminating high school experience in which students can refine their use of language as a tool for exploring the world actively, communicating effectively, and growing intellectually through the study of World literature. As a student in the honors program, you will be asked to read and write in a more independent fashion than you would in other English courses. As a result of an accelerated instructional pace, core literature will be enriched with advanced-level assignments.

**English Language and Literature I (A, S) ..... Credits: 5****Grade 9**

*Participation in the Standard (S) level course is an academic placement decision.*

Language and Literature I focuses on classic and contemporary literature to establish a framework for enabling students to use language as a tool for exploring the world actively, communicating effectively, and growing intellectually. Through reading, writing, speaking, listening, viewing, and critical thinking, learning becomes a multidimensional and transactional process through which students continually expand their repertoire of knowledge.

**English Language and Literature II (A, S) ..... Credits: 5****Grade 10**

*Participation in the Standard (S) level course is an academic placement decision.*

Language and Literature II adds to the framework of prior knowledge with a study of American literature to encourage student use of language as a tool for exploring the world actively, communicating effectively, and growing intellectually. In conjunction with cognitive development, student independence regarding reading, writing, speaking, listening, viewing, and critical thinking increases.

**English Language and Literature III (A, S) ..... Credits: 5****Grade 11**

*Participation in the Standard (S) level course is an academic placement decision.*

Language and Literature III applies the use of language as a tool for exploring the world actively, communicating effectively, and growing intellectually through the study of British literature. Reading, writing, speaking, listening, viewing, and critical thinking are addressed creatively, critically, and strategically.

**English Language and Literature IV (A, S) ..... Credits: 5****Grade 12**

*Participation in the Standard (S) level course is an academic placement decision.*

Language and Literature IV serves as the culminating high school experience in which students can refine their use of language as a tool for exploring the world actively, communicating effectively, and growing intellectually through the study of World literature. Anticipating higher education and/or career employment, reading, writing, speaking, listening, viewing, and critical thinking are addressed with an understanding of both high academic and practical applications.

**English Language and Literature IV—CEP (A) ..... Credits: 5****Grade 12**

Language and Literature IV—CEP (Concurrent Enrollment Program) will continue to follow the philosophy of teaching literature and writing, emphasizing response to literature and writing as a process. The important difference between this course and other English courses is that this course merges senior academic English with freshman college English. Therefore, if all requirements are met by the student, including passing the college level Basic Skills test, credit is earned for both Language and Literature IV and college English I from Raritan Valley Community College. Students pay tuition, purchase some materials, and receive 5 high school credits as well as 3 college credits, which may be transferred to other college or university programs.

**English as a Second Language/Bilingual**

Students who are non-native speakers of English are to be given the "WIDA MODEL" test when they enter our school to see if they are limited English proficient (LEP). This state-mandated test has nine sections and is administered individually by the ESL teacher. Students enrolled in the ESL Program are placed in one of the four levels of ESL based on results of placement tests and/or teacher recommendations.

**ESL I – Grammar & Conversation ..... Credits: 10****Grades 9, 10, 11, 12**

This course, for the beginning ESL student, offers a high level of support via a double period. This course focuses on needs specific to English Language Learners. Students will develop reading, vocabulary, and oral and written language.

**ESL II – Grammar & Conversation ..... Credits: 10****Grades 9, 10, 11, 12**

Students at this level of English Language Proficiency receive a high level of support in their English Language Development by meeting for two periods daily. Students will continue their development of reading, vocabulary and oral and written language.

**ESL III – Reading & Writing ..... Credits: 5****Grades 9, 10, 11, 12**

This course is offered to students who are at a low intermediate level of English proficiency and is taken concurrently with a standard or academic English Language and Literature course for their grade level.

**English Language and Literature SI ..... Credits: 5****Grades 9, 10, 11, 12**

Language and Literature SI is a multi-grade/multi-ability-level course where beginning and intermediate English Language Learners will meet both content and language objectives in a differentiated, sheltered-instruction learning environment. With access to texts from the various language and literature courses, this course will provide a survey of literary study and endeavor to bridge student progress for placement the next year into the grade-level appropriate English Academic or Transition course.

**English Language & Literature T I..... Credits: 5**  
**Grades 9, 10, 11, 12**

Language & Literature T I seeks to prepare ESL students for placement in a grade-level appropriate academic Language & Literature course as they reach the final stage of the ESL program. The course will provide students with materials, resources, and strategies to function as a contributing resource within the traditional English classroom setting. Students will explore the fundamentals of literature study, practice the process of formal essay writing, and develop the confidence to become active members of thoughtful classroom discussion.

**English Language & Literature T II ..... Credits: 5**  
**Grades 9, 10, 11, 12**

Language and Literature T II is a continuation of Language and Literature T I. This course will expand their knowledge of literature, literary terms, and the writing process, therefore preparing them for a grade-level academic English course.

**English Department Electives**

**American Film Study..... Credits: 2.5**  
**Grades 11, 12**

This course seeks to complement and expand upon the core film units addressed in Language & Literature courses. Through an academic consideration of the relationship between film and American culture, students will develop the critical thinking skills needed to meet the demands of contemporary society. Additionally, by studying literary/cinematic devices and paralleling the formal analysis done with print texts, the course will help to ensure greater success in the language arts classroom.

**Comprehensive Creative Writing..... Credits: 5**  
**Grades 11, 12**

*Prerequisite* – Introduction to Creative Writing

If you want to publish and share your stories with the world, this is the course for you. This course provides serious writers of fiction and creative non-fiction with a structured writing workshop community and the preparation necessary to excel at the collegiate level and beyond. Students will refine and revise their work until it is ready to send to magazines, and will learn the needs and styles of contemporary markets. Students will read and study exemplary short fiction and non-fiction across many genres, including the work of graduates of this course who have begun publishing in some of the country's finest literary magazines. Students will consider their personal identities as artists and their role in a larger aesthetic community. Most importantly, students will gain confidence and will go from being student-writers to active, working *writers*.

**Drama ..... Credits: 2.5**  
**Grades 9, 10, 11, 12**

Through a variety of exercises, dramatics encourages you to act, improvise, write, read, and listen. Drawing from inner resources will prepare you for activities in movement, oral interpretation, characterization, playing the part, and dramatic criticism. Activities include reading plays, writing responses and original scenes, and improvising the familiar from sense recall and the unfamiliar from imagination. You will dramatize scenes, (published and/or student generated) monologues, and improvisations. In addition, you will participate in audience critiques of your classmates' performances.

**Forensics..... Credits: 2.5**  
**Grades 9, 10, 11, 12**

*Prerequisite* - Speech

An activity approach to the various areas of forensic speaking and writing, this course will touch on the following areas: extemporaneous speaking, original oratory, dramatic interpretation, humorous interpretation, poetry reading, prose reading, duo interpretation, declamation and impromptu speaking. Each area will be presented and critiqued by students. Diction, speech, and voice modulation will be developed. Students will write formally and informally. Discussion and debate will also be studied. There will be instruction in Lincoln-Douglas and Policy Debate, and a mock debate will be performed. The major focus will be noncompetitive, but students will also be encouraged to raise their performances to competition levels.

**Introduction to Creative Writing ..... Credits: 2.5****Grades 9, 10, 11, 12**

Introduction to Creative Writing teaches you the process involved in writing fiction, drama, and poetry. As you are introduced to each new form of writing, you will read literature which illustrates the type of writing you are doing. Beginning with short assignments to sharpen your use of sensory perception and imagery, you will eventually progress to writing character sketches, short stories, one-act plays, and poetry. You will be encouraged to share your creative work with others.

**Introduction to Screenwriting ..... Credits: 2.5****Grades 11, 12**

*Prerequisite* – American Film Study

This course will enable students to write within the accepted framework for professional film scripts with the goal of producing an act-long script excerpt. Course content will build upon the basic knowledge set attained during the prerequisite course, American Film Study, and transition into practical written applications. Students will learn to analyze film with an increasingly critical eye, synthesizing previously-learned skills with a more advanced understanding of the art and science of screenwriting. They will then be equipped to apply these technical and creative processes to their own work. The format of the course will include close “readings” of a film and several film clips concurrently with their scripts; instruction of and practice with script jargon, format and structure; experience writing and work-shopping a story pitch; writing a 400-word treatment; visually diagramming existing scripts as well as original story ideas; and drafting a complete first act of an original screenplay.

**Journalism ..... Credits: 2.5****Grades 9, 10, 11, 12**

In this course you will be introduced to newspaper journalism. You will learn the particular skills needed in journalistic writing, such as fact gathering, note taking, objective reporting, interviewing, editing, and proofreading. You will read a wide variety of newspapers as well as literature on how ideas are communicated so that you can become a wiser consumer in the media marketplace. You will have the opportunity to publish your writing in school periodicals.

**Kid Lit Literacy ..... Credits: 2.5****Grades 9, 10, 11, 12**

This course explores the history of children’s literature, focusing on societal, cultural, and technological influences. Additionally, the course demonstrates how specific children’s literature can be used as a learning tool across all academic subjects on the high school level. The culmination of the course will be an original production of a picture book.

**Literacy Support (11 or 12) ..... Credits: 5 (grade 11) or 2.5 (grade 12)****Grades 11, 12**

This offering is required for all students who do not meet state graduation standards in reading and/or writing as well as students who are identified through the English department’s student performance-monitoring system. This course involves the creation of an individual-student-learning diagnosis, the differentiation of instruction based on the compilation of a unique master student prescription, and the administration of instructional strategies that drive learning. An awareness of each student’s learning profile based upon the systems affecting output guides literacy instruction in guided practice, independent practice, and applied practice formations.

**LP: Lyrical Poetry ..... Credits: 2.5****Grades 9, 10, 11, 12**

From Beethoven to the Beastie Boys to the Grateful Dead and to the Dave Matthews Band, LP: Lyrical Poetry provides students with a solid foundation in the study of formal analysis of literature, music, and critical terminology. Each area of this class will strive to create an understanding and appreciation of the historical, aesthetic, and cultural aspects of lyrical poetry. Furthermore, this course will allow students to strengthen and build upon their poetic/lyrical writing styles, both formal and creative. Ultimately, students will gain a greater appreciation of writing poetry and lyrics through their own unique, individual experiences.



**Publication Development and Production ..... Credits: 5****Grades 9, 10, 11, 12**

Publication Development and Production provides students with a solid foundation of instruction in the purpose and methods of accomplishing each of the tasks that are part of the publication process. By learning the purpose and function of publication, structural team organization, theme development, coverage reporting, copy/caption writing, computer and manual layout design, topographic and graphic design, proofreading/editing/revision, and photographic composition, students are exposed to the intricacies associated with designing various publications while also learning valuable technological skills that will have practical application to other coursework and to the “real world.”

**Reading Animation ..... Credits: 2.5****Grades 9, 10, 11, 12**

This course provides students with a background and understanding of the art of animation and its effective use in communicating on multiple levels. Students will acquire skills to analyze literature creatively and instructively in a contemporary technological medium that is nearly universal in language. Students will develop awareness of the methods that animation artists and authors employ to communicate broadly, effectively, and with focused intent.

**SAT Preparation ..... Credits: 2.5****Grades 11, 12**

*Prerequisite* - Algebra II or Essentials of Algebra II or currently taking

This elective course targets math and verbal SAT preparation for those students who are planning to take the SAT. It is designed to increase student awareness of important test-taking strategies and, more importantly, to enhance higher order problem solving and thinking skills. One marking period will be devoted to verbal skills and one to math skills.

**Speech ..... Credits: 2.5****Grades 9, 10, 11, 12**

An activity approach to public speaking, this course provides you with practical lessons on how to communicate clearly and dynamically to various audiences. You will learn how to prepare and deliver formal and informal talks. Practice in voice, diction, and listening will be emphasized throughout the course. Tapes of famous personalities may be used to illustrate technique. Finally, by writing speeches and dialogues, you will learn about the similarities and differences in spoken and written English.

**Theater Production ..... Credits: 2.5****Grades 9, 10, 11, 12**

Theater Production, a companion course to Dramatics, explores the backstage support activities that help the play and the actors come alive. Through reading text and plays, researching, drawing and painting, and working on projects, you will learn the basics of backstage management, play selection and rehearsal, set design, lighting design, sound, props, makeup, and costuming. A final large project, perhaps with a Dramatics class, will allow you to concentrate on an area of special interest to you.



# Mathematics

Supervisor: Mr. Jason Mauriello - 908-231-8660 ext. 2266

The high school mathematics curriculum is designed to meet the individual differences in ability, interests, and future educational/life goals. Students are required to take 15 credits of high school mathematics, including Algebra I and Geometry, or the content equivalent, and a third year of math that builds on the concepts and skills of algebra and geometry and prepares students for college and 21st century careers. Courses in statistics, engineering, and computer science are also available through the mathematics course offerings.

BRHS offers mathematics courses at the academic, honors and advanced placement levels. It is the belief that all students should be offered the opportunity to take rigorous mathematics courses if desired. As such, there are no specific grades needed as prerequisites for honors and advanced placement mathematics courses. Decisions on levels should be made in conjunction with the school counselor and be based on student desire to challenge themselves in mathematical reasoning, modeling and application.

The following flow charts illustrate possible sequencing of courses within the department. Students are encouraged to take the most challenging courses (differentiated by level of rigor) in which they will be most successful. Movement across options is possible. This is determined by student ability, motivation, and achievement. **Students are encouraged to read specific course descriptions prior to selection, taking note of prerequisite and recommendation requirements.**

## Option #1 Most Rigorous

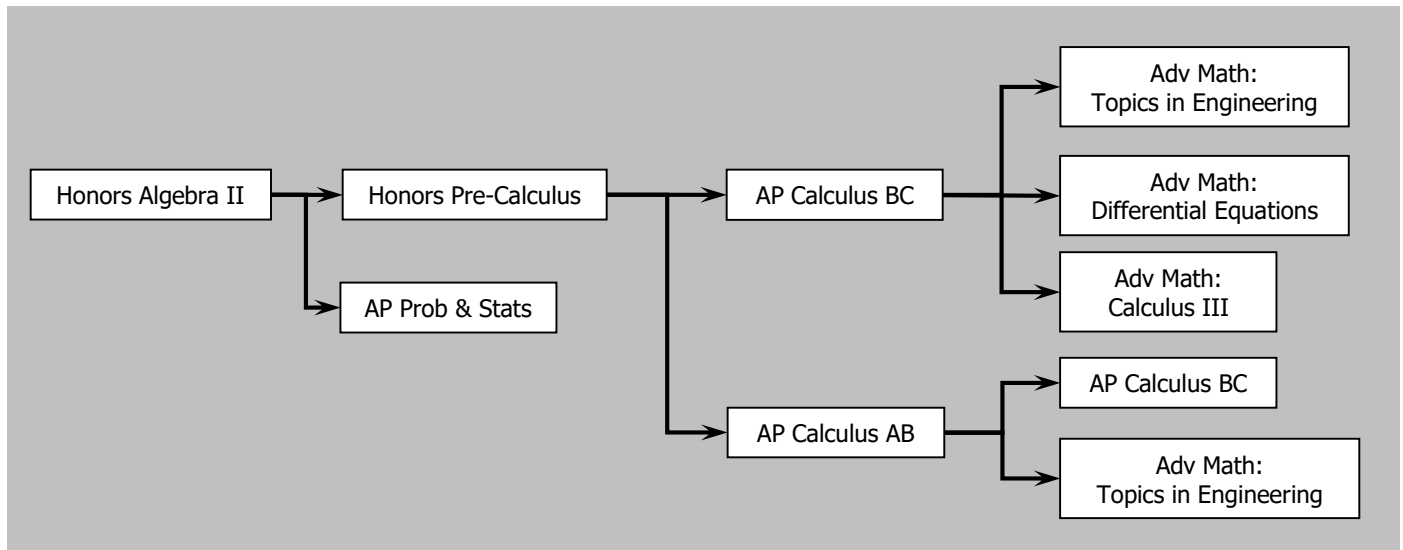

## Option #2 Highly Rigorous

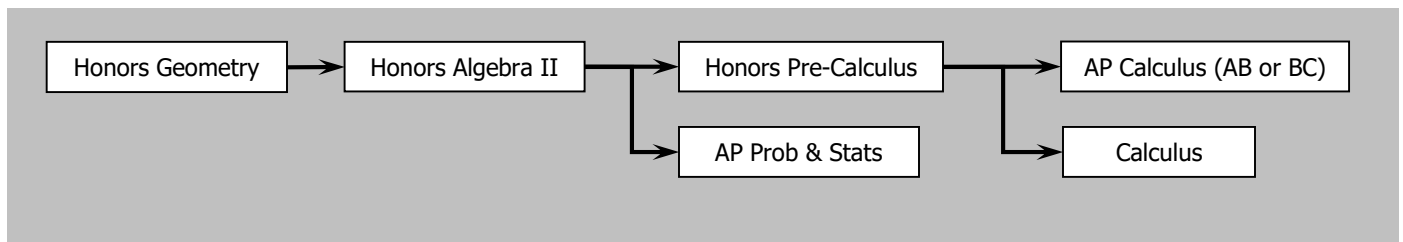

## Option #3 Very Rigorous

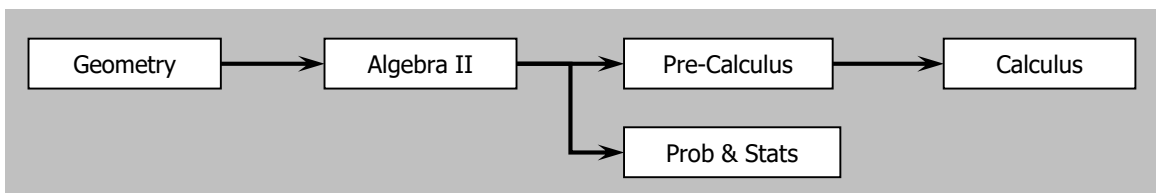

**Option #4 Rigorous**

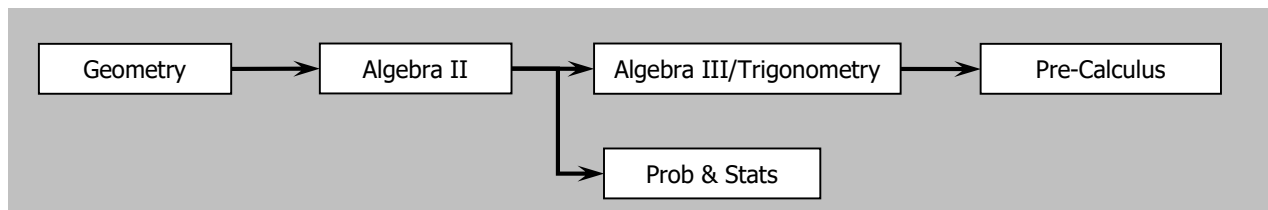

**Option #5 Less Rigorous**

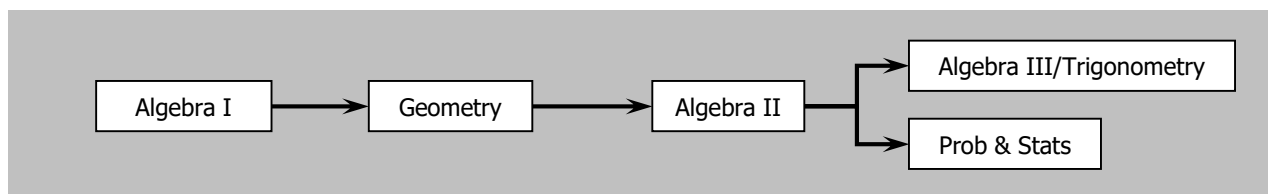

**Mathematics Department Course Descriptions**

**Advanced Placement Calculus AB ..... Credits: 5  
Grades 11, 12**

Prerequisite: Precalculus

This course is designed to prepare students for the College Board Advanced Placement Calculus AB Exam to seek college credit and/or advanced standing in mathematics. The content of the course includes introductory but comprehensive material on differential and integral calculus.

**Advanced Placement Calculus BC ..... Credits: 5  
Grades 11, 12**

Prerequisite - AP Calculus AB OR Precalculus Honors and also must meet department selection criteria

This course is designed to prepare students for the College Board Advanced Placement Calculus BC Exam to seek college credit and/or advanced standing in mathematics. The content of the course includes differential and integral calculus, infinite series, and vector-valued functions.

**Advanced Placement Probability and Statistics ..... Credits: 5  
Grades 11, 12**

Prerequisite - Algebra II

Advanced Placement Probability and Statistics is offered to students who wish to prepare for the CollegeBoard Advanced Placement Examination to seek college credit and/or advanced standing in mathematics. Students will be encouraged to take the examination in May. The content of this course will include introductory but comprehensive material on topics such as exploring data, observational studies, experiments, surveys, probability, and statistical inference. Problems from a variety of disciplines will provide connections between statistics and real life applications. Emphasis will be placed on communication and the ability to think critically.

**Mathematics SI ..... Credits: 5  
Grades 9, 10, 11, 12**

This multi-grade/multi-ability-level course for beginning, intermediate, and advanced English Language Learners (ESL I, II, III) will meet both math content objectives and language objectives in a differentiated, sheltered instruction learning environment. This course will provide an assessment of each student’s specific knowledge and capability in the study of mathematics, offer reinforcement of pre-algebra topics, and provide a preview of the most important algebra topics to prepare students to be successful at the next level in Algebra 1. The sheltered-instruction learning environment will also increase the rate and level at which each student acquires the English language.

**Algebra I (A) ..... Credits: 5****Grade 9**

This course will develop the necessary skills in algebra in order to: connect algebra to geometry, connect algebra to probability and statistics, connect ideas between mathematics and other disciplines, learn how to study mathematics, develop the ability to explore, conjecture, and reason logically, solve non-routine problems, and communicate about and through mathematics. Topics include: use of variables, addition, subtraction, multiplication and division in algebra, slopes and lines, exponents and powers, quadratic equations and square roots, polynomials, linear systems, and factoring.

**Algebra I ..... Credits: 10****Grade 9**

This course will develop the necessary skills in algebra in order to: connect algebra to geometry, connect algebra to probability and statistics, connect ideas between mathematics and other disciplines, learn how to study mathematics, develop the ability to explore, conjecture, and reason logically, solve non-routine problems, and communicate about and through mathematics. Topics include: use of variables, addition, subtraction, multiplication and division in algebra, slopes and lines, exponents and powers, quadratic equations and square roots, polynomials, linear systems, and factoring. This course includes an additional period of small-group instruction to support students in their learning of algebraic topics. The decision for placement in this course is made at the Mathematics Department level and is based on standardized test scores and other entrance criteria.

**Algebra I SI (A)..... Credits: 10****Grade 9**

This course for beginning, intermediate, and advanced English Language Learners (ESL I, II, III) will meet both math content objectives and language objectives in a differentiated, sheltered-instruction learning environment. This course will develop the necessary skills in algebra in order to: connect algebra to geometry, connect algebra to probability and statistics, connect ideas between mathematics and other disciplines, learn how to study mathematics, develop the ability to explore, conjecture, and reason logically, solve non-routine problems, and communicate about and through mathematics. Topics include: use of variables, addition, subtraction, multiplication and division in algebra, slopes and lines, exponents and powers, quadratic equations and square roots, polynomials, linear systems, and factoring.

**Geometry (Honors or A) ..... Credits: 5****Grades 9, 10**

*Prerequisite* - Algebra I

This course will develop skills in visualization and pictorial representation, emphasize applications of geometric ideas to questions about natural, physical, and social phenomena, encourage computer-based explorations, include both coordinate and transformational geometry, and present deductive arguments in a variety of forms. This course includes the principles of plane and solid geometry (e.g., meaning of induction, deduction, methods of deductive reasoning, angle relationships, parallel and perpendicular lines and planes, congruent triangles, arcs and angles as related to the circle, area of polygons, area and volume of solids.) Along with Algebra I and Algebra II, this course constitutes the basic mathematics requirements for admission to some institutions of higher learning. However, it is designed to be a value to you since its techniques are applicable to all fields of thought and since it develops the ability to problem solve using higher level thinking skills. The honors course has a greater focus on deductive reasoning, proof and advanced problem solving, and the level of work is more challenging.

**Geometry SI (A)..... Credits: 5****Grades 9, 10**

*Prerequisite* - Algebra I OR Algebra I SI

This course for beginning, intermediate, and advanced English Language Learners (ESL I, II, III) will meet both math content objectives and language objectives in a differentiated, sheltered-instruction learning environment. This course will develop skills in visualization and pictorial representation, emphasize applications of geometric ideas to questions about natural, physical, and social phenomena, encourage computer-based explorations, include both coordinate and transformational geometry, and present deductive arguments in a variety of forms. This course includes the principles of plane and solid geometry (e.g., meaning of induction, deduction, methods of deductive reasoning, angle relationships, parallel and perpendicular lines and planes, congruent triangles, arcs and angles as related to the circle, area of polygons, area and volume of solids.) Along with Algebra I and Algebra II, this course constitutes the basic mathematics requirements for admission to some institutions of higher learning. However, it is designed to be a value to you since its techniques are applicable to all fields of thought and since it develops the ability to problem solve using higher level thinking skills.

**Algebra II (Honors or A)..... Credits: 5**  
**Grades 9, 10, 11**

*Prerequisite* - Geometry or Essentials of Geometry

This course will emphasize problem solving, communication, reasoning, and connections. The following topics will be explored: analyzing equations and inequalities, graphing linear relations and functions, solving systems of linear equations and inequalities, using matrices, polynomials and radical expressions, quadratic functions and inequalities, polynomial functions, rational expressions, and exponential and logarithmic functions. The honors course moves at an accelerated pace and the level of work is more challenging. The honors course dedicates more time to proof, quadratic relations and conic sections, and matrices.

**Algebra III/Trigonometry (A) ..... Credits: 5**

*Prerequisite* – Algebra II OR Essentials of Algebra II

Algebra III/Trigonometry is designed to strengthen and extend students’ algebraic concepts and skills in preparation for Precalculus/calculus. The course introduces the study of trigonometric functions, identities, equations and their applications.

**Probability and Statistics (A)..... Credits: 5**

**Grades 11, 12**

*Prerequisite* – Essentials of Algebra II or Algebra II

This course will consist of a broad coverage of topics in applied statistics and probability, which will give students the ability to make more informed decisions based on analysis of quantitative data. Understanding probability and statistics is essential in today’s high tech world, where print and electronic media are full of numerical information and interpretation. Statistics is the mathematics we use to collect, organize, and interpret numerical data, from test scores to election results to shopper’s product preferences. Probability is the study of uncertainty and assessing the likelihood of real world events occurring, whether it is games of chance, genetics, or weather prediction to anticipate and prepare for a major storm.

**Precalculus (Honors or A)..... Credits: 5**

**Grades 10, 11, 12**

*Prerequisite* - Algebra II

This full year course lays the groundwork for the study of calculus by providing essential concepts and skills of algebra, trigonometry, and the study of functions. Numerous real-world applications will be discussed. The honors course moves at an accelerated pace and the level of work is more challenging. The honors course dedicates more time to factorable, reducible and quadratic relations, sequences and series, probability, and limits.

**Calculus (A) ..... Credits: 5**

**Grades 11, 12**

*Prerequisite* Precalculus

This course includes the material normally taught in the first two semesters of a college calculus program. It deals with the fundamentals of differential and integral calculus. After a review of analytic geometry, limit theory is developed. The properties of limits are used to find the derivatives of algebraic and transcendental functions. Applications of derivatives are then discussed. The concept of integration is introduced, and the Fundamental Theorem of Integral Calculus is used as a basis for the application of the definite integral. Greater versatility in integration is provided with a study of the methods of integration.



**Mathematics Department Electives****Advanced Mathematics: Calculus III\* ..... Credits: 2.5****Grade 12**

*Prerequisite* - AP Calculus Level BC

This course is typically a third semester calculus course at the college level. Calculus III is a multivariate calculus that primarily deals with vectors, rates of change in three dimensions, and multiple integration.

\*This course will be given AP weight in the calculation of the student's GPA.

**Advanced Mathematics: Differential Equations \* ..... Credits: 2.5****Grade 12**

*Prerequisite* - AP Calculus Level BC This course is typically the fourth semester calculus course at the college level. The course begins with solving first order differential equations. Material expands from AP Calculus BC with basic solutions and progresses throughout the entire course towards solving more complex single differential equations as well as systems of differential equations. Differential equations are used to solve problems that model applied sciences such as engineering and physics.

\*This course will be given AP weight in the calculation of the student's GPA.

**Advanced Mathematics: Topics in Engineering\* ..... Credits: 5****Grade 12**

*Prerequisite* - AP Calculus BC, OR AP Calculus AB with concurrent enrollment in AP Calculus BC

This course will introduce students to the advanced mathematics and "big ideas" of the standard undergraduate engineering curriculum. Topics include series expansions, complex numbers, linear algebra and vector spaces, Fourier analysis, and other advanced calculus methods. The course will include an experiential (lab or coding) component in which students apply their mathematical knowledge to a practical engineering problem. Topics of Engineering is designed to prepare future engineering and science majors for success in their first- and second-year college coursework. \*This course will be given AP weight in the calculation of the student's GPA.

**Mathematics III Workshop ..... Credits: 2.5/5****Grade 11**

The decision for placement in this mathematics workshop is made at the Mathematics Department level and is based on standardized test scores and other entrance criteria. This course remediates identified skill gaps while emphasizing foundational content for Algebra II.

Note: This course does NOT fulfill the mathematics graduation requirement. Therefore, students assigned to this workshop must also take another mathematics course.

**Mathematics IV Workshop ..... Credits: 2.5/5****Grade 12**

This workshop is designed for students who have not demonstrated proficiency in mathematics through required state testing. This course involves the creation and implementation of an individual student plan to achieve graduation testing requirements for mathematics.

Note: This course does NOT fulfill the mathematics graduation requirement. Therefore, students assigned to this workshop must also take another mathematics course.

**SAT Preparation ..... Credits: 2.5****Grades 11, 12**

*Prerequisite* – Algebra II or Essentials of Algebra II or currently taking

This elective course targets math and verbal SAT preparation for those students who are planning to take the SAT. It is designed to increase student awareness of important test-taking strategies and, more importantly, to enhance higher order problem solving and thinking skills. One marking period will be devoted to verbal skills and one to math skills.

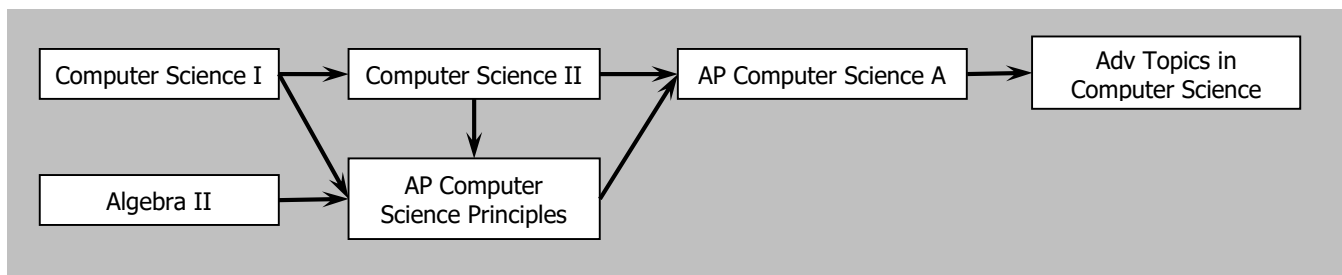
**Computer Science****Advanced Placement Computer Science A ..... Credits: 5  
Grades 10, 11, 12***Prerequisites* Computer Science II OR AP Computer Science Principles

Advanced Placement Computer Science A is an introductory programming course that teaches programming structures and language syntax. The course features a specific programming language, Java. Students will be encouraged to take the CollegeBoard Advanced Placement Examination to seek college credit and/or advanced standing in mathematics. This course utilizes the fundamental, as well as more complex abstract, mathematical concepts. The course challenges students to create programs, as well as utilize common algorithms, to be reusable and adaptable through Object Oriented programming design. For more information on object oriented programming, explore [www.greenfoot.org](http://www.greenfoot.org) and [www.code.org](http://www.code.org).

**Advanced Placement Computer Science Principles ..... Credits: 5  
Grades 10, 11, 12***Prerequisites* –Computer Science I OR Computer Science II OR Algebra II

The AP Computer Science Principles course is designed to be equivalent to a first-semester introductory college computing course. In this course, students will develop computational thinking skills vital for success across all disciplines, such as using computational tools to analyze and study data and working with large data sets to analyze, visualize, and draw conclusions from trends. The course is unique in its focus on fostering student creativity. Students are encouraged to apply creative processes when developing computational artifacts and to think creatively while using computer software and other technology to explore questions that interest them. They will also develop effective communication and collaboration skills, working individually and collaboratively to solve problems, and discussing and writing about the importance of these problems and the impacts to their community, society, and the world.

**Advanced Topics in Computer Science ..... Credits: 5  
Grades 11, 12***Prerequisite*– AP Computer Science A

Advanced Topics in Computer Science is a course that follows AP Computer Science A to investigate the essential properties of data structures and algorithms for operating on them, to use these structures as tools to assist algorithm design, and to extend exposure to searching, sorting and hashing techniques. Topics covered during the year include linked lists, stacks, queues, binary trees, sequential search, binary search, binary search trees, balanced binary search trees, hash tables, heaps for priority queues, graphs and graph algorithms, and asymptotic analysis of time and space requirements. An object-oriented language such as Java will be used to implement algorithms and further develop general programming skills. Students will have the option to pay tuition and receive 4 college credits through Rutgers University for their CS 112 Data Structures course if all requirements are met.

\*This course will be given AP weight in the calculation of the student's GPA.

**Computer Science I ..... Credits: 2.5  
Grades 9, 10, 11, 12***Prerequisite*– None

This elective course will introduce students to programming syntax and algorithm design by using various drag and drop development kits. Through the use of visual Interactive Development Environments and block based coding, students will develop and design interactive games, widgets and elements of app development, while growing in an understanding of basic computer programming principles such as decision-making, looping, variable use, and an object-oriented approach to problem solving. Although emphasis will be on graphically based development environments, a connection to text based coding will be used throughout the course to help transition students into text based languages.

**Computer Science II ..... Credits: 2.5**  
**Grades 9, 10, 11, 12**

*Prerequisite-* Algebra I OR Computer Science I

This elective course will introduce students to text based programming syntax and Object-Oriented programming. Students will develop Object Oriented programming design skills while creating Classes, Methods, and Functions within various IDEs. Students will create and utilize variables, arrays, decision making, and loops in their programming. Various programming environments and languages will be used to give students a broader understanding of the concepts involved in computer science.



## Science

**Supervisor: Mr. Michael Herbst - 908-231-8660 ext. 2267**

It is recommended that students anticipating a college major in the sciences select an advanced science course in their preferred field. If you wish to design a special science sequence that will enable you to take advanced physics in your senior year, you should consult with your school counselor or the science chairperson in your sophomore year.

### Advanced Placement Science - Overview

*Prerequisite-* For all advanced placement science courses:

- Appropriate Basic Course
- 2 years of Science (preference given to Honors)
  - AP Biology students must have successfully completed Biology and completion of or concurrently enrolled in Chemistry
  - AP Chemistry students must have successfully completed Chemistry
  - AP Environmental science student must have completed one year of Biology and one year of Chemistry
  - AP Physics 1 students must have successfully completed or be enrolled in Honors Precalculus and Chemistry
  - AP Physics 2 students must have successfully completed Honors Physics, AP Physics 1, or AP Physics C
  - AP Physics C students must have successfully completed Calculus

The following flow charts illustrate possible sequencing of courses within the department. Students are encouraged to take the most challenging courses (differentiated by level of rigor) in which they will be most successful. Movement across options is possible. This is determined by student ability, motivation, and achievement. Students **are encouraged to read specific course descriptions prior to selection, taking note of prerequisite and recommendation requirements.**

### Option #1 Most Rigorous

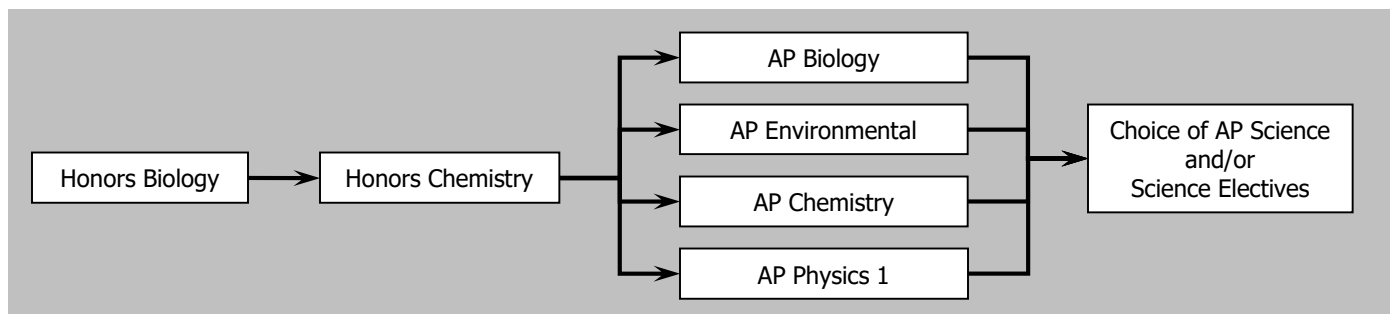



**Option #2 Very Rigorous**

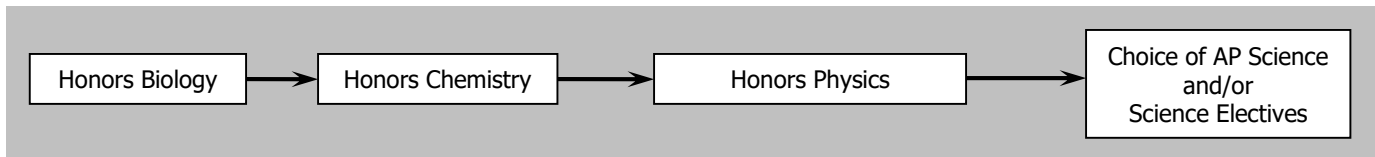

**Option #3 Rigorous**

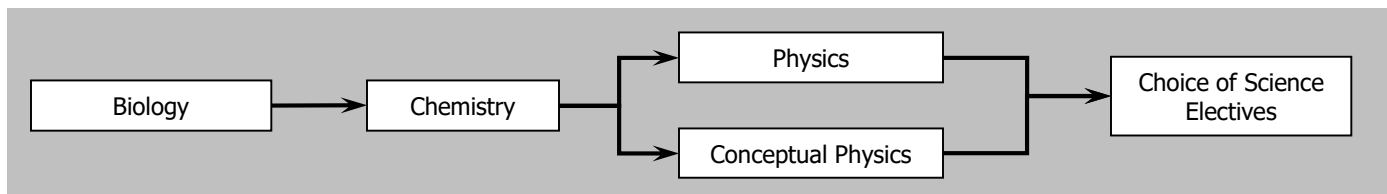

**Option #4 Less Rigorous**

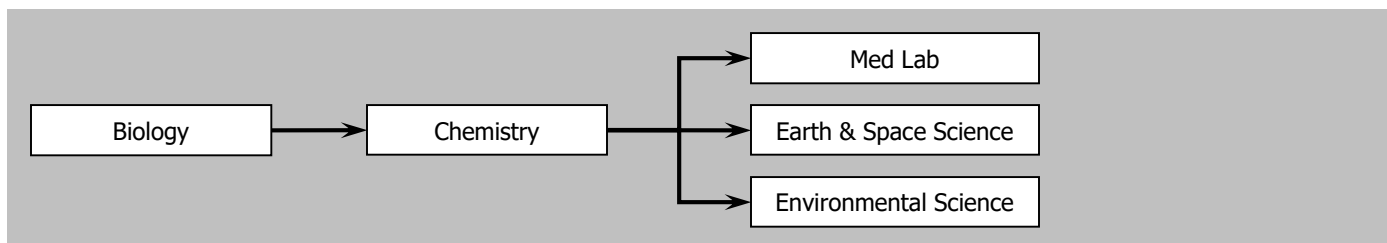

**Science Department Course Descriptions**

**Advanced Placement Biology..... Credits: 7**

**Grades 11, 12**

*Prerequisite* - Successful completion of Biology, completion of or concurrently enrolled in Chemistry

The Advanced Placement Biology course is designed to be the equivalent of the general biology course usually taken during the first year of college and prepares the students for the CollegeBoard Advanced Placement Examination. The advanced placement program provides an opportunity for secondary school students to pursue and achieve credit for college-level course work at the secondary school level. The students are highly recommended to take the Advanced Placement Biology exam in the spring. **Summer assignment required.**

**Advanced Placement Chemistry ..... Credits: 7**

**Grades 11, 12**

The Advanced Placement Chemistry course is designed to be the equivalent of the general chemistry course usually taken during the first year of college. The advanced placement program provides an opportunity for secondary school students to pursue and achieve credit for college-level course work at the secondary school level. The students are highly recommended to take the Advanced Placement Chemistry exam in the spring. Students should have completed two years of academic mathematics. Successful completion of Honors Chemistry is also **highly** recommended. **Summer assignment required.**

**Advanced Placement Environmental Science ..... Credits: 6**

**Grades 11, 12**

*Prerequisites* - Completion of Biology and Chemistry and successful completion of at least one year of Algebra.

The goal of the AP Environmental Science course is to provide students with the scientific principles, concepts, and methodologies required to understand the interrelationships of the natural world, to identify and analyze environmental problems both natural and human-made, to evaluate the relative risks associated with these problems, and to examine alternative solutions for resolving and/or preventing them. The course focus is on the "real science" behind environmental problems and issues. Laboratory and field study are an important element of the course. **Summer assignment required.**

**Advanced Placement Physics 1..... Credits: 6****Grades 11, 12**

*Prerequisite* – successful completion of Chemistry (B or better) or Academic Physics (B or better), and Pre-Calculus (B or better). Alternatively, students who have not completed Pre-Calculus should, at a minimum, be concurrently enrolled in Honors Pre-Calculus with a grade of A- or better in their most recent math course. Trigonometric functions will be utilized; students should have a working knowledge of trigonometry.

**AP Physics 1** is equivalent to a first-semester college course in algebra-based physics. The course requires students to develop a deep understanding of the following topics: Newtonian mechanics (including rotational dynamics and angular momentum); work, energy, and power; mechanical waves and sound; electric charge, electric force, and basic (resistor) electric circuits. **Summer assignment required.**

**Advanced Placement Physics 2..... Credits: 6****Grades 11, 12**

*Prerequisite* – successful completion of Honors Physics (B+ or better), AP Physics 1 or AP Physics C

**AP Physics 2** is equivalent to a second-semester college course in algebra-based physics. The course covers fluid mechanics, thermodynamics, electricity and magnetism, optics, and atomic and nuclear physics. Incoming students should have a solid understanding of AP Physics 1 topics. **Summer assignment required.**

**Advanced Placement Physics C ..... Credits 7****Grade 12**

*Prerequisite* - Calculus (a first year Physics course is recommended but not required)

The Advanced Placement Physics C level course is a rigorous in depth course that covers only “Newtonian Mechanics” and “Electricity and Magnetism.” Methods of calculus are used wherever appropriate in formulating physical principles and in applying them to physical problems. Strong emphasis is placed on solving a variety of challenging problems, some requiring calculus. The Physics C course is the first part of a sequence which in college is sometimes a very intensive one-year course but often extends over one and one-half to two years with a laboratory component. **Summer assignment required.**

**Biology (A) ..... Credits: 6****Grade 9**

Biology is that field of science that relates primarily to life processes and living things. It seeks to discover and describe all the phenomena associated with living things and with the state of being alive. It develops for us a realization of the unifying principles of plant and animal development and behavior, the awareness of order underlying the growth and structure of plants and animals, and the discovery of the sensitive balances regulating the lives of all organisms, including man.

**Biology (Honors)..... Credits: 6****Grade 9**

This course is a comprehensive, investigation oriented introduction to biology and is intended to prepare students to better understand the development of life processes and living forms through time. Major emphasis is placed upon biological themes and key concepts within the framework of scientific inquiry. Laboratory work is an integral part of the course, thus encouraging direct participation and insight into scientific methodology. This course is designed for the accelerated student.

**Biology (S) ..... Credits: 5****Grade 9**

*Participation in this Standard (S) level course is an academic placement decision.*

This five credit biology course explores a field of science that relates primarily to life processes and living things. It seeks to discover and describe all the phenomena associated with living things and with the state of being alive. It develops for us a realization of the unifying principles of plant and animal development and behavior, the awareness of order underlying the growth and structure of plants and animals, and the discovery of the sensitive balances regulating the lives of all organisms, including man.

**Chemistry (A)..... Credits: 6****Grade 10**

*Prerequisite* - Algebra I and successful completion of Biology

This course will establish the basic fundamentals of the study of chemistry so that further study in this and related fields may be pursued more readily. It meets for six periods per week permitting the performance of carefully controlled experimentation on a laboratory basis. Strong mathematical skills are highly correlated with success in chemistry.

**Chemistry (Honors) ..... Credits: 6****Grade 10**

*Prerequisite* – Algebra II or concurrent enrollment in Algebra II and successful completion of Biology

This course will establish an in-depth study of chemistry so that further study in challenging science courses can be pursued more readily. It meets for six periods per week permitting the performance of carefully controlled experimentation on a laboratory basis. This is a challenging course that requires excellent Math and study skills.

**Chemistry (S)..... Credits: 5****Grade 10**

*Prerequisite* - Successful completion of Biology

*Participation in this Standard (S) level course is an academic placement decision.*

Chemistry is a laboratory science course designed for students in the tenth grade who seek a conceptual understanding of chemistry while utilizing essential laboratory skills. This course is designed for the student who wishes to learn the broad concepts and basic laboratory techniques used in chemistry. Applications to daily life will be emphasized. Topics include properties of matter, atomic theory, periodic trends, bonding and types of reactions. The appropriate NJ State and National Standards will be addressed so as to raise the level of student discourse and develop essential scientific reasoning skills.

**Conceptual Physics (A) ..... Credits: 6****Grades 11, 12**

*Prerequisite* – C or higher in Academic Chemistry, English Lang & Lit II, Geometry, and Algebra I (or B or higher in Essentials of Algebra I and Essentials of Geometry). Concurrent English Lang & Lit III and Algebra II are strongly recommended.

Conceptual Physics has a hands-on, minds-on, project-based focus that illustrates the concepts of Physics while utilizing algebra, geometry, analysis, and critical thinking to quantify those concepts. The course requires students to develop a deep conceptual understanding of the following topics: Newtonian mechanics, work, energy, and power; mechanical waves and sound; electric charge, electric force, and basic electric circuits.

This course emphasizes scientific exploration and experimentation. Students are expected to engage in classroom experiences by asking more questions, exploring and discussing possible solutions, investigating science concepts, using argumentation, and being fully active in the learning process. Additionally, this course incorporates important engineering, technology, and innovation principles for all students.

**Physics (A) ..... Credits: 6****Grades 11, 12**

*Prerequisite* – A- or better in Geometry, B or better in Algebra II; concurrent in Precalculus is strongly recommended.

The study of physics is necessary for scientific study and research in fields including engineering and medicine. This course emphasizes both conceptual understanding of physical relationships as well as the ability to analyze these relationships quantitatively, which requires a significantly more advanced use of algebra than in chemistry as well as right angle trigonometry. Students not proficient in right angle trigonometry will be required to learn the skills during the class in order to be successful in the course. Laboratory experimentation in the course is an important part of understanding concepts and quantitative relationships.

**Physics (Honors)..... Credits: 6****Grades 11, 12**

*Prerequisite* –Successful completion of Chemistry and Algebra II

Honors Physics is an in-depth course involving the observation/description, data gathering/analysis, and concept formation of physical phenomena. This is a very challenging course that requires excellent math skills.

**Earth & Space Science ..... Credits: 5****Grades 11, 12**

*Prerequisite* – Successful completion of 2 years of science

This course is designed to be a survey of the sciences that are studied when dealing with the forces that affect our planet. The branches of science that will be covered are Astronomy, Geology, Meteorology and Oceanography. The students will be introduced to plate tectonics, earthquakes, volcanism, the prediction of systems of weather, the processes of the earth, planets, and stars with regard to scales of time and size, the geography and geology of ocean basins, chemistry of sea water, physical dynamics of currents, waves, and tides, coastal processes, and the large scale circulation of the ocean.

**Science Department Electives****Astronomy (A) ..... Credits: 2.5****Grades 10, 11, 12**

Astronomy begins with the study of galaxies and the distribution of stars, developing appropriate units of measurements for each. The course continues with the principles of mass, gravitation, and motion within the universe with consideration given to theories of the origin and destiny of the universe. Various methods of observing by using a wide variety of astronomical instruments are studied.

**Environmental Science (A) ..... Credits: 5****Grades 11, 12**

*Prerequisite* - Biology and Chemistry

An in-depth study of the relationships between chemistry and our biosphere will serve as the foundation of inquiry in this academic course. Major environmental concerns will be studied, researched, and analyzed throughout the year. Topics will include: environment, global ecology, population, living resources, energy, water environment, air pollution, and societal factors. *NOTE: Not a substitute for Conceptual Physics, Academic Physics, or Honors Physics. It is expected that a student will pursue a physics course concomitantly or before he/she enrolls in Environmental Science.*

**Exercise Physiology (A) ..... Credits: 2.5****Grades 10, 11, 12**

*Prerequisite* – Academic Biology, Chemistry or concurrently taking Chemistry

The course begins with a historical perspective on the study of exercise. Students then move into homeostasis, the creation of ATP and metabolism. Obesity, body composition and nutrition are studied as they relate to exercise. Finally, the benefits of exercise on the nerve, muscle and cardiovascular systems are examined. Students are required to exercise throughout the semester. Four field trips provide additional fitness opportunities for enrolled students. The topics covered in this course include:

- The History of Exercise
- Homeostasis
- Bioenergetics
- Metabolism
- Body Composition
- Nutrition
- Nerve Structure
- Muscular System
- Cardiovascular system

**Forensic Science (A) ..... Credits: 2.5****Grades 10, 11, 12**

*Prerequisites* - Successful completion of Biology. Successful completion OR concurrent enrollment in Chemistry or Physics

This specialized course draws from all disciplines of science to demonstrate the use of scientific knowledge in criminal investigation. Emphasis will be placed on principles of biology, chemistry, and physics in all topics covered. Subject areas will include processing a crime scene, eyewitness testimony, forensic anthropology and odontology, blood spatter analysis, DNA analysis, forensic pathology, fingerprints, impression evidence, hair/fiber evidence, toxicology, questioned documents, forensic psychology, forensic engineering, firearms evidence, crime scene reconstruction, and jurisprudence. Emphasis will be placed on laboratory investigation.

**General Anatomy & Physiology (A) ..... Credits: 2.5****Grades 10, 11, 12**

*Prerequisite* - Biology & Chemistry or concurrently taking Chemistry

As you make your way through this course, you will be learning about one of the most fascinating subjects possible -- your own body. If you are to appreciate emerging discoveries in medicine, to understand new techniques for detecting and treating disease, and to make use of published facts on how to stay healthy, it is important to learn about the workings of your body and the basic concepts that form the foundation of Anatomy and Physiology. The TLC series "Trauma: Life in the ER" and "Code Blue" will be an important teaching tool in this class. Students interested in a second semester of anatomy & physiology should take Medical Physiology. Dissection is mandatory for this class.

This course will cover the following topics:

- Human Body: An Orientation
- Cells & Tissues
- Biochemistry
- Muscular System
- Skeletal System
- Membranes & Integumentary System
- Nervous System
- Sense

**Genetics (Honors)..... Credits: 3****Grades 11, 12**

*Prerequisite* - Concurrent enrollment in AP Biology

This course examines the concepts of genetics & genomes, Mendelian and modern genetics, molecular biology, gene regulation, biotechnology, evolutionary connections and biodiversity. In addition, careers/ branches of genetics along with bioethics (ELSI) are included throughout each unit covered in the curriculum.

**Human Anatomy & Physiology (A) ..... Credits: 5****Grades 10, 11, 12**

*Prerequisite* - Biology & Chemistry or concurrently taking Chemistry

Human Anatomy and Physiology is a yearlong combination of Medical and General Anatomy and Physiology that will include an additional unit on respiration. As with the current semester electives, field trips and dissections will be part of the curriculum.

**Introduction to Engineering (Honors)..... Credits: 7****Grades 11, 12**

*Prerequisite* – Successful completion of Academic Physics (A- or better) or concurrently taking AP/Honors Physics

In this honors level laboratory course, students interested in science and technology based careers are exposed to both the academics and applications experienced when majoring in engineering. Topics in mechanical, electrical, materials, energy production, civil, biomedical, and industrial engineering are explored. Principles of science and mathematics will be applied to solve tasks in multidisciplinary projects in which teams of students collaborate to develop communication, academic, and technical skills. Project activities include proposals, research and development, design, experimentation, presentations, reports, and assessments.

**Marine Biology (A) ..... Credits 2.5****Grades 10, 11, 12**

*Prerequisite* - Successful completion of Biology

This course is designed to introduce students to the various marine environments of the world and the organisms found in them. Emphasis will be placed on the biological features of the oceans, organism-habitat relationships, and general ecological concepts influencing marine populations and communities. Topics will include learning the ecological relationship between flora and fauna, realizing influences that affect marine organisms, and identification of popular species of animals. Dissection of several marine species and identification of marine macro- and microfauna are integral components of this course.

**Medical Laboratory Technique..... Credits: 5****Grades 11, 12**

*Prerequisite* – Successful completion of 2 years of Science

This specialized science course is designed to provide the knowledge of equipment and techniques, which will enable you to qualify for employment in hospitals, clinical laboratories, and similar technical areas. It will prove valuable to you if you are considering nursing, allied health fields, or planning to major in Biology or Pre-Med in college. Areas studied include basic chemistry, preparation of solutions, and instruction on operation of medical testing equipment. Basic techniques are introduced in urinalysis, hematology, serology, and bacteriology, as well as independent work in areas of interest.

**Medical Physiology (A) ..... Credits: 2.5****Grades 10, 11, 12**

*Prerequisite* - Biology & Chemistry or concurrently taking Chemistry

This class will thoroughly cover 5 major body systems and medical issues involving these systems. This is a more challenging class in that it focuses not only on the anatomy & physiology of those body systems but will include discussions about medical problems and treatments (clinical application). The TLC series "Trauma: Life in the ER" and "Code Blue" will be an important teaching tool in this class. This class will cover body systems not covered in General Anatomy & Physiology. Although General Anatomy & Physiology is NOT a pre-requisite, those students interested in an in-depth study of the human body should take both classes. Dissection is mandatory for this class.

This course will cover the following topics:

- Urinary System
- Cardiovascular System
- Digestive System
- Immune System
- Respiratory System
- Human Development

**Microbiology (H) ..... Credits: 5****Grades 10-12**

*Prerequisite* – Successful completion of Biology and Chemistry (or concurrently enrolled)

Microbiology will discuss the importance of microorganisms not only as causative agents of disease, but also as major contributors to food production, antibiotic manufacture, vaccine development, regulators of ecological systems and environmental management. Eukaryo, bacteria, protists, algae, fungi, viruses, viroids, and prions will all be explored. Biotechnology laboratories and inquiry-based activities will be implemented throughout the course. Science, technology, engineering, and math will thread throughout the curriculum.

The study of microbiology is extremely rewarding, leading to advances in the welfare of the environment as well as human populations. Studying the above topics will lead to careers in:

*Biotechnology/Pharmaceutical Manufacturing/Medical research/Forensics/Agriculture/Environmental Sciences*

**Oceanography/Meteorology (A)..... Credits: 2.5****Grades 10, 11, 12**

The first half of the semester is devoted to Oceanography, the study of the distribution of land and water, the ocean-floor topography and sediments, the properties of water and seawater, the characteristics of the open ocean and the coastal ocean, ocean currents, waves, and tides. The second half, Meteorology, will cover the atmosphere and solar radiation effects, pressure, winds, circulation, precipitation, air masses, fronts, storms, weather forecasts, and climate.

**Organic & Biochemistry (Honors)..... Credits: 6****Grades 11, 12**

*Prerequisite* - Successful completion of Biology and one full year of Chemistry

This is an advanced chemistry course which will explore special topics in chemistry not covered in the Chemistry or AP Chemistry curriculum. Students will build on the foundation from their first year of Chemistry and develop an understanding of basic Organic Chemistry and Biochemistry. This course provides a survey of the structure, properties, and reactions of the major functional classes of organic and biological molecules and basic principles of metabolism and molecular biology. This course will be especially helpful to those students planning to major in fields that rely on organic and biochemistry (Pharmaceutics, Pre-Med, Nursing, Nutrition, Chemical Engineering, Chemistry, etc.).

## Social Studies

**Supervisor: Ms. Jennifer Edge- 908-231-8660 ext. 2264**

***The State of New Jersey requires that a student successfully complete one year of world history/cultures, and a two-year program in U. S. History. Each of the full year courses earns 5 credits. World Civilizations II is the second year of a two-year program beginning in the 8<sup>th</sup> grade. The United States History courses are sequential and are divided at World War I.***

The following flow charts illustrate possible sequencing of courses within the department. Students are encouraged to take the most challenging courses (differentiated by level of rigor) in which they will be most successful. Movement across options is possible. This is determined by student ability, motivation, and achievement. **Students are encouraged to read specific course descriptions prior to selection, taking note of prerequisite and recommendation requirements.**

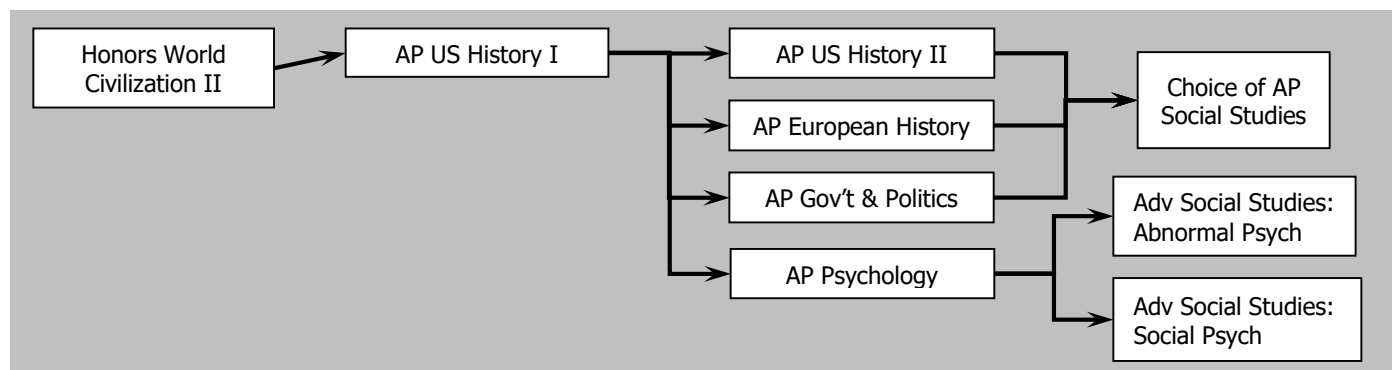
**Option #1 Most Rigorous**

**Option #2 Highly Rigorous**

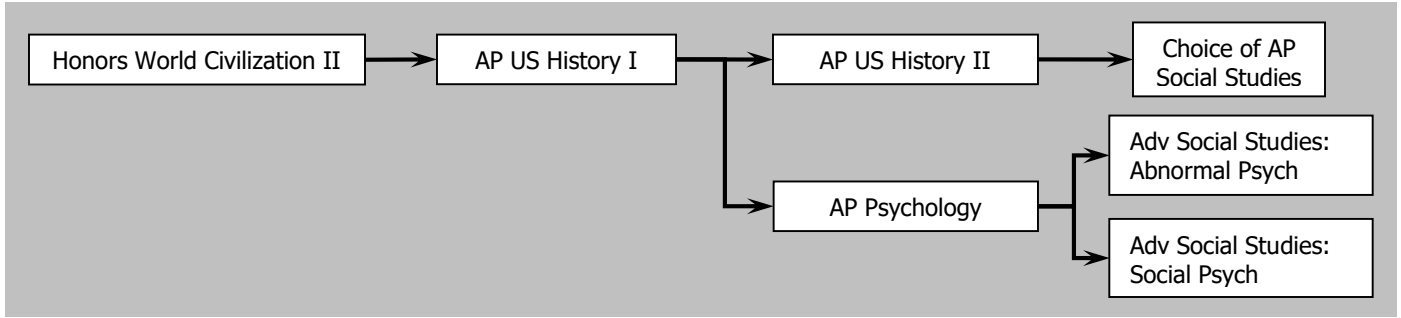

**Option #3 Very Rigorous**

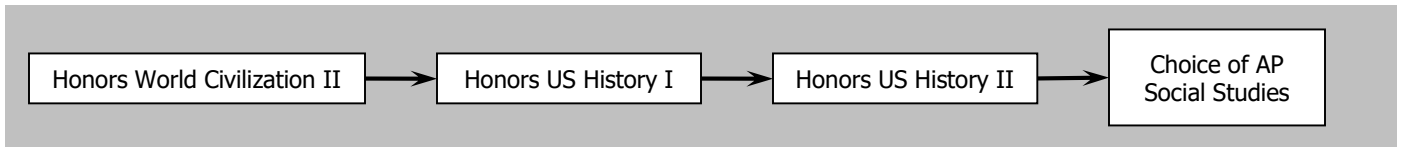

**Option #4 Rigorous**

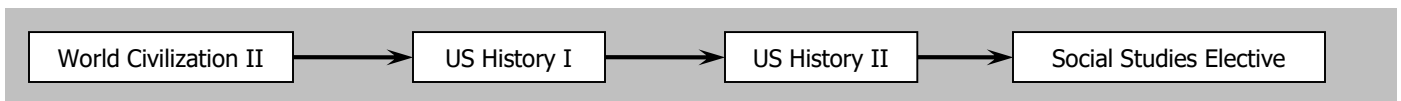

**Option #5 Less Rigorous**

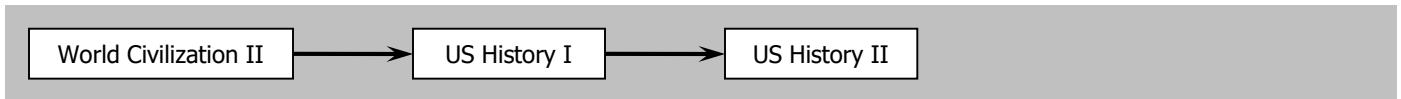

**Social Studies Department Course Descriptions**

**Advanced Placement U.S. History I ..... Credits: 5  
Grades 10, 11**

**Advanced Placement U.S. History II..... Credits: 5  
Grades 11, 12**

AP American History is a two-year program that meets the state requirement in U.S. History. The curriculum of AP American History I & II follows the recommendations of the CollegeBoard and is designed to prepare the student for the Advanced Placement exam. The curriculum includes an in-depth study of American History from the colonial period to the present. Political, social, and economic issues are studied. The AP student is expected to take the Advanced Placement American History Exam in May of his/her junior year. **Summer assignment required in each course.**

**Social Studies SI ..... Credits: 5  
Grades 9, 10, 11, 12**

This multi-grade/multi-ability-level course for beginning, intermediate, and advanced English Language Learners (ESL I, II, III) will meet both social studies content objectives and language objectives in a differentiated, sheltered-instruction learning environment. With access to a variety of texts and materials, this course will account for both American and world history in an effort to bridge student progress for placement the next year into the grade-level appropriate social studies course.

**U.S. History I (A, S)..... Credits: 5**  
**Grades 10, 11**

*Participation in the Standard (S) level course is an academic placement decision.*

This course, a requirement for graduation, is a survey of the period 1585 to 1914. You will gain an understanding of the political, economic, and social development of the nation and of major domestic and foreign issues in the time period of the course. There are eight units of study composing the course. You will study: founding of our nation, nationalism, expansion and sectionalism, economic and political development, foreign policy, and the development of culture and thought. New Jersey history will also be an integral part of the course. The course will be offered at both a standard and an academic instructional level.

**U.S. History I (Honors) ..... Credits: 5**  
**Grades 10, 11**

This program is available to students who demonstrate an interest and an aptitude for in-depth study of American History. Students will be required to do concentrated reading and writing, an in-depth study of various interpretations of American history, individual research, and independent study.

**U.S. History II (A, S) ..... Credits: 5**  
**Grades 11, 12**

*Participation in the Standard (S) level course is an academic placement decision.*

This is a mandatory full year course required of all students for graduation. The course is a survey of American history from World War I to the contemporary world. A thematic approach to the study of political, economic, and social changes as well as major foreign policy events will highlight this course. The course will be offered at both a standard and an academic instructional level.

**U.S. History II (Honors)..... Credits: 5**  
**Grades 10, 11**

This program is available to students who demonstrate an interest and an aptitude for in-depth study of American History. Students will be required to do concentrated reading and writing, an in-depth study of various interpretations of American history, individual research, and independent study.

**World Civilizations II (A, S) ..... Credits: 5**  
**Grade 9**

*Participation in the Standard (S) level course is an academic placement decision.*

This is a state-mandated, full-year course required of all incoming freshmen. Students must successfully complete the course in order to earn credit toward fulfilling the state-mandated graduation requirement. World Civilizations II is a continuation of World Civilizations I begun in 8<sup>th</sup> grade. The focus of the first year of this course was western civilization. The focus of World Civilizations II is non-western civilizations from 1350 through contemporary issues. Students will gain an understanding of the geography, environment, economic innovation/technology, history, and culture of major non-western civilizations.

**World Civilizations II (Honors)..... Credits: 5**  
**Grade 9**

This program is available to students who demonstrate an interest and an aptitude for in-depth study of World Civilizations. Students will be required to do concentrated reading and writing, an in-depth study of various interpretations of World Civilizations, individual research, and independent study.

**Social Studies Electives**

The Social Studies Department offers elective courses to meet student needs and interests. Students are welcome to take any or all of these courses but are reminded that none of these courses meets the New Jersey State Mandate for three years of Social Studies.

**Advanced Placement European History ..... Credits: 5**  
**Grades 11, 12**

This course is offered for students who want preparation for the advanced placement exam in European history. This course will strive to strike a balance between factual knowledge and critical analysis. The major themes of study include the following: political and diplomatic history, intellectual cultural history, and social and economic history. This course will cover European history from 1450, the high Renaissance, to the recent past.



**Advanced Placement Government and Politics, US..... Credits: 5**  
**Grades 11, 12**

This course is offered for students who want preparation for the Advanced Placement exam in Government and Politics, United States. It will give students an analytical perspective on government and politics in the United States. Government and Politics will include both the study of general concepts used to interpret U.S. politics and the analysis of specific examples. It will also require familiarity with the various institutions, groups, beliefs, and ideas that constitute U.S. politics. There are six major topics in the course: I. Constitutional Underpinnings of United States Government; II. Political Beliefs and Behaviors; III. Political Parties; Interest Groups and Mass Media; IV. Institutions of National Government; V. Public Policy and, VI; Civil Rights and Civil Liberties.

**Advanced Placement Psychology ..... Credits: 5**  
**Grades 11, 12**

This course is offered for students who want preparation for the Advanced Placement exam in Psychology. Students will be introduced to the discipline of psychology by emphasizing the history of psychology as a science, the different theoretical approaches that underlie explanations of behavior, and the contemporary research methods used by psychologists. The course traces the emergence of scientific psychology in the nineteenth century from its roots in philosophy and physiology and covers the major "schools" of psychology, showing how these schools differed in what they viewed as the proper subject matter of psychology and the methods used to study it. The scientific nature of psychology is made clear through coverage of the methods psychologists use to answer behavioral questions. Emphasis is given to the experimental method and issues of appropriate experimental sampling and control. Finally, students learn about the many different fields within psychology and about the importance of ethics in both scientific research and the practice of psychology.

**Advanced Placement Research..... Credits: 5**  
**Grade 12**

*Prerequisite* - At least a course grade of B- in **AP Seminar**

**AP Research** allows students to deeply explore an academic topic, problem, or issue of individual interest. Through this exploration, students design, plan, and conduct a year-long research-based investigation to address a research question. In the **AP Research** course, students further their skills acquired in the **AP Seminar** course by understanding research methodology; employing ethical research practices; and accessing, analyzing, and synthesizing information as they address a research question. Students explore their skill development, document their processes, and curate the artifacts of the development of their scholarly work in a portfolio. The course culminates in an academic paper of 4000-5000 words (accompanied by a performance or exhibition of product where applicable) and a presentation with an oral defense.

**Advanced Placement Seminar ..... Credits: 5**  
**Grades 11, 12**

*Prerequisite* – Must meet AP/Honors eligibility requirements in both English and Social Studies

**AP Seminar** is a foundational course that engages students in cross-curricular conversations that explore the complexities of academic and real-world topics and issues by analyzing divergent perspectives. Using an inquiry framework, students practice reading and analyzing articles, research studies, and foundational, literary, and philosophical texts; listening to and viewing speeches, broadcasts, and personal accounts; and experiencing artistic works and performances. Students learn to synthesize information from multiple sources, develop their own perspectives in written essays, and design and deliver oral and visual presentations, both individually and as part of a team. Ultimately, the course aims to equip students with the power to analyze and evaluate information with accuracy and precision in order to craft and communicate evidence-based arguments.

**Advanced Social Studies-Abnormal Psychology\* ..... Credits: 2.5****Grade 12**

*Prerequisite* - At least a course grade of B- in **AP Psychology**

This course covers the major psychological disorders related to patterns of maladaptive behavior. It emphasizes biological, psychological, and social perspectives on causation, treatment, and prevention of these. Topics covered include the following: Defining "abnormality" and maladaptive behavior; History of concepts and treatment for psychological disorders; Biological, psychological, social models of psychological disorder; Research methods in clinical psychology; Diagnosis of psychological disorders; Clinical psychological testing and measurement; Disorders of childhood and adolescence; Anxiety, somatoform, dissociative disorders; Psychological factors in illness and injury; Personality and impulse control disorders; Substance abuse and dependence; Sexual and gender identity disorders, sexual assault; Mood disorders; Suicide; Schizophrenia; Cognitive and neurological disorders; Legal and ethical issues in mental health. Students will develop an appreciation of the range of behaviors that can be characterized as "abnormal" and the treatments for these disorders. Students will also gain an appreciation of how the "abnormal" behaviors studied in class are not unusual, but rather a part of everyday life.

\*This course will be given AP weight in the calculation of the student's GPA.

**Advanced Social Studies-Social Psychology\* ..... Credits: 2.5****Grade 12**

*Prerequisite* - At least a course grade of B- in **AP Psychology**

Social Psychology will focus on the way people think, feel, and act as individuals and groups within social situations. Students will cultivate the skills necessary to recognize and respond to social situations and events they encounter in their everyday lives. Topics to Include: Conformity and Obedience; Prosocial behavior and Antisocial behavior; Stereotypes and Prejudice; Persuasion; Interpersonal attraction. The course will involve examining experiments, current research, and writing. Students in the course will be expected to participate in regular discussions in a seminar style using research.

\*This course will be given AP weight in the calculation of the student's GPA.

**American Law (A) ..... Credits: 2.5****Grades 10, 11, 12**

This semester elective is designed to acquaint students with both legal rights and responsibilities. Court decisions, case studies, and guest speakers will be used to give students practical insight into the mechanics of the judicial process and the theory of the legal system. Students will study criminal, civil, tort, contract, consumer, juvenile, and constitutional law.

**Civics (A) ..... Credits: 2.5****Grades 9, 10, 11, 12**

Civics is the study of citizenship and government. This one-semester course is an investigative study of American political behavior that provides students with a basic understanding of civic life, politics, and government at both a federal and state level. The class includes a short history of government's foundation and development in this country and also explores current issues the different branches are addressing. Students will learn how power and responsibility are shared and limited by government, the impact American politics has on world affairs, the place of law in the American constitutional system, and which rights the American government guarantees its citizens. Students will also explore how the world is organized politically and how civic participation in the American political system compares to that in other societies around the world today. The focus of this course is to prepare students to participate in exercising their political responsibilities as thoughtful and informed citizens.

**Cultural Ceramics ..... Credits: 2.5 in Art or Social Studies****Grades 9, 10, 11, 12**

All societies depend upon the earth for survival. By carefully using earthen materials to express themselves and the beliefs of their culture people worldwide and throughout time have created ceramics. Students in Cultural Ceramics investigate the values and beliefs of one culture by discovering and interpreting its art and works in clay. In a personal way, students then explain the work of the other culture and express themselves by creating ceramic objects. Students declare for credit in art **or** social studies and follow appropriate course requirements.

**Economics Today (A) ..... Credits: 2.5****Grades 9, 10, 11, 12**

This semester course will meet the 2.5 credit state requirement for financial, economic, business, and entrepreneurial literacy. The course is designed to teach students about key principles of economics and how Economics relates to them. Students are provided an opportunity to analyze and assess the cause/effect relationships of economics. Students will take a "hands on" approach in understanding the real life application of the economic infrastructure and their role in it. The course will enhance student competence in understanding theoretical underpinnings and functional knowledge in economics to become informed consumers, producers, and citizens in today's world.

**Global Studies (A) ..... Credits: 5****Grade 12**

Today, we find that many problems have transcended the boundaries of nations and have become global issues. Issues such as economic development, environmental concerns, energy alternatives, national security, and human rights have become concerns for all humankind. This course will examine major global issues at a level appropriate for the student.

**Global Studies (Honors) ..... Credits: 5****Grade 12**

This full year course is aimed at those students who demonstrate an aptitude for concentrated study in the social studies. As in other honors level courses, students will be required to complete extensive reading and writing, individual research, and independent study. The course content will be tied to global issues such as economic and human development, environmental problems, global security, and the idea of alternative futures. The approach will be one of problem solving.

**Historical Exploration ..... Credits: 2.5****Grades 11, 12**

*Historical Exploration* is an academic level, project based, elective course offered only in the first semester to coincide with the National History Day competition. Students will have the unique opportunity to research, analyze, and present a historical topic of interest that coincides with the annual theme for National History Day. The course will enable students to develop their research and presentation skills, as well as to expand their knowledge of and interest in a particular US History topic. Students with a real interest and passion for American history will find this course particularly appealing.

**Human Development (A) ..... Credits: 2.5****Grades 10, 11, 12**

In this introduction to psychology, students will survey the thematic topics of: human development, personality, and the learning process as well as the working of the mind and body. As a result, students will better understand themselves, their personal needs, and the desire for positive and constructive behavior.

**Pop Culture: 20<sup>th</sup> Century. .... Credits: 2.5****Grades 10, 11, 12**

This course will provide students with an understanding of major trends in art, literature, movies, music, radio, television, theater, and fads during the last 100+ years. Students will gain an understanding of these cultural trends set against the backdrop of World War I, the Roaring 20's, the Great Depression, World War II, the Cold War, the Era of Camelot and the Great Society, the Vietnam Era, and the Post-Cold War era.

**Sociology (A) ..... Credits: 2.5****Grades 10, 11, 12**

This semester elective is designed so that you will be able to analyze the social structure of American and global society. You will study the tools of sociology, socialization, social interaction, social forces, the concept of social structure, and the five social institutions. You will also examine current changes and problems of American and global society. Topics such as crime, deviance, racial, ethnic and gender issues, organization, and social fads are all examined.

**Women's Studies: Evolving Image of Women (A) ..... Credits: 2.5****Grades 9, 10, 11, 12**

This semester elective will explore how traditional gender roles were both developed and challenged with the growth of the United States through the 19<sup>th</sup> Amendment. Students will explore the impact of these traditional gender roles on the lives of women today, both in the United States and around the world, in the context of issues like health and reproduction, crime and abuse, and the media and body image. One of the goals of this course is to break down preconceived notions and to inform and change attitudes about women in American society as well as women around the world.

**Women's Studies: Social Change, Changing Gender Roles (A) ..... Credits: 2.5  
Grades 9, 10, 11, 12**

This course will examine how modern gender roles have been shaped and changed by the events and trends of the 20<sup>th</sup> Century. Gender roles in the family and workplace are affected by social, economic, and political changes. Students will explore how key events of the 20<sup>th</sup> century also influenced women in different regions around the world. One of the goals of this course is to break down preconceived notions and to inform and change attitudes about women in American society as well as women around the world.

## World Languages

**Supervisor: Ms. Maria Kostis - 908-231-8660 ext. 2268**

The following flow charts illustrate possible sequencing of courses within the department. Students are encouraged to take the most challenging courses (differentiated by level of rigor) in which they will be most successful. Movement across options is possible. This is determined by student ability, motivation, and achievement. **Students are encouraged to read specific course descriptions prior to selection, taking note of prerequisite and recommendation requirements.**

### Option #1 Most Rigorous

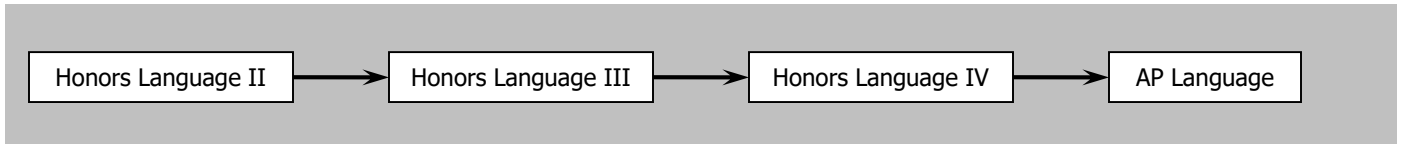

### Option #2 Very Rigorous

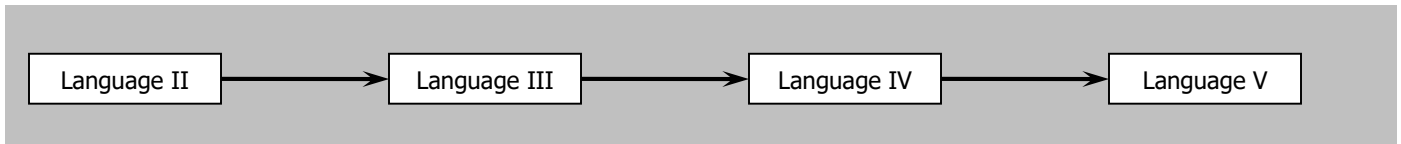

### Option #3 Rigorous

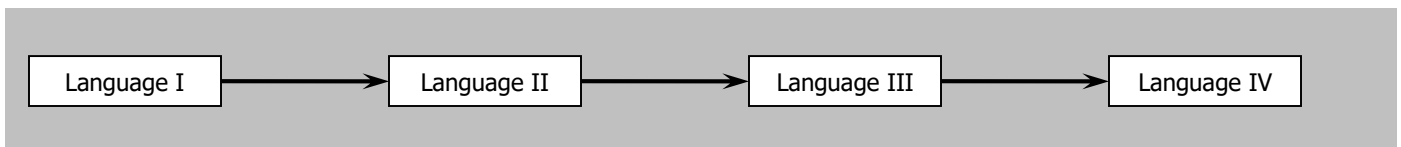

### Changing a World Language Honors Course:

It is suggested to start the world language honors program in level II. The study of a world language is cumulative and the honors curriculum is the most rigorous, thus naturally providing the students with much knowledge and many language skills. Moving into a world language honors course from the academic program in level III and above requires intensive summer study to enhance knowledge and skills to allow for success in the honors course.

The dropping of a world language honors course is serious and can be done only with the written permission of the parent/guardian and consultation with the School Counselor and department supervisor. Students who drop a world language honors course for whatever reason and request to take an academic level course instead must make a lateral move. They cannot change course levels. Example: A student dropping Spanish III H must switch into Spanish III A. She/he may not schedule into Spanish IV A.

**Advanced Placement Chinese, French, German, Italian, Spanish Language ..... Credits: 5  
Grades 11, 12**

*Prerequisite* - Level IV-H or departmental approval

The Advanced Placement Chinese, French, German, Italian, or Spanish Language course is intended for those students who wish to take the Advanced Placement Examination in May. The course is designed to develop students' knowledge of Chinese, French, German, Italian, or Spanish equivalent to a third year college course. Great emphasis is placed on the mastery of interpretive (listening and reading), interpersonal (person to person), and presentational (speaking and writing for an audience) skills.

A continuing focus will be the development of vocabulary and idiomatic language usage, the advancement of cultural knowledge and skills, and the ability to communicate actively in a variety of oral and written forms. A comprehensive review of grammar/characters (Chinese) is also included. Each curriculum provides a challenging program that may lead to college credit or to a student being accepted into an advanced program as a college freshman. **Summer assignment required.**

**Advanced Placement Latin ..... Credits: 5  
Grades 11, 12**

*Prerequisite* - Latin IV-H or departmental approval

The Advanced Placement Latin course is intended for students who wish to take the Advanced Placement – Virgil Examination in May. Students will engage in a close reading of the Aeneid. They will improve their vocabulary and translation skills and learn how to interpret and analyze a masterpiece of literature. They will study the Aeneid against the backdrop of Roman history, mythology, and philosophy. Students will become sensitive to Virgil's elaborate style; they will improve their analytical and higher-order thinking skills, which will serve them well in college and at their future workplace. The curriculum provides a challenging program that may lead to college credit or to a student being accepted into an advanced program as a college freshman. **Summer assignment required.**

**Chinese I, French I, German I, Italian I, Latin I, and Spanish I..... Credits: 5**

Level I courses are **introductory** courses designed for students who are beginning their study of the language for the first time. Students will develop the skills of listening, speaking, reading and writing in the target language. Students will learn about the culture of the country or countries studied.

**Chinese II, French II, German II, Italian II, Latin II, and Spanish II – Academic..... Credits: 5**

*Prerequisite* – successful completion of Level I (MS or HS)

Level II courses are for students who completed Level I at the High School or Middle School. Students will continue to develop the skills of listening, speaking, reading and writing in the target language. Proficiency based assessments are an integral part of the course

**Chinese II, French II, German II, Italian II, Latin II, and Spanish II – Honors ..... Credits: 5**

*Prerequisite* - successful completion of Level I (MS or HS)

Level II honors courses enable motivated students to continue to develop the skills they learned in level I at a more rigorous pace. Emphasis is placed on improving speaking and writing skills. Proficiency based assessments are an integral part of the course

**Chinese III, French III, German III, Italian III, Latin III, and Spanish III – Academic..... Credits: 5**

*Prerequisite* – successful completion of Level II

Level III courses are designed to further individual development of the essential communication skills. Oral proficiency is emphasized. Students read and discuss short stories and selections from contemporary articles on topics of cultural interest. Proficiency based assessments are an integral part of the course.

**Chinese III, French III, German III, Italian III, Latin III, and Spanish III – Honors..... Credits: 5**

*Prerequisite* - successful completion of Level II

Level III Honors courses are designed to further individual development of the communication skills at a rigorous pace. Students will read and discuss short stories and selections from contemporary articles on topics of cultural interest. Grammar will be studied to facilitate accuracy of comprehension and self-expression. Extemporaneous discussion, as well as writing skills, will be incorporated into each unit of study. Proficiency based assessments are an integral part of the course.

**Chinese IV, French IV, German IV, Italian IV, Latin IV, and Spanish IV – Academic ..... Credits: 5**

*Prerequisite* – successful completion of Level III

Level IV courses are designed for students to further develop their communication skills. Reading selections are an important component of the program, and they will help increase students' vocabulary and cultural knowledge. The readings will form the basis for discussion and problem solving. In many types of writing, more creativity will be expected. Knowledge of structural principles of the language will be reviewed in depth and expanded upon with the focus on producing structures to support communication. Proficiency based assessments are an integral part of the course.

**Chinese IV, French IV, German IV, Italian IV, Latin IV, and Spanish IV – Honors ..... Credits: 5**

*Prerequisite* – successful completion of Level III

Level IV Honors is designed to further individual development of communication skills at a rigorous pace. Students will read and discuss short stories and selections from contemporary articles on topics of cultural interest. Students will be provided with ample opportunities to create meaning and use critical thinking skills in order to achieve linguistic proficiency. Grammar learning will take place within a meaningful context, with the focus on producing structures to support communication. Proficiency based assessments are an integral part of the course.

**Chinese V, French V, German V, Italian V, Latin V, and Spanish V – Academic..... Credits: 5**

*Prerequisite* – successful completion of Level IV

Level V courses offer students an opportunity to learn to communicate on an advanced level by reading and discussing many different types of texts. Through reading of literature, as well as selected articles from supplementary materials, vocabulary and comprehension are greatly increased. Classroom activities are designed to give students frequent opportunities to improve oral skills through discussions, impromptu conversation, role playing, and oral reports. Students' writing ability is refined by varied written assignments, grammar review exercises and creative writing. Further insights into the cultures of the countries as well as social issues are gained through a variety of technology-based projects and activities involving problem-solving.

**Spanish for Heritage Speakers – Beginners ..... Credits: 5**

*Prerequisite* – departmental approval only

This course is designed for students who are already able to converse and understand Spanish. Students enrolled in this course should be at a minimum intermediate low level of proficiency in Spanish. The objectives of this course are to expand communication skills and cultural knowledge, as well as improve literacy skills. Students will learn to use Spanish beyond familiar contexts by reading authentic materials and writing for academic purposes. Our thematic curriculum will cover topics which are aligned with the AP Spanish course.



## Health & Physical Education

**Supervisor: Ms. Lois Fyfe - 908-231-8660 ext. 2220**

### **Physical Education I, II, III, IV ..... Credits: 3 or 3.75 per year Required (all students)**

The Bridgewater-Raritan Physical Education Department is committed to educating our students to become lifelong learners of wellness by participating in activities that encourage good health and appropriate social skills and that promote physical fitness in and outside the educational settings. Bridgewater-Raritan students must be provided with opportunities to engage in a physical education program that will develop the necessary skills to participate in individual and team sports and that foster a positive attitude towards physical activities. Students will experience a coeducational physical education program involving large group, team, dual, cooperative, and individual activities.

In ninth and tenth grade, students will be exposed to a variety of activities which include: group initiatives, low confidence course, fitness, field hockey, basketball, floor hockey, lacrosse, soccer, softball, table tennis, team handball, and volleyball.

In grades eleven and twelve, students have the opportunity to participate in a variety of activities that include: aerobics, badminton, basketball, football, hockey sack, pickle ball, soccer, softball, table tennis, punch ball, tennis, ultimate Frisbee, volleyball, weight training, yoga, and the high confidence course.

### **PE Partners ..... Credits: 5 Grades 11, 12**

In lieu of Physical Education III or IV, students can apply to the PE Partners program. P.E. Partners is a collaboration between the special education and physical education departments in which students with developmental disabilities and autism are partnered up with typical students to promote socialization in an active environment.

### **Health I ..... Credits: 1 or 1.25 Required—Grade 9**

Ninth grade Health allows students to investigate the teenage behaviors, human physiological functions, and the avoidance of sexually transmitted diseases including HIV/AIDS. In furthering the wellness concept, students review the methods of balanced nutritional diets and importance of physical fitness as integral parts in total well-being. Other units of study during ninth grade health include: Body Systems, Family Living, Alcohol –Tobacco and Other Drugs, Diseases, Sexuality, Abstinence Education, and Effective Communication Skills.

### **Health II ..... Credits: 1 or 1.25 Required—Grade 10—Driver Education Theory**

Tenth grade Health involves the study of the automobile in modern life and aims to develop mature attitudes and proper habits for safe driving. It is an aid in preparing for the written examination given by the State Department of Motor Vehicles. Included in this course will be a continued study of drugs, alcohol, and tobacco along with their relationship to the operation of a motor vehicle.

### **Health III ..... Credits: 1 or 1.25 Required—Grade 11**

Eleventh grade health includes topics such as Family Living, Mental, Emotional and Social Health, and Human Growth and Development. Students will examine societal influences and the factors that weaken or strengthen relationships. Through a variety of structured classroom experiences, students will learn problem-solving strategies to utilize when confronted with different situations. (Topics can include: healthy or unhealthy relationships, death, harassment, drugs, and diseases). Students will also explore personality development and feelings of positive self-worth. Through a variety of exercises involving the decision making process, students will increase their coping skills in such areas as stress, peer pressure, substance abuse, suicide, and risk situations of sexual assault and abuse.

### **Health IV ..... Credits: 1 or 1.25 Required—Grade 12**

Senior health units include: Cardiopulmonary Resuscitation, Family Living and Human Growth and Development and Disease Prevention. During CPR, students will be given a practical approach to life saving techniques and methods to avoid injuries and illnesses. (Students also have the opportunity to become certified in CPR). During Family Life and Human Growth and Development, students will recognize the development of a child from conception to birth. Students will also study pre-natal and infant care, budgeting for childbirth process, and other responsibilities of parenthood and childrearing.

## Performing Arts

**Supervisor: Dr. Laura Craig - 908-231-8660 ext. 2269**

The following flow chart illustrates the sequencing of courses within the department. **Students are encouraged to read specific course descriptions prior to selection, taking note of prerequisite and recommendation requirements.**

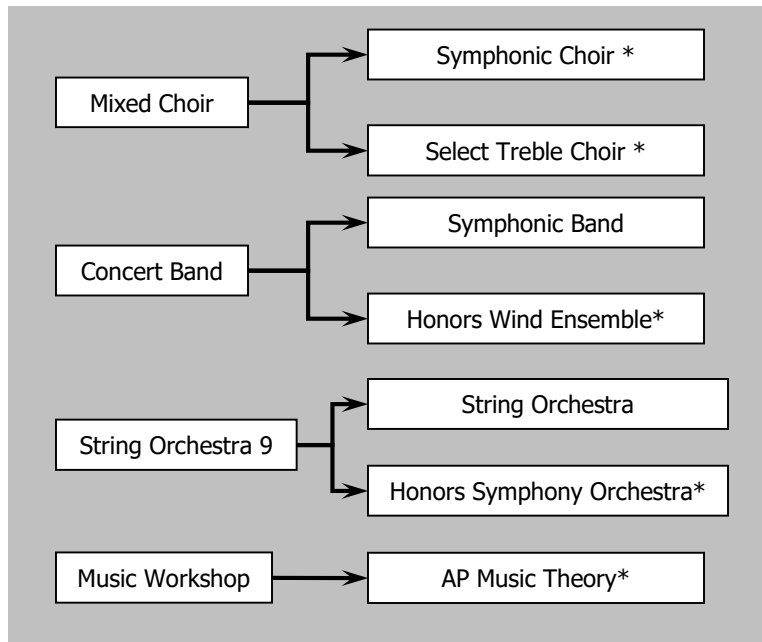

**\* Audition required.**

### Performing Arts Department Course Descriptions

#### **Advanced Placement Music Theory ..... Credits: 5 Grades 11, 12**

*Entrance requirements – Students will be selected for admission to AP Music Theory based on the following criteria:*

- music teacher recommendation and placement exam
- Music Workshop I grades or demonstrated equivalent mastery of theory

This full-year course will provide the student with the equivalent of a college-level music theory course in the study of musical materials, structure, and style. It will integrate melodic, harmonic, textural, rhythmic, and formal aspects of music through musical reading, notation, composition, and active musical listening. Each student's understanding of music history and style will be enhanced by the selection of course materials from the widest possible variety of musical periods, genres, and media. Students are encouraged to take the AP examination in May.

#### **Concert Band ..... Credits: 5 Grade 9**

Band is a full year course where students study and perform standard, popular, and contemporary band literature. The band plays for school functions such as assemblies, athletic programs, and special programs. It also appears at selected civic functions and trips to area or regional festivals. Evening concert and community service performances are a natural outgrowth of this program. Participation is mandatory. Students participating in band are eligible to audition for the orchestra, wind ensemble, jazz ensemble, small ensemble, region and all-state activities.

Included in all choir and instrumental courses are voice and instrument lessons and coaching sessions, individual, if possible, though more likely in small group.



**Introduction to Guitar ..... Credits: 5****Grades 9, 10, 11, 12****Why Guitar?**

Introduction to Guitar requires no previous guitar experience. Students interested in learning guitar will have the opportunity to learn basic chord shapes, notation literacy, and right-hand articulation techniques through songs from a varied repertoire of popular and traditional music.

Guitars will be provided for students for classroom use and at-home practice. The Guitar course is performance-based with homework expectations taking the form of individual practice outside of class.

**Mixed Choir ..... Credits: 5****Grades 9, 10, 11, 12**

This course is designed to introduce and develop healthy vocal technique in ninth grade singers. The Mixed Choir is comprised of students who enjoy singing and want to participate in the four major choir events: the Winter Concert, Festival of the Arts, Broadway Night, and the Spring Concert. All freshman interested in singing are automatically signed up for this ensemble. Many students enrolled in this course wish to make a select ensemble in the future; skills necessary for admission into a select ensemble are a major focus of this class.

The three mandatory rehearsal requirements of the Mixed Choir, in addition to the four major performances of the year, are the Winter Concert dress rehearsal, Festival of the Arts dress rehearsal, and the Spring Concert dress rehearsal.

Students are not required to give extra time beyond these major responsibilities, but they are always encouraged to get involved. Students will have opportunities to audition for solos, Broadway Night, and after school ensembles: Lorelei, Ensembros, and Glee Club.

All BRHS choirs work on vocal technique and sight-reading skills that will help them to improve their confidence and performance should they aspire to become members of the select ensembles and reach a higher level of singing.

Included in all choir and instrumental courses are voice and instrument lessons and coaching sessions, individual, if possible, though more likely in small group.

**Music Workshop ..... Credits: 5****Grades 9, 10, 11, 12**

This course presents an introduction into the basics of music. Included will be the study of the history of music, the development of good listening skills, an introduction to the basic theory of music, and a look into the future via contemporary and electronic music. Class activities will include listening to recordings of ancient through contemporary music, an introduction to composition, and concert attendance.

**Select Treble Choir ..... Credits: 5****Grades 10, 11, 12**

The Select Treble Chorus is the only curricular all treble-voiced group offered at BRHS. This course is designed to continue to develop sight-reading and vocal technique in the developing voice. Students in this course often find themselves singing a variety of different voice parts. The Select Treble Choir rehearses and performs a wide variety of repertoire, ranging from renaissance polyphony to contemporary choral compositions, spirituals, and popular song.

The three mandatory rehearsal requirements of the Select Treble Choir, in addition to the four major performances of the year, are the Winter Concert dress rehearsal, Festival of the Arts dress rehearsal, and the Spring Concert dress rehearsal.

Students are not required to give extra time beyond these major responsibilities, but they may do so if they wish. Students will have opportunities to audition for solos, Broadway Night, and after school ensembles: Lorelei and Glee Club.

As always, the BRHS Choir Program hopes to prepare the members of the Select Treble Choir for a higher level of music should they decide to audition for one of the select groups in the future.

Included in all choir and instrumental courses are voice and instrument lessons and coaching sessions, individual, if possible, though more likely in small group.

**String Orchestra 9 ..... Credits: 5****Grades 9**

The String Orchestra 9 rehearses and performs the standard orchestral literature ranging from Baroque to 20th Century music. The group performs at school assemblies, concerts, and festivals outside the school. Within the String Orchestra are chamber groups that perform for a variety of other events. Participation at scheduled performances is mandatory.

Included in all choir and instrumental courses are voice and instrument lessons and coaching sessions, individual, if possible, though more likely in small group.

**String Orchestra ..... Credits: 5****Grades 9, 10, 11, 12**

The String Orchestra rehearses and performs the standard orchestral literature ranging from Baroque to 20th Century music. The group performs at school assemblies, concerts, and festivals outside the school. Within the String Orchestra are chamber groups that perform for a variety of other events. Wind and percussion players who are current Band class members are accepted, upon successful audition, to augment the String Orchestra for scheduled rehearsals and concerts. Participation at scheduled performances is mandatory.

Included in all choir and instrumental courses are voice and instrument lessons and coaching sessions, individual, if possible, though more likely in small group.

**Symphonic Band ..... Credits: 5****Grades 10, 11, 12**

Band is a full year course where students study and perform standard, popular, and contemporary band literature. The band plays for school functions such as assemblies, athletic programs, and special programs. It also appears at selected civic functions and trips to area or regional festivals. Evening concert and community service performances are a natural outgrowth of this program. Participation is mandatory. Students participating in band are eligible to audition for the orchestra, wind ensemble, jazz ensemble, small ensemble, region and all-state activities.

Included in all choir and instrumental courses are voice and instrument lessons and coaching sessions, individual, if possible, though more likely in small group.

**Symphonic Choir (Honors) ..... Credits: 5****Grades 10, 11, 12**

*Prerequisite* – audition required

The Symphonic Choir is the premier curricular ensemble at BRHS. Its 40 members were selected by a placement audition held in May of the previous year. Students are selected for this group based on their musical audition (tone quality, intonation, musicianship, sight-reading, independence, preparation, tonal memory) and their attitude (ability to work with others, reliability, enthusiasm, dependability).

In addition to participating in the four major choir events throughout the year, the Symphonic Choir prepares repertoire that is performed at festivals and competitions throughout the year. Symphonic Choir will perform challenging music at a high level of proficiency. Though wide-ranging, students will encounter music that represents the very best compositions from the choral repertory, including madrigals, motets, major works, spirituals, and contemporary choral compositions. A member of Symphonic Choir is responsible for being at all rehearsals and performances listed in the BRHS Choir Calendar.

Included in all choir and instrumental courses are voice and instrument lessons and coaching sessions, individual, if possible, though more likely in small group.

**Symphony Orchestra (Honors) ..... Credits: 5****Grades 10, 11, 12**

*Prerequisite* - audition required

The Symphony Orchestra performs advanced orchestral literature, and may be combined with winds and percussion to form a full symphony orchestra. There is strong emphasis on individual performance, leadership, responsibility and musical growth in the exact execution of challenging literature. Participation is by audition and recommendation of the instructor and governed by a rigid consideration for balanced instrumentation. Scheduled public performances are a requirement of the course.

Included in all choir and instrumental courses are voice and instrument lessons and coaching sessions individual, if possible, though more likely in small groups.

**Wind Ensemble (Honors)..... Credits: 5**  
**Grades 10, 11, 12**

*Prerequisite - audition required*

The Wind Ensemble performs advanced band-style literature in the context of a chamber ensemble. Often requiring only a single player on a part, there is strong emphasis on *individual* performance, leadership, responsibility and musical growth. Participation is by audition and recommendation of the instructor and governed by a rigid consideration for balanced instrumentation. Scheduled public performances are a requirement of the course.

Included in all choir and instrumental courses are voice and instrument lessons and coaching sessions, individual, if possible, though more likely in small group.

**Business Education**  
**Supervisor: Dr. Leonard Herman - 908-231-8660 ext. 2263**

The BE Department recognizes that citizens of the 21st Century need to possess a variety of diverse knowledge, skills, and competencies. As a result, the BE Department provides students with a dynamic experience in the field of technology and business from seventh grade through his/her senior year. The BE Department believes that at the middle school level, the program prepares the students with the skills necessary for him/her to be successful during their secondary educational experience. At the secondary-level, the BE Department focus shifts to a philosophy of technology and business integration that will provide students with the necessary skills to succeed in the rapidly changing technological world in which they live.

The staff of BE Department believe that offering a unique blend of curricula will allow students the opportunity to gain the diverse knowledge, skills, and competencies necessary to be successful in the 21st Century. The BE staff accepts all students, no matter of their individual skillset or prerequisite knowledge, and strives to stimulate, encourage, and support their growth in technology and business. The BE Department works hard to ensure that the educational environment is an open and inviting place where everyone is encouraged to learn and feel safe. Innovative curricula allow students to gain knowledge that is then applied, adapted, and utilized to encourage further students to develop the desire to become lifelong learners in our technological society.

All courses in the BE Department are intended to expose students to real-world situations while encouraging them to question and analyze their own knowledge and understanding of the world. Students are challenged to utilize technology to be able to be creative problem-solvers, while strengthening skills necessary to become a leader in their schools, communities, and ultimately in the ever-changing technological world.

The following flow chart illustrates the sequencing of courses within the department. **Students are encouraged to read specific course descriptions prior to selection, taking note of prerequisite and recommendation requirements.**

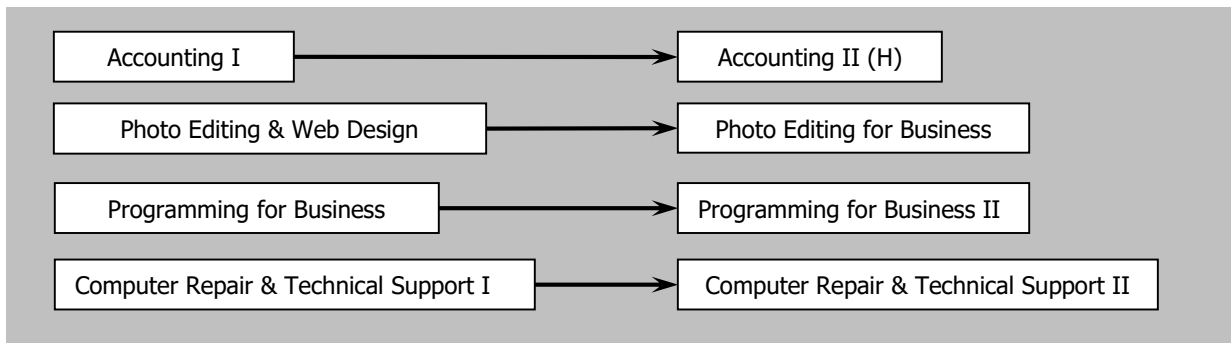

## **Business Education Department Course Descriptions**

### **Academic Internship Program ..... Credits: 7.5 or 15**

#### **Grade 12**

The Academic Internship Program is a senior-level program designed for the student who wants to gain valuable work experience in a business environment. This program is designed to provide on-the-job training in an office-related occupation that corresponds with a student's career objective. This is a unique program that capitalizes on a high level of student motivation and gives the student the opportunity to "learn by doing." Students are to report to work placements for the final two periods of the day. In addition to the afternoon work experience, students will attend a related class in the morning to further develop their office skills and obtain guidance in adjusting from the school environment to the world of work.

### **Accounting I ..... Credits: 5**

#### **Grades 9, 10, 11, 12**

This subject is the introductory course of a recommended two-year sequence, which will introduce students to the basic principles, concepts, and procedures of accounting, including computerized accounting. Students will go through the entire accounting cycle from analyzing and recording transactions to preparing financial statements. The emphasis will be placed on accounting procedures for a proprietorship form of business organization. Accounting career opportunities will be explored. *Note: This class is eligible for college credit at Raritan Valley Community College under the Tech Prep Program.*

### **Accounting II (H)..... Credits: 5**

#### **Grades 10, 11, 12**

*Prerequisite* - Accounting I and grade of "A-" or better

This is the second course of a recommended two-year sequence. The emphasis will be placed on accounting procedures and concepts as they apply to proprietorship, partnerships, and corporations. Also, students will learn to interpret and analyze financial reports. The computer will be used to perform accounting functions throughout the course and career opportunities in the accounting field will be explored for entry-level employment or further study. *Note: This class is eligible for college credit at Raritan Valley Community College under the Tech Prep Program.*

### **Advanced Placement Macroeconomics..... Credits: 5**

#### **Grades 11, 12**

*Prerequisite* – Eligibility is based upon final grades earned in **both** English and Mathematics courses. Grades of "B-" or higher must be earned in AP/Honors English/Mathematics level courses or "A-" or higher in Academic level English/Mathematics courses.

The purpose of this AP course is to give students a thorough understanding of the principles of economics that apply to an economic system as a whole. The curriculum places particular emphasis on the study of national income and price determination and also develops students' familiarity with economic performance measures, economic growth, and international economics. Coverage of these concepts provides students with the foundation for a thorough understanding of macroeconomics in a global context.

### **Advanced Placement Microeconomics..... Credits: 5**

#### **Grades 11, 12**

*Prerequisite* – Eligibility is based upon final grades earned in **both** English and Mathematics courses. Grades of "B-" or higher must be earned in AP/Honors English/Mathematics level courses or "A-" or higher in Academic level English/Mathematics courses.

This college level course is an in-depth study of how individuals, firms, and organizational structures make economic decisions. Areas of study will include the following: demand and supply analysis, allocation of goods, services, and factors of productivity, and the distribution of goods and services throughout the economy. Students will evaluate the strengths and weaknesses of economic decision-makers by employing concepts of efficiency and equity. Throughout the course, learning emphasis is placed on reasoned, logical argument using economics as a method and model for decision-making.

### **App Development ..... Credits: 2.5**

#### **Grades 9, 10, 11, 12**

This course introduces students to programming technologies, design, and development related to mobile applications. Topics include accessing device capabilities, industry standards, operating systems, and programming for mobile applications. The main thrust of the course will be "hands on" experiences in developing Apps that pertain to students' everyday life and needs.

**Business & Criminal Law ..... Credits: 2.5****Grades 9, 10, 11, 12**

The legal environment of Business and Criminal Law overlap quite frequently. This course will provide an overview of both areas as a way to introduce students to various aspects of business and criminal law for both institutions and persons in society, general legal and social law. Throughout, emphasis is placed on the basic theory of the business and criminal law and the relationship between doctrines and the various justifications for imposition of punishment. Some interesting and thought provoking topics include: Consumer Protection, Employment Law, Criminal Law, and The Law of Torts.

**Career Exploration and Awareness..... Credits: 2.5****Grades 9, 10, 11, 12**

This course is designed for students to explore career opportunities and prepare themselves for employment. Students will take self-assessments and study employment trends to help them focus on career considerations. They will explore various tools used to evaluate and research careers, colleges and trade schools. This class will examine skills and professional conduct required in the workplace. Students will explore laws regarding employment as well as employee benefits, salary, and taxes. Students will also create a customized resume and cover letter to prepare for, and participate in a mock interview.

**Computer Applications & Keyboarding..... Credits: 2.5****Grades 9, 10, 11, 12**

Computer Applications & Keyboarding is a course designed to teach students how to use the computer as a business and personal tool through the use of applications software. In addition to basic keyboarding, the appropriate software for database management, word processing, graphics, and spreadsheets will be used. Students will have the opportunity to learn to use the Internet safely and effectively for research and information retrieval.

**Computer Repair and Technical Support I ..... Credits: 2.5****Grades 9, 10, 11, 12**

This hands on PC repair course familiarizes students with standard PC hardware and software systems. Students dismantle and reassemble a PC, learning about industry standard hardware systems and components. Students will also be introduced to and practice standard PC support techniques with special regard to personal safety and system reliability. Diagnosis and resolution of common hardware failures and configuration/compatibility issues is stressed and students are given hands-on practice using proven troubleshooting techniques to solve problems.

**Computer Repair and Technical Support II..... Credits: 2.5****Grades 9, 10, 11, 12**

*Prerequisite* - Computer Applications & Keyboarding and Technical Support I

This hands-on course builds on the knowledge acquired in Computer Repair and Technical Support I and provides an advanced understanding of hardware, networks, and operating systems in a PC environment. Diagnosis and resolution of common software failures are stressed and students are given hands-on practice using proven troubleshooting techniques to solve problems. Participants learn to install, configure, upgrade, and repair an operating system with particular focus on managing the software configuration of the system. Students will also explore the career of the PC technician and opportunities in this field.

**Desktop Publishing & Multimedia Presentations ..... Credits: 2.5****Grades 9, 10, 11, 12**

This course challenges students to utilize creativity, critical thinking skills, and goal setting. Multimedia enhances the way people think, work, learn, communicate, and even the way they interact. This course is designed to give students the knowledge to create professional publications for a wide variety of real-world applications as well as the power to effectively communicate ideas and information. Each student will maintain a portfolio of projects to document their development.

**Entrepreneurship & Business Management ..... Credits: 2.5****Grades 9, 10, 11, 12**

*Prerequisite* – Introduction to Business

This course will focus on the steps to take when creating a business, including recognizing a business opportunity and developing the opportunity into a small business. Through the development of a business idea students will work collaboratively to write a business plan and pitch the idea to the other members of the class.

**Financial Planning..... Credits: 2.5****Grades 11, 12**

This course was developed to provide high school students with the knowledge and skills necessary to manage their personal finances. Students will learn how to evaluate the potential risks and rewards involved in making financial decisions. This class covers credit management, credit laws, debt, bankruptcy, financial fraud, saving, banking, and budgeting. Students will be introduced to investing in stocks, bonds, mutual funds, index funds, ETFS and basic retirement planning.

**International Business..... Credits: 2.5****Grades 9, 10, 11, 12**

This course will provide students with the foundation necessary to understand international business and the various aspects of conducting business in a global economy. It will aid students in gaining an understanding about the customs of people from different geographic, cultural, racial, and ethnic backgrounds of the world. Students will study the technological advances of the Internet and e-commerce to provide goods and services worldwide. This course prepares students to work, live, and think in a global environment.

**Introduction to Business ..... Credits: 2.5****Grades 9, 10, 11, 12**

This course is designed to introduce students to business and financial literacy. Students will be exposed to business terminology, concepts, and practices as well as personal finance. Students will establish a basic business vocabulary and foster critical thinking while evaluating current business practices. Topics covered in this class include basic economics, types of business ownership, owning and operating a business, business ethics, international business, credit, budgeting, banking, and investment strategies.

**Introduction to Marketing through Social Media ..... Credits: 2.5****Grades 9, 10, 11, 12**

*Prerequisite* - None (Suggested: Introduction to Business)

This course is designed to build core Marketing skills and analyze the evolving social media landscape. Students are introduced to such topics as Advertising, Marketing Plans, International Marketing, the Marketing Mix, Consumer Behavior, and the Product Life Cycle. Students also learn how Marketers use Social Media platforms to market products and services.

**Leadership & Philanthropy ..... Credits: 2.5****Grades 9, 10, 11, 12**

This course will provide students with the opportunity to study the effective leadership skills to address problems with their community. Participants will be exposed to the concepts and principles of philanthropic work and the challenge of sustained service. There will be "hands on" real world philanthropy project will be developed during the course.

**Notetaking & Study Skills ..... Credits: 2.5****Grades 9, 10, 11, 12**

This course is designed to teach students organization skills and strategies that will contribute to academic success in their major courses. Students will learn the process and procedures of rapid and efficient note taking. In addition, this course will help students to improve their writing, method of studying, analyzing material heard or read, and organizing usable notes for report and test preparation. Students' notetaking skills will be helpful to them as they continue their high school or advanced education.

**Photo Editing and Web Design ..... Credits: 2.5****Grades 9, 10, 11, 12**

Photo Editing and Web Design will introduce students to the technology needed to edit photographs and create websites. Students will create various "hands-on" projects in a variety of genres and will learn to take ideas and see them through to the finished product. Students will learn to work cooperatively in a group setting as well as work individually. Emphasis will be place on goal setting and attainment.

**Photo Editing for Business..... Credits: 2.5**  
**Grades 9, 10, 11, 12**

*Prerequisite* - Photo Editing and Web Design or CAD Technologies I

This course builds on the foundation learned in Photo Editing and Web Design. It will focus on teaching students to create and/or modify images, text, and other items needed to produce an effective print advertisement. The course will cover concepts such as taking digital photographs, importing them into a computer, and altering them in order to improve quality and remove any imperfections. These photo enhancing techniques will be taught through an advertising-based curriculum. The goal of image enrichment will be to stimulate an audience through advertising.

**Programming for Business ..... Credits: 2.5**  
**Grades 9, 10, 11, 12**

This course will use object-oriented programming languages to solve business and consumer related problems. Emphasis is placed upon finding creative solutions to simulated problems in "real-world" situations. Students will develop a computer/programming vocabulary that will be a valuable tool for this technological age in which we live.

**Programming for Business II ..... Credits: 2.5**  
**Grades 9, 10, 11, 12**

*Prerequisite* - Programming for Business

This course builds on the learning that began in Programming for Business. This course is a must for students who want to gain a working knowledge of computer programming in an object-oriented environment. A majority of the course time is spent working independently or in groups designing, developing, implementing, and trouble-shooting complex windows applications similar to those being used in our society today.



## FAMILY AND CONSUMER SCIENCES

**Supervisor: Dr. Leonard Herman - 908-231-8660 ext. 2263**

It is the intent of the FCS Department to prepare our students with the necessary skills to be successful and productive members of a technological society. Our courses place an emphasis on problem solving, critical thinking, and providing an outlet for individualized creative expression. Courses strongly emphasize the development of career awareness, critical thinking, collaboration, and communication skills. The curriculum includes the integration of technology, time management, problem-solving, and cooperative learning. In addition, students develop interpersonal skills by working in groups with classmates from a variety of socioeconomic and culturally diverse backgrounds.

We further believe that:

- Originality and artistic expression are critical elements for the success of students within the department as well as beyond their high school experience.
- Students explore their creative interests through the exploration of culture, design, creation, and presentation of original work, aesthetics, and analysis.
- The foundation of artistic understanding provides students with a unique perspective, which allows them to view their world differently.

The FCS Department offers the student a wide range of courses that emphasize practical problem solving which will enhance their lives and further prepare them for the 21<sup>st</sup> Century technologically based society in which they live.

The following flow chart illustrates the sequencing of courses within the department. **Students are encouraged to read specific course descriptions prior to selection, taking note of prerequisite and recommendation requirements.**

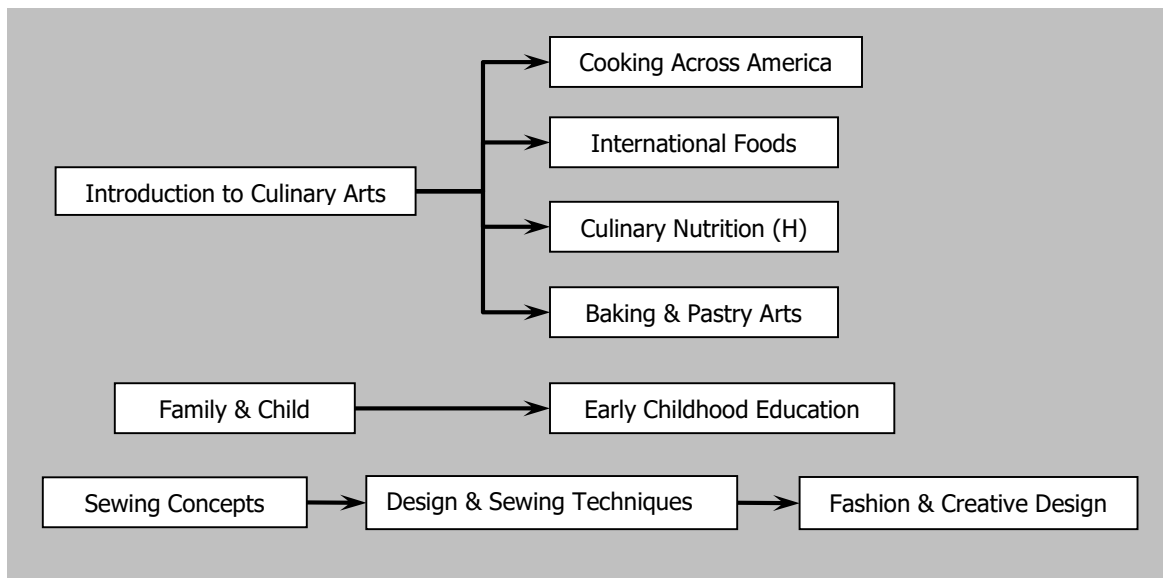

### Family and Consumer Sciences Department Course Descriptions

#### **Baking & Pastry Arts..... Credits: 2.5**

#### **Grades 9, 10, 11, 12**

*Prerequisite* - Introduction to Culinary Arts

This course allows students to delve deeper into their exploration of the components of Baking & Pastry Arts developed in Introduction to Culinary Arts. Hands-on laboratory experiences will place a stronger emphasis on technique, creation, design, presentation, and analysis. Students will begin a more detailed exploration of ingredients used in baking and their function in producing a vast array of products. The focus will be placed on the importance of weights and measures along with recipe comprehension and interpretation. The foundational skills of communication, decision making, and teamwork will continue to be stressed while students more freely develop their own creative interest within the food industry.



**Cooking Across America ..... Credits: 2.5****Grades 9, 10, 11, 12***Prerequisite* - Introduction to Culinary Arts

Students delve deeper into their exploration of the components of culinary arts developed in Introduction to Culinary Arts. Stronger emphasis is placed on creation, design, presentation, and analysis. Through food preparation, students will take a regional tour of the United States, stressing the fundamentals of the historical, cultural, and aesthetic diversity of American regional cooking. The foundational skills of communication, decision making and teamwork continue to be stressed while students are given more freedom to develop their own creative interest.

**Culinary Nutrition (H) ..... Credits: 2.5****Grades 10, 11, 12***Prerequisite* - Introduction to Culinary Arts and a grade of A- or better

Students delve deeper into their exploration of the components of culinary arts developed in Introduction to Culinary Arts. Stronger emphasis is placed on creation, design, presentation, and analysis. Through creative hands-on labs using varied ingredients from all food groups, students will explore the roles food plays in our lives and the science of food. Emphasis is placed throughout on the fundamentals of nutrition and the role of the essential nutrients in maintaining health. The foundational skills of communication, decision making and teamwork continue to be stressed while students are given more freedom to develop their own creative interest.

**International Foods ..... Credits: 2.5****Grades 9 10, 11, 12***Prerequisite* - Introduction to Culinary Arts

Students delve deeper into their exploration of the components of culinary arts developed in Introduction to Culinary Arts. Stronger emphasis is placed on creation, design, presentation, and analysis. Through food preparation, students will take an international tour of the world and become familiar with various ethnic backgrounds and their respective cuisines. Special focus will be given to history, culture, and aesthetic diversity of the countries studied. The foundational skills of communication, decision making and teamwork continue to be stressed. Students will learn how cultural foods connect us through their original and artistic expression of food preparation as a creative outlet.

**Family and Child ..... Credits: 2.5****Grades 11, 12**

For students who are interested in working with children, this course will explore the place of the family and child in society. Childhood behavior patterns and needs of the two- to six-year-old are studied. Experiences include setting up preschool with special attention on health and safety, creative activities, and childhood routines. This will provide an opportunity for a student to observe the behavior of children in an actual preschool setting. Research projects supplement teaching experiences developed and conducted in the Family and Consumer Science classroom.

**Early Childhood Education ..... Credits: 2.5****Grade 12 or Spring Semester Grade 11***Prerequisite* - Family and Child

This course is geared towards students interested in pursuing a career in the field of Early Childhood Education. As an extension of Family and Child, this course will delve into careers available in the field and will continue to focus on the education of the young child. Students will be collaborating in groups to create more challenging lesson plans to enhance the developmental growth and abilities of the young child. Students will work in a preschool laboratory setting to create and implement their age-appropriate lessons and activities.

**Family and Consumer Sciences ..... Credits: 2.5****Grades 9, 10, 11, 12**

Family and Consumer Sciences is a semester course offered to students in grades 9 - 12. This is a survey course in which the student is given an opportunity to briefly explore three main areas of Family and Consumer Sciences. These areas include: Foods and Nutrition, Clothing, and Child Development.

**Sewing Concepts ..... Credits: 2.5****Grades 9, 10, 11, 12**

This is an introductory course that will allow students to explore their interests and talents in clothing construction. It is a hands-on learning environment that encourages peer planning, collaboration, and creative thinking. By planning and constructing articles of clothing, the student is given an opportunity to develop personal skills in the selection of clothing to suit figure, coloring, personality, and budget. An integral part of this course is the construction of individual garments/projects that will foster an awareness of equipment use, terminology, pattern labeling and directions, and a familiarity with a wide selection of fabrics and construction techniques.

**Design & Sewing Techniques..... Credits: 2.5****Grades 9, 10, 11, 12***Prerequisite - Sewing Concepts*

This course is an advanced class which utilizes sewing techniques learned in the prerequisite course - Sewing Concepts. Students will apply more advanced sewing skills and techniques (i.e. seam finishes, darts, easing, gathering, facings, hems, use of serger, hand sewing) in designing and constructing clothing for themselves, family members, or home projects. The use of unique and challenging fabric types and designs will be emphasized as well as pattern alterations. Completion of a needlework design will foster their hand-sewing abilities. In addition to the required projects, students will apply their creativity in re-engineering an old, unused item to create an aesthetically appealing garment/project.

**Fashion & Creative Design\* ..... Credits: 2.5****Grades 10, 11, 12***Prerequisite - Design & Sewing Techniques*

This course is an advanced class which utilizes sewing techniques learned in the prerequisite course - Design and Sewing Techniques. Students will create and construct new original garments by altering existing patterns or combining two or more patterns. Use of fashion croquis, fashion design apps, and various software will enable students to create original designs. Fashion trends, designers, and history will be explored via an assortment of fashion publications, tailored to one's area of interest. It is a must for students who are considering pursuing a career in the fashion industry. Additionally, this course will lay a strong foundation for continued independent construction, altering, and creativity of future garments and projects.

**Home & Interior Design\* ..... Credits: 2.5****Grades 9, 10, 11, 12**

Students will be introduced to the fundamental skills required in the planning, design, and execution of architectural interiors and their furnishings. Housing is a basic human need and accounts for the largest percentage of annual household expenses. Changing global demographics have created housing issues that must be satisfied through innovative design solutions. Students will examine the impact of history, culture, and the environment on current and future trends. Hands-on projects provide opportunities for creative expression and demonstration of comprehension and are a required major component which will parallel coursework. Varied career opportunities and entrepreneurship will also be explored.

**Introduction to Culinary Arts..... Credits: 2.5****Grades 9, 10, 11, 12**

Students will be introduced to the fundamental culinary arts skills required in food preparation, presentation and product analysis. Frequent lab cooking experiences are a required major component which will parallel coursework. Emphasis is placed on safety, sanitation, proper use of tools and equipment along with recipe interpretation. Also stressed is the mastery of foundational skills including communication, decision making and teamwork to create the knowledge base necessary for success in the higher level culinary arts courses.

Note: This course is a prerequisite for all culinary courses.

**Today's Living ..... Credits: 5****Grade 12**

Ever wonder where you are going to learn all the skills you need to be an adult? This course for seniors is designed to equip students with skills to manage life as an independent adult and prepare them for life after high school. This course fulfills the Financial Literacy requirement for graduation while discussing other topics that help students become successful contributors to their families and society. Many areas of study will be discussed to reach this objective. Topics to be discussed will include: communication skills, personality, career planning, consumerism, new technology resources, renting, banking, managing credit, budgeting, taxes, insurance, relationships, and stress management.

## Fine Arts

**Supervisor: Dr. Leonard Herman - 908-231-8660 ext. 2263**

The following flow chart illustrates the sequencing of courses within the department. **Students are encouraged to read specific course descriptions prior to selection, taking note of prerequisite and recommendation requirements.**

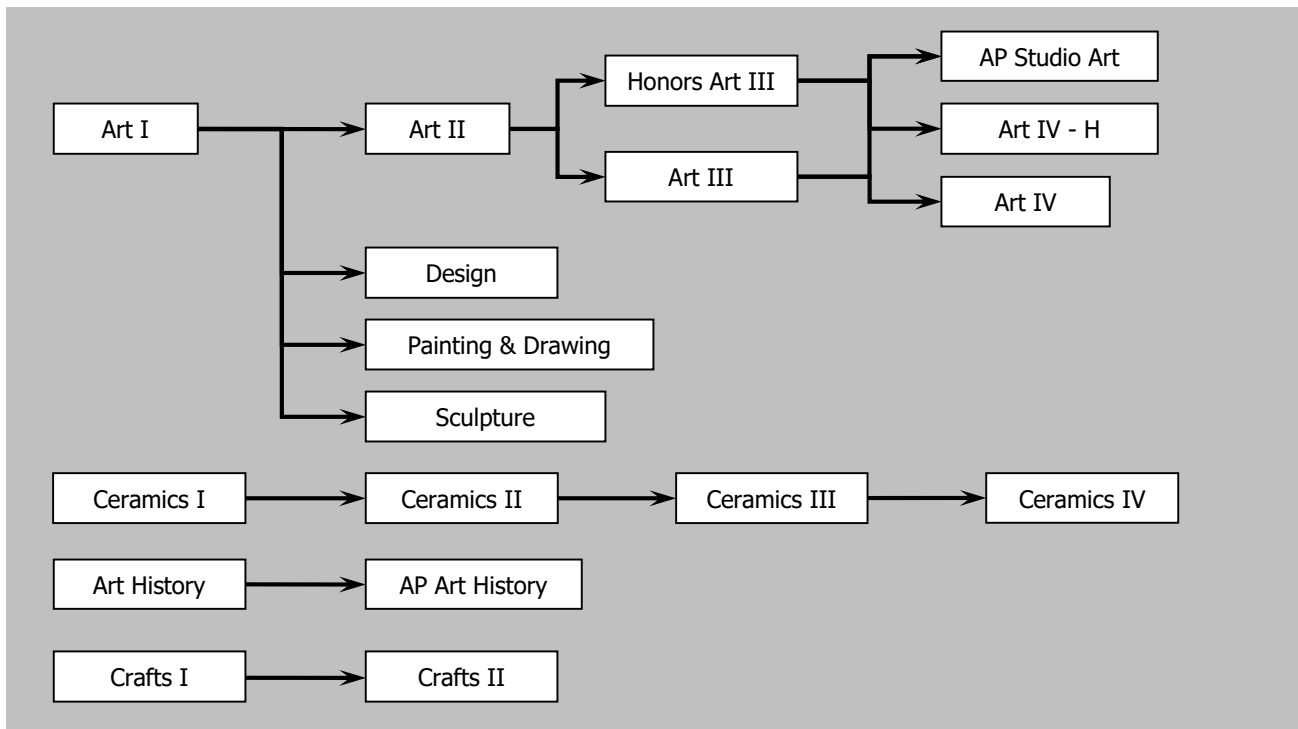

**Fine Arts Department Course Descriptions**

**Advanced Placement Studio Art ..... Credits: 5  
Grade 12**

*Prerequisites* – Students will be selected for admission to AP Studio Art based on the following criteria:

- Successful completion of Honors Art III and /or presentation of a portfolio demonstrating advanced 2-dimensional works, with a “B” average maintained in prior art studio coursework.
- Recommendation of Visual Arts Staff following portfolio review.
- Demonstrated high level of problem solving using the Principles and Elements of Art / Design within the portfolio of work.

AP Studio Art is designed for students who are seriously interested in a challenging practical experience of making art. It is not based on an examination; instead, students submit portfolios to the CollegeBoard in May for evaluation, along with a written statement describing their work. This course will provide the equivalent of a college-level studio art course with substantial portfolio requirements relative to breadth, quality, and volume of work. It is strongly recommended students also apply for Independent Study to provide the time needed to produce and assemble the AP portfolio as well as to generate additional work to comply with the individual requirements of the schools to which they may be applying. **Summer assignment required.**

**Advanced Placement Art History ..... Credits: 5****Grades \*10, 11, 12**

*Prerequisites* -Students will be selected for admission to AP Art History based on the following criteria:

- grades in prior English and History courses
- Art, English, and/or History teacher recommendations
- one year of Art History is highly recommended

\* Open to: Grades 11 and 12, Grade 10 *with successful completion of Art History Academic*

Advanced Placement Art History is designed to give students an understanding of architecture, sculpture, painting, and other art forms within historical and cultural contexts. Students examine major forms in a variety of cultures from ancient to modern times, learning to look at works of art critically, with intelligence and sensitivity, and to analyze what they see. Students who have done well in studies such as history, literature, and advanced art are encouraged to enroll. This course requires strong writing skills and a high degree of commitment to academic work. Students are encouraged to take the AP examination in May. There is no prerequisite for students in grades 11 or 12, but Art History (Academic) is a pre-requisite for 10<sup>th</sup> grade students and strongly recommended if the student has no prior AP course experience. **Summer assignment required.**

**Art History..... Credits: 5****Grades 9, 10, 11, 12**

From the earliest times people have felt the need to make art. All of us inherit the objects that earlier people and cultures have created through the richness of painting, sculpture, architecture, and other visual art. We will study why people felt the need to make these objects and why art is still made today. By learning to interpret these objects, we will examine what they can tell us – about meaning and about ourselves. Art History spans the human experience from the dawn of history through modern times. Students with an interest in people, history, art, or literature will find the study of Art History stimulating and enjoyable. Note: Art History is not a “studio” course in which students make art.

**Art I..... Credits: 5****Grades 9, 10, 11, 12**

Open to all interested students, this full year class provides a general understanding of the elements and principles of design and how they are used in the art making process to build a foundation for more advanced art study. Students will study a wide range of two-dimensional and three-dimensional art, including drawing, painting, sculpture, print making and art history. The variety of art media, techniques, and concepts prepare students for more advanced study. Required: successfully maintain homework assignments in sketchbook or journal.

**Art II..... Credits: 5****Grades 10, 11, 12**

*Prerequisite* - Art I

For the serious art student, this course offers more advanced study in the art making process, further utilizing the elements and principles of design introduced in Art 1. Students are expected to build upon that prior knowledge to produce more advanced work. Successful fulfillment of this course provides students the opportunity to apply for the Art III Honors class. Required: maintain weekly homework assignments in sketchbook and project work done outside of class.

**Art III ..... Credits: 5****Grades 11, 12**

*Prerequisites* - Art II and recommendation.

Offers the opportunity for advanced students to explore and develop their own individual expression and style. Emphasis will be on the development of a well-rounded portfolio that demonstrates self-expression, analytical problem solving, critical analysis, technical achievement and a mature approach to using the elements and principles of design to communicate meaning. Required: maintain weekly homework assignments in sketchbook and project work done outside of class.

**Art III (Honors) ..... Credits: 5**  
**Grades 11, 12**

*Prerequisites* - Art II and recommendation of the visual art staff following portfolio review

Art III-Honors is open to highly motivated students demonstrating exceptional ability, interest, and dedication to the study and production of art. Assignments and projects focus on all aspects of painting, drawing, and design, utilizing a wide range of materials and styles. Emphasis will be on the development of personal style and a well-rounded portfolio that demonstrates self-expression, analytical problem solving, critical analysis, technical achievement, and a mature approach to using the Elements and Principles of Design to purposely and effectively communicate meaning. Admission is by portfolio review; a pre-course summer assignment is required. In addition to required projects and homework assignments, students will be encouraged to pursue individual projects of interest under the guidance of the teacher. **Summer assignment required.**

**Art IV ..... Credits: 5**  
**Grade 12**

*Prerequisites* - Art III

Open to motivated students seeking to develop a high level of technical and creative skills, a broader knowledge of tools and materials, and advanced problem solving techniques. Emphasis will be on completing a well-rounded portfolio demonstrating self-expression, analytical problem solving, technical achievement, and a mature approach to using the Elements and Principles of Design to purposely and effectively communicate meaning. Required: maintain weekly homework assignments in sketchbook and project work done outside of class.

**Art IV (Honors) ..... Credits: 5**  
**Grades 11, 12**

*Prerequisite* - Art III, appropriate elective(s), a juried portfolio review, and permission of the instructor.

Intended to be an outlet for an unusually strong artistic ability in a specific art field, this course will provide you with a significant opportunity to gain extensive experiences that are satisfying to your talent and interests. Emphasis is on the freedom to respond as an individual and to develop independently from the group through the guidance and assistance of the instructor. The presentation of a portfolio or a one-person art show is a desirable goal. **Summer assignment required.**

**Ceramics I ..... Credits: 2.5**  
**Grades 9, 10, 11, 12**

Methods and processes of forming with clay will be presented along with direct experiences in using the potter's wheel. Emphasis upon the study of form, color, and texture is balanced with concern of the technical aspects of the ceramic arts including glaze composition and firing procedures. Students of above average ability and talent in ceramics may be permitted to take another semester of Advanced Ceramics.

**Ceramics II ..... Credits: 2.5**  
**Grades 9, 10, 11, 12**

*Prerequisite* – Ceramics I

This course is the intermediate level ceramics course for students who have taken Ceramics and wish to pursue this specialized area of study, advancing their knowledge and skills. Students will solve classical ceramic design and production problems including wheel thrown and hand built forms. Work on the potter's wheel will center upon cylinders and bowls while hand built work will focus upon complex forms and innovative design. Glaze work and more in-depth studies of ceramic materials and processes are also covered.

**Ceramics III ..... Credits: 2.5**  
**Grades 10, 11, 12**

*Prerequisite* - Ceramics II

Ceramics III offers the opportunity for advanced studio art studies focusing on all aspects of ceramic design and production utilizing a wide range of materials and styles. Emphasis will be on the development of a well-rounded portfolio that demonstrates self-expression, analytical problem solving, critical analysis, technical achievement, and a mature approach to using the Elements and Principles of Design to purposely and effectively communicate meaning. In addition to required projects, students will be encouraged to pursue individual projects of interest under the guidance of the teacher.

**Ceramics IV..... Credits: 2.5****Grades 10, 11, 12***Prerequisite* - Ceramics III

Ceramics IV offers students advanced studio art studies focusing on all aspects of ceramic techniques, design and production. Students will learn advanced techniques that enable them to control the materials and processes of ceramics and resolve design issues related to the properties of fired clay and glazes. Emphasis will be on developing a well-rounded portfolio that demonstrates self-expression, analytical problem solving, critical analysis, technical achievement, and a mature approach to effectively communicating meaning.

**Crafts I..... Credits: 2.5****Grades 9, 10, 11, 12**

Crafts I is a one-semester introductory course for students interested in exploring traditional techniques of crafts across world cultures. Projects may include mediums such as collage, mixed-media, fibers, paper construction, sculpture, jewelry, and ceramics.

**Crafts II ..... Credits: 2.5****Grades 9, 10, 11, 12***Prerequisite* – Art I or Crafts I

Crafts II will further develop techniques, materials and methods introduced in Crafts I. There will be greater emphasis on developing individual aesthetics and demonstrating more sophisticated use of applying elements and principles of art and design. Projects will be more advanced in scope and materials with greater emphasis placed on higher level creative problem solving skills. Projects may include metals, fibers, paper construction, jewelry, sculpture, and ceramics.

**Cultural Ceramics..... Credits: 2.5 in Art or Social Studies****Grades 9, 10, 11, 12**

All societies depend upon the earth for survival. By carefully using earthen materials to express themselves and the beliefs of their culture, people worldwide and throughout time have created ceramics. Students in Cultural Ceramics investigate the values and beliefs of one culture by discovering and interpreting its art and works in clay. In a personal way, students then explain the work of the other culture and express themselves by creating ceramic objects. Students declare for credit in art or social studies and follow appropriate course requirements. Cultural Ceramics may be taken as many as four times.

**Design ..... Credits: 2.5****Grades 10, 11, 12***Prerequisite* - Art I

This course uses a variety of media to complete hands-on activities exploring the arrangement of line, color, shape, form, value, and texture in both 2-dimensional and 3-dimensional design. Projects may include poster design, textile pattern design, relief design, etc. Design may be taken more than once for additional credit.

**Digital Fine Arts I..... Credits: 2.5****Grades 9, 10, 11, 12**

This course will enable students to understand the link between Technology, Science, and Contemporary Fine arts. It is designed to expand the traditional knowledge of Fine Art, Art History, and Design. It provides students with the knowledge and skills necessary to use tools of Photoshop and Adobe Illustrator to create original Artwork. The course will allow the students to create Artwork that expands their 2D portfolios for the college application process, various career opportunities and vocational options within the field of visual communications.

**Painting and Drawing ..... Credits: 2.5****Grades 10, 11, 12***Prerequisite* - Art I

Designed as an in-depth approach to drawing and painting skills, the course will provide you with experiences in the development of realistic and abstract art concepts. The means of expression are interchanged to relate line, form and composition with the problems in translating the techniques of pencil, ink, water color, oils, and acrylics into artistic results.

**Sculpture..... Credits: 2.5**

**Grades 10, 11, 12**

*Prerequisite - Art I*

Sculptural materials and techniques are stressed as they relate to ideas and concepts of interpretive forms as well as to human natural forms. The challenges involved in using materials such as plastic, wood, and plaster are intended to help you develop a more personal and creative rather than mechanical understanding of this fine art. Sculpture may be taken more than once for additional credit.

**Industrial Technology**  
**Supervisor: Dr. Leonard Herman - 908-231-8660 ext. 2263**

The IT Department recognizes that citizens of the 21st Century need to possess a variety of diverse competencies. Therefore, our students are exposed to and develop skills in areas of communications, design, career awareness, leadership, and artistic expression. This knowledge is then applied, adapted, and utilized to further encourage students to develop the desire to become lifelong learners. To achieve this goal, courses are designed to support the development of critical thinking skills, problem solving abilities, information gathering and analysis, cooperative learning, and aesthetic awareness.

We further believe that our program should:

- Inspire, Engage, and Educate
- Improve our world and make it great
- Challenge all to grow and exceed
- Prepare our students will lead the way

Students who go through the IT Program are better prepared to meet life and career goals in a rapidly changing technological world. As a result of the exposure to courses and curriculum, students gain an understanding of the necessary balance of form versus function. It is the goal of the IT Department to create an atmosphere in which students are encouraged to explore creativity, design, analysis, aesthetics, and their physical abilities. Students are challenged throughout the curriculum to transfer those talents to the world they will encounter upon graduation.

The following flow chart illustrates the sequencing of courses within the department. **Students are encouraged to read specific course descriptions prior to selection, taking note of prerequisite and recommendation requirements.**

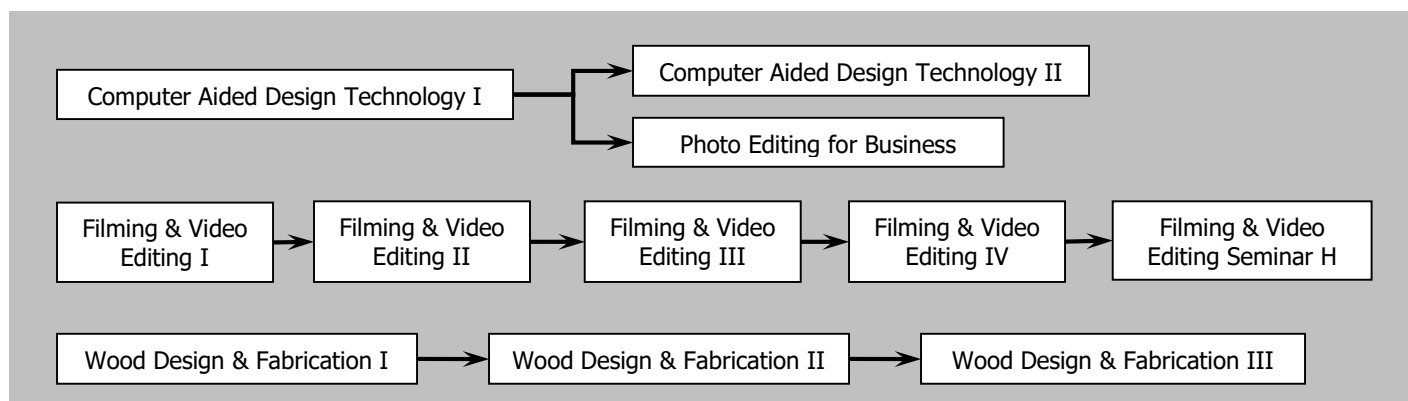

**Industrial Education Department Course Descriptions**

**Audio & Music Engineering ..... Credits: 2.5**

**Grades 9, 10, 11, 12**

This course introduces students to the principles of audio recording. Through guided activities, students will gain the skills to select and set up recording equipment, create multi-track recordings, apply effects, and use advanced mixing and recording techniques. Students will gain a fundamental understanding of necessary skills for the audio industry as well as audio post-production for video. The curriculum built on a foundation of music, audio content production, acoustics, fundamental engineering science, signal processing hardware and software, electronics, and software engineering.

**CNC Production..... Credits: 2.5****Grades 9, 10, 11, 12**

CNC technology has been widely used since the 1960's, mostly in either high production or high precision aerospace sectors. It was basic robotics with machines receiving instructions from tapes where each line of code was manually inserted by a programmer. This changed dramatically with the advent of small, powerful and relatively inexpensive computers in the 1980's. Since that time the lowering costs of computing power and the boom in programming has put CNC technology into nearly every facet of manufacturing and is now in the tool box of many home shops. It has gone from a mass production or highly specialized and very expensive tool to a ubiquitous presence in nearly all production operations for wood, metals & plastics. It has offered the world higher quality and accuracy at much less cost and continues to evolve. Unlike 3D printing which is an additive process CNC machining is subtractive in nature. As there are many materials that cannot be extruded in a printing process, this technology is here to stay and is complementary to 3D printing. It is a major tool for engineering prototyping and is even being used as an artistic tool. This course will give students a firm foundation in CNC routing, knowledge of which can be transferred to other types of CNC machining or cutting. We will be using the best and most widely used software package to explore and create objects or finished products. We will have access to a CNC router with tool changer which will allow students to transform digital images solid objects. This will be a great experience for students with a very wide array of interests and career goals.

**Computer Aided Design Technology I ..... Credits: 5****Grades 9, 10, 11, 12**

This is the first in a series of computer graphic design courses. Its intent is to explore different facets of design over the course of the year. AutoCAD will be used to cover traditional drafting practices in both single-view Mechanical parts, and Architectural Design floor plans and exterior elevations. 3D modeling and printing are covered during the second half of the course. Software packages may include, but are not limited to, AutoCAD LT, Blender 3D, Google Sketchup, AutoDesk Fusion 360, TinkerCAD.

Students are introduced to the basics of drafting on a computer (CAD). Topics covered include: drafting terminology; how to think, work and communicate like an engineer; graphical communication using Single View, Architectural, and 3D modeling; drawing floor plans using AutoCAD as an introduction to Architecture; the importance of working within a Learning Community; and honing 21st-century skills. Students will decipher and complete engineering and architectural drawings at their own pace. 3D modeling software is used to create 3D products and parts while developing global solutions for the next generation of technological thinkers. Students will employ Geometry, Math, Measuring, and Critical Thinking to solve drafting and design problems.

Workbooks and written resources are provided to students over the span of the course for each unit of instruction.

**Computer Aided Design Technology II \* ..... Credits: 5****Grades 10, 11, 12**

*Prerequisite* - Computer Aided Design Technology I

This is the second in a series of computer graphic design courses. Its intent is to explore different facets of design over the course of the year. Graphic Design principles will be explored using vector and raster-based editing software. AutoCAD will be used to cover drafting practices and expand upon the Architectural Design base introduced in CAD 1. Site plans, floor plans, electrical plans, exterior elevations cross-sections, artistic and 3D modeling will be explored using a variety of tools.

Software packages may include, but are not limited to, AutoCAD LT, Blender 3D, Google Sketchup, Autodesk Fusion 360, Adobe Photoshop, Illustrator, and Adobe InDesign.

Topics covered include: drafting terminology for architecture; graphical communication using industry-standard drafting symbols and terminology, Architectural drafting techniques, and 3D modeling; the importance of working within a Learning Community; and honing 21st-century skills. Students will decipher and complete architectural drawings at their own pace. 3D modeling software is used to create still scenes and animations. Graphics and movies can be produced from these scenes at any size and quality for print or display.

Graphic Design and Typography is used to add artistic details to projects as well as promotional materials. Students learn together with Art, Geometry, Math, Measuring, and Critical Thinking to solve drafting and design problems.

Workbooks and other resources are provided to students over the span of the course for each unit of instruction. Most software packages used in this course are free for students and educators.



**Engineering Computer Graphics I ..... Credits: 5****Grades 10, 11, 12**

This course is designed for the student interested in obtaining a knowledge base in Engineering and Engineering Graphics. Students will gain the understanding necessary for career development in Engineering as well as advanced techniques in the use of CAD design and graphic representation. Many different varieties of pictorial drawings will be explored including but not limited to: Orthographic, Isometric, Section Views, and Perspective, drawings. The 3D design will also be explored through surface developments and the introduction of 3D modeling software. Students may use the freely available Blender package to create stunning 3D visuals of their 2D designs. Modeled scenes may also be animated and rendered at any size or quality level to produce 3D movies.

**Introduction to Electronics..... Credits: 5****Grades 9, 10, 11, 12**

This course will investigate the fundamentals of electrical principles through activities in the areas of magnetism, light heat, elementary electronics, house wiring, and printed circuits. Emphasis is placed on fundamental theory, tools, materials, maintenance of equipment, use and control of power, meters, computation and testing. (Algebra I recommended.)

\* *There may be advanced independent study sections in this class for those students who have done well and wish to continue with the permission of the instructors.*

**Filming & Video Editing I ..... Credits: 2.5****Grades 9, 10, 11, 12**

Filming and Video Editing I will introduce the students to the technology needed to create quality video productions. Students will develop video productions in a variety of genres and will learn to take ideas and see them through to finished products. This course is designed to maximize, to the greatest extent possible, hands-on applications of the technology available while giving students the academic background necessary for them to understand the technology at its basic level. This hands-on approach, coupled with the use of media in the presentation of the content, will maximize the learning of students of all ability levels and learning styles. Students will learn to work cooperatively in group settings and to effectively function as teams to develop desired outcomes.

**Filming & Video Editing II ..... Credits: 2.5****Grades 9, 10, 11, 12****Prerequisite - Filming & Video Editing I**

Filming & Video Editing II will continue to build upon materials introduced during the Filming & Video Editing I course. Students learn the technology needed to create quality video productions. Students will develop video productions in a variety of genres and will learn to take ideas and see them through to finished products.

This course is designed to maximize, to the greatest extent possible, hands-on applications of the technology available while giving students the academic background necessary for them to understand the technology at its basic level. This hands-on approach, coupled with the use of media in presentation of the content, will maximize the learning of students of all ability levels and learning styles. Students will learn to work cooperatively in group settings and to effectively function as teams to develop desired outcomes.

**Filming & Video Editing III ..... Credits: 2.5****Grades 10, 11, 12****Prerequisite - Filming & Video Editing II**

Filming and Video Editing III will build upon skills developed in the prerequisite courses and will explore some areas in greater depth as needed in order to meet the demands of this course. Filming and Video Editing III is designed to be a predominantly hands-on course supplemented, at times, by a more in-depth study of advanced elements of production. Examples include: working with advanced cameras and advanced digital editing software.

This course is designed to maximize, to the greatest extent possible, hands-on applications of the technology available while giving students the academic background necessary for them to understand the technology at its basic level. This hands-on approach, coupled with the use of media in the presentation of the content, will maximize the learning of students of all ability levels and learning styles. Students will learn to work cooperatively in group settings and to effectively function as teams to develop desired outcomes.

**Filming & Video Editing IV..... Credits: 2.5****Grades 10, 11, 12****Prerequisite - Filming & Video Editing III**

Filming and Video Editing IV will build upon skills developed in the prerequisite courses and will explore some areas in greater depth as needed in order to meet the demands of this course. Filming and Video Editing IV is designed to provide students with a forum for creative composition and self-expression.

This course is designed to maximize, to the greatest extent possible, hands-on applications of the technology available while giving students the academic background necessary for them to understand the technology at its basic level. This hands-on approach, coupled with the use of media in presentation of the content, will maximize the learning of students of all ability levels and learning styles. Students will continue to learn to work cooperatively in group settings and to effectively function as teams to develop desired outcomes.

**Filming & Video Editing Seminar (H)..... Credits: 2.5****Grades 11, 12****Prerequisite - Filming & Video Editing IV and grade of A- or better**

Filming and Video Editing Seminar is a one-semester academic elective course for students in grades eleven and twelve. Filming and Video Editing I, Filming and Video Editing II, Filming and Video Editing III and Filming and Video Editing IV are prerequisites for taking Filming and Video Editing IV. Filming and Video Editing Seminar will build upon skills developed in the prerequisite courses and will explore some areas in greater depth as needed in order to meet the demands of this course. Filming and Video Editing Seminar is designed to provide students with a forum for creative composition and self-expression.

The Filming and Video Editing Seminar course will provide students with the opportunity to further develop their technical skills in video production and editing as well as provide them with a forum for creative composition and self-expression. Students will be encouraged to submit projects for consideration for the county Teen Arts Festival and other showcases for video as are presented during the course of the year.

**Wood Design and Fabrication I ..... Credits: 5****Grades 9, 10, 11, 12**

This course will introduce the student to the principles of form and function in relation to design, creation, fabrication and critical analysis of wood projects. The will explore their artistic abilities through the design and construction of a variety of projects based on established criteria. Personal choice projects will be adapted to meet the needs, interests, abilities and creative expression of the student.

**Wood Design and Fabrication II..... Credits: 5****Grades 10, 11, 12****Prerequisite - Wood Design and Fabrication I**

This course delves more deeply into the principles of form and function started in Wood Design and Fabrication I. This course explores the methods and process of creating a work in wood as it relates to creative expression. An in-depth study of the intricacies of cabinet making and woodturning will be explored in this course.

**Wood Design and Fabrication III \* ..... Credits: 5****Grades 11, 12****Prerequisite - Wood Design and Fabrication I & II**

The emphasis of the course will be placed on the design, planning, development, and presentation of wood projects. This course is specifically centered on the individual interest of the students. A historical perspective of design and style is developed in order for a student to express his/her creative interests through the creation of various pieces of furniture. Critical analysis skills are developed in order for students to self-evaluate work and improve its form and function.

\* *There may be advanced independent study sections in this class for those students who have done well and wish to continue with the permission of the instructors.*

## Other

**Teacher's Aide ..... Credits: 5 to 10**

**Grade 12 ..... One or Two Semesters**

Students may pursue the Teacher's Aide Program as a full year (10 credits) or semester (five credits) offering by working as teacher aides in the Primary or Intermediate schools of the Bridgewater-Raritan School District. This affords the seniors the opportunity to gain insights into teaching as a professional career. The minimum requirement is that students must remain at their assigned school until the end of the BRHS day. Applications are available in the School Counseling Office and must be approved by student, parent and various school community members. Students must hand in a signed student agreement and student placement contract before the last full day of classes, prior to the start of the final exam period in June to be permitted to participate in the program. No exceptions will be made.



# BRIDGEWATER-RARITAN HIGH SCHOOL CREDIT AND COURSE REQUIREMENTS FOR GRADUATION

**Student Name:** \_\_\_\_\_

English                    1 \_\_\_\_\_ 2 \_\_\_\_\_ 3 \_\_\_\_\_ 4 \_\_\_\_\_

Math                      1 \_\_\_\_\_ 2 \_\_\_\_\_ 3 \_\_\_\_\_

Science                 Bio \_\_\_\_ 2 \_\_\_\_\_ 3 \_\_\_\_\_

Social Studies         World Civ II \_\_\_\_\_ US I \_\_\_\_\_ US II \_\_\_\_\_

Visual/Perform Arts    1 \_\_\_\_\_ 2 \_\_\_\_\_ (Total = 5 credits)

21<sup>st</sup> Century Skills     1 \_\_\_\_\_ 2 \_\_\_\_\_ (Total = 5 credits)

Financial Literacy     1 \_\_\_\_\_ (Total = 2.5 credits)

PE/Health              9<sup>th</sup> \_\_\_\_\_ 10<sup>th</sup> \_\_\_\_\_ 11<sup>th</sup> \_\_\_\_\_ 12<sup>th</sup> \_\_\_\_\_

World Language        \_\_\_\_\_ (Total = 5 credits)

Electives                1 \_\_\_\_\_ 2 \_\_\_\_\_ 3 \_\_\_\_\_ 4 \_\_\_\_\_

Credits completed towards graduation: 9<sup>th</sup> \_\_\_\_\_ 10<sup>th</sup> \_\_\_\_\_ 11<sup>th</sup> \_\_\_\_\_

Minimum credits needed for promotion: 9<sup>th</sup> = 30      10<sup>th</sup> = 60      11<sup>th</sup> = 90

Total credits needed for graduation = 120

## Scheduling Worksheet

Period	Fall	Spring
<b>1</b>		
<b>2</b>		
<b>3</b>		
<b>4</b>		
<b>5</b>		
<b>6</b>		
<b>7</b>		
<b>8</b>		
<b>9</b>		