



Multi



Jump



Tiles



MARCY COOK MATH

P.O. Box 5840

Balboa Island, CA 92662-5840

www.marcycookmath.com

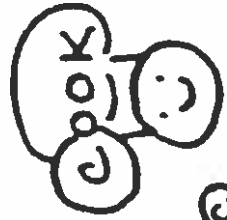

© 2008

Name: _____

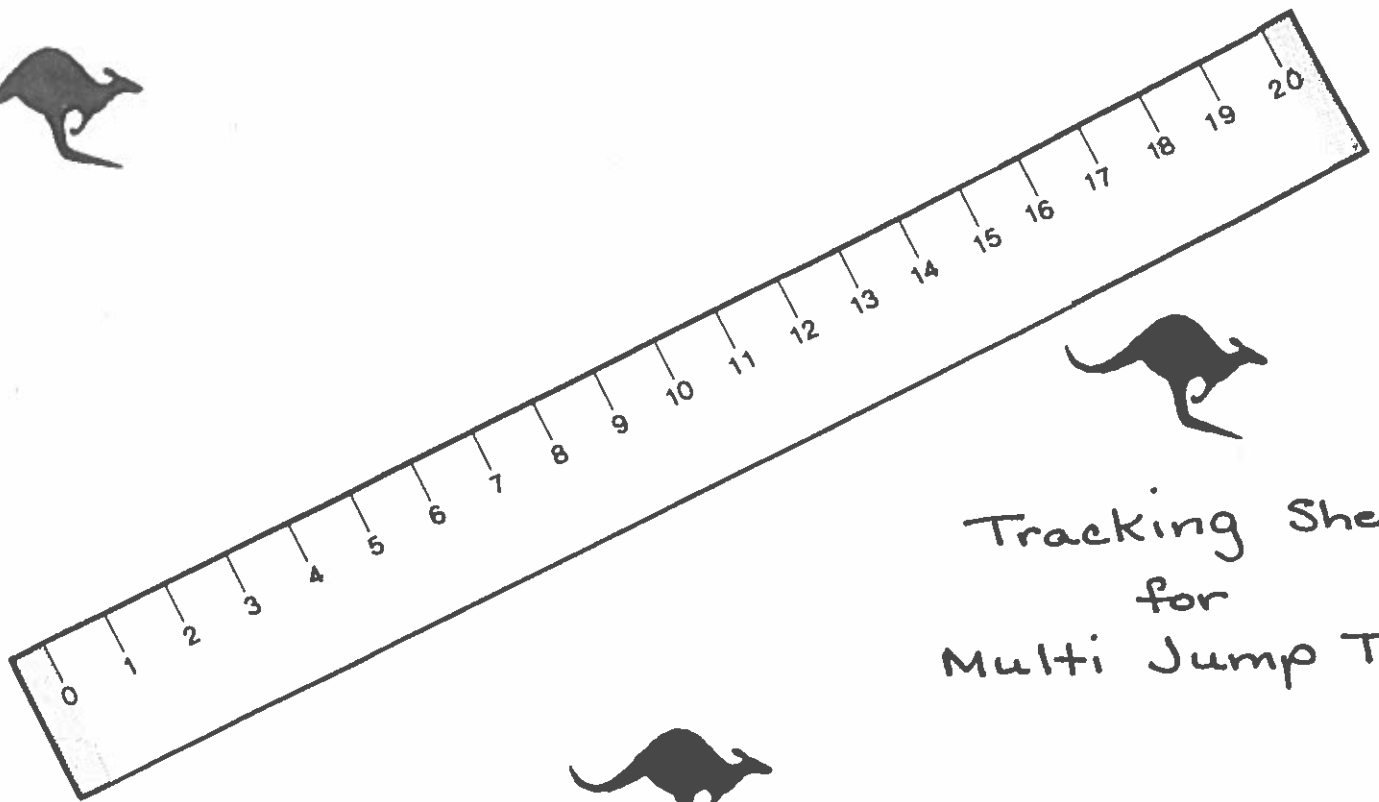

Tracking Sheet
for
Multi Jump Tiles



Name: _____

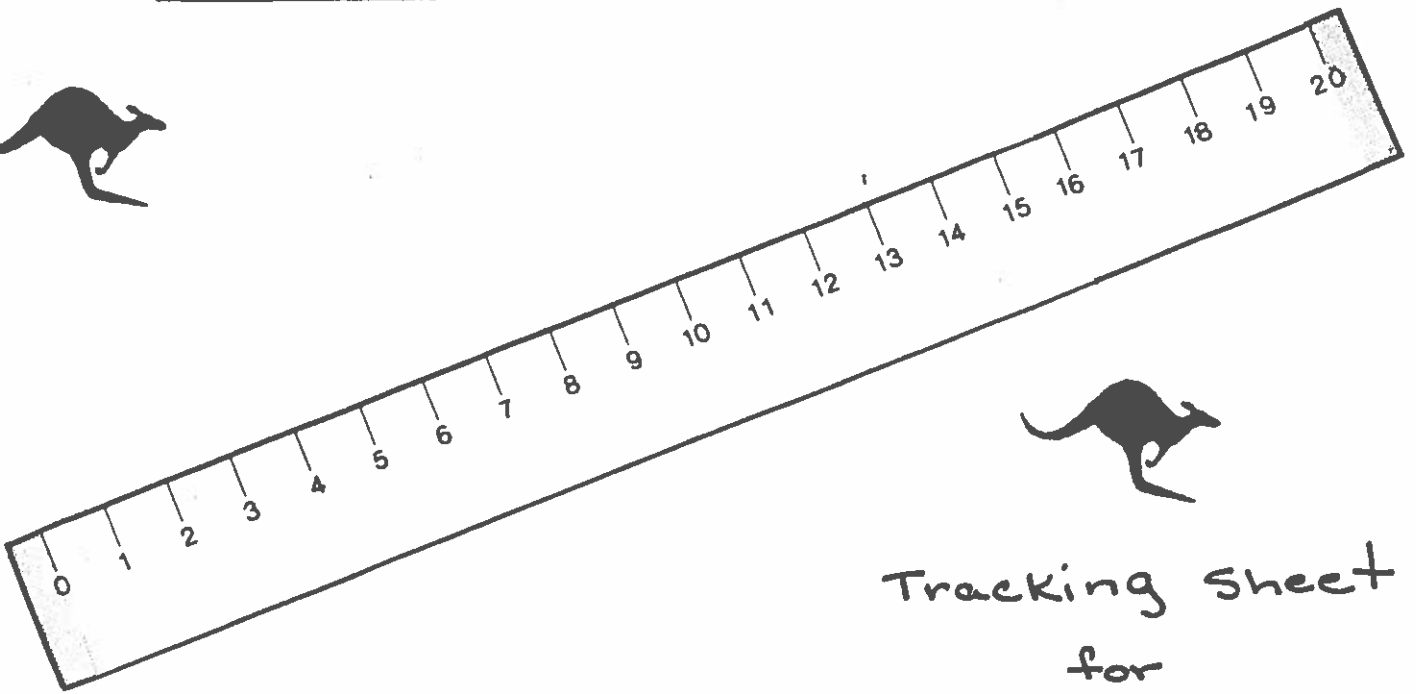

Tracking Sheet
for
Multi Jump Tiles



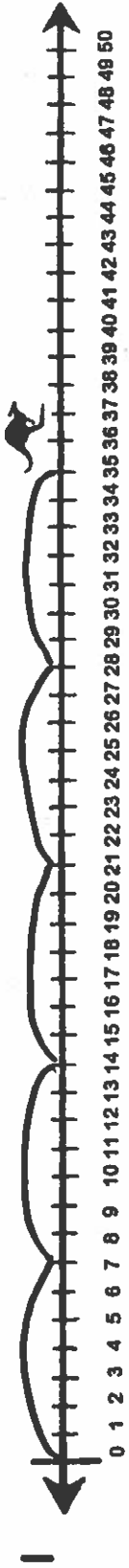

$$\boxed{5} \times \boxed{} = \boxed{} \times \boxed{}$$

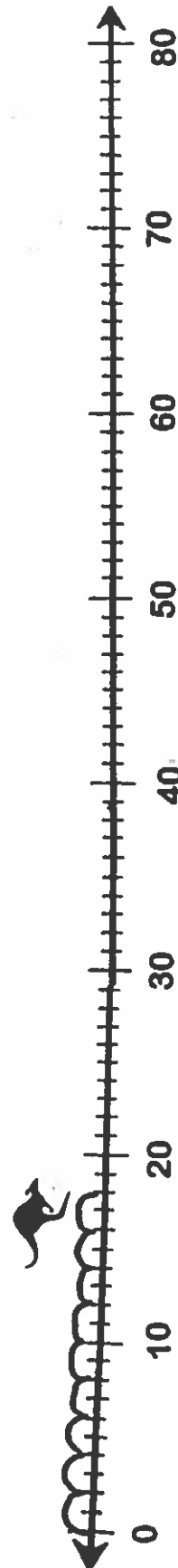

$$\boxed{30} \times \boxed{} = \boxed{} \times \boxed{}$$

Extra Tile

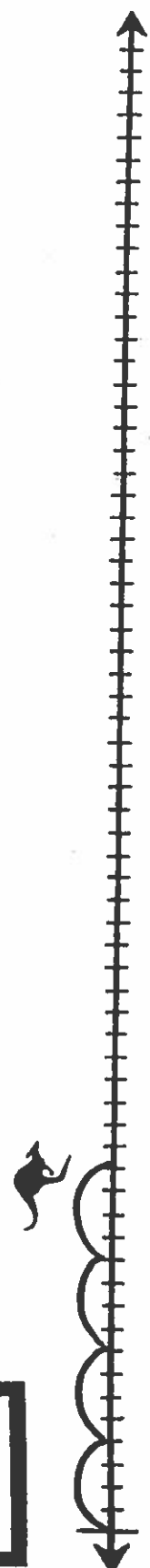

$$\boxed{4} \times \boxed{} = \boxed{} \times \boxed{}$$

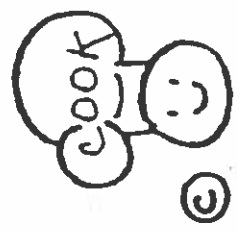

Multi Jump Tiles



$$\square \times 5 = \square$$

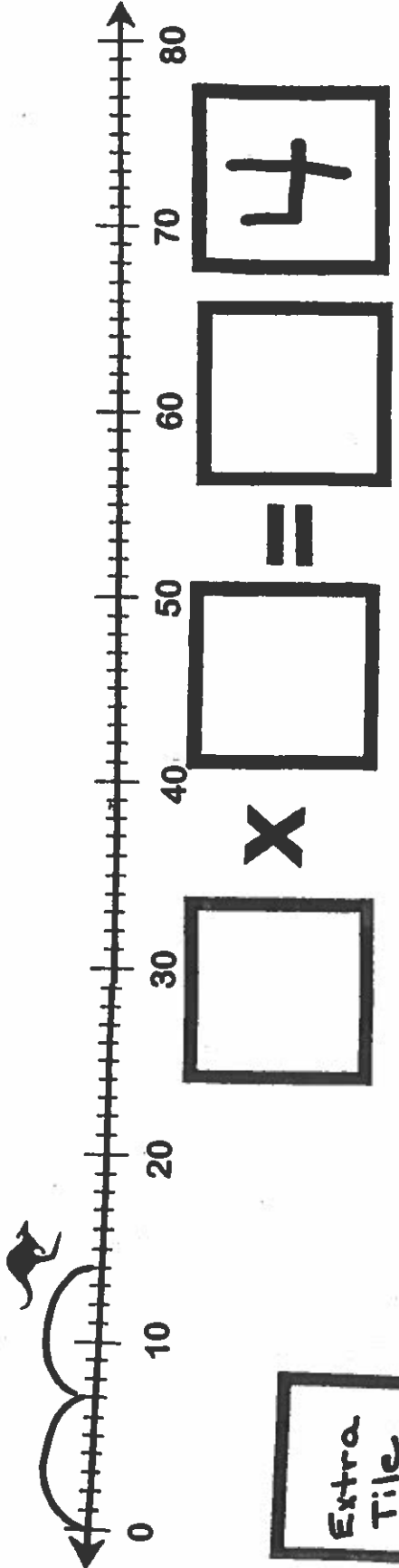

Extra Tile

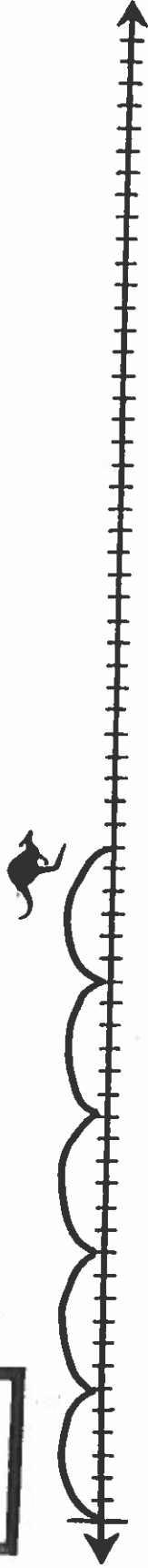

$$5 \times \square = \square$$

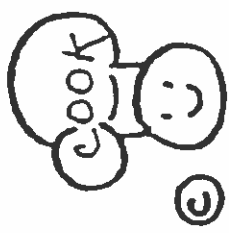

Multi Jump Tiles

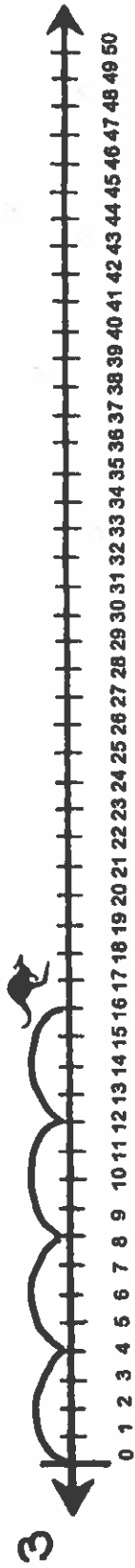

$$\boxed{4} \times \boxed{} = \boxed{} \times \boxed{}$$

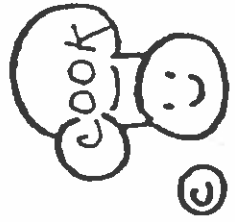
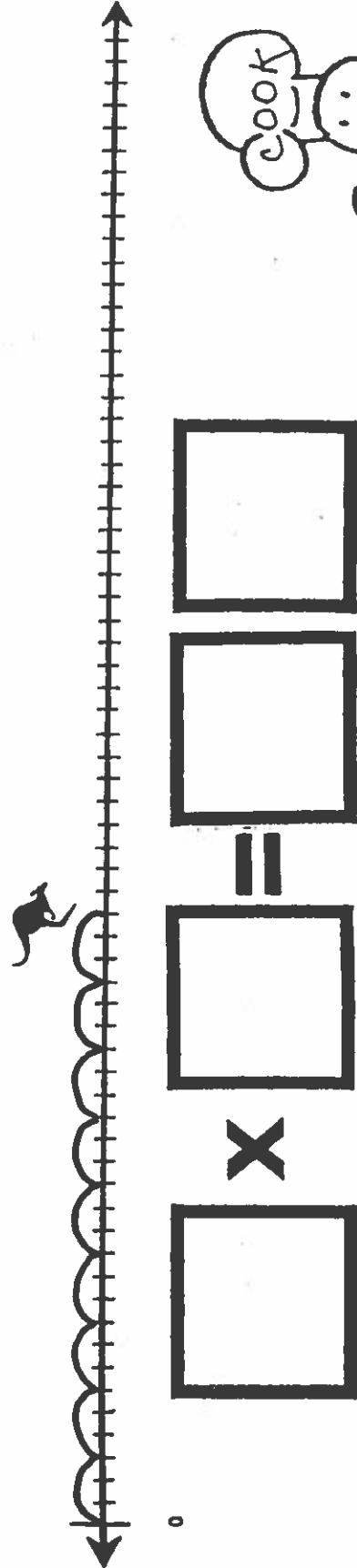
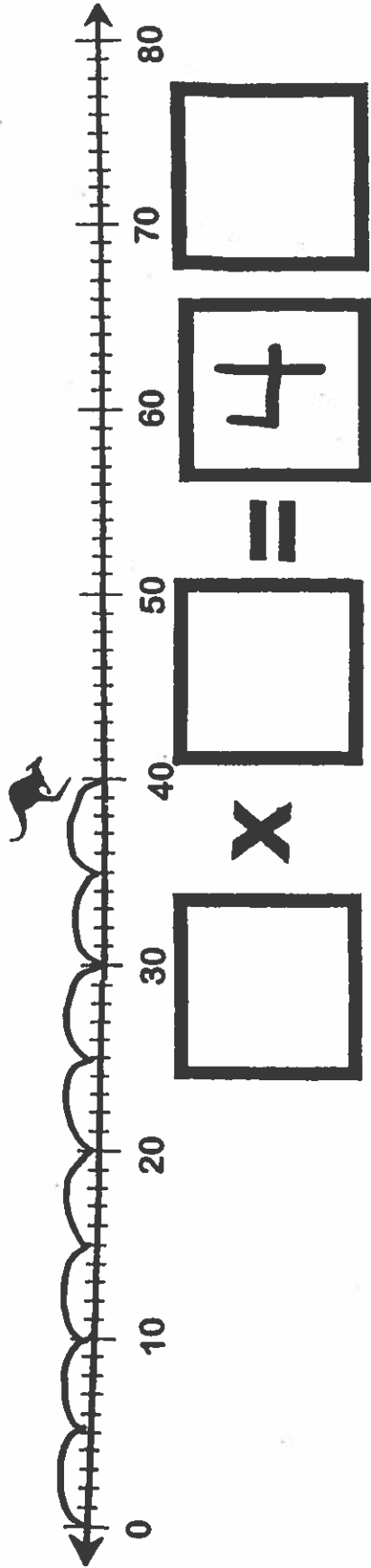

Multi Jump Tiles

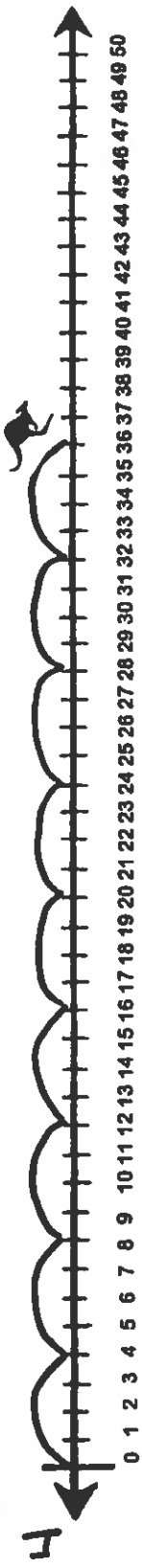

$$\square \times \square = \square$$

6

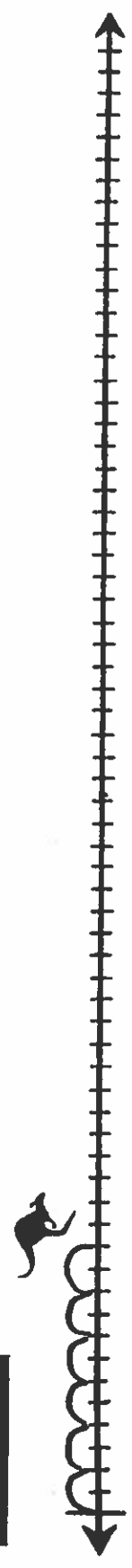
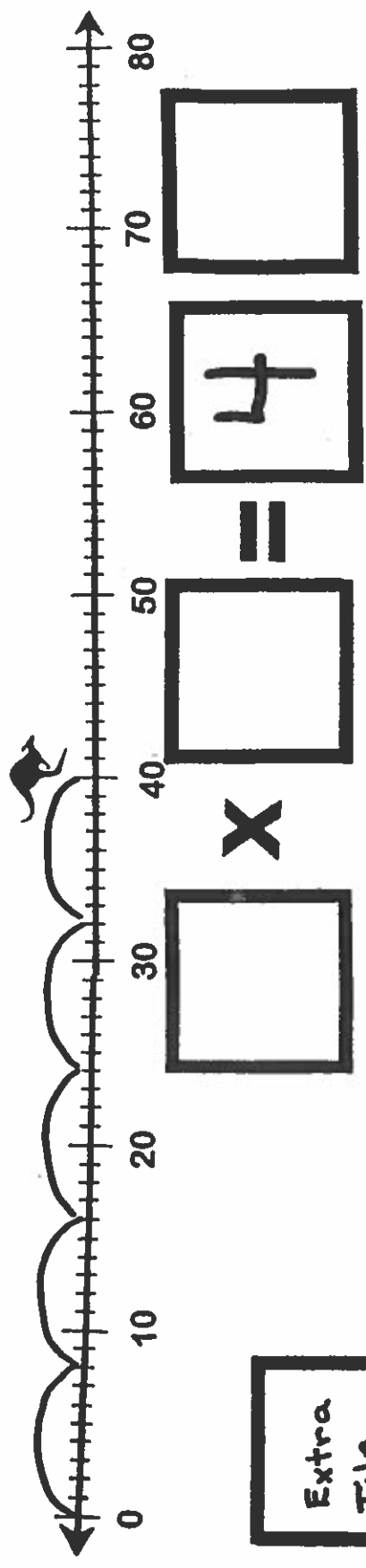

$$\square \times 2 = \square$$

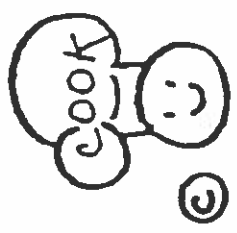

Multi Jump Tiles

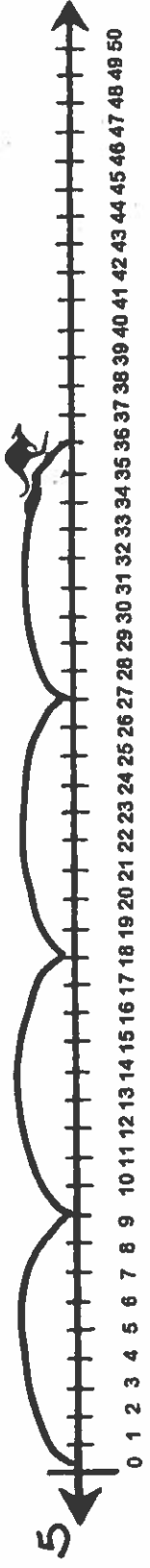

$$\boxed{} \times \boxed{} = \boxed{3} \boxed{}$$

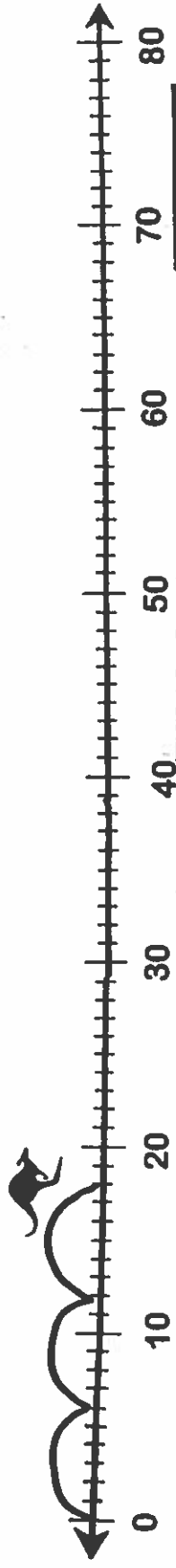

$$\boxed{} \times \boxed{6} = \boxed{} \boxed{}$$

Extra Tile

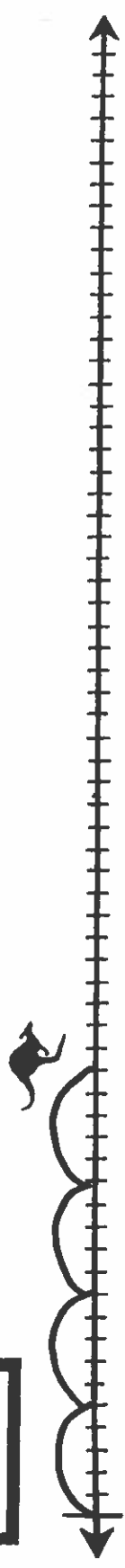

$$\boxed{4} \times \boxed{} = \boxed{} \boxed{}$$

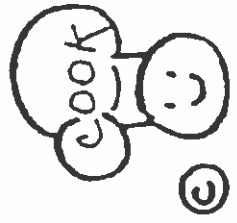

Multi Jump Tiles

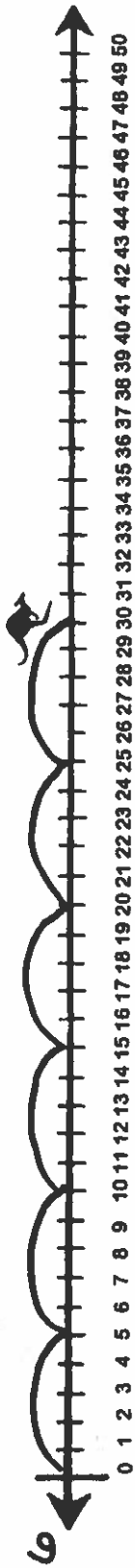

$$\boxed{6} \times \boxed{} = \boxed{} \quad \boxed{} \times \boxed{} = \boxed{}$$

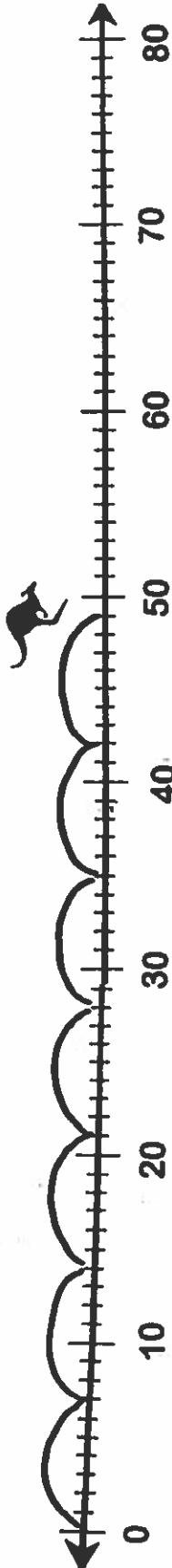

$$\boxed{} \times \boxed{} = \boxed{7} \quad \boxed{} \times \boxed{} = \boxed{}$$

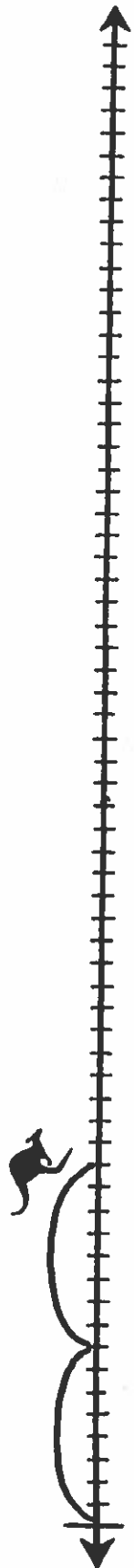

$$\boxed{} \times \boxed{} = \boxed{} \quad \boxed{} \times \boxed{} = \boxed{}$$

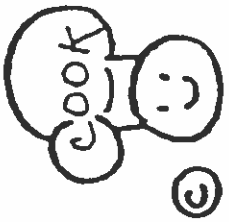

Multi Jump Tiles

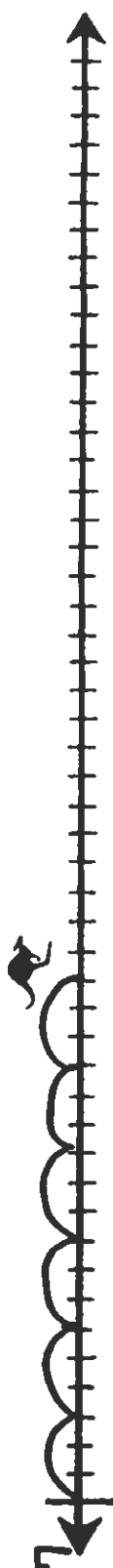

0 1 2 3 4 5 6 7 8 9 10 11 12 13 14 15 16 17 18 19 20 21 22 23 24 25 26 27 28 29 30 31 32 33 34 35 36 37 38 39 40 41 42 43 44 45 46 47 48 49 50

× =

=

=

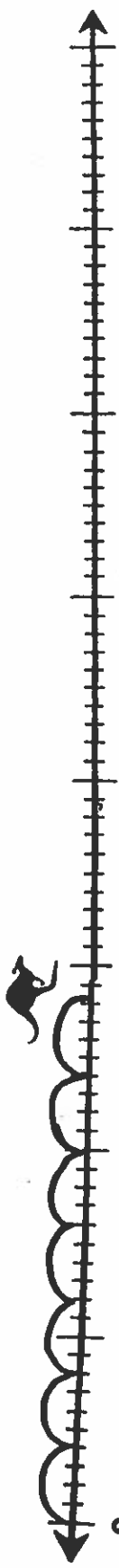

× =

× =

× =

Extra Tile

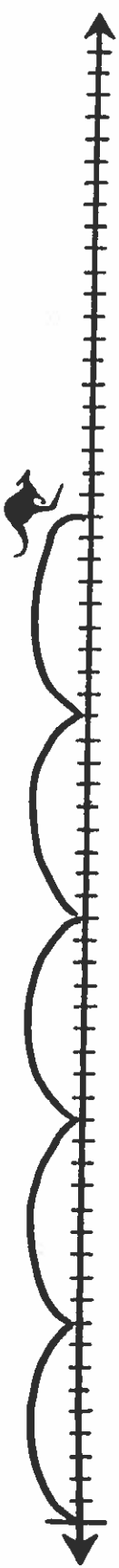

× =

× =

× =

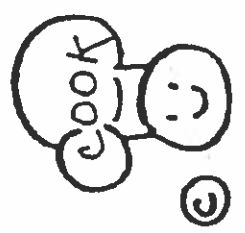

Multi Jump Tiles

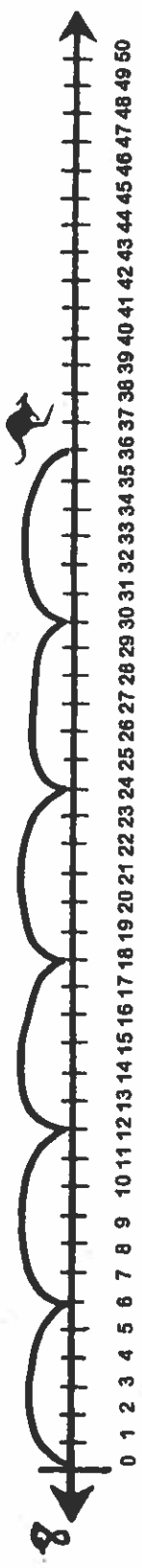

$$\boxed{} \times \boxed{6} = \boxed{} \times \boxed{} = \boxed{6}$$

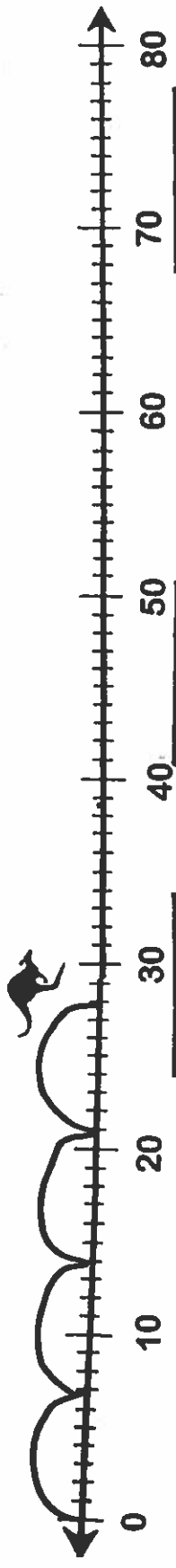

$$\boxed{} \times \boxed{} = \boxed{} \times \boxed{} = \boxed{2}$$

Extra Tile

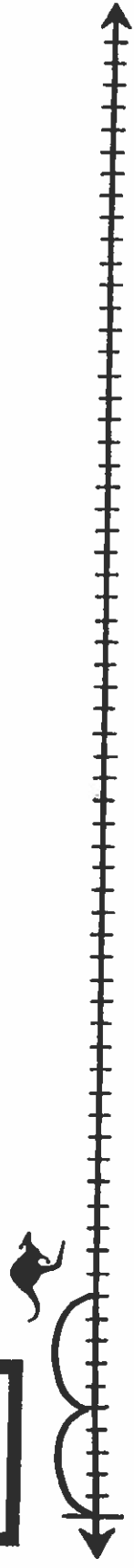

$$\boxed{} \times \boxed{} = \boxed{} \times \boxed{}$$

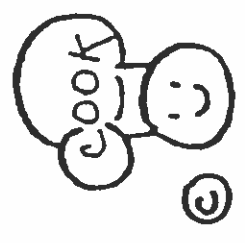

Multi Jump Tiles

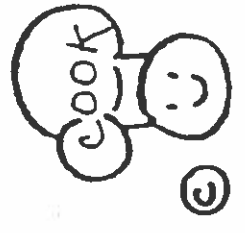
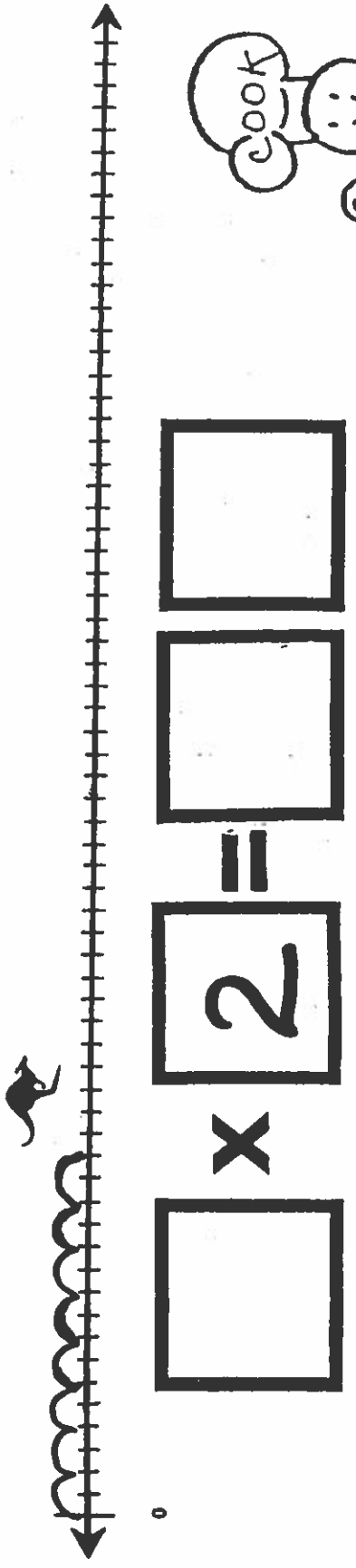
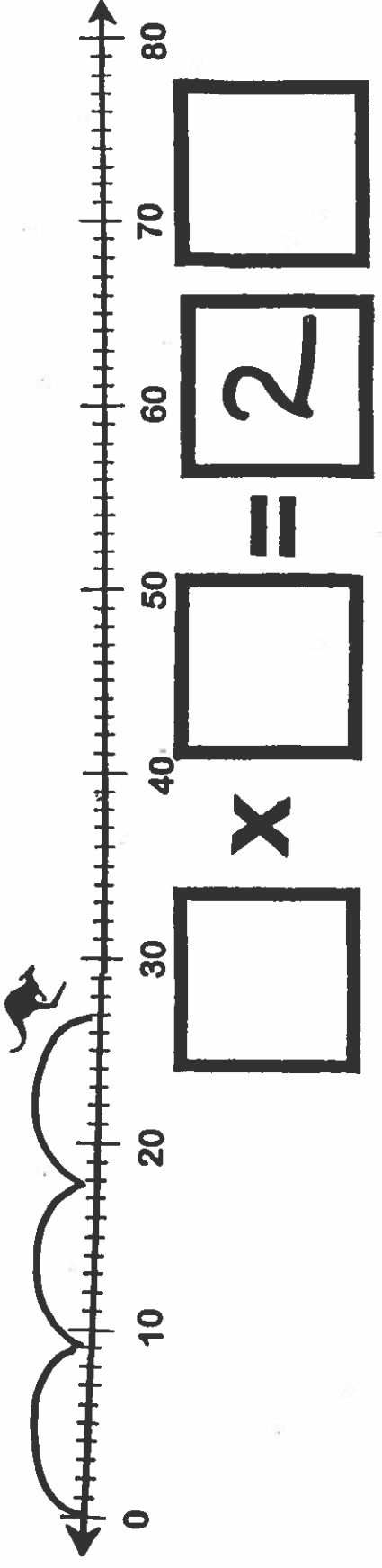
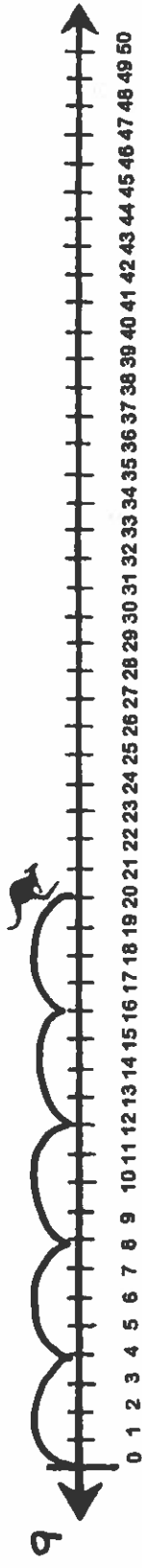

Multi Jump Tiles



$$\boxed{8} \times \boxed{} = \boxed{} \boxed{}$$

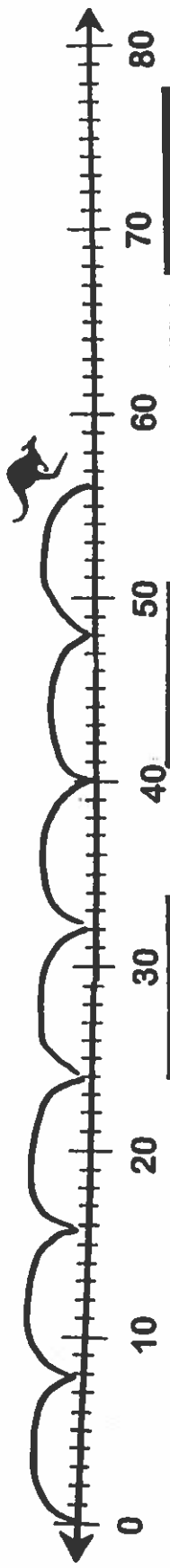

$$\boxed{} \times \boxed{8} = \boxed{} \boxed{}$$

Extra
Tile



$$\boxed{2} \times \boxed{} = \boxed{} \boxed{}$$

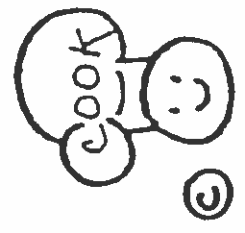

Multi Jump Tiles

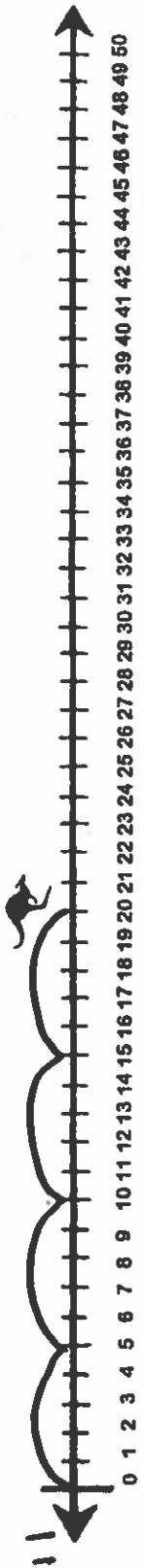

$$\boxed{} \times \boxed{5} = \boxed{} \quad \boxed{}$$

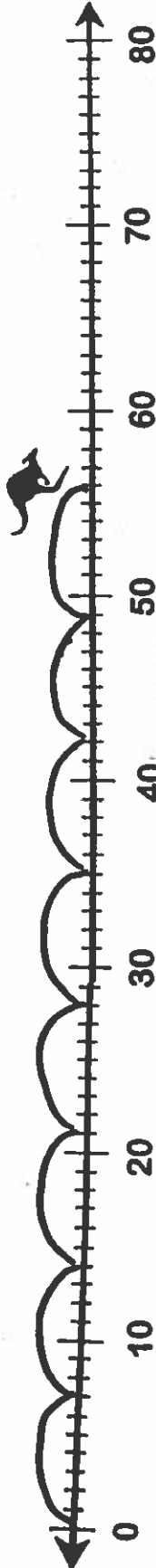

$$\boxed{8} \times \boxed{} = \boxed{} \quad \boxed{}$$

Extra
Tile

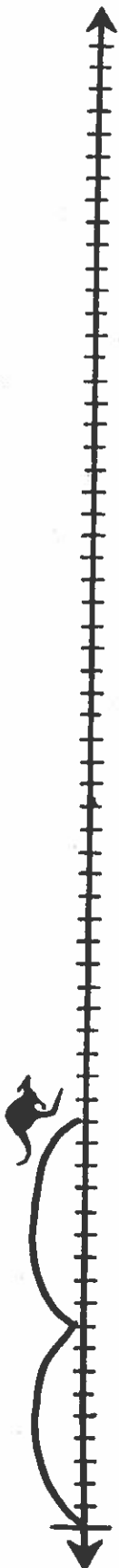

$$\boxed{2} \times \boxed{} = \boxed{} \quad \boxed{}$$

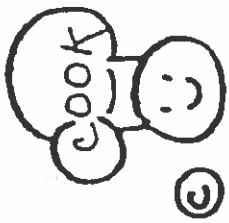

Multi Jump Tiles

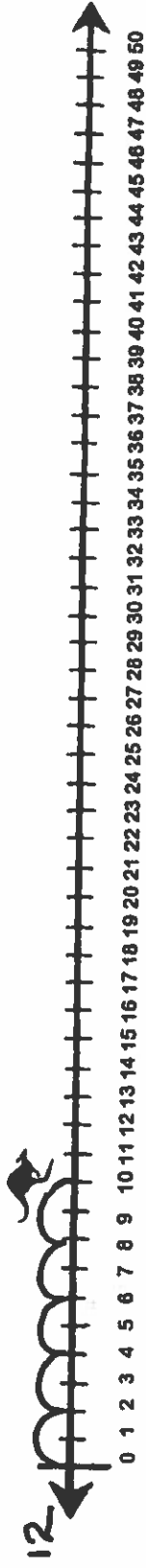

$$\square \times 2 = \square$$

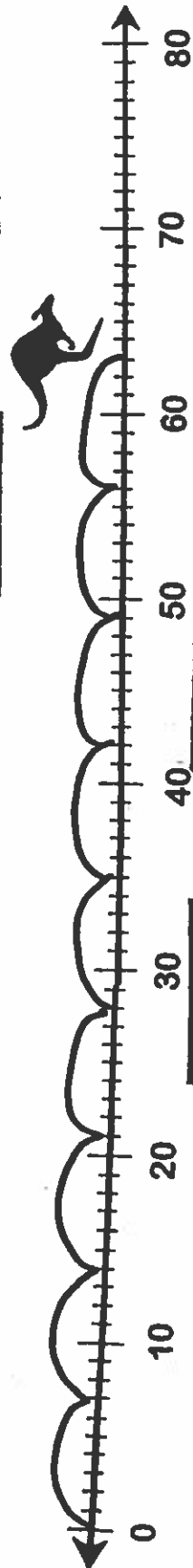

$$\square \times \square = \square$$

Extra
Tile

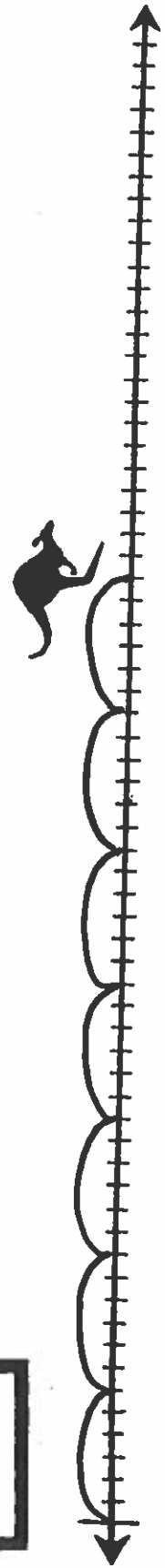

$$7 \times \square = \square$$

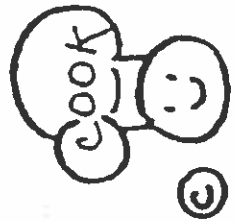

Multi Jump Tiles

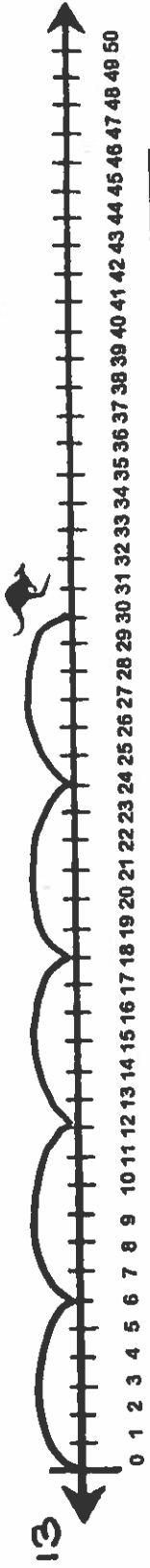

$$\square \times \square = \square$$

$$\square \times \square = 3$$

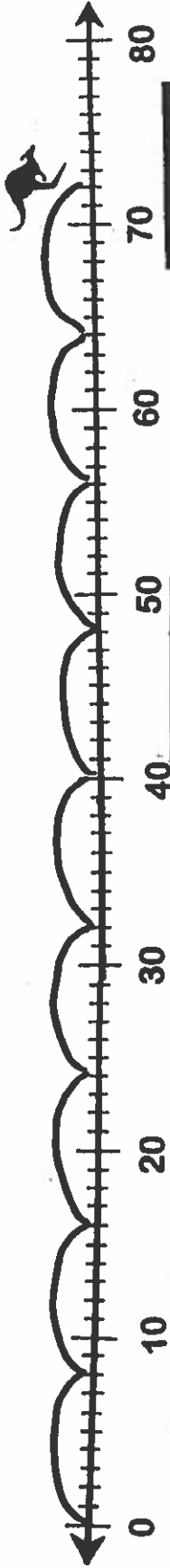

$$\square \times \square = \square$$

$$\square \times \square = \square$$

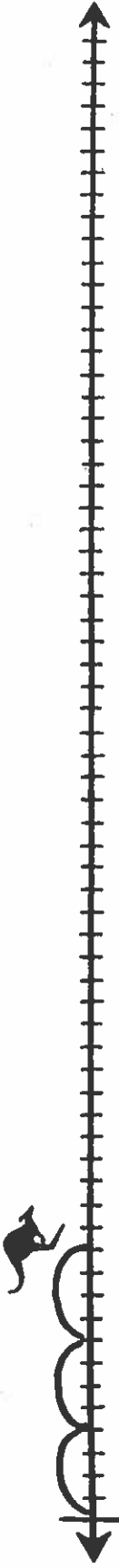

$$\square \times \square = \square$$

$$\square \times \square = 2$$

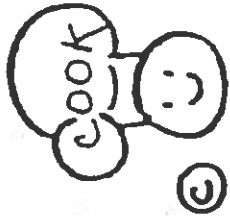

Multi Jump Tiles

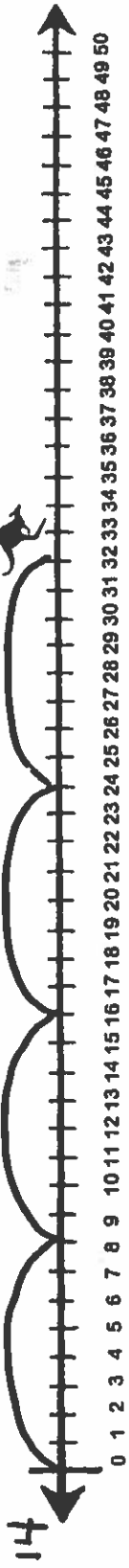

$$\square \times \square = \square$$

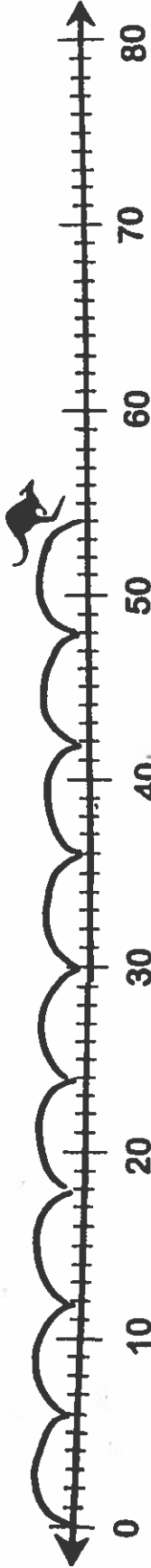

$$\square \times \square = \square$$

Extra Tile

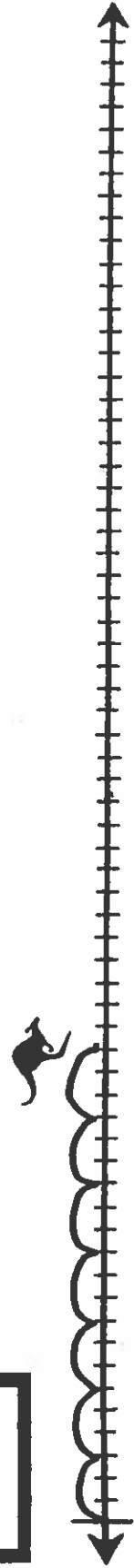

$$\square \times \square = \square$$

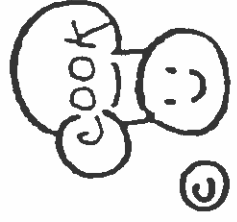

Multi Jump Tiles

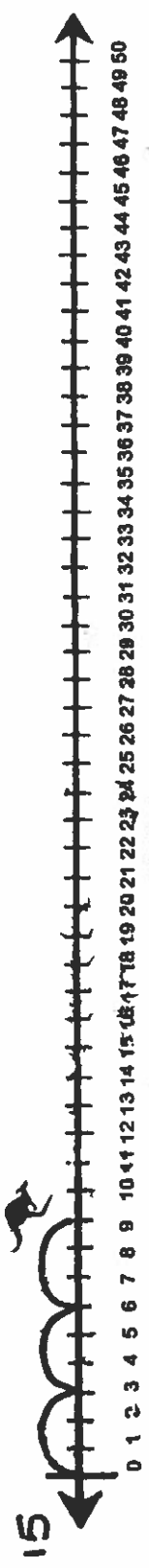

$$\square \times \square = \square$$

$$\square \times 3 = \square$$

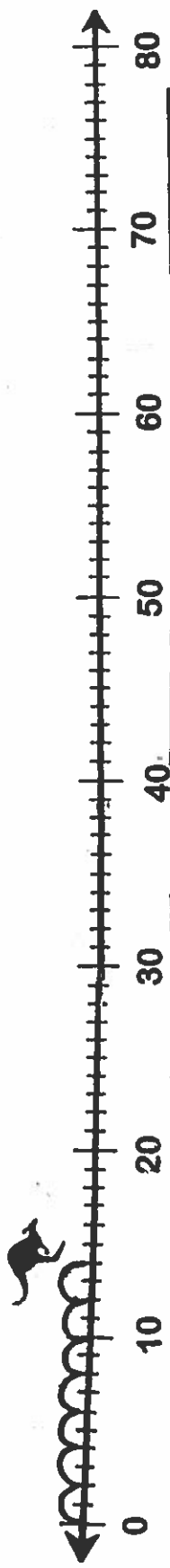

$$\square \times \square = \square$$

Extra Tile



$$\square \times 7 = \square$$

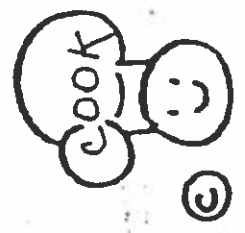

Multi Jump Tiles

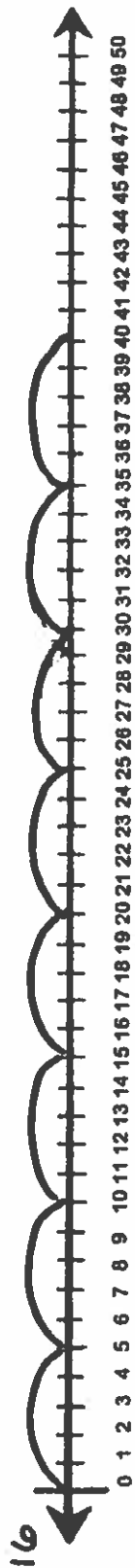

$$\square \times 5 = \square$$

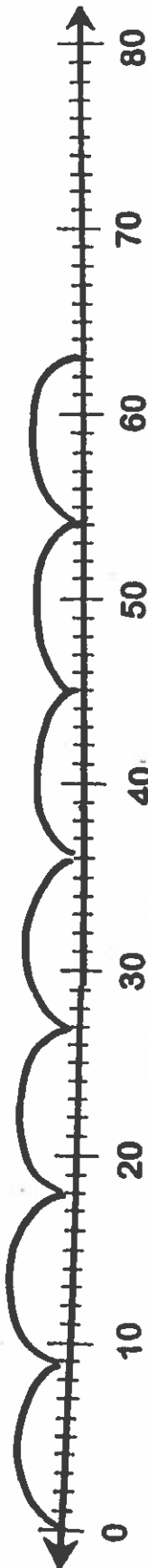

$$\square \times \square = \square$$

Extra Tile



$$5 \times \square = \square$$

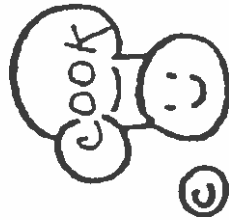

Multi Jump Tiles

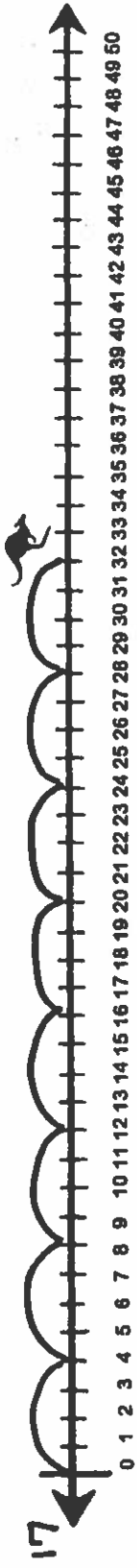

$$\square \times \square = \square$$

$$\square \times \square = \square$$

$$\square \times \square = \square$$

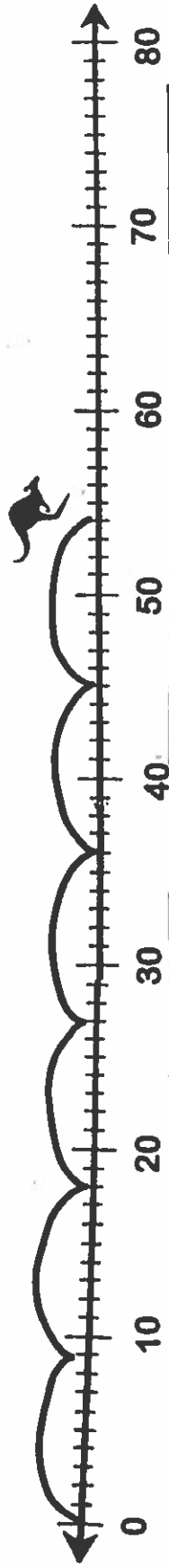

$$\square \times \square = \square$$

$$\square \times \square = \square$$

$$\square \times \square = \square$$

Extra Tile



$$\square \times \square = \square$$

$$\square \times \square = \square$$

$$\square \times \square = \square$$

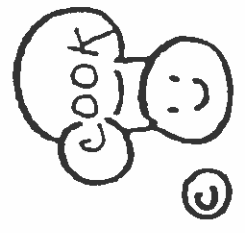

Multi Jump Tiles

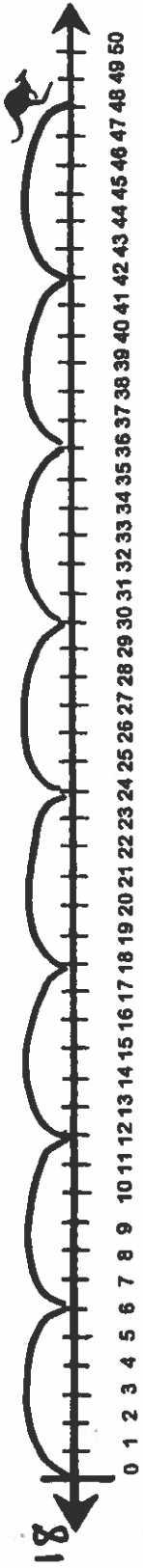

$$\boxed{} \times \boxed{} = \boxed{} \boxed{} \boxed{8}$$

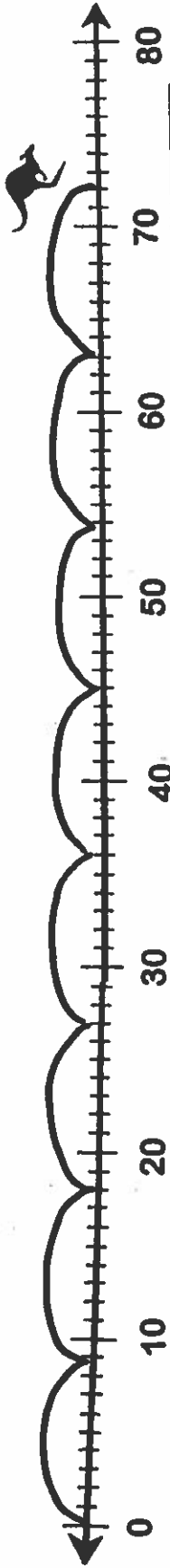

$$\boxed{8} \times \boxed{} = \boxed{} \boxed{} \boxed{}$$

Extra Tile

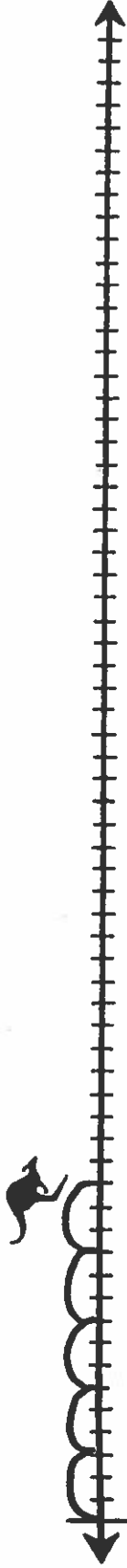

$$\boxed{5} \times \boxed{} = \boxed{} \boxed{} \boxed{}$$

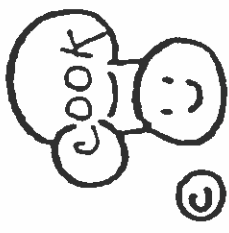

Multi Jump Tiles

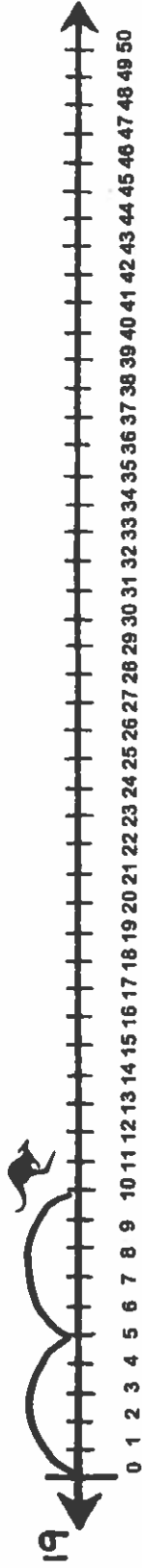

$$\square \times \square = \square$$

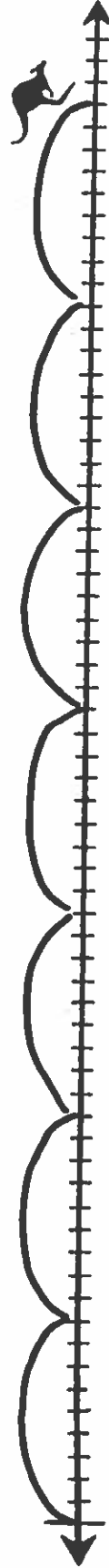
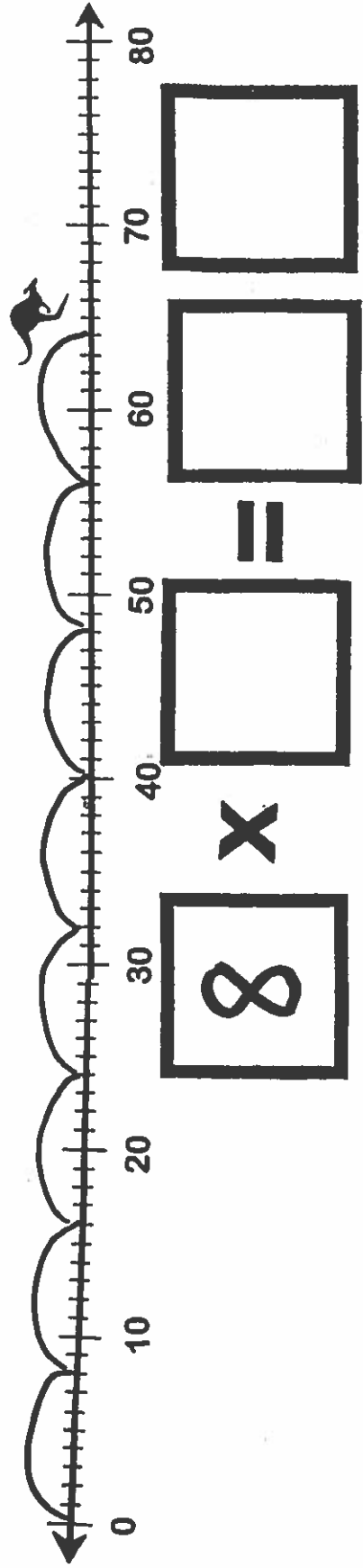

$$\square \times \square = 6$$

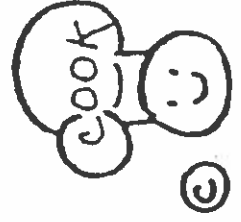

Multi Jump Tiles



$$\square \times \square = \square$$

4

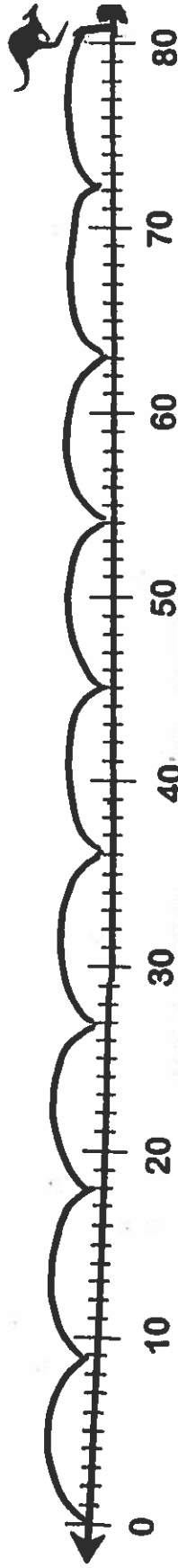

$$\square 9 \times \square = \square$$

Extra Tile



$$\square \times \square 5 = \square$$

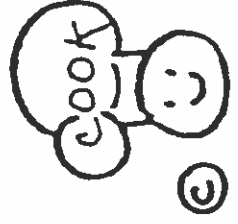

Multi Jump Tiles