

  
SURGICALLY CLEAN AIR™

AIR PURIFIER  
OPERATIONAL MANUAL  
Model No. SCA7000H



## SURGICALLY CLEAN AIR

**WARNING:**

- Before operating the system, please read this manual thoroughly, and retain it for future reference.
- This unit cannot be used in an atmosphere containing explosive dust, gas or oxygen, or in an area where flammable dust is present.
- This product can be used only where the power supply is 120V/60Hz. You cannot use the unit if the power voltage is different.

6300 Viscount Road Unit 1A  
Mississauga Ontario Canada L4V 1H3  
[www.surgicallycleanair.com](http://www.surgicallycleanair.com)  
[info@surgicallycleanair.com](mailto:info@surgicallycleanair.com)

# CONTENTS

	<b>CONSUMER LIMITED WARRANTY</b>	<b>E-4</b>
<b>Chapter 1</b>	<b>IMPORTANT SAFETY RECAUTIONS</b>	<b>E-5~7</b>
<b>Chapter 2</b>	<b>HOW IT WORKS</b>	<b>E-8</b>
<b>Chapter 3</b>	<b>PART NUMBER AND NAME</b>	<b>E-9</b>
<b>Chapter 4</b>	<b>FEATURES AND SPECIFICATIONS</b>	<b>E-10</b>
	Features	
	Product Specifications	
<b>Chapter 5</b>	<b>OPERATION</b>	<b>E-11~13</b>
	Button Operation	<b>E-11</b>
	Display Indicator Lights	<b>E-12</b>
	Remote Control Operation	<b>E-13</b>
<b>Chapter 6</b>	<b>CARE AND MAINTENANCE</b>	<b>E-14~16</b>
	Replacing the Pre-filter	<b>E-14</b>
	Replacing the HEPA filter	<b>E-15</b>
	Replacing the VOC filter	<b>E-15</b>
	Replacing UV Lamp	<b>E-16</b>
	Photo Catalytic Filter	<b>E-16</b>
<b>Chapter 7</b>	<b>TROUBLE SHOOTING</b>	<b>E-17</b>
<b>Chapter 8</b>	<b>WIRING DIAGRAM</b>	<b>E-18</b>
	<b>SERVICE REMINDER SCHEDULE</b>	<b>E-19</b>

## CONSUMER LIMITED WARRANTY

## LIMITED WARRANTY

### *Congratulations on your investment*

Surgically Clean Air (Hereinafter called SCA) gives you the following limited warranty for this product only if it was originally purchased from SCA or from an authorized dealer.

SCA warrants that this product is free, under normal use and maintenance, from any defects in material and workmanship. If any such defects should be found in this product within the applicable warranty period. SCA shall, at its option, repair or replace the product as specified herein.

SCA will repair or replace, free of charge, to the original purchaser, any part that is found to be defective in material or workmanship within one (1) year of the date of purchase. This limited warranty does not cover the replacement of expendable or consumable parts such as filters, and other parts subject to normal wear unless they are defective in material or workmanship.

#### **This warranty shall not apply if:**

(A) Any defects caused or repairs required because of abusive operation, negligence, accident, improper installation or inappropriate use as outlined in the operation manual.

(B) Any product tampered with modified, adjusted or repaired by any party other than SCA, SCA Authorized Service Centers or Dealers.

(C) Damaged caused or repairs because of the use with items not specified or approved by SCA.

(D) Any damage caused by external or environmental conditions, including but not limited to the use of voltage other than indicated on the product.

SCA's limited warranty is valid only if you retain proof of purchase from SCA or a SCA Authorized Retail Dealer for this product.

To obtain the name and address of the nearest Authorized Surgically Clean Air Dealers, please contact:

6300 Viscount Road Unit 1A  
Mississauga Ontario Canada L4V 1H3

---

For more information on this Warranty, Dealers or Service Locations, please call 1-877-440-7770  
Visit our website: [www.surgicallycleanair.com](http://www.surgicallycleanair.com)

# Chapter 1

## IMPORTANT SAFETY PRECAUTIONS

### Power Cord

### Unit Operation

### Running Environment Cautions

- Use only a 120-volt outlet with grounding wire receptacle.
- Do not put in rooms with high heat, damp or wet places.
- Do not use the air purifier if the power cord or plug is damaged or the connection to the wall outlet is loose.
- When removing the power plug, always hold the plug and never pull by the cord.
- Do not handle plug or appliance with wet hands. **Electrical shock or fire from short circuit may occur.**
- Remove the power plug from the wall outlet before cleaning the unit and when not using the unit. Turn off all controls before unplugging.
- If the power cord is damaged, it must be replaced by the SCA authorized service or similarly qualified person.
- To reduce the risk of electric shock, this equipment has a grounding type plug that has a third (grounding) pin. This plug will only fit into a grounding type power outlet. If the plug does not fit into the outlet, contact qualified personnel to install the proper outlet. Do not alter the plug in any way.

### Unit Operation

- Do not clean outside with paint thinner or any chemicals. If so, the unit surface may become damaged or may cause fire.
- Do not wash or reuse the Pre-filter, HEPA filter and the VOC filter.
- Do not operate the unit without filters.
  
- Do not insert fingers or foreign objects into the intake or air outlet.
- Keep hair, loose clothing, fingers and all parts of body away from openings and moving parts.
- Do not block the intake and air outlet.
- Do not use the unit near or on hot objects, such as range or where it may be exposed to steam.
- Always hold the handles on the side of the unit when moving it. Holding the front panel when carrying may cause it to detach, and result in bodily harm.
- Be careful not to tip over the unit when opening the front panel. If not, it may cause bodily harm.
  
- The batteries must be removed from the remote control before disposal, and the batteries must be disposed of safely.
  
- This product complies with the maximum allowable concentration of ozone of 0.050 parts per million by volume (ppmv) in a 24-hour period. The Health Canada Guideline 2010 (ISBN 978-1-100-16288-1) recommends that the maximum exposure limit, based on an average time of 8 hours, is 0.020 ppmv or less when tested in a sealed, controlled room approximately 30m<sup>3</sup>.

# Chapter 1

## IMPORTANT SAFETY PRECAUTIONS



### WARNING

If you do not follow these instructions exactly, the unit may cause property damage, personal injury or loss of life.

#### WARNING:

- Do not use the unit in the places containing explosive dust, gas or flammable substances.
- Do not clean the unit or any parts with flammable substances.
- Do not wash or reuse the Pre-filter, HEPA filter and VOC filter.

This manual classifies precautions into WARNINGS and CAUTIONS. Be sure to follow all precautions below: They are important for ensuring your safety.

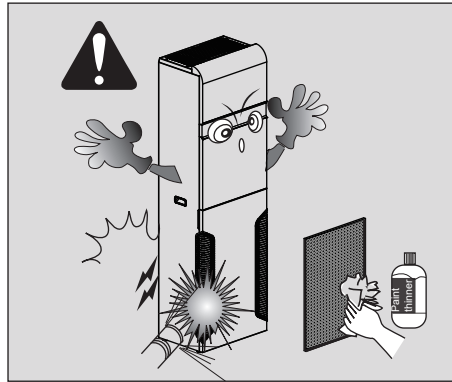

**1. DO NOT** clean the unit or any parts with alcohol, gasoline, paint thinner or other flammable substances.

**It may cause fire!**

Do not wash or reuse the Pre-filter, HEPA filter and the VOC filter.

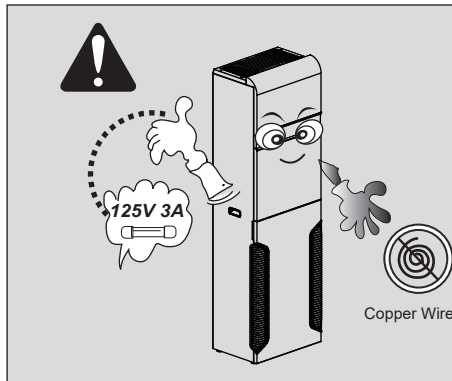

**2. Use** a fuse with proper capacity. Never use a wire in place of a fuse. Doing this may lead to malfunction or fire.

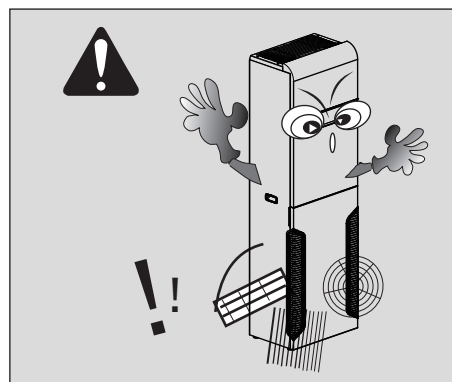

**3. Do not** disassemble or modify this equipment. Unwarranted tampering can lead to fire, electric shock and unit malfunction.

## Chapter 1

### IMPORTANT SAFETY PRECAUTIONS



#### WARNING

If you do not follow these instructions exactly, the unit may cause property damage, personal injury or loss of life.

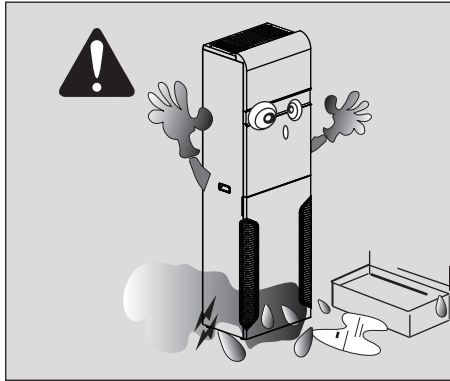

4. Do not use the unit in humid places that might be wet. If any parts of the power source gets wet remove the plug and dry it completely before reusing.

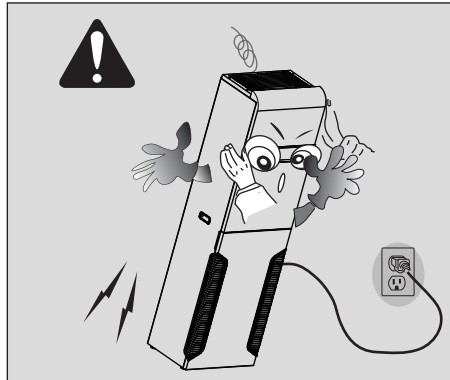

5. Be careful not to tip over the unit when opening the front panel or moving it. **If not, It may cause personal injury.**

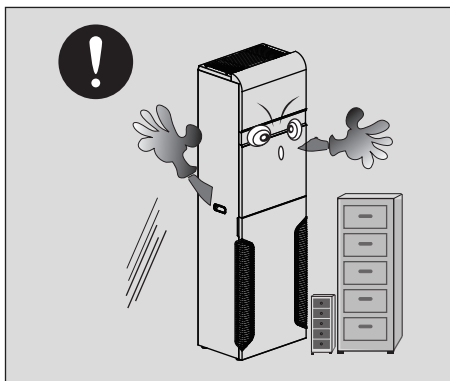

6. Do not block the intake or outlet. Blocked openings can reduce capacity or damage the unit.

## Chapter 2

### HOW IT WORKS

#### The air is cleansed in six stages

#### Part Name

- Stage 1  
Pre-filter
- Stage 2  
HEPA Filter
- Stage 3  
VOC Filter
- Stage 4  
UV-C Germicidal Lamp
- Stage 5  
Photo catalyst
- Stage 6  
Negative Ion Generator

The air purifier functions as an air cleaner by helping to disinfect airborne microorganisms and removing particulates from the air. The centrifugal fans of the unit draw air through the front panel (Intake) on the front of the unit. Then it passes through the Pre-filter, the HEPA filter, the VOC filter and the UV-Photo catalytic sterilization chamber. The purified air is then released through the outlet on the top of the unit.

#### The air is cleansed in six stages:

1. The Pre-filter traps large dust particles.
2. The high efficiency HEPA filter removes microscopic particles in the air.
3. The VOC filter absorbs and reduces odors.
4. The UV sterilization chamber kills bacteria and viral microorganisms such as influenza, TB and Legionnaire's Disease as well as other harmful contaminants.
5. When UV light hits the photo catalytic filter, it creates e<sup>-</sup> and h<sup>+</sup>, which have an excellent effect in the decomposition of odors.
6. The unit also generates negative ions that freshens the room air.

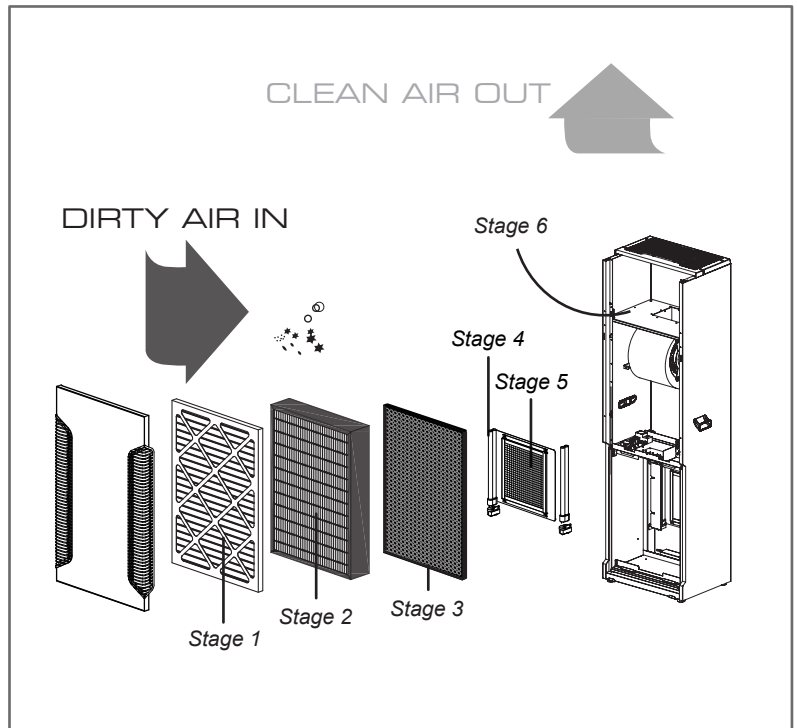

# Chapter 3

## PART NUMBER AND NAME

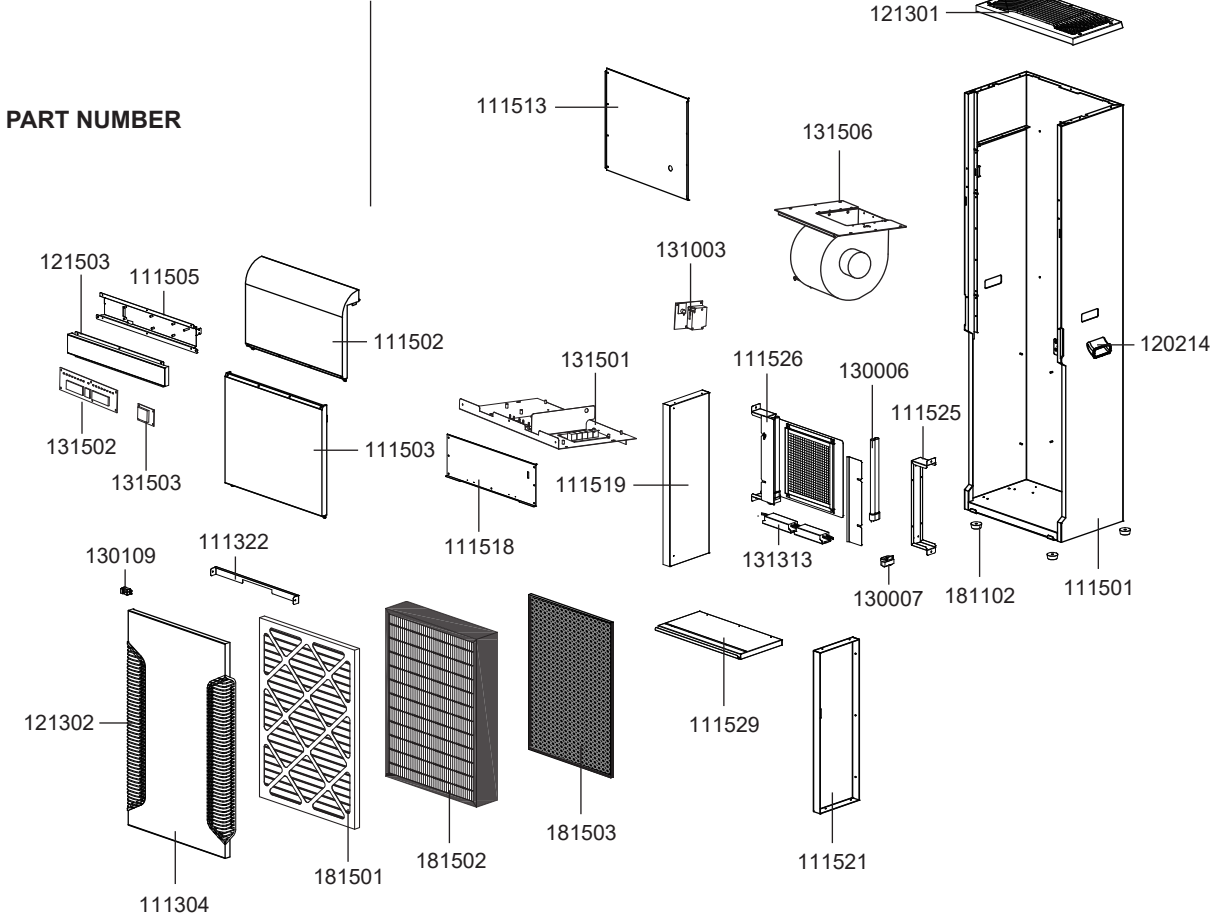

## PART NAME

- |                                    |                               |
|------------------------------------|-------------------------------|
| 111304 Front panel                 | 111513 Fan motor front plate  |
| 121302 Front air inlet             | 131504 Sensors module         |
| 130109 Interlock switch            | 111529 Metal bottom plate     |
| 111322 Filter blocker              | 111519 Metal side plate-Left  |
| 181501 Pre-filter                  | 111521 Metal side plate-Right |
| 181502 HEPA filter                 | 131313 UV lamp ballast        |
| 181503 VOC filter                  | 130007 UV lamp holder         |
| 131502 Display circuit board       | 130006 UV lamp                |
| 131503 PM2.5 Display circuit board | 111525 UV lamp bracket        |
| 121503 Display panel               | 111526 UV light blocker       |
| 111505 Display panel back cover    | 131506 Fan motor              |
| 111502 Upper panel                 | 121301 Plastic air outlet     |
| 111503 Middle panel                | 120214 Unit handle            |
| 111518 Repair cover                | 111501 Unit housing           |
| 131501 Main circuit board          | 181102 Rubber feet            |
| 130001 Power supply                |                               |



## Chapter 4

### FEATURES AND SPECIFICATIONS

#### Features

#### Product Specifications

### FEATURES

#### Multi-Stage Filters

The unit utilizes a HEPA filter combined with a Pre-filter (For large particles), an VOC filter (For odors and gases), UV germicidal light (Killing airborne pathogen), a Photo catalytic filter (Removes VOC's) and a Negative ion generator.

#### Automatic Function

The odor and particle sensor can let the unit automatically select the appropriate fan speed depending on the air quality detected.

#### Filters , UV Lamps Replacement Indicator Lights

The indicator lights tell you when to replace the Pre-filter, HEPA filter and the VOC filter or the UV lamps.

#### Safety Micro-Switch (Interlock switch)

This air purifier is equipped with a safety interlock switch (Micro-safety switch) that will turn the unit off if the front panel is removed while the unit is running.

#### Easy Maintenance and Low Cost

When the filters need to be replaced, simply open the front panel and pull out the filters and put the new one in.  
No screws, hooks or tools are required.

### SPECIFICATIONS

Model No.	SCA7000H
Power Requirement	a.c120V, 60Hz, 2.5A
Rated Power	210W
Negative Ion	>3x10 <sup>6</sup> /cm <sup>3</sup>
UV Lamp	24Wx2
Main Parts	Pre-filter, HEPA filter, VOC Filter, UV light-Photo catalyst system, Negative Ion Generator
Fan Motor	120V, 60Hz
Fan Speed	Max 810m <sup>3</sup> /h
Dimensions	168cmx50cmx38.5cm
Weight	60kg

### STANDBY POWER

In order to operate the electrical circuits while the power plug is inserted in the wall outlet, this product consumes about 1.6W of standby power. For energy conservation, unplug the power cord when the unit is not in use.

## Chapter 5

### OPERATION

#### Button Operation

#### BUTTONS



#### 1. POWER Button

- Turns the purifier On and Off.
- Hold the Power button for 2 seconds, the “” indicator light will light up with beeping. In this mode, the panel is locked. If you want to return to the default mode, do the reverse.

#### 2. SPEED Button

When the SPEED button is pressed the airflow rate changes as shown below: L (speed 1) --L+M (speed 2) -- M (speed 3) --M+H (speed 4) -- H (speed 5) -- A (auto mode).

#### 3. TIMER Button

Press the TIMER button to select the time for operation. The timer setting switches as shown: 1hr -- 2hr -- 4hr -- C (timer cycle function) -- cancel timing.

#### 4. UV LAMP Button

When the button is pressed, it will turn off the UV lamps, pressing again will turn on the UV light.

#### 5. NEG.ION Button

When pressed, the generation of ions will cease and the negative ion generator light will go out.

---

#### Helpful Hints

#### RESET Button

- After the replacement of the Pre-filter, hold the SPEED button 2 seconds to reset the timer with beeping sound.
- After the replacement of HEPA filter, make sure to hold the TIMER button 2 seconds to reset the timer.
- After the replacement of VOC filter, make sure to hold the TIMER button 2 seconds to reset the timer.
- After the replacement of UV lamps, make sure to hold the UV LAMP button 2 seconds to reset the timer.

Note: Before pressing the reset button, be sure the unit is turned on.

## Chapter 5

### OPERATION

#### Display Indicator Lights

#### New Functions

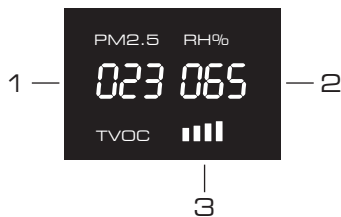

#### POLLUTANT Display

1. Real-time display the indoor PM2.5 concentration ( $\mu\text{g}/\text{m}^3$ ).
2. Indoor humidity display.
3. Indoor TVOC pollution level.

#### Connect the Power

Plug the unit into an electric outlet, the unit will be ready to run and the Power indicator on the display panel will light up.

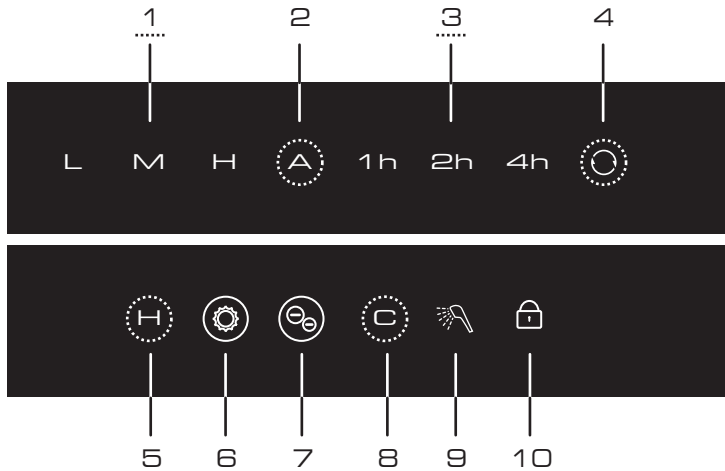

#### 1 SPEED indicator light

When the power is on, the " L " light will light up, select the speed by pressing the SPEED button.

#### 2 AUTO MODE indicator light

When the indicator is lighting up, the unit is at Auto mode.

#### 3 TIMER indicator light

When the TIMER button pressed, the indicator light will light up.

#### 4 TIMER CYCLE indicator light

When this indicator is lighting up, the unit will start to work for 2 hours and stops 0.5 hours automatically, this schedule will repeat itself continuously while in this mode.

#### 5 HEPA FUNCTION and HEPA FILTER LIFE indicator light

When the H indicator light up, the unit is in hybrid mode. When the indicator light flashes, it is time for the HEPA filter to be replaced.

#### 6 UV LAMP indicator light

The indicator light will light up when the UV light are on. When the indicator light flashes, it is time for the UV lamps to be replaced.

#### 7 NEG.ION indicator light

When pressed, the generation of ions will cease and the indicator light will be off.

#### 8 VOC FILTER LIFE indicator light

When the indicator light flashes, the VOC filter needs to be replaced.

#### 9 PRE-FILTER LIFE indicator light

When this indicator light flashes, the Pre-filter needs to be replaced.

#### 10 LOCK FUNCTION indicator light

In this mode, all the buttons will not work.

# Chapter 5

## OPERATION

### Remote Control Operation

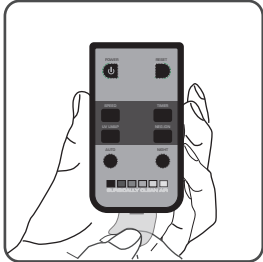

Pull out the clear sheet from the battery cover before using.

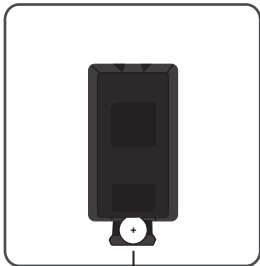

CR2025 Battery

The battery is already set in the remote control, pull out the clear sheet from the battery cover before using.

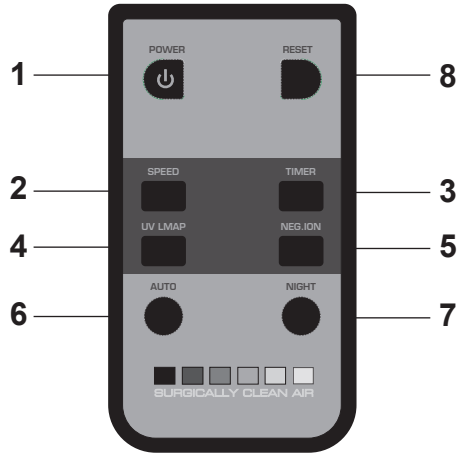

#### 1 Power (ON/OFF) Button

The unit will start operating when the POWER button is pressed. Pressing the button again will stop operation.

#### 2 SPEED Button

The fan speed can be switched among speed 1, speed 2, speed 3, speed 4, speed5 settings.

#### 3 TIMER Button

The set time switches every time the button is pressed as shown below: 1hr - 2hr - 4hr - Cycle - Cancel.

#### 4 UV LAMP Button

Turns UV lights on and off.

#### 5 NEG.ION Button

Turns Negative Ions on and off.

#### 6 AUTO Button

At Auto mode, the fan speed is automatically switched depending on the amount of pollution in the air.

#### 7 NIGHT Button

When pressed, all the indicator lights on the display panel will go out.

#### 8 RESET Button

Pressing the reset button 8 times will reset all the replacement indicator lights.

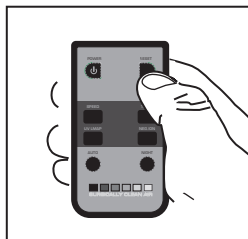

## Chapter 6

### CARE AND MAINTENANCE



#### WARNING

Cleaning the unit while it is plugged in may result in electric shock, electric spark and serious injury. Unplug the unit before cleaning or maintenance!

To maintain optimum performance of this air purifier, the Pre-filter, the HEPA filter, the VOC filter and the UV-C+ bulb need to be replaced when the indicator lights are flashing. When replacing the filters, be sure to unplug the power cord, and never handle the plug with wet hands. If so, electrical shock and bodily injury may occur as a result.

#### Main Unit

Wipe with a dry, soft cloth for stubborn stains or dirt. Do not use **volatile fluids, Benzene, paint thinner, polishing powder**, this may damage the surface. Do not use detergents, detergent ingredients may damage the unit. Keep the unit away from water.

#### Replacing the Pre-filter

When the “” indicator light on the control panel flashes, the Pre-filter needs to be replaced.



##### 6-1 Open the front panel

- Stop the operation and unplug the unit.
- Hold the front panel upper portion (Left and right side) and pull it toward you.



Remove the swing screw and take off the filter blocker.

##### 6-2 Removing the Pre-filter

- Remove the filter blocker.
- Pull the Pre-filter straight up and out of the front panel.

#### CAUTION:

- **DO NOT** reuse or clean the Pre-filter with flammable substance.
- Remove plastic packaging from the Pre-filter before operation.
- After replacing the Pre-filter, hold the **SPEED** button 2 seconds to reset the time for the Pre-filter.

## Chapter 6

### CARE AND MAINTENANCE

#### WARNING :

- *DO NOT clean the HEPA filter with alcohol, gasoline, paint thinner or other flammable substances. It may cause fire!*
- *Before Remove the HEPA filter ,Stop the operation and unplug the unit.*
- *Remove the plastic packaging from the HEPA filter before operation.*



#### WARNING

- *DO NOT reuse or clean the VOC filter with liquid, especially alcohol, gasoline, paint thinner, etc. It may cause fire!*
- *Remove plastic packaging from the VOC filter before operation.*

### Replacing the HEPA filter

When the “” indicator light on the control panel flash, the HEPA filter needs to be replaced.

#### Remove the HEPA filter

Stop the operation and unplug the unit.



6-3 Hold the handle of the HEPA filter, pull it toward to you.

### Replacing the VOC Filter

When the “” indicator light on the control panel flash, the VOC filter needs to be replaced.

#### Remove the VOC filter

Stop the operation and unplug the unit.



6-4 Take the Pre-filter and the HEPA filter out first.



6-5 Hold the VOC filter's handle, pull it toward to you.

#### Reset the filter life

- After replacing the HEPA filter, hold the TIMER button 2 seconds to reset the time for the HEPA filter
- After replacing the VOC filter, hold the TIMER button 2 seconds to reset the time for the VOC filter.

## Chapter 6

### CARE AND MAINTENANCE

Hold the UV LAMP button 2 seconds to reset

After replacing the UV lamps, hold the UV LAMP button 2 seconds to reset the time for the UV lamps.

### Replacing UV Lamp

When the “⊙” indicator light on the control panel flashes, it is time to replace the UV lamps.

#### Removing the UV lamp

Before removing the UV lamps, open the front panel and take the Pre-filter, the HPEA filter and the VOC filter first.

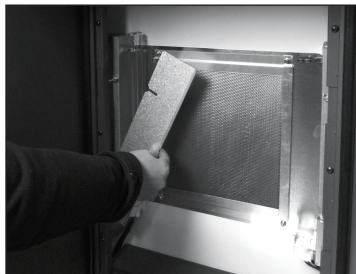

6-7 Remove the UV lamp blocker.



6-8 Hold the UV lamp, pull it up and remove it from the UV lamp holder.

#### **WARNING:**

- *Never look directly at UV lamps. Direct exposure to germicidal light can cause temporary or chronic damage to your eyesight, or even blindness.*
- *Always unplug the unit before cleaning, servicing or replacing the UV lamps.*
- *Do not dispose of the UV bulb with normal household waste, hand it in at an official collection point for recycling.*

#### **Photo Catalytic Filter**

Photo catalytic filter is permanent, never needs replacing. When there is dust on it, clean the dust off using a vacuum cleaner dusting brush. Do not wash it in water

# Chapter 7

## TROUBLE SHOOTING

**The system does not operate at all**

**When functions do not work**

**Automatic function does not work properly**

**For all other problems**

Service problems that appear to be major can often be solved easily. You can be your own troubleshooter by reviewing the following guide. All other servicing should be done by a SCA authorized service center.

Power failure?	Check other electrical appliances.
Power plug disconnected?	Make sure to insert the plug.
Is the fuse burnt?	Replace the FUSE with new one.
Front panel open or interlock switch failure?	The unit does not operate when the front panel is detached. Install properly. Check interlock switch.
There is too much dust on the Pre-filter or HEPA filter?	Replace the Pre-filter or the HEPA filter.
There is too much dust on the VOC filter?	Replace the VOC filter
The air inlet or outlet blocked?	Get rid of foreign materials around the outlets.
There is too much dust on the sensor?	Clean the dust on the sensor.
There is no dust on the sensor.	Call the Customer Service.

Check the problems first and then unplug the power cord. Call the Customer Service to ask for after-sale service or make inquiries.

Germicidal UV-C+ Bulbs should only be purchased from Surgically Clean Air or an authorized dealer at Surgically Clean Air. This will ensure that you are receiving UV bulbs that do not produce ozone. Many after-market sellers are selling ozone-generating UV bulbs.



# Chapter 8

## WIRING DIAGRAM

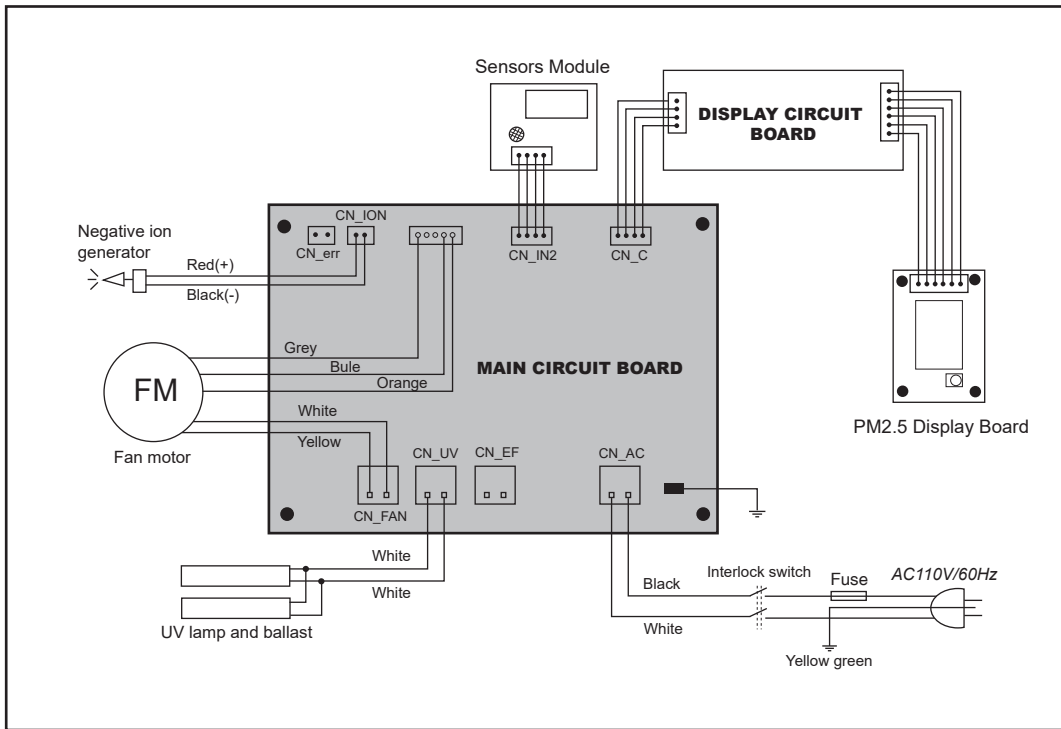

# SERVICE REMINDER SCHEDULE

## Pre-filter Replace Reminder

Year	<i>J</i>	<i>F</i>	<i>M</i>	<i>A</i>	<i>M</i>	<i>J</i>	<i>J</i>	<i>A</i>	<i>S</i>	<i>O</i>	<i>N</i>	<i>D</i>

Memo:

## HEPA Filter Replace Reminder

Year	<i>J</i>	<i>F</i>	<i>M</i>	<i>A</i>	<i>M</i>	<i>J</i>	<i>J</i>	<i>A</i>	<i>S</i>	<i>O</i>	<i>N</i>	<i>D</i>

Memo:



6300 Viscount Road Unit 1A  
Mississauga Ontario Canada L4V 1H3  
Tel: 1-877-440-7770  
[www.surgicallycleanair.com](http://www.surgicallycleanair.com)  
[info@surgicallycleanair.com](mailto:info@surgicallycleanair.com)